

Presented to  
The Library  
of the  
University of Toronto  
by

L.V. Mills, Esq.,  
50 Indian Trail,  
Toronto, Ontario.







Digitized by the Internet Archive  
in 2009 with funding from  
Ontario Council of University Libraries

<http://www.archive.org/details/encyclopediabrit13bayn>









THE  
ENCYCLOPÆDIA BRITANNICA

A  
DICTIONARY

OF  
ARTS, SCIENCES, AND GENERAL LITERATURE

THE R. S. PEALE REPRINT

WITH NEW MAPS AND ORIGINAL AMERICAN ARTICLES BY EMINENT WRITERS

WITH AMERICAN REVISIONS AND ADDITIONS

By W. H. DEPUY, D.D., LL.D.,

BRINGING EACH VOLUME UP TO DATE.

VOLUME XIII

CHICAGO  
R. S. PEALE COMPANY  
1892.

AF

5365

1892

012

708676



# Encyclopædia Britannica.

VOL. XIII.—(INF—KAN).

Total number of Articles, 526.

## PRINCIPAL CONTENTS.

- INFANT. EDJUND ROBERTSON, LL.D., M.P., Professor of Roman Law, University College, London.
- INFANTICIDE. W. C. SMITH, LL.B., Advocate.
- INFINITESIMAL CALCULUS. BENJAMIN WILLIAMSON, F.R.S., Professor of Mathematics, Trinity College, Dublin.
- INGRES. Mrs PATTISON, Author of "Renaissance of Art in France."
- INHERITANCE. Prof. E. ROBERTSON.
- INK. JAMES PATON, Curator, Corporation Galleries of Art, Glasgow.
- INNS OF COURT. J. CLAUDE WEBSTER, Barrister.
- INSCRIPTION. Very Rev. G. W. KITCHIN, M.A., Dean of Winchester.
- INSANITY. J. BATTY TEEKE, M.D., F.R.C.P.E.
- LAW OF INSANITY. ALEX. GIBSON, M.A., Advocate.
- INSCRIPTIONS—
- CUNEIFORM AND SEMITIC. Rev. A. H. SAYCE, Deputy Professor of Comparative Philology, Oxford.
- INDIAN. JOHN DOWSON, late Professor of Hindustani, University College, London.
- GREEK. Rev. E. L. HICKS, M.A. Corpus Christi College, Oxford.
- ROMAN. Dr E. HÜBNER, Professor of Classical Philology, University of Berlin.
- INSECTIVOROUS PLANTS. PATRICK GEDDES, F.R.S.E.
- INSECTS. ROBERT M'LACHLAN, F.R.S.
- INSPIRATION. Prof. T. M. LINDSAY, D.D., Free Church College, Glasgow.
- INSTINCT. G. J. ROMANES, LL.D., F.R.S.
- INSURANCE—
- FIRE. J. M. M'CANDLISH, Actuary.
- LIFE. G. M. LOW, Actuary.
- MARINE. J. WARRACK.
- INTERNATIONAL LAW. Prof. E. ROBERTSON.
- IODINE. Prof. H. E. ARMSTRONG, F.R.S.
- IONIA. E. H. BUNBURY, M.A.
- IOWA. HENRY GANNETT, Census Office, Washington.
- IPECACUANHA. E. M. HOLMES, Curator of Museum of Pharmaceutical Society London.
- IRELAND—
- GEOGRAPHY AND STATISTICS. T. F. HENDERSON.
- HISTORY. W. K. SULLIVAN, President of Queen's College, Cork, and RICHARD BAGWELL, M.A., Author of "History of Ireland under the Tudors."
- IRENÆUS. Prof. T. M. LINDSAY, D.D.
- IRON. C. R. ALDER WRIGHT, D.Sc., F.R.S., Author of "Metals and their Chief Industrial Applications."
- THERAPEUTIC USES. D. J. LEECH, M.D., Professor of Materia Medica, Owens College, Manchester.
- IRON MASK. W. O'CONNOR MORRIS.
- IRRIGATION. Prof. A. H. CHURCH, Agricultural College, Downton.
- IRVING, WASHINGTON. RICHARD GARNETT, Author of "Idylls and Epigrams."
- ISEUS. R. C. JEBB, LL.D., Professor of Greek, University of Glasgow.
- ISAIAH. Rev. Canon CHEYNE, Oriel Professor of Exegesis, University of Oxford.
- ISOCRATES. Prof. JEBB.
- ISPAHAN. Sir H. C. RAWLINSON, K.C.B., F.R.S.
- ISRAEL. Dr JULIUS WELHAUSEN, Professor of Oriental Languages, University of Halle.
- ITALY—
- GEOGRAPHY. E. H. BUNBURY, M.A.
- STATISTICS. H. A. WEBSTER.
- HISTORY. J. ADDINGTON SYMONDS, M.A., Author of "Renaissance in Italy."
- LANGUAGE.—Prof. G. I. ASCOLI, Milan.
- LITERATURE. Prof. A. BARTOLI, Florence.
- IVORY. C. SISSMORE TOMES, F.R.S.
- IVY. SHIRLEY HIBBERD, Author of "The Ivy."
- JACKSON, ANDREW. W. G. SUMNER, Professor of Political and Social Science, Yale College, Conn.
- JACKSON, T. J. ("STONEWALL JACKSON"). Gen. ROGER A. PRYOR, late Confederate Army.
- JACOBI, F. H. R. ADAMSON, M.A., Professor of Logic, Owens College, Manchester.
- JADE. F. W. RUDLER, Curator, Royal School of Mines, London.
- JAGUAR. D. G. ELLIOT, New Brighton, Staten Island, New York.
- JAINS. T. W. RHYNS DAVIDS, Author of "Buddhism."
- JAMAICA. J. L. ORLSON, Secretary to West India Committee, London.
- JAMES, EPISTLE OF. Rev. J. R. LUMBY, D.D., Norrisian Professor of Theology, Cambridge.
- JAMESON, MRS. Lady EASTLAKE.
- JAPAN. T. R. H. M'CLATCHIE.
- JAPANESE ART. Sir RUTHERFORD ALCOCK, K.C.L.
- JAUNDICE. J. O. AFFLECK, M.D., F.R.C.P.E.
- JAVA. H. A. WEBSTER.
- JAY. ALFRED NEWTON, F.R.S., Professor of Zoology, University of Cambridge.
- JEFFERSON. Hon. JOHN BIGELOW, New York.
- JEFFREY. T. F. HENDERSON.
- JENGHIZ KHAN. R. K. DOUGLAS, Professor of Chinese, King's College, London.
- JENNER. J. RAYMOND GASQUET, M.B.
- JEREMIAH. Rev. Prof. CHEYNE.
- JEROME. Prof. T. M. LINDSAY, D.D.
- JERROLD. - FINDLAY MUIRHEAD, M.A.
- JERUSALEM. Lieut. CONDER, R.E., of the Palestine Exploring Expedition, and Rev. W. R. SMITH, M.A.
- JESUITS. Rev. R. F. LITTLEDALE, LL.D., D.C.L.
- JESUS CHRIST. Ven. Archdeacon F. W. FARRAR, D.D., F.R.S., Author of "Life of Christ."
- JEW, WANDERING. MONCURE D. CONWAY.
- JEWELLERY. GEORGE WALLIS, South Kensington Museum, London.
- JEWS, MODERN. ISRAEL DAVIS.
- JOB. Rev. A. B. DAVIDSON, D.D., LL.D., Professor of Hebrew, New College, Edinburgh.
- JOEL. Rev. W. ROBERTSON SMITH, M.A.
- JOHN, EPISTLES OF. Rev. ARTHUR CARR, M.A.
- JOHN (OF ENGLAND). Mrs ARMITAGE.
- JOHNSON. Lord MACAULAY.
- JOINTS. R. H. SMITH, Mason's College, Birmingham.
- JOINVILLE. GEORGE SAINTSBURY, M.A.
- JONSON. A. W. WARD, M.A., Professor of History and English Literature, Owens College, Manchester.
- JORDANES. T. HODGKIN, D.C.L., Author of "Italy and her Invaders."
- JUAN FERNANDEZ. Sir WYVILLE THOMSON, F.R.S.
- JUDE. Prof. J. R. LUMBY, D.D.
- JUDGES, BOOK OF. Rev. W. ROBERTSON SMITH, M.A.
- JUGURTHA. Rev. W. J. BRODRIBB, M.A.
- JULIAN. THOMAS KIRKUP, M.A.
- JUNIUS. A. HAYWARD, Q.C., Author of "Biographical and Critical Essays."
- JUPITER. Prof. W. M. RAMSAY.
- JURA. W. A. B. COOLIDGE, M.A., Editor of the *Alpine Journal*.
- JURY. Prof. E. ROBERTSON.
- JUSTINIAN. JAMES BRYCE, M.P., D.C.L., Regius Professor of Civil Law, University of Oxford.
- JUTE. JAMES PATON.
- JUVENAL. W. Y. SELLAR, LL.D., Professor of Humanity, University of Edinburgh.
- KABBALAH. Rev. C. D. GINSBURG, LL.D.
- KAFFRARIA. J. S. KELTIE and A. H. KEANE.
- KAFIRISTAN. Col. HENRY YULE, C.B.
- KALEIDOSCOPE. JAMES BLYTH, M.A., Professor of Mathematics, Andersonian University, Glasgow.
- KALIDASA. A. A. MACDONELL, B.A., Corpus Christi College, Oxford.
- KANDAHAR. Captain T. H. HOLDICH, R.E.
- KANGAROO. W. H. FLOWER, F.R.S., Professor of Comparative Anatomy, Royal College of Surgeons, London.
- KANSAS. JOHN DAVIS, Editor of the *Tribune*, Junction City, Kansas.
- KANT. Prof. R. ADAMSON.



# ENCYCLOPÆDIA BRITANNICA.

## INFANT

**I**NFANT, in law, is a person under full age, and therefore subject to certain disabilities not affecting persons who have attained full age. The period of full age varies widely in different systems, as do also the disabilities attaching to non-age. In Roman law, the age of puberty, fixed at fourteen for males and twelve for females, was recognized as a dividing line. Under that age a child is under the guardianship of a tutor, but several degrees of infancy are recognized. The first is absolute infancy in the literal sense—speechlessness; after that, until the age of seven, a child is *infantia proximus*; and from the eighth year to puberty he is *pubertati proximus*. An infant in the last stage could, with the assent of his tutor, act so as to bind himself by stipulations; in the earlier stages he could not, although binding stipulations could be made to him in the second stage. After puberty, until the age of twenty-five years, a modified infancy was recognized, during which the minor's acts were not void altogether, but voidable, and a curator was appointed to manage his affairs. The difference between the tutor and the curator in Roman law was marked by the saying that the former was appointed for the care of the person, the latter for the estate of the pupil. These principles of course apply only to children who are *sui juris*. The *patria potestas*, so long as it lasts, gives to the father the complete control of the son's actions; and tutorship and curatorship were devices for protecting those who were free from the *potestas*, but unable by reason of infancy to control their own affairs. The right of the father to appoint tutors to his children by will (*testamentarii*) was recognized by the Twelve Tables, as was also the tutorship of the *agnati* (or legal as distinct from natural relations) in default of such an appointment. Tutors who held office in virtue of a general law were called *legitimi*. Besides and in default of these, tutors *dativi* were appointed by the magistrates. These terms are still used in much the same sense in modern systems founded on the Roman law, as may be seen in the case of Scotland, noticed below.

By the law of England full age is twenty-one, and all minors alike are subject to incapacities. The period of twenty-one years is regarded as complete at the beginning of the day before the birthday: for example, an infant born on the first day of January attains his majority at

the first moment of the 31st of December. The incapacity of an infant is designed of course for his own protection, and its general effect is to prevent him from binding himself absolutely by obligations. In the matter of contracts, the statement has generally passed current that an infant's contracts, except when they are binding for special reasons, are either void or voidable, *i.e.*, null, *ab initio*, or capable of being nullified by the infant at his choice. Contracts, for example, which cannot be beneficial to the infant are said to be absolutely void. A bond with a penalty is for this reason declared to be void. On the other hand, it is alleged by the more recent text-writers that the words void and voidable have not been carefully distinguished, and that a contract is often described as void when it is only meant that it is not binding. On this theory all the contracts of an infant might be described as voidable at his option except those few which are absolutely valid. On his voidable contracts an infant may sue if he chooses to do so, but may not be sued. Of the contracts of an infant which are binding *ab initio*, the most important are those relating to "necessaries." The word is used in an extended signification to cover "articles fit to maintain the person in the particular state, degree, and station in life in which he is." Whether a particular thing is necessary or not is a question of fact to be decided by a jury, but it is for the judge to say whether it is *prima facie* of a description such that it may be a necessary. It has been ruled by judges, without consulting the jury, that the following articles were not necessary:—expensive dinners supplied to an undergraduate in his private rooms; a pair of solitaire studs costing £25, and a goblet costing £15, for a baronet's son; a chronometer worth £68, for a lieutenant in the navy; ornaments to the value of £137. On the other hand, an undergraduate has been allowed a gold watch as a necessary; and liveries for an officer's servant, money paid to release an infant from ejection or distress, and necessaries for an infant's wife have all been held to be necessaries of an infant. An object, in itself of a character to be pronounced a necessary, may in particular cases be declared not necessary, *e.g.*, if the infant is already supplied with things of the kind. A sealskin waistcoat may be a necessary to an infant of good fortune, but not if he has half a dozen such garments in his possession



already. The person who supplies goods *prima facie* necessary to an infant must, it would seem, take the risk of their turning out to be unnecessary. An infant fraudulently passing himself off as of full age and contracting on that footing will be held bound in equity. The protection of infants extends sometimes to transactions completed after full age: the relief of heirs who have been induced to barter away their expectations is an example. "Catching bargains," as they are called, throw on the persons claiming the benefit of them the burden of proving their substantial righteousness; and, although the youth of the party charged is not an essential point, it is generally one of the facts relied on as showing undue influence.

At common law a bargain made by an infant might be ratified by him after full age, and would then become in all respects binding. Lord Tenterden's Act required the ratification to be in writing. But now by the Infants Relief Act, 1874, "all contracts entered into by infants for the repayment of money lent or to be lent, or for goods supplied or to be supplied (other than contracts for necessities), and all accounts stated, shall be absolutely void," and "no action shall be brought whereby to charge any person upon any promise made after full age to pay any debt contracted during infancy, or upon any ratification made after full age of any promise or contract made during infancy, whether there shall or shall not be any new consideration for such promise or ratification after full age." It has been held in a recent case that this action applies to promises of marriage, so that where an infant had promised marriage, and after attaining full age continued to recognize the promise, no action arose on the breach. But an actual contract of marriage may be lawfully made by persons under age. Marriageable age is fourteen in males and twelve in females. So, generally, an infant may bind himself by contract of apprenticeship or service. Since the passing of the Wills Act, an infant is unable to make a will. Infancy is in general a disqualification for public offices and professions, *e.g.*, to be a member of parliament or an elector, a mayor or burgess, a priest or deacon, a barrister or solicitor, &c.

The custody of an infant belongs in the first place, and against all other persons, to the father, who is said to be "the guardian of his children by nature and nurture;" and the father may by deed or will dispose of the custody or tuition of his children until the age of twenty-one. If the father is dead, and has appointed no testamentary guardian, the mother is recognized as "guardian by nature and nurture." But the children must be brought up in the father's religion, even when he has given no directions on the subject; and it appears that no agreement between husband and wife to the contrary effect will be sustained. When, however, the father has in his lifetime suffered the children to be educated in their mother's religion, he may be held to have waived his rights. The Court of Chancery is unwilling to embarrass itself by departing from the strict rule, and an instance is recorded of a child which had been educated from eight to fifteen in the tenets of the Plymouth Brethren being ordered by the court to be educated in the religion of the Church of England. The right of the father to the custody of the child will be enforced, except where he has been guilty of gross immorality, by writ of *habeas corpus*, as long as a child is within the age of nurture, which for males at least may be taken to be fourteen years. The infant then acquires a right of election. In two cases a boy over fourteen but under sixteen has been permitted by the court to choose, when the father had sued for the custody under a *habeas corpus*. In the case of female infants, the courts have held that they do not acquire the right of election till sixteen, following the statute of Philip & Mary which punishes the abduction of maidens under

that age as a criminal offence. These rules do not apply to illegitimate children, as they are not under the legal guardianship of the putative father or the mother. The rights of the father or mother may be interfered with by the Court of Chancery under special circumstances, such as cruelty, immorality, &c. A recent Act (36 & 37 Vict. c. 12) gives power to the court to make orders for the mother of an infant under sixteen, to have or retain the custody of such infant, or to have access thereto, &c. The same statute legalizes agreements by the father to give up the custody and control of children to the wife. The Divorce Court has also very extensive powers of regulating the custody and maintenance of children, in exercising which it observes the same limits of age as the courts of law and chancery.

There is not at common law any corresponding obligation on the part of either parent to maintain or educate the children. The legal duties of parents in this respect are only those created by the poor laws and the Elementary Education Act. In the case, however, of debts contracted by a child for necessities, the authority of the father would, to use a common phrase, be "easily implied."

Besides the natural guardianship of parents, children may in various other ways come under the authority of guardians. A recent author gives the following as a complete list of guardians:—guardian in chivalry, in socage, in nature, by nurture, by election of the infant, by statute (4 Philip & Mary c. 8, 12 Chas. II. c. 24), by custom, by appointment of the ecclesiastical courts and of the Court of Chancery, foreign guardians, and guardians *ad litem* (Simpson's *Law of Infants*, London, 1875). Some of these have already been noticed, and others are obsolete or nearly so. The Act of Chas. II. enables the father to appoint a testamentary guardian to his children during infancy or any less period, who shall have the charge of the infant's real and personal estate. The Act is not to prejudice any customary guardianship, such as that of the City of London, where, according to ancient but now disused custom, the goods and lands of the orphans of freemen are in the custody of the lord mayor and aldermen in their court of orphans. By the custom of Kent, and by the special customs of certain manors, the lord has the right of appointing guardians to infant tenants. Guardianship by socage extends only to lands of socage tenure, and belongs to the next of blood of the infant, other than those who might succeed to the estate when the infant dies. It ends when the infant reaches the age of fourteen; after that age, or before if there was no guardian, infants were formerly allowed to elect a guardian, but that practice is now superseded by the action of the Court of Chancery which appoints guardians in all cases where it is for the benefit of the infants to do so. An infant under a guardian appointed by the Court of Chancery is properly a "ward of court," but the term is also applied to infants brought under the authority of the court although no guardian be appointed. The office and duty of the guardian extend to the custody and control of the infant, to his education, maintenance, and advancement out of any property that may be available therefor, and to the prevention of improper and disparaging marriages. The office of guardian is strictly a trust, the ordinary duties and responsibilities of a trustee with respect to property being accompanied by peculiar rights and duties with respect to the person of the *cestui que trust*. He must act in all cases for the benefit of the infant, and may not put himself into any position in which his interest would be hostile to that of the infant. The Court of Chancery has full jurisdiction over guardians of every kind, whether appointed by itself or not, and if it cannot actually dismiss a testamentary guardian, it may supersede him and entrust the charge of

the infant to some other person on proper cause being shown (see TRUSTEE).

An infant is liable to a civil action for torts and wrongful acts committed by him. But, as it is possible sometimes so to shape the pleadings in an action as to make what is in substance a right arising out of contract take the form of a right arising from civil injury, care is taken that an infant in such a case shall not be held liable. With respect to crime, mere infancy is not a defence, but a child under seven years of age is presumed to be incapable of committing a crime, and between seven and fourteen his capacity requires to be affirmatively proved. After fourteen an infant is *doli capax*.

The law of Scotland follows the leading principles of the Roman law. The period of minority (which ends at twenty-one) is divided into two stages, that of absolute incapacity (until the age of fourteen in males, and twelve in females), during which the minor is in pupilarity, and that of partial incapacity (between fourteen and twenty-one), during which he is under curators. The guardians (or tutors) of the pupil are either tutors-nominate (appointed by the father in his will); tutors-at-law (being the next male agnate of twenty-five years of age), in default of tutors-nominate; or tutors-datave, appointed by royal warrant in default of the other two. No act done by the pupil, or action raised in his name, has any effect without the interposition of a guardian. After fourteen, all acts done by a minor having curators are void without their concurrence. Every deed in nonage, whether during pupilarity or minority, and whether authorized or not by tutors or curators, is liable to reduction on proof of "lesion," i.e., of material injury, due to the fact of nonage, either through the weakness of the minor himself or the impudence or negligence of his curators. Damage in fact arising on a contract in itself just and reasonable would not be lesion entitling to restitution. Deeds in nonage, other than those which are absolutely null *ab initio*, must be challenged within the *quadrimum vite*, or four years after majority.

In the United States, the principles of the English common law as to infancy prevail, generally the most conspicuous variations being those affecting the age at which women attain majority. In many States this is fixed at eighteen. There is some diversity of practice as to the age at which a person can make a will of real or personal estate. (E. U.)

**INFANTICIDE.** The history of infanticide as an archaic institution has already been referred to in the article FOUNDLING HOSPITALS (vol. ix. p. 481). Children of both sexes were sacrificed as religious offerings. Indeed, in some cases, e.g., in expiations for sacrilege, the boy, as being the nobler child, was preferred. But what may be called the normal infanticide of early society was probably confined to girls. The custom is in certain places and for certain periods explained by the system of exogamy; but much more generally, as in China at the present day, it is simply an illustration of what Malthus would call a "positive check," the reckless propagation of children far outrunning the means of subsistence which the energy of the parents can provide. Infanticide still survives among many savage races; and, where the necessity for strong warriors is felt, a selection is sometimes made of the weaker children for destruction. But this political element seldom enters into the custom. It is because girls cannot provide for themselves that they are killed.

More complex were the leading forms of infanticide in India, now suppressed by the wise action of the British Government. The practice, though forbidden by both the Vedas and the Koran, prevailed among the Rájputs and certain of the aboriginal tribes. Among the aristocratic Rájputs, for example, it was thought dishonourable that a girl should remain unmarried. Moreover, a girl may not marry below her caste; she ought to marry her superior, or at least her equal. This reasoning was obviously most powerful with the highest castes, in which, accordingly, the disproportion of the sexes was painfully apparent. But, assuming marriage to be possible, it is ruinously expensive to the bride's father. He has to make gifts of money, clothes, jewels, and sweetmeats to the bridegroom's relatives; and when the marriage ceremony comes,

he has, chiefly owing to the exactions of the Bráhmans and Bhats or minstrels, to face a lavish expenditure on feasts which in the case of some rájás has been known to reach more than £100,000. To avoid all this, the Rájput killed a certain proportion of his daughters,—sometimes in a very singular way. A pill of tobacco and blang might be given to the newborn child to swallow; or it was drowned in milk; or the mother's breast was smeared with opium or the juice of the poisonous *Datura*. A common form was to cover the child's mouth with a plaster of cow-dung before it drew breath. Infanticide was also practised to a small extent by some sects of the aboriginal Kaudhs, and by the poorer hill tribes of the Himalayas. Where infanticide occurs in India, though it really rests on the economic facts stated, there is usually some poetical tradition of its origin. The measures against the practice were begun towards the end of the 18th century by Jonathan Duncan and Major Walker. They were continued by a series of able and earnest officers during the present century. One of its chief events, representing many minor events, was the Unritsur durbar of 1853, which was arranged by the late Lord Lawrence. At that great meeting the chiefs residing in the Panjab and the trans-Sutlej states signed an agreement engaging to expel from caste every one who committed infanticide, to adopt fixed and moderate rates of marriage expenses, and to exclude from these ceremonies the minstrels and beggars who had so greatly swollen the expense. According to the present law, if the female children fall below a certain percentage in any tract or among any tribe in northern India where infanticide formerly prevailed, the suspected village is placed under police supervision, the cost being charged to the locality. By these measures, together with a strictly enforced system of reporting births and deaths, infanticide has been almost trampled out; although some of the Rájput clans keep their female offspring suspiciously close to the lowest average which secures them from surveillance.

The modern crime of infanticide shows no symptom of diminution in the leading nations of Europe. In all of them it is closely connected with illegitimacy in the class of farm and domestic servants. The crime is generally committed by the mother for the purpose of completing the concealment of her shame, and in other cases, where shame has not survived, in order to escape the burden of her child's support. The paramour sometimes aids in the crime, which is not confined to unmarried mothers. The case with which affiliation orders are obtained in Great Britain must save the lives of many children. In France, where the inquiry into paternity is forbidden, a controversy still goes on as to the influence of hospitals for "assisted children," which are said to save life at the expense of morality. It seems certain that the great administrative change involved in closing the "tour" at these hospitals has not perceptibly affected infanticide in France. The laws of the European states differ widely on this subject,—some of them treating infanticide as a special crime, others regarding it merely as a case of murder of unusually difficult proof.

In the law of England, the inexcusable killing of infants is theoretically murder. The infant must of course be a human being in the legal sense; and "a child becomes a human being when it has completely proceeded in a living state from the body of its mother, whether it has breathed or not, and whether it has an independent circulation or not, and whether the navel string is severed or not; and the killing of such a child is homicide when it dies after birth in consequence of injuries received before, during, or after birth." A child in the womb, or in the act of birth, though it may have breathed, is therefore not a human being, the killing of which amounts to homicide. The



older law of child murder under a statute of James I. consisted of cruel presumptions against the mother, and it was not till 1803 that trials for that offence were placed under the ordinary rules of evidence. There now is a presumption, said to be based on considerations of humanity, that every newborn child found dead is born dead until the contrary is very clearly shown. It is the opinion of the most eminent of British medical jurists that this presumption has tended to increase infanticide. Apart from this, the technical definition of human life has excited a good deal of comment and some indignation. The definition allows many wicked acts to go unpunished. The experience of assizes in England shows that many children are killed when it is impossible to prove that they were wholly born. The distinction taken by the law has probably by this time reached the minds of the class to which most of the unhappy mothers belong. Partly to meet this complaint, it was suggested to the Royal Commission of 1866 that killing during birth, or within seven days thereafter, should be an offence punishable with penal servitude. The second complaint is of an opposite character,—partly that infanticide by mothers is not a fit subject for capital punishment, and partly that, whatever be the intrinsic character of the act, juries will not convict or the executive will not carry out the sentence. Earl Russell gave expression to this feeling when he proposed that no capital sentence should be pronounced upon mothers for the killing of children within six months after birth.

It is a statutory offence, under 24 & 25 Vict. c. 100, to administer poison or any noxious thing to a woman with child with intent to procure her miscarriage, or to use any instrument for the same purpose, the maximum punishment being penal servitude for life. The previous law had drawn the distinction of "quick with child," and in such cases had punished capitally. It was a very old controversy among the philosophers and physicians of antiquity, when the fœtus ceased to be *pars viscerum matris* and became "vital," or, as it was afterwards called, "animate." The law has not yet succeeded in putting down the degraded and wicked trade in abortion. There can be no doubt from the French and American treatises of Gallard and Storer that the crime prevails extensively, and even in classes of society in which infanticide proper would not be thought of without a shudder.

Under the same statute it is a misdemeanour punishable by two years' imprisonment with hard labour, as a maximum, to endeavour to conceal the birth of a child by any secret disposition of its dead body, whether the child died before, after, or at its birth. This does not apply to very premature births, where it was impossible that the fœtus should be alive. But it does apply to all those numerous cases where the child's body, without being actually hidden, is placed where it is not likely to be found except by accident, or upon search. Lastly, under the same statute it is a misdemeanour punishable by five years' penal servitude, as a maximum, to abandon or expose a child under the age of two years, so as to endanger its life, or to inflict permanent injury, actual or probable, upon its health.

It is difficult to say to what extent infanticide prevails in the United Kingdom. At one time a large number of children were murdered in England for the mere purpose of obtaining the burial money from a benefit club.<sup>1</sup> In 1871 the House of Commons found it necessary to appoint a select committee "to inquire as to the best means of preventing the destruction of the lives of infants put out to nurse for hire by their parents." The trials of

Margaret Waters and Mary Hall called attention to the infamous relations between the lying-in houses and the baby-farming houses of London. The form was gone through of paying a ridiculously insufficient sum for the maintenance of the child. "Improper and insufficient food," said the committee, "opiates, drugs, crowded rooms, bad air, want of cleanliness, and wilful neglect are sure to be followed in a few months by diarrhœa, convulsions, and wasting away." These unfortunate children were nearly all illegitimate, and the mere fact of their being hand-nursed, and not breast-nursed, goes some way (according to the experience of the Foundling Hospital and the Magdalene Home) to explain the great mortality among them. Such children, when nursed by their mothers in the workhouse, generally live. The practical result of the committee of 1871 was the Act of 1872, 35 & 36 Vict. c. 38, which provides for the compulsory registration of all houses in which more than one child under the age of one year are received for a longer period than twenty-four hours. No licence is granted by the justices of the peace, unless the house is suitable for the purpose, and its owner a person of good character and able to maintain the children. Offences against the Act, including wilful neglect of the children even in a suitable house, are punishable by a fine of £5 or six months' imprisonment with or without hard labour.

The law of Scotland also treats the unlawful killing of completely born infants as murder. In such cases a verdict of culpable homicide is usually returned, the punishment being entirely in the discretion of the court. Still more commonly the charge of concealment of pregnancy is made under the Act 49 Geo. III. c. 14, the maximum punishment being two years' imprisonment. It must be shown that the woman concealed her condition during the whole period of pregnancy, and did not call for help at the birth. Unlawfully procuring abortion, whether by drugs or instruments, is also a crime known to the common law of Scotland, the punishment being penal servitude or imprisonment according to circumstances. In a variety of cases, which do not admit of general statement, convictions have also been obtained against parents of exposing and deserting children or placing them in danger, and of cruel and unnatural treatment and neglect.

Infanticide will have to be further considered under the heading MEDICAL JURISPRUDENCE. For that branch of the subject the works of Tardieu and Taylor are the most important and recent authorities. See also Whitehead *On Abortion and Sterility*, and the works of Gallard and Storer already referred to.

*Bibliography.*—Besides a very large number of theses and special dissertations, and the chapters on the subject in the leading works in medical jurisprudence, the following are the most important works on infanticide. Ploucquet, *Commentarius Medicus in processu criminali super homicidio, infanticidio, &c.*, 1736; W. Hunter, *Uncertainty of the Signs of Murder in Bastard Children*; Olivard, *De l'infanticide et des moyens que l'on emploie pour le constater*, Paris, 1802; Mahon, *An Essay on the Signs of Murder in New-Born Children*, translated by Johnson, Lancaster, 1813; Arrowsmith, *Medico-legal Essay on Infanticide*, Edin., 1828; Cummin, *Proofs of Infanticide Considered*, London, 1836; Ryan, *Child Murder in its Sanitary and Social Bearings*, 1858, and *Infanticide, its Law, Prevalence, Prevention, and History*, London, 1862; Kunze, *Der Kindermord, historisch u. kritisch dargestellt*, Leipzig, 1860; Creaves, *Observations on some of the causes of Infanticide*, Manchester, 1863, and *Observations on the Laws referring to Child Murder and Criminal Abortion*, Manchester, 1864; Storer and Heard, *Criminal Abortion, its Nature, Evidence, and Law*, Boston, 1868; Tardieu, *Étude méd.-lég. et clinique sur l'avortement*, Paris, 1864, and *Étude méd.-lég. sur l'infanticide*, Paris, 1880; Toulmonche, *Études sur l'infanticide et la grossesse cachée ou simulée*, Paris, 1875; Gallard, *De l'avortement au point de vue méd.-lég.*, Paris, 1878. There are several works describing Indian infanticide.

The best known is *Infanticide, its Origin, Progress, and Suppression*, London, 1857, by J. Cave Browne. See also the works of Moore, Cornmack, and Wilson.

(W. C. S.)

INFANTRY. See ARMY.

<sup>1</sup> See *Report on the Sanitary Condition of the Labouring Classes, Supplementary Report on Interment in Towns*, by Edwin Chadwick (*Parl. Papers*, 1843, xii. 395); and *The Social Condition and Education of the People*, by Joseph Kay, 1850.

# INFINITESIMAL CALCULUS

## HISTORICAL INTRODUCTION.

THE mathematical and physical sciences owe their present great development to the introduction of the infinitesimal calculus. The power, for example, of that calculus as an instrument of analysis has vastly extended the science of geometry, so that the investigations of the ancient Greeks go but a short way into the field of knowledge which has been laid open by the modern method; the discoveries of Archimedes and Apollonius are now easy deductions from its more extended results.

So long as the early geometers confined their speculations to the comparison of the areas of rectilinear figures they encountered little difficulty. They readily showed that the determination of the area of any such figure can be reduced to that of a rectangle, or of a square, and thus be completely effected. This process of finding areas was named the "method of quadratures." It failed, however, when they attempted to determine the areas bounded by curved lines, or the surfaces of the elementary solids such as the right cone and the sphere. In treating of these the ancients found it necessary to introduce new notions and modes of demonstration into geometry, and the difficulty of comparing the areas of curvilinear with those of rectilinear figures gave rise to the "method of exhaustions." The fundamental principle of this method consists in conceiving the continual approach of two varying magnitudes to a fixed intermediate magnitude, with which they never become identical, though they may approach it to within less than any assignable difference. For example, a polygon may be inscribed in a circle, and another circumscribed to it, each differing from it by less than any assignable area; hence the ancients may have concluded that areas of circles have to each other the same ratio as the similar polygons inscribed in or circumscribed to them,—that is, the ratio of the squares of the radii. But, as this kind of proof was of a different nature from that by which the more elementary doctrines were established, the Greek geometers fortified it by a *reductio ad absurdum*,—proving, in the above example, that the square of the radius of one circle is to that of another as the area of the former is to a space which is neither less nor greater than the latter, and therefore exactly equal to it.

Archimedes. By the aid of this method Archimedes arrived at his great geometrical discoveries. He determined that the ratio of the circumference to the diameter of a circle lies between  $3\frac{1}{7}$  and  $3\frac{1}{7}$ , by considering the regular polygons of ninety-six sides which may be inscribed in or circumscribed to the circle. He proved that the area of a segment of a parabola cut off by any chord equals two-thirds of a parallelogram included between the chord and the parallel tangent to the curve. He determined the quadrature of the ellipse. In the curves named after him the "spirals of Archimedes," he showed how to draw a tangent at any point, and also determined the area of any portion.

In space of three dimensions, Archimedes proved that the surface of a sphere equals four times that of one of its great circles, that the surface of a spherical cap is equal to the area of a circle the length of whose radius is the distance from the vertex of the cap to any point on its bounding circle; that a sphere has a volume which is two-thirds of that of a cylinder circumscribed to it, and that their surfaces are in the same ratio. Further, the same method of exhaustions furnished Archimedes with the cubature of conoids and spheroids, as he termed

surfaces generated by the revolution of the parabola, the hyperbola, and the ellipse.

During nearly two thousand years no new method enabled mathematicians to rise to a higher generality than that attained in the works of the great Greek geometers. The celebrated Kepler was the first to extend the results of Archimedes. In his treatise entitled *Nova Stereometria Doliorum; accessit stereometria Archimedea supplementum* (1615),<sup>1</sup> he discussed a number of solids of revolution,—for example, those formed by the revolution of a conic section about any ordinate, or a tangent at the vertex, or any line within or without the curve. Thus he considered some ninety new solids, and proposed problems concerning them; of these problems he resolved only a few of the most simple. In this treatise he introduced for the first time the name and notion of "infinity" into the language of geometry. Thus, he considered a circle as composed of an "infinite" number of triangles, having their common vertex at the centre, and forming the circumference by their bases. In like manner he regarded a cone as composed of an infinite number of pyramids, having their vertices at its vertex, and standing on an infinite number of triangular bases, bounded by the circular base of the cone. It may also be noted that Kepler was the first to observe that the increment of a variable—the ordinate of a curve, for example—is evanescent for values infinitely near a maximum or minimum value of the variable. This remark contains the germ of the rule for determining "maxima" and "minima," given by Fermat about twenty years subsequently.

Several years after Kepler had given his method of determining volumes of revolution, another celebrated theory, of a similar kind,—the "geometry of indivisibles" (1635) of Cavalieri, professor of geometry at Bologna,—marks an epoch in the progress which science has made in modern times. In this work lines were considered as composed of an infinite number of points, surfaces of lines, and solids of surfaces. For example, if the perpendicular of a triangle be divided into an infinite number of equal parts, and through each point of division a line be drawn parallel to the base and terminated by the sides, then, according to Cavalieri, we may consider the area of the triangle as the sum of all these parallel lines, regarded as its elements. Again, as these parallels form a series in arithmetical progression, of which the first term is zero, this sum is represented by half the product of the last term and the number of terms. Now the base is the last term, and the altitude measures the number of terms; thus he deduced the ordinary expression for the area of a triangle. Cavalieri applied his method to a number of problems, such as finding the volumes of pyramids, the areas of certain simple curves of the parabolic species, the determination of centres of gravity, &c.; and it is remarkable that he was the first who gave an accurate demonstration of the well-known properties of the centre of gravity, originally announced by Pappus, but commonly called Guldin's theorems. It is accordingly to Cavalieri, and not to Guldin, that the credit is due of having made the first advance beyond Pappus. Cavalieri's method is analogous to that employed in the integral calculus, the "indivisible" being that which has since been styled the "differential element" of the integral.

<sup>1</sup> This work is enlarged from his earlier *Stereometria Doliorum Vinariorum* (1605), which originated in a dispute with a seller of wine as to the proper method of gauging the contents of a cask. This accounts for its strange title.



The method of Cavalieri was severely criticized by some of his contemporaries, more especially by Guldin. They alleged that, since a line has no breadth, no number of right lines, however great, when taken together, could make up a plane area. This objection was answered by Cavalieri; but the reply was stated in the clearest form by Pascal, who observed (letter to M. de Carcavi, 1658) that the method of indivisibles possessed all the rigour of that of exhaustions, from which it differed only in the manner of expression, and that, when we conceive an area as a sum of a system of parallel ordinates, we mean in reality an indefinite number of rectangles under the several ordinates, and the small equal portions into which we conceive the common perpendicular to these ordinates to be divided. This passage is remarkable—as was well observed by Carnot—as it shows that the notion of mathematical infinity, as now employed, was not strange to the geometers of that time; for it is clear that Pascal employed the word “indefinite” in the same signification as we now attach to the word “infinite,” and that he called “small” that which is now called “infinitely small,” also that he neglected these small quantities in comparison with finite quantities—thus he regarded as simple rectangles the small portions of the area of the curve comprised between two consecutive ordinates, neglecting the small triangles which have for their bases the differences of these ordinates. Carnot adds that no person attempted to reproach Pascal with want of rigour in his demonstrations.

Pascal applied the method of Cavalieri with eminent success to the investigation of properties of the cycloid, and other problems. His researches, according to D'Alembert, closely approach to the integral calculus, and form the connexion between the methods of Archimedes and of Newton.

The most important application, however, of Cavalieri's method was that of Wallis, Savilian professor at Oxford, who, in 1655, gave an admirable specimen of this method in his *Arithmetica Infinitorum, sive nova Methodus inquirendi in Curvilinearum Quadraturam*. Pursuing Cavalieri's views, he reduced the problem of finding the areas of a large number of curves, and the volumes of solids of revolution, to the summation of the powers of the terms of arithmetical series, consisting of an infinite number of terms,—or rather to the determination of the ratio of the arithmetical mean of all such powers of the terms to the like power of the last term.

For example, in the series of square numbers 0, 1, 4, 9, 16, &c., the ratio of the mean to the last is, for the first three terms,  $\frac{0+1+4}{4+4+4} = \frac{1}{3} + \frac{1}{12}$ ; for the first four,  $\frac{0+1+4+9}{9+9+9+9} = \frac{1}{3} + \frac{1}{18}$ ; for the first five,  $\frac{0+1+4+9+16}{16+16+16+16+16} = \frac{1}{3} + \frac{1}{24}$ ; in like manner the next fraction is  $\frac{1}{3} + \frac{1}{30}$ . Hence Wallis noticed that the fractions approach nearer and nearer to  $\frac{1}{3}$ ; and, as the denominators in the fractions  $\frac{1}{12}, \frac{1}{18}, \frac{1}{24}, \frac{1}{30}$  form an arithmetical series, with a common difference 6, it follows that, when the number of terms is indefinitely increased, the resulting fraction becomes ultimately  $\frac{1}{3}$ .

Wallis applied the same method to the series 0, 1<sup>3</sup>, 2<sup>3</sup>, 3<sup>3</sup>, &c., and found without difficulty that the aforesaid ratio is  $\frac{1}{4}$  in this case; and so generally. He also introduced into analysis the notation of fractional indices instead of radicals, and extended his method of summation to series proceeding by fractional powers of the natural numbers 1, 2, 3, &c. Wallis was enabled by these principles to obtain the areas of many curves, and the volumes of solids which had not been previously found. He also, by aid of this method, combined with the principles of “interpolation,” arrived at his well-known expression for  $\pi$ , viz. :—

$$\frac{\pi}{4} = \frac{2 \cdot 4}{1} \cdot \frac{4 \cdot 6}{3^2} \cdot \frac{6 \cdot 8}{5^2} \cdot \frac{8 \cdot 10}{7^2} \cdots$$

Again, in his treatise *De Curv. rectific.* (1659), Wallis showed that certain curves were capable of being “rectified,” or that straight lines might be found to which they were exactly equal, a remark which was very soon verified by a young English mathematician William Neil, who, by Wallis's method, obtained in 1660 the length of any arc of a semicubical parabola. This is the first curve that was rectified. The cycloid is the second; its rectification was effected by Sir C. Wren (*Phil. Trans.*, 1673). The methods we have thus far considered were more especially precursory to the integral calculus, having mainly reference to the quadrature of curves and cubature of solids. We now propose to consider the question of tangents to curves, in which the differential calculus may be said to have originated.

The great discovery of Descartes in his application of algebra to geometry (1637) imparted to the latter science the character of abstraction and generality which distinguishes modern from ancient geometry. By it the study of curves was brought under the domain of analysis, and instead of investigation being restricted to particular properties of a few isolated curves, as it had been hitherto, general views and methods applicable to all curves were introduced.

Hence the general problem of drawing tangents to curved lines started immediately into prominence. It was found necessary to depart from the definition of tangents given by the ancient geometers, and to consider them in other points of view. A tangent, accordingly, came to be regarded either (1) as a secant of which the points of intersection became coincident; or (2) as the prolongation of the element of the curve, regarded as a polygon of an infinite number of sides; or (3) as the direction of the resultant motion by which the curve may be described. The first view was that of Descartes and Fermat; the second was introduced by Barrow, who thus simplified the method of Fermat; and the third was that of Roberval.

Descartes's method of drawing a tangent consisted in supposing a circle (whose centre he placed on the axis of  $x$ ) to cut the curve in two points; then, if the radius of the circle be supposed to decrease, its centre remaining fixed, so that the points of section approach nearer and nearer and finally coincide, the circle will touch the curve; thus, by aid of the equation of the curve, the problem was reduced to one of finding the condition of equal roots in an equation. This method is remarkable as being the first general process of applying analysis to the problem of tangents; at the same time it is only capable of practical application in a small number of simple cases.

Many years subsequently (*Act. Erud. Lips.*, 1691) John Bernoulli extended Descartes's method with success to the problem of finding the centre of curvature and the equation of the evolute of an algebraic curve. In his application he supposed the centre of a circle taken on the normal to a curve, and the centre to vary until three of the points of intersection of the circle with the curve became coincident, i.e., so that the resulting equation should have three equal roots. Thus, for example, he showed, without difficulty, that the evolute of a parabola was a semicubical parabola. He also remarked that, when four roots coincide, the centre of curvature becomes a cusp on the evolute.

It should also be noticed that we owe to Descartes the general method of drawing a tangent to a roulette. This was given by him in a letter to Mersenne (Aug. 23, 1638), from which we take the following extracts:—“I have been very glad to see the questions which you say that the geometers, even M. Roberval, whom you esteem the principal of them, confess that they cannot solve; for in investigating them I may discover whether my analysis is better than theirs. The first of these questions is that of drawing



tangents to curves described by a roulette motion. My solution is as follows. If a rectilinear polygon be conceived to roll on a right line, the curve described by any one of its points will be composed of a number of arcs of circles, and the tangent at any point on one of these arcs is perpendicular to the line drawn from the point to that in which the polygon is in contact with the base, when describing the arc. Consequently, if we consider a rolling curve as a polygon of an infinite number of sides, we see clearly that the roulette traced by any point must possess the same property; that is to say, the tangent at any of its points is perpendicular to the right line connecting it with the point of contact of the rolling curve and its base." In this we perceive that Descartes gave a genuine and most important application of the infinitesimal method.

Again, Descartes first introduced the method of indeterminate coefficients into analysis,—a principle, as was ably shown by Carnot, which is of itself sufficient to establish, by ordinary algebra, the fundamental principles of the infinitesimal calculus.

Fermat.

The method of Fermat for drawing tangents was based on his method of maxima and minima. This latter was founded, as already observed, on a principle of Kepler's, viz., that, whenever a magnitude attains a maximum or minimum, its increment or diminution, for a very small change in the variable on which it depends, becomes evanescent.

Accordingly, to determine the maximum or minimum of any function of  $x$ , Fermat substituted  $x + e$  instead of  $x$ , and equated the two consecutive values of the function; then, removing the common terms, and dividing by  $e$ , he made  $e = 0$ , and obtained an equation for determining the maximum or minimum value.

Thus, adopting the modern notation, let  $y = f(x)$ , and  $y_1 = f(x + e)$ , then  $f(x + e) - f(x) = 0$ . Dividing by  $e$ ,

$$\frac{f(x+e) - f(x)}{e} = 0;$$

hence  $f'(x) = 0$ .

Thus the roots of the derived equation,  $f'(x) = 0$ , correspond to the maximum or minimum values of  $f(x)$ . Consequently we see that Fermat's rule agrees with that of the differential calculus, and in fact is the method of the calculus as applied to such cases.<sup>1</sup>

In consequence of Fermat's both having introduced the conception of an infinitely small difference, and also having arrived at the principle of the calculus for determining maxima and minima, it was maintained by Laplace, Lagrange, Fourier, and other eminent French mathematicians that Fermat ought to be regarded as the first inventor of the differential calculus. In reply to this we need but introduce the remark of their distinguished countryman Poisson, "that this calculus consists in a system of rules proper for finding the differentials of all functions, rather than in the use which may be made of these infinitely small variations in the solution of one or two isolated problems" (*Mém. de l'Acad. des Sci.*, 1831).

Fermat seems to have given no general demonstration of his method, but contented himself with giving particular applications of it to some problems of maxima and minima, as well as to finding the tangents to and the centres of gravity of a few curves.

Fermat applied his method to drawing a tangent, as follows:—

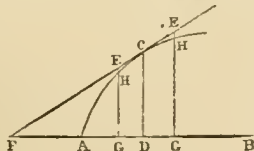

Fig. 1.

<sup>1</sup> Fermat was in possession of his method in the year 1629, as appears from a statement in one of his letters to Roberval, although it was not made public until this correspondence was printed by M. Herigone in his *Cursus Mathematicus* (1644).

Suppose CD (fig. 1) the ordinate, and CF the tangent at the point C in a curve, meeting the axis AB in F; from E, a near point on CF, draw an ordinate EG; then

$$\frac{CD}{DF} = \frac{EG}{GF} > \frac{HG}{GF},$$

if the curve be concave to the axis,

and

$$\frac{CD}{DF} < \frac{HG}{GF}$$

if the curve be convex.

Hence, in either case, the ratio of the ordinate CD to the subtangent DF is a maximum or a minimum relatively to the ratio for a near ordinate HG to GF, the abscissa measured from F, the foot of the tangent.

Accordingly, if  $CD = y$ ,  $HG = y_1$ , and  $DF = t$ , we have, by the method of maxima and minima,

$$\frac{y}{t} = \frac{y_1}{t \pm e}.$$

It is easily seen that this method furnishes the ordinary value for the subtangent, as obtained by infinitesimals; for, denoting by  $x, y$  the coordinates of C, let  $t = FD$ ,  $DG = dx$ ,  $y_1 = y + dy$ , and we have

$$\frac{y}{t} = \frac{y + dy}{t + dx}, \quad \therefore t = y \frac{dx}{dy}$$

from which the subtangent  $t$  can be obtained.

The method of Fermat was improved and extended by an Italian, Cardinal Ricci, in his *Geometrica exercitatio* (1666). Ricci was the first who showed that, if  $(a - x)^m x^n$  is a maximum, we have

$$a = \frac{na}{m+n}.$$

This he easily established when  $m$  and  $n$  are integers, from the principle that if a magnitude be divided into  $r$  equal parts, their continued product is greater than that obtained by dividing it into  $r$  parts in any other manner.

The following application, as given by him, to the curve  $y^m = px^n$ ,  $m > n$ , will help to illustrate this method of drawing tangents. To draw the tangent at C (fig. 1) take  $AF : AD = m - n : n$ , and join FC; then FC touches the curve at C.

For the product  $AF^{m-n} AD^n$  is a maximum by the preceding lemma; hence the product  $AF^{m-n} AG^n$  is not a maximum for the line FG; consequently

$$\frac{AF^{m-n} AD^n}{FD^m} > \frac{AF^{m-n} AG^n}{FG^m}, \quad \therefore \left(\frac{AD}{AG}\right)^n > \left(\frac{FD}{FG}\right)^m;$$

but, from the equation of the curve,

$$\left(\frac{AD}{AG}\right)^n = \left(\frac{CD}{CG}\right)^m;$$

$$\text{also } \frac{FD}{FG} = \frac{CD}{CG}, \quad \therefore \frac{CD}{HG} > \frac{CD}{CG}, \text{ or } EG > GH;$$

i.e., the point E falls outside the curve. In like manner it can be shown that any other point on CF lies outside the curve, and consequently CF touches the curve at C.

Barrow, Newton's predecessor in the Lucasian chair of mathematics at Cambridge, simplified and extended the method of Fermat, and advanced a step further in the development of the infinitesimal method, by the introduction of two infinitesimals instead of one in the problem of drawing a tangent. His method was as follows:—Let  $x, y$  be the coordinates of a point P on a curve (fig. 2), and take Q an adjacent point; let  $e = PR = MN$  be the increment of  $x$ , and  $a = QR$  the increment of  $y$ ; then, substituting  $x + e$  for  $x$ , and  $y + a$  for  $y$ , in the equation of the curve, subtracting the equation of the curve for the original values, and rejecting all terms of the second and higher degrees in  $a$  and  $e$ , he obtained the limiting value of  $a : e$ , or of  $PM : MT$ , thus determining the value of the subtangent. The triangle PQR, which has for its sides the elements of the curve, of the abscissa, and of the ordinate, has been called Barrow's differential triangle.

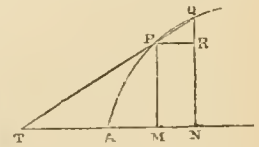

Fig. 2.

The elements which Barrow represented by  $a$  and  $e$  Leibnitz subsequently styled  $dy$  and  $dx$ , the differentials of the ordinate and abscissa of the point on the curve. Thus

Barrow anticipated the methods of Leibnitz and Newton of drawing tangents, so far as rational algebraic curves were concerned. Barrow's researches were delivered in his professorial lectures in 1664, 1665, and 1666, and were published in 1670, under the title of *Lectiones Mathematicæ*.

Roberval The method of tangents of Roberval is based on the conception of the composition of motions, recently introduced by Galileo into mechanics, and depends on finding, from the properties of the curve, the different components of the motion of the point at which the tangent is required. The direction of the resultant of these motions determines that of the tangent. This method bears an analogy to Newton's method of "fluxions," but is very limited in its application on account of the impossibility of applying it except in a few cases. Roberval applied it successfully to the following curves—the parabola, hyperbola, ellipse, conchoid of Nicomedes, limaçon of Pascal, spiral of Archimedes, quadratrix, cissoid, cycloid, companion to the cycloid, and the parabola of Descartes.

We thus see that both in England and on the Continent the principles of the infinitesimal calculus were being gradually developed. Their importance was seen and understood, and they were employed in extending the dominion of geometry. Nothing more was required but an appropriate notation to form them into a system. This was accomplished by Newton and Leibnitz, who appeared nearly at the same time in the field of discovery. In ascribing to each of these great men the full honour due to the merit of the invention of the calculus, it is proper to add that this is a question which at one time divided the opinions of the scientific world, and gave rise to a controversy which was agitated with great keenness for almost a whole century. There never could be any doubt as to Newton being the inventor of the calculus of fluxions; but the question strongly contested has been, whether Leibnitz invented his calculus independently, or borrowed it from the fluxional calculus, with which at bottom it is identical.

Newton  
and  
Leibnitz

Leibnitz, born in 1646, four years after Newton, was also later than Newton in beginning his career of discovery in mathematics. In 1673, being in London, he communicated to some members of the Royal Society what he supposed to be discoveries relative to the differences of numbers. It was, however, shown to him that the same subject had been previously discussed by Mouton, a French geometer. He then appears for the first time to have turned his attention to infinite series. On his return to Germany in 1674 he announced to Mr Oldenburg, secretary to the Royal Society, that he possessed very general analytical methods, depending on infinite series, by which he had found theorems of great importance relating to the quadrature of the circle. In reply Oldenburg informed him that Newton and Gregory had discovered similar methods for the quadrature of curves, which extended to the circle.

On June 13, 1676, Newton addressed a letter to Oldenburg, for transmission to Leibnitz. It contained his binomial theorem, the now well-known expressions for the expansion of an arc in terms of its sine, and the converse, that of the sine in terms of the arc. Contrary to modern procedure, he deduced the latter from the former, by the method of reversion of series,—a method called by Newton the "extraction of roots." This letter also contained an expression in an infinite series for the arc of an ellipse, and various other results, accompanied, however, only by brief indications of his method of demonstration.

On the 27th of the following August, Leibnitz sent a reply through Oldenburg, in which he requested fuller explanation from Newton of his theorems and method of demonstration. Leibnitz added that he possessed another method of extensive application in geometry and mechanics, of which he gave some examples.

To this communication Newton replied on October 24, 1676, in a letter which occupies thirty pages in Newton's *Opuscula* (ed. Cast.). As this letter probably gives a more complete account of the order and dates of Newton's discoveries than is to be obtained elsewhere, it appears desirable to give a brief abstract of it here. He commences by commending the very elegant method of Leibnitz for the treatment of series. He goes on to state that he himself had three methods of such treatment. His first was arrived at from the study of the method of interpolation of series by which Wallis had arrived at expressions for the area of the circle and hyperbola. Thus, by considering the series of expressions  $(1-x^2)^{\frac{1}{2}}$ ,  $(1-x^2)^{\frac{1}{4}}$ ,  $(1-x^2)^{\frac{3}{4}}$ ,  $(1-x^2)^{\frac{1}{2}}$ ,  $(1-x^2)^{\frac{3}{4}}$ , &c., he deduced from the known values of the alternate expressions, by the method of interpolations, the law which connects the successive coefficients in the expansions of the intermediate terms  $(1-x^2)^{\frac{1}{2}}$ ,  $(1-x^2)^{\frac{3}{4}}$ ,  $(1-x^2)^{\frac{1}{2}}$ , &c. Newton thus determined the area of the circle and hyperbola, in infinite series. He adds that this method would have completely escaped his memory if he had not a few weeks previously found the notes he had formerly made on the subject.

By following out the idea thus suggested, he was led to the discovery of his binomial expansion. This he tested in the case of  $(1-x^2)^{\frac{1}{2}}$  by the algebraic process of extracting the square root,—as also, in other cases, by direct multiplication. Having established this result, he was enabled to discard the method of interpolation, and to employ his binomial theorem as the most direct method of obtaining the areas and arcs of curves. Newton styled this his second method. He states that he had discovered it before the plague (in 1665-66) had compelled him to leave Cambridge, when he turned his attention to other subjects. He goes on to say that he had ceased to pursue these ideas as he suspected that Nicholas Mercator had employed some of them in his *Logarithmotechnia* (1668); and this led him to think that the remainder would have been found out before he himself was of sufficiently ripe age to publish<sup>1</sup> his discoveries (*priusquam ego ætatis essem maturæ ad scribendum*).

Newton proceeds to state that about 1669 he communicated through Barrow to Collins a compendium of his method subsequently called the "method of fluxions," with applications to areas, rectification, cubature, &c. In his letter, however, he gave no explanation of this method, carefully concealing its nature in an anagram of transposed letters, thus—6a cc d x 13e ff 7i 3l 9n 4o Aq rr 4s 9t 12v x.<sup>2</sup>

At the end of his letter Newton alludes to the solution of the "inverse problem of tangents," a subject referred to in Leibnitz's letter. For the solution of such problems he says he has two methods, which also he disguises under an anagram. The meaning of this anagram is given in his *Opuscula*, and, as it throws light on Newton's method of discovery, it is introduced here:—"Una methodus consistit in extractione fluentis quantitatis ex æquatione simul involvente fluxionem ejus. Altera tantum in assumptione seriei pro quantitate qualibet incognita ex qua cætera commode derivari possunt, et in collatione

<sup>1</sup> Newton also states in this letter that, in consequence of the various objections, &c., which were raised to his theory of light and colour, he felt that he had been imprudent in having published it, because by catching at the shadow he had lost the substance, namely, his own quiet and repose. This probably may have been the reason why Newton refrained for so long a time from making public his discovery of the method of fluxions, notwithstanding the earnest solicitation of his friends.

<sup>2</sup> It means *Data æquatione quocunque fluentes quantitates involveret, fluxiones invenire; et vice versa.*



terminorum homologorum æquationis resultantis, ad erendos terminos assumptæ scriei.

On June 21, 1677, Leibnitz sent a reply to Newton, through Oldenburg. In this he explained his method of drawing tangents to curves, introducing his notation,  $dx$  and  $dy$ , for the infinitely small differences of the successive coordinates of a point on the curve, and showed that his method could be readily applied if the equation contained irrational functions. Further on he gave one or two examples of the inverse method of tangents, such as to find the curve whose subtangent is  $b + cy + dy^2 - x$ . This, which is a problem involving the integration of a differential equation of the first order, shows that Leibnitz was then in possession of the principles of the integral calculus. The sign of integration has been found to have been employed by him in a manuscript of 29th October 1675, preserved in the royal library of Hanover (Gerhardt, *Die Entdeckung der höheren Analysis*, 1855). This date is of importance, as it proves conclusively that Leibnitz was in possession of his method before he had received through Oldenburg any account of Newton's method of fluxions, and thus shows how unfounded was the statement made in the *Commercium Epistolicum* that Leibnitz had borrowed his calculus from Newton.

The death of Oldenburg, which took place shortly afterwards, put an end to this correspondence. In the year 1684 Leibnitz, for the first time, made his method public, in the *Acta Eruditorum* of Leipsic, under the following title, "Nova methodus pro maximis et minimis, itemque tangentibus, quæ nec fractas nec irrationales quantitates moratur, et singulare pro illis calculi genus." Newton's method did not appear until 1687, when he published it, in a geometrical form, as the method of prime and ultimate ratios, in his great work *Philosophiæ Naturalis Principia Mathematica*; consequently, while Newton's claim to the priority of discovery is now admitted by all, it is no less certain that Leibnitz was the first to publish his method. It is also certain that Leibnitz enjoyed unchallenged for fifteen years the honour of being the inventor of his calculus; even Newton himself rendered him that justice in the first two editions of his *Principia*.

Subsequently, however, a foreigner, Fatio de Duillier, piqued, as is abundantly manifested in his tract, at having been omitted in an enumeration by Leibnitz of eminent geometers alone capable of solving John Bernoulli's celebrated problem of the line of quickest descent, published in 1699, at London, a memoir on the problem. In this he declared that he was obliged by the undeniable evidence of things to acknowledge Newton, not only as the first, but as by many years the first inventor of the calculus, from whom, whether Leibnitz, the second inventor, borrowed anything or not, he would rather they who had seen Newton's letters and other manuscripts should judge than himself.

This insinuation drew forth an animated reply from Leibnitz, in the *Acta Eruditorum*, May 1700, in which he cited Newton's letters, as also the testimony which Newton had rendered to him in the *Principia*, as proof of his claim to an independent authorship of his method. A reply was sent by Duillier, which the editors of the *Acta Eruditorum* refused to publish (*quasi lites aversati*). Here the dispute rested for a time. It was revived in the year 1705, when, on the publication of Newton's *Tractatus de Quadratura Curvarum*, an unfavourable review of the work,—written by Leibnitz, as has since been established,—appeared in the *Acta Eruditorum*. In this review, among other observations, it was stated that Newton employed and had always employed fluxions instead of the differences of Leibnitz, just as Fabri had substituted, in his synopsis of geometry, motion instead of the indivisibles of Cavalieri. This statement excited great indignation among British

mathematicians, one of whom—Keill, Savilian professor of astronomy at Oxford—in a letter printed in the *Philosophical Transactions* of 1708, affirmed that Newton was, without doubt, the first inventor of the calculus, and that Leibnitz, in the *Acta Eruditorum*, had merely changed the name and the notation. Leibnitz, thus directly charged with having taken his calculus from Newton, addressed a letter, March 1711, to Mr (afterwards Sir Hans) Sloane, the secretary of the Royal Society, in which he reminded him that, a similar accusation having been made some years previously by M. Fatio de Duillier, the Society and Newton himself had disapproved of it, and he requested the Society to require that Keill should retract his accusation. This Keill refused to do, and in answer addressed a letter of great length to Sloane, in which he professed to show, not only that Newton had preceded Leibnitz in the invention, but that he had given Leibnitz so many indications of his calculus that its nature might have been easily understood by any man of ordinary intelligence. That this was in substance the statement of Newton himself appears from the minutes of the Royal Society (of which he was president), April 5, 1711, in which it is stated "that the president gave a short account of the matter, referring to some letters, published by Dr Wallis, upon which Mr Keill was desired to draw up an account of the matter under dispute and set it in a just light." Keill accordingly wrote a letter which was submitted to the Society on May 24.

This letter was forwarded to Leibnitz, who, on December 29, 1711, addressed a second letter to Sloane, requiring the Society to stop these unjust attacks of Keill, and saying that Keill was too young a man to know what had passed between Newton and himself. In conclusion, he submitted the matter to the equity of the Royal Society, and stated that he was persuaded that Newton himself would do him justice. The Society, thus appealed to, appointed a committee on 6th of March 1712, to examine the old letters and other documents which had passed between mathematicians on the subject and to furnish a report to the Society. The members of the committee, as originally appointed, were Arbuthnot, Hill, Halley, Jones, Machin, and Burnet. To these Robarts, a contributor to the *Transactions*, was added on the 20th; Bonet, the Prussian minister, on the 27th; and De Moivre, Aston, and Brook Taylor on the 17th of April. The complete list of the committee was not made public until the question was investigated by the late Professor De Morgan, in 1852.

Their report, made on April 24, 1712, concluded as follows:—"The differential method is one and the same with the method of fluxions, excepting the name and mode of notation; Mr Leibnitz calling these quantities differences which Mr Newton calls moments or fluxions, and marking them with the letter  $d$ , a mark not used by Mr Newton. And therefore we take the proper question to be, not who invented this or that method, but who was the first inventor of the method; and we believe that those who have reputed Mr Leibnitz the first inventor, knew little or nothing of his correspondence with Mr Collins and Mr Oldenburg long before; nor of Mr Newton's having that method above fifteen years before Mr Leibnitz began to publish it in the *Acta Eruditorum* of Leipsic. For which reasons, we reckon Mr Newton the first inventor, and are of opinion that Mr Keill, in asserting the same, has been no ways injurious to Mr Leibnitz." On the same day the Society ordered the collection of letters and manuscripts, together with the report of the committee, to be printed, along with any other matter which would throw light on the question. This was accordingly done in the course of that year, under the title *Commercium Epistolicum D. Johannis Collins et aliorum de analysi promotum, jussu Societatis Regiæ in lucem editum*, but not at first for general publication, the

few copies printed being distributed as presents. In 1715 an elaborate account of the contents of this report was published by order of the Royal Society in their *Transactions*. The manuscript of almost the whole of this account has in recent years been found in Newton's own handwriting. (Brewster's *Life of Newton*, vol. ii. p. 75.)

In 1722 what is usually considered the second edition was published. The latest and most important edition is that of M. Biot and M. Lefort, published in Paris in 1856, in which many additional letters and documents necessary for an impartial appreciation of the question are added.

It would occupy too large a share of our space to detail the long and bitter controversy to which the *Commercium Epistolicum* gave rise. It suffices to state that from the time of its publication until long after the death of Leibnitz<sup>1</sup> (November 14, 1716), and of Newton (March 28, 1727), this controversy was carried on, first between Newton and Leibnitz, and afterwards by their respective admirers. The feeling which induces men to exalt their own nation at the expense of their neighbours contributed immensely to increase the bitterness of the dispute. It is the less necessary nowadays to enter into the merits of this great quarrel, inasmuch as it has long been agreed on, by all mathematicians who have examined into the controversy, that Newton and Leibnitz are both justly entitled to be regarded as independent discoverers of the principles of the calculus, and that, while Newton was certainly master of the method of fluxions before Leibnitz discovered his method, yet Leibnitz had several years priority of publication.

The dispute seems, however, to have had a very injurious effect on the progress of mathematics in England; for, partly owing to the natural veneration for the lofty genius of Newton, but mainly, it would appear, in consequence of the strong national prejudice produced by the bitterness of the above-mentioned controversy, British mathematicians, for considerably more than a century, failed to perceive the great superiority of the notation originated by Leibnitz to that which Newton introduced. And thus, while the Bernoullis, Euler, D'Alembert, Clairaut, Lagrange, Laplace, Legendre, and a number of other eminent Continental mathematicians were rapidly extending knowledge, by employing the infinitesimal calculus in all branches of mathematics, pure and applied, and producing a number of great treatises in every department, in England comparatively little progress was made.

In fact it was not until 1815—when three Cambridge graduates, who each afterwards rose to great distinction, Sir John Herschel, Babbage, and Peacock, published a translation of Lacroix's smaller treatise on the calculus—that the algorithm universally adopted by Continental writers was introduced into the studies of the British universities. The great superiority of Leibnitz's system of notation was soon acknowledged, and thus an immense impetus given to the study of mathematics, in all its branches. Ever since that time the method of fluxions,<sup>2</sup> as a distinct method, has become almost obsolete; and it is now strange to read Newton's own assertion in the preface to the *Commercium Epistolicum*, in which he claims that the method of fluxions

is more elegant, more natural, more geometrical, more useful, more certain, and incomparably more universal, than that of Leibnitz.

We next proceed to give a brief account of the notation and principles of the method of fluxions, as that which was first discovered.

The idea of a fluxion, as its name indicates, originated from that of motion, and all geometrical magnitudes were considered by Newton as capable of generation by continuous motion. Thus lines are conceived as generated by the motion of points, surfaces by that of lines, solids by surfaces, &c. Again, if we conceive a moving point as describing a curve, and the curve referred to coordinate axes, then the velocity of the moving point can be decomposed into two others, one parallel to the axis of  $x$ , the other to that of  $y$ ; these velocities are called the "fluxions" of  $x$  and  $y$  respectively, and the velocity of the point is the fluxion of the arc. Reciprocally, the arc is called the "fluent" of the velocity with which it is described; and the ordinates  $x$  and  $y$  are the fluents of their velocities respectively. Again, if the velocity of the moving point be regarded as constant, the fluxions of the abscissa and ordinate of any point on the curve (except in the case of a right line) will be variable; and their ratio at each instant will depend on the nature of the curve, *i.e.*, on the relation between the coordinates. Reciprocally, the relation between the coordinates depends necessarily on that which exists at each instant between their fluxions. Hence we may seek to determine the relation between the fluxions, when we know that which exists between the coordinates, *i.e.*, the equation of the curve; and reciprocally we may seek to discover the relation between the coordinates when we know that between their fluxions, either alone or combined with the coordinates themselves. The first part of the problem is called the "method of fluxions," and the second the "inverse method of fluxions."

Again, in the same case, not only do the coordinates  $x$  and  $y$  change, but also the subtangent, normal, radius of curvature, &c.; that is to say, each of these quantities increases or decreases more or less rapidly, as well as the coordinates themselves. All these quantities, accordingly, have fluxions, whose ratios are also determined by the motion of the point. Consequently these quantities may in like manner be regarded as "fluents." Similar remarks apply to areas and surfaces regarded as fluents. Newton observes that he does not consider the time formally (*formaliter*), but supposes that one of the proposed quantities increases equally (*æquabili fluxu*), to which the others are referred (*tangam ad tempus*). This fluent may be chosen at pleasure, and is what we now are accustomed to call the independent variable.

Again, if any quantities, regarded as fluents, be represented by letters, such as  $u, x, y, z$ , &c., the corresponding fluxions are represented by  $\dot{u}, \dot{x}, \dot{y}, \dot{z}$ , &c., respectively. Next, if  $\dot{u}, \dot{x}, \dot{y}, \dot{z}$  be regarded as variable or fluent quantities, their fluxions are represented by  $\ddot{u}, \ddot{x}, \ddot{y}, \ddot{z}$ , and are the fluxions of the fluxions of  $u, x, y$ , &c., *i.e.*, the second fluxions. If one of these,  $x$  for instance, be taken as the "principal fluxion," then  $\dot{x}$  is a constant, and consequently  $\ddot{x} = 0$ . In like manner we may have third fluxions, as well as those of higher orders.

Again,  $u, x, y$ , &c., may be regarded as themselves the fluxions of other quantities called their fluents. These quantities were represented by Newton, sometimes by  $u', x', y'$ , &c., in other places by  $[u], [x]$ , &c.; and from them it may be desired to proceed to the fluents.

Newton remarks that this second general problem involves three cases:—(1) when the equation contains the fluxions of two quantities and but one of their fluents; (2) when the equation involves both the fluents as well as both

<sup>1</sup> That Leibnitz at the time of his death was occupied with a reply justifying his title to an independent discovery of the calculus, has been brought to light in recent years by Dr Gerhardt's publication (1846) of the manuscript entitled *Historia et Origo Calculi Differentialis a G. G. Leibnitio*. In his letter from Vienna, 25th August 1714, to Chamberlayne, Leibnitz expressed his purpose, on his return to Hanover, to publish an impartial *Commercium Epistolicum*. This, however, remained for others to accomplish.

<sup>2</sup> That the fluxional notation in combination with that of differentials has its advantages is exhibited in many physical works; we may instance Thomson and Taylor's *Treatise on Natural Philosophy*.



the fluxions; (3) when the equation contains the fluents and the fluxions of three or more quantities.

The problem of finding the fluent when the fluxion is known is the simplest case of the first class, and is the same as the method of integration of Leibnitz. It was usually styled in Newton's time the method of quadratures, for it is reducible to the problem of finding the area of a curve, since it can be easily seen that the fluxion of an area is the ordinate, when the abscissa is taken as the principal fluent. The second class comes under what is now called the solution of differential equations; this was styled in Newton's time the "inverse method of tangents." Newton's third class is now treated of under the solution of "partial differential equations."

The infinitely small parts by which the variable quantities increase in an indefinitely small time were called by Newton the "moments" of the fluent quantities; thus, he represented an infinitely small portion of time, called a moment, by  $o$ ; then the moments or infinitely small increments of  $u$ ,  $x$ ,  $y$ , &c., are represented by  $u\dot{o}$ ,  $x\dot{o}$ ,  $y\dot{o}$ , &c.; so that if  $u$ ,  $x$ ,  $y$ , &c., denote the values of the fluents at any instant, their values at the end of an indefinitely small interval of time are represented by  $u + u\dot{o}$ ,  $x + x\dot{o}$ , &c.

For instance, let the fluents  $x$ ,  $y$ , be connected by the equation

$$x^3 - ax^2 + axy - y^3 = 0;$$

then, substituting  $x + x\dot{o}$  for  $x$ , and  $y + y\dot{o}$  for  $y$ , subtracting the original equation, and dividing by  $o$ , we get

$$3x^2\dot{x} - 2ax\dot{x} + ay\dot{x} + ax\dot{y} - 3y^2\dot{y} + 3x\dot{x}^2o + \&c.$$

Hence, regarding  $o$  as an evanescent quantity, we obtain, neglecting the powers of  $o$ ,

$$3x^2\dot{x} - 2ax\dot{x} + ay\dot{x} + ax\dot{y} - 3y^2\dot{y} = 0;$$

consequently  $x : \dot{y} = 3y^2 : ax : 3a^2 - 2ax + ay$ .

This, as Newton observes, furnishes a ready method of drawing the tangent at any point on a curve. In fact, it is, changing the notation, equivalent to Barrow's method already considered. Newton adds, that in like manner we may neglect, in all cases, the terms multiplied by the second and higher powers of  $o$ , and thus find an equation between  $x$ ,  $y$  and their fluxions  $\dot{x}$ ,  $\dot{y}$ .

A good deal of confusion has arisen from the word fluxion having been commonly employed by the early English writers in the sense of an infinitely small increment. Thus, as is abundantly shown by Professor De Morgan in his tract on the early history of infinitesimals in England (*Phil. Mag.*, 1852), all the early writers on fluxions, up to 1704, except Newton and Cheyne, employed the notation  $\dot{x}$  to represent an infinitely small increment, calling it a fluxion. It is even remarkable that, in the extract from the *Commercium Epistolicum* which we have given, the words moment and fluxion seem to have been employed as synonymous. It should also be observed that in Newton's earliest papers his method is strictly infinitesimal; and in the first edition of his *Principia* (1687) the description of fluxions is founded on infinitely small increments; so that the original conception of the calculus in England, as well as on the Continent, was based on infinitesimal principles.

Objection has frequently been made to Newton's method of fluxions, that it introduced a foreign idea, namely, that of motion, into geometry and analysis. This objection is scarcely well founded, and was indeed answered by Newton when he stated that all his method contemplates is that one of the variables should increase uniformly (*æquabili fluxu*) as we conceive time to do.

Leibnitz, like Newton, supposed any variable magnitude as continually increasing or diminishing, by momentary increments or decrements. These instantaneous changes he regarded as infinitely small differences. Thus the infinitely small difference of a variable  $u$  was represented by  $du$ . His calculus also, like Newton's, had two parts:—(1)

the *differential calculus*, which investigated the rules for deducing the relation between these infinitely small differences of quantities from the relation which exists between the quantities themselves; (2) the *integral calculus*, which treated of the inverse problem, viz., the determination of the relation of the quantities when that of their differences is known. This corresponds to Newton's inverse method of fluxions, as the differential calculus does to his direct method. It is not necessary to go into further detail here on Leibnitz's method, as it will be more fully considered subsequently; in fact, all our treatment of the calculus will be merely a development of this method.

The infinitesimal calculus had in the outset its **Objectors** opponents, such as the Abbé de Catelan, a zealous Cartesian, who declared in his *Logistique Universelle, et Méthode pour les Tangentes* (1694), that it would be better to extend the principles of the Cartesian geometry than to seek for new methods; and this was said in the preface of a book composed on the principles, somewhat disguised, of the very calculus of which he was an opponent. It had another adversary in Nieuwentijt, a man who had written some tolerable works on morality and religion, but who had slight pretensions to be regarded as a geometer. Catelan was satisfactorily answered by De l'Hôpital, as was Nieuwentijt by Leibnitz, and afterwards by Bernoulli and Hermann, who proved that this adversary of the calculus really did not know what he opposed. For instance, Nieuwentijt, while admitting differentials of the first order, rejected all those of higher orders. For such a difference of treatment there is no foundation, for, if we imagine in a circle an infinitely small chord of the first order, the versine is an infinitely small line of the second order.

The calculus had a more formidable enemy in Rolle, a skilful algebraist, but a man full of confidence in his own notions, rash in forming his opinions, and jealous of the inventions of others. He attacked the certainty of its principles, and attempted to show that its conclusions were at variance with those obtained by methods previously known, which were acknowledged to be correct. His attack was repelled by Varignon, who completely obviated the objections to the truth of the principles. These disputes occupied the French Academy a considerable part of the year 1701. The members were chiefly mathematicians advanced in years, who had been long accustomed to other methods, and were therefore not much disposed to receive new doctrines. Some took no part in the dispute, yet were not sorry to perceive a storm raised against a theory for which they had no great liking; others, more under the influence of their passions and prejudices, declared open war against it. Rolle brought forward objection upon objection; and, although Varignon answered them in succession, yet the former always claimed the victory. In the end the dispute degenerated into a quarrel, and commissioners were appointed to decide on it. These were Gonye, Cassini, and De la Hire. They, however, pronounced no judgment; but the public opinion, or at least the opinion of geometers, was in favour of Varignon. The first controversy thus ended, or rather was suspended for want of a decision from the commission; but Rolle soon renewed hostilities. The defence was next taken up by Saurin. The ground of attack was the indefinite form which the calculus gives for the subtangent of a curve at a point where two branches intersect each other, and which in this case is expressed by the fraction  $\frac{0}{0}$ . Saurin's answer was satisfactory; but Rolle, entrenched in masses of calculation, obstinately maintained the combat. The Academy was again appealed to in 1705. The Abbé Bignon, who conducted its affairs, undertook to decide the controversy, with the assistance of Gallois and De la Hire, two judges by no means favourable to Saurin. They gave no absolute

judgment, but recommended Rolle to conform more strictly to the rules of the Academy, and Saurin to forgive the proceedings of his adversary. Rolle afterwards did justice to the calculus by acknowledging his error in opposing it, and admitted that he had been urged forward by malevolent persons, one of whom was the Abbé Gallois.

Mathematicians have differed as to the best way of expounding the principles of the calculus. Newton, as has already been stated, employed the theory of motion as the means of connecting its doctrines with the principles of ordinary analysis. Leibnitz, again, with the same view, conceived quantity as passing from one degree of magnitude to another by the continual addition of infinitely small parts. The mind finds no great difficulty in distinctly apprehending the subject in either way. Objections have, however, been taken to both, and attempts made to substitute a better. Euler considered the infinitely small quantities of Leibnitz as absolutely zeros, that have to each other ratios derived from those of the vanishing quantities which they replace. D'Alembert proposed to make the basis of the calculus the consideration of the ratios of the limits of quantities. This method, as was indeed stated by D'Alembert, does not differ in any material respect from Newton's prime and ultimate ratios. An English mathematician, Landen, substituted for the Newtonian method of fluxions another purely algebraical. His views are contained in a work entitled *The Residual Analysis, a new branch of the Algebraic Art* (1764). Lagrange, too, in the *Memoirs of the Berlin Academy* for 1772, proposed to base the calculus altogether on the expansion of functions, and thus to establish it on algebraical principles merely. He subsequently developed his method in his *Théorie des Fonctions Analytiques* (1797), and in his *Leçons sur le Calcul des Fonctions* (1806). Lagrange, however, adopted the infinitesimal method as the basis of his most important work, viz., the *Mécanique Analytique*. He states in his preface to its second edition (1811) that "when we have properly conceived the spirit of the infinitesimal method, and are convinced of the exactness of its results by the geometrical method of prime and ultimate ratios, or by the analytical method of derived functions, we may employ infinitely small quantities as a sure and valuable means of abridging and simplifying our demonstrations."

We shall close this introduction with a list of works on the subject.

*Principal Works bearing on the Infinitesimal Method before the Invention of the Calculus.*—Kepler, *Nova Stereometria Dolorium Vinariorum*, 1615; Cavalieri, *Geometria Indivisibilium*, 1635; Id., *Exercitationes Geometricæ Sex*, 1647; Descartes, *Giometrie*, 1637; Torricelli, *De Sphaera et Solidis Sphaeralibus*, 1644; Grégoire St Vincent, *De Quadratura Circuli*, 1647; Huygens, *Theorematia de Quadratura*, 1647; Id., *Horologium Oscillatorium*, 1673; Wallis, *Arithmetica Infinitorum*, 1655; Id., *Opera Mathematica*, 3 vols., 1693-99; Fermat, *Opera Varia Mathematica*, 1679; Mercator, *Logarithmotechnia*, 1668; James Gregory, *Vera Circuli et Hyperbolæ Quadratura*, 1668; Barrow, *Lectiones Geometricæ*, 1670; Slusius, "Tangents to all Geometrical Curves," *Phil. Trans.*, 1672; Wren, "Rectification of the Cycloid," *Phil. Trans.*, 1673; Bullialdus, *Arithmetica Infinitorum*, 1682.

*List of some of the Principal Works on the Calculus.*—Newton, *De Analysis per Aequationes numero terminorum infinitas*, circulated in MS. in 1669 (extracts from this memoir appeared in the 2d vol. of Wallis's works, 1693, which comprehends the first publication to the world of the method of fluxions); Id., *Principia*, 1687; Id., *Treatatus de Quadratura Curvarum*, published with his *Optics*, 1704; Id., *Methodus Differentialis*, 1711; Leibnitz, "Nova Methodus pro maximis et minimis, itemque tangentibus," *Acta Erud.*, 1684; Leibnitz et Bernoulli, *Commer. Epist. Ph. et Math.*, 1745; John Bernoulli, "Inventio Lineæ Brachistochrone," *Acta Erud.*, 1696; Id., *Analysis Problematis Isoperimetrici*, 1697; Id., *Opera Omnia*, 1742; James Bernoulli, *Opera*, 1744; De l'Hôpital, *Analyse des Infiniment Petits*, 1696; Cheyne, *Fluxionum Methodus Inversa*, 1703; Hayes, *Treatise on Fluxions*, 1704; Manfredi, *De Construct. Aequat. Diff. Primi Gradus*, 1707; Taylor, *Methodus Incrementorum*, 1715; Stirling, *Lin. Tert. Ordin. Newtoni*, 1717; Hermann, "De Construct.

*Equat. Diff.*," *Comm. Petrop.*, 1726; Fontanelle, *Éléments de la Géométrie de l'Infini*, 1727; Clairaut, "Determinatio Curvæ ejusdem Diff.," *Acta Erud.*, 1729; De Moivre, *Miscellanea Analytica*, 1730; Hodgson, *Fluxions*, 1736; Simpson, *Fluxions*, 1737; MacLaurin, *Fluxions*, 1742; Donna Aguesi, *Institutioni Analyticae*, 1748; Euler, *Meth. inven. Lin. Curv. max. vel min. prop. gaud.*, 1744; Id., *Introductio Analyt. Infin.*, 2 vols., 1748; Id., *Institut. Calc. Diff.*, 2 vols., 1755; Id., *Institut. Calc. Integ.*, 3 vols., 1768-70 (the titles of Euler's numerous memoirs on the Differential and Integral Calculus are given in the edition of his *Differential Calculus* published at Pavia in 1787); Walmesly, *Analyse des Mesures, des Rapports, et des Angles*, 1750; Stirling, *Methodus Differentialis*, 1753; Bougainville, *Traité du Calcul Intégral*, 1754; Landen, *Mathematical Lucubrations*, 1755; Id., *Residual Analysis*, 1764; Id., *Mathematical Memoirs*, 1780; Saunderson, *Method of Fluxions*, 1756; Kästner, *Separatio Indeterminat. in Aequat. Diff.*, 1756; D'Alembert, *Opuscules Mathématiques*, 1761-80; Robius, *Mathematical Tracts*, 1761; Waring, *Miscellanea Analytica*, 1762; Id., *Meditationes Analyticae*, 1776; Condorcet, *Du Calcul Intégral*, 1765; Le Seur et Jaquier, *Éléments du Calcul Intégral*, 1768; Lexell, "Methodus integrandi Aeq. Diff.," *Comm. Petrop.*, 1769; Fontaine, *Traité du Calcul Diff. et Intégral*, 1770; Gianella, *De Fluxionibus et eorum Usu*, 1771; Consin, *Traité du Calcul Différentiel et Intégral*, 1776; Laplace, "L'Usage du Calcul aux Diff. part.," *Mém. de l'Acad.*, 1777; Condorcet, "De Integ. ejuisdem Aequationis," *Comm. de Bonon.*, 1783; Paoli, *Memoria sull' equazione a differenza finite e parziali*, 1784; Monge, "Sur le Calc. Int. des Equat. aux Diff. part.," *Mém. de l'Acad.*, 1784; Charles, "Recherches sur le Calcul Intégral," *Mém. de l'Acad.*, 1784; L'Huilier, *Exposition des Principes des Calculs Supérieurs*, 1786; Id., *Pr. Calculi Diff. et Integ.*, 1795; Mascheroni, *Annotationes ad Calc. Integ. Euleri*, 1790; Tabiescen, *Principia atque Historia Calculi Diff. et Integ. necnon Methodi Fluxionum*, 1793; Lagrange, "Calcul des Variations," *Misc. Taur.*, vols. ii. and iv., 1760-69; Id., *Théorie des Fonctions Analytiques*, 1797; Id., *Leçons sur le Calcul des Fonctions*, 2d ed., 1806; Id., separate *Memoirs*, edited under the care of Serret, 7 vols., 1867-77 (the remainder of his works are in course of republication in the same series); Vince, *Principles of Fluxions*, 1797; Carnot, *Réflexions sur la Méthaphysique du Calcul Infinitésimal*, 1797; Lacroix, *Traité du Calcul Différentiel et du Calcul Intégral*, 1797; Arbogast, *Calcul des Dérivations*, 1800; Legendre, *Exercices de Calcul Intégral*, 3 vols., 1811-19; Id., *Traité des Fonctions Elliptiques*, 3 vols., 1825-28; Cauchy, *Cours d'Analyse*, 1821; Id., *Appl. Géom. du Cal. Infin.*, 1823; Id., *Mém. sur les int. déf. prises entre des Limites imag.*, 1825; Id., *Leçons sur le Calcul Différentiel*, 1829; Ohm, *M.*, *System der Mathematik*, 9 vols., 1822-52; Id., *Lehrbuch f. d. gesammte Höh. Math.*, 2 vols., 1839; Magnus, *Sammlung von Aufgaben d. Analyt. Geom.*, 1833; Navier, *Leçons d'Analyse de l'Éc. Polyt.*, 1840; Moigno, *Leçons de Cal. Diff. et de Cal. Int.*, 2 vols., 1840-44; Id., *Calcul des Variations*, 1861; Duhamel, *Cours d'Analyse de l'Éc. Polyt.*, 2 vols., 1840-41; 3d ed. by Bertrand, 2 vols., 1874-75; Cournot, *Théorie des Fonctions et du Calcul Infinitésimal*, 1841; Gregory, *Examples on the Diff. and Int. Calculus*, 1841; De Morgan, *Differential and Integral Calculus*, 1842; Hymers, *Integral Calculus*, 1844; Schlämle, *Handbuch der Differenzial- und Integralrechnung*, 1847; Id., *Compendium der Höheren Analysis*, 2 vols., 1874; Minding, *Sammlung von Integraltafeln*, 1849; Meyer, *Exposé Élé. de la Théorie des Int. Déf.*, 1851; Todhunter, *Differential and Integral Calculus*, 2 vols., 1852; Id., *On Functions of Laplace, Lamé, and Bessel*, 1875; Price, *Infinitesimal Calculus*, 2 vols., 1854; Bierens De Haan, *Tables d'intégrales définies*, 1858; Id., *Exposé de la théorie des intégrales définies*, 1862; Boole, *Differential Equations*, 1859; Id., *Calculus of Finite Differences*, 1860; Grassmann, *Die Ausdehnungslehre*, 1862; Bertrand, *Traité de Cal. Diff. et de Cal. Int.*, 2 vols., 1864-70; Meyer, G. F., *Vorles. ü. d. Theorie d. bestimmten Integrale*, 1871; Williamson, *Differential and Integral Calculus*, 1872-74; Hermite, *Cours d'Analyse*, 1873; Durège, *Theorie d. Funktionen einer complexen veränderl. Grösse*, 2d ed., 1873; Folkierski, *Principles of Diff. and Int. Calc.* (Polish), Paris, 2 vols., 1873; Rubini, *Elementi di Calcolo infinitesimale*, 2 vols., 1874-75; Serret, *Cours de Calc. Diff. et Int.*, 2d ed., 2 vols., 1878-79 (the 8th edition of Lacroix's *Traité Élémentaire*, by Serret and Hermite, contains in the notes many valuable additions); Riemann, *Gesam. Math. Werke*, 2d ed., 1876; Id., *Partielle Differentialgleichungen*, 2d ed., 1876; Lipschitz, *Lehrbuch der Analysis*, 2 vols., 1877-80; Honel, *Cours de Calcul Infinitésimal*, 3 vols., 1878-79; Bouchardat, *Él. de Calc. Diff. et Int.*, 8th ed. by Lanrent, 1879; Stegemann, *Differential- und Integralrechnung*, 2 vols., 3d ed., 1880.

The preceding list contains the names of some of the most important existing treatises on the calculus. It makes no pretence to completeness; in fact, many of the most valuable contributions to the subject are published in the numerous mathematical journals, and in the transactions of learned societies. In treating of elliptic and hyperelliptic functions we shall give a short list of the chief works on that great branch of the calculus.



PART I.

DIFFERENTIAL CALCULUS.

1. In the application of algebra to the theory of curves and surfaces some of the quantities under consideration are conceived as having always the same magnitude, such as the radius of a given circle or of a given sphere, or the axes of a given ellipse or hyperbola; others again are indefinite, and may have any number of particular values, such as the coordinates of any point on a curve. This difference naturally suggests the division of the quantities involved in any question into two kinds, one called *constants*, the other *variables*.

It is usual in analysis to denote constants by the first letters of the alphabet, *a, b, c, &c.*; variables by the last, *u, v, w, x, y, z, &c.*

2. One quantity is said to be a *function* of another when they are so related that any change made in the one causes a corresponding variation in the other. This relation may subsist whether there exist an expression for the function by which its value is determined for each value of its *argument*; or the relation may sometimes be defined by certain characteristics of continuity and discontinuity. When an *expression* is presupposed the relation is usually represented by the letters *F, f, φ, &c.* Thus the equations

$$u = F(x), \quad v = f(x), \quad w = \phi(x),$$

denote that *u, v, w* are regarded as functions of *x*, whose values are determined for any particular value of *x* when the forms of the functions are known.

In each of these expressions the argument *x* is regarded as the *independent variable*, to which any value may be assigned at pleasure; and *u, v, w* are called *dependent variables*, as their values depend on that of *x*, and are determined when it is known.

For example, in each of the equations

$$y = 10x, \quad y = \tan x, \quad y = \frac{a+x}{a-x}$$

the value of *y* is known when that of *x* is given.

Such functions are called *explicit*.

3. In many cases a variable *y*, instead of being given explicitly in terms of *x*, is connected with it by an equation of a more complicated character. For instance, suppose them connected by the relations

$$x \log y = y \log x, \quad \sin y = x \sin(a+y), \quad y^3 + x^3 + 3axy = 0;$$

in these cases the value or values of *y* may be supposed known when *x* is given, and *y* is said to be an *implicit function* of *x*. Such cases are comprehended in the form

$$\phi(x, y) = 0$$

In such a form *y* may be regarded as an implicit function of *x*, or *x* as an implicit function of *y*, at pleasure.

4. Again a quantity may be a function of two or more independent variables. Thus in the equation  $u = \sin(ax + by)$ , *x* and *y* may be regarded as independent variables, and *u* as a function of them. Such functions are in general denoted by

$$\phi(x, y), \quad \phi(x, y, z), \quad \&c.$$

5. A function  $\phi(x)$  is said to be *continuous* between any limiting values of *x*, such as *a* and *b*, when to each value of *x* between those limits there corresponds a finite value of the function, and when an indefinitely small change in the value of *x* produces only an indefinitely small change in the function. In such cases the function in its passage from any one value to any other between the limits receives every intermediate value, and does not become infinite. This continuity can be readily illustrated by taking  $\phi(x)$  as the ordinate of a curve, whose equation may then be written  $y = \phi(x)$ .

6. If the variable *x* be supposed to receive any change, such change is called an *increment*; this increment of *x* is usually represented by the notation  $\Delta x$ . A decrement is regarded as a negative increment. When the increment, or difference, is supposed to be *indefinitely small*, it is called a *differential*, and is represented by  $dx$ ; *i.e.*, an infinitely small difference is called a differential.

In like manner if *u* be a function of *x*, and *x* become  $x + \Delta x$ , the corresponding value of *u* is denoted by  $u + \Delta u$ ; *i.e.*, the increment of *u* is represented by  $\Delta u$ . For finite increments of *x* it is obvious that the ratio of the increment of *u* to the corresponding increment of *x* has, in general, a finite value. Also when the increment of *x* is regarded as being indefinitely small we find that the above mentioned ratio, *i.e.*,  $\frac{\Delta u}{\Delta x}$ , has in general in each case a definite *limiting value*; and the first study of the differential calculus necessarily involves the investigation of each *limiting ratios* for the different forms of functions of *x*.

In fact we have seen that the differential calculus took its rise from the investigation of the limiting value of the ratio of the increment of the ordinate *y* to that of the abscissa *x*, so as to find the position of the tangent at any point on a curve.

thus if the equation of a curve, referred to rectangular axes, be denoted by  $f(x, y) = 0$ , then  $\frac{dy}{dx}$ , *i.e.*, the limiting value of  $\frac{\Delta y}{\Delta x}$  for any point on the curve, represents the tangent of the angle which the tangent at the point makes with the axis of *x*.

7. Again, if we suppose *x* to become  $x + h$  (where *h* represents  $\Delta x$ , the increment of *x*) in the equation  $u = f(x)$ , then the increment of *u* is represented by  $f(x+h) - f(x)$ , and  $\frac{\Delta u}{\Delta x} = \frac{f(x+h) - f(x)}{h}$ , hence

$\frac{du}{dx}$  represents the limit to which

$$\frac{f(x+h) - f(x)}{h}$$

approaches indefinitely, when *h* is diminished without limit.

There are two methods in general of finding this value of  $\frac{du}{dx}$ .

The first consists in determining the limiting value of  $\frac{f(x+h) - f(x)}{h}$

by decreasing *h* indefinitely. The second consists in expanding  $f(x+h)$  in a series of ascending powers of *h*, and taking the coefficient of *h* in the expansion. This is the method introduced by Lagrange when he proposed to make the calculus a branch of ordinary algebra, and altogether independent of the consideration of infinitely small magnitudes, or of limits.

It is easily seen, as was shown by Lagrange, that the result obtained by the latter method is the same as that arrived at by the former; for, since  $f(x+h)$  becomes  $f(x)$  when  $h=0$ ,  $f(x)$  is the first term in the expansion, and we may assume

$$f(x+h) = f(x) + ph + qh^2 + \&c.,$$

in which *p, q, &c.*, represent functions of *x*, independent of *h*, then

$$\frac{f(x+h) - f(x)}{h} = p + qh + \&c.$$

If now we suppose  $h=0$ , the left hand side reduces to *p*; and accordingly the coefficient of *h* in the expansion of  $f(x+h)$  is the limiting value of the expression  $\frac{f(x+h) - f(x)}{h}$ .

This coefficient of *h* was called by Lagrange the *first derived function* of the original function  $f(x)$ , and he represented it by the notation  $f'(x)$ .

Hence we have

$$\frac{du}{dx} = \frac{df(x)}{dx} = f'(x).$$

In this case  $f'(x)dx$  is called the *differential* of  $f(x)$ , and  $f'(x)$  is called its *differential coefficient*.

8. We have already seen that the principles of the calculus may be regarded either from the consideration of limits, or from that of infinitesimals or differentials; the former was the method adopted by Newton, in his later investigations at least; the latter was that adopted by Leibnitz.

The limit of a variable magnitude may be defined as follows. *If a variable magnitude tends continually to equality with a certain fixed magnitude, and approaches nearer to it than any assignable difference, however small, this fixed magnitude is called the limit of the variable magnitude.*

For example, if we suppose a polygon inscribed in or circumscribed to any closed curve, and afterwards imagine each side indefinitely diminished, then the closed curve is said to be the limit of either polygon. By this means the whole length of the curve is the limit of the perimeter of either polygon, and the area of the curve is the limit to the area of either polygon.

9. The following principles concerning limits are of frequent application. (1) The limit of the product of two quantities, which vary together, is the product of their limits. (2) The limit of the quotient of two quantities is the quotient of their limits. These are nearly self-evident propositions; they may, however, be formally proved as follows.

Let *P, Q* represent the variable quantities, and *p, q* their limits; then, if  $P = p + \alpha$ , and  $Q = q + \beta$ ,  $\alpha, \beta$  denote quantities which diminish indefinitely as *P* and *Q* approach their limits, and become evanescent in the limit.

Agai

$$PQ = pq + p\beta + q\alpha + \alpha\beta$$

Accordingly in the limit,  $PQ = pq$ .

The corresponding theorem for the quotients is established easily in like manner.

10. Again, if we conceive any finite number or magnitude to be divided into a very great number of equal parts, each part is very small in comparison with the original magnitude. By supposing the number of parts to be increased indefinitely, *i.e.*, so as to exceed any assigned number, however great, then each part may be regarded as indefinitely small in comparison with the proposed magnitude, and may be called an *infinitesimal* with regard to it.

By an infinitesimal, or an indefinitely small magnitude, we understand a magnitude which is less than any assigned magnitude.

however small, and which can be diminished indefinitely, so as to approach as near as we please to zero, without ever absolutely attaining to it. For instance, the difference between the area of a circle and that of an inscribed regular polygon can, by increasing the number of sides of the polygon, be made less than any assigned area, however small; but, no matter how large the number of sides may be, this difference can never become absolutely zero. It would be easy to give other illustrations of the sense in which the word infinitesimal is employed in analysis.

11. Again, if  $\alpha$  be regarded as an infinitesimal of the first order,  $\alpha^2$ , being infinitely small in comparison with  $\alpha$ , is regarded as an infinitesimal of the second order. In like manner  $\alpha^3, \alpha^4, \dots, \alpha^n$ , may be regarded as representing infinitesimals of the third, fourth, . . .  $n$ th orders, respectively.

Again, two infinitesimals  $\alpha, \beta$  are said to be of the same order if the fraction  $\frac{\beta}{\alpha}$  tends to a finite limit. If  $\frac{\beta}{\alpha}$  tends to a finite limit,

$\beta$  is called an infinitesimal of the  $n$ th order in comparison with  $\alpha$ .

12. To avoid misconception, it should be borne in mind that infinitesimals are not regarded as being actual quantities in the ordinary acceptance of the words, or as capable of exact representation. They are introduced for the purpose of abridgment and simplification of our reasonings, and are an ultimate phase of magnitude when it is conceived by the mind as capable of diminution below any assigned quantity, however small. Such magnitudes are in all cases, as styled by Carnot, *auxiliary quantities*, introduced for the purpose of facilitating our investigations, but they should disappear from our final results.

We shall illustrate this statement by the example of drawing a tangent to a curve,—in which problem the method of infinitesimals may be said to have originated. We introduce the infinitesimals  $dx$  and  $dy$ , for the purpose of finding their ultimate ratio, &c., in order to determine the limit of  $\frac{dy}{dx}$ . Now this limit is in all cases

a function of  $x$  and  $y$ , the coordinates of the point of contact, and cannot contain in it either  $dx$  or  $dy$ , since they must be taken as evanescent quantities when we proceed to the limit.

Likewise in all other applications of infinitesimals in the differential calculus, we endeavour to find the ultimate ratio of two indefinitely small quantities, or infinitesimals; and it is unnecessary to attach any precise meaning to such infinitesimals during the course of our investigations, further than to regard them as *variable quantities*, which become evanescent when we proceed to our final results.

In employing infinitesimals in such cases, we proceed on the principle that the limit of the ratio of two infinitesimals,  $\alpha$  and  $\beta$ , is the same as that of  $\alpha'$  and  $\beta'$ , provided the limit of  $\frac{\alpha'}{\alpha} = 1$ , and limit

of  $\frac{\beta'}{\beta} = 1$ . This is evident since, in all cases, we have

$$\frac{\alpha}{\beta} = \frac{\alpha'}{\beta'} \cdot \frac{\beta'}{\beta};$$

a result which must hold in the limit.

In consequence of this principle, before proceeding to the limit, we may neglect an infinitesimal of any order in comparison with one of a lower order. For instance, in seeking the ultimate ratio of  $\gamma$  to  $\delta$ , where

$$\begin{aligned} \gamma &= A_1\alpha + A_2\alpha^2 + A_3\alpha^3 + \&c. + A_n\alpha^n + \&c., \\ \delta &= B_1\beta + B_2\beta^2 + B_3\beta^3 + \&c. + B_n\beta^n + \&c., \end{aligned}$$

in which  $A_1, A_2, A_3, \dots, B_1, B_2, \&c.$ , are finite, and independent of the infinitesimals  $\alpha$  and  $\beta$ , we may neglect  $\alpha^2, \alpha^3, \beta^2, \beta^3, \dots$  in comparison with  $\alpha$  and  $\beta$ , and we get the limit of  $\frac{\gamma}{\delta} = \frac{A_1}{B_1} \times$  limit of  $\frac{\alpha}{\beta}$ .

In general, if  $\alpha, \beta$  be infinitesimals of the same order, their ratio has a finite magnitude; and if  $\gamma = f_1(\alpha, \beta)$ ,  $\delta = f_2(\alpha, \beta)$ , then in finding the limiting value of  $\frac{\gamma}{\delta}$  we take the terms of the lowest order in  $\alpha$  and  $\beta$  in  $f_1$  and  $f_2$ , neglecting all infinitesimals of higher orders; substituting in the result the limiting value of  $\frac{\alpha}{\beta}$ ,

we obtain the required limit for  $\frac{\gamma}{\delta}$ .

13. Again, if  $\alpha_1 + \alpha_2 + \dots + \alpha_n$  represents the sum of a number of infinitely small quantities which approaches a finite limit when  $n$  is indefinitely increased, and if  $\beta_1, \beta_2, \dots, \beta_m$  be another system of infinitely small quantities, such that

$$\frac{\beta_1}{\alpha_1} = 1 + \epsilon_1, \quad \frac{\beta_2}{\alpha_2} = 1 + \epsilon_2, \quad \dots \quad \frac{\beta_n}{\alpha_n} = 1 + \epsilon_n,$$

where  $\epsilon_1, \epsilon_2, \dots, \epsilon_n$  become evanescent in the limit, then, when  $n$  is indefinitely increased, the limit of the sum of  $\beta_1, \beta_2, \dots, \beta_n$  is equal to that of  $\alpha_1, \alpha_2, \dots, \alpha_n$ . This is evident from the elementary algebraic principle that the ratio  $\frac{\beta_1 + \beta_2 + \dots + \beta_n}{\alpha_1 + \alpha_2 + \dots + \alpha_n}$  lies between the greatest and

the least values of the fractions  $\frac{\beta_1}{\alpha_1}, \frac{\beta_2}{\alpha_2}, \dots, \frac{\beta_n}{\alpha_n}$ ; and it accordingly

has unity for its limit, under the supposed conditions. For example, suppose any magnitude divided into a number of parts, and that each is capable of subdivision into two parts, one of which can be simply found, and the other not so. Let  $A + a$  be the first part, of which  $A$  is of the former species, and  $a$  of the latter. In like manner let  $B + b, C + c, \&c.$  be the other parts. Then the required magnitude is represented by  $A + B + C + \&c. + a + b + c + \&c.$  Now suppose that when a sufficiently great number of parts is taken we can make  $a, b, c, \&c.$ , as small as we please in comparison with  $A, B, C, \&c.$ , then  $a + b + c + \&c.$  can be made as small as we please with respect to  $A + B + C + \&c.$ ; consequently by continuing the process indefinitely, the limit of the sum of  $A + B + C + \&c.$ , is equal to the required magnitude, without the necessity of paying any attention to the remaining parts. This latter may be regarded as the fundamental principle of the integral calculus, and the former, given in § 12, as that of the differential.

14. In consequence of metaphysical objections to the employment of infinitesimals, many writers on the calculus have confined themselves exclusively to the method of limits or limiting ratios, and by so doing have in many cases involved themselves in long and cumbersome demonstrations of theorems which follow with great facility by the adoption of infinitesimals. In reality the difference between the method of infinitesimals and that of limits (when exclusively adopted) is, that in the latter method it is usual to retain evanescent quantities of higher orders until the end of the calculation, and then to neglect them. On the other hand, such quantities are neglected from the commencement in the infinitesimal method, from the conviction that they cannot affect the final result, as they must necessarily disappear when we proceed to the limit. A very little reflection will show that the result obtained in both cases must be the same. Moreover such quantities are neglected, not, as Leibnitz stated, because they are infinitely small in comparison with those that are retained, which would produce an infinitely small error, but because they must be neglected to obtain a rigorous result; since such result must be definite and determinate, and consequently independent of these *variable indefinitely small quantities*. It may be added that the precise principles of the infinitesimal calculus, like those of any other science, cannot be thoroughly apprehended except by those who have already studied the science, and made some progress in the application of its principles.

15. The preceding statements may also be regarded in connexion with the different meanings of the terms "zero" and "an evanescent quantity." There is but one process in arithmetic which yields an *absolute* zero, namely subtraction, thus  $a - a = 0$ . But from no other arithmetical process does zero arise, except by the same train of ideas as leads us to the use of the word infinite. We cannot, for example, obtain the quotient zero by dividing one finite magnitude by another. We can make the result as small as we please, but not absolutely zero. When, therefore, we consider an equation made by addition or subtraction of terms, the absolute zero may be used without reservation, thus  $2x + a = b$ , and  $2x + a - b = 0$  may be substituted for each other without any particular examination of the symbol 0. But in any other case we consider zero or 0 as the limit towards which we approach by a series of diminutions, as the limit towards which is final. Thus when we see that we can nearly arrive at a certain conclusion by attributing a small value to a particular magnitude, that we can more nearly attain this conclusion by attributing to it a smaller value, and so on without limit, i.e., that we can approximate to this conclusion as nearly as we please by the use of a value as small as we please, but that we never attain it as long as the magnitude has any finite amount, never attain it as long as the magnitude is said, for abbreviation, to be absolutely then such conclusion is nothing or zero. These considerations will help to explain the sense in which Euler was correct when he stated that  $dx$  and  $dy$  in the calculus must be regarded each as zero.

16. We now return to the consideration of the method of finding the derived functions or differential coefficients of the different forms of functions of  $x$ . Before doing so, however, it will be necessary to establish two or three general principles.

We commence with the differentiation of a product. Let  $y = uv$ , where  $u$  and  $v$  are functions of  $x$ ; then

$$\begin{aligned} \Delta y &= (u + \Delta u)(v + \Delta v) - uv \\ &= u\Delta v + (v + \Delta v)\Delta u; \end{aligned}$$

$$\frac{\Delta y}{\Delta x} = u \frac{\Delta v}{\Delta x} + (v + \Delta v) \frac{\Delta u}{\Delta x};$$

proceeding to the limit, this becomes

$$\frac{d(uv)}{dx} = u \frac{dv}{dx} + v \frac{du}{dx}.$$

In like manner, if  $y = uvw$ , we get

$$\frac{dy}{dx} = vw \frac{du}{dx} + uv \frac{dv}{dx} + uvw \frac{dw}{dx};$$



and, in general, if  $y = y_1 y_2 y_3 \dots y_n$ , we have

$$\frac{1}{y} \frac{dy}{dx} = \frac{1}{y_1} \frac{dy_1}{dx} + \frac{1}{y_2} \frac{dy_2}{dx} + \dots + \frac{1}{y_n} \frac{dy_n}{dx} \dots$$

Again, if  $y = \frac{u}{v}$ , we have  $u = vy$ , consequently

$$\frac{du}{dx} = v \frac{dy}{dx} + y \frac{dv}{dx};$$

$$\therefore \frac{dy}{dx} = \frac{1}{v} \frac{du}{dx} - \frac{u}{v^2} \frac{dv}{dx} = \frac{v \frac{du}{dx} - u \frac{dv}{dx}}{v^2}$$

17. Next, to differentiate a function of a function of  $x$ ; let  $y = f(x)$ , and  $u = \phi(y)$ , to find  $\frac{du}{dx}$ . Suppose  $y_1, u_1$  to be the values which  $y$  and  $u$  assume when  $x$  becomes  $x_1$ , then

$$\frac{u_1 - u}{x_1 - x} = \frac{y_1 - y}{y_1 - y} \cdot \frac{u_1 - u}{x_1 - x}, \text{ or } \frac{\Delta u}{\Delta x} = \frac{\Delta u}{\Delta y} \cdot \frac{\Delta y}{\Delta x}$$

Hence, since, as proved already, the limit of the product of two variable quantities is the product of their limits, we have

$$\frac{du}{dx} = \frac{du}{dy} \cdot \frac{dy}{dx}$$

Consequently, the derived function of  $u$  with respect to  $x$  is the product of its derived with respect to  $y$  and of the derived of  $y$  with respect to  $x$ . Again, if we suppose  $u = x$ , our equations become  $y = f(x)$ , and  $x = \phi(y)$ . In the former  $y$  is regarded as a function of  $x$ , and in the latter  $x$  as the corresponding function of  $y$ .

Such functions are said to be inverse to each other; and in this case we have—

$$1 = \frac{dx}{dy} \cdot \frac{dy}{dx}, \text{ or } \frac{dx}{dy} = 1 \div \frac{dy}{dx}$$

18. There exist in analysis a small number of simple or elementary functions, each of which requires a special investigation in order to find the corresponding derived function. When these have been established the differentiation of functions composed of these elementary functions can be readily obtained, by applying one or more of the principles just established.

19. We commence with the equation  $y = x^n$ , in which  $n$  is a constant.

(1) Let  $n$  be an integer, and  $y_1$  the value which  $y$  assumes when  $x$  becomes  $x_1$ ; then

$$\frac{y_1 - y}{x_1 - x} = \frac{x_1^n - x^n}{x_1 - x} = x_1^{n-1} + x_1^{n-2} + \dots + x^{n-1}$$

Now the limit of the right hand side when  $x = x_1$  is  $nx^{n-1}$ ; accordingly we have in this case

$$\frac{dx^n}{dx} = nx^{n-1}$$

(2) Let  $y = x^{\frac{m}{n}}$ , where  $m$  and  $n$  are integers. Here  $y^n = x^m$ , and accordingly  $ny^{n-1} \frac{dy}{dx} = mx^{m-1}$ ; hence we get  $\frac{dy}{dx} = \frac{m}{n} x^{\frac{m}{n}-1}$

(3) Let  $y = x^{-m} = \frac{1}{x^m}$ ; then, from § 16, we get  $\frac{dy}{dx} = -mx^{-m-1}$

Consequently we get the following rule, applicable in all cases, for the differentiation of a power of  $x$ :

*Diminish the index by unity, and multiply the power of  $x$  thus obtained by the original index.*

20. We shall next consider the elementary circular and trigonometrical functions.

Let  $y = \sin x$ . Then  $y_1 = \sin(x+h)$ ;

$$\frac{y_1 - y}{h} = \frac{\sin(x+h) - \sin x}{h} = \frac{2}{h} \sin \frac{h}{2} \cos \left(x + \frac{h}{2}\right)$$

But  $\frac{2}{h} \sin \frac{h}{2}$  becomes unity in the limit, and consequently

$$\frac{dy}{dx} = \cos x$$

In like manner it is easily seen that

$$\frac{d \cos x}{dx} = -\sin x$$

Again,  $\frac{d \tan x}{dx} = \frac{d}{dx} \left| \frac{\sin x}{\cos x} \right| = \frac{\cos x \frac{d \sin x}{dx} - \sin x \frac{d \cos x}{dx}}{\cos^2 x}$

$$= \frac{\cos^2 x + \sin^2 x}{\cos^2 x} = \frac{1}{\cos^2 x} = \sec^2 x$$

Similarly  $\frac{d \cot x}{dx} = -\frac{1}{\sin^2 x}$ ,  $\frac{d \sec x}{dx} = \sec x \tan x$ .

Corresponding to these trigonometrical functions we have the circular functions,  $\sin^{-1}x$ ,  $\cos^{-1}x$ ,  $\tan^{-1}x$ , &c.

If  $y = \sin^{-1}x$ , we have  $x = \sin y$ , and hence

$$\frac{dx}{dy} = \cos y, \text{ or } \frac{dy}{dx} = \frac{1}{\cos y} = \frac{1}{\sqrt{1-x^2}}$$

$$\therefore \frac{d \sin^{-1}x}{dx} = \frac{1}{\sqrt{1-x^2}}$$

In like manner

$$\frac{d \cos^{-1}x}{dx} = \frac{-1}{\sqrt{1-x^2}}, \quad \frac{d \tan^{-1}x}{dx} = \frac{1}{1+x^2}$$

21. Next, let  $y = \log_a x$ . Here  $y_1 = \log_a(x+h)$ ;

$$\therefore \frac{y_1 - y}{h} = \frac{1}{h} \log_a \left(\frac{x+h}{x}\right) = \frac{1}{h} \log_a \left(1 + \frac{h}{x}\right)$$

Let  $\frac{h}{x} = u$ ; then

$$\frac{1}{h} \log_a \left(1 + \frac{h}{x}\right) = \frac{1}{xu} \log_a (1+u) = \frac{1}{x} \log_a (1+u)^{\frac{1}{u}}$$

The limiting value of  $(1+u)^{\frac{1}{u}}$  when  $u = 0$ , i.e., of  $\left(1 + \frac{1}{z}\right)^z$  when  $z$

increases indefinitely, is represented by the letter  $e$  (see ALGEBRA, vol. i. p. 558), and is the base of the natural or Napierian system of logarithms. Hence we have

$$\frac{d \log_a x}{dx} = \frac{1}{x} \log_a e$$

If  $e$  be taken as the base of our system of logarithms, we have

$$\frac{d \log x}{dx} = \frac{1}{x}$$

In our subsequent investigations we shall suppose all logarithms, unless otherwise specified, referred to this base, and omit the suffix.

22. The method of differentiation of an exponential function follows immediately from the preceding.

For let  $y = a^x$ , then  $\log y = x \log a$ ,

$$\therefore \frac{1}{y} \frac{dy}{dx} = \log a, \text{ or } \frac{dy}{dx} = a^x \log a$$

We add a few examples for the purpose of showing the application of the preceding results to the differentiation of more complex functions.

(1)  $y = x^x$ .

Here  $\log y = x \log x$ ;  $\therefore \frac{1}{y} \frac{dy}{dx} = \log x + 1$ .

Hence  $\frac{dy}{dx} = (1 + \log x)x^x$ .

(2)  $y = \log \frac{x}{\sqrt{a^2 + x^2}}$

Here  $y = \log x - \frac{1}{2} \log(a^2 + x^2)$ ;

$$\therefore \frac{dy}{dx} = \frac{1}{x} - \frac{x}{a^2 + x^2} = \frac{a^2}{x(a^2 + x^2)}$$

(3)  $y = \log \frac{\sqrt{1+x} + \sqrt{1-x}}{\sqrt{1+x} - \sqrt{1-x}}$

Here  $y = \frac{1}{2} \log \left( \frac{\sqrt{1+x} + \sqrt{1-x}}{\sqrt{1+x} - \sqrt{1-x}} \right)^2 = \frac{1}{2} \log \frac{1 + \sqrt{1-x^2}}{1 - \sqrt{1-x^2}}$

$$= \frac{1}{2} \log(1 + \sqrt{1-x^2}) - \frac{1}{2} \log(1 - \sqrt{1-x^2});$$

$$\therefore \frac{dy}{dx} = \frac{-x}{2\sqrt{1-x^2}(1 + \sqrt{1-x^2})} - \frac{x}{2\sqrt{1-x^2}(1 - \sqrt{1-x^2})}$$

$$= \frac{-1}{x\sqrt{1-x^2}}$$

(4) Prove that  $\sin^2 x \frac{d}{dx} (\sin^m x \sin nx) = n \sin^{m+1} x \sin(n+1)x$ .

Here  $\frac{d}{dx} (\sin^m x \sin nx) = n \sin^{m-1} x (\cos x \sin nx + \sin x \cos nx)$

$$= n \sin^{m-1} x \sin(n+1)x; \quad \therefore \&c.$$

5)  $y = \tan^{-1} \frac{\sqrt{1+x^2} + \sqrt{1-x^2}}{\sqrt{1+x^2} - \sqrt{1-x^2}}$

Here  $\frac{\sqrt{1+x^2} + \sqrt{1-x^2}}{\sqrt{1+x^2} - \sqrt{1-x^2}} = \tan y$ ; from this we get

$$x^2 = \sin 2y;$$

$$\therefore \frac{dy}{dx} = \frac{x}{\cos 2y} = \frac{x}{\sqrt{1-x^2}}$$

(6) If  $y = \log \sin x$ , prove that  $\frac{dy}{dx} = \cot x$ .

(7) If  $y = e^{ax}$ , prove that  $\frac{dy}{dx} = e^{ax} a(1 + \log a)$ .

(8) If  $y = \frac{1}{x}$ , prove that

$$\frac{dy}{dx} + \frac{y}{x} = 0.$$

(9) If  $y = \log(\sqrt{x+a} + \sqrt{x+b})$ , prove that  $\frac{dy}{dx} = \frac{1}{2\sqrt{(x+a)(x+b)}}$ .

23. We shall conclude this section with the consideration of the differential of the area  $\Delta BPM$  (fig. 3) of a plane curve, comprised between the curve, the axis of  $x$ , and two ordinates, of which one  $BA$  is fixed and the other  $PM$  is variable,  $x, y$  representing the coordinates of  $P$ . This area, when the equation of the curve is given, is an *implicit function* of  $x$ . If it be represented by  $u$ , we proceed to find its differential coefficient, or  $\frac{du}{dx}$ . Suppose  $x$  to receive an indefinitely small increment represented by  $MM'$ , the corresponding increment of the area is represented by  $PMM'P'$ , i.e., by the sum of the rectangle  $PMM'R$  and the elementary area  $PP'R$ . Now the latter area becomes evanescent in the limit in comparison with  $PMM'R$ .

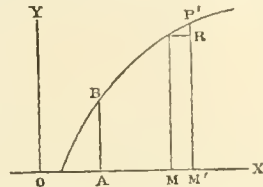

Fig. 3.

Consequently in proceeding to the limit we have  $\frac{du}{dx} = PM = y$ , or  $\frac{du}{dx} = \phi(x)$ , where  $y = \phi(x)$  is the equation of the curve.

From this we can make an important inference, viz., that in all cases there exists a function whose differential coefficient is any given function of  $x$ , suppose  $\phi(x)$ . To find such a function it is sufficient to consider the curve whose equation in rectangular coordinates is  $y = \phi(x)$ ; then the area comprised between any fixed ordinate and the ordinate whose abscissa is  $x$  is a determinate function,—which, by the preceding, has  $\phi(x)$  for its derived function.

*Successive Differentiation.*

24. We have seen that from any function of a variable we can obtain by differentiation a new function, called its differential coefficient, or, after Lagrange, its derived function.

If the primitive function be represented by  $f(x)$ , then, as already stated, its *first* derived function is denoted by  $f'(x)$ . If this new function,  $f'(x)$ , be treated in the same manner, its derived function is called the *second* derived of the original function  $f(x)$ , and is denoted by  $f''(x)$ . In like manner, the derived function of  $f''(x)$  is the *third* derived of  $f(x)$ , and is represented by  $f'''(x)$ , &c. In accordance with this notation, the successive derived functions of  $f(x)$  are represented by

$$f'(x), f''(x), f'''(x), \dots, f^{(n)}(x),$$

each of which is the derived function of the preceding.

25. In like manner, if  $y = f(x)$ , then  $\frac{dy}{dx} = f'(x)$ .

Hence 
$$\frac{d\left(\frac{dy}{dx}\right)}{dx} = \frac{d^2y}{dx^2} = f''(x)$$

The function  $\frac{d\left(\frac{dy}{dx}\right)}{dx}$  is written  $\frac{d^2y}{dx^2}$ , and is called the second differential coefficient of  $y$  with regard to  $x$ .

Likewise  $\frac{d^3y}{dx^3}$  is written  $\frac{d^3y}{dx^3}$ , and so on;

and the series of functions

$$\frac{dy}{dx}, \frac{d^2y}{dx^2}, \frac{d^3y}{dx^3}, \dots, \frac{d^ny}{dx^n}$$

are called the first, second, third, . . . *n*th differential coefficients of the function represented by  $y$ .

It is sometimes convenient to adopt a notation analogous to that of fluxions, and to represent the series of differential coefficients of  $y$  by

$$y', y'', y''', \dots, y^{(n)},$$

in order to abbreviate the labour of writing down the system of successive differential coefficients.

26. It is plain that the determination of the series of successive derived functions of any function of  $x$  does not require any new principles, as it is accomplished by successive applications of the methods already considered.

For example, if  $y = a^n$ , we have

$$\frac{dy}{dx} = na^{n-1},$$

hence  $\frac{d^2y}{dx^2} = n(n-1)a^{n-2}$ ,  $\frac{d^3y}{dx^3} = n(n-1)(n-2)a^{n-3}$ , &c

Again, if  $y = e^{ax}$ , we have

$$\frac{dy}{dx} = ae^{ax}, \quad \frac{d^2y}{dx^2} = a^2e^{ax}, \quad \&c.,$$

and in general  $\frac{d^ny}{dx^n} = a^n e^{ax}$

27. We next proceed to a fundamental theorem due to Leibnitz, and first published in *Mis. Berol.*, 1710, viz., to find the *n*th derived function of the product of two functions.

Let  $y = uv$ ; then, if we write  $u', u'', u''', u''', \dots$ , &c., for

$$\frac{du}{dx}, \frac{d^2u}{dx^2}, \frac{d^3u}{dx^3}, \dots, \&c.,$$

we have  $y' = uv' + uv''$ .

The next differentiation gives

$$y'' = uv'' + u'v' + v'u' + uv''' = uv''' + 2u'v' + uv''.$$

The third differentiation gives

$$y''' = uv'''' + u''v'' + 2u''v' + 2u'v'' + v''u'' + uv'''' = uv'''' + 3u''v' + 3u'v'' + uv''''.$$

in which the coefficients are the same as those in the expansion of  $(a+b)^3$ .

Suppose that the same law holds for the *n*th differential coefficient, and that

$$y^{(n)} = uv^{(n)} + nu'v^{(n-1)} + \frac{n(n-1)}{1 \cdot 2} u''v^{(n-2)} + \dots + nu^{(n-1)}v' + u^{(n)}v;$$

then, differentiating again, we get

$$y^{(n+1)} = uv^{(n+1)} + u'v^{(n)} + n(u''v^{(n)} + u'v^{(n-1)}) + \frac{n(n-1)}{2} (u''v^{(n-1)} + u''v^{(n-2)}) + \dots + u^{(n+1)}v = uv^{(n+1)} + (n+1)u'v^{(n)} + \frac{(n+1)n}{1 \cdot 2} u''v^{(n-1)} + \dots,$$

in which the coefficients follow the law of the Binomial Expansion. Accordingly, if this law hold for any integer value of *n*, it holds for the next higher integer; but it holds when *n*=3, therefore it holds for *n*=4, &c.

In the ordinary notation the preceding result is written

$$\frac{d^n(uv)}{dx^n} = u \frac{d^n v}{dx^n} + n \frac{du}{dx} \frac{d^{n-1} v}{dx^{n-1}} + \frac{n(n-1)}{1 \cdot 2} \frac{d^2 u}{dx^2} \frac{d^{n-2} v}{dx^{n-2}} + \dots + v \frac{d^n u}{dx^n}$$

(1) If  $y = e^{ax} \sin bx$ , to find  $\frac{d^ny}{dx^n}$

Here 
$$\frac{dy}{dx} = e^{ax} (a \sin bx + b \cos bx).$$

Now let  $b = a \tan \phi$ , and we have

$$\frac{dy}{dx} = (a^2 + b^2)^{\frac{1}{2}} e^{ax} (\sin bx \cos \phi + \cos bx \sin \phi) = (a^2 + b^2)^{\frac{1}{2}} e^{ax} \sin (bx + \phi).$$

Similarly we get  $\frac{d^2y}{dx^2} = (a^2 + b^2)^{\frac{n}{2}} e^{ax} \sin (bx + 2\phi)$ ;

and, in general,  $\frac{d^ny}{dx^n} = (a^2 + b^2)^{\frac{n}{2}} e^{ax} \sin (bx + n\phi)$ .

(2) If  $y = \cot^{-1} x$ , to find  $\frac{d^ny}{dx^n}$ .

Here  $x = \cot y, \therefore \frac{dy}{dx} = -\sin^2 y,$

hence 
$$\frac{d^2y}{dx^2} = -\frac{d}{dx} (\sin^2 y) = -\frac{dy}{dx} \cdot \frac{d}{dy} (\sin^2 y) = -\sin^2 y \cdot \frac{d}{dy} (\sin^2 y) = \sin^2 y \sin 2y.$$

Again 
$$\frac{d^3y}{dx^3} = \frac{d}{dx} (\sin^2 y \sin 2y) = \frac{dy}{dx} \cdot \frac{d}{dy} (\sin^2 y \sin 2y)$$

$$= -\sin^2 y \cdot \frac{d}{dy} (\sin^2 y \sin 2y)$$

$$= -1 \cdot 2 \sin^3 y \sin 3y.$$

(Ex. 4, § 22.)

In like manner,

$$\frac{d^4y}{dx^4} = 1 \cdot 2 \cdot 3 \sin^4 y \sin 4y.$$

And, in general,  $\frac{d^ny}{dx^n} = (-1)^n \cdot \frac{1}{2} \cdot \frac{n-1}{2} \sin^n y \sin ny.$

(3) If  $y = x^{n-1} \log x$ , prove that  $\frac{d^n y}{dx^n} = \frac{n-1}{x}$ .

(4) If  $y = \cos (a \sin^{-1} x)$ , prove that

$$(1-x^2) \frac{d^2 y}{dx^2} - x \frac{dy}{dx} + a^2 y = 0.$$

(5) If  $y = a \cos nx + b \sin nx$ , prove that

$$\frac{d^2 y}{dx^2} + n^2 y = 0.$$

(6) If  $u = xy$ , prove that

$$\frac{d^n u}{dx^n} = x \frac{d^{n-1} y}{dx^{n-1}} + n \frac{d^{n-1} y}{dx^{n-1}}.$$

*Partial Differentiation.*

28. We have hitherto treated of functions of a single independent variable solely. The principles established so far apply equally to the case of functions of two or more independent variables.

For example, in the equation

$$u = ax^2 + 2bxy + cy^2,$$

the variables  $x$  and  $y$  may be capable of change independently of each other; and if we suppose  $x$  to vary,  $y$  remaining constant, the corresponding differential coefficient of  $u$  is represented by  $\frac{du}{dx}$ , and we have

$$\frac{du}{dx} = 2ax + 2by.$$

In the same case if we suppose  $y$  to vary,  $x$  being unchanged, the corresponding differential coefficient is represented by  $\frac{du}{dy}$ , and we

have 
$$\frac{du}{dy} = 2bx + 2cy.$$

In general, if  $u$  be a function of two variables,  $x$  and  $y$ , represented by the equation

$$u = \phi(x, y),$$

we have two differential coefficients

$$\frac{du}{dx} \text{ or } \frac{d\phi(x, y)}{dx}, \text{ and } \frac{du}{dy} \text{ or } \frac{d\phi(x, y)}{dy}.$$

These are called the *partial differential coefficients* of the function, with regard to  $x$  and  $y$  respectively. They are usually written  $\frac{\partial \phi}{\partial x}$  and  $\frac{\partial \phi}{\partial y}$ , and are plainly determined in the same manner as in the case of a single variable.

29. These new functions  $\frac{du}{dx}$  and  $\frac{du}{dy}$  admit of being treated in like manner. Thus the partial differential coefficient of  $\frac{du}{dx}$ , taken with

respect to  $x$ ,  $y$  being supposed unchanged, is represented by  $\frac{d^2 u}{dx^2}$

or by  $\frac{\partial^2 u}{\partial x^2}$ ; likewise its differential coefficient with respect to  $y$  is represented by  $\frac{\partial^2 u}{\partial y \partial x}$ ; and so on.

30. It can be seen without difficulty that

$$\frac{d^2 u}{dx dy} = \frac{\partial^2 u}{\partial y \partial x}, \text{ i.e., } \frac{d}{dy} \frac{du}{dx} = \frac{d}{dx} \frac{du}{dy}.$$

In fact  $\frac{\partial^2 u}{\partial y \partial x}$  signifies the limit to which  $\frac{\Delta \Delta u}{\Delta x \Delta y}$  approaches as  $\Delta x$  and  $\Delta y$  diminish beyond limit.

Again 
$$\frac{\Delta u}{\Delta x} = \frac{\phi(x + \Delta x, y) - \phi(x, y)}{\Delta x}.$$

In like manner,

$$\frac{\Delta \frac{\Delta u}{\Delta x}}{\Delta y} = \frac{\frac{\phi(x + \Delta x, y + \Delta y) - \phi(x + \Delta x, y)}{\Delta x} - \frac{\phi(x, y + \Delta y) - \phi(x, y)}{\Delta x}}{\Delta y} = \frac{\phi(x + \Delta x, y + \Delta y) - \phi(x + \Delta x, y) - \phi(x, y + \Delta y) + \phi(x, y)}{\Delta x \Delta y}.$$

It is easily seen that  $\frac{\Delta \frac{\Delta u}{\Delta x}}{\Delta y}$  has the same value. Accordingly the limits of the two expressions must be equal, and hence we infer

$$\frac{\partial^2 u}{\partial y \partial x} = \frac{\partial^2 u}{\partial x \partial y}.$$

31. In general, if  $u$  be a function of several independent variables  $x_1, x_2, \dots, x_n$ , we obtain  $n$  partial differential coefficients of the first order, denoted by

$$\frac{du}{dx_1}, \frac{du}{dx_2}, \dots, \frac{du}{dx_n}.$$

In like manner, the partial differential coefficients of the second order are represented by

$$\frac{d^2 u}{dx_1^2}, \frac{d^2 u}{dx_1 dx_2}, \frac{d^2 u}{dx_2^2}, \text{ \&c., and so on.}$$

We have, as in the former case, between each pair of variables

$$\frac{d^2 u}{dx_1 dx_2} = \frac{d^2 u}{dx_2 dx_1}, \text{ \&c.}$$

32. In the equation  $u = \phi(x, y)$ , if we consider  $x$  and  $y$  to increase simultaneously, then, if  $\Delta u$  represents the total increment of  $u$ , we have

$$\begin{aligned} \Delta u &= \phi(x + \Delta x, y + \Delta y) - \phi(x, y) \\ &= \phi(x + \Delta x, y + \Delta y) - \phi(x, y + \Delta y) + \phi(x, y + \Delta y) - \phi(x, y) \\ &= \phi(x + \Delta x, y + \Delta y) - \phi(x, y + \Delta y) \Delta x + \frac{\phi(x, y + \Delta y) - \phi(x, y)}{\Delta y} \Delta y. \end{aligned}$$

If now we suppose  $\Delta x$  and  $\Delta y$  to diminish indefinitely, and represent the corresponding differentials by  $du, dx, dy$ , we have in the limit

$$du = \frac{du}{dx} dx + \frac{du}{dy} dy.$$

This is called the *total differential* of  $u$ , and it is readily seen that it is equal to the sum of the partial differentials arising from the separate increments in  $x$  and  $y$ . The same principle plainly holds in a function of any number of variables.

33. If  $u = \phi(v, w)$ , where  $v$  and  $w$  are both functions of  $x$ , then by the preceding it is readily seen that

$$\frac{du}{dx} = \frac{du}{dv} \frac{dv}{dx} + \frac{du}{dw} \frac{dw}{dx};$$

and similarly for any number of functions.

34. The principles of total and partial differentiation admit of simple illustration in plane and in spherical trigonometry. For, in either a plane or a spherical triangle, we may regard any three of the parts  $a, b, c, A, B, C$  as being independent variables, and each of the others as a function of the three so chosen.

For instance, in a plane triangle, if the sides  $a$  and  $b$  and the contained angle  $C$  be taken as the independent variables, we have

$$c^2 = a^2 + b^2 - 2ab \cos C;$$

hence 
$$\frac{dc}{da} = \frac{a - b \cos C}{c} = \cos B;$$

likewise 
$$\frac{dc}{db} = \cos A, \quad \frac{dc}{dC} = a \sin B,$$

$$\therefore dc = \cos B da + \cos A db + a \sin B dC.$$

Again, to find  $\frac{dA}{dC}$ , we have  $b \sin A = a \sin B = a \sin (A + C)$ ;

hence, regarding  $a$  and  $b$  as constant, we have

$$\begin{aligned} b \cos A \frac{dA}{dC} &= a \cos (A + C) \left( 1 + \frac{dA}{dC} \right) = -a \cos B - a \cos B \frac{dA}{dC} \\ \therefore \frac{dA}{dC} &= -\frac{a \cos B}{c}. \end{aligned}$$

In like manner we have, in the same case,

$$\frac{dA}{da} = \frac{\sin B}{c}, \quad \frac{dA}{db} = -\frac{\sin A}{c}, \quad \therefore dA = \frac{\sin B}{c} da - \frac{\sin A}{c} db - \frac{a \cos B}{c} dC.$$

Again, in a spherical triangle,

$$\cos c = \cos a \cos b + \sin a \sin b \cos C.$$

From this we obtain

$$\frac{dc}{da} = \cos B, \quad \frac{dc}{db} = \cos A, \quad \frac{dc}{dC} = \sin a \sin B,$$

$$\therefore dc = \cos B da + \cos A db + \sin a \sin B dC.$$

This, and the preceding, also admit of a simple geometrical demonstration, by drawing the triangle and comparing the small increments in each case.

35. Again, since from any equation in spherical trigonometry another can be deduced by aid of the *polar triangle*, we get from the preceding

$$dC = -\cos b da - \cos a db + \sin A \sin b dc.$$

Corresponding formulæ are obtained by an interchange of letters.

<sup>1</sup> The case of the three angles of a plane triangle is excepted, as they are equivalent to but two independent data.



Again, the infinitesimals  $da, db, dA, dB$  are connected by the equation

$$\frac{a a}{\tan a} + \frac{d B}{\tan B} = \frac{d A}{\tan A} + \frac{d b}{\tan b}$$

This follows immediately from the equation  $\sin a \sin B = \sin A \sin b$ .

36. These and the analogous formulæ, when we adopt small differences instead of differentials, are of importance in astronomy in determining the errors in a computed distance arising from small errors in observation. They also enable us to determine the circumstances under which the most favourable observations are made, viz., those for which small errors in observation produce the least error in the required result.

The relations between the variations in the sides and angles of plane and spherical triangles were first treated of by Cotes, in his *Estimatio Errorum in mixta Mathesi* (1722).

(1) The values of  $\frac{dy}{dx}$  and  $\frac{dz}{dx}$ , when  $x, y, z$  are connected by two equations of the form  $f(x, y, z) = 0, \phi(x, y, z) = 0$ , are found to be

$$\frac{dy}{dx} = \frac{df \, d\phi - \frac{df \, d\phi}{dz} \frac{dz}{dx}}{\frac{df}{dz} \frac{d\phi}{dx} - \frac{df \, d\phi}{dz} \frac{d\phi}{dx}}$$

(2) If  $f(u) = \phi(v)$ , where  $u$  and  $v$  are each functions of  $x$  and  $y$ , it is easily shown that

$$\frac{du}{dx} \frac{dv}{dy} - \frac{du}{dy} \frac{dv}{dx} = 0$$

(3) In a spherical triangle, if  $\frac{\sin C}{\sin c}$  be constant, and equal to  $\kappa$ , the relations

$$\frac{da}{\cos A} + \frac{db}{\cos B} + \frac{dc}{\cos C} = 0$$

and  $\cos A \, da + \cos B \, db + \cos C \, dc = \kappa^2 d(\sin a \sin b \sin c)$  can be readily established.

(4) More generally, it may be shown that, if  $\kappa$  also be supposed to vary,

$$\frac{da}{\cos A} + \frac{db}{\cos B} + \frac{dc}{\cos C} = \tan A \tan B \tan C d\left(\frac{1}{\kappa}\right),$$

and  $\cos A \, da + \cos B \, db + \cos C \, dc = \kappa d(\kappa \sin a \sin b \sin c)$ ,

(5) If  $u$  be a function of  $\xi, \eta, \zeta$ , and  $\xi = y + \frac{z}{x}, \eta = z + \frac{1}{x}, \zeta = x + \frac{1}{y}$ , show that

$$x \frac{du}{dx} + y \frac{du}{dy} + z \frac{du}{dz} + \xi \frac{du}{d\xi} + \eta \frac{du}{d\eta} + \zeta \frac{du}{d\zeta} = 2 \left( x \frac{du}{d\xi} + y \frac{du}{d\zeta} + z \frac{du}{d\eta} \right)$$

*Taylor's Theorem and Development of Functions.*

37. We have already noticed that the development of functions by infinite series was a branch of analysis that rose into prominence during the latter portion of the 17th century.

The first series thus published were—that of Nicholas Mercator in his *Logarithmotechnia* (1668) for the expansion of  $\log(1+x)$ , or what was then styled the area of an hyperbola (this he arrived at by the aid of Wallis's method of quadratures); and that of James Gregory, in a letter to J. Collins, 1671, for the expansion of an arc in terms of its tangent. About the same time the first efforts of Newton's genius were directed to this subject; and, as we have already seen, he thus arrived at his binomial theorem, and other general expansions, such as those of  $\sin x, \cos x, e^x$ , &c.

It was not, however, until many years after these discoveries that it was found that all such expansions may be regarded as particular cases of one general theorem. This theorem was discovered by Dr Brook Taylor, and published by him in 1715 in his *Methodus Incrementorum*.

38. Before proceeding to a consideration of this important series it should be observed that, in 1694, John Bernoulli published, in the *Acta Eruditorum*, his well-known expansion under the title *Additamentum effectiois omnium quadraturarum et rectificatorum curvarum per seriem quandam generalissimam*.

This series may be written as follows, slightly altering Bernoulli's notation:—

$$\int y \, dx = xy - \frac{x^2}{1.2} \frac{dy}{dx} + \frac{x^3}{1.2.3} \frac{d^2y}{dx^2} - \&c$$

Bernoulli obtained this result immediately by differentiation, by which process it can be easily verified.

This is the first general theorem on series that was discovered; and it was easily shown by its author that the ordinary series, such as the expansions of  $\log(1+x)$ , of  $\sin x$ , and others, can be deduced from it.

This theorem of Bernoulli, however, is but a particular case of Taylor's, as will be shown subsequently.

39. Taylor arrived at his theorem as a particular case of another in *finite differences*,—a branch of the calculus treated of for the first time in his *Methodus Incrementorum*. Introducing the modern notation, Taylor's proof, with some modifications, is as follows.

Let  $f(x)$  be any function of  $x$ , and suppose  $x$  changed successively into

$$x + \Delta x, \quad x + 2\Delta x, \quad x + 3\Delta x, \quad \dots \quad x + n\Delta x;$$

and let the functions

$$f(x), \quad f(x + \Delta x), \quad f(x + 2\Delta x), \quad \dots \quad f(x + n\Delta x)$$

be represented by

$$y, \quad y_1, \quad y_2, \quad \dots \quad y_n.$$

Then we have

$$y_1 - y = \Delta y, \quad y_2 - y_1 = \Delta y_1, \quad \dots \quad y_n - y_{n-1} = \Delta y_{n-1}, \\ \Delta y_1 - \Delta y = \Delta^2 y, \quad \Delta y_2 - \Delta y_1 = \Delta^2 y_1, \quad \Delta y_n - \Delta y_{n-1} = \Delta^2 y_{n-1}, \\ \Delta^2 y_1 - \Delta^2 y = \Delta^3 y, \quad \&c.$$

The final result consists in expressing  $y_n$  in terms of

$$y, \quad \Delta y, \quad \Delta^2 y, \quad \dots \quad \Delta^n y$$

We have

$$y_n = y_{n-1} + \Delta y_{n-1} = y_{n-2} + 2\Delta y_{n-2} + \Delta^2 y_{n-2}.$$

In like manner, substituting  $y_{n-3} + \Delta y_{n-3}$  for  $y_{n-2}$ , we get

$$y_n = y_{n-3} + 3\Delta y_{n-3} + 3\Delta^2 y_{n-3} + \Delta^3 y_{n-3},$$

the coefficients being the same as those in the expansion of  $(a+b)^n$ . Now, if we assume that the same law holds for any value  $n$ , it is readily seen by the method of mathematical induction, of which we have given an example in § 27, that it holds for the value immediately superior; and we thus get

$$y_n = y + n \Delta y + \frac{n(n-1)}{1.2} \Delta^2 y + \frac{n(n-1)(n-2)}{1.2.3} \Delta^3 y + \dots + \Delta^n y.$$

40. This result can be readily established also by the principles of the symbolic calculus, a branch of the subject to which a short space will be devoted subsequently. We shall anticipate the consideration of that method by giving an application of it to the determination of the preceding result.

Regarding  $\Delta$  as a symbol of operation, the equation  $y_n = y_{n-1} + \Delta y_{n-1}$  may be written  $y_n = (1 + \Delta)y_{n-1}$

In like manner,  $y_{n-1} = (1 + \Delta)y_{n-2}$

$$\therefore y_n = (1 + \Delta)(1 + \Delta)y_{n-2} = (1 + \Delta)^2 y_{n-2}$$

also

$$y_n = (1 + \Delta)^2 y_{n-3}; \text{ and in general} \\ y_n = (1 + \Delta)^n y \\ = \left( 1 + n\Delta + \frac{n(n-1)}{1.2} \Delta^2 + \dots + \Delta^n \right) y \\ = y + n\Delta y + \frac{n(n-1)}{1.2} \Delta^2 y + \dots + \Delta^n y.$$

41. If we suppose

$$n\Delta x = h, \text{ or } n = \frac{h}{\Delta x},$$

the equation becomes

$$f(x+h) = y + h \frac{\Delta y}{\Delta x} + \frac{h(h-\Delta x)}{1.2} \frac{\Delta^2 y}{\Delta x^2} + \&c$$

If now,  $h$  being regarded as constant, we suppose  $n$  to increase, and consequently  $\Delta x$  to diminish, indefinitely, we obtain, on proceeding to the limit,

$$f(x+h) = y + h \frac{dy}{dx} + \frac{h^2}{1.2} \frac{d^2y}{dx^2} + \&c \\ = f(x) + hf'(x) + \frac{h^2}{1.2} f''(x) + \frac{h^3}{1.2.3} f'''(x) + \&c.$$

This is called Taylor's series.

42. In order to complete the investigation, it will be necessary to examine into the convergency or divergency of the series, and to obtain an expression for the remainder in it after any number of terms; this we shall immediately proceed to consider.

43. It may be observed that Taylor does not seem to have been aware of the great importance of his theorem, nor did he give any examples of its application. This probably accounts for the fact that so long a time elapsed before its real value was discovered; and, although Stirling introduced a particular case of it in his *Methodus Differentialis* (1717), it was not noticed in any of the English treatises on the calculus—such as Simpson's *Fluxions* (1737), Emerson's *Fluxions* (1743), Landen's *Residual Analysis* (1764),—nor is it mentioned in the first edition of Montucla's *Hist. des Math.*, 1758. The theorem is to be found in Euler's *Cal. Dif.* (1755); but, although Euler makes extensive use of it, he made no reference to Taylor's name in connexion with the series, and would appear to have given the theorem as his own, or rather perhaps to have connected it with Bernoulli's series.

44. We may observe that Taylor also introduced into his *Methodus Incrementorum*, in the fluxional notation, a series which is the same as that of Bernoulli, already noticed. This led to a long and bitter controversy between them, in which Bernoulli's son Nicholas and others also took part. In this Taylor was accused of plagiarism both with respect to this theorem and to other theorems relative to the general theory of the centre of oscillation of bodies. It is remarkable that in this dispute no reference was made to Taylor's own theorem, nor do the disputants seem to have been aware of its vast superiority to that around which the angry controversy was raised.

45. Taylor's theorem seems never to have risen into due prominence until its great value was pointed out by the illustrious Lagrange, in the Berlin memoirs for 1772. Lagrange demonstrated the theorem by the principles of ordinary algebra. He made it the foundation of the method of series, and also of the differential calculus. He thus proposed to make the calculus a branch of ordinary algebra, and independent of all considerations of infinitely small quantities, and so to give it all the formal rigour of demonstration of the method of the ancients.

46. Lagrange also was the first to place Taylor's theorem on a satisfactory basis by finding an expression for the remainder of the series after any number of terms.

The following demonstration of this theorem of Lagrange depends on a single lemma, which may be thus stated. *If a continuous function f(x) vanish when x=a, and also when x=h, then its derived function f'(x), if also continuous, must also vanish for some value of x between a and b.*

This is easily proved; for if f'(x) does not vanish for some value of x between a and b, it must have always the same sign between these limits, and consequently f(x) must constantly increase or constantly diminish as x passes by small increments from the value a to the value b; but this is impossible, since f(x) vanishes for both limits. Now let R<sub>n</sub> represent the remainder after n terms in Taylor's expansion, then writing X for x+y in that series, we have

$$f(X) = f(x) + \frac{(X-x)}{1} f'(x) + \frac{(X-x)^2}{1.2} f''(x) + \dots + \frac{(X-x)^{n-1}}{[n-1]} f^{(n-1)}(x) + R_n \dots (a)$$

in which f(x), f'(x) . . . . . f<sup>(n-1)</sup>(x) are supposed finite and continuous for all values of the variable between X and x.

From the form of the terms included in R<sub>n</sub> it evidently may be written in the shape

$$R_n = \frac{(X-x)^n}{[n]} P,$$

where P is some function of X and x. Consequently we have

$$f(X) - \left\{ f(x) + \frac{(X-x)}{1} f'(x) + \dots + \frac{(X-x)^{n-1}}{[n-1]} f^{(n-1)}(x) + \frac{(X-x)^n}{[n]} P \right\} = 0 \dots (b)$$

Now, let z be substituted for x in every term in the preceding, with the exception of P, and let F(z) represent the resulting expression, we shall have

$$F(z) = f(X) - \left\{ f(z) + \frac{(X-z)}{1} f'(z) + \dots + \frac{(X-z)^{n-1}}{[n-1]} P \right\} \dots (\gamma)$$

in which P has the same value as before.

Again, the right-hand side in this equation vanishes when z=X, ∴ F(X)=0.

Also, from (b), the right-hand side vanishes when z=x; ∴ F(x)=0.

Accordingly, since the function F(z) vanishes when z=X, and also when z=x, it follows from the preceding lemma that its derived function F'(z) also vanishes for some value of z between the limits X and x.

Proceeding to obtain F'(z) by differentiation, it can be easily seen from equation (γ) that we have

$$F'(z) = - \frac{(X-z)^{n-1}}{[n-1]} f^{(n)}(z) + \frac{(X-z)^{n-1}}{[n-1]} P.$$

Consequently, for some value of z between x and X we must have f<sup>(n)</sup>(z)=P.

Again, if θ be a positive quantity less than unity, the expression x+θ(X-x), by assigning a suitable value to θ, can be made equal to any number intermediate between x and X.

Hence

$$P = f^{(n)}\{x + \theta(X-x)\},$$

where θ is some quantity >0 and <1.

Consequently, the remainder after n terms of Taylor's series can be represented by

$$= \frac{(X-x)^n}{[n]} f^{(n)}\{x + \theta(X-x)\}.$$

This is Lagrange's form for the remainder. Substituting this value for R<sub>n</sub> in (a), it becomes

$$f(X) = f(x) + \frac{(X-x)}{1} f'(x) + \frac{(X-x)^2}{1.2} f''(x) + \dots + \frac{(X-x)^{n-1}}{[n-1]} f^{(n-1)}(x) + \frac{(X-x)^n}{[n]} f^{(n)}\{x + \theta(X-x)\}.$$

Again, if h be substituted for X-x, the series becomes

$$f(x+h) = f(x) + hf'(x) + \&c. + \frac{h^{n-1}}{[n-1]} f^{(n-1)}(x) + \frac{h^n}{[n]} f^{(n)}(x + \theta h).$$

In this expression n may be any positive integer.

47. The last equation may be regarded as the most general form of Taylor's theorem. We infer from it that the essential conditions for the application of Taylor's theorem to the expansion of any function in a series are—that none of its derived functions should become infinite and that  $\frac{h^n}{[n]} f^{(n)}(x + \theta h)$  should become infinitely small when n becomes sufficiently large.

48. The remainder in Taylor's series admits, as was shown by Cauchy, of being written in the form

$$\frac{h^n(1-\theta)^{n-1}}{[n-1]} f^{(n)}(x + \theta h).$$

Another form was given by Dr Schlömilch, viz.

$$R_n = \frac{h^n(1-\theta)^{n+p-1}}{[n-1](p+1)} f^{(n)}(x + \theta h).$$

In some cases one or other of these latter values is preferable to Lagrange's form.

49. Another remarkable mode of determining the remainder in Taylor's theorem was also given by Cauchy. It is based on the following lemma, that if F(x) and f(x) be two functions which remain continuous, as also their derived functions, between the values x<sub>1</sub> and x<sub>1</sub>+h of x, and if also f'(x) does not become zero for any value of x between these limits, then

$$\frac{F(x_1+h) - F(x_1)}{f(x_1+h) - f(x_1)} = \frac{F'(x_1 + \theta h)}{f'(x_1 + \theta h)},$$

where θ is less than unity.

50. If in Taylor's series we make x+h=0, or h=-x, we get

$$f(0) = f(x) - xf'(x) + \frac{x^2}{1.2} f''(x) - \&c.;$$

and hence

$$f(x) = f(0) + xf'(x) - \frac{x^2}{1.2} f''(x) + \&c.,$$

a result which can be readily identified with Bernoulli's series, given in § 38.

51. Again, if x=0, Taylor's series becomes

$$f(h) = f(0) + hf'(0) + \frac{h^2}{1.2} f''(0) + \&c.;$$

or, as it may be written,

$$f(x) = f(0) + \frac{x}{1} f'(0) + \frac{x^2}{1.2} f''(0) + \&c.,$$

in which f(0), f'(0), f''(0), &c., represent the values of f(x), f'(x), f''(x), &c., when x=0.

This result is usually called Maclaurin's series, having been given in his *Fluxions* (1742). It had, however, been previously published by Stirling in his *Math. Diss.* (1717); but neither Stirling nor Maclaurin laid any claim to the theorem as being original, both referring it to Taylor.

By substituting for f(x) any of the elementary functions, such as sin x, cos x, log (1+x), we readily obtain their well-known expansions. It is to be noted that it is necessary in each case, for the validity of the series, to show that the remainder after n terms becomes indefinitely small when n is taken sufficiently large.

52. The application of Taylor's or of Maclaurin's theorem becomes extremely troublesome in many cases, owing to the complexity of the successive derived functions. For example, if we seek to expand tan x by Maclaurin's theorem, we have f(x)=tan x, f'(x)=sec<sup>2</sup>x, f''(x)=2 sec<sup>2</sup>x tan x, f'''(x)=2 sec<sup>4</sup>x + 4 sec<sup>2</sup>x tan<sup>2</sup>x; and the subsequent derived functions increase in complexity. Similarly in the case of other elementary functions, such as sec x cot x, &c.

53. The development of tan x, sec x, and many other functions is much facilitated by the aid of a system of numbers, introduced by James Bernoulli. These numbers are usually arrived at as follows. It is easily seen that the expansion of  $\frac{x}{e^x - 1}$ , in ascending powers of x, contains no odd power of x after the first, and that the two first terms of the expansion are 1 and  $-\frac{x}{2}$ . Accordingly

we may assume

$$\frac{x}{e^x - 1} = 1 - \frac{x}{2} + \frac{B_1}{1.2} x^2 - \frac{B_2}{1.2.3.4} x^4 + \frac{B_3}{6} x^6 - \dots$$



in which  $B_1, B_2, B_3, \dots$ , are constants. These constants are called Bernoulli's numbers, and it can be shown without much difficulty that

$$B_1 = \frac{1}{6}, B_2 = \frac{1}{30}, B_3 = \frac{1}{42}, B_4 = \frac{1}{30}, B_5 = \frac{1}{42}, B_6 = \frac{1}{42}, B_7 = \frac{1}{42}, \&c.$$

The complete investigation of the method of their determination is due to Euler. See his *Calc. Diff.*, lib. ii. cap. 5.

In order to develop  $\tan \theta$  by aid of them, we write it in the form

$$\tan \theta = \frac{1}{i} \left( 1 - \frac{2}{1 + i\theta} \right), \text{ where } i = \sqrt{-1}.$$

Hence we find

$$\tan \theta = 2^2(2^2-1) \frac{B_1 \theta}{2} + 2^4(2^4-1) \frac{B_3 \theta^3}{4} + 2^6(2^6-1) \frac{B_5 \theta^5}{6} \dots,$$

observing that

$$\frac{1}{c^2+1} = \frac{1}{c^2-1} - \frac{2}{c^2-1}.$$

In like manner we get

$$\cot \theta = \frac{1}{\theta} - \frac{2^2 B_1 \theta}{2} - \frac{2^4 B_3 \theta^3}{4} - \frac{2^6 B_5 \theta^5}{6} - \&c.$$

Also, since  $\operatorname{cosec} \theta = \cot \theta + \tan \frac{\theta}{2}$ , we get

$$\operatorname{cosec} \theta = \frac{1}{\theta} + \frac{2(2^1-1)B_1 \theta}{2} + \frac{2(2^3-1)B_3 \theta^3}{4} + \frac{2(2^5-1)B_5 \theta^5}{6} + \dots$$

For the completion of this investigation it would be necessary to consider the convergence or divergence of these series. This question would occupy too much space for treatment here.

54. The numbers  $B_1, B_2, \dots$  were arrived at by James Bernoulli (*Ars conjectandi*, 1713, p. 97) in studying the summation of series of powers of the natural numbers 1, 2, 3, . . .

Thus, if  $Sn^p$  represent the sum of the series

$$1^p + 2^p + 3^p \dots + (n-1)^p$$

Bernoulli proved that

$$Sn^p = \frac{n^{p+1}}{p+1} - \frac{n^p}{2} + \frac{p}{2} B_1 n^{p-1} - \frac{p(p-1)(p-2)}{4} B_2 n^{p-3} + \dots$$

The numbers,  $B_1, B_2, B_3 \dots$  were defined by Bernoulli as being the coefficients of the first power of  $n$  in the expressions for  $Sn^2, Sn^4, Sn^6, \dots$ , respectively.

This series of Bernoulli may be established as follows  
If each side of the identical equation

$$1 + e^x + e^{2x} + e^{3x} \dots + e^{(n-1)x} = \frac{e^{nx} - 1}{e^x - 1},$$

be differentiated  $p$  times with respect to  $x$ , and we make  $x=0$  in the result, we get

$$1^p + 2^p + 3^p \dots + (n-1)^p = D^p \left( \frac{e^{nx} - 1}{e^x - 1} \right), \text{ when } x=0,$$

where  $D$  stands for  $\frac{d}{dx}$ .

This may be written

$$Sn^p = D^p \left( \frac{e^{nx} - 1}{e^x - 1} \right)_{(0)}.$$

Again

$$\frac{e^{nx} - 1}{e^x - 1} = \frac{e^{nx} - 1}{x} \cdot \frac{x}{e^x - 1}.$$

If  $\phi(x) = \frac{e^{nx} - 1}{x}$ , and  $f(x) = \frac{x}{e^x - 1} = 1 - \frac{x}{2} + \frac{B_1}{1.2} x^2 - \&c.$ ,

we get by Leibnitz's theorem § 27,

$$Sn^p = f(0)\phi^{(p)}(0) + p f'(0)\phi^{(p-1)}(0) + \frac{p(p-1)}{1.2} f''(0)\phi^{(p-2)}(0) + \dots$$

Now it is easily seen that

$$\phi^{(k)}(0) = \frac{n^{k+1}}{k+1};$$

and hence Bernoulli's series follows immediately.

From the preceding we have

$$m \{ 1^{m-1} + 2^{m-1} + 3^{m-1} \dots + (z-1)^{m-1} \} \\ = z^m - \frac{m}{2} z^{m-1} + \frac{m(m-1)}{1.2} B_1 z^{m-2} - \dots$$

The function at the right hand side of this equation has been represented by  $\phi(z, m)$ , and called Bernoulli's function of the  $m$ th order, by Professor Raabe (*Crelle*, xlii.).

Raabe has arrived at many remarkable properties of these functions, of which a few of the most elementary are here added.

$$\phi(1-z, m) = (-1)^m \phi(z, m).$$

$$\phi\left(\frac{1}{2}, 2n\right) = (-1)^n \frac{2^{2n}-1}{2} B_n.$$

$$\frac{d}{dz} \phi(z, 2n) = 2n \phi(z, 2n-1), \text{ where } n > 1.$$

$$\frac{d}{dz} \phi(z, 2n+1) = (2n+1) \phi(z, 2n) + (-1)^{n-1} B_n.$$

$$\phi(z, 2n-1) = (-1)^n \frac{2^{2n-1}}{\pi^{2n-1}} \left\{ \frac{\sin 2n\pi z}{2^{2n-1}} + \frac{\sin 4n\pi z}{4^{2n-1}} + \frac{\sin 6n\pi z}{6^{2n-1}} + \dots \right\}$$

where  $z > 0$  and  $< 1$ , and  $n > 1$ .

For their demonstration the reader is referred to Raabe's memoir, as also to Schlämilch's *Compendium der Höheren Analysis*.

It may be noted that the first fifteen of Bernoulli's numbers were given by Euler in his *Inst. Calc. Dif.* P. 2, ch. 5. The next sixteen were calculated by Professor Rothe of Erlangen, and published by Ohm in *Crelle*, vol. xxii.; and thirty-one additional numbers have been recently calculated by Professor Adams, and published in the *Proceedings of the British Association* for 1877.

The fractional part in each of these numbers was calculated by Professor Adams, by aid of Von Staudt's theorem (*Crelle*, xxi.). This remarkable theorem is as follows. If 1, 2,  $a, a' \dots 2n$ , be all divisors of  $2n$ , and if unity be added to each, so as to form the series 2, 3,  $a+1, \dots 2n+1$ , and of these the prima numbers 2, 3,  $p, p' \dots$  be selected, the fractional part of  $B_n$  will be

$$(-1)^n \left\{ \frac{1}{2} + \frac{1}{3} + \frac{1}{p} + \frac{1}{p'} \dots \right\}.$$

55. Several methods have been given for facilitating expansions by series, of which one of the most general and remarkable is that given by Arbogast in his *Calcul des Dérivations* (1800).

This is a method for expanding a function of

$$a + b \frac{x}{1} + c \frac{x^2}{1.2} + d \frac{x^3}{1.2.3} + \&c.$$

in a series of ascending powers of  $x$ .

Let

$$u = a + b \frac{x}{1} + c \frac{x^2}{1.2} + d \frac{x^3}{1.2.3} + \&c.$$

and suppose  $\phi(u)$  represents the required function.

Also, let

$$\begin{aligned} \phi(u) &= f(x) = A + B \frac{x}{1} + C \frac{x^2}{1.2} + D \frac{x^3}{1.2.3} + \&c \\ &= f(0) + \frac{x}{1} f'(0) + \frac{x^2}{1.2} f''(0) + \&c.; \end{aligned}$$

then we have  $A = f(0) = \phi(a)$ .

Also, writing  $u', u'', u'''$ , &c. instead of

$$\frac{du}{dx}, \frac{d^2u}{dx^2}, \frac{d^3u}{dx^3}, \&c.,$$

we obtain, by successive differentiation of the equation  $f(x) = \phi(u)$ ,

$$\begin{aligned} f'(x) &= \phi'(u) \cdot u', \\ f''(x) &= \phi''(u) \cdot u'' + \phi'''(u) \cdot (u')^2, \\ f'''(x) &= \phi'''(u) \cdot u''' + 3\phi^{(4)}(u) \cdot u' \cdot u'' + \phi^{(4)}(u) (u')^3, \\ f^{(4)}(x) &= \phi^{(4)}(u) \cdot u^{(4)} + \phi^{(5)}(u) [4u' u''' + 3(u'')^2] + 6\phi^{(5)}(u) \cdot (u')^2 \cdot u'' \\ &\quad + \phi^{(5)}(u) \cdot (u')^4. \end{aligned}$$

Now,  $u, u', u'', u''', \dots$  obviously become  $a, b, c, d, \dots$  respectively, when  $x=0$ .

Accordingly

$$\begin{aligned} B &= f'(0) = b\phi'(a), \quad C = f''(0) = c\phi''(a) + b^2\phi'''(a), \\ D &= f'''(0) = d\phi'''(a) + 3bc\phi^{(4)}(a) + b^3\phi^{(4)}(a), \&c. \end{aligned}$$

From the mode of formation of these terms, they are seen to be each deduced from the preceding by an analogous law to that by which derived functions are deduced one from the other; and, as  $f'(x), f''(x), \dots$  are deduced from  $f(x)$  by successive differentiation, so in like manner  $B, C, D, \dots$  are deduced from  $\phi(u)$  by successive derivation; where, after differentiation,  $a, b, c, \dots$  are substituted for

$$u, \frac{du}{dx}, \frac{d^2u}{dx^2}, \dots \&c.$$

If this process of derivation be denoted by the letter  $\delta$ , then

$$B = \delta.A, \quad C = \delta.B, \quad D = \delta.C, \&c.$$

From the preceding, we see that in forming the term  $\delta \cdot \phi(a)$  we take the derived function  $\phi'(a)$ , and multiply it by the next letter  $\delta$ , and similarly in other cases.

$$\text{Thus } \delta.b = c, \quad \delta.c = d, \dots$$

$$\delta.b^m = mb^{m-1}c, \quad \delta.c^m = mc^{m-1}d, \dots$$

Also  $\delta \cdot \phi'(a)b = \phi'(a)c + \phi''(a)b^2$ .

This gives the same value for  $C$  as that found before;  $D$  is derived from  $C$  in accordance with the same law: and so on. As an

illustration of this method, we shall apply it to find a few terms in the expansion of

$$\sin \left( a + b \frac{x}{1} + c \frac{x^2}{1 \cdot 2} + d \frac{x^3}{1 \cdot 2 \cdot 3} + \&c. \right).$$

Here  $A = \sin a$ ,  $B = \delta$ ,  $\sin a = b \cos a$ ,  
 $C = \delta \cdot b \cos a = c \cos a - b^2 \sin a$ ,  
 $D = \delta \cdot C = d \cos a - 3bc \sin a - b^3 \cos a$ ,  
 $E = \delta \cdot D = e \cos a - (4bd + 3c^2) \sin a - 6b^2c \cos a + b^4 \sin a$ .

Arbogast's theorem has been treated somewhat differently by Professor De Morgan. Thus, suppose  $\phi(a_0 + a_1x + a_2x^2 + \dots + a_nx^n + \&c.) = A_0 + A_1x + A_2x^2 + \dots + A_nx^n + \&c.$ ; then, if we differentiate with respect to  $a_n$ , we have

$$\phi'(a_0 + a_1x + \dots + a_nx^n + \&c.)x^n = \frac{dA_0}{da_n} + \frac{dA_1}{da_n}x + \dots + \frac{dA_n}{da_n}x^n + \&c.$$

Hence we infer that, if  $m$  be less than  $n$ , we have  $\frac{dA_m}{da_n} = 0$ ,

also 
$$\frac{dA_m}{da_m} = \frac{dA_{m-1}}{da_{m-1}} = \dots = \frac{dA_0}{da_0} = \phi'(a_0),$$

and 
$$\frac{dA_{m+n}}{da_m} = \frac{da_n}{da_0}, \&c.$$

The values of  $A_1, A_2, \dots, A_n$  can be hence calculated (see De Morgan's *Differential and Integral Calculus*, arts. 214-220).  
 56. Lagrange, in addition to having been the first to place Taylor's series on a satisfactory basis, also enlarged the powers of analysis by a remarkable theorem which contains Taylor's as a particular case. This, which is commonly called Lagrange's Formula, first appeared in 1768 in the Berlin memoirs, and may be stated as follows:—

If  $z$  be connected with  $x$  and  $y$  by the equation  $z = x + y\phi(z)$ ,

then the expansion, in ascending powers of  $y$ , of any function  $F(z)$  may be thus written:—

$$F(z) = F(x) + \frac{y}{1} \phi(x)F'(x) + \frac{y^2}{1 \cdot 2} \frac{d}{dx} \left\{ [\phi(x)]^2 F'(x) \right\} + \dots + \frac{y^n}{n} \left( \frac{d}{dx} \right)^{n-1} \left\{ [\phi(x)]^n F'(x) \right\} + \dots$$

This result can be deduced from Maclaurin's theorem, as was shown by Laplace, thus:—

Let  $u = F(z)$ , and we may write

$$u = u_0 + y \left( \frac{du}{dy} \right)_0 + \frac{y^2}{1 \cdot 2} \left( \frac{d^2u}{dy^2} \right)_0 + \dots + \frac{y^n}{n} \left( \frac{d^nu}{dy^n} \right)_0 + \dots$$

where  $\left( \frac{du}{dy} \right)_0, \left( \frac{d^2u}{dy^2} \right)_0, \dots$  represent the values of  $\frac{du}{dy}, \frac{d^2u}{dy^2}, \dots$  when we make  $y=0$  after differentiation.

We plainly have  $u_0 = F(x)$ .

Also, it is easily seen by differentiation that

$$\frac{dz}{dy} = Z \frac{dz}{dx}, \frac{du}{dy} = Z \frac{du}{dx},$$

writing  $Z$  for  $\phi(z)$ .

Again 
$$\frac{d}{dy} \left( \frac{du}{dy} \right) = \frac{d}{dy} \left( Z \frac{du}{dx} \right) = \frac{d}{dx} \left( Z \frac{du}{dy} \right) = \frac{d}{dx} \left( Z^2 \frac{du}{dx} \right).$$

Hence we can deduce in like manner

$$\frac{d^2u}{dy^2} = \left( \frac{d}{dx} \right)^2 \left( Z^2 \frac{du}{dx} \right);$$

and in general

$$\frac{d^nu}{dy^n} = \left( \frac{d}{dx} \right)^{n-1} \left( Z^n \frac{du}{dx} \right).$$

If now we suppose  $y=0$ , since  $Z$  reduces to  $\phi(x)$ , and  $\frac{du}{dx}$  to  $F'(x)$ , we get

$$\left( \frac{du}{dy} \right)_0 = \phi(x)F'(x), \left( \frac{d^2u}{dy^2} \right)_0 = \frac{d}{dx} \left\{ [\phi(x)]^2 F'(x) \right\}, \dots$$

from which the series immediately follows.

For example, let  $z = x + \frac{y}{2} (z^2 - 1)$ ;

then the expansion of  $z$  becomes

$$z = x + \frac{y}{2} (x^2 - 1) + \frac{1}{1 \cdot 2} \left( \frac{y}{2} \right)^2 \frac{d}{dx} (x^2 - 1)^2 + \dots + \frac{1}{n} \left( \frac{y}{2} \right)^n \left( \frac{d}{dx} \right)^{n-1} (x^2 - 1)^n + \dots$$

Again, from our equation we get

$$z = \frac{1}{y} \sqrt{1 - 2xy + y^2}.$$

Hence

$$\frac{dz}{dx} = (1 - 2xy + y^2)^{-\frac{1}{2}}.$$

Consequently we have

$$(1 - 2xy + y^2)^{-\frac{1}{2}} = 1 + \frac{y}{2} \frac{d}{dx} (x^2 - 1) + \dots + \frac{1}{n} \left( \frac{y}{2} \right)^n \left( \frac{d}{dx} \right)^n (x^2 - 1)^n + \dots$$

If we write this expansion in the form

$$(1 - 2xy + y^2)^{-\frac{1}{2}} = 1 + X_1y + X_2y^2 + \dots + X_ny^n + \dots$$

we have<sup>1</sup>

$$X_n = \frac{1}{n} \frac{1}{2^n} \left( \frac{d}{dx} \right)^n (x^2 - 1)^n.$$

The class of functions represented by  $X_n$  was extensively studied by Legendre, to whose works the reader is referred for further development.

An expression for the remainder in Lagrange's series in the form of a definite integral will be given further on.

57. Taylor's series admits of ready extension to two or more variables; thus, if we change  $x$  into  $x+h$  in the equation  $u = \phi(x, y)$ , we get, by Taylor's theorem,

$$\phi(x+h, y) = u + h \frac{du}{dx} + \frac{h^2}{1 \cdot 2} \frac{d^2u}{dx^2} + \frac{h^3}{1 \cdot 2 \cdot 3} \frac{d^3u}{dx^3} + \&c$$

If now we change  $y$  into  $y+k$ ,

$$u \text{ or } \phi(x, y) \text{ becomes } u + k \frac{du}{dy} + \frac{k^2}{1 \cdot 2} \frac{d^2u}{dy^2} + \&c.;$$

$$h \frac{du}{dx} \text{ becomes } h \frac{du}{dx} + hk \frac{d^2u}{dx dy} + h \frac{h^2}{1 \cdot 2} \frac{d^3u}{dx^2 dy} + \&c.;$$

and accordingly we have

$$\phi(x+h, y+k) = u + h \frac{du}{dx} + k \frac{du}{dy} + \frac{h^2}{1 \cdot 2} \frac{d^2u}{dx^2} + hk \frac{d^2u}{dx dy} + \frac{k^2}{1 \cdot 2} \frac{d^2u}{dy^2} + \&c.$$

By aid of Lagrange's theorem in § 46 we can obtain an expression for the remainder of the series.

In like manner, if  $u = \phi(x, y, z)$ , we get

$$\phi(x+h, y+k, z+l) = u + h \frac{du}{dx} + k \frac{du}{dy} + l \frac{du}{dz} + \frac{h^2}{1 \cdot 2} \frac{d^2u}{dx^2} + \frac{k^2}{1 \cdot 2} \frac{d^2u}{dy^2} + \frac{l^2}{1 \cdot 2} \frac{d^2u}{dz^2} + hk \frac{d^2u}{dy dx} + kl \frac{d^2u}{dy dz} + lh \frac{d^2u}{dz dx} + \&c.$$

The method can be readily extended to a function of any number of variables.

1. As an example of Maclaurin's theorem, the first three terms in the expansion of  $\tan x$  are  $x + \frac{x^3}{3} + \frac{2x^5}{15}$ .

(2) Prove that

$$\tan^{-1}(x+h) = \tan^{-1}x + h \sin z \frac{\sin z}{1} - \frac{h^2 \sin z^3 \sin 2z}{2} + (h \sin z)^3 \frac{\sin 3z}{3} - \dots + \&c.$$

where  $z = \cot^{-1}x$ .

(3) If  $x \frac{d^2y}{dx^2} + \frac{dy}{dx} + y = 0$ ,  $y$  may be easily expanded in terms of  $x$  by the method of indeterminate coefficients.

(4) By similar methods the first four terms in the expansion of  $(1+x)^{\frac{1}{2}}$  in ascending powers of  $x$  are found to be

$$\left( 1 - \frac{x}{2} + \frac{11x^2}{24} - \frac{7x^3}{16} \right) e.$$

(5) Find the development of  $\frac{x \sin 3x}{\sin x \sin 2x}$  in ascending powers of  $x$ , the coefficients being expressed in Bernoulli's numbers.

(6) Prove that Legendre's function  $X_n$  satisfies the differential equation

$$(1-x^2) \frac{d^2X_n}{dx^2} - 2x \frac{dX_n}{dx} + n(n+1)X_n = 0;$$

also that

$$\frac{dX_{n+1}}{dx} = (2n+1)X_n + (2n-3)X_{n-2} + (2n-7)X_{n-4} + \dots$$

*Indeterminate Forms.*

58. Another important application of the infinitesimal method is to the determination of the true or limiting values of indeterminate expressions.

For example, if the fraction  $\frac{f(x)}{\phi(x)}$  becomes of the form  $\frac{0}{0}$ , or  $\frac{\infty}{\infty}$ , when  $x=a$ , the fraction is said to become indeterminate for that value of  $x$ .

In fact, the method of the evaluation of indeterminate forms may be regarded as the foundation of the differential calculus, since the determination of the derived function of any expression  $f(x)$  reduces to finding the limiting value of  $\frac{f(x+h) - f(x)}{h}$  when  $h=0$ .

<sup>1</sup> This remarkable expression for  $X_n$  is due to Jacobi (*Crelle*, II. p. 223).

We shall first consider the case where  $f(a)=0$ , and  $\phi(a)=0$ . Here the true value of  $\frac{f(x)}{\phi(x)}$  is that of  $\frac{f'(a+h)}{\phi'(a+h)}$  when  $h$  is evanescent.

But 
$$\frac{f(a+h)}{\phi(a+h)} = \frac{f'(a) + hf''(a+\theta h)}{\phi'(a) + h\phi''(a+\theta h)} = \frac{f'(a+\theta h)}{\phi'(a+\theta h)}$$

$$= \frac{f'(a)}{\phi'(a)} \text{ when } h=0.$$

Hence the limiting value of the fraction is in this case represented by  $\frac{f'(a)}{\phi'(a)}$ .

Again, if  $\frac{f'(a)}{\phi'(a)}$  be also of the form  $\frac{0}{0}$ , its true value is that of  $\frac{f''(a)}{\phi''(a)}$ ; and so on.

In general, if the order of the lowest derived functions which do not both vanish is  $n$ , then the true value of  $\frac{f(x)}{\phi(x)}$  is that of  $\frac{f^{(n)}(a)}{\phi^{(n)}(a)}$ .

For example, the fraction  $\frac{x^a \sin ay - y^a \sin ax}{\tan ay - \tan ax}$  is of the form  $\frac{0}{0}$  when  $x=y$ , to find its true value.

Here  $f(x) = x^a \sin ay - y^a \sin ax$ ,  $\phi(x) = \tan ay - \tan ax$ ,  
 $\therefore f'(x) = ax^{a-1} \sin ay - ay^a \cos ax$ ,  $\phi'(x) = -a \sec^2 ax$ ,  
 accordingly the required value is represented by

$$\frac{f'(y)}{\phi'(y)} = y^{a-1} (y \cos ay - \sin ay) \cos^2 ay.$$

59. Again, to find the true value of  $\frac{f(x)}{\phi(x)}$ , if  $f(a)=\infty$ ,  $\phi(a)=\infty$ .

Here  $\frac{f(x)}{\phi(x)} = \frac{\phi'(x)}{1}$ , which is of the form  $\frac{0}{0}$ , when  $x=a$ .

Hence, by the former case, its limiting value is that of

$$\frac{\phi'(x)}{f'(x)} \left\{ \frac{f(x)}{\phi(x)} \right\}^2.$$

Suppose  $A$  to represent the limiting value in question and we have

$$A = \frac{\phi'(a)}{f'(a)} A^2, \text{ or } A = \frac{f'(a)}{\phi'(a)}.$$

Accordingly the true value of the indeterminate form  $\frac{\infty}{\infty}$  is found in the same manner as that of the form  $\frac{0}{0}$ .

In the preceding, in dividing both sides of our equation by  $A$ , we have assumed that  $A$  is neither zero nor infinite. It can, however, be easily shown that the true value in either of these cases is still that of  $\frac{f'(a)}{\phi'(a)}$ .

60. Again, the expression  $f(x) \times \phi(x)$  becomes indeterminate for any value of  $x$  which makes one of its factors zero and the other infinite. The expression, however, is readily reduced to the form  $\frac{0}{0}$ ; for, if  $f(a)=0$ , and  $\phi(a)=\infty$ , we have

$$f(x) \times \phi(x) = f(x) \div \frac{1}{\phi(x)}, \text{ which is of the form } \frac{0}{0}.$$

Also, if the true value of  $\frac{f(x)}{\phi(x)}$  be unity when  $\phi(a)=\infty$ , then

$$f(a) - \phi(a) = \left\{ \frac{f(a)}{\phi(a)} - 1 \right\} \phi(a) = \left\{ \frac{f(a)}{\phi(a)} - 1 \right\} \div \frac{1}{\phi(a)}.$$

This is of the form  $\frac{0}{0}$ , and its true value can in general be found as above. By this means the true value of  $f(x) - \phi(x)$  when  $f(x)=\infty$ , and  $\phi(x)=\infty$  can be found.

61. The expression  $u^v$  becomes indeterminate in some cases; for suppose  $y=u^v$ , then  $\log y = v \log u$ . This latter product becomes indeterminate whenever one of its factors is zero and the other infinite.

(1) Let  $v=0$ , and  $\log u = \pm \infty$ ; the latter equation requires either  $u = \infty$ , or  $u=0$ . Consequently  $u^v$  becomes indeterminate for either of the forms  $0^0$  or  $\infty^0$ .

(2) Let  $v = \pm \infty$ ,  $\log u = 0$ ; the latter equation gives  $u=1$ , and the corresponding indeterminate forms are  $1^\infty$  or  $1^{-\infty}$ .

62. In many cases the true value of an indeterminate form can be best determined by ordinary algebra or trigonometry. Thus, for example, the expression

$$\frac{\sqrt{a^2+ax+x^2} - \sqrt{a^2-ax-x^2}}{\sqrt{a+x} - \sqrt{a-x}}$$

is of the form  $\frac{0}{0}$  when  $x=0$ . To find its true value we multiply

by the complementary surds, when the expression becomes

$$\frac{\sqrt{a+x} + \sqrt{a-x}}{\sqrt{a^2+ax+x^2} + \sqrt{a^2-ax-x^2}} \times \frac{ax+x^2}{x},$$

the true value of which is plainly  $\sqrt{a}$ , when  $x=0$ .

63. The differential calculus was applied for the first time to finding the true value of an indeterminate form by Jehu Bernoulli, in the *Acta Eruditorum*, 1704, when studying the problem of drawing the tangents at a multiple point on a curve. This problem, as stated already in the Introduction, was started by Rolle, as a crux for the advocates of the differential calculus. It may be here remarked that the determination of the tangents at a multiple point is generally much simpler by Cartesian coordinate geometry than by the method of the differential calculus.

A few elementary examples are added of the different classes of indeterminate forms here given.

(1)  $u = \left\{ \frac{e^{mx} - e^{nx}}{(x-a)^r} \right\}$ , when  $x=a$ .

Here  $f(x) = e^{mx} - e^{nx}$ ,  $\phi(x) = (x-a)^r$ ,

$\therefore f'(x) = me^{mx}$ ,  $\phi'(x) = r(x-a)^{r-1}$ .

Accordingly, when  $r > 1$ ,  $u = \infty$ ; when  $r=1$ ,  $u = me^{ma}$ ; when  $r < 1$ ,  $u = 0$

(2)  $u = \frac{\cos x \theta - \cos n \theta}{(n^2 - x^2)^r}$ , when  $x=n$ .

For  $r > 1$ ,  $u = \infty$ ; for  $r=1$ ,  $u = -\frac{\theta \sin n \theta}{2}$ ; and for  $r < 1$ ,  $u = 0$ .

(3)  $u = \frac{x^2 + 2 \cos x - 2}{\tan^2 x}$ , when  $x=0$ .

Since  $\frac{x}{\tan x} = 1$  when  $x=0$ , the true value of  $u$ , in this case, is the same as that of  $\frac{x^2 + 2 \cos x - 2}{x^4}$ , and is easily seen to be 1

(4)  $u = \frac{x^n}{e^x}$ , when  $x = \infty$ .

Here  $u = \left( \frac{x}{e} \right)^{\frac{x}{e}}$ ; but the true value of  $\frac{x}{e}$ , when  $x = \infty$ , is easily

seen to be zero, consequently the true value of  $u$  is also zero.

(5)  $u = \left( 1 + \frac{a}{x} \right)^x$ , (1) when  $x=0$ , and (2) when  $x = \infty$ .

The true values are (1)  $u=1$ ; (2)  $u=e^a$ .

(6)  $\sqrt{x^2+ax} - \sqrt{x^2+bx}$ , when  $x = \infty$ .

This is of the form  $\infty - \infty$ ; its true value, however, is that of

$$\frac{(a-b)x}{\sqrt{x^2+ax} + \sqrt{x^2+bx}} = \frac{a-b}{\sqrt{1 + \frac{a}{x}} + \sqrt{1 + \frac{b}{x}}} \times \frac{a-b}{2}.$$

(7)  $u = \frac{(x \sin^2 \theta + y \cos^2 \theta)^n - x^n}{x^n - y^n}$ , when  $x=y$ . True value,  $\sin^2 \theta$ .

(8)  $\frac{x \sin(\sin x) - \sin^2 x}{\sin^6 x}$ , when  $x=0$ . True value,  $\frac{1}{18}$ .

(9)  $x(1 - \frac{1}{x^2})$ , when  $x = \infty$ .

This is equivalent to  $\frac{1-a^2}{2}$  when  $x=0$ , and accordingly its true value is  $-\log a$ .

(10)  $\frac{\sqrt{x} - \sqrt{\sin x}}{\sqrt{x^3}}$ , when  $x=0$ . True value,  $\frac{1}{12}$ .

*Maxima and Minima.*

64. We have seen in the Introduction that the question of finding the greatest and least values of an expression was, in the hands of Fermat, one of the first applications of the method of infinitesimals. We have also seen that the principle of his method had been previously stated correctly by Kepler, and is the same as that obtained by the differential calculus. We now proceed to a more general investigation on maxima and minima.

Let  $u$  represent the function, and  $x$  the variable, and suppose we have  $u=f(x)$ .

Let  $a$  be a value of  $x$  corresponding to a maximum or a minimum value of  $u$ , then for a maximum we must have

$$f(a) > f(a+h), \text{ and } f(a) > f(a-h),$$

for small values of  $h$ ; and for a minimum,

$$f(a) < f(a+h), \text{ and } f(a) < f(a-h).$$

Accordingly, in either case,  $f(a+h) - f(a)$  and  $f(a-h) - f(a)$  must have the same sign,  $h$  being small.



But we have already seen that

$$f(a+h) - f(a) = hf'(a) + \frac{h^2}{1 \cdot 2} f''(a + \theta h),$$

$$f(a-h) - f(a) = -hf'(a) + \frac{h^2}{1 \cdot 2} f''(a - \theta h),$$

where  $\theta$  is  $>0$  and  $<1$ .

Now, when  $f''(a)$  is finite, it is plain that  $f(a+h) - f(a)$  and  $f(a-h) - f(a)$  cannot have both the same sign, when  $h$  is very small, unless  $f'(a) = 0$ .

Accordingly, the roots of the equation  $f'(x) = 0$  furnish in general the values of  $x$  for which  $f(x)$  has a maximum or a minimum value.

Also we have in this case—

$$f(a+h) - f(a) = \frac{h^2}{1 \cdot 2} f''(a + \theta h),$$

$$f(a-h) - f(a) = \frac{h^2}{1 \cdot 2} f''(a - \theta h).$$

Consequently, when  $f''(a)$  is negative, the corresponding value of  $f(a)$  is a maximum; and when  $f''(a)$  is positive,  $f(a)$  is a minimum.

If, however,  $f''(a)$  vanishes, along with  $f'(a)$ , it is readily seen that the corresponding value of  $a$  is neither a maximum nor a minimum unless  $f'''(a)$  also vanishes.

In general, let  $f^{(n)}(a)$  be the first derived function that does not vanish; then, if  $n$  be odd, the corresponding value of  $x$  is neither a maximum nor a minimum; but if  $n$  be even, the corresponding value is a maximum when  $f^{(n)}(a)$  is negative and a minimum when it is positive.

These rules for distinguishing between maxima and minima were first given correctly by Maclaurin, in his *Fluxions*, ch. ix.

If the equation  $f'(x) = 0$  has no real solution, then  $f(x)$  has no maximum or minimum value, and consequently is capable of having all possible values from  $-\infty$  to  $+\infty$ .

We shall illustrate the preceding theory by applying it to a few simple cases.

(1) 
$$u = x^2 + 1 \text{ or } 1 - b.$$
 Here 
$$\frac{du}{dx} = 2x + a = 0, \therefore x = -\frac{a}{2}.$$

Again  $\frac{d^2u}{dx^2} = 2$ . Since this is a positive quantity, the function is a minimum when  $x = -\frac{a}{2}$ . Its minimum value is  $b - \frac{a^2}{4}$ ; as is also evident because  $u = \left(x + \frac{a}{2}\right)^2 + b - \frac{a^2}{4}$ .

(2) 
$$u = \frac{ax^2 + 2bx + c}{a^2x^2 + 2bx + c}.$$
 Here 
$$ax^2 + 2bx + c = a(a^2x^2 + 2bx + c).$$

Differentiate both sides, and, since  $\frac{du}{dx} = 0$  for a maximum or a minimum, we have

$$ax + b - (a^2x + b)u.$$

Hence the roots of the quadratic

$$(ab' - ba')x^2 + (a^2c' - ca')x + bc' - cb' = 0$$

give the required solutions.

The corresponding values of  $u$  are given by the quadratic

$$u^2(b^2 - a^2c^2) + u(a^2c' + ca' - 2bb') + b^2 - ac = 0.$$

If the roots of the quadratic in  $x$  be imaginary, the proposed fraction has no maximum or minimum value. When the roots are real, the fraction has one maximum and one minimum value. These can be easily distinguished in any particular case. It is easily seen that to the greater root corresponds a minimum, and to the lesser a maximum value of the fraction, in general.

(3) 
$$u = \tan x^2 - x.$$
 Here 
$$\frac{du}{dx} = 2x \sec^2 x - 1, \quad \frac{d^2u}{dx^2} = 2 \sec^2 x \tan x,$$

$$\frac{d^3u}{dx^3} = 2 \sec^4 x - 4 \sec^2 x \tan^2 x.$$

Hence, for a maximum or a minimum we have  $\sec^2 x = 1$ ,  $\tan x = 0$ ; consequently  $\frac{d^2u}{dx^2} = 0$ , and  $\frac{d^3u}{dx^3} = 0$ .

Accordingly the proposed has neither a maximum nor a minimum value.

(4) 
$$u = \frac{x}{1+x^2}.$$

The fraction  $\frac{x}{1+x^2}$  is a maximum or a minimum according as  $\frac{1+x^2}{1+x^2}$  is a minimum or a maximum, as is evident from the principle

that, when  $u$  is a maximum,  $\frac{1}{u}$  is a minimum. But  $x + \frac{1}{x}$  is a maximum or a minimum when  $\frac{1}{x} = 1$ , or  $x = \pm 1$ .

Again, it is easily seen that the upper sign corresponds to a minimum and the lower to a maximum. We accordingly conclude that  $\frac{1}{2}$  is the maximum value of  $\frac{x}{1+x^2}$ , and  $-\frac{1}{2}$  its minimum value.

(5) The expression  $u = x^2$  has its critical value when  $x = \frac{1}{e}$ .

65. Again, to find the maximum or minimum values of  $u$ , if  $u = f(z)$ , where  $z = \phi(x)$ .

Here 
$$\frac{du}{dx} = f'(z)\phi'(x),$$

and consequently the solutions of the problem are—(1) those given by  $\phi'(x) = 0$ , i.e., the maximum and minimum of  $z$ ; (2) those given by  $f'(z) = 0$ .

In many cases the values of  $z$  are restricted by the conditions of the problem to lie between given limits; and accordingly in such cases no root of  $f'(z) = 0$  can furnish a real solution unless it lies between the given limiting values. This result will be illustrated in the following examples.

1. To find the maximum and minimum perpendicular to the focus the tangent to an ellipse, the perpendicular  $p$  being expressed in terms of the radius vector  $r$ .

The expression for the perpendicular  $p$ , in terms of the radius vector, is

$$p^2 = \frac{b^2 r}{2a - r};$$

$$p \frac{dp}{dr} = \frac{ab^2}{(2a - r)^2}.$$

Accordingly  $\frac{dp}{dr} = 0$  gives  $r = \pm a$ ; but these values are inadmissible, since  $r$  is restricted to lie between the values  $a(1 + e)$  and  $a(1 - e)$ .

Consequently the only maximum and minimum values of  $p$  are those which correspond to the maximum and minimum values of  $r$ ; i.e.,  $a(1 + e)$  and  $a(1 - e)$ .

2. To find in an ellipse the conjugate diameters whose sum is a maximum or a minimum.

If  $r$  and  $r'$  be two conjugate diameters, we have  $r^2 + r'^2 = a^2 + b^2$

$$\therefore u = r + \sqrt{a^2 + b^2 - r^2}.$$

The solutions accordingly are given,—(1) by the maximum and minimum values of  $r$ , and (2) by the equation

$$1 - \frac{r}{\sqrt{a^2 + b^2 - r^2}} = 0.$$

The latter gives the equiconjugate diameters, the former the axes of the ellipse. It is easily seen that the former solution gives a maximum, the latter a minimum; as is also readily shown otherwise.

3. To find the position of a planet when brightest, its orbit and that of the earth being supposed circular, and to lie in the same plane.

Let S, E, P (fig. 4) be the positions of the centres of the sun, earth, and planet respectively. Let ACBD represent the section

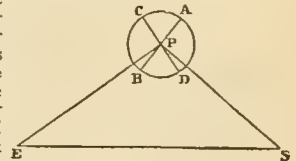

Fig. 4.

of the planet made by the plane SEP. Draw AB perpendicular to SP, and CD perpendicular to PE. Then ADB represents the illuminated half of the planet, and CBD the half visible from the earth. Accordingly the portion of the illuminated surface turned towards the earth is contained between two planes drawn respectively through AB and CD perpendicular to SPE. This surface is projected into a crescent, the breadth of which is proportional to the versine of BPD, or to  $1 + \cos EPS$ .

Again, the brightness, depending on its distance from the earth and its position respecting the sun conjointly, will vary as

$$\frac{1 + \cos EPS}{PE^2}$$

Let  $u = ES$ ,  $b = PS$ ,  $x = PE$ ; then

$$\cos EPS = \frac{x^2 + b^2 - u^2}{2bx}, \therefore \frac{1 + \cos EPS}{PE^2} = \frac{x^2 + 2bx + b^2 - u^2}{2bx^3}.$$

Hence, neglecting a constant multiplier, we have

$$u = \frac{1}{x} + \frac{2b}{x^2} - \frac{a^2 - b^2}{x^3}.$$

Accordingly, the solutions of the problem correspond to—

(1) The maximum and minimum values of  $x$ , i.e.,  $a + b$  and  $a - b$ ;

(2) The roots of the equation  $\frac{du}{dx} = 0$ , or of

$$x^2 + 4bx - 3(a^2 - b^2) = 0;$$



(X, Y) those of any point on the line passing through these points, then the equation of the line is

$$Y - y = (X - x) \frac{y_1 - y}{x_1 - x}.$$

If now the point Q be supposed to approach P, and ultimately to coincide with it, the line becomes the tangent PT at the point P, and its equation becomes

$$Y - y = (X - x) \frac{dy}{dx}.$$

For example, in the curve represented by

$$x^m = ay^n,$$

$$\frac{dy}{dx} = \frac{my}{nx};$$

we have

and the equation of the tangent at the point  $x, y$  is

$$m \frac{X}{x} - n \frac{Y}{y} = m - n.$$

This furnishes a simple construction for the tangent at any point on a parabolic curve. (Compare Ricci's construction given in the Introduction, p. 7.)

If the equation of the curve be given in the form  $u = f(x, y, z) = 0$ , we have

$$\frac{du}{dx} + \frac{du}{dy} \frac{dy}{dx} = 0,$$

and the equation of the tangent is

$$(X - x) \frac{du}{dx} + (Y - y) \frac{du}{dy} = 0.$$

70. Again, the normal at the point  $(x, y)$ , being perpendicular to the tangent, has for its equation

$$\frac{du}{dy} (X - x) = \frac{du}{dx} (Y - y),$$

the curve being referred to rectangular axes of coordinates.

71. The line TM in fig. 6 is usually called the subtangent and RM the subnormal. It is easily seen that

$$MR = \frac{y dy}{dx}, \quad TM = \frac{y}{dx} = y \frac{dx}{dy},$$

as it may otherwise be written.

Again, if the angle  $\Gamma TM = \phi$ ,

we have  $\tan \phi = \frac{dy}{dx}$ ; and

the length of the normal

$$PR = y \sec \phi = y \left( 1 + \frac{dy^2}{dx^2} \right)^{\frac{1}{2}};$$

also that of the tangent

$$PT = y \operatorname{cosec} \phi = y \left( 1 + \frac{dx^2}{dy^2} \right)^{\frac{1}{2}}.$$

72. In general, if the equation of a curve be given in terms of any two variable coordinates, the position of the tangent at any point can be determined by finding the ultimate ratio of the corresponding elementary variations of the coordinates at the point. Newton gave, in his *Opuscula*, several applications of such systems of coordinates. In particular, it may be noticed that he considered the case of what are now called *bifocal curves*, i.e., where the equation is expressed in terms of the distances from two fixed points. Newton illustrated his method by finding the tangent to a Cartesian oval, styled by him an *ellipse of the second order*. The same problem, in a more general case, was studied by Leibnitz (*Ac. Erud.*, 1693), who gave a method of drawing tangents to curves given in terms of the distances from any number of fixed points.

73. At a double point on a curve (see CURVE, vol. vi. p. 719), we have  $\frac{du}{dx} = 0$  and  $\frac{du}{dy} = 0$ ; and  $\frac{dy}{dx}$  at such a point becomes inde-

terminate, — being of the form  $\frac{0}{0}$ , since  $\frac{dy}{dx} = - \frac{\frac{du}{dy}}{\frac{du}{dx}}$ .

Applying the method of § 53, the true value of  $\frac{dy}{dx}$  becomes in this case that of

$$\frac{d^2u}{dx^2} + \frac{d^2u}{dx dy} \frac{dy}{dx},$$

$$\frac{d^2u}{dx dy} + \frac{d^2u}{dy^2} \frac{dy}{dx},$$

$$\frac{d^2u}{dx^2} + \frac{d^2u}{dx dy} \frac{dy}{dx},$$

$$\text{i.e., } \frac{dy}{dx} = - \frac{\frac{d^2u}{dx dy} + \frac{d^2u}{dy^2} \frac{dy}{dx}}{\frac{d^2u}{dx^2} + \frac{d^2u}{dx dy} \frac{dy}{dx}}.$$

Hence  $\frac{d^2u}{dx^2} + 2 \frac{d^2u}{dx dy} \frac{dy}{dx} + \frac{d^2u}{dy^2} \left( \frac{dy}{dx} \right)^2 = 0$ .

The roots of this equation in  $\frac{dy}{dx}$  give the tangents to the two branches of the curve at the double point.

Double points are distinguished into three classes, according as the roots of this equation are (1) real and unequal, (2) real and equal, or (3) imaginary, i.e., as  $\left( \frac{d^2u}{dx dy} \right)^2 - \frac{d^2u}{dx^2} \frac{d^2u}{dy^2}$  is  $>$ ,  $=$ , or  $<$  0.

Of these the first are called *nodes*, the second *cusps*, and the third *conjugate points*. They are frequently also styled by Professor Cayley's nomenclature as *crunodes*, *spinodes*, and *acnodes*. See vol. vi. p. 723.

74. In the general discussion of curves it is usually more convenient to refer them to a system of *trilinear coordinates* (see vol. vi. p. 719), in which the position of a point is determined by its distances from three fixed lines. The equations of curves in system are homogeneous.

Again, if  $(x, y, z)$ ,  $(x', y', z')$  denote two points in such a system, the coordinates of any point on the line joining these points may be represented by

$$\lambda x + \kappa x', \quad \lambda y + \kappa y', \quad \lambda z + \kappa z'.$$

Hence, to determine the points in which the line joining  $x, y, z$  to  $x', y', z'$  intersects a curve of the  $n$ th degree, we substitute  $\lambda x + \kappa x'$ ,  $\lambda y + \kappa y'$ ,  $\lambda z + \kappa z'$  for  $x, y, z$  in the equation of the curve,  $u = 0$ ; then by Taylor's theorem (§ 57) the result may be written

$$\lambda^n u + \lambda^{n-1} \kappa \left( x \frac{du}{dx} + y' \frac{du}{dy} + z' \frac{du}{dz} \right)$$

$$+ \frac{\lambda^{n-2} \kappa^2}{1 \cdot 2} \left( x' \frac{d}{dx} + y' \frac{d}{dy} + z' \frac{d}{dz} \right)^2 u + \&c.,$$

or

$$\lambda^n u + \lambda^{n-1} \kappa \Delta u + \frac{\lambda^{n-2} \kappa^2}{1 \cdot 2} \Delta^2 u + \&c.,$$

where  $\Delta$  stands for the symbol of operation

$$\left( x' \frac{d}{dx} + y' \frac{d}{dy} + z' \frac{d}{dz} \right).$$

The roots of this equation in  $\frac{\lambda}{\kappa}$  determine the coordinates of the points of intersection of the line and the curve.

If the point  $x, y, z$  lie on the curve, we have  $u = 0$ ; if in addition we have

$$x \frac{du}{dx} + y' \frac{du}{dy} + z' \frac{du}{dz} = 0, \quad \text{or } \Delta u = 0,$$

then a second point of intersection of the line with the curve will be consecutive to  $x, y, z$ ; and  $\Delta u = 0$  is the equation to the tangent at the point  $x, y, z$ .

Again, if the latter expression  $\Delta u$  vanish identically, the point  $x, y, z$  is a double point on the curve; or, in other words, every line passing through it meets two branches of the curve there. The equation  $\Delta^2 u = 0$  is in this case that of the pair of tangent lines at this point to these two branches.

This method is evidently susceptible of much extension.

*Asymptotes.*

75. The method of the calculus furnishes a ready mode of determining the asymptotes to algebraic curves. By an asymptote we understand a tangent whose point of contact is situated at an infinite distance.

To find the asymptotes to a curve of the  $n$ th degree, we suppose its equation written in the form

$$u_n + u_{n-1} + u_{n-2} + \dots + u_2 + u_1 + u_0 = 0,$$

where  $u_n$  is a homogeneous expression of the  $n$ th degree in  $x$  and  $y$ , &c.

Again, writing  $u_n = x^n f_0 \left( \frac{y}{x} \right)$ ,  $u_{n-1} = x^{n-1} f_1 \left( \frac{y}{x} \right)$ , &c., the equation becomes

$$x^n f_0 \left( \frac{y}{x} \right) + x^{n-1} f_1 \left( \frac{y}{x} \right) + x^{n-2} f_2 \left( \frac{y}{x} \right) + \&c. = 0.$$

Let  $y = \kappa x + \nu$  be the equation of any right line; then, to find its points of intersection with the curve, we substitute  $\kappa + \frac{\nu}{x}$  for  $\frac{y}{x}$  in the preceding equation, and, after expansion by Taylor's theorem, we arrange according to powers of  $x$ ; this gives

$$x^n f_0(\kappa) + x^{n-1} \{ f_1(\kappa) + \nu f_0'(\kappa) \}$$

$$+ x^{n-2} \{ f_2(\kappa) + \nu^2 f_1'(\kappa) + \frac{\nu^2}{1 \cdot 2} f_0''(\kappa) \} + \&c. = 0.$$

Now if the line  $y = \kappa x + \nu$  be an asymptote, two of the roots of this equation in  $x$  must be infinite, and consequently we have

$$f_0(\kappa) = 0, \quad \text{and } f_1(\kappa) + \nu f_0'(\kappa) = 0.$$



If  $\kappa'$  be a root of  $f_0(\kappa) = 0$ , the corresponding value of  $\nu$  is

$$-\frac{f_1(\kappa')}{f_0'(\kappa')}$$

and the equation

$$y = \kappa'x - \frac{f_1(\kappa')}{f_0'(\kappa')}$$

represents an asymptote.

If  $f_1(\kappa') = 0$ , i.e., if  $u_{n-1}$  and  $u_n$  have a common factor  $y - \kappa'x$ , the line  $y = \kappa'x$  is an asymptote.

To each root of  $f_0(\kappa) = 0$  corresponds an asymptote, and accordingly every curve of the  $n$ th degree has in general  $n$  asymptotes, real or imaginary. If the equation of the curve contains no terms of the degree  $n - 1$ , the  $n$  asymptotes are represented by the equation  $u_n = 0$ .

In the case when  $f_0(\kappa)$  has a pair of roots each equal to  $\kappa'$ , then  $f_1(\kappa') = 0$ , and the corresponding value of  $\nu$  is, in general, infinite. In such cases the corresponding asymptote is situated at infinity. The parabola is the simplest case of this, having the line at infinity for its asymptote. Branches of this class belonging to a curve are called *parabolic*, while a branch having an asymptote within a measurable distance is called *hyperbolic*.

It is easy to establish an analogous method for finding asymptotes to curves whose equations are given in polar coordinates.

The equations to the real asymptotes in the following curves are easily found by the above method.

- (1)  $x^2y^2 = a^2(x^2 + y^2) + b^4$ . *Ans.*  $x = \pm a, y = \pm a$ .  
 (2)  $x^2y^2 = a^2(x^2 - y^2) + b^2(x + y)$ . ,,  $y + a = 0, y - a = 0$ .  
 (3)  $x^3 - x^2y - (a + c)x^2 + axy + 2a^2y + d = 0$ . ,,  $x + a = 0, x - 2a = 0$   
 $x - y - c = 0$ .

(4) Prove that the asymptotes to a curve of the third degree meet the curve in points which lie on a right line.

(5) Show that the curve  $x^3 - axy + aby = 0$  has a parabolic asymptote, and find its equation.

*Curvature, Evolutes, Points of Inflection.*

76. The word curvature indicates deviation from a right line, the curvature at any point on a curve being greater or less according as it deviates more or less rapidly from the tangent at the point.

The curvature at any point on a curve is obtained by determining the circle which has the same curvature as that of the curve at the point. Let  $ds$  be an indefinitely small element of the curve, and  $d\phi$  the angle between the tangents at its extremities, then  $\frac{ds}{d\phi}$  represents the radius of the circle which has the same curvature.

$\frac{ds}{d\phi}$  is accordingly called the *radius of curvature* of the curve at the point. The circle is called the *circle of curvature*, and its centre the *centre of curvature*, corresponding to the point on the curve. Denoting the radius of the circle of curvature by  $\rho$ , we have

$$\rho = \frac{ds}{d\phi}$$

Again, if  $x, y$  be the coordinates of the point, and  $\phi$  be measured from the axis of  $x$ , then, since  $ds$  is the limit of the hypotenuse of a right-angled triangle of which  $dx, dy$  are the limits of the sides, we have

$$\tan \phi = \frac{dy}{dx}; \therefore \frac{d^2y}{dx^2} = \sec^2 \phi \frac{d\phi}{dx} = \sec^2 \phi \frac{d\phi}{ds} \cdot \frac{ds}{dx} = \frac{\sec^3 \phi}{\rho}$$

Hence 
$$\rho = \frac{\sec^3 \phi}{\frac{d^2y}{dx^2}} = \frac{1 + \left(\frac{dy}{dx}\right)^2}{\frac{d^2y}{dx^2}}$$

This expression for the radius of curvature was given by John Bernoulli (*Acta Eruditorum*, 1701).

The radius of curvature becomes infinite at a point for which  $\frac{d^2y}{dx^2} = 0$ . Such points are styled *points of inflection* on the curve, and the tangent at a point of inflection is called a *stationary tangent* (vol. vi. p. 719). Other expressions for the radius of curvature can be readily obtained.

For instance, since

$$\cos \phi = \frac{dx}{ds}, \text{ and } \sin \phi = \frac{dy}{ds},$$

if the arc be taken as the independent variable, we have

$$-\sin \phi \frac{d\phi}{ds} = \frac{d^2x}{ds^2}, \quad \cos \phi \frac{d\phi}{ds} = \frac{d^2y}{ds^2},$$

$$\therefore \frac{1}{\rho} \frac{d\phi}{ds} = \sqrt{\left(\frac{d^2x}{ds^2}\right)^2 + \left(\frac{d^2y}{ds^2}\right)^2}$$

Again, if  $p$  be the length of the perpendicular drawn from the origin on the tangent at a point whose distance from the origin is  $r$ , the radius of curvature at the point is given by the equation

$$\rho = r \frac{dr}{d\nu}$$

This value of  $\rho$  can be readily established from geometrical considerations, and is frequently useful, more especially in applications of the calculus to physical astronomy.

77. If the centre of curvature for each point on a plane curve be taken, we get a new curve called its *evolute*. Also, with respect to the evolute, the original curve is called an *involute*, and may be described from its evolute by the unrolling a stretched string supposed wound round the evolute. In this motion each point on the string describes an *involute* to the curve. The curves of the system thus described are said to be *parallel*. Again, from its definition, it is plain that the evolute of a curve is the locus of the points of intersection of the normals drawn at consecutive points on the curve.

78. *Contact of Curves.*—Suppose two curves, represented by the equations  $y = f(x)$  and  $y = \phi(x)$ , to have a point  $(x, \nu)$  in common, then  $f(x) = \phi(x)$ .

Let  $x + h$  be substituted for  $x$  in both equations, and suppose  $y_1$  and  $y_2$  to be the corresponding ordinates, then

$$y_1 = f(x + h) = f(x) + hf'(x) + \frac{h^2}{1.2} f''(x) + \&c.$$

$$y_2 = \phi(x + h) = \phi(x) + h\phi'(x) + \frac{h^2}{1.2} \phi''(x) + \&c.$$

$$\therefore y_1 - y_2 = h \left\{ f'(x) - \phi'(x) \right\} + \frac{h^2}{1.2} \left\{ f''(x) - \phi''(x) \right\} + \&c.$$

Now, if  $f'(x) = \phi'(x)$ , we have

$$y_1 - y_2 = \frac{h^2}{1.2} \left\{ f''(x) - \phi''(x) \right\} + \frac{h^3}{1.2.3} \left\{ f'''(x) - \phi'''(x) \right\} + \&c.,$$

and the curves have a common tangent. In this case the curves have a contact of the first order, and when  $h$  is small the difference between the ordinates  $y_1$  and  $y_2$  is a small quantity of the second order.

If in addition  $f''(x) = \phi''(x)$ , we have

$$y_1 - y_2 = \frac{h^3}{1.2.3} \left\{ f'''(x) - \phi'''(x) \right\} + \&c.$$

In this case the difference of the ordinates is a small quantity of the *third* order; and the curves are said to have a contact of the *second* order, and approach indefinitely nearer to each other at the point of contact than in the former case.

Also, since  $y_1 - y_2$  changes its sign with that of  $h$ , the curves intersect, as well as touch, at the point of contact.

If, moreover,  $f'''(x) = \phi'''(x)$ , the curves have a contact of the third order.

In general, if  $f(x) = \phi(x)$ ,  $f'(x) = \phi'(x)$ ,  $f''(x) = \phi''(x)$ , . . .  $f^{(n)}(x) = \phi^{(n)}(x)$ , the curves are said to have a *contact of the  $n$ th order* at the point.

It is plain from what precedes that, if two curves have a contact of the  $n$ th order, no curve having with either a contact of a lower order can pass between them.

We shall illustrate this theory of the contact of curves by finding the circle which has a contact of the second order with the curve  $y = f(x)$  at the point  $(x, y)$ .

Suppose  $(x - \alpha)^2 + (y - \beta)^2 = r^2$  to be the equation of the circle, then, by the preceding,  $\frac{dy}{dx}$  and  $\frac{d^2y}{dx^2}$  must be the same for the circle and for the curve at the point.

Differentiating twice successively the equation of the circle we get

$$x - \alpha + (y - \beta) \frac{dy}{dx} = 0,$$

and 
$$1 + \left(\frac{dy}{dx}\right)^2 + (y - \beta) \frac{d^2y}{dx^2} = 0.$$

Hence 
$$R^2 = (x - \alpha)^2 + (y - \beta)^2 = \frac{1 + \left(\frac{dy}{dx}\right)^2}{\left(\frac{d^2y}{dx^2}\right)^2}.$$

This agrees with the value for the radius of curvature found in § 76, and shows, as is indeed evident, that the circle of curvature is the circle having a contact of the second order at the point in which it touches the curve.

Again, if  $x, y$  be eliminated between the preceding differential equations and that of the curve, the resulting equation in  $\alpha, \beta$  is that of the evolute of the curve.

From what has been shown above, if the equation of a curve contain  $n$  arbitrary coefficients, we can in general determine their values so that the curve shall have a contact of the order  $n - 1$  with a given curve at any point; for the coefficients can be determined so that  $y, \frac{dy}{dx}, \frac{d^2y}{dx^2}, \dots, \frac{d^{n-1}y}{dx^{n-1}}$  shall have the same values for the two curves at the point.

The curve thus determined having a contact of the highest order with a given curve at any point is called an *osculating curve*. For instance, as the equation of a right line contains but two independent constants, it admits in general of a contact of the first degree only. Again, the equation of a circle has three independent con-

stants, and accordingly the circle admits in general of a contact of the second degree with a curve at any point. The parabola has four independent constants, and consequently admits of a contact of the third order; and so on.

Again, introducing the additional condition  $f^{(n)}(x) = \phi^{(n)}(x)$ , a finite number of points is seen to exist at which the osculating curve has a contact one degree higher; thus a tangent may have contact of the second order, an osculating circle contact of the third order, and so on.

In the case of a right line, we have  
 $\phi(x) = ax + b, \quad \phi'(x) = a, \quad \phi''(x) = 0.$  This agrees with the condition found for a point of inflexion in § 76. The problem of contact admits of being considered also from a geometrical point of view, i.e., from the consideration of the number of consecutive points of intersection of two curves.

79. The discussion of evolutes and involutes originated with Huygens, in his celebrated work, *Horologium Oscillatorium* (1673), published before the invention of the calculus. Huygens's investigation is purely geometrical. The definition of the osculating circle was first given by Leibnitz, in the *Acta Eruditorum*, 1686, where he pointed out its great importance in the study of curves. Newton, in his *Principia*, makes frequent use of the theory of the radius of curvature, and of its connexion with evolutes.

Newton also observed that the radius of curvature becomes infinite at a point of inflexion, and vanishes at a cusp—called by him *punctum rectitudinis*, and *punctum curvaturæ infinitæ*, respectively. See *Opusc.*, i. pp. 121, 122, ed. Cast.

It is worthy of remark that Sluze, in his *Mesolabrum seu duæ medietates proportionales*, &c. (1659), pointed out a general method for the determination of the points of inflexion (*puncta flexus contrarii*), by reducing it to a question of maxima and minima, viz., to finding when the intercept made by the tangent, measured along any axis from a fixed point on it, is a maximum or a minimum. This method he applied successfully to the conchoid of Nicomedes.

(1) It is easily found as above that the radius of curvature at any point on the curve  $3a^2y = x^3$  is equal to  $\rho = \frac{(x^3 + x^2)^{\frac{3}{2}}}{2a^2x}$ .

(2) The following expression for the radius of curvature in polar coordinates,—

$$\rho = \frac{r^2 \left\{ 1 + \left( \frac{dr}{r d\theta} \right)^2 \right\}^{\frac{3}{2}}}{r^2 - r' \frac{d^2r}{r d\theta^2} + 2 \left( \frac{dr}{r d\theta} \right)^2},$$

can be easily deduced.

(3) If  $u = \frac{1}{r}$ , this becomes

$$\rho = \frac{\left\{ 1 + \left( \frac{du}{u d\theta} \right)^2 \right\}^{\frac{3}{2}}}{u + \frac{d^2u}{d\theta^2}}.$$

(4) Hence at a point of inflexion we have

$$u + \frac{d^2u}{d\theta^2} = 0.$$

(5) The origin is a point of inflexion on the curve represented by the equation  $u_1 + u_2 = 0$ .

(6) The length of the radius of curvature at the origin in the curve  $y = a \sin \pi\theta$  is  $\frac{1}{2}a$ .

(7) If on the tangent to a curve a constant length be measured from the point of contact, the normal to the locus of the points thus taken passes through the corresponding centre of curvature of the proposed curve.

(8) In the ellipse  $\frac{x^2}{a^2} + \frac{y^2}{b^2} = 1$ , if we take  $x = a \cos \phi, y = b \sin \phi$ , the coordinates  $\alpha, \beta$  of the centre of curvature of any point are given by the equations

$$\alpha = \frac{a^2 - b^2}{a} \cos^3 \phi; \quad \beta = \frac{b^2 - a^2}{b} \sin^3 \phi.$$

(9) At a cusp (compare § 73) the radius of curvature is zero for both branches.

(10) In some cases two branches of the same curve may have a contact of the second or of a higher order. For instance, it is easy to show that at the origin two branches of the curve

$$y^2 - 2a^2y + x^4 - x^2 = 0$$

have equal finite radii of curvature.

*Envelopes.*

80. If we suppose a series of different values given to  $a$  in the equation

$$f(x, y, a) = 0,$$

then for each value we get a distinct curve, and the above equation may be regarded as representing an indefinite number of curves, a single determinate curve corresponding to each distinct value of  $a$ , provided  $a$  enters into the equation in a rational form only.

If now we regard the parameter  $a$  as varying continuously, and consider the two curves

$$f(x, y, a) = 0, \quad f(x, y, a + \Delta a) = 0,$$

then the coordinates of their points of intersection satisfy each of these equations and therefore also satisfy the equation

$$\frac{f(x, y, a + \Delta a) - f(x, y, a)}{\Delta a} = 0.$$

Now, in the limit, when  $\Delta a$  is infinitely small, the latter equation becomes

$$\frac{df(x, y, a)}{da} = 0.$$

Hence the locus of the points of ultimate intersection for the entire system of curves represented by  $f(x, y, a) = 0$  is obtained by eliminating  $a$  between the equations

$$f(x, y, a) = 0 \quad \text{and} \quad \frac{df(x, y, a)}{da} = 0.$$

This locus is called the *envelope* of the system, and it can be easily seen that it is touched by every curve of the system.

For instance, suppose  $L, M, N$  to be given functions of  $x$  and  $y$ , and  $a$  a parameter, to find the envelope of the system of curves represented by the equation

$$La^2 + 2Ma + N = 0.$$

Hence

$$f(x, y, a) = La^2 + 2Ma + N; \\ \therefore \frac{df(x, y, a)}{da} = 2La + 2M.$$

Consequently the envelope is the curve represented by the equation  $LN = M^2$ .

For example, if  $L, M, N$  represent right lines, the envelope of the moving line

$$La^2 + 2Ma + N = 0,$$

is the conic  $LN = M^2$ .

In general, if the equation of the moving curve be of the form

$$P_0 a^n + P_1 a^{n-1} + P_2 a^{n-2} + \dots + P_n = 0,$$

where  $P_0, P_1, P_2, \dots, P_n$  are given functions of  $x$  and  $y$ , the envelope is obtained by the elimination of  $a$  between the proposed equation and its derived equation

$$nP_0 a^{n-1} + (n-1)P_1 a^{n-2} + \&c. = 0.$$

It is accordingly represented by the condition that the equation in  $a$  should have equal roots; this condition is called the *discriminant* of the equation. For examples see Salmon's *Higher Plane Curves*, Arts. 85, 86.

81. In many cases the equation of the moving curve is of the form

$$f(x, y, \alpha, \beta) = 0,$$

where the parameters  $\alpha, \beta$  are connected by an equation

$$\phi(\alpha, \beta) = 0.$$

In this case we regard  $\beta$  as a function of  $\alpha$ , and thus we get by differentiation

$$\frac{df}{d\alpha} + \frac{df}{d\beta} \frac{d\beta}{d\alpha} = 0, \quad \frac{d\phi}{d\alpha} + \frac{d\phi}{d\beta} \frac{d\beta}{d\alpha} = 0;$$

consequently, if we make

$$\frac{df}{d\alpha} = \lambda \frac{d\phi}{d\alpha}, \quad \text{we get} \quad \frac{df}{d\beta} = \lambda \frac{d\phi}{d\beta},$$

and the required envelope is obtained by the elimination of  $\alpha, \beta, \lambda$  between these and the two given equations.

For example, let it be proposed to find the envelope of a line of given length ( $a$ ), whose extremities move along two fixed rectangular axes.

Here, taking the fixed lines for coordinate axes, and denoting the intercepts by  $\alpha$  and  $\beta$ , we have

$$\frac{x}{\alpha} + \frac{y}{\beta} = 1, \quad \text{and} \quad \alpha^2 + \beta^2 = a^2.$$

Hence

$$\frac{x}{\alpha} = \lambda \alpha, \quad \frac{y}{\beta} = \lambda \beta;$$

from which we get

$$\lambda = \frac{1}{\alpha^2}, \quad \therefore \alpha^2 = a^2 x, \quad \beta^2 = a^2 y,$$

and the equation of the envelope is

$$x^2 + y^2 = a^2.$$

This envelope was discussed by John Bernoulli in the *Acta Erud.*, 1692.

Again, to find the equation to the evolute of an ellipse, regarded as the envelope of its normals. Here we have the equations

$$a^2 \frac{x}{\alpha} - b^2 \frac{y}{\beta} = a^2 - b^2, \quad \text{and} \quad \frac{\alpha^2}{a^2} + \frac{\beta^2}{b^2} = 1,$$

where  $\alpha, \beta$  are the coordinates of a point on the ellipse. Hence

$$\frac{a^2 x}{\alpha^2} = \lambda \frac{\alpha}{a^2}, \quad \frac{b^2 y}{\beta^2} = -\lambda \frac{\beta}{b^2}$$

and we easily obtain as the required equation

$$(ax)^{\frac{3}{2}} + (by)^{\frac{3}{2}} = (a^2 - b^2)^{\frac{3}{2}}.$$



The preceding method can be readily extended to the general case in which the equation of the moving curve contains any number  $n$  of variable parameters, which are connected by  $n-1$  equations of condition.

82. The theory of envelopes, or of ultimate intersections, may be said to have originated with the investigations of Huygens on evolutes, already referred to, and those of Tschirnhausen on caustics (*Acta Eruditorum*, 1682). These authors, however, merely treated geometrically a few cases of moving right lines, and did not give any general method for the investigation of such problems. Leibnitz was the first who gave a general process for the solution of this class of questions (*Acta Eruditorum*, 1692, 1694). His method does not differ in any material respect from that here given.

(1) To find the envelope of the parabolas described by a projectile discharged from a given point with a given velocity, but at different angles of elevation.

If  $e$  be the angle of elevation, and  $h$  the height due to the initial velocity, the equation of the parabolic path is

$$x = y \tan e - \frac{y^2}{4h \cos^2 e}.$$

Let  $\tan e = a$ , and the equation becomes

$$x = ay - \frac{y^2}{4h} (1 + a^2), \text{ or } \frac{y^2}{4h} + x - ay + a^2 \frac{y^2}{4h} = 0.$$

Consequently the equation to the required envelope is

$$y^2 = 4h(h - x),$$

which represents a parabola.

This problem is the first that was brought forward on the locus of the ultimate intersection of curved lines. It was proposed by Daillier to John Bernoulli, who solved it, but not by any general method (*Commer. Epist. Leib. et Bern.*, vol. i. p. 17).

(2) To find the envelope of the system of conics represented by the equation

$$\frac{x^2}{a} + \frac{y^2}{a-n} = 1,$$

where  $a$  is a variable parameter. Proceeding as before we get as the equation to the envelope  $(x \pm \sqrt{n})^2 + y^2 = 0$ . Hence we infer that a system of confocal conics may be regarded as inscribed in the same imaginary quadrilateral.

(3) Find the envelope of the plane

$$\frac{x}{l} + \frac{y}{m} + \frac{z}{n} = 1$$

in which the parameters  $l, m, n$  are connected by the equation  $lmn = a^3$ . *Ans.*  $27ayz = a^3$ .

(4) A right line revolves with a uniform angular velocity, while one of its points moves uniformly along a fixed right line, prove that its envelope is a cycloid.

*Symbolic Methods.*

83. The analogy between successive differentiation and ordinary exponentials was perceived by Leibnitz and the early writers on the calculus, and afterwards more especially by Lagrange (*Mém. Acad. Berlin*, 1772). Arbogast was, however, the first to separate the symbol of operation from that of quantity in a differential equation (*Calcul des Dérivations*, 1800). The first writers who appear to have given correct rules on the subject of operations were François, *Ann. des Math.*, 1812, and Sarvois, in the same journal, in 1814. Sarvois more especially exhibited the principles on which the legitimacy of the separation of the symbols of operation from those of quantity depends; and, making a separate calculus of functions out of those properties, he succeeded in proving that differences, differentiations, and multiplications by any factors which are independent of the variable, may be employed as if the symbols of operation were ordinary algebraic quantities. Hence has arisen a new method of considering the principles and processes of the calculus, called the symbolic method, or the calculus of operations.

In this method  $\frac{d}{dx}$  is written in the form  $\left(\frac{d}{dx}\right)u$ , and the symbol

$\frac{d}{dx}$  is regarded in the light of an operation, supposed to be made on the function  $u$  according to the established principles of differentiation.

Again 
$$\frac{d}{dx}(u+v) = \left(\frac{d}{dx}\right)u + \left(\frac{d}{dx}\right)v \dots \dots (1).$$

Also, 
$$\left(\frac{d}{dx}\right)^m \left(\frac{d}{dx}\right)^n u = \left(\frac{d}{dx}\right)^{m+n} u \dots \dots (2).$$

And, if  $u$  be a function of  $x$  and  $y$ ,

$$\left(\frac{d}{dx}\right) \left(\frac{d}{dy}\right)u = \left(\frac{d}{dy}\right) \left(\frac{d}{dx}\right)u \dots \dots (3).$$

Hence we observe that the symbols  $\frac{d}{dx}$  and  $\frac{d}{dy}$  operate and are com-

mutative according to the same laws as ordinary algebraic symbols of quantity, such as  $a$  and  $b$ ; and we can readily infer that the theorems in ordinary algebra (compare ALGÈBRE, vol. i. p. 519, § 8, 9) which depend solely on such laws of combination are capable of being extended to similar theorems depending on the symbols  $\frac{d}{dx}$  and  $\frac{d}{dy}$

or on the symbol  $\frac{d}{dx}$  and any constant  $d$ . Such results are in general capable of extension to any symbols that are subject to the same laws of combination.

The law embodied in equation (1) is called the distributive law; the second, in (2), is called the index or exponential law; and the third, in (3), the commutative law.

It is convenient to denote the preceding symbols by single letters. Accordingly we may suppose the symbol  $\frac{d}{dx}$  to be represented by  $D$ ,

and  $\frac{d}{dy}$  by  $D'$ , &c.

In general, if  $\pi, \rho$  denote two symbols of operation such that

$$\begin{aligned} \pi(u \cdot v) &= \pi u \cdot \pi v, \\ \rho(u \cdot v) &= \rho u \cdot \rho v, \\ \pi \rho u &= \rho \pi u, \\ \pi^n \pi^m u &= \pi^{n+m} u, \end{aligned}$$

then the symbols  $\pi, \rho$  possess the distributive, commutative, and exponential properties.

For example, suppose  $E_h$  represent the operation of changing  $x$  into  $x+h$  in any function of  $x$ , i.e., suppose  $E_h \phi(x) = \phi(x+h)$ . Then

$$E_h \{ \phi(x) \cdot \psi(x) \} = \phi(x+h) \cdot \psi(x+h) = E_h \phi(x) \cdot E_h \psi(x).$$

Moreover,  $E_k$  denoting the operation of changing  $x$  into  $x+k$ , we have

$$E_k \phi(x) = \phi(x+k), \dots E_k \cdot E_h \phi(x) = \phi(x+k+h) = \phi(x+h+k).$$

In like manner

$$E_k E_h \phi(x) = \phi(x+h+k) = E_h E_k \phi(x), \dots E_h E_k \phi(x) = E_k E_h \phi(x).$$

Hence the symbols  $E_h, E_k$  are commutative.

Also the equation

$$E_h E_k \phi(x) = E_{h+k} \phi(x)$$

may be written, symbolically, thus:—

$$E_h E_k = E_{h+k}.$$

This shows that the symbol  $E_h$  is of the nature of an exponential; and may be written in the form  $E^{hD}$ .

84. This symbol can also be connected with Taylor's expansion. Thus, if we separate the symbols of operation from those of quantity in Taylor's theorem, it may be written

$$f(x+h) = \left( 1 + hD + \frac{h^2}{1 \cdot 2} D^2 + \frac{h^3}{1 \cdot 2 \cdot 3} D^3 + \dots \right) f(x) = e^{hD} f(x).$$

Accordingly, although we can give no direct meaning to the symbol  $e^{hD}$ , except as the representative of the symbolic expansion

$$1 + hD + \frac{h^2}{1 \cdot 2} D^2 + \dots + \frac{h^n}{n!} D^n.$$

we may from the preceding section regard it as equivalent to the symbol  $E^h$ .

In like manner we may write

$$e^{hD} \phi(x, y) = \phi(x+h, y).$$

If now we suppose both sides operated on by the symbol  $e^{kD'}$ , we have

$$e^{kD'} \cdot e^{hD} \cdot \phi(x, y) = e^{kD'} \phi(x+h, y) = \phi(x+h, y+k).$$

Hence

$$\begin{aligned} \phi(x+h, y+k) &= e^{hD+kD'} \phi(x, y) \\ &= \left\{ 1 + (hD+kD') + \frac{1}{2} (hD+kD')^2 + \dots \right\} \phi(x, y) \\ &= \phi(x, y) + h \frac{\partial \phi}{\partial x} + k \frac{\partial \phi}{\partial y} + \frac{1}{2} \left( h^2 \frac{\partial^2 \phi}{\partial x^2} + 2hk \frac{\partial^2 \phi}{\partial x \partial y} + k^2 \frac{\partial^2 \phi}{\partial y^2} \right) + \&O \end{aligned}$$

(Compare § 57; also Arbogast, *Cal. des Dér.*, pp. 343-352.)

85. Another proof, by the method of operations, of the foregoing symbolic expression for Taylor's theorem may be added.

It has already been shown that when  $h$  is infinitely small we may write

$$\phi(x+h) - \phi(x) = h \phi'(x) = hD \phi(x), \dots \phi(x+h) = (1+hD) \phi(x).$$

In like manner

$$(1+hD)^2 \phi(x) = (1+hD) \phi(x+h) = \phi(x+2h), \&c.$$

And in general

$$\phi(x+nu) = (1+hD)^n \phi(x).$$

Now suppose  $nh = a$ , and we get

$$\phi(x+a) = (1+hD)^{\frac{a}{h}} \phi(x).$$

But when  $h$  is infinitely small, we may, by analogy (see § 21), assume

$$(1+hD)^{\frac{1}{h}}u = e^{\alpha}u, \quad \therefore (1+hD)^{\frac{\alpha}{h}}u = e^{\alpha}u.$$

Hence

$$\phi(x+\alpha) = e^{\alpha D}\phi(x), \text{ as before.}$$

86. Again, as in § 84, representing the symbol  $e^{\alpha}$  by  $E$ , we may write

$$e^{\alpha D}\phi(x) = E\phi(x).$$

Also, if  $\Delta$  prefixed to any function of  $x$  denote the operation of taking the increment of that function when  $x$  receives the increment unity, we have

$$f(x+1) - f(x) = \Delta f(x).$$

Accordingly

$$E\phi(x) = (1+\Delta)\phi(x).$$

And, by the index law, we have

$$E^n\phi(x) = (1+\Delta)^n\phi(x),$$

$$\begin{aligned} \text{or } f(x+n) &= \left(1+n\Delta + \frac{n(n-1)}{1 \cdot 2}\Delta^2 + \dots\right)\phi(x) \\ &= f(x) + n\Delta f(x) + \frac{n(n-1)}{1 \cdot 2}\Delta^2 f(x) + \&c. \end{aligned}$$

Adopting the notation  $\phi(x) = u_x$ ,  $\phi(x+h) = u_{x+h}$ , &c., this leads to the following fundamental theorem of the calculus of finite differences

$$u_{x+n} - u_x = n\Delta u_x + \frac{n(n-1)}{1 \cdot 2}\Delta^2 u_x + \dots$$

Again, since

$$\Delta = E - 1, \text{ we have } \Delta^n u_x = (E-1)^n u_x$$

Hence, in like manner,

$$\Delta^n u_x = u_{x+n} - n\Delta u_{x+n-1} + \frac{n(n-1)}{1 \cdot 2}\Delta^2 u_{x+n-2} + \dots + (-1)^n u_x.$$

For example,

$$\Delta^n x^m = (x+1)^m - n(x+n-1)^{m-1} + \dots + (-1)^n x^m.$$

Again, if  $\Delta^n 0^m$  represent the value of  $\Delta^n x^m$  when  $x=0$ , we have

$$\Delta^n 0^m - n\Delta^n 0^{m-1} + \frac{n(n-1)}{1 \cdot 2}\Delta^n 0^{m-2} - \dots + (-1)^n 0^m.$$

The numbers represented by the symbol  $\Delta^n 0^m$ , called the differences of the powers of zero, are of frequent occurrence in analysis, and their values can be readily tabulated from this series

87. Again, since

$$D(uv) = \frac{d}{dx}(uv) = v \frac{d}{dx}u + u \frac{d}{dx}v = (D_1 + D_2)uv,$$

in which we suppose  $D_1$  to operate on  $u$  only, and  $D_2$  on  $v$  only, we infer that

$$\begin{aligned} D^n(uv) &= (D_1 + D_2)^n uv \\ &= \left\{ D_1^n + n D_1^{n-1} D_2 + \frac{n(n-1)}{1 \cdot 2} D_1^{n-2} D_2^2 + \dots \right\} uv \\ &= v \frac{d^n u}{dx^n} + n \frac{dv}{dx} \frac{d^{n-1} u}{dx^{n-1}} + \frac{n(n-1)}{1 \cdot 2} \frac{d^2 v}{dx^2} \frac{d^{n-2} u}{dx^{n-2}} + \dots + u \frac{d^n v}{dx^n}. \end{aligned}$$

This is Leibnitz's theorem, given in § 27.

This result can be extended to the  $n$ th differential of the product of any number of functions.

88. More generally, if  $\psi(x)$  represent any function of  $x$ , and if  $f(x)$  be any rational function, and we suppose  $D_1$  operates on  $u$  only, and  $D_2$  on  $\psi(x)$  only, we have

$$\begin{aligned} f(D)\psi(x)u &= f(D_1 + D_2)\psi(x)u \\ &= \{f(D_1) + D_2 f'(D_1) + \dots\}\psi(x)u \\ &= \psi(x)f(D)u + \psi'(x)f'(D)u + \frac{\psi''(x)}{1 \cdot 2}f''(D)u + \&c. \end{aligned}$$

In like manner the equation

$$f(x)\psi(D)u = \psi(D)f(x)u - \psi'(D)f'(x)u + \frac{\psi''(D)}{1 \cdot 2}f''(x)u - \dots$$

can be established.

These expansions form the basis of Hargreave's well-known memoir on the "Solution of Differential Equations" (*Philosophical Transactions*, 1845). Hargreave observes that on mere inspection of these results it is apparent that if  $D$  be substituted for  $z$ , and  $-z$  for  $D$ , the former equation transforms into the latter. Hence, in any differential equation and in its symbolical solution, if the foregoing substitutions be made we shall obtain another form, accompanied with its symbolical solution. This principle was applied by Hargreave to the solution of several classes of differential equations.

89. Again, in Leibnitz's theorem we make  $v = e^{\alpha x}$ , we get

$$\begin{aligned} D^n(e^{\alpha x}u) &= e^{\alpha x} \left( D^n u + n\alpha D^{n-1}u + \frac{n(n-1)}{1 \cdot 2}\alpha^2 D^{n-2}u + \dots \right) \\ &= e^{\alpha x} \left( D^n + n\alpha D^{n-1} + \frac{n(n-1)}{1 \cdot 2}\alpha^2 D^{n-2} + \dots \right) u \\ &= e^{\alpha x} (D + \alpha)^n u. \end{aligned}$$

Accordingly

$$(D + \alpha)^n u = e^{-\alpha x} D^n (e^{\alpha x} u).$$

Hence we readily infer that, if  $f(\alpha)$  represent any function involving only positive integral powers of  $\alpha$ , we shall have

$$f(D + \alpha)u = e^{-\alpha x} f(D) e^{\alpha x} u.$$

Again, if this be transformed by assuming  $e^x = y$ , we have  $\frac{dy}{dx} = y$ , and

$$\therefore \left(\frac{d}{dx}\right)u = \frac{dy}{dx} \left(\frac{d}{dy}\right)u = \left(y \frac{d}{dy}\right)u = yD'u.$$

Hence the foregoing result may be exhibited as follows:—

$$f(yD' + \alpha)u = y^{-\alpha} f(yD')y^{\alpha} u.$$

This may be written

$$f(xD + \alpha)u = x^{-\alpha} f(xD)x^{\alpha} u.$$

90. The interpretation of negative and fractional powers of a symbol of operation is a subject necessarily suggested by the introduction of such symbols. We pass over all allusion to the case of fractional powers, as no satisfactory theory for their interpretation has as yet been arrived at. The interpretation of an integer negative power of a symbol is easily established, and is in all cases of the nature of an inverse process.

For instance let  $\pi$  be a symbol of operation such that

$$\pi u = v,$$

then, if  $v$  be given and  $u$  unknown, we may write

$$u = \pi^{-1}v,$$

and the problem contained in the inverse symbol of operation will be answered when, by any process, we have determined  $u$  so as to satisfy the equation  $\pi u = v$ , or  $\pi \pi^{-1}v = v$ . In other words, we define the inverse symbol  $\pi^{-1}$  to be that which the direct operation  $\pi$  simply annuls; and this is in accordance with the analogy of ordinary algebra.

For example, since  $Df(x) = f'(x)$ , we write  $D^{-1}f'(x) = f(x)$ , and the symbol  $D^{-1}$  is equivalent to an integration. In like manner  $D^{-n}$  is equivalent to  $n$  successive integrations.

Similarly the symbol  $(D + \alpha)^{-n}$  is regarded as the inverse of the symbol  $(D + \alpha)^n$ , i.e., such that

$$(D + \alpha)^n (D + \alpha)^{-n} u = u.$$

We now proceed to investigate how far the equation

$$f(D + \alpha)u = e^{-\alpha x} f(D) e^{\alpha x} u$$

holds for inverse symbols.

We have already seen that when  $n$  is a positive integer

$$(D + \alpha)^n u = e^{-\alpha x} D^n e^{\alpha x} u = v, \text{ suppose; } \therefore u = (D + \alpha)^{-n} v.$$

Moreover from the equation

$$e^{-\alpha x} D^n e^{\alpha x} u = v$$

we get

$$D^n e^{\alpha x} u = e^{\alpha x} v,$$

or

$$u = e^{-\alpha x} D^{-n} e^{\alpha x} v.$$

Consequently

$$(D + \alpha)^{-n} v = e^{-\alpha x} D^{-n} e^{\alpha x} v.$$

Hence we infer that the symbolic equation also holds for negative powers of  $D$ .

91. In general, since

$$D \cdot e^{\phi(x)} u = e^{\phi(x)} \{D + \phi'(x)\} u,$$

we have

$$\{D + \phi'(x)\} u = e^{-\phi(x)} D e^{\phi(x)} u.$$

Again

$$\begin{aligned} \{D + \phi'(x)\}^2 u &= e^{-\phi(x)} D e^{\phi(x)} \{D + \phi'(x)\} u \\ &= e^{-\phi(x)} D^2 e^{\phi(x)} u; \end{aligned}$$

and in general

$$\{D + \phi'(x)\}^n u = e^{-\phi(x)} D^n e^{\phi(x)} u,$$

where  $n$  is an integer.

From this we conclude that in all interpretable cases we have

$$f\{D + \phi'(x)\} u = e^{-\phi(x)} f(D) e^{\phi(x)} u.$$

The results here given have been generalized and extensively employed in the integration of differential equations by Boole. See *Philosophical Transactions*, 1844; also Boole's *Differential Equations*, chapter xvii.

92. We conclude this short account of symbolic methods by applying them to establish one or two well-known formulæ.

It has been shown already (§ 84) that we may write

$$(e^{hD} - 1)\phi(x) = \phi(x+h) - \phi(x).$$

Hence

$$\phi(x) = (e^{hD} - 1)^{-1} \{\phi(x+h) - \phi(x)\}$$

Multiplying by  $h$ , and operating on both sides with the symbol of differentiation  $D$ , we get

$$h\phi'(x) = \left( \frac{hD}{e^{hD} - 1} \right) \{ \phi(x+h) - \phi(x) \}.$$

But, by analogy from § 53, we may write

$$\begin{aligned} & \left( \frac{hD}{e^{hD} - 1} \right) \{ \phi(x+h) - \phi(x) \} \\ &= \left( 1 - \frac{hD}{2} + \frac{B_1 h^2 D^2}{1.2} - \frac{B_2 h^4 D^4}{1.2.3.4} + \dots \right) \{ \phi(x+h) - \phi(x) \} \\ &= \phi(x+h) - \phi(x) - \frac{h}{2} \{ \phi'(x+h) - \phi'(x) \} + \frac{B_1 h^2}{1.2} \{ \phi''(x+h) - \phi''(x) \} \\ & \quad - \frac{B_2 h^4}{1.2.3.4} \{ \phi^{IV}(x+h) - \phi^{IV}(x) \} + \&c. \end{aligned}$$

Hence

$$\begin{aligned} \phi(x+h) &= \phi(x) + \frac{h}{2} \{ \phi'(x+h) + \phi'(x) \} - \frac{h^2}{12} \{ \phi''(x+h) - \phi''(x) \} \\ & \quad + \frac{h^4}{720} \{ \phi^{IV}(x+h) - \phi^{IV}(x) \} - \dots \\ & \quad + (-1)^n \frac{B_n h^{2n}}{1.2 \dots 2n} \{ \phi^{2n}(x+h) - \phi^{2n}(x) \} + \&c. \end{aligned}$$

This result is due to Stirling, and has important applications. To complete this proof it is necessary to consider the question of the convergence or divergence of this series. On this investigation see Bertrand, *Calcul Intégral*, Art. 374.

93. Again, in the calculus of finite differences, if we consider the finite symbol of summation  $\Sigma$  as the inverse to that of finite differences  $\Delta$ , we have

$$\begin{aligned} \Sigma \phi(x) &= \Delta^{-1} \phi(x) = \frac{1}{e^{\Delta} - 1} \phi(x) \\ &= \left( D^{-1} - \frac{1}{2} + \frac{B_1 D}{1.2} - \frac{B_2 D^3}{1.2.3.4} + \dots \right) \phi(x) \\ &= \int \phi(x) dx - \frac{1}{2} \phi(x) + \frac{B_1}{1.2} \phi'(x) - \frac{B_2}{1.2.3.4} \phi'''(x) + \&c. \\ &= C + \int \phi(x) dx - \frac{\phi(x)}{2} + \frac{1}{12} \phi'(x) - \frac{1}{720} \phi'''(x) + \frac{1}{30240} \phi^{(5)}(x) \dots \end{aligned}$$

This theorem is due to Euler; the foregoing demonstration was given by Gregory (*Camb. Math. Journal*, 1837).

On the limits of the remainder after  $n$  terms in this series, see Boole's *Finite Differences*, pp. 91-93; also Mr J. W. L. Glaisher, in *Quarterly Journal of Mathematics*, 1872.

In concluding this brief account of symbolic methods we may observe that the general principles of the theory of operations have been studied in a comprehensive manner by Grassmann, and by Hankel, who applied them to the general theory of complex variables and of quaternions. See Grassmann's *Ausdehnungslehre* (1862), and Hankel's *Vorlesungen über die Complexen Zahlen*, 1867. The reader will find Grassmann's method fully discussed in Heiél's *Calcul Infinitesimal*, vol. i.

We add a few miscellaneous examples of these methods.

(1) Prove the symbolic equation  $x^n D^n u = x(D-1)(x D - 2) \dots (x D - n + 1)u$ .

(2) Prove that  $D^r (e^{ax} x^n) = \left( \frac{x}{a} \right)^{n-r} D^n (e^{ax} x^n)$ .

(3) Prove the symbolic equation in finite differences  $(E-a)^n X = a^{n+x} \Delta^n a^{-n} X$ ,

where  $E$  is the symbol  $e^D$  (Gregory, *Camb. Math. Jour.*, 1837).

(4) If  $\pi$  and  $\rho$  be symbols of operation such that  $\pi \rho - \rho \pi = \rho_1$ ,  $\pi \rho_1 - \rho_1 \pi = \rho_2$ ,  $\pi \rho_2 - \rho_2 \pi = \rho_3$ , prove the following symbolic equation

$$f(\pi)\rho = \rho f(\pi) + \rho_1 f'(\pi) + \frac{\rho_2}{1.2} f''(\pi) + \dots$$

See Donkin, *Camb. and Dub. Math. Jour.*, 1850.

(5) From the preceding the following symbolic equations can be readily deduced.

$$f\left(D + \frac{X'}{X}\right) = f(D) + \frac{X'}{X} f'(D) + \frac{1}{1.2} \frac{X''}{X} f''(D) + \dots$$

$$f\left(x + \frac{\phi'(D)}{\phi(D)}\right) = f(x) + f'(x) \frac{\phi'(D)}{\phi(D)} + \frac{f''(x)}{1.2} \frac{\phi''(D)}{\phi(D)} + \dots$$

(Donkin, *ibid.*)

(6) Every differential equation of the form

$$\{a + bx + cx^2 + \dots\} D^n + \{a' + b'x + \dots\} D^{n-1} + \dots \} u = X$$

can be transformed into the shape

$$\{f_0(xD) + f_1(xD)x + f_2(xD)x^2 + \dots\} u = X. \quad (\text{Boole.})$$

(7) Apply the method of operations to the proof of Herschel's expansion for  $F(e^t)$  (*Philosophical Transactions*, 1816). If we make  $\theta = 0$  in the equation

$$f(D) e^{\theta} = e^{\theta} f(t),$$

we have

$$f(t) = f(D)e^{\alpha}, \text{ where } D \text{ represents the symbol } \frac{d}{d\theta}.$$

If now  $f(t) = F(e^t)$ , we get

$$\begin{aligned} F(e^t) &= F(e^D) \cdot e^{\alpha} = F(1 + \Delta) e^{\alpha} \\ &= F(1 + \Delta) \left\{ 1 + 0\alpha + \frac{0^2 \cdot \alpha^2}{1.2} + \dots \right\} \\ &= F(1) + tF(1 + \Delta) \cdot 0 + \frac{t^2}{1.2} F(1 + \Delta) \cdot 0^2 + \&c. \end{aligned}$$

(Gregory, *Camb. Math. Jour.*, 1838.)

(8) Prove the equation

$$f(D)\phi(e^x) e^{rx} = \phi(E)f(r) e^{rx},$$

where  $D$  represents  $\frac{d}{dx}$ , and  $E$  represents  $ce^{dx}$ .

Also  $f\left(\frac{d}{dx} + r\right)\phi(x) = \phi\left(\frac{d}{dr} + x\right)f(r)$ .

(Brouwin, *Camb. and Dub. Math. Jour.*, 1848.)

(9) Prove the symbolic equation

$$\phi\left(\frac{d}{dD}\right) f(D) X = f(D) \phi(x - \dot{x}) X,$$

where  $\dot{x}$  is to be regarded as a variable independent of the operation  $D$ , but which, after the operations, is to be replaced by  $x$ . (Crofton, *Quar. Math. Jour.*, 1879; also Donkin, *Camb. and Dub. Math. Jour.*, 1850.)

*Change of Independent Variable.*

94. In the application of the calculus it is often necessary to adopt in our equations new independent variables instead of those originally selected.

Thus, suppose it be required to transform a function of  $y, x, \frac{dy}{dx}, \frac{d^2y}{dx^2}$ , &c., into a function of  $y, t, \frac{dy}{dt}, \frac{d^2y}{dt^2}$ ,  $x$  being supposed a function of  $t$ .

Let the functions  $\frac{dx}{dt}, \frac{d^2x}{dt^2}$ , &c., be represented by  $x', x'',$  &c., then we have in all cases

$$\frac{du}{dx} = \frac{1}{x'} \frac{du}{dt}, \quad \therefore \frac{dy}{dx} = \frac{1}{x'} \frac{dy}{dt};$$

also  $\frac{d^2y}{dx^2} = \frac{d}{dx} \left( \frac{1}{x'} \frac{dy}{dt} \right) = \frac{1}{x'} \frac{d}{dt} \left( \frac{1}{x'} \frac{dy}{dt} \right) = \frac{1}{x'^3} \left( x' \frac{d^2y}{dt^2} - x'' \frac{dy}{dt} \right)$ .

Again  $\frac{d^2x}{dt^2} = \frac{d}{dx} \left( x' \frac{d^2y}{dt^2} - x'' \frac{dy}{dt} \right) = \frac{1}{x'} \frac{d}{dt} \left( x' \frac{d^2y}{dt^2} - x'' \frac{dy}{dt} \right) = \frac{1}{x'^5} \left\{ x'^2 \frac{d^2y}{dt^2} - 3x'x'' \frac{d^2y}{dt^2} + \frac{dy}{dt} \left( 3(x')^2 - x''x'' \right) \right\};$

and so on for differentials of higher order.

If  $y$  be taken as the independent variable, we have

$$\frac{dy}{dt} = 1, \quad \frac{d^2y}{dt^2} = 0, \quad \&c.$$

Hence  $\frac{dy}{dx} = \frac{1}{x'}, \quad \frac{d^2y}{dx^2} = \frac{1}{(dx/dy)^3} \cdot \frac{d^2x}{dy^2}$ ,

$$\frac{d^2x}{dy^2} = \frac{1}{\left(\frac{dx}{dy}\right)^5} \left\{ 3 \left(\frac{d^2x}{dy^2}\right)^2 - \frac{dx}{dy} \frac{d^3x}{dy^3} \right\}, \quad \&c.$$

The formulæ for the change of the independent variable were given for the first time in the *Traité des infiniment petites* of L'Hôpital. The general theory of transformation was discussed at considerable extent by Euler in his *Calc. Diff.*

In the case of two independent variables, suppose we are given

$$x = \phi(r, \theta), \quad y = \psi(r, \theta).$$

Then

$$\begin{aligned} \frac{dv}{dr} &= \frac{dv}{dx} \frac{dx}{dr} + \frac{dv}{dy} \frac{dy}{dr}; \\ \frac{dv}{d\theta} &= \frac{dv}{dx} \frac{dx}{d\theta} + \frac{dv}{dy} \frac{dy}{d\theta}. \end{aligned}$$



Hence 
$$\frac{dv}{dx} = \frac{\frac{dv}{d\theta} \frac{d\theta}{dr} - \frac{dv}{dr} \frac{d\theta}{d\theta}}{\frac{dx}{d\theta} \frac{d\theta}{dr} - \frac{dx}{dr} \frac{d\theta}{d\theta}};$$

$$\frac{dv}{dy} = \frac{\frac{dv}{d\theta} \frac{d\theta}{dr} - \frac{dv}{dr} \frac{d\theta}{d\theta}}{\frac{dy}{d\theta} \frac{d\theta}{dr} - \frac{dy}{dr} \frac{d\theta}{d\theta}}.$$

In like manner  $\frac{d^2v}{dx^2}$ ,  $\frac{d^2v}{dy^2}$  can be deduced, but their general values are too complicated for insertion here.

A case which commonly arises is in the transformation from rectangular to polar coordinates.

In this case, we have  $x = r \cos \theta$ ,  $y = r \sin \theta$ , and

$$\frac{dv}{dx} = \cos \theta \frac{dv}{dr} - \frac{\sin \theta}{r} \frac{dv}{d\theta},$$

$$\frac{dv}{dy} = \sin \theta \frac{dv}{dr} + \frac{\cos \theta}{r} \frac{dv}{d\theta}.$$

Hence 
$$\frac{d^2v}{dx^2} = \left( \cos \theta \frac{d}{dr} - \frac{\sin \theta}{r} \frac{d}{d\theta} \right) \left( \cos \theta \frac{dv}{dr} - \frac{\sin \theta}{r} \frac{dv}{d\theta} \right)$$

$$= \cos^2 \theta \frac{d^2v}{dr^2} + \frac{2 \sin \theta \cos \theta}{r} \left( \frac{1}{r} \frac{dv}{d\theta} - \frac{d^2v}{dr d\theta} \right)$$

$$+ \frac{\sin^2 \theta}{r^2} \frac{d^2v}{d\theta^2}.$$

The corresponding value of  $\frac{d^2v}{dy^2}$  is got by substituting  $\frac{\pi}{2} - \theta$  instead of  $\theta$  in the last equation. Hence we easily find

$$\frac{d^2v}{dx^2} + \frac{d^2v}{dy^2} = \frac{d^2v}{dr^2} + \frac{1}{r} \frac{dv}{dr} + \frac{1}{r^2} \frac{d^2v}{d\theta^2}.$$

95. Another important case, which is of extensive application in geometry, is that of linear transformations.

Let us consider the case of three variables, and suppose

$$x = aX + bY + cZ, \quad y = a'X + b'Y + c'Z, \quad z = a''X + b''Y + c''Z,$$

then 
$$\frac{dv}{dX} = a \frac{dv}{dx} + a' \frac{dv}{dy} + a'' \frac{dv}{dz},$$

$$\frac{dv}{dY} = b \frac{dv}{dx} + b' \frac{dv}{dy} + b'' \frac{dv}{dz},$$

$$\frac{dv}{dZ} = c \frac{dv}{dx} + c' \frac{dv}{dy} + c'' \frac{dv}{dz}.$$

$$\frac{d^2v}{dX^2} = \left( a \frac{d}{dx} + a' \frac{d}{dy} + a'' \frac{d}{dz} \right)^2 v$$

$$= a^2 \frac{d^2v}{dx^2} + 2a a' \frac{d^2v}{dx dy} + 2a a'' \frac{d^2v}{dx dz} + 2a' a'' \frac{d^2v}{dy dz}$$

$$+ a'^2 \frac{d^2v}{dy^2} + a''^2 \frac{d^2v}{dz^2}.$$

Again, if we suppose  $x', y', z'$  to be transformed by a similar substitution, i.e.,

$$x' = aX' + bY' + cZ', \quad y' = a'X' + b'Y' + c'Z', \quad \&c.,$$

then, if any function  $u = \phi(x, y, z)$  transform into  $\phi_1(X', Y', Z')$ , we shall have

$$\phi(x + kx', y + ky', z + kz') = \phi_1(X + kX', Y + kY', Z + kZ').$$

If these be expanded, and like powers of  $k$  at both sides be equated, we have

$$\left( x' \frac{d}{dx} + y' \frac{d}{dy} + z' \frac{d}{dz} \right) u = \left( X' \frac{d}{dX} + Y' \frac{d}{dY} + Z' \frac{d}{dZ} \right) u.$$

$$\left( x' \frac{d}{dx} + y' \frac{d}{dy} + z' \frac{d}{dz} \right)^2 u = \left( X' \frac{d}{dX} + Y' \frac{d}{dY} + Z' \frac{d}{dZ} \right)^2 u, \quad \&c.$$

Consequently the functions  $x' \frac{du}{dx} + y' \frac{du}{dy} + z' \frac{du}{dz}$ , &c., are unaltered by linear transformation. These functions have important geometrical relations with the original function. Many applications of these principles will be found in Salmon's *Higher Plane Curves*, as also in his *Geometry of Three Dimensions*.

A few additional examples are added for illustration.

(1) If  $x = \tan \theta$ ,

$$\frac{d^2y}{dx^2} + \frac{2x}{1+x^2} \frac{dy}{dx} + \frac{y}{(1+x^2)^2} = 0$$

transforms into

$$\frac{d^2y}{d\theta^2} + y = 0.$$

(2) If  $z$  be a function of  $x$  and  $y$ , and  $u = px + qy - z$ , prove that when  $p$  and  $q$  are taken as independent variables we have

$$\frac{du}{dp} = x, \quad \frac{du}{dq} = y, \quad \frac{d^2u}{dp^2} = \frac{1}{r^2 - s^2}, \quad \frac{d^2u}{dp dq} = \frac{-s}{r^2 - s^2}, \quad \frac{d^2u}{dq^2} = \frac{r}{r^2 - s^2},$$

where  $p, q, r, s, t$  denote the partial differential coefficients of  $z$  with respect to  $x$  and  $y$ , of the first and second orders.

(3) In the linear transformations in § 95 the determinant  $(ab'c'')$  is called the *modulus* of transformation, and the transformation is said to be *orthogonal* when

$$x^2 + y^2 + z^2 = X^2 + Y^2 + Z^2.$$

In this case the determinant

$$\begin{vmatrix} \frac{d^2u}{dx^2} & \frac{d^2u}{dx dy} & \frac{d^2u}{dx dz} \\ \frac{d^2u}{dx dy} & \frac{d^2u}{dy^2} & \frac{d^2u}{dy dz} \\ \frac{d^2u}{dx dz} & \frac{d^2u}{dy dz} & \frac{d^2u}{dz^2} \end{vmatrix}$$

is unaltered by the transformation.

*Jacobians.*

96. We now proceed to a short treatment of a remarkable class of determinants first studied by Jacobi (*De determinantibus functionalibus*, Crelle, 1841), in developing important generalizations of the fundamental principles of the differential and integral calculus.

If  $u_1, u_2, u_3, \dots, u_n$  be functions of  $n$  independent variables  $x_1, x_2, x_3, \dots, x_n$ , then the following determinant

$$\begin{vmatrix} \frac{du_1}{dx_1} & \frac{du_1}{dx_2} & \frac{du_1}{dx_3} & \dots & \frac{du_1}{dx_n} \\ \frac{du_2}{dx_1} & \frac{du_2}{dx_2} & \frac{du_2}{dx_3} & \dots & \frac{du_2}{dx_n} \\ \dots & \dots & \dots & \dots & \dots \\ \frac{du_n}{dx_1} & \frac{du_n}{dx_2} & \frac{du_n}{dx_3} & \dots & \frac{du_n}{dx_n} \end{vmatrix}$$

was called a *functional determinant* by Jacobi. Such determinants are now more usually known as *Jacobians*, a designation introduced by Professor Sylvester, who largely developed their properties, and gave numerous applications of them in higher algebra, as also in curves and surfaces.

The preceding determinant is frequently represented by the abridged notation

$$\frac{d(u_1, u_2, \dots, u_n)}{d(x_1, x_2, \dots, x_n)}.$$

The following discussion, for brevity, is limited for the most part to the case of three variables, but it can be readily extended to any number.

97. Altering the notation, we suppose  $u, v, w$  to represent functions of three independent variables,  $x, y, z$ ; then (Bertrand, *Liouville's Journal*, 1851), if we attribute to each variable an infinitely small increment, there will result a corresponding increment for each of the functions. If now we choose arbitrarily a number of different systems of increments, there will result a corresponding number of systems of increments for the functions.

Accordingly, representing the increments of  $x$  by  $d_1x, d_2x, d_3x$ , and similarly for the other variables, we shall have

$$d_1u = \frac{du}{dx} d_1x + \frac{du}{dy} d_1y + \frac{du}{dz} d_1z,$$

$$d_2u = \frac{du}{dx} d_2x + \frac{du}{dy} d_2y + \frac{du}{dz} d_2z,$$

$$d_3u = \frac{du}{dx} d_3x + \frac{du}{dy} d_3y + \frac{du}{dz} d_3z.$$

Consequently, by the fundamental rule for the multiplication of determinants, we shall have

$$\begin{vmatrix} d_1u & d_1v & d_1w \\ d_2u & d_2v & d_2w \\ d_3u & d_3v & d_3w \end{vmatrix} = \begin{vmatrix} d_1x & d_1y & d_1z \\ d_2x & d_2y & d_2z \\ d_3x & d_3y & d_3z \end{vmatrix} \times \begin{vmatrix} \frac{du}{dx} & \frac{du}{dy} & \frac{du}{dz} \\ \frac{dv}{dx} & \frac{dv}{dy} & \frac{dv}{dz} \\ \frac{dw}{dx} & \frac{dw}{dy} & \frac{dw}{dz} \end{vmatrix}$$

Let the first determinant be represented by (A), the second by (B), and the third, or *Jacobian*, by J, and we get  $J = \frac{A}{B}$ . That is to say, the Jacobian is the ratio of the determinant of the system of infinitesimal increments of the functions to that of the increments of the variables.

This may be regarded as a generalization of the definition of the derived function in the case of a single variable.

98. Again, when the functions  $u, v, w$  are connected by any relation their *Jacobian* vanishes.

For suppose  $u, v, w$  to be connected by an equation

$$F(u, v, w) = 0.$$

for all values of  $x, y, z$ ; then, since in this case

$$\frac{dF}{dx} = 0, \quad \frac{dF}{dy} = 0, \quad \frac{dF}{dz} = 0,$$

we have

$$\begin{aligned} \frac{dF}{du} \frac{du}{dx} + \frac{dF}{dv} \frac{dv}{dx} + \frac{dF}{dw} \frac{dw}{dx} &= 0, \\ \frac{dF}{du} \frac{du}{dy} + \frac{dF}{dv} \frac{dv}{dy} + \frac{dF}{dw} \frac{dw}{dy} &= 0, \\ \frac{dF}{du} \frac{du}{dz} + \frac{dF}{dv} \frac{dv}{dz} + \frac{dF}{dw} \frac{dw}{dz} &= 0. \end{aligned}$$

Consequently, eliminating

$$\frac{dF}{du}, \quad \frac{dF}{dv}, \quad \frac{dF}{dw},$$

we get

$$\begin{vmatrix} \frac{du}{dx} & \frac{du}{dy} & \frac{du}{dz} \\ \frac{dv}{dx} & \frac{dv}{dy} & \frac{dv}{dz} \\ \frac{dw}{dx} & \frac{dw}{dy} & \frac{dw}{dz} \end{vmatrix} = 0.$$

This is an extension of the theorem that when a function of a single variable is constant its derived function is zero.

The converse of the preceding theorem can be established, viz., if  $J=0$ , then the functions  $u, v, w$  are no longer independent of each other.

These results are readily extended to any number of variables; thus, when the functions  $u_1, u_2, \dots, u_n$  are connected by a relation,  $\frac{d(u_1, u_2, \dots, u_n)}{d(x_1, x_2, \dots, x_n)} = 0$ ; and conversely.

99. Again, if  $u, v, w$ , instead of being given explicitly in terms of  $x, y, z$ , be given implicitly, i.e., if they are connected with them by three equations of the form

$$F_1(x, y, z, u, v, w) = 0, \quad F_2(x, y, z, u, v, w) = 0, \quad F_3(x, y, z, u, v, w) = 0,$$

we have, adopting the same notation as before,

$$\frac{dF_1}{dx} dx + \frac{dF_1}{dy} dy + \frac{dF_1}{dz} dz + \frac{dF_1}{du} du + \frac{dF_1}{dv} dv + \frac{dF_1}{dw} dw = 0,$$

or

$$\frac{dF_1}{dx} dx + \frac{dF_1}{dy} dy + \frac{dF_1}{dz} dz = -\frac{dF_1}{du} du - \frac{dF_1}{dv} dv - \frac{dF_1}{dw} dw,$$

and similar equations for the increments  $d_2x, \dots, d_3x$ , &c. . . ., as also others derived from the functions  $F_2, F_3, \dots$ . Hence, as before,

$$\begin{vmatrix} d_1x & d_1y & d_1z \\ d_2x & d_2y & d_2z \\ d_3x & d_3y & d_3z \end{vmatrix} \times \begin{vmatrix} \frac{dF_1}{dx} & \frac{dF_1}{dy} & \frac{dF_1}{dz} \\ \frac{dF_2}{dx} & \frac{dF_2}{dy} & \frac{dF_2}{dz} \\ \frac{dF_3}{dx} & \frac{dF_3}{dy} & \frac{dF_3}{dz} \end{vmatrix} \\ = - \begin{vmatrix} d_1u & d_1v & d_1w \\ d_2u & d_2v & d_2w \\ d_3u & d_3v & d_3w \end{vmatrix} \times \begin{vmatrix} \frac{dF_1}{du} & \frac{dF_1}{dv} & \frac{dF_1}{dw} \\ \frac{dF_2}{du} & \frac{dF_2}{dv} & \frac{dF_2}{dw} \\ \frac{dF_3}{du} & \frac{dF_3}{dv} & \frac{dF_3}{dw} \end{vmatrix}$$

This result, when generalized, may be written as follows:—

$$\frac{d(u_1, u_2, \dots, u_n)}{d(x_1, x_2, \dots, x_n)} = (-1)^n \begin{vmatrix} \frac{dF_1}{dx_1} & \dots & \frac{dF_1}{dx_n} \\ \frac{dF_2}{dx_1} & \dots & \frac{dF_2}{dx_n} \\ \dots & \dots & \dots \\ \frac{dF_n}{dx_1} & \dots & \frac{dF_n}{dx_n} \end{vmatrix} \div \begin{vmatrix} \frac{dF_1}{du_1} & \dots & \frac{dF_1}{du_n} \\ \frac{dF_2}{du_1} & \dots & \frac{dF_2}{du_n} \\ \dots & \dots & \dots \\ \frac{dF_n}{du_1} & \dots & \frac{dF_n}{du_n} \end{vmatrix}$$

100. We shall next consider the generalization of the elementary theorem  $\frac{dF(u)}{dx} = \frac{dF(u)}{du} \frac{du}{dx}$ .

If we suppose  $\phi_1, \phi_2, \phi_3$  to represent functions of  $u, v, w$ , while  $u, v, w$  are functions of  $x, y, z$ , then, adopting the same notation as before, and representing the determinant

$$\begin{vmatrix} d_1\phi_1 & d_1\phi_2 & d_1\phi_3 \\ d_2\phi_1 & d_2\phi_2 & d_2\phi_3 \\ d_3\phi_1 & d_3\phi_2 & d_3\phi_3 \end{vmatrix}$$

by C, we have by § 97

$$\begin{vmatrix} \frac{d\phi_1}{dx} & \frac{d\phi_1}{dy} & \frac{d\phi_1}{dz} \\ \frac{d\phi_2}{dx} & \frac{d\phi_2}{dy} & \frac{d\phi_2}{dz} \\ \frac{d\phi_3}{dx} & \frac{d\phi_3}{dy} & \frac{d\phi_3}{dz} \end{vmatrix} = \frac{C}{B};$$

and similarly

$$\begin{vmatrix} \frac{d\phi_1}{du} & \frac{d\phi_1}{dv} & \frac{d\phi_1}{dw} \\ \frac{d\phi_2}{du} & \frac{d\phi_2}{dv} & \frac{d\phi_2}{dw} \\ \frac{d\phi_3}{du} & \frac{d\phi_3}{dv} & \frac{d\phi_3}{dw} \end{vmatrix} = \frac{C}{A}.$$

Hence

$$\begin{vmatrix} \frac{d\phi_1}{dx} & \frac{d\phi_1}{dy} & \frac{d\phi_1}{dz} \\ \frac{d\phi_2}{dx} & \frac{d\phi_2}{dy} & \frac{d\phi_2}{dz} \\ \frac{d\phi_3}{dx} & \frac{d\phi_3}{dy} & \frac{d\phi_3}{dz} \end{vmatrix} = \begin{vmatrix} \frac{d\phi_1}{du} & \frac{d\phi_1}{dv} & \frac{d\phi_1}{dw} \\ \frac{d\phi_2}{du} & \frac{d\phi_2}{dv} & \frac{d\phi_2}{dw} \\ \frac{d\phi_3}{du} & \frac{d\phi_3}{dv} & \frac{d\phi_3}{dw} \end{vmatrix} \begin{vmatrix} \frac{du}{dx} & \frac{du}{dy} & \frac{du}{dz} \\ \frac{dv}{dx} & \frac{dv}{dy} & \frac{dv}{dz} \\ \frac{dw}{dx} & \frac{dw}{dy} & \frac{dw}{dz} \end{vmatrix}.$$

Consequently, the Jacobian of  $\phi_1, \phi_2, \phi_3$  with respect to  $x, y, z$  is equal to their Jacobian with respect to  $u, v, w$  multiplied by the Jacobian of  $u, v, w$  with respect to  $x, y, z$ .

This is the required generalization in the case of three variables. 101. Again, if  $u, v, w$  be functions of  $x, y, z$ , we may regard  $x, y, z$  as functions of  $u, v, w$ ; and it follows immediately that the Jacobian of  $u, v, w$  with respect to  $x, y, z$  is the reciprocal of the Jacobian of  $x, y, z$  with respect to  $u, v, w$ ; i.e.

$$\begin{vmatrix} \frac{du}{dx} & \frac{du}{dy} & \frac{du}{dz} \\ \frac{dv}{dx} & \frac{dv}{dy} & \frac{dv}{dz} \\ \frac{dw}{dx} & \frac{dw}{dy} & \frac{dw}{dz} \end{vmatrix} \begin{vmatrix} \frac{dx}{du} & \frac{dx}{dv} & \frac{dx}{dw} \\ \frac{dy}{du} & \frac{dy}{dv} & \frac{dy}{dw} \\ \frac{dz}{du} & \frac{dz}{dv} & \frac{dz}{dw} \end{vmatrix} = 1.$$

This, when extended to  $n$  variables, is the generalization of the theorem that the derived function of  $y$  with respect to  $x$  is the inverse of that of  $x$  with respect to  $y$ .

The preceding demonstrations are readily extended to any number of variables. When generalized for  $n$  variables, the results are written in abridged notation thus—

$$\frac{d(\phi_1, \phi_2, \dots, \phi_n)}{d(x_1, x_2, \dots, x_n)} = \frac{d(\phi_1, \phi_2, \dots, \phi_n)}{d(u_1, u_2, \dots, u_n)} \times \frac{d(u_1, u_2, \dots, u_n)}{d(x_1, x_2, \dots, x_n)}$$

and 
$$\frac{d(u_1, u_2, \dots, u_n)}{d(x_1, x_2, \dots, x_n)} \times \frac{d(x_1, x_2, \dots, x_n)}{d(u_1, u_2, \dots, u_n)} = 1$$

102. Again, the Jacobian of any system can be expressed as a monomial. This result can be established as follows:—

Reverting to our original discussion, it is readily seen that of  $2n$  quantities,  $x_1, x_2, x_3, \dots, x_n, u_1, u_2, u_3, \dots, u_n$ , connected by  $n$  equations, when any  $n$  are chosen at pleasure the others are capable of determination. Consequently, if  $n-1$  of them be supposed to remain invariable, all the others may be regarded as changing simultaneously, and the ratios of their infinitely small increments are determined. Hence we may suppose our  $n$  systems of simultaneous increments attributed as in the following table:—

$$\begin{matrix} d_1x_1 & d_1x_2 & \dots & d_1x_n & d_1u_1 & 0 & 0 & 0 \\ 0 & d_2x_2 & \dots & d_2x_n & d_2u_1 & d_2u_2 & 0 & 0 \\ 0 & 0 & d_3x_3 & d_3x_n & d_3u_1 & d_3u_2 & d_3u_3 & 0 \\ \dots & \dots & \dots & \dots & \dots & \dots & \dots & \dots \\ 0 & 0 & 0 & d_nx_n & d_nu_1 & d_nu_2 & \dots & d_nu_n \end{matrix}$$

The first line indicates that the first system of increments attributed to  $x_1, x_2, \dots, x_n$  are such that  $u_2, u_3, \dots, u_n$  do not change; in the second line we suppose that increments of the second system are such that  $x_1, u_3, \dots, u_n$  do not change; and so on.

Again, since for these values the determinants A, B, reduce to their diagonal terms, we have, in this case, by § 97,

$$J = \frac{d_1u_1}{d_1x_1} \cdot \frac{d_2u_2}{d_2x_2} \cdot \frac{d_3u_3}{d_3x_3} \cdot \dots \cdot \frac{d_nu_n}{d_nx_n}$$

Also, by what has been stated above, the ratios

$$\frac{d_1u_1}{d_1x_1}, \quad \frac{d_2u_2}{d_2x_2}, \quad \frac{d_3u_3}{d_3x_3}, \quad \dots \quad \frac{d_nu_n}{d_nx_n},$$

can each be determined in this case from the given equations.

Consequently the Jacobian of our system is the continued product of

$$\frac{du_1}{dx_1}, \frac{du_2}{dx_2}, \dots, \frac{du_n}{dx_n}.$$

In order to calculate  $\frac{du_1}{dx_1}$  it is necessary to express  $u_1$  as a function of  $x_1, u_2, \dots, u_n$ ; and similarly for  $u_2, u_3, \&c.$

103. For example, let it be required to find the Jacobian of the system

$$\begin{aligned} x_1 &= r \cos \theta_1, \\ x_2 &= r \sin \theta_1 \cos \theta_2, \\ x_3 &= r \sin \theta_1 \sin \theta_2 \cos \theta_3, \\ &\dots \\ x_{n-1} &= r \sin \theta_1 \sin \theta_2 \dots \cos \theta_{n-1}, \\ x_n &= r \sin \theta_1 \sin \theta_2 \dots \sin \theta_{n-1}. \end{aligned}$$

Here, squaring and adding, we get

$$x_1^2 + x_2^2 + \dots + x_n^2 = r^2.$$

We shall employ this instead of the last equation of Hence, adopting the conditions laid down in § 102, we get

$$\frac{dx_1}{d\theta_1} = -r \sin \theta_1, \quad \frac{dx_2}{d\theta_2} = -r \sin \theta_1 \sin \theta_2, \dots \&c., \quad \frac{dx_n}{dr} = \frac{r}{x_n}.$$

Accordingly, the Jacobian of the system is

$$\begin{aligned} &(-1)^{n-1} \frac{r^n \sin^{n-1} \theta_1 \sin^{n-2} \theta_2 \dots \sin \theta_{n-1}}{x_n} \\ &= (-1)^{n-1} r^{n-1} \sin^{n-2} \theta_1 \sin^{n-3} \theta_2 \dots \sin \theta_{n-2}. \end{aligned}$$

104. Again, suppose  $u_1, u_2, \dots, u_n$  to be the partial derived functions of a given function of the variables  $x_1, x_2, \dots, x_n$ ; i.e., let

$$u_1 = \frac{df}{dx_1}, \quad u_2 = \frac{df}{dx_2}, \quad \dots, \quad u_n = \frac{df}{dx_n}.$$

The Jacobian becomes

$$\begin{vmatrix} \frac{d^2f}{dx_1^2} & \frac{d^2f}{dx_1 dx_2} & \dots & \frac{d^2f}{dx_1 dx_n} \\ \frac{d^2f}{dx_2 dx_1} & \frac{d^2f}{dx_2^2} & \dots & \frac{d^2f}{dx_2 dx_n} \\ \dots & \dots & \dots & \dots \\ \frac{d^2f}{dx_n dx_1} & \frac{d^2f}{dx_n dx_2} & \dots & \frac{d^2f}{dx_n^2} \end{vmatrix}$$

Such a determinant is called the *Hessian* of the function  $f(x_1, x_2, \dots, x_n)$ , after Hesse, who first introduced such determinants into analysis, applying them in many investigations of fundamental importance in the theory of curves and surfaces.

105. Again, in the Jacobian

$$\frac{d(y_1, y_2, \dots, y_n)}{d(x_1, x_2, \dots, x_n)},$$

if the functions  $y_1, y_2, \dots$  are fractions with the same denominator, i.e., such that

$$y_1 = \frac{u_1}{u}, \quad y_2 = \frac{u_2}{u}, \quad \dots, \quad y_n = \frac{u_n}{u},$$

we have

$$\begin{aligned} u^2 \frac{dy_1}{dx_k} &= u \frac{du_1}{dx_k} - u_1 \frac{du}{dx_k}, \\ u^2 \frac{dy_2}{dx_k} &= u \frac{du_2}{dx_k} - u_2 \frac{du}{dx_k}, \\ &\dots \\ u^2 \frac{dy_n}{dx_k} &= u \frac{du_n}{dx_k} - u_n \frac{du}{dx_k}. \end{aligned}$$

Hence

$$u^{2n+1} \frac{d(y_1, y_2, \dots, y_n)}{d(x_1, x_2, \dots, x_n)} = \begin{vmatrix} u, & 0, & \dots, & 0, \\ u_1, & u \frac{du_1}{dx_1} - u_1 \frac{du}{dx_1}, & \dots, & u \frac{du_1}{dx_n} - u_1 \frac{du}{dx_n} \\ \dots & \dots & \dots & \dots \\ u_n, & u \frac{du_n}{dx_1} - u_n \frac{du}{dx_1}, & \dots, & u \frac{du_n}{dx_n} - u_n \frac{du}{dx_n} \end{vmatrix}.$$

From this, by elementary properties of determinants, we get

$$u^{2n+1} \frac{d(y_1, y_2, \dots, y_n)}{d(x_1, x_2, \dots, x_n)} = \begin{vmatrix} u, & u \frac{du}{dx_1}, & \dots, & u \frac{du}{dx_n} \\ u_1, & u \frac{du_1}{dx_1}, & \dots, & u \frac{du_1}{dx_n} \\ \dots & \dots & \dots & \dots \\ u_n, & u \frac{du_n}{dx_1}, & \dots, & u \frac{du_n}{dx_n} \end{vmatrix}.$$

Hence

$$\frac{d(y_1, y_2, \dots, y_n)}{d(x_1, x_2, \dots, x_n)} = \frac{1}{u^{n+1}} \begin{vmatrix} u & u_1 & \dots & u_n \\ \frac{du}{dx_1} & \frac{du_1}{dx_1} & \dots & \frac{du_n}{dx_1} \\ \dots & \dots & \dots & \dots \\ \frac{du}{dx_n} & \frac{du_1}{dx_n} & \dots & \frac{du_n}{dx_n} \end{vmatrix}.$$

This latter determinant has been denoted by  $K(u, u_1, \dots, u_n)$ . It possesses interesting properties. For example, if  $u, u_1, \dots, u_n$  are connected by any homogeneous relation, then

$$K(u, u_1, \dots, u_n) = 0.$$

This follows from § 98, since the quantities  $y_1, y_2, \dots, y_n$  are in this case connected by an equation.

It is seen without difficulty that Jacobians and Hessians are covariants. That is, if the functions be transformed by linear substitution (§ 95), the Jacobian of the transformed functions is equal to the original Jacobian multiplied by the modulus of transformation; and similarly the Hessian of the transformed function is equal to that of the original function multiplied by the square of the modulus. It can also be seen that, when the transformation is *orthogonal*, the Jacobian and Hessian are unaltered by the transformation.

PART II.

INTEGRAL CALCULUS.

106. The integral calculus may be said to have taken its origin from the methods employed by Cavalieri, Wallis, and others, for the determination of the quadrature of curves and the cubature of surfaces. These methods, as we have seen, consisted in the division of the required area, or volume, into an indefinite number of thin slices, or "elements"; and then from the law connecting their successive values the sum of all the elements was determined—or rather the "limit" to which that sum approached when the number of elements was indefinitely increased. The processes thus employed were developed and reduced to a suitable notation by Newton and Leibnitz. Thus, adopting the more modern nomenclature, if  $\phi(x)$  be a function of  $x$  which is finite for all values of  $x$  between the limits  $x_0$  and  $X$ , and if we suppose the interval  $X - x_0$  divided into  $n$  parts,  $x_1 - x_0, x_2 - x_1, x_3 - x_2, \dots, X - x_{n-1}$ , then, multiplying each element by the corresponding value of the function, i.e.,  $x_1 - x_0$  by  $\phi(x_0)$ , &c., the sum

$$S = (x_1 - x_0)\phi(x_0) + (x_2 - x_1)\phi(x_1) + \dots + (X - x_{n-1})\phi(x_{n-1})$$

has, by elementary algebra, a finite value, which may be represented by  $(X - x_0)\phi(\xi)$ , where  $\phi(\xi)$  lies between the greatest and the least value  $\phi(x)$  admits of between the limits.

If, now, we suppose the number of elements increase beyond limit, so that  $x_1 - x_0, x_2 - x_1, \&c.$ , may be regarded as each becoming indefinitely small, then ultimately the value of  $S$  attains to a certain limit, which depends only on the form of the function  $\phi(x)$ , and on the extreme values  $X$  and  $x_0$ . In this stage, introducing the symbol of integration  $\int$ , and adopting the notation  $\int_{x_0}^X \phi(x) dx$ , instead of  $S$ , we write

$$\int_{x_0}^X \phi(x) dx = \lim. \left[ (x_1 - x_0)\phi(x_0) + (x_2 - x_1)\phi(x_1) + \dots + (X - x_{n-1})\phi(x_{n-1}) \right] = (X - x_0)\phi \int_{x_0}^X \theta(X - x_0) \},$$

in which  $\theta$  lies between 0 and 1.

For greater simplicity, it is usual to suppose that the increments  $x_1 - x_0, x_2 - x_1, \dots, X - x_{n-1}$  are all equal. In this case their common value  $h$  is equal to the fraction  $\frac{X - x_0}{n}$ ; and  $S$  becomes

$$h \{ f(x_0) + f(x_0 + h) + f(x_0 + 2h) + \dots + f(X - 2h) + f(X - h) \}.$$

Again  $f \{ x_0 + \theta(X - x_0) \}$  represents the *mean* value of  $f(x)$ , as  $x$  proceeds by equal infinitesimal increments from the value  $x_0$  to  $X$ . The application of the integral calculus to the solution of questions on mean or average values is founded on the result here given. Thus, denoting the mean value of  $\phi(x)$ , between the limits  $X$  and  $x_0$ , by  $M\phi(x)$ , we have

$$M\phi(x) = \frac{1}{X - x_0} \int_{x_0}^X \phi(x) dx.$$

107. If in the definite integral  $\int_{x_0}^X \phi(x) dx$  the upper limit  $X$  be conceived to vary,  $x_0$  remaining constant, the integral itself will vary; and if we replace  $X$ , regarded as variable, by  $x$ , the integral may be regarded as a new function,  $F(x)$ , of  $x$ , determined by the equation

$$F(x) = \int_{x_0}^x \phi(x) dx = (x - x_0)\phi \left[ x_0 + \theta(x - x_0) \right].$$

This function vanishes when  $x = x_0$ ;  $\therefore F(x_0) = 0$ .

Also, by the differential calculus (§ 46) we have

$$F(x) = (x - x_0)F' \left[ x_0 + \theta(x - x_0) \right].$$

Consequently

$$\phi \left[ x_0 + \theta(x - x_0) \right] = F' \left[ x_0 + \theta(x - x_0) \right].$$

Again, making  $x = x_0$ , we get

$$\phi(x_0) = F'(x_0);$$



and, since  $x_0$  may have any value, we have in general

$$\phi(x) = F'(x).$$

Accordingly we may write

$$\int_{x_0}^X F'(x) dx = F(X) - F(x_0).$$

Hence the process of integration is reduced to the determination of a function  $F(x)$  when its derived function  $F'(x)$  is known.

We shall illustrate these preliminary remarks by one or two examples.

Ex. 1. Find the limit of the sum of the series

$$\frac{n}{n^2+1^2} + \frac{n}{n^2+2^2} + \dots + \frac{n}{n^2+2n^2},$$

when  $n$  is indefinitely increased.

Let  $dx = \frac{1}{n}$ , and the limit of the series is easily seen to be represented by

$$\int_0^1 \frac{dx}{1+x^2}, \text{ or is } \frac{\pi}{4} \text{ since } \frac{d}{dx} (\tan^{-1} x) = \frac{1}{1+x^2}$$

Ex. 2. Find the limit of the sum

$$\frac{1}{\sqrt{n^2-1^2}} + \frac{1}{\sqrt{n^2-2^2}} + \frac{1}{\sqrt{n^2-3^2}} + \dots + \frac{1}{\sqrt{n^2-(n-1)^2}},$$

when  $n$  is indefinitely increased.

Here the required limit =  $\int_0^1 \frac{dx}{\sqrt{1-x^2}} = \frac{\pi}{2}$ .

108. We might have started from the preceding result as the definition of the integral calculus, and regarded this calculus as the inverse of the differential. Thus, as in the differential calculus we investigate the rules for proceeding from any primitive function  $F(x)$  to its derived function  $F'(x)$ , so in the integral calculus our object is the converse, viz., to determine  $F(x)$  when  $F'(x)$  is given; or, in the language of Newton, "to find the fluent of a given fluxion."

It may be here remarked that it has been shown from geometrical considerations, in § 23, that such a function always exists.

In the differential calculus rules have been laid down for the method of determining the differential of any function. There are, however, no direct rules for the inverse process, except by retracing the steps by which the derived has been deduced from the original function.

Accordingly, the integral calculus is based on the differential, and to each result in the differential calculus corresponds another in the integral. Moreover, as  $F(x)$  and  $F(x) + C$  (where  $C$  is any arbitrary quantity that does not vary with  $x$ ) have the same differential, it follows that to find the general integral of  $F'(x) dx$  we must add an arbitrary constant to  $F(x)$ .

109. The following elementary integrals (omitting arbitrary constants) are easily arrived at, and are called fundamental integrals, to which all others that admit of integration in finite terms are ultimately reducible—excluding higher transcendental functions:—

$$\begin{aligned} \int x^n dx &= \frac{x^{n+1}}{n+1}, \quad \int \frac{dx}{x} = \log x, \\ \int \sin x dx &= -\cos x, \quad \int \cos x dx = \sin x, \\ \int \frac{dx}{\cos^2 x} &= \tan x, \quad \int \frac{dx}{\sin^2 x} = -\cot x, \\ \int \frac{dx}{\sqrt{a^2-x^2}} &= \sin^{-1} \frac{x}{a}, \quad \int \frac{dx}{\sqrt{a^2+x^2}} = \log(x + \sqrt{a^2+x^2}), \\ \int \frac{dx}{a^2+x^2} &= \frac{1}{a} \tan^{-1} \frac{x}{a}, \quad \int a^x dx = \frac{a^x}{\log a}. \end{aligned}$$

110. A number of integrals can readily be reduced to one or other of the above forms. A few elementary cases, such as frequently occur in practice, are here given. We commence with the integral

$$(1) \quad \int \frac{dx}{(x-a)(x-\beta)},$$

Here  $\frac{1}{(x-a)(x-\beta)} = \frac{1}{a-\beta} \left( \frac{1}{x-a} - \frac{1}{x-\beta} \right)$ .

$$\therefore \int \frac{dx}{(x-a)(x-\beta)} = \frac{1}{a-\beta} \log \frac{x-a}{x-\beta}.$$

$$(2) \text{ More generally, the integral } \int \frac{dx}{a+2bx+cx^2}$$

may be written in the form

$$\int \frac{dx}{(cx+b)^2 + ac - b^2},$$

or, substituting  $z$  for  $cx+b$ .

$$\int \frac{dz}{z^2 + ac - b^2}.$$

The form of this integral depends on the sign of  $ac - b^2$ .

If  $ac - b^2 > 0$ , we have

$$\int \frac{dx}{a+2bx+cx^2} = \frac{1}{\sqrt{ac-b^2}} \tan^{-1} \frac{cx+b}{\sqrt{ac-b^2}}.$$

If  $ac - b^2 = 0$ .

$$\int \frac{dx}{a+2bx+cx^2} = \frac{-1}{cx+b}$$

If  $ac - b^2 < 0$ , the integral comes under (1), and we have

$$\int \frac{dx}{a+2bx+cx^2} = \frac{1}{2\sqrt{b^2-ac}} \log \frac{cx+b-\sqrt{b^2-ac}}{cx+b+\sqrt{b^2-ac}}.$$

(3) Again, since

$$\frac{l+mx}{a+2bx+cx^2} = \frac{m}{c} \frac{b+cx}{a+2bx+cx^2} + \frac{lc-mb}{c} \frac{1}{a+2bx+cx^2}$$

we have

$$\int \frac{(l+mx)dx}{a+2bx+cx^2} = \frac{m}{c} \int \frac{(b+cx)dx}{a+2bx+cx^2} + \frac{lc-mb}{c} \int \frac{dx}{a+2bx+cx^2}.$$

The integral of  $\frac{(b+cx)dx}{a+2bx+cx^2}$  is  $\frac{1}{2} \log(a+2bx+cx^2)$ , and the latter integral has been obtained in (2).

$$(4) \text{ Next, to find } \int \frac{dx}{\sin x \cos x}.$$

$$\text{Here } \int \frac{dx}{\sin x \cos x} = \int \frac{1}{\tan x \cos^2 x} dx = \int \frac{d(\tan x)}{\tan x} = \log(\tan x).$$

In like manner,

$$(5) \quad \int \frac{dx}{\sin x} = \int \frac{d\left(\frac{x}{2}\right)}{\sin \frac{x}{2} \cos \frac{x}{2}} = \log\left(\tan \frac{x}{2}\right).$$

$$\text{Hence we get } \int \frac{dx}{\cos x} = \log \cdot \tan\left(\frac{x}{2} + \frac{\pi}{4}\right).$$

$$(6) \text{ Again } \int \tan^2 x dx = \int \sec^2 x dx - \int dx = \tan x - x.$$

111. The number of independent fundamental formulae must ultimately be the same as the number of independent kinds of functions in analysis. The ordinary elementary functions may be briefly classed as follows:—(1) algebraic functions, powers and roots, such as  $x^m$ , for fixed numerical values of  $m$ , &c.; (2) trigonometrical functions,  $\sin x$ ,  $\tan x$ , &c., and their inverse functions, circular functions,  $\sin^{-1} x$ ,  $\tan^{-1} x$ , &c.; (3) exponentials  $a^x$ , &c., and their inverse functions, logarithms.

Several other transcendental functions have been introduced into analysis, such as elliptic and hyper-elliptic functions, gamma-functions, and others. We propose subsequently to give a short account of the elementary properties of some of these functions.

112. The reduction of an integration to one or more of the preceding elementary forms is usually effected by one or other of the following methods:—(1) transformation to a new variable; (2) integration by parts; (3) decomposition into partial fractions; (4) successive reduction; (5) rationalization. Examples of these methods will appear in succeeding paragraphs.

113. The method of integration by substitution corresponds to a change of the independent variable. We shall exemplify it by a few simple cases.

$$\text{Ex. 1. Let } u = \frac{x^m dx}{(a+bx)^n}, \text{ } m \text{ being a positive integer.}$$

Assume  $a+bx=z$ , and the integral transforms into

$$\frac{1}{b^{m+1}} \int \frac{(z-a)^m dz}{z^n}$$

If  $(z-a)^m$  be expanded by the binomial theorem, each term can be separately integrated.

$$\text{Ex. 2 } u = \int \frac{dx}{(x+a)\sqrt{a+2bx+cx^2}}.$$

Let  $x+a = \frac{1}{z}$ , and the integral transforms into

$$-\int \frac{dz}{\sqrt{a'+2b'z+c'z^2}},$$

where  $a' = c$ ,  $b' = b - ca$ ,  $c' = a - 2ba + ca^2$ .

$$\text{Ex. 3. } u = \int \frac{dx}{(a+cx^2)^{\frac{1}{2}}}.$$

Let  $x = \frac{1}{z}$ , and we get

$$u = \int \frac{-z dz}{(az^2 + c)^{\frac{3}{2}}} = \frac{1}{a(ax^2 + c)^{\frac{3}{2}}} = \frac{x}{a(ax^2 + c)^{\frac{3}{2}}}$$

Ex. 4.  $u = \int \frac{dx}{(a + 2bx + cx^2)^{\frac{3}{2}}}$

Here  $u = \int \frac{c^{\frac{1}{2}} dx}{\{ac - b^2 + (cx + b)^2\}^{\frac{3}{2}}}$

Let  $cx + b = z$ , and it transforms into the preceding integral: hence

$$u = \frac{cx + b}{(ac - b^2)(a + 2bx + cx^2)^{\frac{3}{2}}}$$

Ex. 5.  $u = \int \frac{dx}{(a' + c'x^2)(a + cx^2)^{\frac{3}{2}}}$

Let  $(a + cx^2)^{\frac{1}{2}} = xz$ ; then

$$\frac{dx}{(a + cx^2)^{\frac{1}{2}}} = \frac{dz}{c - z^2}$$

and the integral transforms into

$$\int \frac{dz}{(a'c - c'a) - a'z^2}$$

Ex. 6.  $u = \int \frac{dx}{\sqrt{(a-x)(x-\beta)}}$

Let  $x = a \sin^2 \theta + \beta \cos^2 \theta$ , and we get

$$\frac{dx}{\sqrt{(a-x)(x-\beta)}} = 2d\theta, \therefore \int \frac{dx}{\sqrt{(a-x)(x-\beta)}} = 2\theta = 2 \sin^{-1} \sqrt{\frac{x-\beta}{a-\beta}}$$

Ex. 7.  $u = \int \frac{dx}{x \sqrt{\frac{a^2 - x^2}{x^2 - \beta^2}}}$

Here  $du = \frac{a^2 dx}{x \sqrt{(a^2 - x^2)(x^2 - \beta^2)}} - \frac{xdx}{\sqrt{(a^2 - x^2)(x^2 - \beta^2)}}$

If we make  $x^2 = \frac{1}{z}$  in the former, and  $x^2 = y$  in the latter, they each reduce to the preceding example.

Ex. 8.  $\int \frac{dx}{a + b \cos x}$

Here  $u = \int \frac{dx}{(a + b) \cos \frac{x}{2} + (a - b) \sin^2 \frac{x}{2}}$

$$= \int \frac{\sec^2 \frac{x}{2} dx}{a + b + (a - b) \tan^2 \frac{x}{2}} = 2 \int \frac{dz}{a + b + (a - b)z^2}$$

where  $z = \tan \frac{x}{2}$ .

This integral is a circular or a logarithmic function, according as  $a >$ , or,  $<$   $b$ .

(1) Let  $a > b$ , and suppose  $b = a \cos \alpha$ , then we have

$$u = \frac{1}{a} \int \frac{dz}{\cos^2 \frac{\alpha}{2} + z^2 \sin^2 \frac{\alpha}{2}} = \frac{2}{a \sin \alpha} \tan^{-1} \left( \tan \frac{\alpha}{2} \tan \frac{x}{2} \right)$$

(2) If  $a < b$ , let  $a = b \cos \alpha$ , then

$$u = \int \frac{dz}{\cos^2 \frac{\alpha}{2} - z^2 \sin^2 \frac{\alpha}{2}} = \frac{1}{b \sin \alpha} \log \frac{\cos \frac{\alpha}{2} + \sin \frac{\alpha}{2} \tan \frac{x}{2}}{\cos \frac{\alpha}{2} - \sin \frac{\alpha}{2} \tan \frac{x}{2}},$$

$$= \frac{1}{b \sin \alpha} \log \frac{\cos \frac{\alpha - x}{2}}{\cos \frac{\alpha + x}{2}}$$

(3) If  $a = b$ , the value of the integral is

$$\frac{1}{a} \tan \frac{x}{2}$$

114. The substitution of an imaginary expression for a constant in an integral is often useful in evaluating integrals. For example, if in the equation

$$\int e^{ax} dx = \frac{e^{ax}}{a}$$

we substitute  $\alpha + i\beta$  for  $a$ , it becomes

<sup>1</sup> We shall throughout represent the imaginary symbol  $\sqrt{-1}$  by  $i$ , according to the usual notation.

$$\int e^{ax} (\cos \beta x + i \sin \beta x) dx = \frac{e^{ax} (\cos \beta x + i \sin \beta x)}{\alpha + i\beta} = \frac{e^{ax} (\cos \beta x + i \sin \beta x) (\alpha - i\beta)}{\alpha^2 + \beta^2}$$

Hence, equating the real and also the imaginary parts, we get

$$\int e^{ax} \cos \beta x dx = \frac{e^{ax} (\alpha \cos \beta x + \beta \sin \beta x)}{\alpha^2 + \beta^2}$$

$$\int e^{ax} \sin \beta x dx = \frac{e^{ax} (\alpha \sin \beta x - \beta \cos \beta x)}{\alpha^2 + \beta^2}$$

omitting the arbitrary constants. These results can be easily verified.

115. The method of *integration by parts* depends on the following equation, which is deduced immediately from the relation  $d(uv) = u dv + v du$  :-

$$\int u dv = uv - \int v du$$

Hence the determination of the former integral is reduced to that of the latter, and *vice versa*.

Ex. 1. To find

$$\int \tan^{-1} x dx$$

Here

$$\int \tan^{-1} x dx = x \tan^{-1} x - \int \frac{x dx}{1 + x^2} = x \tan^{-1} x - \frac{1}{2} \log(1 + x^2)$$

Ex. 2. Next, to find

$$\int x^n \log x dx$$

Let

$$v = \log x, \quad v = \frac{x^{n+1}}{n+1};$$

then

$$\int x^n \log x dx = \frac{x^{n+1}}{n+1} \log x - \int \frac{x^n dx}{n+1} = \frac{x^{n+1}}{n+1} \left( \log x - \frac{1}{n+1} \right)$$

Ex. 3. Again, to find

$$\int \log(x + \sqrt{x^2 + a^2}) dx$$

$$\int \log(x + \sqrt{x^2 + a^2}) dx = x \log(x + \sqrt{x^2 + a^2}) - \int \frac{nx dx}{\sqrt{x^2 + a^2}} = x \log(x + \sqrt{x^2 + a^2}) - \sqrt{x^2 + a^2}$$

Ex. 4.

$$\int (\log x)^n dx$$

$$= x(\log x)^n dx = x(\log x)^n - n \int (\log x)^{n-1} dx = x(\log x)^n - nx(\log x)^{n-1} + n(n-1) \int (\log x)^{n-2} dx$$

Accordingly, by successive applications of this formula, the integral can be found whenever  $n$  is a *positive* integer. If  $n$  be a negative integer, the integral finally depends on  $\int \frac{dx}{\log x}$ , a form to be subsequently considered.

Ex. 5.  $\int x^m (\log x)^n dx$

This is at once reduced to the preceding by making  $z = x^{m+1}$ .

Ex. 6.  $\int x^m e^{ax} dx$

This is immediately reducible to Ex. 4 by making  $e^{ax} = z$ . It can also be deduced directly, since

$$\int x^m e^{ax} dx = \frac{x^m e^{ax}}{a} - \frac{m}{a} \int x^{m-1} e^{ax} dx$$

Ex. 7.

$$\int \frac{e^{cx}}{(1+x)^2} dx \quad \text{Ans. } \frac{e^x}{1+x}$$

116. In general, if

$$\Theta = u \frac{d^n v}{dx^n} - \frac{du}{dx} \frac{d^{n-1} v}{dx^{n-1}} + \frac{d^2 u}{dx^2} \frac{d^{n-2} v}{dx^{n-2}} - \dots + (-1)^n \frac{d^n u}{dx^n} v$$

we have

$$\int u \frac{d^{n+1} v}{dx^{n+1}} dx = \Theta + (-1)^{n+1} \int v \frac{d^{n+1} u}{dx^{n+1}} dx$$

This result is readily proved by successive applications of the method of integration by parts, or can at once be verified by differentiation.

As an example, let us consider the integral

$$\int F(x) e^{ax} dx,$$

where  $F(x)$  represents a rational integer algebraic function of  $x$ , of the degree  $n$ .

Let  $u = F(x)$ , and  $v = \frac{e^{ax}}{a^{n+1}}$ , then  $\frac{d^{n+1} u}{dx^{n+1}} = 0$ ;

consequently we have

$$\int e^{ax} F(x) dx = \frac{e^{ax}}{a} \left[ F(x) - \frac{F'(x)}{a} + \dots + (-1)^n \frac{F^{(n)}(x)}{a^n} \right]$$

This result can be also readily obtained by aid of the symbolic theorem of § 90, thus,

$$D^{-1} \cdot e^{ax} F(x) = e^{ax} (D+a)^{-1} F(x) \\ = \frac{e^{ax}}{a} \left( 1 + \frac{D}{a} \right)^{-1} F(x) \\ = \frac{e^{ax}}{a} \left[ 1 - \frac{D}{a} + \frac{D^2}{a^2} - \dots + (-1)^n \frac{D^n}{a^n} \right] F(x),$$

the remaining terms being neglected since  $D^{n+1}F(x) = 0$ . This result plainly coincides with that previously found.

More generally, if  $F(x, e^{ax}, e^{bx}, \dots, e^{kx})$  represents a rational integer function of  $x, e^{ax}, e^{bx}, \dots$  the integral of

$$F(x, e^{ax}, e^{bx}, \dots, e^{kx}) dx$$

can be determined. For, this function, being composed of products of integer positive powers of  $x, e^{ax}, \&c.$ , will consist of a number of terms of the form  $Ax^m e^{ax} e^{bnx} \dots$  or  $Ax^m e^{(a+nb+\dots)x}$ , each of which can be integrated by the preceding method.

Again the form

$$\int F(x, \log x) dx,$$

is reducible to

$$\int F(e^z, z) e^z dz,$$

by making  $x = e^z$ , and consequently, when  $F$  represents an integer algebraic function, is integrable by the method considered above.

117. We next proceed to give a brief account of the treatment of the integral  $\int \frac{f(x)}{\phi(x)} dx$ , in which  $f(x)$  and  $\phi(x)$  are rational algebraic functions of  $x$ .

This class of integrals early engaged the attention of mathematicians. For example, Leibnitz and John Bernoulli, in the *Acta Eruditorum* (1702 and 1703), showed that such integrals depended on the method of *partial fractions*. The processes there given were simplified and generalized by Euler (*Introductio in Analysin Infinitorum*, 1748).

When the degree of  $f(x)$  is not less than that of  $\phi(x)$ , the expression  $\frac{f(x)}{\phi(x)}$  can by division be reduced to an integer along with a fractional part; we may, therefore, suppose that we have reduced the degree of  $f(x)$  to less than that of  $\phi(x)$ . Then,  $a$  being a simple root of  $\phi(x) = 0$ , we may assume  $\phi(x) = (x-a)\chi(x)$ , where  $\chi(x)$  is not divisible by  $x-a$ .

If we now make  $\frac{f(x)}{\phi(x)} = \frac{A}{x-a} + \frac{f_1(x)}{\chi(x)},$

we have

$$\frac{f(x)}{\phi(x)} = \frac{A\chi(x) + (x-a)f_1(x)}{(x-a)\chi(x)},$$

$$\therefore f(x) = A\chi(x) + (x-a)f_1(x).$$

This gives

$$f_1(x) = \frac{f(x) - A\chi(x)}{x-a}.$$

In order that the second member should be an integer expression,  $f(x) - A\chi(x)$  must be divisible by  $x-a$ ; hence we get

$$A = \frac{f(a)}{\chi(a)} = \frac{f(a)}{\phi'(a)}.$$

In like manner, if  $b$  be a second simple root of  $\phi(x) = 0$ , and consequently a root of  $\chi(x) = 0$ , we may make  $\chi(x) = (x-b)\psi(x)$ . Hence we get

$$\frac{f_1(x)}{\chi(x)} = \frac{B}{x-b} + \frac{f_2(x)}{\psi(x)};$$

from which it follows that

$$B = \frac{f(b)}{\phi'(b)}.$$

Finally if  $a, b, \dots, l$  represent all the roots of  $\phi(x) = 0$ , no two of which are equal, we shall have

$$\frac{f(x)}{\phi(x)} = \frac{A}{x-a} + \frac{B}{x-b} + \dots + \frac{L}{x-l},$$

where

$$A = \frac{f(a)}{\phi'(a)}, \quad B = \frac{f(b)}{\phi'(b)}, \quad \dots, \quad L = \frac{f(l)}{\phi'(l)}.$$

Hence

$$\int \frac{f(x)}{\phi(x)} dx = \frac{f(a)}{\phi'(a)} \log(x-a) + \frac{f(b)}{\phi'(b)} \log(x-b) + \dots + \frac{f(l)}{\phi'(l)} \log(x-l)$$

In the general case of multiple roots, we may suppose

$$\phi(x) = (x-a)^\alpha (x-b)^\beta \dots (x-l)^\lambda,$$

and assume

$$\frac{f(x)}{\phi(x)} = \frac{A_1}{x-a} + \frac{A_2}{(x-a)^2} + \dots + \frac{A_\alpha}{(x-a)^\alpha} \\ + \frac{B_1}{x-b} + \frac{B_2}{(x-b)^2} + \dots + \frac{B_\beta}{(x-b)^\beta} \\ \dots \\ + \frac{L_1}{x-l} + \frac{L_2}{(x-l)^2} + \dots + \frac{L_\lambda}{(x-l)^\lambda}.$$

The constants  $A_1, A_2, \dots, B_1, B_2, \dots, L_1, \dots, L_\lambda$ , can be determined by ordinary algebraic methods, and each term is immediately integrable. The preceding is called the method of integration by decomposition into partial fractions.

The method here given applies also to the case where  $\phi(x) = 0$  has imaginary roots. In that case it is usually, however, simpler to employ a somewhat different treatment. Thus, to a pair of imaginary roots  $a \pm i\beta$  corresponds a partial fraction of the form

$$\frac{Lx + M}{(x-a)^2 + \beta^2}.$$

Also, for  $n$  pairs of equal imaginary roots, we have additional terms of the form

$$\frac{L_1 x + M_1}{\{(x-a)^2 + \beta^2\}^2}, \quad \frac{L_2 x + M_2}{\{(x-a)^2 + \beta^2\}^3}, \quad \dots, \quad \frac{L_n x + M_n}{\{(x-a)^2 + \beta^2\}^n}.$$

Each of these expressions consists of two parts, one of which can be immediately integrated. For example,

$$\frac{(L_n x + M_n) dx}{\{(x-a)^2 + \beta^2\}^n} = \frac{L_n (x-a) dx}{\{(x-a)^2 + \beta^2\}^n} + \frac{(L_n a + M) dx}{\{(x-a)^2 + \beta^2\}^n};$$

the former can be at once found; the consideration of the latter class of expressions is postponed for the present.

Many integrals of the form here considered may be determined by a transformation, without the employment of the method of partial fractions.

For example,

$$\int \frac{x^{m-1} dx}{ax^{2n} + 2bx^n + c}$$

is at once reduced to an elementary form by making  $x^n = z$ .

Again

$$\int \frac{dx}{(x-a)^m (x-b)^n}$$

is reduced to depend on

$$\int \frac{(1-z)^{m+n-2} dz}{z^m}$$

by making  $z = \frac{x-a}{x-b}$ .

Ex. 1. To find  $\int \frac{x^2 dx}{x^2-1}$ , assume  $z = x^2$ ;

then  $x^2 dx = \frac{1}{2} z dz$ , and we get

$$\int \frac{x^2 dx}{x^2-1} = \frac{1}{2} \int \frac{z dz}{z-1} = \frac{1}{2} z + \frac{1}{2} \log(z-1) = \frac{x^2}{2} + \frac{1}{2} \log(x^2-1).$$

Ex. 2. To find

$$\int \frac{dx}{x(a+bx^n)}.$$

Let  $x^n = \frac{1}{z}$ , then

$$\frac{dx}{x} = -\frac{1}{n} \frac{dz}{z},$$

and

$$\int \frac{dx}{x(a+bx^n)} = -\frac{1}{n} \int \frac{dz}{az+b} = -\frac{1}{na} \log\left(\frac{x^n}{a+bx^n}\right)$$

Ex. 3.

$$\int \frac{dx}{x^2(a+bx^3)}.$$

Let  $x^3 = \frac{1}{z}$ , and we get

$$\int \frac{dx}{x^2(a+bx^3)} = -\frac{1}{3} \int \frac{z dz}{az+b} = -\frac{z}{3a} + \frac{b}{3a^2} \log(az+b) \\ = -\frac{1}{3ax^3} + \frac{b}{3a^2} \log\left(\frac{a+bx^3}{x^3}\right).$$

Ex. 4. To find

$$\int \frac{dx}{1-2x^2 \cos \theta + x^4}.$$

Here

$$\int \frac{dx}{1-2x^2 \cos \theta + x^4} = \int \frac{dx}{(1+2x \cos \frac{1}{2}\theta + x^2)(1-2x \cos \frac{1}{2}\theta + x^2)} \\ = \frac{1}{4 \cos \frac{1}{2}\theta} \int \frac{(x+2 \cos \frac{1}{2}\theta) dx}{1+2x \cos \frac{1}{2}\theta + x^2} - \frac{1}{4 \cos \frac{1}{2}\theta} \int \frac{(x-2 \cos \frac{1}{2}\theta) dx}{1-2x \cos \frac{1}{2}\theta + x^2} \\ = \frac{1}{8 \cos \frac{1}{2}\theta} \log \frac{1+2x \cos \frac{1}{2}\theta + x^2}{1-2x \cos \frac{1}{2}\theta + x^2} \\ + \frac{1}{4 \sin \frac{1}{2}\theta} \left\{ \tan^{-1} \frac{x + \cos \frac{1}{2}\theta}{\sin \frac{1}{2}\theta} + \tan^{-1} \frac{x - \cos \frac{1}{2}\theta}{\sin \frac{1}{2}\theta} \right\} \\ = \frac{1}{8 \cos \frac{1}{2}\theta} \log \frac{1+2x \cos \frac{1}{2}\theta + x^2}{1-2x \cos \frac{1}{2}\theta + x^2} + \frac{1}{4 \sin \frac{1}{2}\theta} \tan^{-1} \frac{2x \sin \frac{1}{2}\theta}{1-x^2}.$$

Ex. 5. Find the integral of

$$\frac{dx}{a+2bx^2+cx^4}$$

when

$$ac > b^2.$$

It is easily seen from the last that its value may be written

$$\frac{1}{8\sqrt{a}} \log \frac{\sqrt{a+2cx+x^2}\sqrt{c}}{\sqrt{a-2cx+x^2}\sqrt{c}} + \frac{1}{4\sqrt{a(b+\kappa^2)}} \tan^{-1} \frac{2x\sqrt{b+\kappa^2}}{\sqrt{a-x^2}\sqrt{c}},$$



where

$$\kappa = \sqrt{\frac{\sqrt{ac-b}}{2}}$$

118. Several general classes of integrals can be easily reduced by a transformation to depend on those of the preceding article.

For example, the integral

$$\int f(c^{ax}) dx$$

reduces to  $\int f(z) \frac{dz}{z}$ , by making  $c^{ax} = z$ ; and, accordingly, it can be integrated whenever  $f(z)$  is a rational algebraic function of  $z$ .

Again, if we take  $\tan \frac{1}{2} x = z$ , we get

$$\sin x = \frac{2z}{1+z^2}, \cos x = \frac{1-z^2}{1+z^2}, dx = \frac{2dz}{1+z^2}$$

and, the expression

$$f(\sin x, \cos x) dx,$$

$$f\left(\frac{2z}{1+z^2}, \frac{1-z^2}{1+z^2}\right) \frac{2dz}{1+z^2}$$

transforms into

Consequently, whenever  $f(\sin x, \cos x)$  is a rational function, the integration of  $f(\sin x, \cos x) dx$  is reducible by the method of partial fractions.

119. Functions of this latter class are, however, usually more readily integrated by other processes. Thus, when  $f(\sin x, \cos x)$  is a rational and integer function, its integration depends on that of the sum of a number of expressions of the form  $\sin^m x \cos^n x dx$ . As a number of other forms are readily reducible to this type, it is proposed to devote a short space to its discussion here.

In the first place it should be observed that whenever  $m$  or  $n$  is an odd integer, the expression  $\sin^m x \cos^n x dx$  can be immediately integrated. For, if we suppose  $n = 2r + 1$ , the integral transforms into

$$\int z^m (1-z^2)^r dz,$$

by making  $z = \sin x$ . Hence, as  $r$  is by hypothesis a positive integer,  $(1-z^2)^r$  can be expanded in a finite number of terms, and the integral thus immediately obtained.

Again, if  $m+n$  be an even negative integer, the expression can be readily integrated; for, by assuming  $z = \tan x$ , we get

$$\int \sin^m x \cos^n x dx = \int z^m (1+z^2)^{\frac{m+n}{2}-1} dz.$$

This integral can be readily obtained by expansion.

120. When neither of these methods is applicable it is usual to find the integral of  $\sin^m x \cos^n x dx$  by the method of successive reduction.

The formulæ of reduction can be easily obtained by the method of integration by parts; thus

$$\int \sin^m x \cos^n x dx = \int \cos^{n-1} x \sin^m x d(\sin x) = \int \frac{\cos^{n-1} x}{m+1} d(\sin^{m+1} x)$$

$$= \frac{\cos^{n-1} x \sin^{m+1} x}{m+1} + \frac{n-1}{m+1} \int \sin^{m+2} x \cos^{n-2} x dx.$$

$$\text{Again, } \int \sin^{m+2} x \cos^{n-2} x dx = \int \sin^{m+1} x (1-\cos^2 x) \cos^{n-2} x dx$$

$$= \int \sin^{m+1} x \cos^{n-2} x dx - \int \sin^{m+1} x \cos^n x dx.$$

Substituting in the former equation, and transposing the latter integral to the other side of the equation, we get

$$\int \sin^m x \cos^n x dx = \frac{\sin^{m+1} x \cos^{n-1} x}{m+n} + \frac{n-1}{m+n} \int \sin^m x \cos^{n-2} x dx.$$

Hence, when  $n$  is positive, the integral of  $\sin^m x \cos^n x dx$  depends on that of  $\sin^m x \cos^{n-2} x dx$ . The corresponding formulæ in which the degree of  $\sin x$  is reduced can be immediately found.

It should be noted that these formulæ of reduction are perfectly general, and hold whether  $m$  and  $n$  be positive or negative, integer or fractional. Accordingly, changing the sign of  $m$ , our first equation may be written thus:—

$$\int \frac{\cos^n x}{\sin^m x} dx = -\frac{\cos^{n-1} x}{(m-1) \sin^{m-1} x} - \frac{n-1}{m-1} \int \frac{\cos^{n-2} x}{\sin^{m-2} x} dx.$$

121. These formulæ of reduction, as well as many others, can be readily established by differentiation. For example, since

$$\frac{d}{dx} (\sin^m x \cos^n x) = m \sin^{m-1} x \cos^n x - n \sin^m x \cos^{n-1} x$$

$$= m \sin^{m-1} x \cos^{n-1} x - (m+n) \sin^{m+1} x \cos^{n-1} x,$$

the integration of the expression  $\sin^{m+1} x \cos^{n-1} x dx$  depends on that of  $\sin^{m-1} x \cos^{n-1} x dx$ ; and similarly in other cases.

It may be noted that the integral (§ 118)

$$\int \frac{dx}{\{(x-a)^2 + \beta^2\}^n}$$

is at once reduced to the class here considered by making  $x - a = \beta \tan \theta$ , when it becomes

$$\frac{1}{\beta^{2n-1}} \int \cos^{2n-2} \theta d\theta.$$

To find  $\int \tan^n x dx$ .

$$\text{Here } \int \tan^n x dx = \int \tan^{n-2} x (\sec^2 x - 1) dx$$

$$= \frac{\tan^{n-1} x}{n-1} - \int \tan^{n-2} x dx$$

$$= \frac{\tan^{n-1} x}{n-1} - \frac{\tan^{n-3} x}{n-3} + \&c.$$

Next, let us consider the integral

$$\int \frac{dx}{(a \cos x + b \sin x)^n}.$$

Let  $\tan a = \frac{\alpha}{\beta}$ , and we get

$$a \cos x + b \sin x = (a^2 + b^2)^{\frac{1}{2}} \sin(x + \alpha).$$

Hence, making  $x + \alpha = z$ , the integral transforms into

$$(a^2 + b^2)^{-\frac{n}{2}} \int \frac{dz}{\sin^n z}.$$

122. In many applications the results depend on integrals of the form here discussed when taken between the limits 0 and  $\frac{\pi}{2}$ . Such definite integrals are easily found when the indices  $m$  and  $n$  are positive integers.

Commencing with the simple case of  $\int_0^{\frac{\pi}{2}} \sin^n x dx$ , we have, since  $\sin x \cos^{n-1} x$  vanishes for both limits,

$$\int_0^{\frac{\pi}{2}} \cos^n x dx = \frac{n-1}{n} \int_0^{\frac{\pi}{2}} \cos^{n-2} x dx.$$

By successive applications of this formula the definite integral in question can be always found when  $n$  is a positive integer; its form, however, depends on whether the index  $n$  is even or odd.

(1) Suppose  $n$  even, and equal to  $2r$ ,

$$\text{then } \int_0^{\frac{\pi}{2}} \cos^{2r} x dx = \frac{2r-1}{2r} \int_0^{\frac{\pi}{2}} \cos^{2r-2} x dx,$$

and, accordingly, by successive applications, we get

$$\int_0^{\frac{\pi}{2}} \cos^{2r} x dx = \frac{1 \cdot 3 \cdot 5 \dots (2r-1)}{2 \cdot 4 \cdot 6 \dots 2r} \frac{\pi}{2}.$$

(2) If  $n$  be odd, and equal to  $2r+1$ , we get in like manner

$$\int_0^{\frac{\pi}{2}} \cos^{2r+1} x dx = \frac{2 \cdot 4 \cdot 6 \dots 2r}{3 \cdot 5 \cdot 7 \dots (2r+1)}.$$

It is evident that in all cases

$$\int_0^{\frac{\pi}{2}} \sin^n x dx = \int_0^{\frac{\pi}{2}} \cos^n x dx.$$

(3) In like manner, we have

$$\int_0^{\frac{\pi}{2}} \sin^m x \cos^n x dx = \frac{n-1}{m+n} \int_0^{\frac{\pi}{2}} \sin^m x \cos^{n-2} x dx.$$

As in the former case, the value of this definite integral depends on whether the indices are odd or even.

First suppose  $n$  odd, and equal  $2r+1$ ,

$$\text{then } \int_0^{\frac{\pi}{2}} \sin^m x \cos^{2r+1} x dx = \frac{2r}{m+2r+1} \int_0^{\frac{\pi}{2}} \sin^m x \cos^{2r-1} x dx.$$

Hence

$$\int_0^{\frac{\pi}{2}} \sin^m x \cos^{2r+1} x dx$$

$$= \frac{2r(2r-2) \dots 2}{(2r+m+1)(2r+m-1) \dots (m+3)} \int_0^{\frac{\pi}{2}} \sin^m x \cos x dx$$

$$= \frac{2 \cdot 4 \cdot 6 \dots 2r}{(m+1)(m+3) \dots (m+2r+1)}.$$

Next let  $n$  be even, and equal to  $2r$ , then

$$\int_0^{\frac{\pi}{2}} \sin^m x \cos^{2r} x dx = \frac{2r-1}{2(m+r)} \int_0^{\frac{\pi}{2}} \sin^m x \cos^{2r-2} x dx.$$

Hence, as before,

$$\int_0^{\frac{\pi}{2}} \sin^m x \cos^{2r} x dx = \frac{1 \cdot 3 \cdot 5 \dots (2r-1)}{(2m+2) \dots (2m+2r)} \int_0^{\frac{\pi}{2}} \sin^m x dx$$

$$= \frac{1 \cdot 3 \cdot 5 \dots (2r-1) \cdot 1 \cdot 3 \cdot 5 \dots (2m-1)}{2 \cdot 4 \cdot 6 \dots (2m+2r)} \frac{\pi}{2}.$$

When  $m$  and  $n$  are both fractional these definite integrals are

reducible to Eulerian integrals,—functions of which a short discussion will be subsequently given.

The following examples are given for the purpose of illustrating the preceding results.

Ex. 1.  $\int_0^1 (1-x^2)^m dx$ , where  $m$  is an integer.  
*Ans.*  $\frac{2 \cdot 4 \cdot 6 \dots (2m)}{3 \cdot 5 \cdot 7 \dots (2m+1)}$ .

Ex. 2.  $\int_0^{\frac{\pi}{2}} \cos^2 x \sin^2 x dx$ .  
*Ans.*  $\frac{3 \cdot 6 \cdot 12}{5 \cdot 11 \cdot 17}$ .

Ex. 3.  $\int_0^\infty \frac{dx}{(a^2+x^2)^n}$ , where  $n$  is an integer.  
*Ans.*  $\frac{\pi}{2a^{2n-1}} \cdot \frac{1 \cdot 3 \cdot 5 \dots (2n-3)}{2 \cdot 4 \cdot 6 \dots (2n-2)}$ .

Ex. 4.  $\int_0^{\frac{\pi}{2}} \cos^{2r} x \cos nx dx$ .  
*Ans.*  $\frac{\pi}{2^{n+2r+1}} \frac{(n+2r)(n+2r-1) \dots (n+r+1)}{1 \cdot 2 \cdot 3 \dots r}$ .

Ex. 5. To deduce Wallis's value for  $\pi$  by aid of the definite integrals considered in this article.

When  $m$  is positive, we have, for all values of  $x$  between 0 and  $\frac{\pi}{2}$ ,  $\sin^{2m-1}x > \sin^{2m}x > \sin^{2m+1}x$ ; accordingly,

$$\int_0^{\frac{\pi}{2}} \sin^{2m-1}x dx > \int_0^{\frac{\pi}{2}} \sin^{2m}x dx > \int_0^{\frac{\pi}{2}} \sin^{2m+1}x dx,$$

$\therefore \frac{1 \cdot 3 \cdot 5 \dots (2m-1)}{2 \cdot 4 \cdot 6 \dots 2m} \frac{\pi}{2}$  lies between  $\frac{2 \cdot 4 \cdot 6 \dots (2m-2)}{3 \cdot 5 \cdot 7 \dots (2m-1)}$  and  $\frac{2 \cdot 4 \cdot 6 \dots 2m}{3 \cdot 5 \cdot 7 \dots (2m+1)}$ ;

but when  $m$  is indefinitely increased the latter fractions tend to equality, and, consequently, we have the well-known formula of Wallis, viz. :—

$$\frac{\pi}{2} = \text{limit of } \frac{2 \cdot 2}{1 \cdot 3} \cdot \frac{4 \cdot 4}{3 \cdot 5} \cdot \frac{6 \cdot 6}{5 \cdot 7} \dots$$

123. As a further example of the method of successive reduction, we shall consider the integral

$$\int x^{m-1}(1-x)^{n-1} dx.$$

Here, integrating by parts, we have

$$\int x^{m-1}(1-x)^{n-1} dx = \frac{x^m(1-x)^{n-1}}{m} + \frac{n-1}{n} \int x^m(1-x)^{n-2} dx.$$

Again,  $\int x^m(1-x)^{n-2} dx = \int x^{m-1}(1-x)^{n-2} dx - \int x^{m-1}(1-x)^{n-1} dx$ .

Substituting, and transposing, we get

$$\int x^{m-1}(1-x)^{n-1} dx = \frac{x^m(1-x)^{n-1}}{m+n-1} + \frac{n-1}{m+n-1} \int x^{m-1}(1-x)^{n-2} dx.$$

By successive applications of this relation the proposed integral can be found whenever  $n$  is a positive integer. It can be determined in like manner when  $m$  is a positive integer. The integral of  $x^m(a+bx)^n dx$  readily admits of similar treatment.

The preceding is a simple case of the integration of what are styled *binomial differentials*, i. e., differentials of the form  $x^m(a+bx)^p dx$ ,—in which  $m, n, p, q$  represent any numbers, positive or negative. We propose to determine in what cases such differentials can be immediately integrated by a transformation.

Assume  $a+bx^n = z$ , then  $x = \left(\frac{z-a}{b}\right)^{\frac{1}{n}}$ , and we get

$$x^m(a+bx^n)^p dx = \frac{q}{nb^{\frac{1}{n}}} z^{p+q-1} (z-a)^{\frac{m-n+1}{n}} dz.$$

The latter can be immediately integrated when  $\frac{m+1}{n}$  is an integer.

Again, substituting  $\frac{1}{z}$  for  $x$ , the expression  $x^m(a+bx^n)^p dx$  becomes  $-c^{-m-n} z^{-p-2} (az+b)^p dz$ . This can be integrated whenever  $\frac{m+1}{n} + \frac{p}{q}$  is an integer.

It can be shown that when neither of these conditions is fulfilled the integral of the binomial differential cannot be expressed except by infinite series.

124. *Irrational Functions.*—We shall next briefly consider the method of proceeding in the case of *irrational* expressions.

Suppose  $F(x, \sqrt{X}) dx$  to represent the expression whose integration is sought, where  $F$  is a rational algebraic function, and  $X$  is a rational integer polynomial of any degree in  $x$ . Here, since even powers of  $\sqrt{X}$  are rational, and odd powers contain  $\sqrt{X}$  as a factor, it is plain that  $F(x, \sqrt{X})$  can be always reduced to the form

$$\frac{P+Q\sqrt{X}}{P'+Q'\sqrt{X}},$$

where  $P, Q, P', Q'$  are rational algebraic functions of  $x$ . Again, if this be multiplied by  $P'-Q'\sqrt{X}$ , it is reducible to the form

$$M+N\sqrt{X}, \text{ or to } M + \frac{NX}{\sqrt{X}},$$

where  $M$  and  $N$  are rational functions. Consequently integrals of the proposed form are reducible in general to two parts, of which one is rational, and the other is of the form

$$\int \frac{f(x)}{\phi(x)} \frac{dx}{\sqrt{X}}.$$

It can be shown that, when  $X$  contains powers of  $x$  beyond the second, such integrals cannot be reduced to any of the elementary forms given at the commencement; and, accordingly, they depend on higher transcendental functions. When  $X$  is a cubic or a bi-quadratic, such integrals are reducible to elliptic functions, of which a short account shall be given below. When  $X$  is a polynomial of higher degree, the integrals are usually styled *hyper-elliptic* integrals. They were first treated of in a general manner by Abel.

125. We shall at present consider only the case where  $X$  is a quadratic, of the form  $a+2bx+cx^2$ . The integral

$$\int \frac{f(x)}{\phi(x)} \frac{dx}{\sqrt{a+2bx+cx^2}}$$

can be rendered rational in different ways.

(1) First, let the roots of  $a+2bx+cx^2=0$  be real, and suppose  $a+2bx+cx^2=c(x-\alpha)(x-\beta)$ .

If  $c$  be positive, we assume  $x-\alpha=(x-\beta)z^2$ , or  $x = \frac{\alpha-\beta z^2}{1-z^2}$ ; then

$$\sqrt{X} = (\alpha-\beta)\sqrt{c} \frac{z}{1-z^2}, \text{ and } dx = \frac{2(\alpha-\beta)z dz}{(1-z^2)^2}$$

$$\therefore \frac{dx}{\sqrt{X}} = \frac{2}{\sqrt{c}} \frac{dz}{1-z^2}.$$

Hence the transformed expression is a rational function of  $z$ .

If  $c$  be negative, we make  $x = \frac{\alpha+\beta z^2}{1+z^2}$ , and the transformed expression is rational, in like manner.

When the roots  $\alpha$  and  $\beta$  are imaginary this method of transformation introduces imaginary forms into our results. In such cases it is usually more advantageous to adopt a different treatment.

For instance, if we assume

$$\sqrt{a+2bx+cx^2} = z - x\sqrt{c},$$

$$a+2bx = z^2 - 2xz\sqrt{c}.$$

we get

$$x = \frac{z^2 - a}{2(b+z\sqrt{c})},$$

and

$$\frac{dx}{\sqrt{a+2bx+cx^2}} = \frac{dz}{b+z\sqrt{c}}.$$

This substitution consequently furnishes a rational function in  $z$ .

Again, when  $c$  is negative the expression becomes rational by the assumption

$$\sqrt{a+2bx+cx^2} = \sqrt{a} + xz.$$

In general, if we substitute  $\frac{\lambda+2\mu z + \nu z^2}{\lambda'+2\mu'z + \nu'z^2}$  for  $x$ , where  $\lambda, \lambda', \mu, \mu', \nu, \nu'$  satisfy the equations  $\mu^2 - \lambda\nu = \sigma, \lambda'\nu + \lambda\nu' - 2\mu\mu' = 2b, \mu'^2 - \lambda'\nu' = c$ , it can be shown without difficulty that

$$\frac{dx}{\sqrt{a+2bx+cx^2}} = \frac{2dz}{\lambda'+2\mu'z + \nu'z^2},$$

and accordingly the function

$$\frac{f(x)}{\phi(x)} \frac{dx}{\sqrt{a+2bx+cx^2}}$$

becomes rational by this transformation.

This last is a particular case of the general method adopted by Jacobi (*Fundamenta nova theoriae functionum ellipticarum*) for the transformation of elliptic integrals.

126. The class of integrals here discussed admits also of another mode of treatment.

Thus it can be shown that, if  $F(x)$  is an integer rational function of the degree  $n$ , then

$$\int \frac{F(x) dx}{\sqrt{a+2bx+cx^2}} = a \int \frac{dx}{\sqrt{a+2bx+cx^2}} + \phi(x) \sqrt{a+2bx+cx^2},$$

in which  $a$  is a constant, and  $\phi(x)$  is at most of the degree  $n-1$  in  $x$ . For, if we differentiate the expression  $x^m \sqrt{a+2bx+cx^2}$  with respect to  $x$ , we readily obtain, after the integration of both sides, and the substitution of  $X$  for  $a+2bx+cx^2$ ,

$$x^m \sqrt{X} = (m+1)c \int \frac{x^{m+1} dx}{\sqrt{X}} + (2m+1)b \int \frac{x^m dx}{\sqrt{X}} + ma \int \frac{x^{m-1} dx}{\sqrt{X}}.$$

Hence, making  $m=0, 1, 2, 3 \dots$  in succession, it is easily seen that  $\int \frac{x^m dx}{\sqrt{X}}$  is expressible in terms of  $\int \frac{dx}{\sqrt{X}}$  and of an algebraic expression of the form  $\phi(x) \sqrt{X}$ , where  $\phi(x)$  is of the degree  $n-1$  at highest.

Again, by the method of partial fractions the integral

$$\int \frac{f(x)}{\phi(x)} \frac{dx}{\sqrt{a+2bx+cx^2}}$$

reduces to terms such as the preceding, along with terms of the form

$$\int \frac{dx}{(x-a)^n \sqrt{a+2bx+cx^2}}.$$

If in this latter we substitute  $\frac{1}{z}$  for  $x-a$ , it reduces to the form

$$\int \frac{z^{n-1} dz}{\sqrt{A+2Bz+Cz^2}}.$$

in which  $A=c, B=-b-ca, C=a+2ba+ca^2$ .

127. Integrals of the form here discussed may also be treated by the method of indeterminate coefficients. Thus, writing  $X$  for  $a+2bx+cx^2$ , and differentiating the equation at the commencement of §126, we get

$$\frac{F(x)}{\sqrt{X}} = \frac{a}{\sqrt{X}} + \phi'(x) \sqrt{X} + \frac{\phi(x)(b+cx)}{\sqrt{X}},$$

or  $\int F(x) = a + \phi'(x)(a+2bx+cx^2) + \phi(x)(b+cx)$ .

Hence, by equating coefficients of like powers of  $x$ , the value of  $a$  and of the coefficients in  $\phi(x)$  can be determined.

For example, let it be proposed to find

$$\int \frac{x^2 dx}{\sqrt{a+2bx+cx^2}}.$$

Writing  $\lambda + 2\mu x + \nu x^2$  for  $\phi(x)$ , we get

$$x^3 = a + 2(a+2bx+cx^2)(\mu + \nu x) + (\lambda + 2\mu x + \nu x^2)(b+cx),$$

from which we deduce

$$\nu = \frac{1}{3c}, \quad \mu = -\frac{5b}{12c^2}, \quad \lambda = \frac{5b^2}{2c^3} - \frac{2a}{3c^2}, \quad a = \frac{b}{2c^2}(3ac - 5b^2).$$

128. Again, if  $F$  denote a rational function, the integral

$$\int F(x, \sqrt{ax+b}, \sqrt{a'x+b'}) dx$$

is reducible to the preceding type, by making  $\sqrt{ax+b}=y$ . For this gives

$$dx = \frac{2y dy}{a}, \quad \sqrt{a'x+b'} = \sqrt{\frac{a'y^2}{a} + \frac{a'b'-a'b}{a}};$$

and the proposed becomes of the form

$$\int f(y, \sqrt{Y}) dy,$$

in which  $Y$  is of the second degree in  $y$ .

129. Having given a sketch of the various methods of reduction of integrals to the forms usually regarded as elementary, we proceed to introduce further transcendental integrals by considering the integral  $\int \frac{e^{ax} f(x) dx}{\phi(x)}$ , in which  $f(x)$  and  $\phi(x)$  are rational algebraic functions of  $x$ .

By the method of partial fractions we may write

$$\frac{f(x)}{\phi(x)} = F(x) + \sum \frac{a}{x-a} + \sum \frac{a_1}{(x-a)^2} + \dots + \sum \frac{a_n}{(x-a)^{n+1}},$$

or, making a slight change in the constants,

$$\frac{f(x)}{\phi(x)} = F(x) + \sum \Lambda(x-a)^{-1} + \sum A_1 \frac{d}{dx}(x-a)^{-1} + \dots + \sum A_n \left(\frac{d}{dx}\right)^n (x-a)^{-1} = F(x) + \sum (\Lambda + A_1 D + A_2 D^2 + \dots + A_n D^n)(x-a)^{-1},$$

where  $D$  stands for the symbol  $\frac{d}{dx}$ .

The method of integrating  $F(x)e^{ax} dx$  has been already considered (§ 116). The integral of the remainder depends on that of the expression

$$e^{ax} dx (\Lambda + A_1 D + A_2 D^2 + \dots + A_n D^n)(x-a)^{-1}.$$

If the symbolic expression  $\Lambda + A_1 D + A_2 D^2 + \dots + A_n D^n$  be represented by  $f(D)$ , this integral, in symbolic notation, is represented by

$$D^{-1} e^{ax} f(D)(x-a)^{-1},$$

or, by § 89,

$$D^{-1} f(D-n) \frac{e^{ax}}{x-a}.$$

Again if  $f(-n)$ , or  $\Lambda - A_1 n + A_2 n^2 - \dots \pm A_n n^n$ , be represented by  $N$ , we have

$$f(D-n) = N - \frac{dN}{dn} D + \frac{d^2 N}{dn^2} D^2 - \dots + A_n D^n.$$

Hence, observing that  $N, \frac{dN}{dn}, \frac{d^2 N}{dn^2} \dots$  are independent of  $x$ , we have

$$\begin{aligned} D^{-1} e^{ax} f(D) \frac{1}{x-a} &= D^{-1} \left\{ N - \frac{dN}{dn} D + \dots + A_n D^n \right\} \frac{e^{ax}}{x-a} \\ &= N \int \frac{e^{ax} dx}{x-a} - \frac{dN}{dn} \int \frac{e^{ax}}{x-a} + \frac{d^2 N}{dn^2} \frac{d}{dx} \left( \frac{e^{ax}}{x-a} \right) - \dots \\ &\quad + A_n \left( \frac{d}{dx} \right)^{n-1} \left( \frac{e^{ax}}{x-a} \right). \end{aligned}$$

Consequently, the class of integrals here considered depends ultimately on the integral

$$\int \frac{e^{ax} dx}{x-a}.$$

If we make  $x-a = \log z$ , this integral reduces to the form (§ 116, Ex. 4)

$$\int \frac{dz}{\log z}.$$

It is impossible to represent this latter integral, in a finite form, in terms of  $z$ . It is accordingly regarded as a function *sui generis*, and is usually styled the *logarithmic integral*, and sometimes Soli-mer's integral. Its expression in the form of a series will be discussed in a subsequent section.

130. Next, if we replace  $n$  by  $in$ , where  $i$  stands for  $\sqrt{-1}$ ,

$$e^{ax} \frac{f(x)}{\phi(x)} \text{ becomes } (\cos nx + i \sin nx) \frac{f(x)}{\phi(x)},$$

and by an analogous treatment it can be proved that integrals of the forms

$$\int \cos nx \frac{f(x)}{\phi(x)} dx \text{ and } \int \sin nx \frac{f(x)}{\phi(x)} dx$$

depend on the forms

$$\int \frac{\cos z dz}{z} \text{ and } \int \frac{\sin z dz}{z}.$$

Finally, denoting by  $F(\sin x, \cos x)$  an integer polynomial in  $\sin x$  and  $\cos x$ , it can be shown that the integral

$$\int \frac{f(x)}{\phi(x)} F(\sin x, \cos x) dx$$

can be reduced to the same fundamental forms. For the polynomial  $F(\sin x, \cos x)$  can be transformed into a linear function of sines and cosines of multiples of  $x$ . Again, decomposing  $\frac{f(x)}{\phi(x)}$  by the method of partial fractions, the integral in question can be made to depend on integrals of the form

$$\int \frac{\sin mx dx}{(x-a)^{n+1}} \text{ and } \int \frac{\cos mx dx}{(x-a)^{n+1}},$$

and consequently on

$$\int dx \sin mx \left(\frac{d}{dx}\right)^n \frac{1}{(x-a)} \text{ and } \int dx \cos mx \left(\frac{d}{dx}\right)^n \frac{1}{(x-a)}.$$

These integrals, by the method of § 116, depend on

$$\int dx \frac{\left(\frac{d}{dx}\right)^n \sin mx}{x-a} \text{ and } \int dx \frac{\left(\frac{d}{dx}\right)^n \cos mx}{x-a}$$

and, consequently, on the forms

$$\int \frac{\sin z dz}{z} \text{ and } \int \frac{\cos z dz}{z}.$$

131. These latter integrals also are now regarded as primary functions in analysis, and are incapable of representation in terms of  $z$  except by infinite series.

These functions have been largely treated of by mathematicians, more especially by Schlömilch (*Crelle*, vol. xxxiii.), by whom they were styled the *sine-integral* and the *cosine-integral*. Also, introducing a slight modification, the logarithmic integral can be written in the form

$$\int \frac{e^{-z} dz}{z}.$$



In this latter shape it is called the exponential integral. Hence, adopting Schlömilch's notation, we write

$$\begin{aligned} \text{Si } x &= \int_0^x \frac{\sin z}{z} dz = \int_0^1 \frac{\sin(uz)}{u} du, \\ \text{Ci } x &= \int_{-\infty}^x \frac{\cos z}{z} dz = \int_x^1 \frac{\cos(uz)}{u} du, \\ \text{Ei } x &= \int_{-\infty}^{-x} \frac{e^{-z}}{z} dz = \int_x^{-1} \frac{e^{-uz}}{u} du. \end{aligned}$$

Again, if  $\text{Li } x = \int_0^x \frac{dz}{\log z}$ , we have  $\text{Li } e^x = \text{Ei } x$ .

An interesting and valuable historical account of these transcendental functions is given by Mr J. W. L. Glaisher in the *Transactions of the Royal Society*, 1870, of which want of space prevents our giving a fuller account. Mr Glaisher has also, in the same memoir, given tables of the numerical values of these transcendental functions for a number of different arguments.

It may be added that the logarithmic integral was discussed, and tabulated by Soldner in 1809.

Numerous integrals have been reduced to depend on the foregoing transcendents. For example, in the great tables of Bierens de Haan (*Nouvelles tables d'intégrales définies*, Leyden, 1867) nearly 450 forms are shown to be reducible to one or other of the functions considered in this section.

What has been said here will help to exhibit the way in which the necessity for the introduction of new transcendental functions arises as the calculus is developed, and to show that around each new transcendent whole classes of integrals are grouped.

132. The very limited number of differentials which can be integrated in a finite form by aid of the ordinary functions makes it an interesting and important question to find whether the integral of any proposed differential expression is capable of being represented by such functions or not. This problem appears to have been first discussed in a general manner by Abel. Our limits admit only of a statement of one or two of the general results thus arrived at. The reader will find a tolerably full account of the treatment of the question in Bertrand's *Calcul Intégral*, pp. 89-110.

Abel's fundamental theorem may be stated as follows. Suppose  $y$  to be an algebraic function of the variable  $x$ , that is, a function defined by a rational equation  $F(x, y) = 0$ , which is of the  $n$ th degree in  $y$ ; then, if the integral  $\int y dx$  be also an algebraic function of  $x$ , it must be of the form

$$\int y dx = P_0 + P_1 y + P_2 y^2 + \dots + P_{n-1} y^{n-1},$$

in which  $P_0, P_1, P_2, \dots, P_{n-1}$  are rational functions of  $x$ . The functions  $P_0, P_1, \dots$  can be investigated by the method of indeterminate coefficients, which, in the great majority of cases, will show the impossibility of an algebraic integral.

In the particular case where  $y = \sqrt[n]{X}$ ,  $X$  denoting a rational function of  $x$ , it has been shown by Liouville, as a consequence of Abel's theorem, that, if the integral  $\int dx \sqrt[n]{X}$  be algebraic, it must be of the form  $P_1 \sqrt[n]{X}$ , in which  $P_1$  is a rational algebraic function of  $x$ .

Again, denoting  $X$  by  $\frac{M}{N}$ , and substituting  $T$  for  $M^{n-1}N$ , if the integral

$$\int \frac{M dx}{\sqrt[n]{T}},$$

where  $M$  and  $T$  are whole polynomials, be expressible algebraically, it is of the form  $\frac{\Theta}{\sqrt[n]{T}}$ , where  $\Theta$  is another polynomial.

If the equation

$$\int \frac{M dx}{\sqrt[n]{T}} = \frac{\Theta}{\sqrt[n]{T}}$$

be differentiated, we see that the highest degree of  $x$  in  $\Theta$  must be one greater than that in  $M$ . Hence, by the method of indeterminate coefficients the integral, if it is algebraic, can be found; or else it can be shown to be impossible under such a form.

Again, if  $t, u, v, \dots$  be algebraic functions of  $x$ , the differential of

$$t + A \log u + B \log v + \dots,$$

where  $A, B, C$  are constants, is evidently algebraic. The converse theorem was investigated by Abel, viz., when  $y$  is algebraic, to find when  $\int y dx$  can be expressed by algebraic and logarithmic functions. He showed that if

$$\int y dx = t + A \log u + B \log v + C \log w + \dots,$$

then the functions  $t, u, v, \dots$  are capable of being expressed as integer functions of  $y$ .

Abel's theorem was extended by Liouville, who started from supposing

$$\int y dx = F(x, e^x, e^{\sigma x}, \log x, \dots),$$

where  $u, v, w, \dots$  are algebraic functions of  $x$ . He proved that, when  $y$  is algebraic, the expression for its integral cannot contain an exponential, such as  $e^x$ . Also that a logarithmic function, such as  $\log w$ , cannot enter into the integral except in a linear form with a constant coefficient.

In particular, it is shown by Abel that whenever  $\int \frac{P dx}{\sqrt{R}}$  is expressible explicitly, it must be of the form

$$\int \frac{P dx}{\sqrt{R}} = \frac{\Theta}{\sqrt{R}} + A \log \frac{\alpha + \beta \sqrt{R}}{\alpha - \beta \sqrt{R}} + B \log \frac{\gamma + \delta \sqrt{R}}{\gamma - \delta \sqrt{R}} + \dots,$$

in which  $P$  and  $R$  are integral polynomial functions of  $x$ .

*Definite Integrals.*

133. The investigations have thus far been chiefly limited to what are styled indefinite integrals. It is plain from §107 that, whenever the expression  $\phi(x)$  remains finite between the limits of integration, its definite integral, taken between those limits, can be determined whenever its indefinite integral is known.

For instance, since

$$\int \frac{dx}{1 + 2x \cos a + x^2} = \frac{1}{\sin a} \tan^{-1} \left( \frac{x + \cos a}{\sin a} \right),$$

we have

$$\int_0^1 \frac{dx}{1 + 2x \cos a + x^2} = \frac{1}{\sin a} \left\{ \tan^{-1} \frac{1 + \cos a}{\sin a} - \tan^{-1} \frac{\cos a}{\sin a} \right\} = \frac{\pi}{2 \sin a}.$$

Also (Ex. 8, § 113),

$$\int \frac{dx}{1 + \cos a \cos x} = \frac{2}{\sin a} \tan^{-1} \left( \tan \frac{a}{2} \tan \frac{x}{2} \right).$$

Accordingly  $\int_0^\pi \frac{dx}{1 + \cos a \cos x} = \frac{\pi}{\sin a}$ ;

or  $\int_0^\pi \frac{dx}{1 + k \cos x} = \frac{\pi}{\sqrt{1-k^2}}$ , when  $k < 1$ .

From this we readily get

$$\int_0^{\frac{\pi}{2}} \frac{dx}{a^2 \cos^2 x + b^2 \sin^2 x} = \frac{\pi}{2ab}.$$

134. As definite integrals have frequently to be considered in which we regard one or both of the limits as infinite, it is necessary to determine whether the equation

$$\int_{x_0}^X F(x) dx = F(X) - F(x_0)$$

holds for infinite limits.

Suppose when  $X$  becomes infinitely great that  $F(x)$  approaches a finite limit, represented by  $F(\infty)$ , then

$$\lim_{X=\infty} \int_{x_0}^X F(x) dx = \lim_{X=\infty} \{ F(X) - F(x_0) \} = F(\infty) - F(x_0).$$

Consequently the formula holds in this case.

In like manner if, when  $x$  becomes  $-\infty$ ,  $F(x)$  tends to a finite value  $F(-\infty)$ , we have

$$\int_{-\infty}^X F(x) dx = F(X) - F(-\infty).$$

Also  $\int_{-\infty}^{+\infty} F(x) dx = F(\infty) - F(-\infty)$ .

Hence, when  $F'(x)$  remains finite between the limits, and  $F(x)$  has determinate values for both limits, the equation

$$\int_{x_0}^X F'(x) dx = F(x) - F(x_0)$$

always holds.

For example, in the integral

$$\int \frac{dx}{a^2 + x^2} = \frac{1}{a} \tan^{-1} \left( \frac{x}{a} \right),$$

when  $x = \infty$ ,  $\tan^{-1} \left( \frac{x}{a} \right)$  has for its limit  $\frac{\pi}{2}$ , and when  $x = -\infty$ ,  $\tan^{-1} \frac{x}{a}$  has for limit  $-\frac{\pi}{2}$ ; hence

$$\int_0^\infty \frac{dx}{a^2 + x^2} = \frac{\pi}{2a}, \quad \int_{-\infty}^\infty \frac{dx}{a^2 + x^2} = \frac{\pi}{a}.$$

Also, from the integrals given in § 114, we get

$$\int_0^\infty e^{-ax} \cos bx dx = \frac{a}{a^2 + b^2}, \quad \int_0^\infty e^{-ax} \sin bx dx = \frac{b}{a^2 + b^2}.$$

Again, in Ex. 4, § 113, we have

$$F'(0) = \frac{b}{(ac - b^2)\sqrt{a}}, \quad F'(\infty) = \frac{\sqrt{c}}{ac - b^2},$$

$$\therefore \int_0^\infty \frac{dx}{(a + 2bx + cx^2)^{\frac{3}{2}}} = \frac{1}{ac^{\frac{1}{2}} + ba^{\frac{1}{2}}}.$$

In like manner, from Ex. 5, § 117, we get

$$\int_0^\infty \frac{dx}{a + 2bx^2 + cx^4} = \frac{\pi}{2\sqrt{akh}}, \quad \text{where } h = 2(\sqrt{ac} + b).$$

It may be noted that if  $F(x)$  approaches a finite value  $F(\infty)$  as  $x$  approaches  $\infty$  the derived function  $F'(x)$  must vanish at the same time.

135. As a further example, let us consider the definite integral

$$\int_{-1}^{+1} \phi(x) X_n dx,$$

where  $\phi(x)$  is an arbitrary polynomial of the degree  $n-1$  in  $x$ , and  $X_n$  is the coefficient of  $a^n$  in the expansion of  $(1 - 2ax + a^2)^{\frac{1}{2}}$ .

It has been shown (§ 56) that

$$X_n = \frac{1}{2 \cdot 4 \cdot 6 \dots 2n} \left(\frac{d}{dx}\right)^n (x^2 - 1)^n.$$

Again, by the method of § 116, we have

$$\int dx \phi(x) \left(\frac{d}{dx}\right)^n (x^2 - 1)^n = \Theta + (-1)^n \int dx (x^2 - 1)^n \left(\frac{d}{dx}\right)^n \phi(x);$$

moreover,  $\left(\frac{d}{dx}\right)^n \phi(x) = 0$  by hypothesis, and when the limits  $+1$  and  $-1$  are substituted each term in  $\Theta$  vanishes separately; hence we have

$$\int_{-1}^{+1} \phi(x) X_n dx = 0.$$

From this it is readily seen that so long as  $m$  and  $n$  are unequal we have

$$\int_{-1}^{+1} X_m X_n dx = 0.$$

136. There are many integrals which are capable of being determined between certain definite limits without any previous knowledge of the corresponding indefinite integral, and even in cases where the consideration of the indefinite integral would lead to the introduction of a higher transcendental function. Examples of this class will be met with further on.

137. Next, reverting to our original definition (§ 106), we have

$\int_{x_0}^X f(x) dx = \lim \left[ (x_1 - x_0)f(x_0) + (x_2 - x_1)f(x_1) + \dots + (X - x_{n-1})f(x_{n-1}) \right]$ , in which  $f(x)$  is supposed to be continuous between the limits  $x_0$  and  $X$ . If now  $A$  represents the least and  $B$  the greatest value of  $f(x)$  between these limits, it is plain that

$(x_1 - x_0)f(x_0) + (x_2 - x_1)f(x_1) + \dots + (X - x_{n-1})f(x_{n-1})$  is greater than  $(X - x_0)A$ , and less than  $(X - x_0)B$ .

Hence  $\int_{x_0}^X f(x) dx = (X - x_0)M$ , where  $M > A$  and  $M < B$ .

Again, when  $f(x)$  is a continuous function, in passing from one limit to the other it varies so as always to lie between the values  $A$  and  $B$ . Consequently for some value  $\xi$ , of  $x$ , we must have  $f(\xi) = M$ , where  $\xi$  lies between  $x_0$  and  $X$ , i. e.,  $\xi$  is of the form  $x_0 + \theta(X - x_0)$ , where  $\theta$  is positive and less than unity. Hence, whenever  $f(x)$  is finite and continuous between the limits  $x_0$  and  $X$ , we have

$$\int_{x_0}^X f(x) dx = (X - x_0) f(x_0 + \theta(X - x_0)).$$

In like manner it is shown that

$$\int_{x_0}^X f(x) \phi(x) dx = f(x_0 + \theta(X - x_0)) \int_{x_0}^X \phi(x) dx,$$

provided  $f(x)$  and  $\phi(x)$  are finite and continuous between the limits  $x_0$  and  $X$ , and  $\phi(x)$  has always the same sign between these limits.

For example, let  $\phi(x) = \frac{1}{x-a}$ , and write  $f(x)$  instead of  $\frac{f(x)}{x-a}$ , then

$$\int_{x_0}^X f(x) dx = (\xi - a) f(\xi) \log \frac{X-a}{x_0-a},$$

in which we suppose that  $X-a$ ,  $x_0-a$  have the same sign, and  $\xi$  lies between  $x_0$  and  $X$ .

In particular, if  $a=0$ , we have

$$\int_{x_0}^X f(x) dx = \xi f(\xi) \log \frac{X}{x_0}.$$

138. Taylor's Theorem.—The method of definite integrals furnishes us with a simple demonstration of Taylor's series.

For, if in the equation

$$f(X+h) - f(X) = \int_X^{X+h} f'(x) dx$$

we substitute  $X+h-z$  for  $x$ , we get

$$f(X+h) - f(X) = \int_0^h f'(X+h-z) dz$$

Integrating by parts, we have

$$\int f'(X+h-z) dz = z f'(X+h-z) + \int z f''(X+h-z) dz;$$

hence

$$f(X+h) - f(X) = h f'(X) + \int_0^h f''(X+h-z) z dz.$$

Again,

$$\int_0^h f''(X+h-z) z dz = \frac{h^2}{1.2} f''(X) + \int_0^h f'''(X+h-z) \frac{z^2 dz}{1.2},$$

and so on.

Hence we get finally

$$f(X+h) = f(X) + \frac{h}{1} f'(X) + \frac{h^2}{1.2} f''(X) + \dots + \frac{h^{n-1}}{(n-1)} f^{(n-1)}(X) + \int_0^h f^{(n)}(X+h-z) \frac{z^{n-1} dz}{(n-1)}.$$

Accordingly the remainder,  $R_n$ , after  $n$  terms, in Taylor's series, is represented by the definite integral

$$\frac{1}{(n-1)} \int_0^h f^{(n)}(X+h-z) z^{n-1} dz.$$

This value of  $R_n$  can be identified with that given in § 46, for by § 137 we have

$$R_n = \frac{U}{(n-1)} \int_0^h z^{n-1} dz = U \frac{h^n}{n},$$

where  $U$  lies between the greatest and least values of  $f^{(n)}(X+h-z)$  between the limits 0 and  $h$  for  $z$ .

Hence, since any value of  $z$  between 0 and  $h$  may be represented by  $(1-\theta)h$ , where  $\theta > 0$  and  $< 1$ , we have

$$R_n = \frac{h^n}{n} f^{(n)}(X + \theta h).$$

139. Thus far the function  $f(x)$  under the sign of integration has been supposed to have a finite value for all values of  $x$  between the limits of integration.

Let the indefinite integral of  $f(x) dx$  be denoted by  $F(x)$  and suppose  $f(x) = \infty$  when  $x = a$ , where  $a$  lies between the limits  $X$  and  $x_0$ ; then, decomposing the integral into two parts, we have

$$\int_{x_0}^X f(x) dx = \lim_{x=a} \int_{x_0}^x f(x) dx + \lim_{x=a} \int_x^X f(x) dx = \left[ \lim_{x=a} F(x) - F(x_0) \right] + \left[ F(X) - \lim_{x=a} F(x) \right]$$

Accordingly, whenever  $F(a)$  has a finite and determinate value, we have

$$\int_{x_0}^X f(x) dx = F(X) - F(x_0).$$

This result also holds if  $f(x)$  becomes infinite at one of the limits, provided  $F(x)$  is finite and determinate at the same time

For example, the expression  $\frac{1}{\sqrt{(a-x)(x-\beta)}}$  becomes infinite when  $x = a$ , and also when  $x = \beta$ ; but (Ex. 6, § 113)  $F(a) = \pi$ ,  $F(\beta) = 0$ ,

$$\therefore \int_{\beta}^a \frac{dx}{\sqrt{(a-x)(x-\beta)}} = \pi.$$

140. The complete discussion of the exceptional cases in definite integrals is due to Cauchy. We purpose here to give a brief account of his method.

Suppose that the function  $f(x)$  becomes infinite for the particular values of  $x$  represented by  $x_1, x_2, \dots, x_n$ , lying between the limits of integration; then we have

$$\int_{x_0}^X f(x) dx = \int_{x_0}^{x_1} f(x) dx + \int_{x_1}^{x_2} f(x) dx + \dots + \int_{x_n}^X f(x) dx = \lim \left\{ \int_{x_0}^{x_1-\mu_1\epsilon} f(x) dx + \int_{x_1+\nu_1\epsilon}^{x_2-\mu_2\epsilon} f(x) dx + \dots + \int_{x_n+\nu_n\epsilon}^X f(x) dx \right\};$$

where  $\epsilon$  denotes an infinitely small quantity, and  $\mu_1, \nu_1, \mu_2, \nu_2, \dots, \nu_n$ , are positive constants, but arbitrary.

In addition, if the limits  $X$  and  $x_0$  become  $+\infty$  and  $-\infty$ , we write

$$\int_{-\infty}^{+\infty} f(x)dx = \lim. \left\{ \int_{-\frac{1}{\mu\epsilon}}^{x_1 - \mu_1\epsilon} f(x)dx + \int_{x_1 + \nu_1\epsilon}^{x_2 - \mu_2\epsilon} f(x)dx \dots \right. \\ \left. + \int_{x_n + \nu_n\epsilon}^{\frac{1}{\nu\epsilon}} f(x)dx \right\},$$

in which  $\mu, \nu$  are new positive arbitrary constants. In all cases, the *general values* of the definite integrals

$$\int_{x_0}^X f(x)dx, \quad \int_{-\infty}^{+\infty} f(x)dx,$$

deduced from the preceding equations, depend on the form of the function  $f(x)$ , and may be finite and determinate, or infinite, or indeterminate, depending on the values attributed to the arbitrary constants  $\mu, \nu, \mu_1, \nu_1, \dots, \mu_n, \nu_n$ .

Whenever the integrals become indeterminate, if each of the constants  $\mu, \nu, \dots, \mu_n, \nu_n$  be made unity, the corresponding values of

$$\int_{x_0}^X f(x)dx \text{ and } \int_{-\infty}^{+\infty} f(x)dx$$

become

$$\lim. \left[ \int_{x_0}^{x_1 - \epsilon} f(x)dx + \int_{x_1 + \epsilon}^{x_2 - \epsilon} f(x)dx \dots + \int_{x_n + \epsilon}^X f(x)dx \right]$$

and

$$\lim. \left[ \int_{-\frac{1}{\mu\epsilon}}^{x_1 - \epsilon} f(x)dx + \int_{x_1 + \epsilon}^{x_2 - \epsilon} f(x)dx \dots + \int_{x_n + \epsilon}^{\frac{1}{\nu\epsilon}} f(x)dx \right].$$

These are called, by Cauchy, the *principal values* of the definite integrals

$$\int_{x_0}^X f(x)dx \text{ and } \int_{-\infty}^{+\infty} f(x)dx,$$

in the case in question.

Again, the definite integral

$$\int_a^b f(x)dx,$$

if  $f(x)$  be finite when  $x = a$ , is infinitely small if the difference between the limits  $a$  and  $b$  is an evanescent quantity.

But, if  $f(x)$  become infinitely great at the same time, the value of the definite integral may be finite, or even infinite. In the latter cases the integral is called a *singular definite integral*.

For instance, if  $f(x_1) = \infty$ , the integral

$$\int_{x_1 - \epsilon}^{x_1 - \mu_1\epsilon} f(x)dx,$$

where  $\epsilon$  is an infinitesimal, is of this class. Its value may be represented by the method of § 137; for, if  $f_1$  denote the limit of  $(x - x_1)f(x)$  when  $x = x_1$ , we have

$$\int_{x_1 - \epsilon}^{x_1 - \mu_1\epsilon} f(x)dx = f_1 \log \frac{1}{\mu_1}.$$

Similarly

$$\int_{x_1 + \nu_1\epsilon}^{x_1 + \epsilon} f(x)dx = f_1 \log \frac{1}{\nu_1}.$$

Again, if the limits  $a$  and  $b$  each become infinite, while preserving the same sign, we have another class of singular definite integrals, such as

$$\int_{\frac{1}{\nu\epsilon}}^{\frac{1}{\mu\epsilon}} f(x)dx, \quad \int_{-\frac{1}{\mu\epsilon}}^{-\frac{1}{\nu\epsilon}} f(x)dx,$$

in which  $\epsilon$  is considered evanescent as before.

In this, as in the former case, if  $x f(x)$  tend to a limiting value  $f$ , when  $x$  is infinitely great, we shall have

$$\int_{\frac{1}{\nu\epsilon}}^{\frac{1}{\mu\epsilon}} f(x)dx = f \log \left( \frac{1}{\nu} \right), \quad \int_{-\frac{1}{\mu\epsilon}}^{-\frac{1}{\nu\epsilon}} f(x)dx = f \log \mu.$$

141. We shall illustrate the preceding by a few simple examples commencing with the definite integral

$$\int_{-x_0}^X \frac{dx}{x}.$$

Here the function  $\frac{1}{x}$  becomes infinite when  $x = 0$ , and we have

$$\int_{-x_0}^X \frac{dx}{x} = \int_{-x_0}^0 \frac{dx}{x} + \int_0^X \frac{dx}{x} \\ = \lim. \left[ \int_{-x_0}^{-\mu\epsilon} \frac{dx}{x} + \int_{\nu\epsilon}^X \frac{dx}{x} \right],$$

but

$$\int_{\nu\epsilon}^X \frac{dx}{x} = \log \frac{X}{\nu\epsilon}, \quad \int_{-x_0}^{-\mu\epsilon} \frac{dx}{x} = \int_{x_0}^{\mu\epsilon} \frac{dz}{z} = \log \left( \frac{\mu\epsilon}{x_0} \right);$$

$$\therefore \lim. \left[ \int_{-x_0}^{-\mu\epsilon} \frac{dx}{x} + \int_{\nu\epsilon}^X \frac{dx}{x} \right] = \log \frac{X}{x_0} + \log \left( \frac{\mu}{\nu} \right).$$

Accordingly, the principal value of  $\int_{-x_0}^X \frac{dx}{x}$  is  $\log \left( \frac{X}{x_0} \right)$ , and its general value is  $\log \frac{X}{x_0} + \log \frac{\mu}{\nu}$ . The latter is perfectly arbitrary and indeterminate.

Again, each of the singular definite integrals

$$\int_{\nu\epsilon}^{\frac{1}{\mu\epsilon}} \frac{dx}{x}, \quad \int_{\frac{1}{\nu\epsilon}}^{\frac{1}{\mu\epsilon}} \frac{dx}{x},$$

is equal to  $\log \frac{1}{\nu}$ .

Next 
$$\int_{-x_0}^X \frac{dx}{x^2} = \lim. \left[ \int_{-x_0}^{-\mu\epsilon} \frac{dx}{x^2} + \int_{\nu\epsilon}^X \frac{dx}{x^2} \right].$$

But 
$$\int_{-x_0}^{-\mu\epsilon} \frac{dx}{x^2} = \frac{1}{\mu\epsilon} - \frac{1}{x_0}, \quad \int_{\nu\epsilon}^X \frac{dx}{x^2} = \frac{1}{\nu\epsilon} - \frac{1}{X};$$

$$\therefore \int_{-x_0}^X \frac{dx}{x^2} = \lim. \left[ \frac{1}{\mu\epsilon} + \frac{1}{\nu\epsilon} - \frac{1}{x_0} - \frac{1}{X} \right].$$

Consequently, the principal value and the general value of the definite integral are both infinite in this case.

In like manner

$$\int_{-x_0}^X \frac{dx}{x^3} = \lim. \frac{1}{2} \left( \frac{1}{\nu^2\epsilon^2} - \frac{1}{\mu^2\epsilon^2} + \frac{1}{x_0^2} - \frac{1}{X^2} \right).$$

Accordingly, the general value of the integral is infinite, while its principal value is  $\frac{1}{2} \left( \frac{1}{x_0^2} - \frac{1}{X^2} \right)$ .

Next let us consider the singular definite integral

$$\int_{\frac{1}{\nu\epsilon}}^{\frac{1}{\mu\epsilon}} \frac{(x-a)dx}{(x-a)^2 + b^2}.$$

Here 
$$\int \frac{(x-a)dx}{(x-a)^2 + b^2} = \frac{1}{2} \log \{ (x-a)^2 + b^2 \}.$$

If we substitute the proposed limits and afterwards make  $\epsilon = 0$ , we readily find the value of the proposed to be  $\log \left( \frac{1}{\nu} \right)$ —an indeterminate quantity, as  $\nu$  is by hypothesis supposed to be arbitrary. Likewise

$$\int_{-\infty}^{+\infty} \frac{(x-a)dx}{(x-a)^2 + b^2} = \lim. \int_{-\frac{1}{\mu\epsilon}}^{\frac{1}{\nu\epsilon}} \frac{(x-a)dx}{(x-a)^2 + b^2} = \log \frac{\mu}{\nu}, \text{ when } \epsilon = 0.$$

Accordingly the general value of

$$\int_{-\infty}^{+\infty} \frac{(x-a)dx}{(x-a)^2 + b^2}$$

is perfectly arbitrary, while its principal value is zero.

In like manner, since

$$\int \frac{dx}{(x-a)^2 + b^2} = \frac{1}{b} \tan^{-1} \left( \frac{x-a}{b} \right),$$

we find the general and also the principal value of

$$\int_{-\infty}^{+\infty} \frac{dx}{(x-a)^2 + b^2} = \frac{\pi}{b}.$$

Again, it readily follows from the last result that, when  $ac > b^2$ , the value of the definite integral

$$\int_{-\infty}^{\infty} \frac{dx}{a + 2bx + cx^2} \text{ is } \frac{\pi}{\sqrt{ac - b^2}}.$$

142. Next let us consider the definite integral

$$u = \int_0^{\infty} \frac{\phi(ax) - \phi(bx)}{x} dx.$$

Here

$$u = \lim. \int_{\nu\epsilon}^{\frac{1}{\mu\epsilon}} \frac{\phi(ax) - \phi(bx)}{x} dx.$$

But

$$\int_{\nu\epsilon}^{\frac{1}{\mu\epsilon}} \frac{\phi(ax)}{x} dx = \int_{a\nu\epsilon}^{\frac{a}{\mu\epsilon}} \frac{\phi(z)}{z} dz, \text{ making } ax = z.$$

Also

$$\int_{\nu\epsilon}^{\frac{1}{\mu\epsilon}} \frac{\phi(bx)}{x} dx = \int_{b\nu\epsilon}^{\frac{b}{\mu\epsilon}} \frac{\phi(z)}{z} dz.$$

$$\therefore u = \lim. \int_{\frac{b}{\mu\epsilon}}^{\frac{a}{\mu\epsilon}} \frac{\phi(z)dz}{z} + \lim. \int_{a\nu\epsilon}^{b\nu\epsilon} \frac{\phi(z)dz}{z},$$

where  $\epsilon$  is infinitely small.



The limit of the latter integral, as already seen, is  $\phi(0) \log \left( \frac{a}{b} \right)$ . Also, whenever  $\phi(z)$  tends to a definite limiting value  $\phi(\infty)$  when  $z$  is infinite, we have

$$\int_0^{\infty} \frac{\phi(z) dz}{z} = \phi(\infty) \log \left( \frac{a}{b} \right).$$

$$\therefore \int_0^{\infty} \frac{\phi(ax) - \phi(bx)}{x} dx = \{\phi(\infty) - \phi(0)\} \log \left( \frac{a}{b} \right),$$

in this case.

Again, whenever  $\int_0^{\infty} \frac{\phi(z) dz}{z}$  is zero we have

$$\int_0^{\infty} \frac{\phi(ax) - \phi(bx)}{x} dx = \phi(0) \log \left( \frac{b}{a} \right).$$

In the latter form this result is called Frullani's theorem, having been communicated by Frullani to Plana in 1821, and subsequently published in *Mem. del. Soc. Ital.*, 1823.

These results, though limited as to their generality, contain many particular integrals under them.

For example, since  $e^{-ax}$  becomes 0 when  $x = \infty$ , and 1 when  $x = 0$ , we have

$$\int_0^{\infty} \frac{e^{-ax} - e^{-bx}}{x} dx = \log \frac{b}{a}.$$

Again, when  $x = 0$ ,  $\tan^{-1}(ax)$  becomes 0; and when  $x = \infty$ ,  $\tan^{-1}ax = \frac{\pi}{2}$ . Consequently we have

$$\int_0^{\infty} \frac{\tan^{-1}ax - \tan^{-1}bx}{x} dx = \frac{\pi}{2} \log \frac{a}{b}.$$

Also, from the periodic character of  $\cos z$ , it is readily seen that

$$\int_0^{\frac{a}{\mu\epsilon}} \frac{\cos z}{z} dz$$

vanishes when  $\epsilon = 0$ .

Hence 
$$\int_0^{\infty} \frac{\cos ax - \cos bx}{x} dx = \log \frac{a}{b}$$

In like manner we have

$$\int_0^{\infty} \frac{\log(m + ne^{-ax}) - \log(m + ne^{-bx})}{x} dx = \log \left( 1 + \frac{m}{n} \right) \log \frac{a}{b}.$$

Frullani's theorem has attracted considerable attention recently, and many remarkable applications, both in single and multiple integrals, have been given by Mr Elliott, Mr Lendesdorf, and others, chiefly in the *Proceedings of the London Mathematical Society* 1876, 1877, 1878.

143. The consideration of singular definite integrals furnishes a method for the calculation of the general value of a definite integral when its principal value is known.

Thus, if A be the general value and B the principal value of  $\int_{x_0}^X f(x) dx$ , where  $f(x)$  is supposed to become infinite for the values  $x_1, x_2, \dots, x_n$  of  $x$ , then the difference  $A - B$ , from the preceding investigation, will consist of the sum of the singular definite integrals

$$\int_{x_1-\epsilon}^{x_1+\mu\epsilon} f(x) dx, \int_{x_1+\nu_1\epsilon}^{x_1+\epsilon} f(x) dx, \dots$$

Consequently if  $f_1, f_2, \dots, f_n$ , as before, denote the limiting values of

$$(x - x_1)f(x), (x - x_2)f(x), \dots, (x - x_n)f(x),$$

when  $x = x_1, x = x_2, \dots, x = x_n$ , respectively, we shall have

$$A - B = f_1 \log \frac{\mu_1}{\nu_1} + f_2 \log \frac{\mu_2}{\nu_2} + \dots + f_n \log \frac{\mu_n}{\nu_n}.$$

Accordingly, in order that the definite integral  $\int_{x_0}^X f(x) dx$  should have a finite and determinate value it is necessary that the quantities  $f_1, f_2, \dots, f_n$  should each be evanescent.

When the limits  $X$  and  $x_0$  are  $+\infty$  and  $-\infty$ , to the value of  $A - B$  here given we must add the term  $f \log \frac{\mu}{\nu}$ , provided  $x f(x)$ , as  $x$  becomes infinitely great, tends to a definite limiting value  $f$ .

144. For example, if  $\frac{f(x)}{F(x)}$  be a rational algebraic function, then the integral  $\int_{-\infty}^{+\infty} \frac{f(x)}{F(x)} dx$  has a finite and determinate value, provided (1) the equation  $F(x) = 0$  has no real roots, and (2) the de-

gree of  $x$  in the denominator  $F(x)$  exceeds that of the numerator  $f(x)$  by two at least. For the former condition implies that  $\frac{f(x)}{F(x)}$  does not become infinite for any real finite value of  $x$ , and it follows from the latter condition that  $\frac{xf(x)}{F(x)}$  becomes evanescent when  $x$  becomes infinite.

In order to find the value of  $\int_{-\infty}^{+\infty} \frac{f(x)}{F(x)} dx$  in this case, we suppose

$$\frac{A(x-a)+B}{(x-a)^2+b^2}$$

to represent the partial fraction corresponding to a pair of conjugate roots  $a \pm ib$  of the equation  $F(x) = 0$ ; then, as we have shown that the general and the principal values of the definite integral are the same in this case, we may write

$$\int_{-\infty}^{+\infty} \frac{f(x)}{F(x)} dx = \lim_{\epsilon \rightarrow 0} \int_{-\frac{1}{\epsilon}}^{+\frac{1}{\epsilon}} \frac{f(x)}{F(x)} dx$$

$$= \lim_{\epsilon \rightarrow 0} \sum \int_{-\frac{1}{\epsilon}}^{+\frac{1}{\epsilon}} \frac{A(x-a)+B}{(x-a)^2+b^2} dx.$$

But we have already seen that

$$\int_{-\frac{1}{\epsilon}}^{+\frac{1}{\epsilon}} \frac{(x-a)dx}{(x-a)^2+b^2} = 0, \text{ and } \int_{-\frac{1}{\epsilon}}^{+\frac{1}{\epsilon}} \frac{dx}{(x-a)^2+b^2} = \frac{\pi}{b}.$$

Consequently

$$\int_{-\infty}^{+\infty} \frac{f(x)}{F(x)} dx = \pi \sum \frac{B}{b}$$

$$= \pi \left( \frac{B_1}{b_1} + \frac{B_2}{b_2} + \dots + \frac{B_n}{b_n} \right),$$

where  $B_1, b_1, B_2, b_2, \dots, B_n, b_n$  represent the constants corresponding to the  $n$  pairs of imaginary roots in the equation  $F(x) = 0$ .

As an example, let us consider the definite integral

$$\int_{-\infty}^{+\infty} \frac{x^{2m} dx}{1+x^{2n}},$$

where  $m$  and  $n$  are positive integers, of which  $n$  is the greater.

By aid of the theory of equations it can be shown without difficulty that

$$\frac{B_1}{b_1}, \frac{B_2}{b_2}, \dots, \frac{B_n}{b_n}$$

are respectively equal to

$$\frac{\sin \theta}{n}, \frac{\sin 3\theta}{n}, \dots, \frac{\sin (2n-1)\theta}{n},$$

where

$$\theta = \frac{2m+1}{2n} \pi.$$

Consequently we have

$$\frac{B_1}{b_1} + \frac{B_2}{b_2} + \dots + \frac{B_n}{b_n} = \frac{1}{n} [\sin \theta + \sin 3\theta + \dots + \sin (2n-1)\theta]$$

$$= \frac{1}{n \sin \frac{2m+1}{2n} \pi}.$$

Accordingly 
$$\int_{-\infty}^{+\infty} \frac{x^{2m} dx}{1+x^{2n}} = \frac{\pi}{n \sin \frac{2m+1}{2n} \pi}.$$

Hence it follows immediately that

$$\int_0^{\infty} \frac{x^{2m} dx}{1+x^{2n}} = \frac{\pi}{2n \sin \frac{2m+1}{2n} \pi}.$$

By a corresponding investigation it can be shown that

$$\int_0^{\infty} \frac{x^{2m} dx}{1-x^{2n}} = \frac{\pi}{2n} \cot \frac{2m+1}{2n} \pi.$$

These results are readily transformed into

$$\int_0^{\infty} \frac{x^{\alpha-1} dx}{1+x} = \frac{\pi}{\sin \alpha \pi}, \text{ and } \int_0^{\infty} \frac{x^{\alpha-1} dx}{1-x} = \pi \cot \alpha \pi,$$

where  $\alpha$  is less than unity.

A few simple examples are added.

(1) To show that  $\int_0^{\infty} \frac{dx}{(1-x^2)(a^2+\beta^2x^2)}$  is equal to  $\frac{\pi}{2a(a+\beta)}$ .

(2) If  $n$  be less than unity, the equations

$$\int_0^1 \frac{x^n + x^{-n}}{x^2 + 1} dx = \frac{\pi}{2} \sec \frac{n\pi}{2},$$

$$\int_0^1 \frac{x^n - x^{-n}}{x^2 - 1} dx = \frac{\pi}{2} \tan \frac{n\pi}{2},$$

can be readily established.

(3) If  $a < \pi$ , by a simple transformation it can be shown that

$$\int_0^\infty \frac{e^{ax} + e^{-ax}}{e^{\pi x} + e^{-\pi x}} dx = \frac{1}{2} \sec \frac{a}{2},$$

$$\int_0^\infty \frac{e^{ax} - e^{-ax}}{e^{\pi x} - e^{-\pi x}} dx = \frac{1}{2} \tan \frac{a}{2}.$$

(4) If  $a + b < \pi$ , we can prove the equation

$$\int_0^\infty \frac{(e^{ax} + e^{-ax})(e^{bx} + e^{-bx})}{e^{\pi x} + e^{-\pi x}} dx = \frac{2 \cos \frac{a}{2} \cos \frac{b}{2}}{\cos a + \cos b}.$$

(5) To find the value of

$$\int_0^1 \frac{dx}{(1-x^6)^{\frac{1}{2}}},$$

Assume

$$1 - x^6 = \frac{1}{1 + y^6},$$

$$\log(1 - x^6) = -\log(1 + y^6),$$

$$\frac{x^2 dx}{1 - x^6} = \frac{y^5 dy}{1 + y^6}; \text{ but } y^5 = \frac{x^5}{(1 - x^6)^{\frac{5}{6}}}.$$

$$\therefore \int_0^1 \frac{dx}{(1 - x^6)^{\frac{1}{2}}} = \int_0^\infty \frac{dy}{1 + y^6} = \frac{\pi}{3}.$$

(6) In like manner  $\int_0^1 \frac{dx}{(1 - x^{2n})^{\frac{1}{2}}} = \frac{\pi}{2n \sin \frac{\pi}{2n}}$

145. We now propose to consider some of the general methods of evaluating definite integrals. It is obvious that the value of the definite integral

$$\int_a^b f(x) dx$$

is independent of the variable  $x$ , and is a function of the limits  $a$  and  $b$ , as also of any constant parameters contained in the function  $f(x)$ . We proceed to show that a definite integral may be differentiated, and also integrated, with respect to any such parameter.

*Differentiation under the Sign of Integration.*

146. Suppose the function  $f(x)$  to contain a constant parameter  $\alpha$ ; i.e., let  $f(x) = \phi(x, \alpha)$ ; then, denoting the definite integral by  $u$ , we have

$$u = \int_a^b \phi(x, \alpha) dx.$$

Also, let the limits  $a$  and  $b$  be independent of  $\alpha$ ; then, if  $\Delta u$  denote the change in  $u$  arising from the change  $\Delta \alpha$  in  $\alpha$ , we get

$$\Delta u = \int_a^b \{ \phi(x, \alpha + \Delta \alpha) - \phi(x, \alpha) \} dx,$$

$$\therefore \frac{\Delta u}{\Delta \alpha} = \int_a^b \frac{\phi(x, \alpha + \Delta \alpha) - \phi(x, \alpha)}{\Delta \alpha} dx.$$

Hence, passing to the limit,

$$\frac{du}{d\alpha} = \int_a^b \frac{d\phi(x, \alpha)}{d\alpha} dx.$$

This principle is called *differentiation under the sign of integration*, and, by aid of it, from any known integral a number of others can in general be determined by differentiation with respect to the constants contained in the integral.

For example, if we differentiate the equation

$$\int_0^\infty e^{-ax} dx = \frac{1}{a},$$

we get

$$\int_0^\infty e^{-ax} dx = \frac{1}{a^2};$$

and, by  $n$  successive differentiations,

$$\int_0^\infty e^{-ax} dx = \frac{1 \cdot 2 \cdot 3 \cdot \dots \cdot n}{a^{n+1}}.$$

Again, if the equation

$$\int_{-\infty}^{+\infty} \frac{dx}{a + 2bx + cx^2} = \frac{\pi}{\sqrt{ac - b^2}}$$

be differentiated with respect to  $a, b, c$  respectively, we have

$$\int_{-\infty}^{+\infty} \frac{dx}{(a + 2bx + cx^2)^2} = \frac{\pi c}{2(ac - b^2)^{\frac{3}{2}}},$$

$$\int_{-\infty}^{+\infty} \frac{xdx}{(a + 2bx + cx^2)^2} = -\frac{\pi b}{2(ac - b^2)^{\frac{3}{2}}},$$

$$\int_{-\infty}^{+\infty} \frac{x^2 dx}{(a + 2bx + cx^2)^2} = \frac{\pi a}{2(ac - b^2)^{\frac{3}{2}}}.$$

Hence

$$\int_{-\infty}^{+\infty} \frac{(a' + 2b'x + c'x^2) dx}{(a + 2bx + cx^2)^2} = \frac{\pi(ac' + a'c - 2bb')}{2(ac - b^2)^{\frac{3}{2}}}.$$

A number of other definite integrals can be immediately deduced from these by successive differentiation.

Again, since  $\int_0^\infty \frac{dx}{(a^2 + 2bx + cx^2)^{\frac{1}{2}}} = \frac{1}{ha^{\frac{1}{2}}}$ ,

where  $h = \sqrt{ac} + b$ , we get, by differentiation,

$$\int_0^\infty \frac{dx}{(a + 2bx + cx^2)^{\frac{3}{2}}} = \frac{2h - b}{3h^2 a^{\frac{3}{2}}},$$

$$\int_0^\infty \frac{xdx}{(a + 2bx + cx^2)^{\frac{3}{2}}} = \frac{1}{3h^2 a^{\frac{3}{2}}},$$

$$\int_0^\infty \frac{x^2 dx}{(a + 2bx + cx^2)^{\frac{3}{2}}} = \frac{1}{3h^2 c^{\frac{3}{2}}}.$$

In like manner, if the equation

$$\int_0^{\frac{\pi}{2}} \frac{dx}{a^2 \cos^2 x + \beta^2 \sin^2 x} = \frac{\pi}{2a\beta}$$

be differentiated with respect to  $a$  and  $\beta$  respectively, we get

$$\int_0^{\frac{\pi}{2}} \frac{\cos^2 x dx}{(a^2 \cos^2 x + \beta^2 \sin^2 x)^2} = \frac{\pi}{4a^3 \beta},$$

$$\int_0^{\frac{\pi}{2}} \frac{\sin^2 x dx}{(a^2 \cos^2 x + \beta^2 \sin^2 x)^2} = \frac{\pi}{4a\beta^3}.$$

Hence, by addition,

$$\int_0^{\frac{\pi}{2}} \frac{dx}{(a^2 \cos^2 x + \beta^2 \sin^2 x)^2} = \frac{\pi(a^2 + \beta^2)}{4a^3 \beta^3}.$$

From these other definite integrals can be readily found by further differentiation.

147. When the limits are functions of the parameter  $\alpha$ , a definite integral admits of differentiation in like manner. For, let  $\Delta \alpha, \Delta b$  be the changes in the limits corresponding to the increment  $\Delta \alpha$  in  $\alpha$ , then

$$\Delta u = \int_{a+\Delta a}^{b+\Delta b} \phi(x, \alpha + \Delta \alpha) dx - \int_a^b \phi(x, \alpha) dx$$

$$= \int_a^b \{ \phi(x, \alpha + \Delta \alpha) - \phi(x, \alpha) \} dx + \int_b^{b+\Delta b} \phi(x, \alpha + \Delta \alpha) dx$$

$$- \int_a^{a+\Delta a} \phi(x, \alpha + \Delta \alpha) dx.$$

Hence, proceeding to the limit, we get

$$\frac{du}{d\alpha} = \int_a^b \frac{d\phi(x, \alpha)}{d\alpha} dx + \phi(b, \alpha) \frac{db}{d\alpha} - \phi(a, \alpha) \frac{da}{d\alpha}.$$

*Integration under the Sign of Integration.*

148. We shall next consider the corresponding process called *integration under the sign of integration*.

Suppose  $\int_a^b \phi(x, \alpha) dx$  to be represented by  $u$ , then

$$\int_a^b [\int \phi(x, \alpha) d\alpha] dx = \int_a^b \phi(x, \alpha) dx = u,$$

or

$$\int_a^b [\int \phi(x, \alpha) d\alpha] dx = \int u d\alpha,$$

the same limits for  $\alpha$  being taken in both integrals.

Suppose  $\alpha_1$  and  $\alpha_2$  to represent the limiting values of  $\alpha$ , then the preceding result may be written

$$\int_a^b [\int_{\alpha_1}^{\alpha_2} \phi(x, \alpha) d\alpha] dx = \int_{\alpha_1}^{\alpha_2} [\int_a^b \phi(x, \alpha) dx] d\alpha;$$

or, adopting the usual notation,

$$\int_a^b \int_{\alpha}^{\beta} \phi(x, a) da dx = \int_{\alpha}^{\beta} \int_a^b \phi(x, a) dx da.$$

Such expressions are called double integrals, and the result just established is equivalent to the statement that in a double integration, when the limits are independent one of the other, we may effect the integrations in either order without altering the result.

It is easily seen that the preceding statement does not hold if either  $\phi(x, a)$ ,  $\frac{d\phi(x, a)}{dx}$ , or  $\frac{d\phi(x, a)}{da}$  become infinite within the assigned limits of integration.

By aid of this principle, from a definite integral involving constant parameters we can often obtain others by the method of integration with respect to one of its parameters.

(1) For example, if the integral

$$\int_0^{\infty} e^{-ax} \cos bx dx = \frac{a}{a^2 + b^2}$$

be integrated with respect to  $a$  between the limits  $\alpha$  and  $\beta$ , we get

$$\int_0^{\infty} \frac{e^{-ax} - e^{-\beta x}}{x} \cos bx dx = \frac{1}{2} \log \frac{\beta^2 + b^2}{\alpha^2 + b^2}.$$

(2) If the same equation be integrated with respect to  $b$  between the limits  $\alpha$  and  $\theta$ , we get

$$\int_0^{\infty} e^{-ax} \frac{\sin ax}{x} dx = \tan^{-1} \frac{\alpha}{a}.$$

On making  $\alpha = 0$  in this, it becomes

$$\int_0^{\infty} \frac{\sin ax}{x} dx = \frac{\pi}{2},$$

provided  $a$  is positive.

(3) Again, if the definite integral (§ 133)

$$\int_0^{\pi} \frac{dx}{1 + \kappa \cos x} = \frac{\pi}{\sqrt{1 - \kappa^2}}$$

be integrated with respect to  $\kappa$ , between the limits 0 and  $\sin \alpha$ , we get

$$\int_0^{\pi} \frac{\log(1 + \sin \alpha \cos x)}{\cos x} dx = \pi \alpha.$$

(4) Next, if the equation

$$\int_0^1 x^n dx = \frac{1}{n+1}$$

be integrated with respect to  $n$  between the limits  $\alpha$  and  $\beta$ , we get

$$\int_0^1 \frac{x^{\beta} - x^{\alpha}}{\log x} dx = \log \frac{1 + \beta}{1 + \alpha}.$$

(5) To find the value of the integral

$$u = \int_0^{\infty} e^{-x^2} dx.$$

If  $z$  be substituted for  $x$ , we have, since the value of the integral plainly remains unaltered,

$$u = \int_0^{\infty} z e^{-z^2 x^2} dz, \\ \int_0^{\infty} e^{-z^2(1+x^2)} z dx = u e^{-z^2}.$$

Hence, integrating with respect to  $z$  between the limits 0 and  $\infty$ , we have

$$\int_0^{\infty} \int_0^{\infty} e^{-z^2(1+x^2)} z dx dz = u \int_0^{\infty} e^{-z^2} dz = u^2.$$

Again,  $\int_0^{\infty} e^{-z^2(1+x^2)} z dz = \frac{1}{2} \frac{1}{1+x^2},$

$$\therefore u^2 = \frac{1}{2} \int_0^{\infty} \frac{dx}{1+x^2}, \text{ or } u = \frac{\pi}{4}.$$

Consequently  $u = \frac{1}{2} \sqrt{\pi}$ ; i. e.,  $\int_0^{\infty} e^{-x^2} dx = \frac{1}{2} \sqrt{\pi}.$

149. In many cases an unknown integral can be reduced to an elementary form by differentiation under the sign of integration.

For example, let

$$v = \int_0^1 \frac{\tan^{-1}(ax)}{x \sqrt{1-x^2}} dx;$$

then

$$\frac{dv}{da} = \int_0^1 \frac{dx}{(1+a^2x^2)\sqrt{1-x^2}} = \frac{\pi}{2} \frac{1}{\sqrt{1+a^2}}, \quad (\text{Ex. 5, § 113}).$$

$$\therefore u = \frac{\pi}{2} \int \frac{da}{\sqrt{1+a^2}} = \pi \log(a + \sqrt{1+a^2}).$$

No constant is added, since  $u=0$  when  $a=0$ .

150. A modification of this method of determining definite integrals is founded on the transformation of a simple integral into a double integral, and the inversion of the order of integration.

(1) For example, when  $x$  is positive, we have

$$\frac{1}{x} = \int_0^{\infty} e^{-xy} dy,$$

$$\therefore \int_0^{\infty} \frac{\sin ax}{x} dx = \int_0^{\infty} \sin ax dx \int_0^{\infty} e^{-xy} dy$$

$$= \int_0^{\infty} dy \int_0^{\infty} e^{-xy} \sin ax dx = \int_0^{\infty} \frac{ady}{a^2 + y^2} = \frac{\pi}{2}, \quad (\S 148).$$

(2) Next, to find the value of

$$u = \int_0^{\frac{\pi}{2}} \log \left( \frac{a + b \sin \theta}{a - b \sin \theta} \right) \frac{d\theta}{\sin \theta}.$$

Here, from the elementary equation

$$\log \frac{m+n}{m-n} = \int_0^1 \frac{2mndx}{m^2 - n^2x^2}, \text{ where } m > n,$$

we get

$$\log \left( \frac{a + b \sin \theta}{a - b \sin \theta} \right) = \int_0^1 \frac{2ab \sin \theta dx}{a^2 - b^2x^2 \sin^2 \theta};$$

$$\therefore u = 2ab \int_0^{\frac{\pi}{2}} \int_0^1 \frac{dx d\theta}{a^2 - b^2x^2 \sin^2 \theta}.$$

Hence, inverting the order of integration, we get (§ 133)

$$u = \pi a \int_0^1 \frac{dx}{\sqrt{a^2 - b^2x^2}} = \pi \sin^{-1} \left( \frac{b}{a} \right).$$

Similarly we get

$$\int_0^{\frac{\pi}{2}} \log \left( \frac{a + b \sin \theta}{a - b \sin \theta} \right) \sin \theta d\theta = \pi \frac{a - \sqrt{a^2 - b^2}}{b}.$$

Ex. 3. Again, by aid of the equation

$$\tan^{-1} \left( \frac{b}{a} \sin \theta \right) = \int_0^1 \frac{ab \sin \theta dx}{a^2 + b^2x^2 \sin^2 \theta},$$

it is readily seen that

$$\int_0^{\frac{\pi}{2}} \tan^{-1} \left( \frac{b}{a} \sin \theta \right) \sin \theta d\theta = \frac{\pi}{2} \frac{\sqrt{a^2 + b^2} - a}{b}.$$

151. *Lagrange's Theorem.*—That Lagrange's series (§ 56) can be established by the integral calculus, and its remainder after any number of terms exhibited in the form of a definite integral, was shown by M. Popoff (*Comptes rendus*, 1861). His demonstration has been transformed into a simple shape by M. Zolotareff, in the following manner.

Let  $z = x + y\phi(x)$ , and suppose the definite integral

$$\int_x^z \{y\phi(u) + x - u\}^n F'(u) du$$

represented by  $s_n$ , then we get by differentiation

$$\frac{ds_n}{dx} = n \int_x^z \{y\phi(u) + x - u\}^{n-1} F'(u) du - y^n \{ \phi(x) \}^n F(x) \\ = ns_{n-1} - y^n \{ \phi(x) \}^n F(x).$$

If we make  $n=1$ , we have

$$s_0 = y\phi(x)F'(x) + \frac{ds_0}{dx};$$

but

$$s_0 = F(z) - F(x);$$

$$\therefore F(z) = F(x) + y\phi(x)F'(x) + \frac{ds_1}{dx}.$$

In like manner, if  $n=2$ , we get

$$2s_1 = y^2 \{ \phi(x) \}^2 F'(x) + \frac{ds_2}{dx},$$

$$\therefore \frac{ds_1}{dx} = \frac{y^2}{1.2} \frac{d}{dx} \{ [\phi(x)]^2 F'(x) \} + \frac{1}{1.2} \frac{d^2s_2}{dx^2}.$$

Consequently

$$F(z) = F(x) + y\phi(x)F'(x) + \frac{y^2}{1.2} \frac{d}{dx} [ \{ \phi(x) \}^2 F'(x) ] + \frac{1}{1.2} \frac{d^2s_2}{dx^2}$$

Again

$$s_2 = \frac{y^3}{3} \{ \phi(x) \}^3 F'(x) + \frac{1}{3} \frac{ds_3}{dx},$$

$$\therefore \frac{1}{1.2} \frac{d^2s_2}{dx^2} = \frac{y^3}{1.2.3} \left( \frac{d}{dx} \right)^2 [ \{ \phi(x) \}^3 F'(x) ] + \frac{1}{1.2.3} \frac{d^3s_3}{dx^3},$$

and so on.

Hence we deduce finally



$$F(z) = F(x) + \frac{y}{1} \phi(x) F'(x) + \frac{y^2}{1 \cdot 2} \frac{d}{dx} [\phi(x)^2 F'(x)] \\ + \dots + \frac{1}{1 \cdot 2 \dots n} \left(\frac{d}{dx}\right)^n \int_x^z \{y\phi(u) + x - u\}^n F'(u) du.$$

This is Lagrange's series, — in which the remainder after  $n$  terms is exhibited in the form

$$\frac{1}{n} \left(\frac{d}{dx}\right)^n \int_x^z \{y\phi(u) + x - u\}^n F'(u) du.$$

*Discontinuous Integrals.*

152. The integral calculus furnishes many examples of discontinuous functions. For example

$$\int_0^x \frac{\sin ax \cos bx}{x} dx = \frac{1}{2} \int_0^x \frac{\sin(a+b)x}{x} dx + \frac{1}{2} \int_0^x \frac{\sin(a-b)x}{x} dx.$$

When  $a + b$  and  $a - b$  are both positive, each of the latter integrals (§ 148) is equal to  $\frac{\pi}{2}$ . Hence we have —

when  $a > b$ ,  $\int_0^x \frac{\sin ax \cos bx}{x} dx = \frac{\pi}{2}$ ,

and when  $a < b$   $\int_0^x \frac{\sin ax \cos bx}{x} dx = 0$ .

If  $a = b$ , the value of the integral becomes  $\frac{\pi}{4}$ .

Here we have an example of a function of two variables  $a$  and  $b$ , changing its value suddenly when  $b$ , varying in a continuous manner, becomes equal to or greater than  $a$ . This singularity has been ingeniously utilized for the purpose of obtaining the values of certain definite integrals. For example, let

$$u = \int_0^x \frac{\sin ax \cos bx}{x} dx;$$

then, since  $u = 0$  when  $a$  is less than  $b$ , and  $u = \frac{\pi}{2}$  when  $a > b$ , we have

$$\int_0^a u e^{-a} da = \frac{\pi}{2} \int_0^a e^{-a} da = \frac{\pi}{2} e^{-b},$$

or  $\int_0^a \int_0^a \frac{e^{-a} \sin ax \cos bx}{x} da dx = \frac{\pi}{2} e^{-b}$ .

But  $\int_0^a e^{-a} \sin ax da = \frac{x}{1+x^2}$ , (§ 134);

$$\therefore \int_0^a \frac{\cos bx}{1+x^2} dx = \frac{\pi}{2} e^{-b}.$$

Again, considering  $b$  as variable,

$$\int_0^b u db = \int_0^a \int_0^b \frac{\sin ax \cos bx}{x} db dx = \int_0^a \frac{\sin ax \sin bx}{x^2} dx.$$

Hence, if  $b < a$ , we have

$$\int_0^b \frac{\sin ax \sin bx}{x^2} dx = \frac{\pi}{2} b;$$

if  $b > a$ , we have  $\int_0^b \frac{\sin ax \sin bx}{x^2} dx = \frac{\pi}{2} a$ .

Consequently  $\int_0^a \frac{\sin ax \sin bx}{x^2} dx$  is equal to  $\frac{\pi}{2}$  multiplied by the smaller of the numbers  $a$  and  $b$ .

Again, let us consider the definite integral

$$\int_0^x \frac{(a-b \cos x) dx}{a^2 - 2ab \cos x + b^2}$$

Here we have

$$\int \frac{(a-b \cos x) dx}{a^2 - 2ab \cos x + b^2} = \frac{1}{2a} \int \left(1 + \frac{a^2 - b^2}{a^2 - 2ab \cos x + b^2}\right) dx \\ = \frac{x}{2a} + \frac{a^2 - b^2}{2a} \int \frac{dx}{a^2 - 2ab \cos x + b^2}.$$

Again (Ex. 8, § 113),

$$\int \frac{dx}{a^2 - 2ab \cos x + b^2} = \frac{2}{a^2 - b^2} \tan^{-1} \left( \frac{a+b}{a-b} \tan \frac{x}{2} \right); \\ \therefore \frac{a^2 - b^2}{2a} \int \frac{dx}{a^2 - 2ab \cos x + b^2} = \frac{1}{a} \tan^{-1} \left( \frac{a+b}{a-b} \tan \frac{x}{2} \right)$$

Accordingly, if  $a^2 > b^2$ ,

$$\frac{a^2 - b^2}{2a} \int_0^\pi \frac{dx}{a^2 - 2ab \cos x + b^2} = \frac{\pi}{2a}$$

If  $a^2 < b^2$ , we have

$$\frac{a^2 - b^2}{2a} \int_0^\pi \frac{dx}{a^2 - 2ab \cos x + b^2} = -\frac{\pi}{2a}$$

Consequently, when  $a^2 - b^2 > 0$ ,

$$\int_0^\pi \frac{(a-b \cos x) dx}{a^2 - 2ab \cos x + b^2} = \frac{\pi}{2a};$$

when  $a^2 - b^2 < 0$ ,

$$\int_0^\pi \frac{(a-b \cos x) dx}{a^2 - 2ab \cos x + b^2} = 0;$$

and when  $a = b$ ,

$$\int_0^\pi \frac{a(1 - \cos x) dx}{2a^2(1 - \cos x)} = \frac{1}{2a} \int_0^\pi dx = \frac{\pi}{2a}.$$

The comparison of these three cases shows that if  $b$  be supposed to vary in a continuous manner from a value less than  $a$  to a value greater than  $a$ , the integral

$$\int_0^\pi \frac{(a-b \cos x) dx}{a^2 - 2ab \cos x + b^2}$$

will assume for  $b = a - h$ ,  $a$ ,  $a + h$  the values  $\frac{\pi}{a}$ ,  $\frac{\pi}{2a}$ ,  $0$ . It is accordingly a discontinuous function.

*Eulerian Integrals*

153. The following definite integrals,

$$\int_0^1 x^{m-1} (1-x)^{n-1} dx, \quad \int_0^\infty e^{-x} x^{n-1} dx.$$

were first studied, under a modified form, by Euler, who devoted several memoirs to the investigation of their properties. They were afterwards fully discussed by Legendre, by whom they were styled Eulerian integrals of the first and second species respectively. The latter integral is now regarded as the fundamental one, to which the other is reducible, as shall be presently shown.

In the case where  $n$  is an integer we plainly have

$$\int_0^\infty e^{-x} x^{n-1} dx = 1 \cdot 2 \cdot 3 \dots n = n!$$

The integral is in all cases a function of  $n$ ; and, when  $n$  is fractional, it is regarded as a distinct transcendental function. It was distinguished by the symbol  $\Gamma$  by Legendre, thus:—

$$\Gamma(n) = \int_0^\infty e^{-x} x^{n-1} dx$$

This is now usually called the *Gamma-Function*, but sometimes, however, the *Factorial Function*, a name suggested by Arbogast, and subsequently adopted by Kramp and others.

Moreover, since (Ex. 6, § 115),

$$\int_0^\infty e^{-x} x^n dx = n \int_0^\infty e^{-x} x^{n-1} dx,$$

we have  $\Gamma(n+1) = n\Gamma(n)$ .

This may be taken as the fundamental property of gamma-functions, and by aid of it the calculation of all such functions is reduced to the case where the parameter  $n$  is comprised between any two consecutive integers. The values of  $\Gamma(n)$ , or rather of  $\log \Gamma(n)$ , were tabulated to twelve decimal places by Legendre in his *Traité des fonctions elliptiques*, tome 2, ch. 16, corresponding to values of  $n$  increasing by intervals of .001 between the integers 1 and 2.

It may be remarked that  $\Gamma(1) = 1$ ,  $\Gamma(0) = \infty$ ,  $\Gamma(-n) = \infty$ ,  $n$  being an integer. For negative values of  $n$ , not being integers, the function has a finite value.

The first Eulerian integral,

$$\int_0^1 x^{m-1} (1-x)^{n-1} dx,$$

is evidently a function of its two parameters,  $m$  and  $n$ . Following Binet we shall represent the integral by the notation  $B(m, n)$ .

It is readily seen that

$$\int_0^1 x^{m-1} (1-x)^{n-1} dx = \int_0^1 x^{m-1} (1-x)^{n-1} dx,$$

$$\dots B(m, n) = B(n, m).$$

Its value, when either  $m$  or  $n$  is a positive integer, can be immediately found. For, suppose  $n$  a positive integer, then (§ 123) we have

$$\int_0^1 x^{m-1} (1-x)^{n-1} dx = \frac{n-1}{m+n-1} \int_0^1 x^{m-1} (1-x)^{n-2} dx.$$

By successive applications we get

$$\int_0^1 x^{m-1} (1-x)^{n-1} dx = \frac{(n-1)(n-2) \dots 1}{(m+n-1)(m+n-2) \dots (m+1)} \int_0^1 x^{m-1} dx \\ = \frac{1 \cdot 2 \cdot 3 \dots (n-1)}{m(m+1)(m+2) \dots (m+n-1)}.$$

The corresponding result when  $m$  is an integer is obtained by interchanging the letters  $m$  and  $n$ .

We now proceed to show that  $B(m, n)$  can in all cases be expressed in gamma-functions. For if we substitute  $xz$  for  $x$  in the equation

$$\Gamma(n) = \int_0^{\infty} e^{-z} z^{n-1} dz$$

we get

$$\Gamma(n) = \int_0^{\infty} e^{-xz} z^{n-1} dx$$

Hence

$$\Gamma(n)\Gamma(1-z)^{m-1} = \int_0^{\infty} e^{-x(1+z)} z^{m+n-1} x^{n-1} dx$$

$$\Gamma(n) \int_0^{\infty} e^{-z} z^{n-1} dz = \int_0^{\infty} \int_0^{\infty} e^{-d(1+z)} z^{m+n-1} x^{n-1} dx dz$$

Let  $x(1+z) = y$ , and we get

$$\int_0^{\infty} e^{-d(1+z)} z^{m+n-1} dz = \frac{1}{(1+x)^{m+n}} \int_0^{\infty} e^{-y} y^{m+n-1} dy = \frac{\Gamma(m+n)}{(1+x)^{m+n}}$$

Hence

$$\frac{\Gamma(n)\Gamma(n)}{\Gamma(m+n)} = \int_0^{\infty} \frac{x^{n-1} dx}{(1+x)^{m+n}}$$

Next let

$$u = \frac{x}{1+x}$$

and  $\int_0^{\infty} \frac{x^{n-1}}{(1+x)^{m+n}} dx = \int_0^1 u^{n-1} (1-u)^{m-1} du = B(m, n)$

$$B(m, n) = \frac{\Gamma(m)\Gamma(n)}{\Gamma(m+n)}$$

This fundamental relation is due to Euler.

Again, if  $m = 1 - n$ , we get from the preceding

$$\Gamma(n)\Gamma(1-n) = \int_0^{\infty} \frac{x^{n-1}}{1+x} dx = \frac{\pi}{\sin n\pi} \quad (\S 144)$$

If  $n = \frac{1}{2}$ , this becomes  $\Gamma(\frac{1}{2}) = \sqrt{\pi}$ .

This result agrees with § 148, for, if we write  $z^2$  for  $x$ ,

$$\Gamma(\frac{1}{2}) = \int_0^{\infty} e^{-z} z^{-1/2} dz = 2 \int_0^{\infty} e^{-z^2} dz$$

154. Many definite integrals are reducible to gamma-functions, of which a few elementary cases are here given.

(1) To express the definite integral

$$\int_0^{\pi/2} \sin^n \theta \cos^{m-1} \theta d\theta$$

in gamma-functions.

Let  $x = \sin^2 \theta$ , and the integral transforms into

$$\frac{1}{2} \int_0^1 x^{n/2-1} (1-x)^{m/2-1} dx = \frac{1}{2} \frac{\Gamma(\frac{n}{2}) \Gamma(\frac{m}{2})}{\Gamma(\frac{m+n}{2})}$$

(2) To find the value of

$$\int_0^1 x^n (1-x)^r dx$$

Let  $x^n = z$ , and the transformed integral is

$$\frac{1}{n} \int_0^1 z^{r/n-1} (1-z)^r dz = \frac{1}{n} \frac{\Gamma(\frac{r+1}{n}) \Gamma(r+1)}{\Gamma(r+1 + \frac{r+1}{n})}$$

(3) If in the last  $r = -\frac{1}{2}$ , we get

$$\int_0^1 \frac{x^{n-1/2} dx}{(1-x)^{1/2}} = \frac{\sqrt{\pi}}{n} \frac{\Gamma(\frac{n}{2})}{\Gamma(\frac{1}{2} + \frac{n}{2})}$$

(4)

$$u = \int_{\beta}^{\alpha} (a-x)^m (x-\beta)^n dx$$

Let  $x = \beta + (a-\beta)z$ , and we readily find

$$u = (a-\beta)^{m+n+1} \frac{\Gamma(m+1)\Gamma(n+1)}{\Gamma(m+n+2)}$$

(5) To prove the equations

$$\int_0^x e^{-ax} x^{n-1} \cos bx dx = \frac{\Gamma(n)}{(a^2 + b^2)^{n/2}} \cos n\theta$$

$$\int_0^x e^{-ax} x^{n-1} \sin bx dx = \frac{\Gamma(n)}{(a^2 + b^2)^{n/2}} \sin n\theta$$

where  $\theta = \tan^{-1}(\frac{b}{a})$ .

In the equation

$$\int_0^{\infty} e^{-ax} x^{n-1} dx = \frac{\Gamma(n)}{a^n}$$

let  $a - ib$  be substituted for  $a$ , and we get

$$\int_0^{\infty} e^{-ax} (\cos bx + i \sin bx) x^{n-1} dx = \frac{\Gamma(n)}{(a-ib)^n} = \frac{\Gamma(n)(a+ib)^n}{(a^2+b^2)^{n/2}}$$

If  $b = a \tan \theta$ , we have

$$\frac{a}{(a^2+b^2)^{n/2}} = \cos n\theta, \quad \frac{b}{(a^2+b^2)^{n/2}} = \sin n\theta$$

$$\therefore \int_0^{\infty} e^{-ax} (\cos bx + i \sin bx) x^{n-1} dx = \frac{\Gamma(n)}{(a^2+b^2)^{n/2}} (\cos n\theta + i \sin n\theta)$$

Hence the proposed equations are obtained by equating the real and imaginary parts respectively.

$$(6) \int_0^{\infty} \cos bx x^{n-1} dx = \frac{\Gamma(n)}{b^n} \cos \frac{n\pi}{2}$$

$$\int_0^{\infty} \sin bx x^{n-1} dx = \frac{\Gamma(n)}{b^n} \sin \frac{n\pi}{2}$$

These follow from the preceding by making  $n=0$ .

A more rigorous demonstration of this and of the preceding example will be found in Serret's *Calcul integral*, pp. 194-198.

(7) Find the value of

$$u = \Gamma\left(\frac{1}{n}\right) \Gamma\left(\frac{2}{n}\right) \Gamma\left(\frac{3}{n}\right) \dots \Gamma\left(\frac{n-1}{n}\right)$$

Here, since  $\Gamma\left(\frac{1}{n}\right) \Gamma\left(1 - \frac{1}{n}\right) = \frac{\pi}{\sin \frac{\pi}{n}}$ ,

it is easily seen that

$$u^2 = \frac{\pi^{n-1}}{\sin \frac{\pi}{n} \sin \frac{2\pi}{n} \dots \sin \frac{(n-1)\pi}{n}}$$

But it can be shown, by trigonometry, that

$$\sin \frac{\pi}{n} \sin \frac{2\pi}{n} \dots \sin \frac{(n-1)\pi}{n} = \frac{n}{2^{n-1}}$$

hence  $\Gamma\left(\frac{1}{n}\right) \Gamma\left(\frac{2}{n}\right) \dots \Gamma\left(\frac{n-1}{n}\right) = \frac{(2\pi)^{n-1}}{n^{n-1}}$

(8) Prove that

$$\int_0^{\pi/2} \cos^n \theta \cos m\theta d\theta = \frac{\pi}{2^{n+1}} \frac{\Gamma(n+1)}{\Gamma\left(\frac{m+n}{2}+1\right) \Gamma\left(\frac{n+m}{2}-1\right)}$$

155. We next proceed to show that  $\Gamma(n)$  admits of being exhibited as the limit of the product of an infinite number of factors, a form which was adopted by Gauss as the definition of the function.

If in the equation

$$\Gamma(n) = \int_0^{\infty} e^{-x} x^{n-1} dx$$

we make  $e^{-x} = z$ , we get

$$\Gamma(n) = \int_0^1 \left(\log \frac{1}{z}\right)^{n-1} dz$$

But (§ 63, Ex. 9)  $\log \frac{1}{z}$  is the limit of  $\mu(1-z^{\frac{1}{\mu}})$  when  $\mu$  increases beyond limit.

$$\therefore \Gamma(n) = \lim_{\mu \rightarrow \infty} \mu^n \int_0^1 (1-z^{\frac{1}{\mu}})^{n-1} dz$$

$$= \lim_{\mu \rightarrow \infty} \mu^n \int_0^1 y^{\mu-1} (1-y)^{n-1} dy, \text{ making } z = y^{\mu}$$

$$\Gamma(n) = \lim_{\mu \rightarrow \infty} \mu^n \cdot \frac{1 \cdot 2 \cdot 3 \dots \mu}{n \cdot (n+1) \dots (n+\mu)}, \quad (\S 123)$$

when  $\mu$  is increased indefinitely.

As an application of this definition of  $\Gamma(n)$  suppose  $n+l$  and  $n-l$  respectively substituted for  $n$ , and we readily obtain

$$\frac{\{\Gamma(n)\}^2}{\Gamma(n-l)\Gamma(n+l)} = \left(1 - \frac{l^2}{n^2}\right) \left(1 - \frac{l^2}{(n+1)^2}\right) \left(1 - \frac{l^2}{(n+2)^2}\right) \dots$$

$$= \frac{n}{l\pi} \sin \frac{l\pi}{n}$$

by a well-known trigonometrical relation.

If we make  $n=1$ , this gives

$$\Gamma(1-l)\Gamma(1+l) = \frac{l\pi}{\sin l\pi}; \quad \therefore \Gamma(l)\Gamma(1-l) = \frac{\pi}{\sin l\pi}, \text{ as before.}$$

156. Again, if we make  $x=az$ , we get

$$\int_0^a x^{n-1} (a-x)^{n-1} dx = a^{m+n-1} \int_0^1 z^{m-1} (1-z)^{n-1} dz$$

$$= a^{m+n-1} \frac{\Gamma(m)\Gamma(n)}{\Gamma(m+n)}$$

This result can be readily represented as a theorem in double integration, as follows.

If the double integral  $\iint x^{m-1}y^{n-1}dxdy$  be taken for all positive values of  $x$  and  $y$  subject to the condition  $x+y < a$ , its value is represented by

$$\frac{\Gamma(m)\Gamma(n)}{\Gamma(m+n+1)} a^{m+n}.$$

For, considering  $x$  as constant, and integrating with respect to  $y$  between the limits 0 and  $a-x$ , the value of the double integral becomes

$$\frac{1}{n} \int_0^a x^{m-1}(a-x)^n dx, \text{ or } \frac{a^{m+n}}{n} \frac{\Gamma(m)\Gamma(n+1)}{\Gamma(m+n+1)},$$

i. e., 
$$\frac{a^{m+n}}{\Gamma(m+n+1)} \frac{\Gamma(m)\Gamma(n)}{\Gamma(m+n+1)}.$$

157. The preceding result, first given by Euler, was generalized by Dirichlet (*Liouville's Journal*, 1839), and extended to a large class of multiple integrals by the following theorem.

Let 
$$V = \iiint \dots x^{l-1}y^{m-1}z^{n-1} \dots dx dy dz \dots,$$

in which the variables  $x, y, z$  &c., are always positive, and subject only to the condition

$$x+y+z \dots < 1,$$

then 
$$V = \frac{\Gamma(l)\Gamma(m)\Gamma(n) \dots}{\Gamma(1+l+m+n \dots)}.$$

It will be sufficient here to show that the theorem is true in the case of three variables,  $x, y, z$ ; i. e., let

$$V = \iiint x^{l-1}y^{m-1}z^{n-1}dxdydz,$$

subject to the foregoing conditions.

Integrating with respect to  $z$ , considering  $x$  and  $y$  constant, we get

$$V = \frac{1}{n} \iint x^{l-1}y^{m-1}(1-x-y)^n dxdy,$$

in which  $x$  and  $y$  are positive, and subject to the condition  $x+y < 1$ .

If we next integrate with respect to  $y$ , between the limits 0 and  $1-x$ , we have

$$\int_0^{1-x} y^{m-1}(1-x-y)^n dy = (1-x)^{m+n} \frac{\Gamma(m)\Gamma(n+1)}{\Gamma(m+n+1)}.$$

Accordingly

$$\begin{aligned} V &= \frac{\Gamma(m)\Gamma(n)}{\Gamma(m+n+1)} \int_0^1 x^{l-1}(1-x)^{m+n} dx \\ &= \frac{\Gamma(m)\Gamma(n)}{\Gamma(m+n+1)} \frac{\Gamma(l)\Gamma(m+n+1)}{\Gamma(l+m+n+1)} = \frac{\Gamma(l)\Gamma(m)\Gamma(n)}{\Gamma(l+m+n+1)}. \end{aligned}$$

158. The preceding theorem when extended to  $n$  variables can be stated somewhat more generally, viz., if

$$V = \iiint \dots x^{l-1}y^{m-1}z^{n-1} \dots dx dy dz \dots$$

where  $x, y, z$  are always positive and subject to the condition

$$\left(\frac{x}{a}\right)^p + \left(\frac{y}{\beta}\right)^q + \left(\frac{z}{\gamma}\right)^r + \dots < 1,$$

$\alpha, \beta, \gamma, \dots, p, q, r, \dots$  being positive quantities, then we shall have

$$V = \frac{\alpha^l \beta^m \gamma^n \dots}{pqr \dots} \frac{\Gamma\left(\frac{l}{p}\right) \Gamma\left(\frac{m}{q}\right) \Gamma\left(\frac{n}{r}\right) \dots}{\Gamma\left(1 + \frac{l}{p} + \frac{m}{q} + \frac{n}{r} \dots\right)}.$$

This readily follows from the preceding by making

$$\left(\frac{x}{a}\right)^p = x', \left(\frac{y}{\beta}\right)^q = y', \left(\frac{z}{\gamma}\right)^r = z', \dots$$

In the case of three variables this theorem contains a large number of results relative to volumes, centres of gravity, moments of inertia, &c.

The remarkable elegance and generality of Dirichlet's theorem immediately attracted notice, and his results were speedily extended by Liouville, Catalan, Leslie Ellis, and other mathematicians of distinction. Of the results thus established we shall content ourselves with giving Liouville's extension of Dirichlet's theorem (*Liouville's Journal*, 1839).

If

$$V = \iiint \dots x^{l-1}y^{m-1}z^{n-1} \dots f \left\{ \left(\frac{x}{a}\right)^p + \left(\frac{y}{\beta}\right)^q + \dots \right\} dx dy dz \dots,$$

where  $x, y, z$  are always positive and subject to the condition

$$\left(\frac{x}{a}\right)^p + \left(\frac{y}{\beta}\right)^q + \left(\frac{z}{\gamma}\right)^r + \dots < h,$$

$\alpha, \beta, p, q$ , being always positive, as before, then will

$$V = \frac{\alpha^l \beta^m \gamma^n \dots}{pqr \dots} \frac{\Gamma\left(\frac{l}{p}\right) \Gamma\left(\frac{m}{q}\right) \dots}{\Gamma\left(\frac{l}{p} + \frac{m}{q} + \dots\right)} \int_0^h u^{\frac{l}{p} + \frac{m}{q} + \dots - 1} f(u) du.$$

This follows without difficulty from the preceding by assuming

$$\left(\frac{x}{a}\right)^p = x', \left(\frac{y}{\beta}\right)^q = y', \dots, \text{ and then making } x' + y' + z' \dots = u.$$

A few examples are added for illustration.

(1) The value of  $\iiint dx_1 dx_2 dx_3 \dots dx_n$ , where  $x_1, x_2, \dots, x_n$  are subject to the condition

$$x_1^2 + x_2^2 + x_3^2 + \dots + x_n^2 < R^2,$$

is 
$$\frac{R^n}{2^n} \frac{\pi^{\frac{n}{2}}}{\Gamma\left(1 + \frac{n}{2}\right)}.$$

(2) The value of

$$\iiint \dots \frac{dx_1 dx_2 \dots dx_n}{\sqrt{1-x_1^2-x_2^2-\dots-x_n^2}},$$

extended to all positive values of the variables for which the expression is real, is

$$\frac{\pi^{\frac{n+1}{2}}}{2^n \Gamma\left(\frac{n+1}{2}\right)}.$$

(3) The value of

$$\iint x^{l-1}y^{m-1}e^{kx+ny}dxdy$$

extended to all positive values for which  $x+y < h$  is

$$\frac{\pi}{\sin k\pi} (e^h - 1).$$

(4) The value of

$$\iint dxdy \left( \frac{1-x^2-y^2}{1+x^2+y^2} \right)^{\frac{1}{2}}$$

for all real values of the expression,  $x$  and  $y$  being positive, is

$$\frac{\pi}{4} (\pi - 1).$$

(5) The value of

$$\iiint x^{p-1}y^{q-1}z^{r-1}dxdydz$$

extended to all positive values of  $x, y, z$  contained within the ellipsoid

$$\frac{x^2}{a^2} + \frac{y^2}{b^2} + \frac{z^2}{c^2} = 1$$

is

$$\frac{a^p b^q c^r}{8} \frac{\Gamma\left(\frac{p}{2}\right) \Gamma\left(\frac{q}{2}\right) \Gamma\left(\frac{r}{2}\right)}{\Gamma\left(\frac{p+q+r}{2} + 1\right)}.$$

(6) Prove that

$$\iiint \dots \frac{f(a_1x_1 + a_2x_2 + \dots + a_nx_n)}{\sqrt{1-x_1^2-x_2^2-\dots-x_n^2}} dx_1 dx_2 \dots dx_n,$$

when extended to all values subject to the condition

$$x_1^2 + x_2^2 + \dots + x_n^2 < 1,$$

is equal to

$$\frac{\pi^{\frac{n}{2}}}{\Gamma\left(\frac{n}{2}\right)} \int_{-1}^1 f(kx)(1-x^2)^{\frac{n}{2}-1} dx,$$

where

$$k = \sqrt{a_1^2 + a_2^2 + \dots + a_n^2}.$$

159. We shall next give a short account of Legendre's formula for the calculation of  $\log \Gamma(1+x)$ .

Adopting Gauss's definition, substituting  $x+1$  for  $n$ , and taking the logarithms of both sides of the equation of § 155, we get

$$\log \Gamma(x+1)$$

$$= \lim \left\{ x \log \mu - \log \left(1 + \frac{x}{\mu}\right) - \log \left(1 + \frac{x}{2\mu}\right) \dots - \log \left(1 + \frac{x}{\mu}\right) \right\}.$$

Now  $x$  lie between  $+1$  and  $-1$ , we may substitute their well-known expansions for  $\log \left(1 + \frac{x}{\mu}\right), \log \left(1 + \frac{x}{2\mu}\right) \dots$

Hence, representing the indefinite series

$$\frac{1}{1^n} + \frac{1}{2^n} + \frac{1}{3^n} + \dots \&c.$$



by  $s_n$ , we shall have

$$\log \Gamma(x+1) = -\gamma x + \frac{1}{2} s_2 x^2 - \frac{1}{6} s_3 x^3 + \frac{1}{24} s_4 x^4 - \dots \&c.,$$

where  $\gamma$  represents the limit of

$$\frac{1}{1} + \frac{1}{2} + \frac{1}{3} + \dots + \frac{1}{\mu} - \log \mu$$

when  $\mu$  is indefinitely increased. This limit, whose importance was first noticed by Euler (*Acta Petropolis*, 1734), is now usually called *Euler's Constant*.

If we change the sign of  $x$  in the preceding equation it becomes

$$\log \Gamma(1-x) = \gamma x + \frac{1}{2} s_2 x^2 + \frac{1}{6} s_3 x^3 + \frac{1}{24} s_4 x^4 + \dots \&c.$$

Again 
$$\frac{\Gamma(1+x)}{\Gamma(1-x)} = \frac{\{\Gamma(1+x)\}^2}{x\Gamma(x)\Gamma(1-x)} = \frac{[\Gamma(1+x)]^2 \sin \pi x}{\pi x}$$

Hence we have

$$\log \Gamma(1+x) = \frac{1}{2} \log \frac{2\pi}{\sin \pi x} - (\gamma x + \frac{1}{2} s_2 x^2 + \frac{1}{6} s_3 x^3 + \dots)$$

Again, by logarithms,

$$\frac{1}{2} \log \frac{1+x}{1-x} = x + \frac{1}{3} x^3 + \frac{1}{5} x^5 + \dots \&c.$$

Consequently

$$\begin{aligned} \log \Gamma(1+x) &= \frac{1}{2} \log \frac{2\pi}{\sin \pi x} - \frac{1}{2} \log \left( \frac{1+x}{1-x} \right) + (1-\gamma)x - \frac{1}{2} (s_2-1)x^2 - \frac{1}{6} (s_3-1)x^3 \dots \\ &= \frac{1}{2} \log \frac{2\pi}{\sin \pi x} - \frac{1}{2} \log \frac{1+x}{1-x} + c_1 x - c_2 x^2 - c_3 x^3 \dots, \end{aligned}$$

where  $c_1 = 1-\gamma$ ,  $c_2 = \frac{1}{2}(s_2-1)$ ,  $c_3 = \frac{1}{6}(s_3-1)$ ...

It is easily seen that the constants  $c_2, c_3, c_4, \dots$ , form a rapidly decreasing series, in which each term can be calculated to any required number of places of decimals. Accordingly, when the value of Euler's constant  $\gamma$  has been determined, a series of values of  $\log \Gamma(1+x)$  can be computed from the foregoing equation, and thus tabulated.

Again, since  $\Gamma\left(\frac{3}{2}\right) = \frac{\sqrt{\pi}}{2}$ , the value of  $\gamma$  may be calculated by making  $x = \frac{1}{2}$  in the preceding formula; by this means its value is found to be 0.5772156649 to ten decimal places.

*On the Integrals Li x, Ei x, Si x, and Ci x.*

160. Having thus arrived at a determination of Euler's constant, we shall return to the consideration of the logarithmic integral and other transcendents introduced into § 131.

Adopting the notation of that article, we have

$$Li(e^{-x}) = \int_{\infty}^x \frac{e^{-z}}{z} dz = \int_{\infty}^1 \frac{e^{-xu}}{u} du, \text{ writing } xu \text{ for } z;$$

$$\begin{aligned} \therefore Li(e^{-x}) - Li(e^{-y}) &= \int_1^{\infty} \frac{e^{-yu} - e^{-xu}}{u} du \\ &= \int_0^{\infty} \frac{e^{-yu} - e^{-xu}}{u} du + \int_0^1 \frac{e^{-xu} - e^{-yu}}{u} du. \end{aligned}$$

But (§ 142),

$$\int_0^{\infty} \frac{e^{-yu} - e^{-xu}}{u} du = \log \frac{x}{y};$$

$$\therefore Li(e^{-x}) - Li(e^{-y}) = \log x - \log y + \int_0^1 \frac{1 - e^{-yu}}{u} du - \int_0^1 \frac{1 - e^{-xu}}{u} du.$$

Again 
$$\int_0^1 \frac{1 - e^{-yu}}{u} du = \int_0^1 \frac{1 - (1-u)^y}{u} du - \int_0^1 \frac{e^{-yu} - (1-u)^y}{u} du.$$

But 
$$\begin{aligned} \int_0^1 \frac{1 - (1-u)^y}{u} du &= \int_0^1 \frac{1 - (1-u)^y}{1 - (1-u)} du \\ &= \int_0^1 \{1 + (1-u) + (1-u)^2 + \dots + (1-u)^{y-1}\} du \\ &= 1 + \frac{1}{2} + \frac{1}{3} + \dots + \frac{1}{y}. \end{aligned}$$

If now we suppose  $y$  to increase beyond limit, observing that in that case  $Li e^{-y} = 0$ , and that  $\gamma = \text{limit of } 1 + \frac{1}{2} + \frac{1}{3} + \dots + \frac{1}{y} - \log y$  when  $y = \infty$ , we get

$$Li(e^{-x}) = \gamma + \log x - \int_0^1 \frac{1 - e^{-xu}}{u} du - \text{lim.} \int_0^1 \frac{e^{-yu} - (1-u)^y}{u} du.$$

We next proceed to show that

$$\int_0^1 \frac{e^{-yu} - (1-u)^y}{u} du$$

vanishes when  $y$  becomes indefinitely great.

To prove this, we observe that, since  $u$  lies between 0 and 1,

$$e^{-yu} > 1-u, \therefore e^{-yu} > (1-u)^y,$$

Also

$$e^{-yu} > 1-u, \therefore (1-u)e^{-yu} > 1-u^2,$$

hence

$$1 - (1-u)e^{-yu} < 1 - (1-u^2)^y < yu^2, \therefore e^{-yu} - (1-u)^y < yu^2 e^{-yu}$$

Consequently

$$\int_0^1 \frac{e^{-yu} - (1-u)^y}{u} du < y \int_0^1 u e^{-yu} du.$$

Again,

$$\int_0^1 u e^{-yu} du = \frac{1}{y} (1 - e^{-y}) - e^{-y} = 0 \text{ when } y = \infty.$$

$$\therefore \int_0^1 \frac{e^{-yu} - (1-u)^y}{u} du$$

vanishes at the same time.

Hence

$$Li(e^{-x}) = \gamma + \log x - \int_0^1 \frac{1 - e^{-xu}}{u} du.$$

Again

$$\begin{aligned} \int_0^1 \frac{1 - e^{-xu}}{u} du &= \int_0^1 \left( x - \frac{x^2}{1.2} u + \frac{x^3}{1.2.3} u^2 - \dots \right) du \\ &= x - \frac{x^2}{2.1.2} + \frac{1}{3} \frac{x^3}{1.2.3} - \dots \&c. \end{aligned}$$

$$Li(e^{-x}) = \gamma + \log x - x + \frac{1}{2} \frac{x^2}{1.2} - \frac{1}{6} \frac{x^3}{1.2.3} + \dots \&c.$$

Again,

$$\begin{aligned} Li(x) &= \int_{\infty}^{-x} \frac{e^{-z}}{z} dz = - \int_{-\infty}^x \frac{e^{-z}}{z} dz \\ &= - \text{lim.} \left[ \int_{-x}^{-\epsilon} \frac{e^{-z}}{z} dz + \int_{\epsilon}^x \frac{e^{-z}}{z} dz \right] \end{aligned}$$

when  $\epsilon$  vanishes.

But

$$\int_{\epsilon}^{\infty} = \int_x^{\infty} + \int_{\epsilon}^x;$$

$$\begin{aligned} \therefore Li(x) &= - \text{lim.} \left[ \int_{-x}^{-\epsilon} \frac{e^{-z}}{z} dz + \int_{\epsilon}^x \frac{e^{-z}}{z} dz \right] - \int_x^{\infty} \frac{e^{-z}}{z} dz \\ &= \int_0^x \frac{e^{-z} - e^{-z}}{z} dz - \int_x^{\infty} \frac{e^{-z}}{z} dz. \end{aligned}$$

Let  $z = xu$ , and this becomes

$$\begin{aligned} Li(x) &= \int_0^1 \frac{e^{-xu} - e^{-xu}}{u} du - \int_1^{\infty} \frac{e^{-xu}}{u} du; \\ \therefore Li(x) &= Li(e^{-x}) + \int_0^1 \frac{e^{-xu} - e^{-xu}}{u} du; \end{aligned}$$

hence

$$Li(x) = \gamma + \log x + x + \frac{1}{2} \frac{x^2}{1.2} + \frac{1}{6} \frac{x^3}{1.2.3} + \dots \&c.$$

This and the preceding can be represented by the single formula

$$Ei x = Li(x) = \gamma + \frac{1}{2} \log(x^2) + x + \frac{1}{2} \frac{x^2}{1.2} + \frac{1}{6} \frac{x^3}{1.2.3} + \dots \&c.$$

The expansion for the sine-integral can be readily obtained, for we have by definition

$$Si x = \int_0^x \frac{\sin z}{z} dz;$$

hence, substituting the ordinary expansion for  $\sin z$ , and integrating between the limits proposed, we get

$$Si x = x - \frac{1}{3} \frac{x^3}{1.2.3} + \frac{1}{5} \frac{x^5}{1.2.3.4.5} - \dots \&c.$$

Again, if, in the equation already proved

$$Li(e^{-x}) = \int_{\infty}^1 \frac{e^{-xu}}{u} du = \gamma + \frac{1}{2} \log(x^2) - x + \frac{1}{2} \frac{x^2}{1.2} - \frac{1}{6} \frac{x^3}{1.2.3} + \dots \&c.,$$

we substitute  $ix$  for  $x$ , it becomes

$$\int_{\infty}^1 \frac{e^{-ixu}}{u} du = \gamma + \frac{1}{2} \log(x^2) - ix - \frac{1}{2} \frac{x^2}{1.2} + \frac{1}{6} \frac{ix^3}{1.2.3} + \dots \&c.,$$

$$\text{or } \int_{\infty}^1 \frac{\cos xu - i \sin xu}{u} du = \gamma + \frac{1}{2} \log(x^2) - ix - \dots \&c.$$

Hence, equating the real parts on both sides, we get

$$\int_{\infty}^1 \frac{\cos xu}{u} du = \gamma + \frac{1}{2} \log(x^2) - \frac{1}{2} \frac{x^2}{1.2} + \frac{1}{24} \frac{x^4}{1.2.3.4} - \dots \&c.$$

Consequently

$$Ci x = \gamma + \frac{1}{2} \log(x^2) - \frac{1}{2} \frac{x^2}{1.2} + \frac{1}{24} \frac{x^4}{1.2.3.4} - \dots \&c.$$

The several series here arrived at are readily seen to be convergent for all real values of  $x$ , and by aid of them the values of  $Ei x$ ,  $Si x$ ,  $Ci x$  for different values of the argument  $x$  can be tabulated.

Such tables have been constructed by Soldner, Bidone, Bret-

schneider, Schlömilch, and others. The most recent and complete tables are those of Mr J. W. L. Glaisher, already referred to (§ 131).

161. The values of some definite integrals can be best determined by transforming them into *infinite series*. This statement will be illustrated by one or two examples.

(1) To find  $\int_0^1 \frac{\log x}{1-x} dx$ .

Here, when  $x$  is less than unity,

$$\frac{\log x}{1-x} = \log x(1+x+x^2+\dots+x^n+\&c.)$$

but  $\int_0^1 x^n \log x dx = -\frac{1}{(n+1)^2}$  ;

consequently  $\int_0^1 \frac{\log x}{1-x} dx = -(1+\frac{1}{4}+\frac{1}{9}+\dots) = -\frac{\pi^2}{6}$

(2) In like manner it can be shown that

$$\int_0^1 \frac{\log x}{1+x} dx = -\frac{\pi^2}{12} \int_0^1 \frac{\log x}{1-x^2} dx = -\frac{\pi^2}{8}$$

(3) Again, to find  $\int_0^1 \frac{x^{a-1}-x^{b-1}}{(1+x) \log x} dx$ .

Replacing  $\frac{1}{1+x}$  by its development, we get

$$\frac{x^{a-1}-x^{b-1}}{1+x} = x^{a-1}-x^{b-1}-(x^a-x^{b+1})+(x^{a+1}-x^{b+2})-\dots$$

Consequently (Ex. 4, § 148)

$$\int_0^1 \frac{x^{a-1}-x^{b-1}}{(1+x) \log x} dx = \log \frac{a}{1-a} - \log \frac{a+1}{2-a} + \log \frac{a+2}{3-a} - \dots$$

$$= -\log \frac{a(a+2)(a+4)\dots(2-a)(4-a)\dots}{(1-a)(1+a)(3-a)(3+a)\dots}$$

$$= \log \frac{\alpha(2^2-\alpha^2)(4^2-\alpha^2)\dots}{(1^2-\alpha^2)(3^2-\alpha^2)\dots} = \log \tan \frac{\alpha\pi}{2}$$

by a known formula in trigonometry.

162. Conversely, an infinite series can in many cases be transformed into a definite integral, and thus evaluated.

For example, suppose

$$S = 1 + \frac{1}{2^n} - \frac{1}{3^n} + \frac{1}{4^n} + \frac{1}{5^n} - \dots$$

Here, since  $\frac{1}{2n+1} = \int_0^1 x^{2n} dx$ , we have

$$S = \int_0^1 dx(1+x^2-x^4+x^6+\dots) = \int_0^1 \frac{1+x^2}{1+x^4} dx = \frac{\pi}{4}\sqrt{2}$$

In like manner we get

$$1 - \frac{1}{2^n} + \frac{1}{3^n} - \frac{1}{4^n} + \frac{1}{5^n} - \dots = \int_0^1 \frac{1-x^n}{1-x^{2n}} dx = \frac{\pi}{4} \frac{1+\sqrt{2}}{2}$$

Again, the series

$$S = \frac{1}{p(p+1)} + \frac{1}{(p+m)(p+m+1)} + \dots + \&c.$$

can be represented by a definite integral.

Here

$$\frac{1}{p(p+1)} + \dots + \frac{1}{(p+m)(p+m+1)} = \frac{\Gamma(p)}{\Gamma(n+p+1)} = \frac{1}{\Gamma(n+1)} \int_0^1 (1-x)^n x^{p-1} dx$$

(§ 153) ;

$$\therefore S = \frac{1}{\Gamma(n+1)} \int_0^1 (1-x)^n (x^{p-1} + x^{p+m-1} + \dots) dx$$

$$= \frac{1}{1.2.3 \dots n} \int_0^1 \frac{(1-x)^n x^{p-1}}{1-x^m} dx$$

We now proceed to give a few applications of the calculus to geometrical problems.

*Areas of Plane Curves.*

163. If a plane curve be referred to rectangular axes of coordinates, the area between the curve, the axis of X, and two ordinates corresponding to the abscissæ  $a$  and  $b$  is represented by the definite integral

$$\int_a^b y dx$$

Hence if  $y = \phi(x)$  be the equation of the curve, the area in question is denoted by

$$\int_a^b \phi(x) dx$$

From this result it follows that every definite integral may be

represented by an area. And it is seen at once that all the examples hitherto considered admit of geometrical interpretation.

In the above formula the ordinate is supposed positive for all points of the curve between the limiting abscissæ. The modification when the curve cuts the axis of  $x$  can be readily supplied.

Ex. 1. Let the curve be an ellipse, represented by the equation

$$\frac{x^2}{a^2} + \frac{y^2}{b^2} = 1$$

Here  $y = \frac{b}{a} \sqrt{a^2 - x^2}$ ; and, if  $x, y$  be the coordinates of the point P (fig. 7), the area APN is represented by the integral

$$\frac{b}{a} \int_x^a \sqrt{a^2 - x^2} dx$$

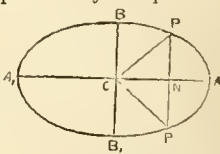

Fig 7.

Let  $x = a \cos \phi$ , and the integral transforms into

$$ab \int_0^\phi \sin^2 \phi d\phi = \frac{ab}{2} (\phi - \sin \phi \cos \phi) = \frac{ab}{2} \cos^{-1} \frac{x}{a} - \frac{xy}{2}$$

Hence, the area of the elliptic sector APC<sub>1</sub> is equal to

$$ab \cos^{-1} \frac{x}{a}$$

If the sectorial area APC<sub>1</sub> be represented by S, the preceding result gives

$$\frac{x}{a} = \cos \frac{S}{ab}, \quad \frac{y}{b} = \sin \frac{S}{ab};$$

or  $\frac{x}{a} = \cos \phi, \quad \frac{y}{b} = \sin \phi, \quad \text{where } \phi = \frac{S}{ab}$

Ex. 2. The equation of a hyperbola referred to its axes is

$$\frac{x^2}{a^2} - \frac{y^2}{b^2} = 1$$

$$\therefore y = \frac{b}{a} \sqrt{x^2 - a^2}$$

Accordingly, if  $x, y$  be the coordinates of the point P on the curve (fig. 8), the area APN is represented by

$$\frac{b}{a} \int_a^x \sqrt{x^2 - a^2} dx = \frac{b}{2a} x \sqrt{x^2 - a^2} - \frac{ab}{2} \log \frac{x + \sqrt{x^2 - a^2}}{a}$$

$$= \frac{xy}{2} - \frac{ab}{2} \log \left( \frac{x}{a} + \frac{y}{b} \right)$$

Consequently the area of the hyperbolic sector ACP is represented by

$$\frac{ab}{2} \log \left( \frac{x}{a} + \frac{y}{b} \right)$$

This relation has given rise to a class of expressions called *hyperbolic functions*. Thus, if S denote the area of the hyperbolic sector APC<sub>1</sub>, we have

$$S = ab \log \left( \frac{x}{a} + \frac{y}{b} \right),$$

$$\therefore \frac{x}{a} + \frac{y}{b} = e^{\frac{S}{ab}}$$

Hence, from the equation

$$\frac{x^2}{a^2} - \frac{y^2}{b^2} = 1$$

we get  $\frac{x}{a} - \frac{y}{b} = e^{-\frac{S}{ab}}$

Let  $\frac{S}{ab}$  be represented by  $v$ , and we have

$$\frac{x}{a} = \frac{e^v + e^{-v}}{2}, \quad \frac{y}{b} = \frac{e^v - e^{-v}}{2}$$

An analogy with the formulae for the ellipse the expressions

$$\frac{e^v + e^{-v}}{2}, \quad \frac{e^v - e^{-v}}{2}$$

are called the hyperbolic cosine and hyperbolic sine of  $v$  respectively, and are usually written  $\cosh v, \sinh v$ ; and we have

$$\frac{x}{a} = \cosh v, \quad \frac{y}{b} = \sinh v$$

Again, for simplicity, the hyperbola may be assumed equilateral, and  $a = b = 1$ ; in this case the equations become

$$x = \cosh v, \quad y = \sinh v$$

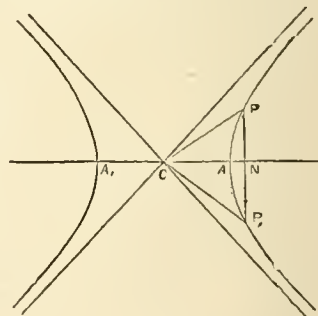

Fig 8.

where  $v$  represents the area of the corresponding hyperbolic sector, represented by APCP.

Also, by analogy, we write

$$\tanh v = \frac{\sinh v}{\cosh v} = \frac{e^v - e^{-v}}{e^v + e^{-v}} = \frac{e^{2v} - 1}{e^{2v} + 1}, \text{ \&c.}$$

Again, we obviously have

$$\cos x = \cosh ix, \quad i \sin x = \sinh ix \dots$$

Between hyperbolic functions many relations exist analogous to those between ordinary trigonometrical functions.

For example, it is easily seen that we have

$$\begin{aligned} \cosh^2 x - \sinh^2 x &= 1, \\ \cosh(x+y) &= \cosh x \cosh y + \sinh x \sinh y, \\ \sinh(x+y) &= \sinh x \cosh y + \cosh x \sinh y, \\ \cosh 3x &= 4 \cosh^3 x - 3 \cosh x, \\ \sinh 3x &= 4 \sinh^3 x + 3 \sinh x. \end{aligned}$$

Again

$$\begin{aligned} \frac{d}{dx} \sinh x &= \cosh x, & \frac{d}{dx} \cosh x &= \sinh x, \\ \frac{d}{dx} \tanh x &= \frac{1}{\cosh^2 x}, & \frac{d}{dx} \coth x &= -\frac{1}{\sinh^2 x}. \end{aligned}$$

Hence

$$\begin{aligned} \int \cosh x \, dx &= \sinh x, & \int \sinh x \, dx &= \cosh x, \\ \int \frac{dx}{\cosh^2 x} &= \tanh x, & \int \frac{dx}{\sinh^2 x} &= -\coth x. \end{aligned}$$

The analogy between hyperbolic and trigonometrical functions will also appear as follows. If we make  $x = \sec \phi$  in the equation of the equilateral hyperbola  $x^2 - y^2 = 1$ , we get  $y = \tan \phi$ . Consequently  $\sec \phi = \cosh v$ ,  $\tan \phi = \sinh v$ .

Moreover the equation  $v = \log(x + y)$ , gives

$$\tan \left( \frac{\phi}{2} + \frac{\pi}{4} \right) = e^v.$$

In this case  $\phi$  is called the *hyperbolic amplitude* of  $v$ ; and, by analogy, we write  $\phi = \text{anh } v$ . Also when  $x = \cosh v$ , we have  $v = \log(x + \sqrt{x^2 - 1})$ . Again, when  $y = \sinh v$ , we have  $v = \log(y + \sqrt{y^2 + 1})$ .

Moreover, since  $v$  is the sector whose corresponding hyperbolic cosine is  $x$ , the connexion between  $v$  and  $x$  may be represented by the relation  $v = \text{sect } \cosh x$ .

Hence we have

$$\text{sect } \cosh x = \log(x + \sqrt{x^2 - 1}).$$

In like manner we get

$$\begin{aligned} \text{sect } \sinh x &= \log(x + \sqrt{x^2 + 1}), \\ \text{sect } \tanh x &= \frac{1}{2} \log \frac{1+x}{1-x}. \end{aligned}$$

This notation exhibits the analogy between the elementary integrals in a remarkable manner, and even more strikingly when we introduce the Continental notation, arc sin  $x$ , instead of  $\sin^{-1}x$ , &c.

Thus

$$\begin{aligned} \int \frac{dx}{\sqrt{1-x^2}} &= \sin^{-1}x = \text{arc } \sin x; \\ \int \frac{dx}{\sqrt{1+x^2}} &= \log(x + \sqrt{1+x^2}) = \text{sect } \sinh x; \\ \int \frac{dx}{1+x^2} &= \tan^{-1}x = \text{arc } \tan x; \\ \int \frac{dx}{1-x^2} &= \frac{1}{2} \log \frac{1+x}{1-x} = \text{sect } \tanh x. \end{aligned}$$

*Ex. 3.* To find the area included between the cissoid of Diocles and its asymptote.

The equation of this curve is

$$y^2(2a-x) = x^3,$$

and that of its asymptote is  $x = 2a$ .

Hence the area in question is represented by

$$\int_0^{2a} \frac{x^3 dx}{(2a-x)^{\frac{3}{2}}}$$

Let  $x = 2a \sin^2 \theta$ , and the integral becomes

$$8a^2 \int_0^{\frac{\pi}{2}} \sin^4 \theta d\theta = \frac{3}{2} \pi a^2.$$

*Ex. 4.* To find the whole area of the curve

$$\left(\frac{x}{a}\right)^{\frac{2}{n}} + \left(\frac{y}{b}\right)^{\frac{2}{n}} = 1.$$

Let  $\frac{x}{a} = \cos^2 \theta$ ; then  $\frac{y}{b} = \sin^2 \theta$ .

Hence the whole area is represented by

$$4ab \int_0^{\frac{\pi}{2}} x^{\frac{n-1}{n}} \sin^{n-1} \theta \cos^{n-1} \theta d\theta.$$

The method of determining this integral has been exhibited in § 122.

164. In the preceding examples the area of any portion of a plane may be conceived as divided into a system of infinitesimal rectangles,  $dx dy$ , by lines drawn parallel to the axes of coordinates. Accordingly any plane area may be represented by  $\iint dx dy$ , taken between limits determined by the boundary of the area.

Again, as in polar coordinates, the plane may be divided by a system of circles having the origin as centre, and also by a system of radii vectors drawn through the origin. In such coordinates the element of area bounded by two circles of radii  $r$  and  $r + dr$  and by the radii vectors corresponding to the angles  $\theta$  and  $\theta + d\theta$  is plainly represented by  $r dr d\theta$ . Accordingly, any plane area may be represented by

$$\iint r dr d\theta$$

taken between the limits determined by its boundary.

Hence, if the equation of a curve be given in polar coordinates, the sectorial area  $S$  bounded by two radii, and the curve is represented by

$$S = \frac{1}{2} \int_a^\beta r^2 d\theta,$$

where  $\alpha$  and  $\beta$  are the values of  $\theta$  corresponding to the limiting radii.

(1) For example, in the class of spirals represented by  $r = a\theta^m$ , we have

$$S = \frac{a^2}{2} \frac{\theta^{2m+1}}{2m+1} + \text{const.}$$

If the area be bounded by the prime vector  $\theta = 0$ , this gives

$$S = \frac{a^2}{2} \frac{\theta^{2m+1}}{2m+1}$$

Thus for the spiral of Archimedes, whose equation is  $r = a\theta$ ,

$$S = \frac{a^2}{6} \theta^3 = \frac{r^3}{6a}.$$

In the spiral,  $r^2 = a\theta$ , we have

$$S = \frac{a^2 \theta^2}{4} = \left(\frac{r^2}{2a}\right)^2.$$

In the reciprocal to this spiral, viz.,  $r^2 \theta = a^2$ , we have

$$S = \frac{a^2}{2} \log \theta = a^2 \log \left(\frac{a}{r}\right),$$

in which the sector is reckoned from  $\theta = 1$ .

(2) To find the area of a loop of the curve

$$r^2 = a^2 \cos n\theta.$$

Here  $r = 0$  when  $n\theta = \frac{\pi}{2}$ , and  $r = a$  when  $n\theta = 0$ . Consequently the area of a loop is represented by

$$a^2 \int_0^{\frac{\pi}{2n}} \cos n\theta d\theta,$$

and, accordingly, is  $\frac{a^2}{n}$ . It is easily seen that when  $n$  is a positive integer, the curve consists of  $n$  loops; accordingly the entire area of the curve is  $a^2$ .

(3) To find the area of the loop of the folium of Descartes, the equation of the curve being  $x^2 + y^3 = 3axy$ .

Transforming to polar coordinates, we get

$$S = \frac{9a^2}{2} \int_0^{\frac{\pi}{2}} \frac{\sin^2 \theta \cos^2 \theta d\theta}{(\sin^3 \theta + \cos^3 \theta)^2}.$$

Let  $\tan \theta = u$ , and this becomes

$$\frac{9a^2}{2} \int_0^{\infty} \frac{u^2 du}{(1+u^3)^2} = \frac{3a^2}{2}.$$

165. If from any point a perpendicular be drawn to any tangent to a curve, the locus of the foot of the perpendicular is called the *pedal* of the curve with respect to the assumed origin.

If  $p$  and  $\omega$  be the polar coordinates of the foot of the perpendicular, the sectorial area of the pedal curve is plainly represented by

$$\frac{1}{2} \int p^2 d\omega$$

taken between proper limits.

The following remarkable connexion between the pedal areas with respect to the same closed curve, for different internal origins, is due to Steiner. Let  $A$  be the area of the pedal with respect to the origin  $O$ ,  $A'$  the area for origin  $O'$ , and  $p, p'$  the corresponding perpendiculars, then we have

$$A = \frac{1}{2} \int_0^{2\pi} p^2 d\omega, \quad A' = \frac{1}{2} \int_0^{2\pi} p'^2 d\omega.$$



If, now,  $x, y$  be the coordinates of  $O'$  with respect to a pair of rectangular axes drawn through  $O$ , we shall have

$$p' = p - x \cos \omega - y \sin \omega ;$$

therefore

$$A' - A = \frac{1}{2} \int_0^{2\pi} (x \cos \omega + y \sin \omega)^2 d\omega - x \int_0^{2\pi} p \cos \omega d\omega - y \int_0^{2\pi} p \sin \omega d\omega .$$

Bnt

$$\int_0^{2\pi} \cos^2 \omega d\omega = \pi, \int_0^{2\pi} \sin^2 \omega d\omega = \pi, \int_0^{2\pi} \sin \omega \cos \omega d\omega = 0 ;$$

consequently  $A' - A = \frac{\pi}{2} (x^2 + y^2) - gx - hy ,$

where  $g = \int_0^{2\pi} p \cos \omega d\omega, h = \int_0^{2\pi} p \sin \omega d\omega .$

Hence we infer that, if  $O$  be fixed, the locus of  $O'$ , when the corresponding pedal area  $A'$  is constant, is a circle.

All the circles obtained by varying the pedal area are concentric. Also the common centre is the point for which the pedal area is a minimum, and the pedal area with respect to any origin exceeds the minimum pedal area by half the area of the circle whose radius is the distance between the pedal origins. Many interesting results may be deduced from this theorem. When the curve is not closed, it is easy to prove, as was shown by Prof. Raabe (*Crelle*, vol. 1.), that the locus of the origin for pedals of equal areas is an ellipse. The corresponding theorems for the volumes of the pedals of surfaces were investigated by Dr Hirst (*Transactions of the Royal Society*, 1863). In addition to other important generalizations, Dr Hirst has here proved, when the surface is closed, that the locus of the origin for equal pedal volumes is a surface of the second degree.

Another remarkable theorem of Steiner's, on the connexion between the areas of pedals and of roulettes, may be stated here. *When a closed curve rolls on a right line, the area between the right line and the roulette generated by any point invariably connected with the rolling curve, in a complete revolution, is double the area of the pedal of the rolling curve, taken with respect to the generating point as origin.* Hence it follows that there is one point in a closed curve for which the entire area of the roulette, described in a complete revolution, is a minimum. Also, the area of the roulette described by any other point exceeds that of the minimum roulette by the area of the circle whose radius is the distance between the points.

*Rectification of Curves.*

166. The rectification of curves is based on the principle that the length of an arc of any curve is the limit to which the perimeter of an inscribed polygon approaches when each of its sides is conceived to diminish indefinitely.

Hence, if the curve be referred to rectangular axes of coordinates, and if  $ds$  denote the element of the arc of the curve at the point  $(x, y)$ , we shall have

$$ds^2 = dx^2 + dy^2,$$

and accordingly

$$s = \int \left\{ 1 + \left( \frac{dy}{dx} \right)^2 \right\}^{\frac{1}{2}} dx, \text{ or } s = \int \left\{ 1 + \left( \frac{dx}{dy} \right)^2 \right\}^{\frac{1}{2}} dy,$$

taken between the limiting points, *i.e.*, the extremities of the arc.

In like manner if the curve be referred to polar coordinates we shall have

$$s = \int \left\{ 1 + \left( \frac{rd\theta}{dr} \right)^2 \right\}^{\frac{1}{2}} dr, \text{ or } s = \int \left\{ r^2 + \left( \frac{dr}{d\theta} \right)^2 \right\}^{\frac{1}{2}} d\theta .$$

We shall illustrate these formulæ by a few simple cases.

Ex. 1. In the ordinary parabola  $x^2 = 2py$  we have

$$\frac{dy}{dx} = \frac{x}{p} ;$$

$$\therefore s = \frac{1}{p} \int (x^2 + p^2)^{\frac{1}{2}} dx = \frac{(x^2 + p^2)^{\frac{1}{2}}}{2p} + \frac{p}{2} \log \frac{x + \sqrt{x^2 + p^2}}{p} .$$

Ex. 2. In the more general parabolic curve represented by  $x^n = py$  we have

$$\frac{dy}{dx} = \frac{n}{p} x^{n-1} ;$$

$$\therefore s = \int \left( 1 + \frac{n^2}{p^2} x^{2n-2} \right)^{\frac{1}{2}} dx .$$

This expression is capable of integration in a finite algebraical form (§ 123) for the following values of  $2n - 2$ ,

$$1, \frac{1}{2}, \frac{1}{3}, \frac{1}{4}, \dots, \frac{1}{r}, \text{ \&c.},$$

*i.e.*, when  $n$  is

$$\frac{3}{2}, \frac{5}{4}, \frac{7}{6}, \dots, \frac{2r+1}{2r}, \text{ \&c.}$$

167. In illustration of the method of rectification in polar coordinates, we commence with the spiral of Archimedes,  $r = a\theta$ .

Here

$$s = \frac{1}{a} \int (r^2 + a^2)^{\frac{1}{2}} dr .$$

This shows that the length of any arc of this spiral is equal to that of a corresponding arc of a parabola.

This relation between the spiral of Archimedes and the parabola was discovered, according to Sir John Leslie, by Gregoire St Vincent, before the middle of the 17th century (see Leslie's *Geometrical Analysis*, p. 424). That a corresponding relation connected the parabola  $y^n = px$  and the spiral  $r^{n-1} = \frac{n-1}{n} p\theta$  was established by

John Bernoulli (*Acta Erud.*, 1691).

These results were extended by Lardner (*Algebraic Geometry*, p. 355), and in their general form may be stated thus:—

*If from the equation to any curve in rectangular coordinates another curve in polar coordinates be formed, by making  $dy = dr$  and  $dx = rd\theta$ , then the length of any arc of the second curve will be equal to that of the corresponding arc of the first curve. Also the sectorial area of the second curve will be half the area bounded by the corresponding  $y$  ordinates in the first curve.*

These relations can be immediately established.

As an example, the right line  $y = mx$  gives by this transformation the logarithmic spiral  $r = e^{m\theta}$ . Hence we can always obtain a portion of a right line equal in length to any arc of this spiral, — a result which is obvious otherwise.

Again, from the ellipse

$$\frac{x^2}{a^2} + \frac{y^2}{b^2} = 1 \text{ we get } x = \frac{a}{b} \sqrt{b^2 - y^2},$$

$$\therefore dx = -\frac{a}{b} \frac{y dy}{\sqrt{b^2 - y^2}} .$$

Hence the differential equation of the transformed curve is

$$d\theta = -\frac{a}{b} \frac{dr}{\sqrt{b^2 - r^2}},$$

from which we get

$$r = b \cos \frac{b}{a} \theta,$$

where  $\theta$  is measured from the line which corresponds to the major axis of the ellipse. Accordingly, the rectification and quadrature of this latter curve is the same as for the ellipse. This can also be shown immediately otherwise.

168. Whenever the pedal equation of a curve (§ 165) can be found, there is another general formula for its rectification, which may be proved thus.

In fig. 9 let  $ON$  be the perpendicular

let fall on the tangent at any point  $P$  on a curve, and  $ON'$  the perpendicular on the tangent at a consecutive point  $Q$ ;

and suppose  $ON = p$ , angle  $AON = \omega$ , and  $PN = t$ . Then  $PQ = \Delta s$ , angle  $SON = \Delta \omega$ ,  $\Delta t = QN' - PN$ .

Hence  $\frac{ds}{d\omega} = \lim. \frac{PT + TQ}{\Delta \omega}, \frac{dt}{d\omega} = \lim. \frac{QN' - PN}{\Delta \omega} .$

But

$$PT + TQ + PN - QN' = TN - TN' ;$$

hence  $\frac{ds}{d\omega} - \frac{dt}{d\omega} = \lim. \frac{TN - TN'}{\Delta \omega} = \lim. \frac{SN}{\Delta \omega} = ON = p .$

Accordingly, if  $\omega_1$  and  $\omega_0$  be the values of  $\omega$  corresponding to the extremities of the arc  $s$ , and  $t_1, t_0$  the corresponding values of  $t$ , we have

$$s = t_1 - t_0 + \int_{\omega_0}^{\omega_1} p d\omega .$$

This theorem is due to Legendre. In its application it is well to observe, that

$$\frac{dp}{d\omega} = \lim. \frac{SN'}{\Delta \omega} = \lim. TN' = t .$$

For example, in the parabola we have

$$p = \frac{a}{\cos \omega} ; \therefore \frac{dp}{d\omega} = \frac{a \sin \omega}{\cos^2 \omega} .$$

Hence, if  $s$  be measured from the vertex of the parabola, we have

$$s = \frac{a \sin \omega}{\cos^2 \omega} + a \int_0^{\omega} \frac{d\omega}{\cos \omega} = a \frac{\sin \omega}{\cos^2 \omega} + a \log \tan \left( \frac{\pi}{4} + \frac{\omega}{2} \right) .$$

Similarly in the ellipse,  $\frac{x^2}{a^2} + \frac{y^2}{b^2} = 1$ , we have  $p = \sqrt{a^2 \cos^2 \omega + b^2 \sin^2 \omega}$ .

Accordingly, the rectification of the ellipse depends on the integral

$$\int \sqrt{a^2 \cos^2 \omega + b^2 \sin^2 \omega} d\omega .$$

Likewise the rectification of the hyperbola depends on the integral

$$\int \sqrt{a^2 \cos^2 \omega - b^2 \sin^2 \omega} d\omega .$$

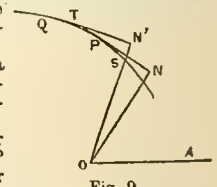

Fig. 9.

Further considerations on the rectification of these curves will be found under the head of elliptic integrals.

169. Steiner's theorem connecting the rectification of pedals and roulettes, analogous to that which connects their areas (§ 165), may be here stated. It is as follows:—

If a curve roll on a right line, the length of the roulette described by any point connected with the rolling curve is equal to the corresponding arc of the pedal of the rolling curve, taken with respect to the describing point as origin.

From this it is easily seen that the length of any arc of a cycloid is equal to that of a corresponding portion of a cardioid, and the length of a trochoid to an arc of a limaçon. Again, if an ellipse be supposed to roll on a right line, the length of the roulette described by either of its foci is equal to the length of the corresponding arc of the auxiliary circle.

*Rectification of Curves of Double Curvature.*

170. If the points in a curve be not in the same plane, the curve is said to be one of *double curvature*.

Formulae for the rectification of curves of double curvature are easily obtained. Thus, if the curve be referred to a system of rectangular axes in space, we shall have

$$ds^2 = dx^2 + dy^2 + dz^2.$$

Hence, if  $x$  be taken as the independent variable, we have

$$s = \int \left( 1 + \frac{dy^2}{dx^2} + \frac{dz^2}{dx^2} \right)^{\frac{1}{2}} dx,$$

and similar formulæ when either  $y$  or  $z$  is taken as the independent variable.

The equations of the curve are usually written in the form

$$f(x, y) = 0, \quad \phi(x, z) = 0;$$

that is, the curve is determined by the intersection of two cylinders. The values of  $\frac{dy}{dx}$  and  $\frac{dz}{dx}$  deduced from these equations have to be substituted in the foregoing integral.

It is not difficult to determine a relation between the functions  $f$  and  $\phi$  in order that the arc of the curve of intersection may admit of easy determination.

The simplest class is where  $\left(\frac{dy}{dx}\right)^2 = 2\frac{dz}{dx}$ ; for in this case

$$s = \int \left( 1 + 2\frac{dz}{dx} + \left(\frac{dz}{dx}\right)^2 \right)^{\frac{1}{2}} dx \\ = \int \left( 1 + \frac{dz}{dx} \right) dx = x + z + \text{const.}$$

For example, in the parabolic cylinder

$$x^2 = 2py + \text{const.},$$

we have

$$\frac{dy}{dx} = \frac{x}{y}.$$

Accordingly, let

$$\frac{dz}{dx} = \frac{x^2}{y^2},$$

and we get

$$z = \frac{x^3}{6y^3} + \text{const.},$$

hence the length of the curve of intersection of the cylindrical surfaces

$$x^2 = 2py + c, \quad x^3 = 6y^3z + c'$$

is immediately determined. In general, when  $y=f(x)$  is the equation of the first cylinder, and that of the second is represented by the equation

$$z = \frac{1}{2} \int \{ f'(x) \}^2 dx + \text{constant},$$

the arc is determined by the above formula.

171. If we transform to polar coordinates by the relations

$$x = r \cos \theta \sin \phi, \quad y = r \sin \theta \sin \phi, \quad z = r \cos \phi,$$

we get

$$ds^2 = dr^2 + r^2 d\phi^2 + r^2 \sin^2 \phi d\theta^2;$$

hence, for the rectification of a curve of double curvature we have

$$s = \int \left( 1 + r^2 \frac{d\phi^2}{dr^2} + r^2 \sin^2 \phi \frac{d\theta^2}{dr^2} \right)^{\frac{1}{2}} dr; \\ s = \int \left( r^2 + \frac{dr^2}{d\phi^2} + r^2 \sin^2 \phi \frac{d\theta^2}{d\phi^2} \right)^{\frac{1}{2}} d\phi.$$

The latter gives for the length of the arc of a curve on a sphere, of radius  $a$ ,

$$s = a \int \left( 1 + \sin^2 \phi \frac{d\theta^2}{d\phi^2} \right)^{\frac{1}{2}} d\phi.$$

If  $\phi$  be const. =  $\alpha$ , the curve lies on a right cone; and we have

$$s = \int \left( 1 + r^2 \sin^2 \alpha \frac{d\theta^2}{dr^2} \right)^{\frac{1}{2}} dr.$$

*Cubature of Solids.*

172. The method usually adopted, in seeking the volume of any solid, consists in supposing it divided by parallel planes into an indefinite number of thin slices. Then in finding the volume we may in the limit consider each slice as an infinitely thin cylindrical plate; and, consequently, represent its volume by the product of the area of the corresponding section into the indefinitely small distance between the parallel planes which bound it.

Thus, if the points in the body be referred to a system of rectangular axes of coordinates, and the system of parallel planes be perpendicular to the axis of  $x$ , then, representing the area of the section at the distance  $x$  from the origin by  $A_x$ , the volume of the solid will be represented by

$$\int A_x dx$$

taken between proper limits.

Adopting a similar notation, the volume of a solid may be represented by

$$\int A_y dy, \text{ or } \int A_z dz.$$

In the case of a surface of revolution, the sections are drawn perpendicular to the axis of revolution. Thus, if any curve, situated in the plane  $xy$ , turn round the axis of  $x$ , a plane perpendicular to the axis cuts the surface in a circle. The area of this circle is  $\pi y^2$ ; consequently the volume between two sections, corresponding to the abscissæ  $a$  and  $b$ , is represented by

$$\pi \int_a^b y^2 dx.$$

(1) Suppose the ellipse  $\frac{x^2}{a^2} + \frac{y^2}{b^2} = 1$  to revolve round its axis of  $x$ , then the entire volume of the generated solid is

$$\pi \int_{-a}^a b^2 \left( 1 - \frac{x^2}{a^2} \right) dx = 2\pi b^2 \int_0^a \left( 1 - \frac{x^2}{a^2} \right) dx = \frac{4}{3} \pi a b^3.$$

(2) If the parabola  $y = ax^n$  revolve round the axis of  $x$ , the volume cut off by a plane at the distance  $X$  from the origin is

$$\pi \int_0^X a^2 x^{2n} dx = \frac{\pi a^2 X^{2n+1}}{2n+1} = \frac{\pi X Y^2}{2n+1}.$$

(3) To find the volume of the ellipsoid

$$\frac{x^2}{a^2} + \frac{y^2}{b^2} + \frac{z^2}{c^2} = 1.$$

Here the section at the distance  $z$  from the origin is the ellipse

$$\frac{x^2}{a^2} + \frac{y^2}{b^2} = 1 - \frac{z^2}{c^2}.$$

The area of this section  $A_z$  is

$$\pi \left( 1 - \frac{z^2}{c^2} \right) ab;$$

accordingly the volume of the ellipsoid is represented by

$$2\pi ab \int_0^c \left( 1 - \frac{z^2}{c^2} \right) dz = \frac{4}{3} \pi abc.$$

(4) To find the volume of the surface generated by the revolution of a cycloid round its base.

It is easily seen that the coordinates of any point on a cycloid, of radius  $a$ , are capable of being represented by

$$x = a(\phi + \sin \phi), \quad y = a(1 + \cos \phi).$$

Hence the volume  $V$  generated is given by the equation

$$V = 2\pi a^3 \int_0^\pi (1 + \cos \phi)^3 d\phi = 16\pi a^3 \int_0^\pi \cos^2 \frac{\phi}{2} d\phi = 5\pi^2 a^3.$$

(5) To find the volume of the portion of the paraboloid

$$\frac{x^2}{t} + \frac{y^2}{m} = 2z$$

cut off by a plane drawn perpendicular to the axis of  $z$ .

Here, the area of the section at the distance  $z$  from the origin is  $2\pi z \sqrt{tm}$ . Hence, if  $c$  be the distance of the bounding plane,

$$V = 2\pi \sqrt{tm} \int_0^c z dz = \pi c^2 \sqrt{tm}.$$

Consequently the volume is half that of the circumscribing cylinder.

173. Again, since any solid can be supposed divided into an indefinite number of elementary parallelepipeds, the volume enclosed within any boundary may be represented by

$$\iiint dx dy dz,$$

the limits being determined in each case by the nature of the problem.

For example, cubature of the ellipsoid

$$\frac{x^2}{a^2} + \frac{y^2}{b^2} + \frac{z^2}{c^2} = 1$$

is equivalent to the determination of the triple integral

$$\iiint dx dy dz,$$

for all values of  $x, y, z$  subject to the relation

$$\frac{x^2}{a^2} + \frac{y^2}{b^2} + \frac{z^2}{c^2} < 1.$$

Here, as in all other cases, we integrate, first, with respect to one of the variables, regarding the others as constant, and determine the limits from the given relation.

Thus, integrating with respect to  $z$ , and observing that the limit-

ing values of  $z$  are  $\pm c \sqrt{1 - \frac{x^2}{a^2} - \frac{y^2}{b^2}}$ , we get

$$V = 2c \iint \sqrt{1 - \frac{x^2}{a^2} - \frac{y^2}{b^2}} dx dy,$$

in which  $x, y$  are connected by the relation

$$\frac{x^2}{a^2} + \frac{y^2}{b^2} < 1.$$

This integral is easily determined by making

$$\frac{y}{b} = \sqrt{1 - \frac{x^2}{a^2}} \sin \phi;$$

then

$$dy = b \sqrt{1 - \frac{x^2}{a^2}} \cos \phi d\phi,$$

and

$$V = 2bc \iint \left(1 - \frac{x^2}{a^2}\right) \cos^2 \phi d\phi,$$

where the limits for  $\phi$  are  $\frac{\pi}{2}$  and  $-\frac{\pi}{2}$

But

$$\int_{-\frac{\pi}{2}}^{+\frac{\pi}{2}} \cos^2 \phi d\phi = \frac{\pi}{2},$$

hence

$$V = \pi bc \int_{-a}^{+a} \left(1 - \frac{x^2}{a^2}\right) dx = \frac{4}{3} \pi abc, \text{ as before.}$$

The geometrical interpretation of each step in the preceding demonstration can be readily supplied by the reader.

It may be observed that, in consequence of the symmetry of the ellipsoid, the preceding integrations might have been limited to positive values of  $x, y, z$ ,—thus determining the eighth part of the entire volume. A similar remark applies to any symmetrical surface. It will also be observed that the determination of the volume of an ellipsoid is a simple case of the theorem given in § 157.

Similarly the volume included within the surface

$$\left(\frac{x}{a}\right)^{\frac{2}{l}} + \left(\frac{y}{b}\right)^{\frac{2}{m}} + \left(\frac{z}{c}\right)^{\frac{2}{n}} = 1$$

is reducible to the determination of the triple integral

$$\iiint dx dy dz$$

extended to all positive values of  $x, y, z$ , subject to the condition

$$\left(\frac{x}{a}\right)^{\frac{2}{l}} + \left(\frac{y}{b}\right)^{\frac{2}{m}} + \left(\frac{z}{c}\right)^{\frac{2}{n}} < 1.$$

Hence, by § 157, we get

$$V = lmnabc \frac{\Gamma\left(\frac{l}{2}\right)\Gamma\left(\frac{m}{2}\right)\Gamma\left(\frac{n}{2}\right)}{\Gamma\left(1 + \frac{l+m+n}{2}\right)}$$

Thus, for instance, the volume enclosed by the surface

$$\left(\frac{x}{a}\right)^3 + \left(\frac{y}{b}\right)^3 + \left(\frac{z}{c}\right)^3 = 1 \text{ is } \frac{4\pi abc}{5 \cdot 7}$$

In like manner the volume enclosed within the surface

$$\left(\frac{x}{a}\right)^2 + \left(\frac{y}{b}\right)^2 + \left(\frac{z}{c}\right)^2 = 1 \text{ is } \frac{20\pi abc}{3 \cdot 7 \cdot 11 \cdot 13},$$

and so on.

174. From the preceding it will be apparent that every double integral may, in general, be represented by a volume.

As an example, let us consider the double integral

$$u = \int_a^{2a} \int_0^b \sqrt{2ax - x^2} f(x, y) dx dy.$$

Here, since  $y > 0$  and  $< \frac{b}{a} \sqrt{2ax - x^2}$ , and the limits of  $x$  are 0 and  $2a$ , it is readily seen that the integral represents half the

volume of the solid bounded by the surface  $z = f(x, y)$ , by the plane of  $xy$ , and by the cylinder having as its base the ellipse

$$\frac{x^2}{a^2} + \frac{y^2}{b^2} - \frac{2x}{a} = 1.$$

For instance, suppose the bounding surface to be the paraboloid

$$\frac{x^2}{l} + \frac{y^2}{m} = 2z,$$

then the volume in question becomes

$$u = \frac{1}{2} \int_0^{2a} \int_0^b \sqrt{2ax - x^2} \left(\frac{x^2}{l} + \frac{y^2}{m}\right) dx dy \\ = \frac{b}{2a} \int_0^{2a} \left\{ \frac{x^3}{l} (2ax - x^2)^{\frac{1}{2}} + \frac{b^2}{3ma^2} (2ax - x^2)^{\frac{3}{2}} \right\} dx$$

To integrate this, assume  $x = 2a \sin^2 \theta$ , and we get

$$u = \frac{16a^3 b}{l} \int_0^{\frac{\pi}{2}} \cos^2 \theta \sin^3 \theta d\theta + \frac{16ab^3}{3m} \int_0^{\frac{\pi}{2}} \sin^3 \theta \cos^4 \theta d\theta \\ = \frac{\pi ab}{8} \left( \frac{5a^2}{l} + \frac{b^2}{m} \right)$$

175. Again, the double integral

$$\int_{x_0}^X \int_{y_0}^Y f(x, y) dx dy,$$

when the limits  $X, x_0, Y, y_0$  are constants, represents the volume bounded by the plane  $xy$ , the surface  $z = f(x, y)$ , and the planes  $x = X, x = x_0, y = Y, y = y_0$ . Also, in the determination of this double integral the order of integration may, in general, be changed (§ 148); and this change in the order produces no alteration in the limits. The latter statement no longer holds when the limits of integration with respect to the first variable are functions of the second.

In this latter case it is of importance to be able to determine in each case what are the new limits when the order of integration is reversed. This can generally be best effected from geometrical considerations; thus, for instance, in the example of the preceding article, we readily find, when the order is reversed, the new limits of  $x$  to be  $a + a \sqrt{1 - \frac{y^2}{b^2}}$  and  $a - a \sqrt{1 - \frac{y^2}{b^2}}$ , and that the subsequent limits for  $y$  are 0 and  $b$ .

As another example, let us consider the double integral

$$u = \int_0^a \int_0^{\frac{b}{a}x} f(x, y) dx dy.$$

If we take on the axis of  $x$  a portion  $OA = a$  (fig. 10), and on the axis of  $y$ ,  $OB = b$ , and complete the rectangle  $OACB$ , it is plain from the equation that the point  $(x, y)$  is limited to the triangle  $OAC$ .

Accordingly, if the order of integration be reversed, we must suppose the area, instead of being divided into infinitesimal strips parallel to the axis of  $y$ , to be divided into strips parallel to the axis of  $x$ . Hence, the limits for  $x$ ,

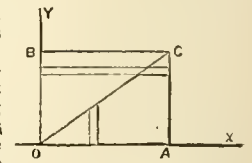

Fig. 10.

when  $y$  is constant, are  $a$  and  $\frac{ay}{b}$ ; and the subsequent limits for  $y$  are  $b$  and 0.

Consequently,

$$\int_0^a \int_0^{\frac{b}{a}x} f(x, y) dx dy = \int_0^b \int_{\frac{ay}{b}}^a f(x, y) dx dy.$$

As an exemplification of the advantage of an interchange in the order of integration it will suffice to take the double integral

$$u = \int_0^a \int_0^x \frac{f'(y) dx dy}{\sqrt{(a-x)(x-y)}}$$

Here, interchanging the order, we have by the preceding

$$u = \int_0^a \int_y^a \frac{f'(y) dy dx}{\sqrt{(a-x)(x-y)}}$$

But (§ 139),

$$\int_y^a \frac{dx}{\sqrt{(a-x)(x-y)}} = \pi.$$

$$u = \int_0^a f'(y) dy = \pi \{f(a) - f(0)\}$$

It may be observed that in many cases, when the order of integration



tion is reversed, we get two or more double integrals instead of the original integral.

176. It is frequently found necessary to transform a double integral

$$\iint f(x, y) dx dy,$$

referred to rectangular coordinates, to another referred to polar coordinates.

In this case, as in § 164, we substitute  $rdrd\theta$  instead of  $dx dy$ , and the integral becomes

$$\iint f(r \cos \theta, r \sin \theta) r dr d\theta$$

The limits in the latter integral are determined from the equations which give the limits in the former.

For example, to find the volume comprised between the plane of  $xy$ , the hyperbolic paraboloid  $cx = xy$ , and the right cylinder  $(x - a)^2 + (y - b)^2 = k^2$ .

Here

$$V = \frac{1}{c} \iint xy dx dy,$$

extended to all values of  $x, y$ , subject to the condition

$$(x - a)^2 + (y - b)^2 < k^2.$$

Assuming the origin of polar coordinates at the point  $a, b$ , and transforming the equation, we get

$$V = \frac{1}{c} \int_0^k \int_0^{2\pi} (a + r \cos \theta)(b + r \sin \theta) r dr d\theta = \frac{\pi abk^2}{c}.$$

since

$$\int_0^{2\pi} \sin \theta d\theta = 0, \int_0^{2\pi} \cos \theta d\theta = 0, \int_0^{2\pi} \sin \theta \cos \theta d\theta = 0.$$

177. The triple integral

$$\iiint f(x, y, z) dx dy dz$$

can be transformed in like manner.

For, first, take

$$x = \rho \cos \phi, y = \rho \sin \phi,$$

and the integral transforms into

$$\iiint f(\rho \cos \phi, \rho \sin \phi, z) \rho d\rho d\phi dz$$

Again, assume  $z = r \cos \theta, \rho = r \sin \theta$ , and the multiple integral becomes

$$\iiint f(r \sin \theta \cos \phi, r \sin \theta \sin \phi, r \cos \theta) r^2 \sin \theta dr d\theta d\phi.$$

With respect to the limits in the new integral, it may be observed that, in this and all other cases, the new limits must be taken in such a manner that the transformed multiple integral shall comprise every element which enters into the original integral, and no more.

In particular the volume of any solid is represented by

$$\iiint r^2 \sin \theta dr d\theta d\phi,$$

taken between limits determined by the boundary of the solid.

If this expression be integrated with respect to  $r$ , we have

$$V = \frac{1}{3} \iiint r^3 \sin \theta d\theta d\phi,$$

in which we must substitute for  $r$  its value determined by the equation of the bounding surface.

For example, let us investigate the volume within the surface

$$(x^2 + y^2 + z^2)^2 = (a^2 x^2 + b^2 y^2 + c^2 z^2)^2.$$

Here we get

$$r^2 = a^2 \sin^2 \theta \cos^2 \phi + b^2 \sin^2 \theta \sin^2 \phi + c^2 \cos^2 \theta,$$

and, as the equation is symmetrical, we have

$$V = \frac{1}{3} \int_0^{\pi/2} \int_0^{\pi/2} \int_0^{\pi/2} (a^2 \sin^2 \theta \cos^2 \phi + b^2 \sin^2 \theta \sin^2 \phi + c^2 \cos^2 \theta) \sin \theta d\theta d\phi d\phi \\ = \frac{1}{3} \int_0^{\pi/2} \int_0^{\pi/2} (2a^2 \cos^2 \phi + 2b^2 \sin^2 \phi + c^2) d\phi = \frac{4\pi}{9} (a^3 + b^3 + c^3)$$

Again, the expression for the volume of the ellipsoid

$$\frac{x^2}{a^2} + \frac{y^2}{b^2} + \frac{z^2}{c^2} = 1$$

is represented by the integral

$$\int_0^{\pi/2} \int_0^{\pi/2} \int_0^{\pi/2} \frac{\sin \theta d\theta d\phi d\psi}{\left\{ \frac{\sin^2 \theta \cos^2 \phi + \sin^2 \theta \sin^2 \phi + \cos^2 \theta}{a^2} + \frac{\sin^2 \theta \cos^2 \phi + \sin^2 \theta \sin^2 \phi + \cos^2 \theta}{b^2} + \frac{\cos^2 \theta}{c^2} \right\}^{3/2}}$$

Hence, since the volume of the ellipsoid is  $\frac{4}{3}\pi abc$ , we get

$$\int_0^{\pi/2} \int_0^{\pi/2} \int_0^{\pi/2} \frac{\sin \theta d\theta d\phi d\psi}{\left\{ \frac{\sin^2 \theta \cos^2 \phi + \sin^2 \theta \sin^2 \phi + \cos^2 \theta}{a^2} + \frac{\sin^2 \theta \cos^2 \phi + \sin^2 \theta \sin^2 \phi + \cos^2 \theta}{b^2} + \frac{\cos^2 \theta}{c^2} \right\}^{3/2}} = \frac{\pi abc}{2},$$

a result which admits of a direct demonstration.

178. The multiple integral

$$u = \iiint V dx_1 dx_2 dx_3 dx_4$$

admits of a like transformation.

For, let  $x_1 = \rho_1 \cos \phi, x_2 = \rho_1 \sin \phi$ , and it becomes

$$\iiint V_1 \rho_1 d\rho_1 d\phi dx_3 dx_4,$$

where  $V_1$  represents the transformed value of  $V$ .

In like manner, if  $x_3 = \rho_2 \cos \psi, x_4 = \rho_2 \sin \psi$ , the transformed integral may be written

$$\iiint V_2 \rho_1 \rho_2 d\rho_1 d\rho_2 d\phi d\psi$$

Again, if  $\rho_1 = r \cos \theta, \rho_2 = r \sin \theta$ , the integral assumes the form

$$\iiint V_3 r^3 \sin \theta \cos \theta dr d\theta d\phi d\psi,$$

where  $V_3$  represents the final form of  $V$ . In this case the values of  $x_1, x_2, x_3, x_4$ , in terms of the new variables, are

$$x_1 = r \cos \theta \cos \phi, x_2 = r \sin \theta \cos \phi, \\ x_3 = r \cos \theta \sin \psi, x_4 = r \sin \theta \sin \psi.$$

Quadrature of Surfaces.

179. It is readily shown that the area of any cylindrical surface, bounded by two planes perpendicular to its axis, is equal to the rectangle under the height of the cylinder and the perimeter of its base; also that the surface of a truncated right cone is equal to the rectangle under its mean section and the length of the portion of any edge of the cone intercepted between the bounding sections.

In the evaluation of the superficial area of a solid of revolution, we proceed, as in § 172, by supposing the surface divided by planes

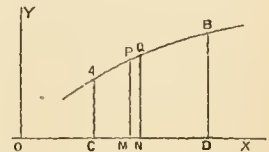

Fig. 11.

perpendicular to the axis of revolution (fig. 11). Then the elementary portion of surface between two indefinitely near planes may be regarded as a portion of the surface of a right cone, generated by the revolution of the corresponding element of the curve round the axis. Hence, denoting the element PQ by  $ds$ , and FM by  $y$ ,

the area generated by PQ in a complete revolution round the axis of  $x$  is represented in the limit by  $2\pi y ds$ . Consequently, if  $S$  be the surface generated by the curve AB, we have

$$S = 2\pi \int y ds,$$

taken between limits corresponding to the points A and B.

(1) Thus for the sphere, generated by the revolution of the circle  $x^2 + y^2 = a^2$  round the axis of  $x$ , we have

$$ds = \left\{ 1 + \left( \frac{dy}{dx} \right)^2 \right\}^{1/2} dx = \left( 1 + \frac{x^2}{y^2} \right)^{1/2} dx = \frac{a}{y} dx$$

Hence  $S = 2\pi \int a dx = 2\pi a(X - x_0)$ , if  $X, x_0$  be the limits for  $x$ .

Accordingly, the whole surface is  $4\pi a^2$ , i. e., four times the area of one of the great circles of the sphere. Also the surface bounded by any two parallel planes is equal to the corresponding surface cut out of the circumscribed cylinder, whose axis is perpendicular to the bounding planes.

(2) If the ellipse

$$\frac{x^2}{a^2} + \frac{y^2}{b^2} = 1$$

revolve round the axis of  $x$ , we have

$$ds = \left( 1 + \frac{b^4 x^2}{a^4 y^2} \right)^{1/2} dx;$$

$$\therefore y ds = \frac{b}{a} (a^2 - e^2 x^2)^{1/2} dx,$$

where  $e$  is the eccentricity of the ellipse.

Hence, the whole surface of this ellipsoid is

$$4\pi \frac{b}{a} \int_0^a (a^2 - e^2 x^2)^{1/2} dx = 2\pi b^2 + 2\pi \frac{ab}{c} \sin^{-1} e.$$

In like manner, if  $S$  be the surface generated by the revolution of the ellipse round its axis minor, we get

$$S = 2\pi \int x ds = 2\pi \frac{a}{b^2} \int (b^4 + a^2 e^2 y^2)^{1/2} dy.$$

Consequently its entire surface is represented by

$$2\pi a^2 + \pi \frac{b^3}{e} \log \left( \frac{1+e}{1-e} \right).$$

180. In connexion with surfaces of revolution, the following general propositions, usually called Guldin's theorems, may be here stated.

(1) If a plane curve revolve round any external axis situated in its plane, the area of the surface generated in a complete revolution

equals the product of the length of the generating curve into the path described by its centre of gravity.

(2) In like manner, the volume of the solid generated is equal to the product of the generating area into the path described by the centre of gravity of the area.

The former of these theorems is easily shown; for if  $y_1$  be the distance of the centre of gravity of the curve from the axis of revolution, taken as that of  $x$ , we have

$$y_1 s = \int y ds; \quad \therefore 2\pi y_1 s = 2\pi \int y ds = S$$

which proves the theorem.

Next, if  $y_2$  be the ordinate of the centre of gravity of the area  $A$ , we have

$$Ay_2 = \iint y dA = \iint y dx dy = \frac{1}{2} \int y^2 dx, \quad \therefore 2\pi y_2 A = \pi \int y^2 dx$$

whence the latter theorem follows.

181. In the general case of the determination of the quadrature of a surface we regard it as the limit of a number of indefinitely small elements, each of which is considered a portion of a plane that is ultimately a tangent plane to the surface. Now let  $dS$  denote such an element at any point of the surface, and  $d\sigma$  its projection on a fixed plane, which makes the angle  $\theta$  with the tangent plane at the point, then we have

$$d\sigma = dS \cos \theta, \text{ or } dS = \sec \theta d\sigma.$$

Hence 
$$S = \int \sec \theta d\sigma,$$

taken between proper limits.

If now the surface be referred to a rectangular system of coordinate axes, we may take  $d\sigma = dx dy$ ; also, from an elementary theorem in surfaces,

$$\sec \theta = \sqrt{1+p^2+q^2}, \text{ where } p = \frac{dz}{dx}, \quad q = \frac{dz}{dy}$$

Hence we have

$$S = \iint (1+p^2+q^2)^{\frac{1}{2}} dx dy,$$

in which the values of  $p$  and  $q$  are to be determined from the equation of the surface.

(1) For example, let it be proposed to find the portion of the surface of a sphere intercepted by a cone of the second order, whose vertex is on the surface of the sphere, and whose internal axis passes through the centre of the sphere.

Let  $O$  the vertex of the cone be taken as the origin (fig. 12), and the line joining it to the centre of the sphere as axis of  $z$ , then the equation of the sphere may be written

$$x^2 + y^2 + z^2 = 2az.$$

Hence

$$p = \frac{dz}{dx} = \frac{x}{a-z}, \quad q = \frac{dz}{dy} = \frac{y}{a-z},$$

$$\therefore \sqrt{1+p^2+q^2} = \frac{a}{a-z};$$

consequently 
$$S = a \iint \frac{dx dy}{\sqrt{a^2 - x^2 - y^2}},$$

in which the limits are determined from the equation of the bounding cone. Let the equation of this cone be

$$z^2 = A^2 x^2 + B^2 y^2;$$

then, eliminating  $z$ , the limiting values of  $x$  and  $y$  are connected by the equation

$$(1+A^2)x^2 + (1+B^2)y^2 = 2a\sqrt{A^2x^2+B^2y^2}.$$

Next, transform to polar coordinates by making

$$x = r \cos \theta, \quad y = r \sin \theta,$$

and we get

$$S = a \iint \frac{r dr d\theta}{\sqrt{a^2 - r^2}},$$

taken for all points within the curve

$$r \{ (1+A^2) \cos^2 \theta + (1+B^2) \sin^2 \theta \} = 2a \sqrt{A^2 \cos^2 \theta + B^2 \sin^2 \theta}.$$

Hence, since the curve is symmetrical, we get

$$S = 4a \int_0^{\frac{\pi}{2}} \int_0^R \frac{r dr d\theta}{\sqrt{a^2 - r^2}},$$

where

$$R = \frac{2a \sqrt{A^2 \cos^2 \theta + B^2 \sin^2 \theta}}{1 + A^2 \cos^2 \theta + B^2 \sin^2 \theta}$$

Again 
$$\int_0^R \frac{r dr}{\sqrt{a^2 - r^2}} = a - \sqrt{a^2 - R^2} = \frac{2a}{1 + A^2 \cos^2 \theta + B^2 \sin^2 \theta},$$

$$\therefore S = 8a^2 \int_0^{\frac{\pi}{2}} \frac{d\theta}{(1+A^2) \cos^2 \theta + (1+B^2) \sin^2 \theta} = \frac{4\pi a^2}{\sqrt{(1+A^2)(1+B^2)}}$$

This result admits of a simple geometrical representation; for let  $D, E$  (fig. 12) be the points in which the edges of the cone lying in the planes  $y=0$  and  $x=0$  cut the surface of the sphere, and we plainly have

$$CD = \frac{2a}{\sqrt{1+A^2}}, \quad CE = \frac{2a}{\sqrt{1+B^2}}$$

Consequently the area of the intercepted portion of the sphere is equal to that of the ellipse which has  $CD$  and  $CE$  as its semi-axes.

(2) If, instead of the cone, we had taken the paraboloid

$$z = Ax^2 + By^2,$$

the area of the portion intercepted on the sphere is given, as in the preceding, by the equation

$$S = 4a \int_0^{\frac{\pi}{2}} (a - \sqrt{a^2 - R^2}) d\theta,$$

where, from the equation of the bounding curve, we have

$$R^2 = \frac{2a(A \cos^2 \theta + B \sin^2 \theta) - 1}{(A \cos^2 \theta + B \sin^2 \theta)^2}$$

Hence 
$$S = 4a \int_0^{\frac{\pi}{2}} \frac{d\theta}{A \cos^2 \theta + B \sin^2 \theta} = \frac{2\pi a}{\sqrt{AB}}$$

This result admits of a geometrical interpretation similar to that in example (1).

*Multiple Integrals.*

182. The general form of a multiple integral may be represented by the expression

$$\int_{x_0}^X dx \int_{y_0}^Y dy \dots \int_{u_0}^U du \dots \int_{t_0}^T dt f(x, y, \dots, u, t),$$

in which  $f(x, y, \dots, u, t)$  is supposed continuous for all systems of values of the independent variables  $x, y, \dots, u, t$  included within the limits. Moreover the limits of each variable must be independent of the following variables, but may depend on the preceding variables.

In calculating the integral, the expression  $f(x, y, \dots, u, t) dt$  is integrated between the limits  $T$  and  $t_0$ , regarding  $x, y, \dots, u$  as constants. Thus we obtain a function of  $x, y, \dots, u$ . This function is integrated with respect to  $u$  between the limits  $U$  and  $u_0$ , treating  $x, y, \dots$  as constant. We thus obtain a function of  $x, y, \dots$  independent of  $u, t$ ; and so on for the subsequent integrations.

If the limits for each variable be constant, the integrations may be taken in any order, subject to such limitations as those given in § 148 for two variables. In the more general case, when the order of integration is altered it is necessary to determine, from the conditions of the problem, the new limiting values. This is usually a matter of much difficulty.

183. Continuing from § 178, the general problem of the transformation of a multiple integral by a change of variables may be stated as follows.

Suppose the multiple integral represented by

$$\iint \dots \int \phi(x_1, x_2, \dots, x_n) dx_1 dx_2 \dots dx_n,$$

and it be proposed to transform it into another, depending on new variables  $u_1, u_2, \dots, u_n$ , which are related with the original variables by a system of  $n$  given equations. This transformation implies three parts in general:—(1) the determination of  $\phi(x_1, x_2, \dots, x_n)$  in terms of  $u_1, u_2, \dots, u_n$ ; (2) the determination of the new system of limits; (3) the finding the substitution for  $dx_1 dx_2 \dots dx_n$ .

The solution of the first two questions is an algebraical problem, of which we have already considered one or two elementary cases. We now address ourselves to the third question, and write the integral in the form

$$\int dx_1 \int dx_2 \dots \int dx_{n-1} \int dx_n \phi(x_1, x_2, \dots).$$

In the integration with respect to  $x_n$ , as stated in § 182,  $x_1, x_2, \dots, x_{n-1}$  are regarded as constants. Accordingly, in order to replace  $x_n$  by  $u_n$ , it is sufficient to express  $x_n$  in terms of  $u_n, x_1, x_2, \dots, x_{n-1}$ , and then to substitute  $\frac{dx_n}{du_n} du_n$  for  $dx_n$ . Again, to transform the next integration, relative to  $dx_{n-1}$ , we suppose  $x_{n-1}$  expressed in terms of  $u_{n-1}, u_n, x_1, x_2, \dots, x_{n-2}$ , and we replace  $dx_{n-1}$  by  $\frac{dx_{n-1}}{du_{n-1}} du_{n-1}$ . By continuing this process the integral finally becomes of the form

$$\iiint \dots \int \phi_1 \frac{dx_n}{du_n} \frac{dx_{n-1}}{du_{n-1}} \dots \frac{dx_1}{du_1} du_1 du_2 \dots du_n,$$

where  $\phi_1$  represents the value of  $\phi(x_1, x_2, \dots, x_n)$  when transformed into a function of  $u_1, u_2, \dots, u_n$ .

Moreover, by § 102, the product

$$\frac{dx_n}{du_n} \frac{dx_{n-1}}{du_{n-1}} \dots \frac{dx_1}{du_1}$$

is, in this case, the Jacobian of the original system of variables  $x_1, x_2, \dots, x_n$  regarded as functions of the new variables.

Accordingly, for  $dx_1 dx_2 \dots dx_n$  we substitute

$$\begin{vmatrix} \frac{dx_1}{du_1} & \frac{dx_1}{du_2} & \dots & \frac{dx_1}{du_n} \\ \frac{dx_2}{du_1} & \frac{dx_2}{du_2} & \dots & \frac{dx_2}{du_n} \\ \dots & \dots & \dots & \dots \\ \frac{dx_n}{du_1} & \frac{dx_n}{du_2} & \dots & \frac{dx_n}{du_n} \end{vmatrix} du_1 du_2 \dots du_n.$$

For instance, if  $\iiint V dx dy$  be transformed to new variables  $u, v$ , denoting by  $V_1$  the value which  $V$  assumes, the double integral becomes

$$\iint V_1 (x' u y' v - y' u x' v) dx dy,$$

where

$$x' u = \frac{dx}{du}, y' u = \frac{dy}{du}, x' v = \frac{dx}{dv}, y' v = \frac{dy}{dv}.$$

Again, if the coordinates of each point on a surface be given in terms of two independent variables  $u, v$ , to find the transformed expression for the superficial area

$$\iint \sqrt{1 + \left(\frac{dz}{dx}\right)^2 + \left(\frac{dz}{dy}\right)^2} dx dy.$$

Here  $dx dy$  becomes  $(x' u y' v - y' u x' v) du dv$  as before.

Also, since, from the equation to the surface,  $z$  may be regarded as a function of  $x$  and  $y$ , we have

$$z' u = x' u \frac{dz}{dx} + y' u \frac{dz}{dy}, z' v = x' v \frac{dz}{dx} + y' v \frac{dz}{dy};$$

$$\frac{dz}{dx} = \frac{z' u y' v - y' u z' v}{x' u y' v - y' u x' v}, \frac{dz}{dy} = \frac{x' u z' v - z' u x' v}{x' u y' v - y' u x' v}.$$

Accordingly the transformed expression is

$$\iint \{ (x' u y' v - y' u x' v)^2 + (y' u z' v - z' u y' v)^2 + (x' v z' u - z' v x' u)^2 \}^{1/2} du dv.$$

For example, the coordinates of any point on the ellipsoid

$$\frac{x^2}{a^2} + \frac{y^2}{b^2} + \frac{z^2}{c^2} = 1$$

may be represented by the equations

$$x = a \sin \theta \cos \phi, y = b \sin \theta \sin \phi, z = c \cos \theta;$$

hence it can be shown that its total surface  $S$  is represented by

$$S = abc \int_0^\pi \int_0^{2\pi} \sin \theta d\theta d\phi \left\{ \frac{\cos^2 \theta}{c^2} + \frac{\sin^2 \theta \sin^2 \phi}{b^2} + \frac{\sin^2 \theta \cos^2 \phi}{a^2} \right\}^{1/2};$$

in which the integration with respect to  $\theta$  can be immediately effected.

Again, the coordinates of any point on a sphere of radius  $a$  can be represented by the equations

$$x = a \sin \theta \sqrt{1 - k^2 \sin^2 \phi}, y = a \sin \theta \sqrt{1 - k'^2 \sin^2 \theta}, z = a \cos \theta \cos \phi, \text{ where } k^2 + k'^2 = 1.$$

This is obvious, since the sum of the squares of these expressions is  $a^2$ .

Accordingly

$$x' \theta y' \phi - y' \theta x' \phi = -\frac{a^2 \cos \theta \cos \phi (k^2 \cos^2 \phi + k'^2 \cos^2 \theta)}{\sqrt{1 - k^2 \sin^2 \phi} \sqrt{1 - k'^2 \sin^2 \theta}},$$

$$y' \theta z' \phi - z' \theta y' \phi = \frac{a^2 \sin \theta (k^2 \cos^2 \phi + k'^2 \cos^2 \theta)}{\sqrt{1 - k^2 \sin^2 \phi}},$$

$$z' \theta x' \phi - x' \theta z' \phi = \frac{a^2 \sin \theta \phi (k^2 \cos^2 \phi + k'^2 \cos^2 \theta)}{\sqrt{1 - k^2 \sin^2 \phi}}$$

Hence we get

$$dS = \frac{a^2 (k^2 \cos^2 \phi + k'^2 \cos^2 \theta)}{\sqrt{1 - k^2 \sin^2 \phi} \sqrt{1 - k'^2 \sin^2 \theta}} d\theta d\phi.$$

Consequently, since the entire surface of the sphere is  $4\pi a^2$ , we have

$$\int_0^\pi \int_0^{2\pi} \frac{(k^2 \cos^2 \phi + k'^2 \cos^2 \theta) d\theta d\phi}{\sqrt{1 - k^2 \sin^2 \phi} \sqrt{1 - k'^2 \sin^2 \theta}} = \pi.$$

The well-known general formula of Legendre, connecting complete elliptic functions of the first and second species, follows at once from this last result.

184. In the case of three variables, adopting a similar notation, the integral

$$\iiint V dx dy dz$$

transforms into

$$\iiint V_1 \{ x' u y' v - y' u x' v \} + y' u \{ z' u x' v - x' u z' v \} + x' u \{ y' u z' v - z' u y' v \} du dv dw.$$

For example, in the general transformation from rectangular to polar coordinates we find, as already observed, that  $r^2 \sin \theta dr d\theta d\phi$  is to be substituted for the element of volume  $dx dy dz$ . This is but a particular case of the general transformation given in § 103.

The preceding formula of transformation for three variables was given by Euler in 1769, and afterwards generalized by Lagrange in 1773. Jacobi appears, however, to have been the first to have established the general transformation, in his memoir referred to in § 96. The method of proof here adopted is that given by Bertrand.

Ex. 1. In the case of linear transformations, viz., when

$$x_1 = a_1 u_1 + a_2 u_2 + \dots + a_n u_n, \\ x_2 = b_1 u_1 + b_2 u_2 + \dots + b_n u_n, \\ \dots \\ x_n = l_1 u_1 + l_2 u_2 + \dots + l_n u_n,$$

we get

$$dx_1 dx_2 \dots dx_n = \Delta du_1 du_2 \dots du_n.$$

where

$$\Delta = \begin{vmatrix} a_1 & a_2 & \dots & a_n \\ b_1 & b_2 & \dots & b_n \\ \dots & \dots & \dots & \dots \\ l_1 & l_2 & \dots & l_n \end{vmatrix}.$$

Ex. 2. If

$$x_1 = \frac{u_1 u_2}{u_1}, x_2 = \frac{u_1 u_3}{u_2}, x_3 = \frac{u_1 u_3}{u_2},$$

the Jacobian is

$$\begin{vmatrix} -\frac{u_2 u_3}{u_1^2} & \frac{u_3}{u_1} & \frac{u_2}{u_1} \\ \frac{u_3}{u_2} & -\frac{u_1 u_3}{u_2^2} & \frac{u_1}{u_2} \\ \frac{u_2}{u_3} & \frac{u_1}{u_3} & -\frac{u_1 u_2}{u_3^2} \end{vmatrix}.$$

The value of this determinant is easily seen to be 4; hence

$$\iiint V dx_1 dx_2 dx_3 \text{ transforms into } 4 \iiint V_1 du_1 du_2 du_3.$$

Ex. 3. As an additional example we shall take Jacobi's method of establishing the fundamental formula of Eulerian integrals (§ 153). Since

$$\Gamma(l) = \int_0^\infty e^{-x} x^{l-1} dx, \Gamma(m) = \int_0^\infty e^{-y} y^{m-1} dy$$

we have

$$\Gamma(l)\Gamma(m) = \int_0^\infty \int_0^\infty e^{-x-y} x^{l-1} y^{m-1} dx dy.$$

If now we transform by making  $x = uv, y = u(1-v)$ , the limits for  $u$  are 0 and  $\infty$ , and those for  $v$  are 0 and 1;

$$\frac{dx}{dv} \frac{dy}{du} - \frac{dx}{du} \frac{dy}{dv} = u;$$

$$\text{hence } \Gamma(l)\Gamma(m) = \int_0^\infty \int_0^1 e^{-u} u^{l+m-1} v^{l-1} (1-v)^{m-1} du dv$$

$$= \Gamma(l+m) \int_0^1 v^{l-1} (1-v)^{m-1} dv,$$

$$\therefore \int_0^1 v^{l-1} (1-v)^{m-1} dv = \frac{\Gamma(l)\Gamma(m)}{\Gamma(l+m)}.$$

185. In the more general case, where  $x_1, x_2, \dots, x_n$  are not given explicitly in terms of  $u_1, u_2, \dots, u_n$ , but are connected with them by  $n$  equations of the form

$$F_1(x_1, x_2, \dots, x_n, u_1, u_2, \dots, u_n) = 0, F_2(x_1, x_2, \dots, x_n, u_1, u_2, \dots, u_n) = 0,$$

$$F_{n-1}(x_1, x_2, \dots, x_n, u_1, u_2, \dots, u_n) = 0, F_n(x_1, x_2, \dots, x_n, u_1, u_2, \dots, u_n) = 0,$$

we get, by § 99,

$$\begin{vmatrix} \frac{dx_1}{du_1} & \frac{dx_1}{du_2} & \dots & \frac{dx_1}{du_n} \\ \frac{dx_2}{du_1} & \frac{dx_2}{du_2} & \dots & \frac{dx_2}{du_n} \\ \dots & \dots & \dots & \dots \\ \frac{dx_n}{du_1} & \frac{dx_n}{du_2} & \dots & \frac{dx_n}{du_n} \end{vmatrix} = \frac{\Delta_1}{\Delta_0}.$$



where

$$\Delta_1 = \begin{vmatrix} \frac{dF_1}{du_1} & \frac{dF_1}{du_2} & \dots & \frac{dF_1}{du_n} \\ \frac{dF_2}{du_1} & \frac{dF_2}{du_2} & \dots & \frac{dF_2}{du_n} \\ \dots & \dots & \dots & \dots \\ \frac{dF_n}{du_1} & \frac{dF_n}{du_2} & \dots & \frac{dF_n}{du_n} \end{vmatrix}, \Delta_2 = \begin{vmatrix} \frac{dF_1}{dx_1} & \frac{dF_1}{dx_2} & \dots & \frac{dF_1}{dx_n} \\ \frac{dF_2}{dx_1} & \frac{dF_2}{dx_2} & \dots & \frac{dF_2}{dx_n} \\ \dots & \dots & \dots & \dots \\ \frac{dF_n}{dx_1} & \frac{dF_n}{dx_2} & \dots & \frac{dF_n}{dx_n} \end{vmatrix}.$$

Accordingly the multiple integral

$$\iiint \dots \int \sqrt{d\omega_1 d\omega_2 \dots d\omega_n}$$

transforms into

$$\iiint \dots \int \sqrt{V_1 \Delta_1 du_1 du_2 \dots du_n}.$$

The limits in the transformed integral are determined by aid of the equations which give the limits in the original.

186. We conclude this short account of multiple integrals with a notice of the very general and remarkable theorems relative to integrals extended through a closed surface first given by Green (*Essay on the Application of Mathematics to Electricity and Magnetism*, Nottingham, 1828).

Let  $U, V$  denote two functions of the rectangular coordinates  $x, y, z$  which are finite, and have their first differential coefficients finite, for all points within a closed surface; then, since

$$\frac{d}{dx} \left( U \frac{dV}{dx} \right) = \frac{dU}{dx} \frac{dV}{dx} + U \frac{d^2V}{dx^2},$$

we have

$$\iiint \frac{d}{dx} \left( U \frac{dV}{dx} \right) dx dy dz = \iiint \frac{dU}{dx} \frac{dV}{dx} dx dy dz + \iiint U \frac{d^2V}{dx^2} dx dy dz,$$

the integrals being extended to all points within the surface.

Also, since the bounding surface is closed, any right line which meets the bounding surface, must cut it in an even number of points; hence the integral

$$\iiint \frac{d}{dx} \left( U \frac{dV}{dx} \right) dx dy dz = \iint dy dz \Sigma \left( U_2 \frac{dV_2}{dx_2} - U_1 \frac{dV_1}{dx_1} \right)$$

where  $x_2, x_1, U_2, U_1$ , &c., are the values of  $x$ , &c., for two corresponding points of intersection with the boundary by the infinitely thin cylinder standing on  $dy dz$ , and by  $\Sigma$  is denoted the summation taken for all such values. Again, if  $dS_2, dS_1$  be the corresponding elements of surface, and  $\alpha_2, \alpha_1$  the angles which the exterior normal to the surface at each of these points makes with the positive direction of the axis of  $x$ , we have

$$dy dz = \cos \alpha_2 dS_2 = -\cos \alpha_1 dS_1;$$

hence it is readily seen that the integral

$$\iint dy dz \Sigma \left( U_2 \frac{dV_2}{dx_2} - U_1 \frac{dV_1}{dx_1} \right)$$

is equal to

$$\iint U \frac{dV}{dx} \cos \alpha dS,$$

taken for every element of the boundary, whether it consist of one closed surface or of several.

Accordingly, we get

$$\iiint U \frac{d^2V}{dx^2} dx dy dz + \iint \frac{dU}{dx} \frac{dV}{dx} dx dy dz = \iint U \frac{dV}{dx} \cos \alpha dS,$$

in which the former integrals are taken for every point within any space, and the latter integral taken for each point on the boundary of that space. This may be written

$$\iiint \frac{dU}{dx} \frac{dV}{dx} dx dy dz = \iint U \frac{dV}{dx} \cos \alpha dS - \iiint U \frac{d^2V}{dx^2} dx dy dz.$$

Taking the corresponding equations relative to  $y$  and  $z$ , we have by addition,

$$\begin{aligned} & \iiint \left( \frac{dU}{dx} \frac{dV}{dx} + \frac{dU}{dy} \frac{dV}{dy} + \frac{dU}{dz} \frac{dV}{dz} \right) dx dy dz \\ &= \iint U \left( \frac{dV}{dx} \cos \alpha + \frac{dV}{dy} \cos \beta + \frac{dV}{dz} \cos \gamma \right) dS \\ & \quad - \iiint U \left( \frac{d^2V}{dx^2} + \frac{d^2V}{dy^2} + \frac{d^2V}{dz^2} \right) dx dy dz. \end{aligned}$$

Again, if  $d\omega$  be the element of the normal, measured outwards, at the element  $dS$  we readily get

$$\cos \alpha = \frac{dx}{d\omega}, \quad \cos \beta = \frac{dy}{d\omega}, \quad \cos \gamma = \frac{dz}{d\omega};$$

$$\therefore \frac{dV}{dx} \cos \alpha + \frac{dV}{dy} \cos \beta + \frac{dV}{dz} \cos \gamma = \frac{dV}{d\omega}$$

Hence

$$\begin{aligned} & \iiint \left( \frac{dU}{dx} \frac{dV}{dx} + \frac{dU}{dy} \frac{dV}{dy} + \frac{dU}{dz} \frac{dV}{dz} \right) dx dy dz \\ &= \iint U \frac{dV}{d\omega} dS - \iiint U \left( \frac{d^2V}{dx^2} + \frac{d^2V}{dy^2} + \frac{d^2V}{dz^2} \right) dx dy dz \\ &= \iint V \frac{dU}{d\omega} dS - \iiint V \left( \frac{d^2U}{dx^2} + \frac{d^2U}{dy^2} + \frac{d^2U}{dz^2} \right) dx dy dz. \end{aligned}$$

The latter equation is obtained by an interchange of  $U$  and  $V$ .

This is Green's fundamental theorem, in the case where  $U$  and  $V$  are continuous functions.

187. The modification when one of the functions,  $U$  for example, becomes infinite for a point within the surface was also investigated by Green. Suppose this to happen at one point,  $P$ , only; moreover, infinitely near to  $P$  let  $U$  be sensibly  $= \frac{1}{r}$ ,  $r$  being the distance from  $P$ .

Next suppose an indefinitely small sphere, of radius  $a$ , described with  $P$  as centre. Then it is clear that Green's equation holds for all the space exterior to this sphere. Also, since

$$\left( \frac{\partial^2}{\partial x^2} + \frac{\partial^2}{\partial y^2} + \frac{\partial^2}{\partial z^2} \right) \frac{1}{r} = 0,$$

the triple integrals may be extended throughout the entire space.

Moreover, the part of  $\iint U \frac{dV}{d\omega} dS$  due to the surface of the sphere is plainly infinitely small of the order of  $a$ . It only remains to consider the value of  $\iint V \frac{dU}{d\omega} dS$  taken over the surface of the sphere.

But, since  $\frac{dU}{d\omega} = -\frac{1}{a^2}$ , this becomes  $-4\pi V_1$ , where  $V_1$  is the value of  $V$  at the point  $P$ .

Hence, denoting

$$\frac{\partial^2}{\partial x^2} + \frac{\partial^2}{\partial y^2} + \frac{\partial^2}{\partial z^2} \text{ by } \nabla_2,$$

we have

$$\begin{aligned} & \iiint dx dy dz U \nabla_2 V - \iint U \frac{dV}{d\omega} dS \\ &= \iiint dx dy dz V \nabla_2 U - \iint V \frac{dU}{d\omega} dS + 4\pi V_1, \end{aligned}$$

where, as before, the double integrals are extended over the bounding surface or surfaces, and the triple integrals taken throughout the entire space enclosed.

These theorems of Green have been generalized by Sir W. Thomson; thus, if  $\alpha$  be another continuous function of  $x, y, z$ , we get, by a similar treatment, instead of Green's first equations,

$$\begin{aligned} & \iiint \alpha^2 \left( \frac{dU}{dx} \frac{dV}{dx} + \frac{dU}{dy} \frac{dV}{dy} + \frac{dU}{dz} \frac{dV}{dz} \right) dx dy dz \\ &= \iint \alpha^2 V \frac{dU}{d\omega} dS - \iiint V \left\{ \frac{d}{dx} \left( \alpha^2 \frac{dU}{dx} \right) + \frac{d}{dy} \left( \alpha^2 \frac{dU}{dy} \right) \right. \\ & \quad \left. + \frac{d}{dz} \left( \alpha^2 \frac{dU}{dz} \right) \right\} dx dy dz \\ &= \iint \alpha^2 U \frac{dV}{d\omega} dS - \iiint U \left\{ \frac{d}{dx} \left( \alpha^2 \frac{dV}{dx} \right) + \frac{d}{dy} \left( \alpha^2 \frac{dV}{dy} \right) \right. \\ & \quad \left. + \frac{d}{dz} \left( \alpha^2 \frac{dV}{dz} \right) \right\} dx dy dz, \end{aligned}$$

with a corresponding modification when one of the functions becomes infinite at one or more interior points.

In the case of many-valued functions, another modification of Green's theorem was established by Helmholtz (*Ueber Integrale der Hydrodynamischen Gleichungen welche den Wirbelbewegungen entsprechen*, *Crelle*, 1858).

*Elliptic Integrals.*

188. Attention has hitherto been restricted to integrations of rational algebraic functions, of logarithmic or circular functions, or of such functions as could be transformed to depend on these; or, if irrationalities were introduced, they were such as involved the variable under the radical in no higher than the second degree. But the founders of the infinitesimal calculus early perceived that many integrals did not admit of expression by means of these elementary functions with which they were familiar. Apparently it was the geometrical interest attached to such integrations which first attracted notice. Thus James Bernoulli published, in the *Acta Eruditorum* for 1691, a paper on the helicoidal parabola, in which we meet with the idea of comparing arcs of one and the same curve, which cannot be superposed.

This spiral is the locus of the extremities of the ordinates of a parabola when its axis is rolled as a tangent to a fixed circle, the ordinates being measured towards the centre. The polar

equation of the locus is  $(\alpha - r)^2 = 2ar\omega$  (see fig. 13). Hence the arc  $ds = dr \sqrt{1 + \frac{r^2(\alpha - r)^2}{a^2\omega^2}}$ ; so that, if  $s_1$  be the arc contained be-

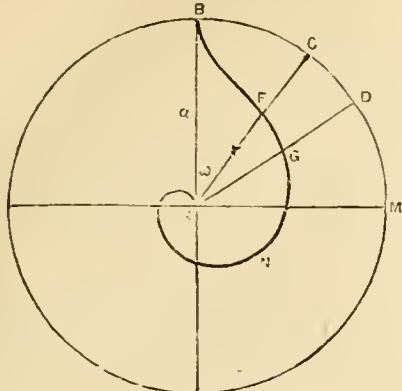

Fig. 13.

tween the values  $\frac{1}{2}a$  and  $\frac{1}{2}a + c$  ( $=AG$ ) of  $r$ , and  $s_2$  the arc between the values  $\frac{1}{2}a - c$  ( $=AN$ ) and  $\frac{1}{2}a$ , we have

$$s_1 = \int_{\frac{1}{2}a}^{\frac{1}{2}a+c} \sqrt{1 + \frac{r^2(\alpha - r)^2}{a^2\omega^2}} dr, \quad s_2 = \int_{\frac{1}{2}a-c}^{\frac{1}{2}a} \sqrt{1 + \frac{r^2(\alpha - r)^2}{a^2\omega^2}} dr.$$

Now, putting in the former  $r = \frac{1}{2}a + z$  and in the latter  $r = \frac{1}{2}a - z$ , we find

$$s_1 = s_2 = \int_0^c \sqrt{1 + \frac{1}{a^2\omega^2} \left( z^2 - \frac{a^2}{4} \right)^2} dz;$$

whence we conclude, as Bernoulli did, that even in curves whose rectification has not yet been effected, parts may be assigned which are equal though dissimilar; such as  $BG = AN$ , and  $GI = NI$ , where  $AI = \frac{1}{2}a$ .

John Bernoulli, following up this discovery of his brother, proposed to find for a given curve another, such that the sum or the difference of two arcs, one on each curve, may be expressed by arcs of circles. In the case of the cubical parabola he noticed that the two curves reduce to one curve, in which, without effecting the rectification, pairs of arcs could be found whose difference is rectifiable.

189. The Count Fagnani next proposed in 1714 the problem, "given a portion of the parabola whose equation is  $x^3 = y$ , to find another portion of it such that the difference of these two parts may be rectifiable." In the following year, not having received a solution, Fagnani published his own, with greater generality, as follows.

Taking  $a$  constant, and  $m$  any real number, let  $y = \frac{2}{m+2} \frac{x^{\frac{m+2}{2}}}{\frac{x}{a}}$  be

the equation of a parabolic curve (compare Ex 2, § 166). Let  $l$  be the portion of the tangent between any point  $(x, y)$  of the curve and the axis of abscissa.

Then by the equation of the curve,

$$l = \frac{2x}{m+2} \sqrt{1 + \left(\frac{x}{a}\right)^m}$$

and the arc of the curve

$$s = \int \sqrt{1 + \left(\frac{x}{a}\right)^m} dx$$

Integration by parts gives (see fig. 14)

$$\frac{m}{m+2} \int_{x_0}^{x_1} \frac{dx}{\sqrt{1 + \left(\frac{x}{a}\right)^m}} = \text{arc } PP_1 - (P_1R_1 - PR),$$

if  $P, P_1$  have the abscissae  $x_0, x_1$ ; also

$$\frac{m}{m+2} \int_{x_0}^{x_1} \frac{dz}{\sqrt{1 + \left(\frac{z}{a}\right)^m}} = \text{arc } QQ_1 - (Q_1S_1 - QS),$$

if  $Q, Q_1$  have  $z_0, z_1$  as abscissae.

Now if the former integral can be transformed by introducing a variable  $z$  so that the function under the sign of integration may remain unaltered, and thus the former integral may pass into the latter, we may equate  $\text{arc } PP_1 - (P_1R_1 - PR) = \text{arc } QQ_1 - (Q_1S_1 - QS)$ .

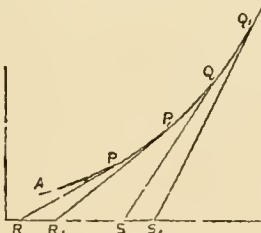

Fig. 14.

Thus the question is to determine an integral of the differential equation

$$\frac{dx}{\sqrt{1 + \left(\frac{x}{a}\right)^m}} = \frac{dz}{\sqrt{1 + \left(\frac{z}{a}\right)^m}},$$

or of

$$\frac{dx}{\sqrt{1 + \left(\frac{x}{a}\right)^m}} + \frac{dz}{\sqrt{1 + \left(\frac{z}{a}\right)^m}} = 0.$$

Fagnani gave the following solutions. For  $m=4$  the curve is the cubical parabola, and the relation between  $x$  and  $z$  is  $xz = a^2$ . For  $m=3$  the equation is satisfied by the relation

$$\left(1 + \frac{x}{a}\right) \left(1 + \frac{z}{a}\right) = 3.$$

For  $m=6$  the curve is as in the problem proposed, and the relation is

$$\left(\frac{x}{a}\right)^3 \left\{ 2 \left(\frac{z}{a}\right)^2 - 1 \right\} = \left(\frac{z}{a}\right)^2 - 1.$$

190. Passing over Fagnani's investigations relative to the lemniscate,—such as his discoveries of the method of doubling or halving any arc, of dividing the quadrant into equal parts in number  $2 \cdot 2^m$ ,  $3 \cdot 2^m$ , or  $5 \cdot 2^m$ , discoveries which prompted to their author the wish, since executed, that on his tomb a lemniscate should be inscribed *in memoriam*,—we must mention his well-known geometrical theorem, that on the circumference of an ellipse, in innumerable ways, pairs of arcs can be determined having their difference expressible by a right line (first published 1716). His method is as follows. If we have  $h, l, f, g$  constants, and  $(fhx^2 - 2) + (flz^2) + (fz^2)^2 + (gl)^2 = 0$ , then, first, the sum

$$\int \frac{dx \sqrt{hx^2 + l}}{\sqrt{fx^2 + g}} + \int \frac{dz \sqrt{hx^2 + l}}{\sqrt{fz^2 + g}} = a - \frac{hxz}{\sqrt{-fl}} \text{ if } s = +1. \quad (1);$$

and, secondly, the same sum  $= a + \frac{xz\sqrt{-h}}{\sqrt{g}}$  when  $s = -1$ .

In the former case the relation gives

$$z = \frac{\sqrt{-flx^2 - gl}}{\sqrt{fhx^2 + fl}}$$

Introducing this into the first integral, and the corresponding value of  $x$  into the second, the sum of the integrals becomes

$$\int \frac{dx \sqrt{-l}}{x \sqrt{f}} + \int \frac{dz \sqrt{-l}}{x \sqrt{f}}$$

But differentiating the relation, and dividing by  $2fxz$ , we find

$$hxdx + hxdz + l \frac{dx}{z} + l \frac{dz}{x} = 0;$$

whence, substituting, the sum is found to be as stated. A like treatment yields the formula when  $s = -1$ . This theorem is applied in its former part to elliptic arcs. Let us call the axis major  $2a$ , the parameter  $p$ , and the abscissa  $x$ ; then, if  $h = p - 2a$ , the element of the arc  $AB$  (fig. 15) corresponding to the abscissa  $CD = x$  can be shown to be

$$\frac{dx \sqrt{hx^2 + 2ax}}{\sqrt{2a^3 - 2ax^2}}$$

If now  $l = 2a^3, f = -2a$ , and  $g = 2a^3$ , this becomes the former differential in (1); and it appears that, taking another abscissa

$$CE = z = \frac{a\sqrt{2a^3 - 2ax^2}}{\sqrt{hx^2 + 2ax}},$$

we have

$$\text{arc } AB + \text{arc } AF = -\frac{hxz}{2a^2} + K.$$

To determine the value of the constant  $K$ , let  $x=0$ ; then  $AF$  becomes the entire arc  $AG$ , hence

$$\text{arc } AB - \text{arc } GF = -\frac{hxz}{2a^2}$$

The second part of the theorem is applied to the hyperbola (fig. 16). Calling  $HA = 2a$ , the parameter  $p$ , and  $x$  the variable abscissa  $CD$ , and putting  $h = p + 2a$ , the element of the arc  $AB$  is easily found to be expressed by

$$\frac{dx \sqrt{hx^2 - 2a^3}}{\sqrt{2ax^2 - 2a^3}};$$

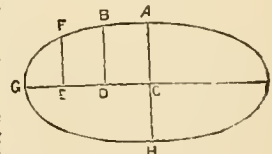

Fig. 15.

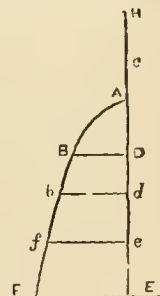

Fig. 16.







essentially as follows, has much analogy with Fagnani's, given in § 190.

Let the equation

$$(ax^2 + 2a'x + a'')y^2 + 2(bx^2 + 2b'x + b'')y + cx^2 + 2c'x + c'' = Ly^2 + 2My + N = 0 \dots (1),$$

or  $(ay^2 + 2by + c)x^2 + 2(a'y^2 + 2b'y + c'')x + a''y^2 + 2b''y + c'' = Px^2 + 2Qx + R = 0 \dots (2),$

substit between  $x$  and  $y$ . Differentiating either, we get  $(Px + Q)dx + (Ly + M)dy = 0 \dots (3).$

Further, by (1, 2)  $(Px + Q)^2 = Q^2 - PR, (Ly + M)^2 = M^2 - LN, \dots (4);$

taking the roots positive, (3) becomes  $\frac{dx}{\sqrt{M^2 - LN}} + \frac{dy}{\sqrt{Q^2 - PR}} = 0 \dots (5),$

in which the radicals are respectively functions of  $x$  and of  $y$  expressible from (1) and (2).

If the functions under the radicals are to be severally the same functions of  $x$  and  $y$ , the following conditions result:—

$$b^2 - ac = a'^2 - aa'', \quad 2bb' - ac' - a''c = 2a'b' - ab'' - a''b, \\ bb'' = a'c', \quad 2b'b'' - a'c'' - a''c' = 2b'c' - bc'' - b'c', \quad b''^2 - a''c'' = c'^2 - c'c''.$$

The values of  $c$  and  $c'$  being substituted from the first and third equations, in the second we get  $a' = b$ . Whence first and third give  $a'' = c, b' = c'$ ; and the others are identical. (1) thus becomes

$$ax^2y^2 + 2bxy(x+y) + c(x^2+y^2) + 4b'y + 2c'(x+y) + c'' = 0 \quad (6),$$

Hence (5) takes the form

$$\frac{dx}{\sqrt{A + 2Bx + Cx^2 + 2Dx^3 + Ex^4}} + \frac{dy}{\sqrt{A + 2By + Cy^2 + 2Dy^3 + Ey^4}} = 0,$$

or more briefly

$$\frac{dx}{\sqrt{X}} + \frac{dy}{\sqrt{Y}} = 0,$$

of which the obvious transcendental integral is

$$\int \frac{dx}{\sqrt{X}} + \int \frac{dy}{\sqrt{Y}} = \text{const.}$$

where

$$A = c^2 - ac'', \quad B = 2b'c' - bc'' - c'c', \\ C = 4b'^2 - ac'' - c^2 - 2bc', \quad D = 2bb'' - ac' - bc, \quad E = b^2 - ac.$$

Further, from (4)

$$\sqrt{Y} = (ay^2 + 2by + c)x + by^2 + 2b'y + c', \\ \sqrt{X} = (ax^2 + 2bx + c)y + bx^2 + 2b'x + c'.$$

Hence  $\frac{\sqrt{X} - \sqrt{Y}}{x - y} = axy + b(x+y) + 2b' - c.$

Squaring, we get, by (6), &c., the algebraic integral

$$\left( \frac{\sqrt{X} - \sqrt{Y}}{x - y} \right)^2 = E(x+y)^2 + 2D(x+y) + (2b' - c)^2 - ac''.$$

The constant on the right, involving an arbitrary quantity, if  $A, B, C, D, E$  are known, may be taken as the constant of integration.

198. In Euler's first paper in vol. vii. of the *St Petersburg Commentaries*, he uses the "aqua canonica"  $0 = a + \gamma(x^2 + y^2) + 2\delta xy + \epsilon x^2y^2$  as a starting point for establishing his theorem of addition, and, introducing the notation

$$\Pi(x) = \int_0^x \frac{A' + B'x^2 + C'x^4}{\sqrt{A + Cx^2 + Ex^4}} dx,$$

establishes the equation

$$\Pi(x) + \Pi(y) - \Pi(z) = \frac{xyz}{\sqrt{A}} \left[ -B' - \frac{x^2 + y^2 + z^2}{2} C' + \frac{x^2y^2z^2}{6A} EC' \right]$$

where  $z = \frac{x\sqrt{A(A + Cy^2 + Ey^4)} + y\sqrt{A(A + Cx^2 + Ex^4)}}{A - Ex^2y^2}$

Now, when  $B' = 0, C' = 0$ , these equations represent the theorem of addition for Legendre's first kind of elliptic integrals, and when  $A = 1, C = -(1 + \kappa^2), E = \kappa^2, A' = 1, B' = -\kappa^2, C' = 0$ , they become the theorem of addition for his second kind. Thus it appears that already in 1761 Euler was acquainted with this fundamental theorem, of which he gave many applications to the comparison of elliptic arcs.

199. But it seems to have been Euler's paper "De reductione formularum integralium ad rectificationem ellipsis ac hyperbolæ" (*Novi Comment.*, x. p. 3-50, St Petersburg, 1766), which impelled Legendre to his investigations. With special cases of the general relation, § 197 (1), between  $x$  and  $y$ , Euler transforms integrals contained in the form  $\int \sqrt{\frac{f + gx^2}{k + hx^2}} dx$ , and distinguishes whether the integral has one

of the five significations, arc of ellipse, arc of hyperbola, or either or both of these along with an algebraic part,—collecting in one general investigation the results of Maclaurin and D'Alembert on the rectification of conics. Here we find the words,—regarding the desirability of a suitable notation by which elliptic arcs may be as conveniently expressed in calculation as logarithms and circular arcs are at present, "such signs," he says, "will afford a new sort of calculus, of which I have here attempted the exposition of the first elements,"—which Legendre cites in the preface to his great work in 1825 as having remained unfulfilled but for his own labours continued till that date from his first publications on the subject in 1786.

200. In vol. iv. of the *Miscellanea Taurinensia*, Lagrange deals with the integration which had been given by Euler, remarking that it was due only to a kind of lucky accident. This indeed Euler himself admitted when he stated that he had not obtained this result by a regular method, but "potius tentando, vel divinando," and recommended mathematicians to seek a direct method. Lagrange here lays down the principle that, when the integral of a differential equation of the first degree cannot be found, the equation should be differentiated; and, combining the result with the given equation, an integral equation of the first degree different from the proposed may be found. Then by means of these two the first differentials may be eliminated, and the result is the required integral. If this fail we may differentiate once more, and try to get a new equation of the second order, and so on. This enabled him to give a deduction of Euler's equation, which Euler received with the greatest admiration, and gives nearly as follows in his *Institut. Calc.* *Int.*, iv. p. 466.

Writing for brevity

$$\begin{aligned} A + Bx + Cx^2 + Dx^3 + Ex^4 = X \\ A + By + Cy^2 + Dy^3 + Ey^4 = Y \end{aligned} \dots (1),$$

suppose the differential equation between  $x$  and  $y$  to be

$$\frac{dx}{\sqrt{X}} + \frac{dy}{\sqrt{Y}} = 0 \dots (2).$$

Regard  $x$  and  $y$  as functions of a variable  $t$ , and replace (2) by the following

$$\frac{dx}{dt} = \sqrt{X}, \quad \frac{dy}{dt} = -\sqrt{Y} \dots (3).$$

Assuming  $x + y = p, x - y = q \dots (4),$

we get  $\frac{dp}{dt} = \sqrt{X} - \sqrt{Y}, \quad \frac{dq}{dt} = \sqrt{X} + \sqrt{Y}, \quad \frac{d^2p}{dt^2} = \frac{X' + Y'}{2}, \quad (5),$

which last is, by (1),

$$\frac{d^2p}{dt^2} = B + C(x+y) + \frac{1}{2}D(x^2+y^2) + 2E(x^3+y^3) \dots (6).$$

We also get, from (5),  $\frac{dp}{dt} \frac{dq}{dt} = X - Y$

$$= (x - y) \{ B + C(x+y) + D(x^2 + xy + y^2) + E(x+y)(x^2 + y^2) \},$$

which, combined with (6), gives, by (4),

$$q \frac{d^2p}{dt^2} - \frac{dp}{dt} \frac{dq}{dt} = q^2 \left( \frac{1}{2}D + E\rho \right), \text{ i.e., } \frac{2}{q} \frac{d}{dt} \left( \frac{1}{q} \frac{dp}{dt} \right) = D + 2E\rho$$

Multiplying by  $\frac{dp}{dt}$ , this gives on integration, with  $F$  a constant,

$$\left( \frac{1}{q} \frac{dp}{dt} \right)^2 = D\rho + E\rho^2 + F:$$

whence, replacing values,

$$\left( \frac{\sqrt{X} - \sqrt{Y}}{x - y} \right)^2 = D(x+y) + E(x+y)^2 + F,$$

which is the same result as Euler's (§ 197).

A principal advantage of this method consists in its admitting of generalization, which Euler's method, depending on the solution of a quadratic equation, excludes. But Lagrange fails to apply it to the case of  $X$  and  $Y$  being arbitrary polynomials respectively in  $x$  and  $y$ ; all assumptions lead back to the forms of  $X$  and  $Y$  in (1).

201. In a paper of Euler's in the *St Petersburg Transactions* for 1771, an angle is introduced as the variable into the integral for the arc of an ellipse. In another paper, in the *Novi Commentarii*, 1767, he had also remarked that, in a differential such as

$$\frac{dx}{\sqrt{A + Bx + Cx^2 + Dx^3 + Ex^4}},$$

by a substitution of the form  $x = \frac{mz + a}{nz + b}$  the odd powers of  $z$  under the radical can be abolished; and by a like substitution, removing the odd powers of  $y$ , Euler treats, without any loss of generality, the differential equation in the form

$$\frac{dx}{\sqrt{A + Cx^2 + Ex^4}} = \frac{dy}{\sqrt{A + Cy^2 + Ey^4}}$$

This furnishes an essential simplification of the process of calculation, and leads to the results of his important and remarkable "Plenior Explicatio" in the *St Petersburg Transactions* for 1781. This contains in fact a proposition which includes the theorem of addition for all three kinds of elliptic integrals of Legendre.

$$202. \text{ Putting } \Pi(z) = \int_0^z \frac{Zdz}{\sqrt{1+mx^2+nx^4}},$$

where  $Z$  is an even function of  $z$ ,  $\Pi(x) + \Pi(y) - \Pi(z)$  can be exhibited as an algebraic function of  $x, y$ , and  $z$ , provided a certain algebraic relation holds between  $x, y$ , and  $z$ . "But now," observes Euler, "I have noticed that the same comparisons may be instituted if for  $Z$  be assumed any rational function of  $z^2$ , as suppose one of the form

$$\frac{F + Gz^2 + Hz^4 + Iz^6 + Kz^8 + \dots}{f + gz^2 + hz^4 + iz^6 + kz^8 + \dots};$$

in this case, however, the difference between the sum of two such formulæ and a third is no longer found to be an algebraic quantity, but can always be expressed by logarithms and circular arcs, so that the investigation is much more extensive than I hitherto conceived."

To establish this, assume

$$x^2 + y^2 - z^2 + 2xy\sqrt{1+mx^2+nx^4} - nx^2y^2z^2 = 0 \dots (1),$$

or, writing

$$\sqrt{1+mx^2+nx^4} = \Delta \dots (2),$$

$$x^2 + y^2 - z^2 + 2xy\Delta - nx^2y^2z^2 = 0 \dots (3).$$

Solving in turn for  $x$  and  $y$ , this gives

$$\left. \begin{aligned} x(1 - ny^2z^2) + y\Delta &= z\sqrt{1+my^2+ny^4} \\ y(1 - nx^2z^2) + x\Delta &= z\sqrt{1+mx^2+nx^4} \end{aligned} \right\} \dots (4).$$

But, by differentiation, we know that

$$\frac{dx}{\sqrt{1+mx^2+nx^4}} + \frac{dy}{\sqrt{1+my^2+ny^4}} = 0 \dots (5),$$

which may be written thus

$$\frac{dx}{y(1-nx^2z^2)+x\Delta} = -\frac{dy}{x(1-ny^2z^2)+y\Delta} \dots (6).$$

For  $x=0$ ; the relation (3) gives  $y=z$ ; whence (5) integrated gives the known theorem of addition for integrals of the first kind.

Now let  $X, Y$  be the same functions of  $x^2, y^2$  as  $Z$  is of  $z^2$ : then

writing  $\frac{XdX}{\sqrt{1+mx^2+nx^4}} + \frac{YdY}{\sqrt{1+my^2+ny^4}} = dV \dots (7),$

the quantity  $V$  may be found as follows.

We can eliminate by (5) either  $dx$  or  $dy$  from (7); but, as there is no reason to consider  $V$  as a function of  $x$  or of  $y$  specially, introduce a new independent variable  $u = xy$ . Then we may replace (6) by  $dx = [y(1-nx^2z^2) + x\Delta]du, dy = -[x(1-ny^2z^2) + y\Delta]du \dots (8),$

where we take

$$s = \frac{1}{y^2 - x^2}.$$

Thus

$$\frac{dx}{\sqrt{1+mx^2+nx^4}} = -\frac{dy}{\sqrt{1+my^2+ny^4}} = \frac{zdu}{y^2 - x^2},$$

which give

$$dV = -z \frac{Y-X}{y^2 - x^2} du \dots (9),$$

But now  $\frac{Y-X}{y^2 - x^2}$  is a function of  $xy$  and  $x^2 + y^2$ , or of  $u$ , since by (3)

$$x^2 + y^2 = z^2 - 2u\Delta + nu^2z^2.$$

Thus, putting  $z \frac{Y-X}{y^2 - x^2} = U$ , we have  $dV = -Udu$ . Substituting this in (7), and integrating, we have

$$\Pi(x) + \Pi(y) - \Pi(z) = -\int_0^u Udu,$$

since, for  $x=0, y=z$  and  $u=0$ .

As an example,

if  $Z = \frac{a + bz^2}{a + b'z^2}$ , then  $\frac{Y-X}{y^2 - x^2} = \frac{a'b - ab'}{a^2 + a'b'(x^2 + y^2) + b^2x^2y^2};$

that is,  $U = \frac{(a'b - ab')z}{a^2 + a'b'(z^2 - 2u\Delta + u^2z^2) + (b^2 + a'b'nz^2)u^2}.$

Thus, if we take

$$\Pi(z) = \int_0^z \frac{a + bz^2}{a' + b'z^2} \frac{dz}{\sqrt{1+mx^2+nx^4}},$$

we have

$$\Pi(x) + \Pi(y) - \Pi(z) = \int_0^u \frac{(ab' - a'b)zdu}{a^2 + a'b'z^2 + 2a'b'\Delta u + (b^2 + a'b'nz^2)u^2},$$

in which after integration  $u$  is to be put  $=xy$ . By assigning special values to the constants this equation can be applied to each kind of elliptic integral.

203. In the *Théorie des Fonctions Analytiques* of Lagrange there is found the remark on the relation between the summation of elliptic

integrals and spherical triangles which is involved in the formulæ of § 200, and of which we have given the essential formulæ in §§ 34-36. But Lagrange's paper "On a new method of the Integral Calculus for Differentials affected with the square root of a polynomial of not more than the fourth degree" (*Mémoire de l'Acad. des sciences*, 1784-5, 2d part, Turin, 1786), contains additions of much greater importance to our subject.

Taking

$$\left. \begin{aligned} p' &= p + \sqrt{p^2 - q^2}, & q' &= p - \sqrt{p^2 - q^2}, \\ p'' &= p' + \sqrt{p'^2 - q'^2}, & q'' &= p' - \sqrt{p'^2 - q'^2}, \\ p''' &= p'' + \sqrt{p''^2 - q''^2}, & q''' &= p'' - \sqrt{p''^2 - q''^2}. \end{aligned} \right.$$

Further, writing for brevity,

$$\left. \begin{aligned} R &= \sqrt{(1 \pm p^2 y^2)(1 \pm q^2 y^2)}, \\ R' &= \sqrt{(1 \pm p'^2 y'^2)(1 \pm q'^2 y'^2)}, \\ R'' &= \sqrt{(1 \pm p''^2 y''^2)(1 \pm q''^2 y''^2)}; \end{aligned} \right.$$

and

$$y' = \frac{yR}{1 \pm q^2 y^2}, \quad y'' = \frac{y'R'}{1 \pm q'^2 y'^2}, \quad y''' = \frac{y''R''}{1 \pm q''^2 y''^2} \dots$$

we have the equations

$$\left. \begin{aligned} y^2 &= \frac{\pm q^2 y'^2 - 1 + R'}{\pm 2p^2}, \\ y'^2 &= \frac{\pm q'^2 y''^2 - 1 + R''}{\pm 2p'^2}, \\ y''^2 &= \frac{\pm q''^2 y'''^2 - 1 + R'''}{\pm 2p''^2}; \end{aligned} \right.$$

and

$$\frac{dy}{R} = \frac{dy'}{R'} = \frac{dy''}{R''} \dots$$

Now, assuming  $q < p$ , we have  $p < p' < p''$ ; and, as  $q' = q \cdot \frac{q}{p'}$ ,  $q > q' > q''$ , &c., without limit.

Lagrange gives another system of equations of reduction following from the above series when continued backwards, so that the series are

$$\dots p_2, p_1, p, p', p'', \dots$$

$$\dots q_2, q_1, q, q', q'', \dots$$

The equations

$$\left. \begin{aligned} p &= p_1 + \sqrt{p_1^2 - q_1^2}, & q &= p_1 - \sqrt{p_1^2 - q_1^2}, \\ p_1 &= p_2 + \sqrt{p_2^2 - q_2^2}, & q_1 &= p_2 - \sqrt{p_2^2 - q_2^2}, \end{aligned} \right.$$

give conversely

$$\left. \begin{aligned} p_1 &= \frac{1}{2}(p + q), & q_1 &= \sqrt{pq}, \\ p_2 &= \frac{1}{2}(p_1 + q_1), & q_2 &= \sqrt{p_1 q_1}, \end{aligned} \right.$$

and the terms  $p, p_1, p_2 \dots$  decrease, while  $q, q_1, q_2 \dots$  increase.

Now, putting

$$y = \frac{y_1 R_1}{1 \pm q_1^2 y_1^2}, \quad y_1 = \frac{y_2 R_2}{1 \pm q_2^2 y_2^2}, \dots$$

$R_1 = \sqrt{(1 \pm p_1^2 y_1^2)(1 \pm q_1^2 y_1^2)}, R_2 = \sqrt{(1 \pm p_2^2 y_2^2)(1 \pm q_2^2 y_2^2)}, \dots$

we get

$$y_1^2 = \frac{\pm q_1^2 y^2 - 1 + R}{\pm 2p_1^2}, \text{ \&c.; and } \frac{dy}{R} = \frac{dy_1}{R_1} = \frac{dy_2}{R_2} = \text{\&c.}$$

The former series are essentially the transformation known by Landen's name; the latter, indirectly, are (§ 214) the transformation which Gauss published in 1818, and on which his theory of the arithmetico-geometric mean is based.

204. We have thus glanced at the most important contributions to this branch of our subject previous to Legendre. His "Mémoire sur les intégrations par d'arcs d'ellipse" (*Histoire de l'Acad.*, 1786) appeared a few years after Euler's death (1783). The geometric basis is here almost abandoned. Establishing with ease and elegance the theorems of Fagnani, Landen, and Euler, there are perceptible traces of a coming theory of transformation in the analytical conception of these theorems. Legendre's *Mémoire sur les Transcendentes Elliptiques* (Paris, 1793) contains the division of elliptic integrals into their different kinds, the reduction of integrals of each kind to the simplest normal forms, and the calculation of elliptic integrals by most accurate modes of approximation. All these investigations are collected in Legendre's *Exercices* (Paris, 1811-19), and later in his *Traité des Fonctions elliptiques et des Intégrales Eulériennes* (Paris, 1825-6, 2 vols., suppl. vol., 1828).

205. "It is Legendre's undying glory," said Lejeune Dirichlet of this great work, "to have recognized in the discoveries we have just mentioned (of Fagnani, Euler, Landen, and Lagrange) the bud-



ding of a mighty branch of analysis, and by the toil of half a life to have erected on these bases an independent theory which embraces all integrals containing no other irrationality but a square root under which the variable rises only to the fourth degree. Euler had already noticed with what modifications his theorem can be extended to such integrals; Legendre, starting from the happy thought of reducing all these integrals to fixed canonical forms, attained the knowledge, so important for the development of the theory, that they group into three essentially different kinds. Submitting them each kind to a careful investigation, he discovered many of their most important properties, of which chiefly those which belong to the third kind were very obscure and inaccessible. Only for the most persistent tenacity, which ever anew led the great-mathematician to his subject, did the victory at last declare itself over difficulties apparently insurmountable by the weapons at his disposal."

206. Having shown that the integral  $\int \frac{Pdx}{R}$ , where P is a rational function of x, and  $R = (\alpha + \beta x + \gamma x^2 + \delta x^3 + \epsilon x^4)^{\frac{1}{2}}$ , can be reduced to the fixed fundamental forms  $\int \frac{dx}{R}$ ,  $\int \frac{x dx}{R}$ ,  $\int \frac{x^2 dx}{R}$ ,  $\int \frac{dx}{(1+nx)R}$ , Legendre removes, by aid of the linear transformation  $x = \frac{p+qy}{1+y}$ , the odd powers of the variable from the polynomial R<sup>2</sup>, and shows, by enumeration of cases, that  $\frac{dx}{R}$  can always be reduced to the form  $\frac{m d\phi}{\sqrt{1-c^2 \sin^2 \phi}}$ , where c is a quantity less than unity. Thus he reduces the general elliptic integral  $\int \frac{Q dx}{\sqrt{1-c^2 \sin^2 \phi}}$ , with abstraction from an algebraic part, to the three normal forms of "elliptic functions or transcendents"—

$$\int \frac{d\phi}{\Delta} = F, \quad \int \Delta d\phi = E, \quad \int \frac{d\phi}{(1+n \sin^2 \phi)\Delta} = \Pi,$$

$\Delta$  being an abbreviation for the radical  $\sqrt{1-c^2 \sin^2 \phi}$ . With this reduction to fixed normal forms the foundation of the theory of elliptic integrals is laid, and the essentially irreducible integrals found which belong to a square root of a biquadratic function. The same reduction subsequently led to the division of the general Abelian integrals into those of the first, second, and third kinds, in accordance with the properties of these three classes of integrals, either of remaining always finite, or of becoming infinite, algebraically only at infinity, or logarithmically at two different points.

It will be perceived that the epithet "elliptic" applied to these integrals is purely conventional, arising from the connexion of one of them with the arc of an ellipse; but even at this stage it is apparent that we are concerned with matters of much greater generality than the name indicates. It may also be noticed that, though Legendre calls by the name elliptic functions what are now called elliptic integrals, this is a change introduced by Jacobi, which Legendre long resisted. The change consists in regarding the superior limit of the integral of the first kind as a function of the integral, the latter being now considered as the independent variable. Expressed in symbols the change is that, in Legendre's equation  $F(\kappa, \phi) = \int_0^\phi \frac{d\phi}{\Delta(\kappa, \phi)} = u$ , Jacobi calls  $\phi = \text{am}(u, \kappa)$ , and  $\sin \phi$ ,  $\cos \phi$ , or  $\Delta \phi$ , &c. (or, in this notation,  $\sin \text{am } u$ ,  $\cos \text{am } u$ ,  $\Delta \text{am } u$ , &c.), are his elliptic functions.

207. Legendre proceeds, after classifying the integrals, to the comparison of his elliptic functions of the first kind. All geometers, he says, are acquainted with the complete algebraic integral given by Euler of the differential equation

$$\frac{dx}{(\alpha + \beta x + \gamma x^2 + \delta x^3 + \epsilon x^4)^{\frac{1}{2}}} + \frac{dy}{(\alpha + \beta y + \gamma y^2 + \delta y^3 + \epsilon y^4)^{\frac{1}{2}}} = 0;$$

the discovery of which, in the introduction, he too ascribes to a combination of good fortune "quoique ces hazards n' arrivent qu'à ceux qui savent les faire naître." Our reductions show that this equation can, without loss of generality, be put under the form

$$\frac{d\phi}{\sqrt{1-c^2 \sin^2 \phi}} + \frac{d\psi}{\sqrt{1-c^2 \sin^2 \psi}} = 0;$$

and then its integral is

$$F(\phi) + F(\psi) = F(\mu),$$

$\mu$  being an arbitrary constant. But the integral found by Euler's method is thus written

$$\cos \phi \cos \psi - \sin \phi \sin \psi \sqrt{1-c^2 \sin^2 \mu} = \cos \mu,$$

which he then verifies *a posteriori*.

$$\text{The expressions } \sin \mu = \frac{\sin \phi \cos \psi \Delta \psi + \sin \psi \cos \phi \Delta \phi}{1 - c^2 \sin^2 \phi \sin^2 \psi},$$

$$\cos \mu = \frac{\cos \phi \cos \psi - \sin \phi \sin \psi \Delta \phi \Delta \psi}{1 - c^2 \sin^2 \phi \sin^2 \psi},$$

$$\Delta \mu = \frac{\Delta \phi \Delta \psi - c^2 \sin \phi \sin \psi \cos \phi \cos \psi}{1 - c^2 \sin^2 \phi \sin^2 \psi},$$

are at once derived from this form of the integral; and the corresponding formulæ for the amplitude of the difference between two functions follow by replacing  $\psi$  by  $-\psi$ .

Legendre next proceeds to the formulæ for finding algebraically a multiple function of a given one, connecting the angles  $\phi_{n-1}$ ,  $\phi_n$ ,  $\phi_{n+1}$ , by the relations equivalent to  $F(\phi_{n+1}) = F(\phi_n) + F(\phi)$ ;  $F(\phi_{n-1}) = F(\phi_n) - F(\phi)$ , which he writes

$$\sin \phi_{n+1} + \sin \phi_{n-1} = \frac{2\Delta \cos \phi \sin \phi_n}{1 - c^2 \sin^2 \phi \sin^2 \phi_n},$$

$$\cos \phi_{n+1} + \cos \phi_{n-1} = \frac{2 \cos \phi \cos \phi_n}{1 - c^2 \sin^2 \phi \sin^2 \phi_n}.$$

These can be applied in succession. Investigating the division of a function into  $n$  equal parts the equation is found to rise in general to the degree  $n^2$ ; but for the complete function the equation is only of the degree  $\frac{1}{2}(n^2 - 1)$  when  $n$  is odd.

208. Proceeding to generalization of Euler's addition theorem, Legendre admits that, denoting the radical by  $R(x)$ , &c., the equation  $0 = \frac{m dx}{R(x)} + \frac{n dy}{R(y)} + \frac{p dz}{R(z)} + \dots$ , can for integer values of  $m, n, p$  always be expressed in the form  $F(\mu) = mF(\phi) + nF(\psi) + \dots$  and so will always have a complete algebraic integral, for nothing prevents the supposition that  $z$  and the following variables are given algebraic functions of  $x$  and  $y$ . Perhaps, he says, this is the only way of generalizing Euler's result concerning the equation  $\frac{dx}{R(x)} + \frac{dy}{R(y)} = 0$ . For, though Lagrange tried to find cases of integrability of  $\frac{dx}{\sqrt{X}} + \frac{dy}{\sqrt{Y}}$ , without supposing the two polynomials X

and Y entirely similar, it does not seem that he arrived at any other result; the equation he gives (*Mém. de Turin*, iv. 119) is immediately reducible to Euler's. Thus, as has been remarked, Legendre was at this time very far from anticipating the very general transformations, since discovered, or the celebrated theorem of Abel which so marvellously extended this subject.

209. Having illustrated the functions F by the lemniscate and other curves, algebraic and transcendental, whose arcs are expressed by functions of the first kind, as well as by the expression for the time in the motion of a simple pendulum, Legendre enters, in chapter ix., on the comparison of elliptic functions of the second kind. Corresponding to the relation  $F(\phi) + F(\psi) - F(\mu) = 0$ , these functions are related by

$$E(\phi) + E(\psi) - E(\mu) = c^2 \sin \mu \sin \phi \sin \psi.$$

This includes Fagnani's as a particular case, and of course there is a similar relation for comparison of the arcs of hyperbolæ. In chap. xii. the well-known relation of Legendre is established between complete integrals of the first two kinds with complementary moduli;  $b$  and  $c$  being moduli are said to be complementary when

$$b^2 + c^2 = 1. \text{ Denoting by } F, E \text{ the values of } F\left(\frac{\pi}{2}, c\right), E\left(\frac{\pi}{2}, c\right),$$

and by  $F', E'$  those of  $F\left(\frac{\pi}{2}, b\right), E\left(\frac{\pi}{2}, b\right)$ , this relation, which has been already demonstrated, § 183, is

$$F'E' + FE - FF' = \frac{\pi}{2}.$$

These complete functions satisfy differential equations of the second order, viz., F satisfies

$$(1-c^2) \frac{d^2 F}{dc^2} + \frac{1-3c^2}{c} \frac{dF}{dc} - F = 0,$$

and the complete E

$$(1-c^2) \frac{d^2 E}{dc^2} + \frac{1-c^2}{c} \frac{dE}{dc} + E = 0,$$

with corresponding equations when  $b$  is taken as the independent variable. The complete integrals of these differential equations are assigned in terms of both sets of complete functions, and the differential equations are utilized to show the law of the development of these functions in series of powers of the complement of the modulus, since when the modulus is near unity the ordinary series in powers of the modulus do not sufficiently converge.

210. In treating integrals of the third kind, the presence of a third determining magnitude, the parameter  $n$ , besides the amplitude  $\phi$  and modulus  $c$ , which are common to the first two kinds, is



an additional complication. Legendre first establishes the relation

$$\Pi(n) + \Pi\left(\frac{c^2}{n}\right) = F + \frac{1}{\sqrt{\alpha}} \tan^{-1} \frac{\sqrt{\alpha} \tan \phi}{\Delta},$$

where

$$\alpha = (1+n)\left(1 + \frac{c^2}{n}\right);$$

by means of which any function  $\Pi$  having a parameter greater than  $c$  is reduced to depend on one having a parameter less than  $c$ , but with the same amplitude and modulus. The quantity  $\alpha$ , however, may have different values, and thus the following cases are to be distinguished.

When  $\alpha$  is positive (either  $n$  positive, or if negative its value is between  $-1$  and  $-c^2$ ) the function introduced is *circular*, as written above.

When  $\alpha$  is negative,  $n$  is negative, and either greater than  $-1$  or less than  $-c^2$ , and the function is *logarithmic*. In this case writing  $\alpha = -\beta$ , the comparison written above is

$$\Pi(n) + \Pi\left(\frac{c^2}{n}\right) = F + \frac{1}{2\sqrt{\beta}} \log \left( \frac{\Delta + \sqrt{\beta} \tan \phi}{\Delta - \sqrt{\beta} \tan \phi} \right),$$

When  $\alpha = 0$  the integrals are expressed by the first and second kinds.

Omitting the case of  $n = -\operatorname{cosec}^2\theta$ , which can be reduced to that of  $n = -c^2 \sin^2\theta$ , this case and those of  $n = \cot^2\theta$  and  $n = -1 + b^2 \sin^2\theta$  remain, the first being the logarithmic parameter. The other two cases are easily shown to be connected by the relation

$$\frac{1+n}{n} \Pi(n) - \frac{1-m}{m} \Pi(-m) = \frac{c^2 F}{mn} + \frac{1}{\sqrt{mn}} \tan^{-1} \frac{\sqrt{mn} \sin \phi \cos \phi}{\Delta},$$

provided  $(1+n)(1-m) = b^2$ , and so constitute really but one case. Functions with imaginary parameters always reduce to others with real parameters of the above two distinct kinds.

211. Comparison of integrals of the third kind by means of the additional theorem leads to the formula

$$\Pi(\phi) + \Pi(\psi) - \Pi(\mu) = \frac{1}{\sqrt{\alpha}} \tan^{-1} \left\{ \frac{n\sqrt{\alpha} \sin \mu \sin \phi \sin \psi}{1+n-n \cos \mu \cos \phi \cos \psi} \right\};$$

and thus the difference, which is zero in the first kind, and is algebraic in the second, is here expressed by the arc of a circle; which becomes a logarithm if  $\alpha$  be negative. Thus finally Legendre remarks that if

$$Z(x) = \int \frac{P dx}{\sqrt{(a + \beta x + \gamma x^2 + \delta x^3 + \epsilon x^4)}},$$

where  $P$  is a rational function of  $x$ , there can always be found an algebraic equation between  $x, y, z$ , &c., such that the quantity

$$iZ(x) + kZ(y) + lZ(z) + \&c.,$$

where  $i, k, l$ , &c., are integers, may be determinable by arcs of circles and by logarithms.

212. Legendre next proceeds to the discovery of Landen, having so far been employed mainly with those of Euler. He expresses astonishment that among the many analytical transformations employed by Maclaurin and D'Alembert they had not fallen in with the transformation which brings to light the numerous properties of the chain of moduli, and that this discovery was reserved for Landen, who, however, made but a poor use of it, not even seeing that it furnished a very simple method for approximate calculation of the arcs of conics. It is less astonishing that Euler missed this discovery considering that the beautiful integration which is due to him led him to compare together the different values of the same transcendent, just as arcs of the same curve are compared. But nowhere in his *Mémoires* do we find him varying the constants or parameters of the functions, and thus passing from one curve to another, as is done in comparisons which depend on the scale of moduli. From the fact that Euler has written nothing about the memoir of Landen, Legendre concludes he had never been acquainted with it.

213. The formula given in § 194, by introducing the eccentric angles from the axes minor in the two ellipses, easily gives rise to the equation  $\sin \phi^0 = (1+b) \frac{\sin \phi \cos \phi}{\Delta}$ , where  $b = \frac{n}{m}$ , and so  $c = \sqrt{g}$  of that article.  $\phi^0$  belongs to another ellipse, and for it the value of the corresponding modulus is evidently  $\frac{1-b}{1+b}$ . Legendre sees through the simple proposition of Landen, expressing the arc of a hyperbola by two arcs of ellipses, to the infinite series of moduli which can be produced by repeated application of this substitution. Commencing with functions of the first kind, he shows

that  $F(c, \phi)$  and  $F(c', \phi')$ , when  $c' = \frac{2\sqrt{c}}{1+c}$ , and  $\phi'$  is determined by  $\sin(2\phi' - \phi) = c \sin \phi$ , are related by the equation

$$F(c', \phi') = \frac{1+c}{2} F(c, \phi).$$

Thus, as  $2\phi' - \phi$  is always contained between  $+\theta$  and  $-\theta$ ,  $\theta$  being the least arc having  $c$  for its sine, there is no ambiguity in deter-

mining the values of  $\phi'$  and  $\phi$ . The relation for complete functions is  $F^1(c') = (1+c)F^1(c)$ . Now conceive an infinite series of increasing moduli

$$c' = \frac{2\sqrt{c}}{1+c}, \quad c'' = \frac{2\sqrt{c'}}{1+c'}, \quad c''' = \frac{2\sqrt{c''}}{1+c''}, \quad \&c.,$$

it will soon attain the limit unity. Forming the complements  $b', b'', \&c.$ , of these moduli, the series decreases continually, and each term is, according to the law,

$$b' = \frac{1-c}{1+c}, \quad b'' = \frac{1-c'}{1+c'}, \quad b''' = \frac{1-c''}{1+c''}, \quad \&c.$$

The series of amplitudes is deduced in succession by the formulæ

$$\sin(2\phi' - \phi) = c \sin \phi, \quad \sin(2\phi'' - \phi') = c' \sin \phi', \\ \sin(2\phi''' - \phi'') = c'' \sin \phi'', \quad \&c.;$$

and so a series of integrals of the first kind is got, related as follows

$$F(c', \phi') = \frac{1+c}{2} F(c, \phi), \\ F(c'', \phi'') = \frac{1+c'}{2} F(c', \phi') = \frac{1+c}{2} \frac{1+c'}{2} F(c, \phi), \quad \&c.,$$

any two of the functions being always in a ratio independent of the values of the corresponding amplitudes. Similarly for the complete functions

$$F^1(c') = (1+c)F^1(c), \quad F^1(c'') = (1+c')F^1(c') = (1+c)(1+c')F^1(c), \quad \&c.$$

But the series  $c, c', c'',$  increasing in one direction, can be prolonged indefinitely in the opposite or decreasing sense to the limit zero. Here the law of terms is

$$c = \frac{2\sqrt{c^0}}{1+c^0}, \quad c^0 = \frac{2\sqrt{c^{00}}}{1+c^{00}}, \quad c^{00} = \frac{2\sqrt{c^{000}}}{1+c^{000}}, \quad \&c.;$$

and similarly

$$c^0 = \frac{1-b}{1+b}, \quad c^{00} = \frac{1-b^0}{1+b^0}, \quad \&c.,$$

with the series of relations of amplitudes derived from  $\sin(2\phi - \phi^0) = c^0 \sin \phi$ , &c., which may be written  $\tan(\phi - \phi^0) = b \tan \phi$ , &c., and of integrals  $F(c, \phi) = \frac{1+c^0}{2} F(c^0, \phi^0)$ , &c.;

or, reversing, since  $1+c^0 = \frac{2}{1+b}$ ,

$$F(c^0, \phi^0) = (1+b)F(c, \phi), \\ F(c^{00}, \phi^{00}) = (1+b^0)F(c^0, \phi^0) = (1+b)(1+b^0)F(c, \phi), \quad \&c.,$$

and, for the complete integrals,

$$F^1(c^0) = \frac{1+b}{2} F^1(c), \\ F^1(c^{00}) = \frac{1+b^0}{2} F^1(c^0) = \frac{1+b}{2} \frac{1+b^0}{2} F^1(c), \quad \&c.,$$

for the decreasing scale of moduli.

214. Now if this be applied to the second kind of integrals we find

$$b^2 F(c, \phi) = 2E(c, \phi) - 2(1+c)E(c', \phi') + 2c \sin \phi,$$

showing that an integral of the first kind can be expressed by the aid of two arcs of ellipses,  $E(c, \phi)$  and  $E(c', \phi')$ . Whence by the formula of § 192 it follows that an arc of a hyperbola can always be expressed by two elliptic arcs, the theorem Landen enriched geometry by. Also, by eliminating the integral of the first kind by means of two consecutive equations in the series, the relation between the arcs of three consecutive ellipses in the series can be found; so that by the indefinite rectification of two ellipses in the series

$$\dots E(c', \phi''), \quad E(c', \phi'), \quad E(c, \phi), \quad E(c^0, \phi^0), \quad E(c^{00}, \phi^{00}), \dots$$

of which the extremes are the ellipse having an eccentricity 1, which is a portion of the axis major, and that having an eccentricity 0, which is a circle, the rectification of all the rest is obtained.

The transformations of Lagrange, or of Gauss (§ 203), may be seen to be essentially the same as this of Landen (or Legendre), for by taking  $\sin \phi = \frac{(1+k) \sin \psi}{1+k \sin^2 \psi}$  in  $F(c, \phi)$  we get

$$\frac{d\phi}{\sqrt{1-c^2 \sin^2 \phi}} = \frac{(1+k)d\psi}{\sqrt{1-k^2 \sin^2 \psi}}, \quad \text{where } c = \frac{2\sqrt{k}}{1+k}, \quad \text{or } k = c^0.$$

Hence  $F(c, \phi) = (1+c^0)F(c^0, \psi)$ .

Now with  $F(c^0, \psi) = \frac{1}{2} F(c^0, \phi^0)$ ,  $F(c, \phi) = \frac{1+c^0}{2} F(c^0, \phi^0)$ , and by elimi-

nating the quantity  $\psi$  between the equations  $\sin \phi = \frac{(1+c^0) \sin \psi}{1+c^0 \sin^2 \psi}$ ,

$\tan \frac{1}{2} \phi^0 = \tan \psi \sqrt{1-c^0 \sin^2 \psi}$ , we obtain the relation given above  $\sin(2\phi - \phi^0) = c^0 \sin \phi^0$ .

215. This principle of transformation is next applied to the approximate calculation of the three kinds of integrals. Required, for instance, an approximate value of  $F(c, \phi)$ : the decreasing moduli

$c^0, c^{00}, c^{000}, \dots$  must be calculated and the increasing amplitudes  $\phi^0, \phi^{00}, \phi^{000}, \dots$  thus

$$F(c, \phi) = \frac{1+c^0}{2} F(c^0, \phi^0) = \frac{1+c^0}{2} \frac{1+c^{00}}{2} F(c^{00}, \phi^{00}) = \&c.;$$

but, when the modulus has become very small,  $\Delta = 1$ , and  $\int \frac{d\phi}{\Delta} = \phi$ ; if then  $\phi$  be the limit of the angles  $\frac{1}{2}\phi^0, \frac{1}{3}\phi^{00}, \frac{1}{4}\phi^{000}, \&c.$ , we have

$$F(c, \phi) = \Phi(1+c^0)(1+c^{00}) \dots$$

When  $\phi = \frac{1}{2}\pi$  the limit  $\Phi$  will be equally  $\frac{1}{2}\pi$ ; so that the complete function is

$$F^1(c) = \frac{1}{2}\pi(1+c^0)(1+c^{00})(1+c^{000}) \dots$$

The continued product which multiplies  $\frac{1}{2}\pi$ , or  $\Phi$ , may also be written in a form suited to logarithmic calculation, as

$$\sqrt{\frac{b^0 b^{00} b^{000}}{b}} \dots$$

The moduli are best got by taking auxiliary angles: let  $\sin \mu = c$ ,  $\therefore c^0 = \tan^2 \frac{1}{2}\mu$ , similarly if  $c^0 = \sin \mu^0$ ,  $c^{00} = \tan^2 \frac{1}{2}\mu^0$ , &c.; and when a very small  $c$  has been arrived at, we can get the next by  $c^0 = \frac{1}{2}c^2 + \frac{1}{4} \cdot \frac{2}{3}c^4 + \frac{1}{4} \cdot \frac{2}{3} \cdot \frac{2}{5}c^6 + \dots$

Also the angles  $\phi^0, \phi^{00}$ , are best found by  $\tan(\phi^0 - \phi) = b \tan \phi$ ,—taking for  $\phi^0 - \phi$  not always the least angle given by the tables but that which is nearest  $\phi$ .

216. Combining the equation  $\Pi = \int \frac{d\phi}{(1+n \sin^2 \phi) \Delta \phi}$  with that derived from it by differentiation with regard to  $n$ , and using  $a$  to denote  $(1+n) \left(1 + \frac{c^2}{n}\right)$ , as in § 210, it is easily found that

$$2\sqrt{a} \cdot \Pi = \Delta \sin \phi \cos \phi \int \frac{dn}{(1+n \sin^2 \phi) \sqrt{a}} - c^2 F \int \frac{dn}{n^2 \sqrt{a}} - (F-E) \int \frac{dn}{n \sqrt{a}}$$

Applying this to the case  $n = \cot^2 \phi$ , and writing for brevity  $\cot^2 \phi = n'$ , the following relation is found:—

$$\begin{aligned} & \frac{\Delta(b, \theta)}{\sin \theta \cos \theta} \Pi(n, c, \phi) + \frac{\Delta(c, \phi)}{\sin \phi \cos \phi} \Pi(n', b, \theta) \\ &= \frac{1}{2}\pi + \tan \theta \Delta(b, \theta) F(c, \phi) + \tan \phi \Delta(c, \phi) F(b, \theta) \\ &+ F(c, \phi) F(b, \theta) - F(c, \phi) E(b, \theta) - E(c, \phi) F(b, \theta). \end{aligned}$$

Making  $\phi = \frac{1}{2}\pi$ , this gives for the complete function of the third kind, with positive parameter, the following expression:—

$$\begin{aligned} & \frac{\Delta(b, \theta)}{\sin \theta \cos \theta} \Pi^1(n, c) = \frac{1}{2}\pi + \tan \theta \Delta(b, \theta) F^1(c) \\ &+ F^1(c) F(b, \theta) - F^1(c) E(b, \theta) - E^1(c) F(b, \theta). \end{aligned}$$

A similar relation is established for the other cases of the parameter, and in each the complete integral is likewise expressed by integrals of lower kinds.

There now follow the general reduction of integrals with imaginary parameter, and the reduction to elliptic integrals of integrals not included in the general type, as for instance

$$\int \frac{dz}{(1+pz^2)(1+qz^2)^2}, \int \frac{d\phi}{(1-c^2 \sin^2 \phi)^{\frac{1}{2}}}, \int \frac{d\phi}{(1-c^2 \sin^2 \phi)^2}, \&c.$$

217. In his preface, however, Legendre had directed attention to the discovery of a new scale of moduli, different from that hitherto known, as the most novel of the results distinguishing this work from his *Exercices*. This transformation starts from the assumption

$$\sin \omega = \frac{\sin(\phi + h \sin^2 \phi)}{1 + k \sin^2 \phi};$$

and by the conditions that  $\omega$  and  $\phi$  reach  $\frac{1}{2}\pi$  together, and, moreover, that  $\cos \omega$  does not contain any other irrational factor in  $\sin \phi$  but  $\cos \phi$ , we get

$$\cos \omega = \frac{\cos \phi(1 - h \sin^2 \phi)}{1 + k \sin^2 \phi}, \text{ with } k = \frac{1}{2}(m-1)(m+3), \quad h = \frac{1}{2}(m-1)^2.$$

Now  $d\omega = \frac{d\phi(m-k \sin^2 \phi)}{1+k \sin^2 \phi}$ , hence  $\tan \frac{1}{2}(\omega + \phi) = \frac{m+1}{2} \tan \phi$ .

But in order that  $\omega$  should increase gradually from 0 to  $\frac{1}{2}\pi$ , as  $\phi$  does,  $h$  must be less than 1, and  $m$  less than 3.

Again, if  $c$  and  $a$  are two moduli, so related that

$$1 - a^2 \sin^2 \omega = (1 - c^2 \sin^2 \phi) \left( \frac{1 - \frac{k}{m} \sin^2 \phi}{1 + k \sin^2 \phi} \right)^2,$$

it will be found possible in general to satisfy the above equation, and thus we get

$$a^2 = \frac{(m-1)(m+3)^3}{16m^3}, \text{ and } c^2 = \frac{(m-1)^3(m+3)}{16m};$$

whence  $m$  must be between 3 and 1 in order that  $a$  and  $c$  may both be real proper fractions.

$$\text{Hence } \Delta(a, \omega) = \frac{1 - \frac{k}{m} \sin^2 \phi}{1 + k \sin^2 \phi} \Delta(c, \phi);$$

and this, combined with the above differential relation, gives

$$\frac{d\omega}{\Delta(a, \omega)} = \frac{m d\phi}{\Delta(c, \phi)},$$

or, integrating,  $F(a, \omega) = m F(c, \phi)$ ,—a relation between two functions of the first kind, whose moduli depend in general on the quantity  $m$ , which may be taken at will between the limits 1 and 3.

The modulus  $a$  is always greater than  $c$ , for we have

$$\frac{c}{a} = \frac{m^2 - m}{m + 3} \text{ and } m + 3 - (m^2 - m) = (1 + m)(3 - m),$$

which is always positive. We have seen that  $a$  and  $c$  are determined by means of the regulator  $m$  when it is known; it can be found from either of them by solving a biquadratic.

Again, the complements of the moduli are found by

$$\beta^2 = \frac{(m+1)(3-m)^3}{16m^3}, \quad \beta^2 = \frac{(m+1)^3(3-m)}{16m},$$

whence follows the simple relation

$$\sqrt{ac} + \sqrt{\beta\delta} = 1.$$

Application of this transformation to integrals of the second and third kinds gives rise to the remark that the trisection of an indefinite function of the first kind may be reduced to depend on the solution of two cubic equations.

218. Now, starting with a given modulus  $c$ , an infinite series of moduli increasing towards the limit 1, and an infinite series decreasing towards the limit 0, may be formed, and we may denote the latter by a notation analogous to the former. Let them be in the increasing order  $c, c_1, c_{11}, c_{111}, \&c.$ , and in the decreasing order  $c, c_0, c_{00}, \&c.$ ; and similarly for the complements, the regulators, and the amplitudes. Thus, by the first scale, any integral of the first kind, having a given modulus and amplitude, can be transformed into another with any modulus in the series  $\dots c^{00}, c^0, c, c', c', \dots$  and from this by the second to any in the other series formed from the same  $c$  by a different law, depending on extractions of square and cube roots.

Legendre arranges the moduli in a sort of infinite chess-board, having  $c$  in the centre, and the moduli derived according to each scale in rectangular directions, and notices how remarkable is this infinite multitude of transformations which the same function  $F(c, \phi)$  may be submitted to, without changing its nature while preserving the same ratio between the new function and the old for all values of the amplitude; in vain, he adds, might a second example be sought of a function which should be reproduced under so many different forms, and to which, more justly than to the logarithmic spiral, might be applied James Bernoulli's device, "Eadem mutata resurgit."

219. The first volume of the *Traité* also contains the reduction to elliptics of a great number of integrals, the development of elliptic integrals in series proceeding by sines and cosines of multiples of the amplitude, and calculations of some definite integrals, single and double, which can be expressed by elliptic integrals. The applications are, in geometry to the surface of an oblique cone, to that of an ellipsoid, and to a geodesic on a spheroid; and in mechanics, to the rotation of a solid, to the motion of a body under the attraction of two fixed centres, to the attraction of homogeneous ellipsoids, and to the orbit described under a given central force.

The second volume contains details of the calculation of the integrals, and such tables of them as have to be constructed in order that the use of these functions may be introduced into analysis just as circular and logarithmic functions are employed. Here, Legendre excludes the thought of reducing to tables functions of the third kind, since they contain besides the principal variable two arbitrary quantities; and so the tables should be of triple entry a thing altogether unmanageable. Besides these, this volume contains a treatise on Eulerian integrals, and an appendix on spherical functions and on quadratures.

The third volume of the *Traité* contains three supplements to the theory of elliptic functions, dated 1828, 1829, 1832, embodying Legendre's acceptance of the discoveries made by Jacobi and Abel since the publication of the *Traité*.

220. It was owing to the strangeness of his subject that Legendre for more than twenty years found no fellow-worker in it. "After having employed myself for a great number of years," he says in the preface to the first supplement of the *Traité*, "with the theory of elliptic functions, of which the immortal Euler had laid the foundations, I thought I should collect the results of this long work in a treatise, and this I published in the month of January 1827. Up to that geometers had taken almost no part in this kind of researches; but hardly had my work seen the light, its name could hardly have become known to scientific foreigners!"



when I learned with equal surprise and satisfaction that two young geometers, M.M. Jacobi of Königsberg and Abel of Christiania, had succeeded by their own studies in perfecting considerably the theory of elliptic functions in its highest parts."

Abel and Jacobi have found out not only points of connexion for their works with Legendre's investigations, but have been able to adopt a set of methods and points of view from his *Traité*, on the basis of which they have constructed the mighty edifice of the theory of elliptic transcendents. This Jacobi himself subsequently fully recognized. On May 27, 1832, he writes to Legendre:—"In a note at the end of the eighth volume of M. Crelle, I have sought to extol the imperishable merits of the geometer who, besides the numerous and important discoveries with which he has enriched science, has effectually laid the foundations by the glorious labours of his life of two great and extended disciplines which shall henceforth form the  $\alpha$  and the  $\omega$  of every mathematical study. I have at the same time made use of this opportunity to speak of Abel and of his great theorem, which you again have the merit of having first penetrated, and of having shown to posterity that its development is the great task remaining for it to fulfil."

221. Before entering into the developments due to these two celebrated mathematicians we should make some mention of Gauss's labours in the same field. These were mostly found in incomplete sketches at the beginnings of different treatises, or as individual formulae scattered among his other works. The editor of his collected works has brought them together in the latter part of the third volume, and states that there is evidence that Gauss was acquainted with the relations between the arithmetic geometric mean and the series proceeding by square powers in the year 1794. This *arithmetic geometric mean* is defined in the paper "Determinatio attractionis" published in 1818, where he speaks of it as a peculiar and most expeditious algorithm which he fully for many years employed, and intended yet to treat of more fully.

Let  $m, n$  be two positive quantities, and put  $m' = \frac{1}{2}(m+n), n' = \sqrt{mn}$ , so that  $m'$  and  $n'$  may be their arithmetic and geometric mean, taking the latter always positive. Now take

$$m'' = \frac{1}{2}(m' + n'), n'' = \sqrt{m'n'},$$

$$m''' = \frac{1}{2}(m'' + n''), n''' = \sqrt{m''n''},$$

and so on. It may be seen that the series  $m, m', m'', m''',$  and  $n, n', n'', n''',$  &c., rapidly converge to a common limit, which we shall denote by  $\mu$ , and simply call the *arithmetic geometric mean* between  $m$  and  $n$ . Now we shall demonstrate that  $\frac{1}{\mu}$  is the value of the integral

$$\int \frac{d\tau}{2\pi\sqrt{m^2 \cos^2 \tau + n^2 \sin^2 \tau}},$$

taken  $\tau = 0$  to  $\tau = 360$ .

For suppose that the variable  $\tau$  is expressed by another  $\tau'$ , so that

$$\sin \tau = \frac{2m \sin \tau'}{(m+n) \cos^2 \tau' + 2m \sin^2 \tau'},$$

it will easily be seen that as  $\tau'$  increases from 0 to  $90^\circ, 180^\circ, 270^\circ, 360^\circ$ ,  $\tau$  also, though not uniformly, increases through the same range. But, effecting the substitution,

$$\frac{\tau}{\sqrt{(m^2 \cos^2 \tau + n^2 \sin^2 \tau)}} = \frac{d\tau'}{\sqrt{(m^2 \cos^2 \tau' + n^2 \sin^2 \tau')}},$$

accordingly the values of the integrals

$$\int \frac{d\tau}{2\pi\sqrt{(m^2 \cos^2 \tau + n^2 \sin^2 \tau)}} \int \frac{d\tau'}{2\pi\sqrt{(m^2 \cos^2 \tau' + n^2 \sin^2 \tau')}},$$

each taken from 0 to  $360^\circ$  are equal; and, since this may be carried on as far as we please, plainly they are also equal to the value of the integral

$$\int \frac{d\theta}{2\pi\sqrt{(\mu^2 \cos^2 \theta + \mu^2 \sin^2 \theta)}},$$

from  $\theta = 0$  to  $\theta = 360^\circ$ , which is plainly  $\frac{1}{\mu}$ .

222. N. H. Abel (1802-29) started in the summer of 1825 to pursue his studies abroad, chiefly at Paris. On his way he made the acquaintance in Berlin of A. L. Crelle, who had long conceived the project of founding a mathematical journal, but was decided to put this into execution by the importance of the numerous memoirs already prepared by Abel (as also by Steiner), who consented to their publication in it. The first number of the journal appeared during Abel's stay in Berlin, and each copy in the first four volumes contained papers by him. These and other published papers are reprinted in the first volume of his collected works (Christiania, 1839). The second volume contains mostly papers found after his death, nearly all in this volume having been written before Abel began his travels. These, therefore, first claim our attention after Legendre's independent investigations.

223. Elliptic integrals have hitherto occupied us. We have mentioned (§ 207) the problem of inversion which leads to elliptic functions, viz., that if  $u = F(\kappa, \phi)$ , then  $\phi = \text{am } u$ , and if

$$u = \int_0^x \frac{dr}{\sqrt{(1-r^2)(1-\kappa^2 r^2)}}, \text{ we have } x = \text{sn am } u.$$

Paper viii. (vol. ii.), is headed "Remarkable properties of the function determined by the equation

$$y y' dy - dx \{ (x-y)(x_1-y)(x_2-y) \dots (x_{m-1}-y) \}^2 = 0,$$

$f(y)$  being any function of  $y$  which does not become zero or infinite when  $y = a, a_1, a_2, \dots, a_{m-1}$ ." In it this problem of inversion of the more general (hyperelliptic) integral in which the square root contains a function of the degree  $m+1$  is attempted; and, though it has since been shown by Jacobi (*Crelle*, xiii.) that the inversion of hyperelliptic integrals is a different problem from what is here proposed, Abel at any rate in this short paper had established the existence of two periods for elliptic functions.

224. We saw in § 216 that Legendre, in comparing two elliptic integrals of the third kind, found a certain relation connecting with integrals of the first and second kinds two such integrals of the third kind, in which the argument and parameter are interchanged. This relation recurs to us in an extended form in the paper of Abel (ix., vol. ii.) "On a remarkable property of a very extended class of transcendental functions." Defining  $y$  or  $\psi$  by the differential equation  $y' f(x) + \frac{dy}{dx} \cdot \phi \psi = 0$ , where  $\phi x = a + a_1 x + a_2 x^2 + \dots$ , and  $f x = \beta + \beta_1 x + \beta_2 x^2 + \dots$ , he gets

$$\frac{1}{\psi u} \int \psi^y \cdot d\psi - \psi \cdot \phi \int \frac{d\psi}{(\psi - a) \phi \psi} = \psi u$$

$$= \Sigma (\lambda + 2) a_{m+\lambda+2} - \beta_{m+\lambda+1} \int \frac{u^m d\psi}{\phi \psi} - \int \psi^m \phi \psi d\psi,$$

the integrals in  $\psi$  being taken from a value of  $\psi$  which makes  $\psi \cdot \phi \psi$  vanish, and those in  $u$  from a value of  $u$  which destroys  $\frac{1}{\psi u}$ . When we put  $\psi = \frac{1}{\phi \psi}$  in this, it becomes the theorem for the interchange of argument and parameter for hyperelliptic integrals.

225. "The first works of Abel which attracted attention," writes his editor, "were his memoirs on the impossibility of the general resolution of algebraic equations higher than the fourth degree, and his researches on elliptic functions." Simultaneously with Abel, and without being acquainted with his works, M. Jacobi of Königsberg began to treat the theory of elliptic functions. Thus a rivalry exists between these two men of exalted genius in their treatises on these functions. Abel told me that during his stay at Paris in 1826 he had already completed the essential part of the principles he subsequently enunciated regarding these functions, and that he would have much wished to postpone the publication of his discoveries until he could compose a complete theory of them, had not in the meanwhile M. Jacobi entered the lists."

226. On October 24, 1826, Abel wrote from Paris:—"I have just finished a large treatise on a certain class of transcendental functions for presentation to the Institute, and that will take place next Monday. I dare without ostentation say it is a treatise which will give satisfaction. I am curious to hear the opinion of the Institute about it." He had not deceived himself in the significance and reach of this fundamental theorem; yet in the Academy judgment upon the work was deferred, so that Abel two years later (Jan. 6, 1829), felt himself called upon to send to Crelle the following, which appeared in the fourth volume of the *Journal (Works, i. p. 324)*.

227. "Demonstration of a general property of a certain class of transcendental functions.

"Theorem.—Let  $y$  be a function of  $x$  which satisfies any irreducible equation of the form

$$0 = p_0 + p_1 y + p_2 y^2 + \dots + p_{n-1} y^{n-1} + y^n \dots \quad (1),$$

where  $p_0, p_1, \dots, p_{n-1}$  are integer functions of the variable  $x$ . In like manner let  $z_0, z_1, \dots, z_{n-1}$  be integer functions of  $x$ , and

$$0 = z_0 + z_1 y + z_2 y^2 + \dots + z_{n-1} y^{n-1} \dots \quad (2)$$

a similar equation, and let us suppose the coefficients of the different powers of  $x$  in these functions variable. Let these be denoted by  $a, a', a'', \dots$ . By reason of the two equations (1) and (2),  $x$  will be a function of  $a, a', a'', \dots$ ; and we shall determine its values by eliminating  $y$ . Let us denote by

$$\rho = 0 \dots \dots \dots \quad (3)$$

the result of elimination, so that  $\rho$  will contain only the variables  $x, a, a', \dots$ . Let  $\mu$  be the degree of this equation in  $x$ , and let its  $\mu$  roots be

$$x_1, x_2, \dots, x_\mu \dots \dots \dots \quad (4),$$

which will be so many functions of  $a, a', a'', \dots$ .

"Now, if  $f(x, y)$  denote any rational function of  $x$  and  $y$ , and we make

$$\phi x = f(x, y) dx \dots \dots \dots \quad (5),$$



then the transcendental function  $\psi(x)$  will possess the general property expressed by the following equation—

$$\psi x_1 + \psi x_2 + \dots + \psi x_\mu = u + k_1 \log v_1 + k_2 \log v_2 + \dots + k_n \log v_n \dots (6),$$

$v, v_1, v_2, \dots, v_n$ , being rational functions of  $a, a', a'', \dots$  and  $k_1, k_2, \dots, k_n$ , constants.

“*Demonstration.*—To prove this theorem it is enough to express the first member of equation (6) as a function of  $a, a', a'', \&c.$ ; for thereby it will reduce to a rational differential, as we shall see.

“First, the two equations (1) and (2) will give  $y$  as a rational function of  $x, a, a', a'', \dots$ . Similarly the equation (3) will give for  $dx$  an expression of the form

$$dx = ada + a'da' + a''da'' + \&c.,$$

where  $a, a', a'', \dots$  are rational functions of  $x, a, a', a'', \&c.$  Hence it follows that the differential  $f(x, y)dx$  can be put under the form  $f(x, y)dx = \phi_1 x da + \phi_2 x da' + \phi_3 x da'' + \&c.$ , where  $\phi_1, \phi_2, \phi_3, \dots$  are rational functions of  $x, a, a', a'', \dots$ . Integrating, we get  $\psi x = \int (\phi_1 x da + \phi_2 x da' + \dots)$ ; and from this we conclude, since this equation holds when we put for  $x$  its  $\mu$  values,

$$\left. \begin{aligned} \psi x_1 + \psi x_2 + \dots + \psi x_\mu &= \int (\phi_1 x_1 + \phi_2 x_2 + \dots + \phi_\mu x_\mu) da \\ &+ \int (\phi_1 x_1 + \phi_2 x_2 + \dots + \phi_\mu x_\mu) da' + \&c. \end{aligned} \right\} (7).$$

“In this equation the coefficients of the differentials  $da, da', \&c.$ , are rational functions of  $a, a', a'', \dots$  and of  $x_1, x_2, \dots, x_\mu$ ; but they are besides symmetrical in  $x_1, x_2, \dots, x_\mu$ ; therefore, by a well-known theorem, they can be expressed rationally in terms of  $a, a', a'', \dots$  and the coefficients of the equation  $\rho = 0$ ; but these latter are themselves rational functions of the variables  $a, a', a'', \dots$  so that finally the coefficients of  $da, da', da'', \&c.$ , of equation (7) will be so too. Therefore, integrating, we have an equation of the form (6).

“I propose on another occasion to develop numerous applications of this theorem, which will throw a great light on the nature of the transcendental functions it deals with.”

228. Abel died of consumption, April 6, 1829, having been confined to bed nearly three months; and of the applications promised nothing appeared or has since been found in his remains. Moreover, except the note that he had presented the memoir to the Academy, which appears in the paper “On some general properties of a certain sort of transcendental functions” (*Works*, i. p. 288), Abel hardly seems to have expressly referred to it, though he mentioned the theorem (November 25, 1828, *Works*, ii. p. 258) to Legendre, adding that on this general property he had in fact founded the whole theory of elliptic functions.

229. But notwithstanding, his contemporaries were not slow to estimate the value of his analysis. The statement in *Crelle's Journal* revealed to Jacobi the entire significance of this “fundamental theorem of analysis,” and his admiration breaks forth to Legendre on the 14th March 1829:—“What a discovery of Abel's is that generalization of Euler's integral? But how does it happen that this discovery, perhaps the most important our century has made in mathematics, though communicated two years since to the Academy, has been able to escape the attention both of you and your fellow members?” To this question Legendre answers (April 8, 1829):—“I shall not close this letter without answering yours relative to M. Abel's beautiful paper, which was printed in the last number of *Crelle's Journal*, and which had been presented to the Academy by its author in the last months of 1826. M. Poisson was then president of the Academy. The committee named to examine the memoir were M. Cauchy and myself. We perceived that the memoir was almost illegible; it was written with very faint ink, the characters badly formed; it was agreed on that we should ask the author for a better copy, and one easier to be read. So things remained. M. Cauchy kept the manuscript up to this without doing anything further about it. The author, M. Abel, appears to have gone away without caring what became of his memoir. He furnished no copy, and no report was made. However, I have asked M. Cauchy to give me the manuscript, which never was in my hands, and I shall see what there is to be done, to make up, if possible, for the little attention he bestowed on a production which no doubt deserved a better fate.”

230. The third and last supplement of Legendre to his great work is dated March 4, 1832, and concludes as follows:—“Here we shall terminate the additions we proposed to make to our work, taking advantage of the recent discoveries of MM. Abel and Jacobi in the theory of elliptic functions. It will be remarked that the most important of these additions consists in the new branch of analysis we have deduced from the theorem of M. Abel, and which had hitherto remained quite unknown to geometers. This branch of analysis, to which we have given the name ‘theory of ultra-elliptic functions,’ is of infinitely greater extent than that of elliptic functions, with which it has very intimate relations; it is composed of an indefinite number of classes, each of which divides into three kinds, as do elliptic functions, having besides a great number of properties. We have only been able to glance at this matter, but

no doubt it will be gradually enriched by the labours of geometers, and at length will form one of the finest parts of the analysis of transcendents.” At nearly the same time Legendre wrote to Crelle:—“The work, so far as I am concerned, has given me the profound satisfaction of rendering conspicuous homage to the genius of M. Abel, in making felt all the merit of the beautiful theorem which was his discovery, and which may be characterized as *Monumentum ære perennius*.” In his remarks on this third supplement of Legendre (*Crelle*, viii.) occur the notable words of Jacobi:—“We hold it (the Abelian theorem) to be the greatest mathematical discovery of our time, although it remains for a future, perhaps long distant, work to manifest its whole significance.”

231. The name which Jacobi thus applied, the Abelian theorem, has since adhered, and the functions to which it refers have been called Abelian functions, the term hyper- or ultra-elliptic having been restricted to that particular class in which the square root of a polynomial is the only irrational quantity introduced; while Abelian functions may depend on any irrationality. The neglected paper of Abel appeared in the *Memoirs of the Institute* in 1841.

232. But, though the Abelian theorem was thus published during its author's stay in Paris, his labours in other departments of the theory of transcendents suffered no intermission. In December 1826 he writes—“I have written a large memoir on elliptic functions which contains much that is curious, and which I flatter myself will not fail to fix the attention of the literary world. Amongst other things it treats of the division of the arc of the lemniscate. I have found that with rule and compass the lemniscate can be divided into  $2^n + 1$  equal parts, when this number  $2^n + 1$  is prime. The division depends on an equation of the degree  $(2^n + 1)^2 - 1$ , but I have found its complete solution by means of square roots. This has revealed to me at the same time the mystery in which Mr Gauss's theory of the division of the circumference of the circle has been wrapped up. I see clearly how he arrived at it,” referring to the last section of the *Disquisitiones Arithmeticæ* of Gauss, published in 1801.

233. C. G. J. Jacobi (born Dec. 10, 1804, died Feb. 18, 1851) appeared first as a discoverer in connexion with our subject in the “Extracts of two letters to the editor,” published in September 1827 in the *Astronomische Nachrichten* of Schumacher, and reprinted at the beginning of the collected *Works*, 1881. We have seen that Legendre discerned the vast importance of the relations which he called Landen's transformation, and discovered with increased wonder the further transformation of the third order, which became public in January of this same year 1827 in the *Traité*. But in his first letter Jacobi states: “The integrals of the form  $\int \frac{d\phi}{\sqrt{1 - c^2 \sin^2 \phi}}$  for different moduli  $c$ , belong to different

transcendents. Only one system of moduli is known for which they reduce into one another, and M. Legendre in his *Exercices* says even that there is only this one. But in fact there are as many of these systems as there are prime numbers, that is to say, there is an infinite number of these systems, all independent, each answering to a prime number; the system heretofore known answers to the prime number 2.”

This is already, without proof, a statement of the general theorem of transformation of elliptic integrals of the first kind. If  $U$  be a certain odd function of  $\sin \psi$  of any degree  $n$ , and  $V$  a certain even function of  $\sin \psi$  of degree  $n - 1$ , then, putting  $\sin \phi = \frac{U}{V}$ , the coefficients of these functions may be determined so as to satisfy

$$\int \frac{d\phi}{\sqrt{1 - c^2 \sin^2 \phi}} = m \int \frac{d\psi}{\sqrt{1 - k^2 \sin^2 \psi}}; \text{ and each of these substitutions gives a new system of moduli.}$$

Further, Jacobi notices that  $\sin \psi$  can be in an almost analogous manner expressed by  $\sin \theta$ , so as by composition of the two integral equations to satisfy the relation

$$\int \frac{d\phi}{\sqrt{1 - c^2 \sin^2 \phi}} = n \int \frac{d\theta}{\sqrt{1 - c'^2 \sin^2 \theta}}.$$

Thus the substitution which serves to give  $n$  times the transcendental can be divided into two of a simpler nature, and this substitution gives  $\sin \phi$  expressed by a fraction whose numerator contains the odd powers of  $\sin \theta$  up to  $n^2$ , and its denominator the even powers of it up to  $n^2 - 1$ .

Without giving the general proof, the transformations of the third and of the fifth degrees are here actually effected, and connected with multiplication and division for the numbers 3 and 5; and thus for the first time the algebraic solution of the equation of the ninth degree which trisects the transcendental is given.

234. Legendre could not at first believe in the existence of an algebraic transformation belonging to any arbitrary degree, and thought Jacobi trusted to mere induction. But he soon admitted the profundity and rigour of Jacobi's analysis on receiving from him a letter, dated Aug. 5, 1827, in which it is stated that, if  $\rho$  be any odd number, we can by a rational substitution,

$$w = \frac{z(A + A'z^2 + \dots + A''z^{p-1})}{B + B'z^2 + \dots + B''z^{p-1}}$$

arrive at the equation

$$\frac{dz}{\sqrt{(1-z^2)(1-\kappa^2z^2)}} = p \frac{dz}{\sqrt{(1-z^2)(1-\kappa'^2z^2)}}$$

Moreover, this substitution can be replaced by two in succession,

$$x = \frac{y(a + a'y^2 + \dots + a''y^{p-1})}{b + b'y^2 + \dots + b''y^{p-1}}, \quad y = \frac{z(a + a'z^2 + \dots + a''z^{p-1})}{\beta + \beta'z^2 + \dots + \beta''z^{p-1}}$$

the first substitution transforming the elliptic function into another of different modulus, so that

$$\frac{dx}{\sqrt{(1-x^2)(1-\kappa^2x^2)}} = \frac{Mdy}{\sqrt{(1-y^2)(1-\lambda^2y^2)}}$$

and the second returning to the original

$$\frac{dy}{\sqrt{(1-y^2)(1-\lambda^2y^2)}} = p \frac{dz}{M \sqrt{(1-z^2)(1-\kappa'^2z^2)}}$$

Now, giving  $p$  different values, we see that each given modulus is one in an infinite scale of moduli into which it may be transformed by an algebraic and even rational substitution. This letter, moreover, contained the two theorems giving the general formula in a trigonometric form.

235. Subsequently Jacobi, on January 12, 1828, brought under the notice of Legendre the works of Abel on elliptic functions, which Crelle had published,—but in his own notation. Abel, he says, begins with the analytic expression of all the roots of the equations of higher degrees on which the division of elliptic functions depends. Taking  $\sin \phi = i \tan \psi$ , where  $i = \sqrt{-1}$ , and

$$\frac{d\phi}{\sqrt{1-\kappa^2 \sin^2 \phi}} = \xi,$$

we have, if  $\kappa'$  be the complement of  $\kappa$ ,

$$\frac{d\phi}{\sqrt{1-\kappa^2 \sin^2 \phi}} = \frac{id\psi}{\sqrt{1-\kappa'^2 \sin^2 \psi}}$$

whence

$$\sin \operatorname{am} (i\xi, \kappa) = i \tan \operatorname{am} (\xi, \kappa'),$$

which is a "fundamental theorem of M. Abel."

Further, we have in general  $\sin \operatorname{am} (\xi + 4mK + 4m'iK') = \sin \operatorname{am} \xi$ , where  $m$  and  $m'$  are positive or negative integers, and  $K$  is the complete function

$$\int_0^{\frac{\pi}{2}} \frac{d\phi}{\sqrt{1-\kappa^2 \sin^2 \phi}},$$

and  $K'$  the complete function corresponding to  $\kappa'$ .

We see then that the roots of this higher equation for dividing the elliptic function  $\xi$  into  $n$  parts will be of the form

$$\sin \operatorname{am} \frac{\xi + 4mK + 4m'iK'}{n};$$

a formula which involves as many as  $n^2$  roots, if we make  $m, m'$  successively take the values  $0, 1, 2, \dots, n-1$ .

Abel next reduces the division of any elliptic function  $\xi$  to the division of the complete function  $K$ . In fact, if  $\alpha, \beta$  be any roots of  $x^n = 1$ , the expression  $(\sum \alpha^n \beta^{m'} \sin \operatorname{am} \frac{\xi + 4mK + 4m'iK'}{n})^n$ , giving  $m, m'$  all the values  $0, 1, 2, \dots, n-1$ , will not change if we put instead of  $\sin \operatorname{am} \frac{\xi}{n}$  any other root,  $\sin \operatorname{am} \frac{\xi + 4\mu K + 4\mu'iK'}{n}$ ; it will

thus be symmetrical in these roots, and may therefore be expressed by  $\sin \operatorname{am} \xi$ , and by constant but irrational quantities of the form  $\sin \operatorname{am} \frac{4mK + 4m'iK'}{n}$ .

Now giving  $\alpha, \beta$  all possible values produces  $n^2$  combinations, and thereby the values of all the roots. The division of the complete function, which depends in general on an equation of the  $\frac{1}{2}(n^2-1)$  degree, is reduced to one of the  $n+1$  degree,  $n$  being a prime number. For if  $\omega = \frac{4\mu K + 4\mu'iK'}{n}$ , and  $g$  be a primitive root

of the congruence  $x^{n-1} \equiv 1 \pmod{n}$ , also  $\phi(\omega)$  any trigonometric function of the amplitude of  $\omega$ , and  $\alpha$  a root of  $x^{n-1} = 1$ , we attain this by considering the expression

$$[\phi(\omega) + \alpha\phi(g\omega) + \alpha^2\phi(g^2\omega) + \dots + \alpha^{n-2}\phi(g^{n-2}\omega)]^{n-1}$$

which is symmetrical in

$$\phi(\omega), \phi(g\omega), \phi(g^2\omega), \dots, \phi(g^{n-2}\omega).$$

But symmetric functions of these quantities can only have  $n+1$  different values, answering to  $\mu=0, \mu'=1; \mu=1, \mu'=0; \mu=1, \mu'=1, 2, 3, \dots, n-1$ . So they will be determined by an algebraic equation of the degree  $n+1$ .

In conclusion, Jacobi mentions researches of his own, which led him to the conclusion that if a modulus  $\kappa$  can be transformed into another  $\lambda$ , they are connected by an algebraic equation of the degree

$n+1$ , if the transformation be of the order of the number  $n$ , supposed prime. These symmetric equations are, for  $n=3$  and  $5$ ,  $u^4 - v^4 \pm 2uv(1-u^2v^2) = 0$ ,  $u^6 - v^6 + 5u^2v^2(u^2-v^2) \pm 4uv(1-u^4v^4) = 0$ , putting  $u = \sqrt[3]{\kappa}, v = \sqrt[3]{\lambda}$ .

These equations he names *modular equations*, and notices as remarkable that they have their simplest forms when expressed in the fourth roots of the moduli. He also gives the differential equation of the third degree which all these algebraic equations satisfy, viz.,

$$3(d\kappa^2 d\lambda^2 - d\lambda^2 d\kappa^2) - 2d\kappa d\lambda (d\kappa d^3\lambda - d\lambda d^3\kappa) + d\kappa^2 d\lambda^2 \left[ \left( \frac{1+\kappa^2}{\kappa-\kappa^2} \right)^2 d\kappa^2 - \left( \frac{1+\lambda^2}{\lambda-\lambda^2} \right)^2 d\lambda^2 \right] = 0.$$

Moreover, in some cases the same modulus reappears, and the transformation becomes multiplication. This takes place in all cases when  $n$  is the sum of two squares,  $n = a^2 + 4b^2$ ,  $\kappa$  being  $\sqrt{\frac{a+bi}{a-bi}}$ , and the elliptic function becomes multiplied by  $a \pm 2bi$ . Similarly with all moduli which are connected by any scale with  $\kappa = \sqrt{\frac{a+bi}{a-bi}}$ , a kind of multiplication not having an analogue in circular arcs.

236. In answer to a request of Legendre that he would furnish him with the clue to his discoveries, Jacobi wrote, April 12, 1828:—"Having found (March 1827) the equation

$$\frac{T}{M} = V \frac{dU}{dx} - U \frac{dV}{dx},$$

I recognized that for any number,  $n$ , transformation was a *determinate* problem of algebraic analysis, the number of arbitrary constants being always equal to that of conditions. By indeterminate coefficients I formed the transformations for the numbers 3 and 5. The biquadratic equation to which the former led me having nearly the same form as that which serves for trisection, I began to suspect some relation. Fortunately I happened to remark in these two cases the other transformation complementary to multiplication. At this stage I wrote my first letter to M. Schumacher, the method being general and verified by examples. Subsequently, examining more closely the two substitutions  $z = \frac{ay+by^3}{1+cy^2}$ ,  $y = \frac{ax+bx^3}{1+cx^2}$  under the form presented in my first letter, I saw that when we put  $x = \sin \operatorname{am} \frac{2K}{3}$ ,  $z$  must vanish, and, as in the said form  $\frac{b}{a}$  was positive, I then concluded that  $y$  must vanish also. In this manner I found by induction the resolution into factors, which being confirmed by examples, I gave the general theorem in my second letter. Having remarked the equation  $\sin \operatorname{am} (i\xi, \kappa) = i \tan \operatorname{am} (\xi, \kappa')$ , I next drew from it the transformation from  $\kappa'$  to  $\lambda'$ . I had then two different transformations, one from  $\kappa$  to a smaller modulus  $\lambda$ , the other from  $\kappa'$  to a larger one  $\lambda'$ . Thence I conjectured that exchanging *inter se*  $\kappa'$  and  $\lambda$ ,  $\kappa$  and  $\lambda'$ , the analytic expression of the complementary transformation would be got. The demonstrations were found only subsequently."

237. Equally interesting is Legendre's reply (June 16, 1828):—"As to what you told me of the train of ideas which led you to your beautiful discoveries on elliptic functions, I see that we have both run some risks,—you in announcing discoveries not yet invested with the seal of a rigorous demonstration, and I in publicly and unrestrictedly giving them my full and entire approbation. We have neither of us to repent of what we have done. . . I saw very clearly that results such as these you had obtained could be no effect of chance or of a faulty induction, but only of a profound theory based upon the nature of things."

238. Of Gauss's investigations in this branch of mathematics Jacobi makes mention in his first letter to Legendre (August 5, 1827). These researches "are not the only ones which have been undertaken in Germany in the same subject. M. Gauss having heard of them let me know that he had developed as far back as 1808 the cases of division into 3, 5, and 7 parts, and found at the same time the new scales of moduli referring to them." Again, April 12, 1828:—"As to M. Gauss, he has not yet published anything in elliptic functions, but it is certain he has made beautiful discoveries. If he has been anticipated and perhaps surpassed, it is a penalty due to the veil of mystery he has spread over his works. I am not personally acquainted with him, as I studied philology at Berlin, where there are no distinguished geometers." Legendre, however, cannot believe that discoveries of such reach can be left unpublished, as was actually the case with Gauss. "If M. Gauss," Legendre writes to Jacobi, April 14, 1828, "had fallen upon such discoveries, which in my eyes surpass all hitherto done in analysis, most assuredly he would have lost no time in publishing them."

239. Simultaneously with the announcements of Jacobi just mentioned there appeared in September 1827, in *Crelle*, the first part of Abel's "Recherches sur les fonctions elliptiques," and accompanying the second part (Feb. 12, 1828) a statement that, "having finished the preceding memoir on elliptic functions, a note on the same functions by Mr C. G. J. Jacobi, inserted in No. 123 of M. Schumacher's *Nachricht'n*, has reached me. M. Jacobi gives



following theorem. . . This elegant theorem, which M. Jacobi gives without demonstration, is contained as a particular case in formula 227 of the foregoing memoir (which is the formula of § 246 *infra*), and is fundamentally the same as that of formula 270." This he proceeds to show.

240. The "Recherches" present a great and complete theory of elliptic transcendents. Starting with the inverse function  $\phi(a)$  as that determined by  $a = \int \frac{dx}{\sqrt{1-c^2 \sin^2 \theta}}$  and  $\sin \theta = \phi a = x$ , which by

$$d\theta \sqrt{1 - \sin^2 \theta} = d\phi a = dx \text{ gives } a = \int_0^x \frac{dx}{\sqrt{(1-x^2)(1-c^2 x^2)}}, \text{ Abel noticed}$$

that the formulæ become simpler by supposing  $c^2$  negative =  $-c^2$ , and for symmetry writes  $1 - c^2 x^2$  instead of  $1 - x^2$ , so that the function  $\phi a = x$  will be given by the equation

$$a = \int_0^x \frac{dx}{\sqrt{(1-c^2 x^2)(1+c^2 x^2)}}$$

or by

$$\phi a = \sqrt{(1-c^2 \phi^2 a)(1+c^2 \phi^2 a)},$$

and for brevity two other functions  $f a = \sqrt{1-c^2 \phi^2 a}$ ,  $F a = \sqrt{1+c^2 \phi^2 a}$  are introduced.

After establishing the double periodicity, and determining the zero and infinite values of these functions, Abel proceeds to the development of the formulæ of multiplication to determine  $\phi(na)$ ,  $f(na)$ ,  $F(na)$  in rational functions of  $\phi(a)$ ,  $f(a)$ ,  $F(a)$ .

He next enters on the solution of the more difficult problem of the division of elliptic functions, which is the principal object of the memoir, Abel proves the algebraic expressibility of the functions  $\phi\left(\frac{a}{2n+1}\right)$ ,  $f\left(\frac{a}{2n+1}\right)$ ,  $F\left(\frac{a}{2n+1}\right)$  as functions of  $\phi(a)$ ,  $f(a)$ ,  $F(a)$  in the form

$$\phi(\beta) = \frac{1}{2n+1} \left\{ \phi_1(\beta) + \left( C_1 + \sqrt{C_1^2 - D_1^{2n+1}} \right)^{\frac{1}{2n+1}} + \dots + \left( C_{2n} + \sqrt{C_{2n}^2 - D_{2n}^{2n+1}} \right)^{\frac{1}{2n+1}} \right\},$$

in which

$$\phi_1 \beta = \phi(2n+1)\beta + \frac{1}{2n+1} \left\{ \left( A_1 + \sqrt{A_1^2 - B_1^{2n+1}} \right)^{\frac{1}{2n+1}} + \left( A_2 + \sqrt{A_2^2 - B_2^{2n+1}} \right)^{\frac{1}{2n+1}} + \dots + \left( A_{2n} + \sqrt{A_{2n}^2 - B_{2n}^{2n+1}} \right)^{\frac{1}{2n+1}} \right\}$$

and the quantities C, D are rational functions of  $\phi_1(\beta)$ , while the quantities A, B are similar functions of  $\phi(2n+1)\beta$ . Thus these equations give  $\phi(\beta)$  algebraically expressed by  $\phi_1(\beta)$ , and then  $\phi_1(\beta)$  algebraically by  $\phi(2n+1)\beta$ . So, replacing  $\beta$  by  $\frac{a}{2n+1}$ , we get  $\phi\left(\frac{a}{2n+1}\right)$  as an algebraic function of  $\phi a$ ; and similarly for  $f$  and  $F$ .

241. The priority of this beautiful discovery Jacobi ascribes unconditionally to Abel. To Legendre he writes (March 14, 1829).—"You suppose I have found means of expressing algebraically trigonometric functions of the amplitudes you denote by  $a_n$ , adding that without that my formula would contain coefficients I could not determine. But that is quite impossible in the general case, and is done only for special values of the modulus. My formula, which gives the algebraic expression for  $\sin am u$  by means of  $\sin am nu$ , supposes known the section of the complete function. In this manner, for more than a century, the division of an arc of a circle could be solved algebraically, supposing known that of the complete circumference, this latter having been given generally only in these later times by the works of M. Gauss. . . You see then that M. Abel has proved this important theorem, as you call it, in his first memoir on elliptic functions, although he has not dealt in it with transformation, and does not appear even to have thought when he wrote that his formulæ and theorems would find such an application. The transformed modulus, or, which amounts to the same thing, the regulator, being supposed known, it is still necessary to resolve an equation of degree  $\frac{1}{2}(n-1)$  to arrive at the quantities  $\sin^2 am(2\omega)$ , or at the section of the complete function. Thus you had only to solve a quadratic in the case of  $n=5$ . M. Abel proved that M. Gauss's method applies nearly word for word to the solution of these equations, so that it is only the modular equations that we are unable to solve algebraically."

242. Starting from the solution of the problem of multiplication and division,  $\phi(2n+1)\beta$  is exhibited by Abel as the quotient of two double products, the factors of which depend linearly on  $\phi(\beta)$ . Thence, putting  $\beta = \frac{a}{2n+1}$ , and  $n = \infty$ , the development of the inverse function  $\phi(a)$  is derived in double products and double sums, the factors of which are linear in  $a$ ; accordingly a unique analytic expression is found for the function heretofore defined only by its properties. The reduction of the double products and double sums

to simple products and simple sums, the product development and breaking up into partial fractions of the elliptic functions, follow then without further difficulties.

243. With the publication of the "Recherches" Abel clears at one bound the limits of the investigations of Jacobi hitherto published, though the first part devotes no attention to the problem of transformation of elliptic integrals. Moreover, this work drew from Gauss the remark:—"M. Abel has anticipated me at least in a third part. He has just trodden precisely the same path I went along in 1798. And so I am not at all astonished at his arriving, for the most part, at the same results. Besides, as in his deduction he has displayed so much sagacity, penetration, and elegance, I feel myself by it relieved from the publication of my own researches."

244. The same volume of *Crelle* contains, besides the first part of the "Recherches," indications in the paper "Problems and Theorems" that Abel was at the time in possession, not only of the theory of rational transformation which Jacobi treated, but of the general algebraic transformation, as has been made manifest subsequently in his collected works.

245. Before Jacobi had read the "Recherches" he published a proof of the general theorem of rational transformation in No. 127 of Schumacher's *Nachrichten*, December 1827. It is based on enumeration of the constants available, and fixing the conditions in order that the substitution  $y = \frac{U}{V}$  may satisfy the differential equation

$$\frac{dy}{\sqrt{(1-\alpha y)(1-\alpha' y)(1-\alpha'' y)(1-\alpha''' y)}} = \frac{dx}{M\sqrt{(1-\beta x)(1-\beta' x)(1-\beta'' x)(1-\beta''' x)}}$$

He introduces the unique inverse function which he calls sine of the amplitude,  $\sin am$ , and gives the value of

$$1-y = \frac{(1 \mp x) \left( 1 \pm \frac{x}{\sin \text{coam} \frac{2K}{2n+1}} \right)^2 \dots \left( 1 - \frac{x}{\sin \text{coam} \frac{2nK}{2n+1}} \right)^2}{\left( 1 - \kappa^2 x^2 \sin^2 am \frac{2K}{2n+1} \right) \dots \left( 1 - \kappa^2 x^2 \sin^2 am \frac{2nK}{2n+1} \right)}$$

as satisfying the differential equation (M being constant)

$$\frac{dx}{\sqrt{(1-x^2)(1-\kappa^2 x^2)}} = M \frac{dy}{\sqrt{(1-y^2)(1-\lambda^2 y^2)}}$$

The value of  $y$  is derived from this, and Jacobi remarks that this theorem holds generally, but does not embrace all the solutions of the problem.

246. The second part of the "Recherches" was finished by Abel February 12, 1828, and appeared immediately in *Crelle*. The first problem treated is the algebraic expressibility of the function  $\phi\left(\frac{a}{n}\right)$ , when certain relations, as for the lemniscate, hold between  $c$  and  $c$ . The principal application of this is the expression of the function by square roots whenever  $n$  is of the form  $2^n$  or  $1+2^n$ , the latter being prime. He then proceeds to deal with the general treatment of rational transformation, which he presents in the following form.

If  $a$  be  $\frac{(m+\mu)\omega + (m-\mu)\varpi i}{2n+1}$ , where at least one of the integers

$m$  and  $\mu$  is prime to  $2n+1$ , we shall have

$$\int \frac{dy}{\sqrt{[(1-c_1^2 y^2)(1+c_1^2 y^2)]^n}} = a \int \frac{dx}{\sqrt{[(1-c^2 x^2)(1+c^2 x^2)]^n}},$$

where

$$y = f \cdot x \cdot \frac{(\phi^2 a - x^2)(\phi^2 2a - x^2) \dots (\phi^2 n a - x^2)}{(1+c^2 \phi^2 \phi^2 a \cdot x^2)(1+c^2 \phi^2 \phi^2 2a \cdot x^2) \dots (1+c^2 \phi^2 \phi^2 n a \cdot x^2)},$$

$$\frac{1}{c_1} = \frac{f}{c} \left[ \phi\left(\frac{\omega}{2} + a\right) \cdot \phi\left(\frac{\omega}{2} + 2a\right) \dots \phi\left(\frac{\omega}{2} + na\right) \right]^2,$$

$$\frac{1}{c_1} = \frac{f}{c} \left[ \phi\left(\frac{\varpi i}{2} + a\right) \cdot \phi\left(\frac{\varpi i}{2} + 2a\right) \dots \phi\left(\frac{\varpi i}{2} + na\right) \right]^2,$$

$$a = f(\phi a \cdot \phi 2a \cdot \phi 3a \dots \phi na)^2,$$

$f$  being an indeterminate, so that there only exists a single relation between the quantities  $c_1, c_1, c, c$ . The section concludes with the words—"To have a complete theory of the transformation of elliptic functions, it would be necessary to know all the transformations possible; now I have succeeded in demonstrating that they are all got by combining that of M. Legendre with those contained in the above formula, even when we are looking for the most general relation between any number of elliptic functions. This theorem, the consequences of which embrace nearly the whole theory of elliptic functions, has led me to a very great number of fine properties of them."

247. The same number of *Crelle* contained, in an extract from a letter by Jacobi, "Note sur les fonctions elliptiques," the exhibition of  $\sin am$  as the quotient of two series  $\Theta$  and  $H$ , or as they



were subsequently called the  $\theta$  and  $\theta_1$  functions: also appended to this, the development of  $\sqrt{\frac{2K}{\pi}}$  by powers of  $q = e^{-\frac{\pi K'}{K}}$ , the exponents of which are the squares of the natural numbers; as also the very important development of  $\sqrt{k}$  as quotient of two series proceeding by square powers of  $q$  and  $q^4$ —results whose importance was at once accepted by Legendre. Regarding the result in this paper, that to a given modulus for a prime degree of transformation  $n$  there always correspond  $n+1$  other transformed moduli got by

putting  $q^n, q^{n^2}, \dots, aq^{n^2}, \dots, a^{n-1}q^n$  for  $q$ , where  $a^n=1$ , Jacobi remarks, "Thus M. Abel will see that imaginary transformations had not escaped me."

248. Jacobi's well-known construction for the addition and multiplication of elliptic functions by the arcs determined on a circle by the vertices of an inscribed polygon, whose sides touch other circles coaxial with it (or, as he entitled it, application of elliptic transcendents to a known problem of elementary geometry—to find the relation between the distance of the centres and the radii of two circles, one inscribed in, and the other circumscribed to, an irregular polygon), is of about the same date, April 1, 1828.

Immediately afterwards, Jacobi, still ignorant of the second part of Abel's "Recherches," communicates to Legendre (April 12, 1828), the forms of development detailed in the work we have just spoken of for the sin am, for the modulus of the integral, and for the period  $K$ , and notices that these formulæ will not be without interest for the celebrated geometers who are engaged with the motion of heat,—numerators and denominators of the fractions by which the trigonometric functions of the amplitude have been expressed being often met with in that question.

249. Abel sought to generalize the problem of transformation, in the publication of which he was anticipated by Jacobi.

"We may regard this theory" he says (May 27, 1828), "from a much more general point of view, proposing as a problem of indeterminate analysis to find all possible transformations of an elliptic function which can be effected in a certain manner. I have attained the complete resolution of a great number of problems of this kind,—among them the following:—To find all possible cases in which we can satisfy the differential equation

$$\sqrt{(1-c_1^2y^2)(1-c_2^2y^2)} = \pm a \sqrt{(1-c^2x^2)(1-c'^2x^2)} \dots \dots (1)$$

by putting for  $y$  an algebraic function of  $x$ , rational or irrational. This problem may be reduced to the case that  $y$  is rational. For we can show that, if (1) holds for an irrational value of  $y$ , we can always deduce from it another of the same form in which  $y$  is rational by suitably changing the coefficient  $a$ ,—the quantities  $c_1, c_2, c, c'$  remaining the same. The first method which presents itself for resolving this problem when  $y$  is rational is that of undetermined coefficients. But this is a very fatiguing process. The following, I believe, deserves the attention of geometers, leading as it does to a complete solution in the simplest manner."

The theorem of the reducibility of the general problem of transformation to the rational is, however, stated without proof in this paper, but the problem of rational transformation, based on considerations of periods for the original and transformed elliptic function, is strictly treated. It is shown to resolve into simpler analogous problems whenever the number characteristic of the transformation is a compound one, and the equation of transformation itself is stated to be algebraically soluble. Lastly, Abel enters more closely into the case of equality of the transformed moduli of the integrals (viz.,  $c_1=c, c_2=c$ ), which has subsequently constituted the theory of the complex multiplication of elliptic functions. The multiplier  $a$  of the transformation is found in the necessary form  $\mu' + \sqrt{-\mu}$ , where  $\mu'$  and  $\mu$  signify two rational numbers, of which the latter must be essentially positive; and Abel adds—"If we attribute to  $a$  such a value, we can find an infinity of different values of  $c$  and  $c'$  which render the problem possible. All these values are expressible by radicals." Regarding the subject of this paper, Jacobi remarks to Legendre (June 14, 1829), "Abel's principal merit in the theory of transformation consists in his demonstration that ~~the~~ formulæ embrace all possible algebraic substitutions, and this gives a high degree of perfection to this theory."

250. In the "Suite des notices sur les fonctions elliptiques," dated July 21, 1828 (*Crelle*, vol. iii.), Jacobi introduces his functions  $\Theta$  and  $\Pi$  as independent fundamental functions on which to base the theory of elliptic transcendents; a conception to which also Abel was simultaneously led, and which he gave utterance to in writing to Legendre, Nov. 25, 1828:—"The theory of elliptic functions has led me to consider two new functions which enjoy several remarkable properties." Abel desired, quite in analogy with Jacobi's principle, to treat of the properties of these new transcendents apart from the inverse function of the elliptic integral, but the priority of publication of this discovery is Jacobi's, since the completion of the second part of the "Précis d'une théorie des

fonctions elliptiques," which was to contain all these investigations, was interrupted by Abel's unexpected death.

The above-mentioned work by Jacobi next contains the theorems expressing elliptic integrals of second and third kinds by  $\theta$  functions. Regarding the formula of reduction of the integral of the third kind by aid of the  $\theta$  functions, Jacobi remarks a characteristic property to Legendre (September 9, 1828):—"Moreover it shows that elliptic functions of the third kind into which three variables enter reduce to other transcendents which contain only two,"—a discovery which Legendre was greatly interested in, though he found difficulties in the distinction of real and imaginary parameters, expecting that the introduction of an imaginary parameter involved three independent quantities in the integral, and so there should be four kinds of elliptic functions instead of three.

Jacobi, however, repeats the above assertion in his demonstration of the relation  $\Pi(u, a) = uZ(a) + \frac{1}{2} \log \frac{\Theta(u-a)}{\Theta(u+a)}$  (*Crelle*, iv.):—"This

latter formula shows that elliptic functions of the third kind which depend on three elements can be reduced to other transcendents which contain only two." Later, Jacobi wrote to Legendre (May 23, 1829):—"As regards elliptic integrals of the third kind with circular parameter, they do not admit of a reduction analogous to that of the logarithmic kind. In a general analytical sense not distinguishing between real and imaginary values, a formula embraces all cases; but in applying to numerical calculation cases must be distinguished." And again, "as to the numerical calculation of elliptic integrals of the third kind with circular parameter, I do not think you should too much regret the inconvenience that they cannot be reduced to tables of double entry."

251. The collected statement of his investigations, published by Jacobi as his *Fundamenta nova Theoriæ Functionum Ellipticarum* in 1829, contains two main divisions, the first on the transformation of elliptic functions, the second on their evolution. We have already indicated many of the principles contained in this work, the most important of all being that of the double periodicity of these functions. As Jacobi says (*Works*, i. p. 262):—"Elliptic functions differ essentially from ordinary transcendents. They have, so to say, an absolute manner of existence. Their principal character is to embrace all there is in analysis that is periodical. In fact, trigonometric functions having a real period, exponentials an imaginary period, elliptic functions embrace the two cases, since we have at the same time  $\sin \operatorname{am}(u+4K) = \sin \operatorname{am} u$ ,  $\sin \operatorname{am}(u+2iK') = \sin \operatorname{am} u$ . Moreover it is easily demonstrated that an analytic function cannot have more than two periods, one real and the other imaginary, or both imaginary (complex) if the modulus  $k$  be so too. The quotient  $\frac{K'}{K}$  of

the periods of a proposed function determines the modulus of the elliptic functions by which it must be expressed by means of the

$$\text{relations } \sqrt{\frac{2K}{\pi}} = \Theta\left(\frac{\pi}{2}\right), \sqrt{\frac{2K'K}{\pi}} = \Theta(0), \sqrt{\frac{2kK}{\pi}} = H\left(\frac{\pi}{2}\right),$$

(the expansions for which in terms of  $q$  follow by § 258). Perhaps it will be convenient to introduce this quotient  $\frac{K'}{K}$  into analysis as modulus in place of  $k$ ." On these principles Jacobi subsequently founded a theory of hyperelliptic functions.

252. Jacobi's first evolution of elliptic functions is into infinite products, and is derived from the transformation from  $\lambda$  to  $k$ , which is expressed by  $\sin \operatorname{am}(nu, k)$

$$= \sqrt{\frac{\lambda^n}{k}} \sin \operatorname{am} \frac{u}{M} \sin \operatorname{am} \left( \frac{u}{M} + \frac{4iA'}{n} \right) \sin \operatorname{am} \left( \frac{u}{M} + \frac{8iA'}{n} \right) \dots$$

$$\sin \operatorname{am} \left( \frac{u}{M} + \frac{4(n-1)A'}{n} \right), \text{ and equivalent forms, by writing in the}$$

equations of transformation, for  $u, \frac{u}{n}$ , and allowing  $n$  to take an infinitely great value. When this is done,  $\operatorname{am} \left( \frac{u}{M}, \lambda \right)$  becomes

$$\operatorname{am} \left( \frac{u}{nM}, \lambda \right) = \frac{\pi u}{2k} = \epsilon, \text{ and he arrives at the equations}$$

$$\sin \operatorname{am} \frac{2Kx}{\pi} = \frac{2q^{\frac{1}{2}}}{\sqrt{k}} \sin x \frac{(1-2q^2 \cos 2x + q^4)(1-2q^4 \cos 2x + q^8) \dots}{(1-2q \cos 2x + q^2)(1-2q^3 \cos 2x + q^6) \dots},$$

$$\cos \operatorname{am} \frac{2Kx}{\pi} = 2q^{\frac{1}{2}} \sqrt{k} \cos x \frac{(1+2q^2 \cos 2x + q^4)(1+2q^4 \cos 2x + q^8) \dots}{(1-2q \cos 2x + q^2)(1-2q^3 \cos 2x + q^6) \dots} \quad (A)$$

$$\Delta \operatorname{am} \frac{2Kx}{\pi} = \sqrt{k} \frac{(1+2q \cos 2x + q^2)(1+2q^3 \cos 2x + q^6) \dots}{(1-2q \cos 2x + q^2)(1-2q^3 \cos 2x + q^6) \dots},$$

from which are easily derived such series as

$$\frac{2\lambda K}{\pi} \sin \operatorname{am} \frac{2Kx}{\pi} = \frac{4\sqrt{q} \sin x}{1-q} + \frac{4\sqrt{q^3} \sin 3x}{1-q^3} + \frac{4\sqrt{q^5} \sin 5x}{1-q^5} + \&c.$$

$$= 4 \sin x \left\{ \frac{\sqrt{q}(1+q)}{1-2q \cos 2x + q^2} + \frac{\sqrt{q^3}(1+q^3)}{1-2q^3 \cos 2x + q^6} + \&c \right\}.$$

The series for powers of these functions are then investigated; and it is found, e.g., that the square may be written  $\left(\frac{2kK}{\pi}\right)^2 \sin^2 am \frac{2Kx}{\pi}$

$$\frac{4K(K-E^1)}{\pi^2} - 4 \left\{ \frac{2\eta^2 \cos 2x}{1-\eta^2} + \frac{4\eta^4 \cos 4x}{1-\eta^4} + \frac{6\eta^6 \cos 6x}{1-\eta^6} + \dots \right\}.$$

253. This enables the second kind of elliptic integral to be evolved in a series. The form introduced being called Z is related to Legendre's E by the equations

$$\frac{2Kx}{\pi} = u, \quad \phi = am u, \quad Z(u) = \frac{E^1 E(\phi) - E^1 F(\phi)}{F^1},$$

and the expansion is found

$$\frac{2K}{\pi} Z\left(\frac{2Kx}{\pi}\right) = \frac{2Kx}{\pi} \left(\frac{2K}{\pi} - 2E^1\right) - \left(\frac{2kK}{\pi}\right)^2 \int_0^x \sin^2 am \frac{2Kx}{\pi} dx. \quad (B)$$

$$= 4 \left\{ \frac{\eta \sin 2x}{1-\eta^2} + \frac{\eta^3 \sin 4x}{1-\eta^4} + \frac{\eta^5 \sin 6x}{1-\eta^6} + \dots \right\}.$$

254. Before proceeding to the serial development of the third kind of integrals, the theorems concerning their reduction to depend on functions containing only two variables are given. It is shown first assuming two angles  $\sigma, \delta$ , such that  $F(\phi) + F(\alpha) = F(\sigma)$  and  $F(\phi) - F(\alpha) = F(\delta)$  that

$$\int_0^\phi k^2 \sin \alpha \cos \alpha \Delta \alpha \cdot \sin^2 \phi d\phi$$

$$\int_0^\phi \{1 - k^2 \sin^2 \alpha \cdot \sin^2 \phi\} \Delta(\phi)$$

$$= F(\phi)E(\alpha) - \frac{1}{2} \int_0^\phi \frac{E(\phi)d\phi}{\Delta(\phi)} + \frac{1}{2} \int_0^\delta \frac{E(\phi)d\phi}{\Delta(\phi)} \quad (C)$$

so that the third kind of elliptic integrals, which involves three elements, the modulus  $k$ , the amplitude  $\phi$ , and the parameter  $\alpha$  (the quantity  $-k^2 \sin^2 \alpha$  is what Legendre called  $n$  the parameter, § 206) is reduced to integrals of the first and second kind, and to the new transcendental  $\int_0^\phi \frac{E(\phi)d\phi}{\Delta(\phi)}$ , each of these depending only on two elements.

This new transcendental we see from the above equation, by letting  $F(\alpha) = 2F(\alpha)$ , and so  $\sigma = \alpha, \delta = 0$ , for  $\phi = \alpha$ , satisfies the equation

$$\int_0^\alpha \frac{k^2 \sin \alpha \cos \alpha \Delta \alpha \cdot \sin^2 \phi d\phi}{(1 - k^2 \sin^2 \alpha \sin^2 \phi) \Delta(\phi)} = F(\alpha)E(\alpha) - \frac{1}{2} \int_0^{2\alpha} \frac{E(\phi)d\phi}{\Delta(\phi)}$$

that is to say, for the new transcendental we may substitute the definite integral of the third kind in which the amplitude is equal to the parameter; another statement of the reducibility to functions depending on two elements only.

The above equation (C) may be transformed by the identity derived from the formulæ of § 207,

$$\sin^2 \sigma - \sin^2 \delta = \frac{4 \sin \alpha \cos \alpha \Delta \alpha \sin \phi \cos \phi \Delta \phi}{(1 - k^2 \sin^2 \alpha \sin^2 \phi)^2}$$

which gives, on introducing an  $\nu$  for  $\phi$ , am  $\alpha$  for  $\alpha$ , and consequently am  $(u + \alpha)$  for  $\sigma$  and am  $(u - \alpha)$  for  $\delta$ , and integrating,

$$\int_0^u du \{ \sin^2 am(u + \alpha) - \sin^2 am(u - \alpha) \}$$

$$= 2 \sin am \alpha \cos am \alpha \Delta am \alpha \cdot \sin^2 am u$$

$$= \frac{2 \sin am \alpha \cos am \alpha \Delta am \alpha \cdot \sin^2 am u}{1 - k^2 \sin^2 am \alpha \cdot \sin^2 am u}$$

255. Jacobi accordingly accepts as canonical for an integral of the third kind the form written above. He defines it by

$$\Pi(u, \alpha) = \int_0^u \frac{k^2 \sin am \alpha \cdot \cos am \alpha \cdot \Delta am \alpha \cdot \sin^2 am u \cdot du}{1 - k^2 \sin^2 am \alpha \cdot \sin^2 am u}$$

Again, denoting by  $\Theta(u)$  the expression  $\Theta(u) = \Theta(0) \int_0^u Z(u) du$  the integration of the series for  $Z(u)$  (§ 253) gives

$$\frac{2K}{\pi} \int_0^x Z\left(\frac{2Kx}{\pi}\right) dx = -2 \left\{ \frac{\eta^2 \cos 2x}{1-\eta^2} + \frac{\eta^4 \cos 4x}{2(1-\eta^4)} + \frac{\eta^6 \cos 6x}{3(1-\eta^6)} + \dots \right\} + \text{const.}$$

$$= -\log \left\{ \frac{(1-2\eta \cos 2x + \eta^2)(1-2\eta^3 \cos 2x + \eta^6)(1-2\eta^5 \cos 2x + \eta^{10}) \dots}{\{(1-\eta)(1-\eta^3)(1-\eta^5) \dots\}^2} \right\};$$

whence

$$\frac{\Theta\left(\frac{2Kx}{\pi}\right)}{\Theta(0)} = \frac{(1-2\eta \cos 2x + \eta^2)(1-2\eta^3 \cos 2x + \eta^6) \dots}{\{(1-\eta)(1-\eta^3)(1-\eta^5) \dots\}^2}$$

256. This is the first introduction in the *Fundamenta* of these functions, which have been called *theta* functions from the original notation adopted for them by Jacobi, and by many writers have been named after him *Jacobian functions*.

The connexion of the integral of the third kind with these functions follows at once from § 254. In fact, calling  $\frac{d\Theta(u)}{du} = \Theta'(u)$ , it is

$$\Pi(u, \alpha) = uZ(u) + \frac{1}{2} \log \frac{\Theta(u-\alpha)}{\Theta(u+\alpha)} = u \frac{\Theta'(u)}{\Theta(u)} + \frac{1}{2} \log \frac{\Theta(u-\alpha)}{\Theta(u+\alpha)}$$

But, since  $\Theta$  is an even function in  $u$ ,  $\Theta(u) = \Theta(-u)$ ,

$$\text{whence} \quad \Pi(u, \alpha) = \alpha Z(u) + \frac{1}{2} \log \frac{\Theta(u-\alpha)}{\Theta(u+\alpha)}$$

Hence, subtracting,

$$\Pi(u, \alpha) - \Pi(u, \alpha) = uZ(u) - \alpha Z(u),$$

which is in this notation the theorem that an integral of the third kind can always be reduced to another in which its parameter and amplitude are interchanged, as was noticed by Legendre (§ 216).

The development of  $\Pi(u)$  in a series is found by aid of the series for  $\sin^2 am u$  and of the last equation in § 254. It is

$$\Pi\left(\frac{2Kx}{\pi}, \frac{2K\alpha}{\pi}\right) = \frac{2K\alpha}{\pi} Z\left(\frac{2Kx}{\pi}\right)$$

$$- 2 \left\{ \frac{\eta \sin 2\alpha \sin 2x}{1-\eta^2} + \frac{\eta^3 \sin 4\alpha \sin 4x}{2(1-\eta^4)} + \frac{\eta^5 \sin 6\alpha \sin 6x}{3(1-\eta^6)} + \dots \right\}.$$

257. Returning from the integrals to the elliptic functions, the expressions in infinite products (A, § 252) are resumed. The occurrence of the function  $\Theta$  is apparent in each of the denominators. Introducing the definition of a function  $\Pi$ ,

$$H\left(\frac{2Kx}{\pi}\right) = \frac{2\eta^2 \sin x(1-2\eta^2 \cos 2x + \eta^4)(1-2\eta^4 \cos 2x + \eta^8) \dots}{\{(1-\eta)(1-\eta^3)(1-\eta^5) \dots\}^2},$$

$$\Theta(0)$$

and replacing  $\frac{2Kx}{\pi}$  by  $u$ , it is easily seen that the expressions are

$$\sin am u = \frac{1}{\sqrt{k}} \frac{\Pi(u)}{\Theta(u)}, \quad \cos am u = \sqrt{\frac{k'}{k}} \frac{H(u+k)}{\Theta(u)},$$

$$\Delta am u = \sqrt{k} \frac{\Theta(u+k)}{\Theta(u)}.$$

Again, it is easily seen that  $\Theta(u + 2K) = \Theta(u)$  and  $\Pi(u + 2K) = -\Pi(u)$ . Also as by substituting  $iu$  for  $u$  (§ 235) we get

$$iZ(iu, k') = Z(u, k) + \frac{\pi i u}{2Kk'} - \tan am(u, k') \Delta am(u, k');$$

whence, integrating,

$$\frac{\Theta(iu, k')}{\Theta(0, k')} = e^{\frac{\pi u^2}{4Kk'}} \cos am(u, k') \frac{\Theta(u, k')}{\Theta(0, k')},$$

it follows that  $\Theta(u + 2iK') = -e^{-\frac{\pi(K'-iu)}{K}} \Theta(u)$ ;

as also that  $\Theta(u + iK') = ie^{-\frac{\pi(K'-2iu)}{4K}} \Theta(u) \cdot \sqrt{k} \sin am u$ .

whence

$$= ie^{-\frac{\pi(K'-2iu)}{4K}} H(u);$$

and by successively replacing  $u$  by  $u + 2iK'$  it is hence seen that  $\Theta(u)$  and  $H(u)$  have one real period  $4K$  common with the elliptic

functions, and that  $e^{\frac{\pi u^2}{4Kk'}} \Theta(u)$  and  $e^{\frac{\pi u^2}{4Kk'}} \Pi(u)$  have another imaginary period  $4iK'$  in common with them.

258. The expansion of the  $\Theta$  and  $H$  functions in series of cosines and sines of multiple arcs by the method of indeterminate coefficients determines

$$\Theta\left(\frac{2Kx}{\pi}\right) = 1 - 2\eta \cos 2x + 2\eta^4 \cos 4x - 2\eta^9 \cos 6x + 2\eta^{16} \cos 8x - \dots$$

$$\Pi\left(\frac{2Kx}{\pi}\right) = 2\eta^4 \sin x - 2\eta^7 \sin 3x + 2\eta^{12} \sin 5x - 2\eta^{19} \sin 7x + \dots$$

and hence a new development of elliptic functions as well as of the integrals arises.

The developments of the numerators of the  $\cos am$  and  $\Delta am$  may be written down from the above—in the notation subsequently used by Jacobi—

$$\theta_x = 1 - 2\eta \cos 2x + 2\eta^4 \cos 4x - 2\eta^9 \cos 6x + \dots$$

$$\theta_1 x = 2\eta^4 \sin x - 2\eta^7 \sin 3x + 2\eta^{12} \sin 5x - \dots$$

$$\theta_2 x = 2\eta^7 \cos x + 2\eta^{12} \cos 3x + 2\eta^{19} \cos 5x + \dots$$

$$\theta_3 x = 1 + 2\eta \cos 2x + 2\eta^4 \cos 4x + 2\eta^9 \cos 6x + \dots$$

as, for instance, in his lectures, in which, without any pre-supposition from the theory of elliptic transcendents, he established the relations which these series fulfil, and from them a theorem of addition for the quotients of the series, and from this the differential formulæ which lead immediately to the elliptic integrals. All these formulæ consist of series of exponential quantities, extending in both directions to infinity, in which the ordering element in the exponent rises to the second degree. Their general form may therefore be written  $\sum c^{\nu x^2 + 2\nu x + c}$ , where  $\nu$  takes all positive and negative integer values.

259. The *Fundamenta Nova* appeared almost at the date of the death of Abel. Of Abel's works, besides those which we have men-



tioned, the chief is the unfinished "Précis d'une théorie des fonctions elliptiques," which appeared in *Crelle*, iv., in 1829. "The whole of my researches will form a work of some extent which I cannot yet publish, therefore I give here a 'Précis' of the method I followed, and its general results." The fragment of this work which has been published deals only with the integrals.

260. The consideration of the indeterminateness of the integral

$$u = \int_0^x \frac{dx}{\sqrt{(1-x^2)(1-k^2x^2)}},$$

which gives rise to periodicity in the inverse function  $x = \sin am u$ , has led to the consideration of the whole subject from a new point of view. The introduction of the complex variable into analysis by Cauchy in his *Mémoire sur les intégrales définies prises entre des limites imaginaires* (1825), and by Gauss in the second part of his *Theoria Residuorum Biquadraticorum* (1831), has been followed by the works of Puiseux ("Recherches sur les fonctions algébriques," *Liouville*, xv. 1850), of Riemann (*Inaugural Dissertation*, 1851, and "Theorie der Abelschen Functionen," *Crelle*, 1857), and of Weierstrass ("Theorie der Abelschen Functionen," *Crelle*, 1856)—which develop the subject in this more extended field, perfecting the conception which the term *function* covers in analysis, and pointing out the essential distinctions in the different modes of dependence of two quantities,—such distinctions, for instance, as when a function is defined by a differential equation, whether it is one-valued or not, and, if it be, whether it is integer or fractional.

261. In close connexion with this is another department to which the theory of transcendents has with great success been applied,—the investigation of the geometrical properties of curves. The points on a curve are expressed as functions of a parameter, and on the nature of these functions the nature of the curve depends,—the "deficiency" or "Geschlecht" of the curve (see *CURVE*, vol. vi., p. 725) determines the nature of the function, and any curve into which another can be rationally transformed depends on the same function.

We shall conclude with a brief application to the case of elliptic functions and plane curves of the third degree. It is well known that the equation of any non-singular cubic can be reduced to the form

$$y^2 = x(x-y)(x-k^2y),$$

where  $y=0$  is the tangent at the point of inflexion in which the curve meets  $x=0$ , and  $x=0$ ,  $x=y$ ,  $x=k^2y$  are the tangents from that point to the curve, their points of contact lying on  $z=0$ .

This equation is satisfied identically by assuming the equations  $\rho x = \sin am u$ ,  $\rho y = \sin^2 am u$ ,  $\rho z = \Delta am u \cos am u$ , which determine any point on the curve by a parameter  $u$ . To each value of  $u$  corresponds a perfectly definite point of the curve. But on the other hand, to any point of the curve corresponds an infinite number of values of the argument all related to one of them,  $u$ ,—differing from it only by a multiple sum of the periods.

The occurrence of the elliptic integral  $u$  here in this normal form results from the coordinates chosen; but, whatever they be, we see that the points of the curve can be expressed by a parameter depending on no higher irrationality than that we have introduced. When the cubic has a double point, the coordinates of any point on the curve can be expressed by a parameter without introducing any irrationality.

262. To investigate the intersections of the cubic with a right line we proceed to derive in a simple manner a slight extension of Euler's notation (§ 207). Written in Jacobi's notation it is  $\cos am(u_1 + u_2) = \cos am u_1 \cos am u_2 - \sin am u_1 \sin am u_2 \Delta am(u_1 + u_2)$ , which is easily thrown into the form

$$k'^2 + k^2 \cos am u_1 \cos am u_2 \cos am(u_1 + u_2) = \Delta am u_1 \Delta am u_2 \Delta am(u_1 + u_2).$$

This may be extended to three arguments as follows. Denoting  $\sin am u_r$  briefly by  $s_r$ , also  $\cos am u_r$  by  $c_r$ ,  $\Delta am u_r$  by  $\Delta_r$ ,  $\tan am u_r$  by  $t_r$ , and  $\cot am u_r$  by  $c'_r$ , the formula may be written

$$k'^2 + k^2 c_1 c_2 c_3 (u_1 + u_2) = \Delta_1 \Delta_2 \Delta_3 (u_1 + u_2);$$

putting for  $u_1, u_2, u_3$ , and expressing, by § 207,  $c(u_2 + u_3)$  and  $\Delta(u_2 + u_3)$  by functions of one argument, we get

$$k'^2 + k^2 s_1 c_2 c_3 (t_1 + t_2 + t_3) - \Delta_1 \Delta_2 \Delta_3 \Delta (u_1 + u_2 + u_3) = k^2 s_2 s_3 \{k'^2 s_1 s_3 + c_1 \Delta_2 \Delta_3 c' (u_1 + u_2 + u_3) - \Delta_1 c_2 c_3 \Delta (u_1 + u_2 + u_3)\}.$$

Now the former expression is symmetrical; denoting it by  $k^2 s_2 s_3 \theta$ , we can determine  $\theta$  as follows. Writing for brevity

$$c(u_1 + u_2 + u_3) = C, \text{ and } \Delta(u_1 + u_2 + u_3) = \Delta$$

the equation is  $k'^2 s_2 s_3 + c_1 \Delta_2 \Delta_3 C - \Delta_1 c_2 c_3 \Delta - \theta s_1 = 0$ .

Hence writing down the three equations, which must hold from symmetry,

$$\begin{aligned} 0 &= k'^2 s_2 s_3 + c_1 \Delta_2 \Delta_3 C - \Delta_1 c_2 c_3 \Delta - \theta s_1, \\ 0 &= k'^2 s_1 s_3 + c_2 \Delta_1 \Delta_3 C - \Delta_2 c_1 c_3 \Delta - \theta s_2, \\ 0 &= k'^2 s_1 s_2 + c_3 \Delta_1 \Delta_2 C - \Delta_3 c_1 c_2 \Delta - \theta s_3, \end{aligned}$$

we obtain  $C$  and  $\Delta$  as quotients of determinants of single arguments. For  $\Delta$  we get

$$\Delta = \begin{vmatrix} 1 & s_1^2 & s_1 c_1 \Delta_1 \\ 1 & s_2^2 & s_2 c_2 \Delta_2 \\ 1 & s_3^2 & s_3 c_3 \Delta_3 \end{vmatrix} = \begin{vmatrix} 1 & s_1^2 & \frac{s_1 c_1}{\Delta_1} \\ 1 & s_2^2 & \frac{s_2 c_2}{\Delta_2} \\ 1 & s_3^2 & \frac{s_3 c_3}{\Delta_3} \end{vmatrix} \Delta_1 \Delta_2 \Delta_3,$$

and for  $C$

$$C = \begin{vmatrix} 1 & s_1^2 & s_1 c_1 \Delta_1 \\ 1 & s_2^2 & s_2 c_2 \Delta_2 \\ 1 & s_3^2 & s_3 c_3 \Delta_3 \end{vmatrix} U = \begin{vmatrix} 1 & s_1^2 & \Delta_1' \\ 1 & s_2^2 & \Delta_2' \\ 1 & s_3^2 & \Delta_3' \end{vmatrix} c_1 c_2 c_3.$$

But in this, increasing each argument by  $iK$ , since then we get, for  $s_r, \frac{1}{k s_r}$ , for  $c_r, \frac{-i \Delta_r}{k s_r}$ , for  $\Delta_r, -i c'_r$ , for  $t_r, \frac{i}{\Delta_r}$ , and thus for  $C, \frac{i \Delta}{k S}$ , where  $S$  stands for  $\sin am(u_1 + u_2 + u_3)$ , this formula gives

$$\frac{\Delta}{\Delta_1 \Delta_2 \Delta_3} = - \begin{vmatrix} 1 & s_1^2 & \Delta_1 c'_1 \\ 1 & s_2^2 & \Delta_2 c'_2 \\ 1 & s_3^2 & \Delta_3 c'_3 \end{vmatrix} = - \begin{vmatrix} 1 & s_1^2 & \frac{c_1 s_1}{\Delta_1} \\ 1 & s_2^2 & \frac{c_2 s_2}{\Delta_2} \\ 1 & s_3^2 & \frac{c_3 s_3}{\Delta_3} \end{vmatrix} \frac{S}{s_1 s_2 s_3};$$

whence

$$\sin am(u_1 + u_2 + u_3) = - \frac{\begin{vmatrix} s_1 & s_1^3 & \Delta_1 c_1 \\ s_2 & s_2^3 & \Delta_2 c_2 \\ s_3 & s_3^3 & \Delta_3 c_3 \end{vmatrix}}{\begin{vmatrix} 1 & s_1^2 & s_1 c_1 \Delta_1 \\ 1 & s_2^2 & s_2 c_2 \Delta_2 \\ 1 & s_3^2 & s_3 c_3 \Delta_3 \end{vmatrix}};$$

and the value for  $\theta$  thus found gives

$$k'^2 + k^2 c_1 c_2 c_3 C (u_1 + u_2 + u_3) - \Delta_1 \Delta_2 \Delta_3 \Delta (u_1 + u_2 + u_3) + k^2 k'^2 s_2 s_3 S (u_1 + u_2 + u_3) = 0.$$

263. The formula thus obtained for  $\sin am(u_1 + u_2 + u_3)$  vanishes when  $u_1 + u_2 + u_3 = 0$ , or differs from 0 only by an integer combination of the periods. But the determinant

$$\begin{vmatrix} s_1 & s_1^3 & \Delta_1 c_1 \\ s_2 & s_2^3 & \Delta_2 c_2 \\ s_3 & s_3^3 & \Delta_3 c_3 \end{vmatrix}$$

vanishes if its constituents be the coordinates of three collinear points. But these are, as we have just seen, the coordinates of three points on the cubic  $y^2 = x(x-y)(x-k^2y)$ , § 261.

This result may therefore be stated thus:—If the points of a cubic be expressed as elliptic functions of a parameter, then for the intersections with a right line the sum of the arguments differs from zero only by some integer combination of the periods.

This enables us to solve many problems. For instance, the arguments of the points of contact of the four tangents which can be drawn to the curve from a point  $u$  on it are

$$-\frac{u}{2}, -\frac{u+\omega}{2}, -\frac{u+\omega'}{2}, -\frac{u+\omega+\omega'}{2}.$$

Conversely the tangential point  $v$  of a given point  $u$  of the curve is determined by  $u = -2v \pmod{\omega}$ .

The problem of determination of points of inflexion when one point of inflexion is known is identical with the problem of the special trisection of elliptic functions, i.e., of the determination of the values for  $u = \frac{v\omega + q\omega'}{3}$  to the same moduli.

*Bibliography.*—In addition to the works on elliptic functions and the higher transcendents already named, there have recently appeared as independent works, besides innumerable memoirs in the various mathematical periodicals—Briot and Bouquet, *Théorie des fonctions elliptiques*, 2d ed., 1875; Briot, *Théorie des fonctions abéliennes*, 1873; Booth, *Theory of Elliptic Integrals*, 1851; Casorati, *Teoria delle funzioni di variabili complesse*, 1868; Cayley, *Elementary Treatise on Elliptic Functions*, 1876; Clebsch, *Geometrie*, 1876; Clebsch and Gordan, *Theorie der Abelschen Functionen*, 1866; Durège, *Elemente der Theorie der Functionen*, 1873; Id., *Theorie der ellipt. Funct.*, 1875; Eisenstein, "Beiträge," collected in his *Math. Abhandlungen*, 1847; Ellis, "Report on Recent Progress of Analysis," *Brit. Ass. Reports*, 1846; Enneper, *Ell. Funct. Theorie und Geschichte*, 1876; Königsberger, *Transformation, Act. der Ell. Functionen*, 1868; Id., *Theorie d. Ell. Funct.*, 1874; Id., *Theorie d. hyperelliptischen Integrale*, 1878; Id., *Geschichte der Ell. Transcendenten*, 1879 (to the last two authors we are mainly indebted for the historical details of our subject); Lipschitz, *Differential und Integralrechnung*, 1880; Neumann, *Ueber Riemann's Theorie d. Abelschen Integrale*, 1865; Roberts, *On Addition of Elliptic and Hyperelliptic Integrals*, 1871; Russell, "Report on Recent Progress in Elliptic and Hyperelliptic Functions," *Brit. Ass. Reports* (1869, p. 334; 1870, p. 102; 1872, p. 335, 1873, p. 307); Schlicht, *Ell. Integrale und Theta Functionen*, 1864; Schläglic, *Compendium der Höheren Analysis*, 2d ed., 1874; Schöenke, "Elliptische Functionen," in Ersch and Gruber's *Encyclopädie*; Thoma, *Abriss einer Theorie der complexen Functionen*, 1873; Id., *Sammlung von Formeln*, 1876; Verhulst, *Tratté élémentaire des fonctions elliptiques*, 1841; Weber, *Theorie d. Abelschen Functionen von Geschlecht 3*, 1876; Weyr, *Theorie d. Ell. Funct.*, 1876; and of the highest historical interest is the publication by Borchardt of the correspondence between Legendre and Jacobi in vol. lxxx. of *Crelle's Journal*, 1875, reproduced in vol. i. of the collected works of Jacobi, 1881. (B.W.)



INFLUENZA (syn. Epidemic Catarrh) is a term applied to an infectious febrile disorder of short duration, characterized specially by catarrh of the respiratory passages and alimentary canal, and occurring mostly as an epidemic.

The symptoms of this disease develop suddenly, with all the phenomena attending a severe cold or catarrh. At first there are chills or rigors, which are soon accompanied with distressing headache and tightness across the forehead, tenderness and watering of the eyes, and sneezing and discharge from the nostrils. To these succeed heat and soreness of the throat, hoarseness, cough, and, it may be, some difficulty of breathing. The temperature is elevated, the pulse quick and feeble, and the skin, which at first was dry, becomes moist, and is said to exhale a peculiar musty odour. The digestive system participates in the disturbance, and there is loss of appetite, with thirst, vomiting, and occasionally diarrhœa.

Rapid loss of strength and remarkable depression of spirits accompany these various symptoms, and are among the most characteristic features of the disease. After lasting for two or three days, the symptoms abate and convalescence begins, but there may remain, particularly in severe cases, and in persons at the extremes of life, great debility for a length of time, or the attack may be complicated with inflammatory affections of the chest, which may prove a source of danger far exceeding that of the original disease. Apart from this, influenza is not usually a very fatal malady, although some epidemics such as that of 1762 have been characterized by a severe type of the disease and considerable loss of life. The mortality is generally reckoned at about 2 per cent., but when an extensive epidemic prevails, even this proportion is sufficient to swell the death-rate largely.

This disease is referred to in the works of the ancient physicians, but accurate descriptions of it have been given by numerous medical writers during the last three centuries, in connexion with epidemics which have occurred from time to time. These various accounts agree substantially in their narration of the phenomena and course of the disease, and influenza has in all times been regarded as fulfilling all the conditions of an epidemic in its sudden invasion, rapid and extensive spread, and speedy and complete disappearance. Among the chief epidemics of influenza are those of 1762, 1782, 1787, 1803, 1833, 1837, and 1847. In several of these the disease appeared to originate in some parts of Asia, and to travel westward through Europe and on to America, resembling in this respect certain cholera epidemics, although the two classes of disease have nothing in common. In some of the epidemics influenza has spread through the whole of Europe in the course of six weeks. Wherever it appears the whole community suffers to a greater or less extent, irrespective of age or condition of life. It has occasionally appeared in fleets at sea away from all communication with land, and to such an extent as to disable them temporarily for service. This happened in 1782 in the case of the squadron of Admiral Kempenfelt, which had to return to England from the coast of France in consequence of a severe epidemic of influenza attacking his crews, while at the same time the squadron of Lord Anson, off the coast of Holland, suffered extensively from a similar outbreak. Many instances of a like kind have been recorded.

Much speculation and some amount of scientific inquiry have been expended in endeavours to ascertain the cause of this remarkable ailment. The Italians in the 17th century ascribed it to the influence of the stars, and hence the name "influenza," by which the disease has subsequently been known. By some it has been held to depend on certain telluric, and by others on certain climatic conditions; but the occurrence of the disease in all sorts of climates and

localities is sufficient to negative these theories. The view which refers it to some morbid principle present in the atmosphere during an epidemic is that which has gained widest acceptance, but the nature of this infecting agent is unknown. Various hypotheses have been advanced on the subject, such as some change in the electrical condition of the air, or the over-abundance of ozone, but these have not been confirmed by observation. More probable, and more in harmony with observed facts, is the theory that in influenza, as in other epidemic diseases, there is present in the atmosphere some minute organism of specific nature, which is not only distributed over wide areas, but which when introduced into the bodies of those attacked multiplies there indefinitely, and becomes a source of infection by the breath, &c., and in this way a further cause of the spread of the disease. The contagiousness of influenza appears to be unquestionable. The treatment of this disorder is similar to that recommended in CATARRH (*q.v.*), but special regard must be had to its weakening effects, and every effort made throughout the illness to maintain the strength by light but nutritious diet. (J. O. A.)

INFORMATION, in English law, is a formal accusation of a crime committed, preferred *ex officio* by the attorney-general or solicitor-general in the Queen's Bench without the intervention of a grand jury. It lies only for misdemeanour and not for treason, felonies, or misprision of treason (see INDICTMENT); and it is properly employed against such "enormous misdemeanours" as peculiarly tend to disturb or endanger the Queen's government, *e.g.*, seditions, obstructing the Queen's officers in the execution of their duties, &c. In the form of the proceedings the attorney-general is said to "come into the court of our lady the Queen before the Queen herself at Westminster, and gives the court there to understand and be informed that, &c." Then follows the statement of the offence as in an indictment. The information is filed in the crown office without the leave of the court. An information may also be filed at the instance of a private prosecutor for misdemeanours not affecting the government, but being peculiarly flagrant and pernicious. Thus criminal informations have been granted for bribing or attempting to bribe public functionaries, and for aggravated libels on public or private persons. Leave to file an information is obtained after an application to show cause, founded on a sworn statement of the material facts of the case.

INFUSORIA. See PROTOZOA.

INGELHEIM. Oberingelheim and Niederingelheim, two contiguous market-towns of Germany, in the Hessian province of Rhine Hesse, circle of Bingen, are situated on the Hessian Ludwig Railway and on the Salz near its confluence with the Rhine, 9 miles west-north-west of Mainz. Oberingelheim, formerly an imperial village, has an old Evangelical church with painted windows representing scenes in the life of Charlemagne, a Catholic church, and a synagogue. Its industries are the manufacture of wine and papermaking. The population of Oberingelheim in 1875 was 2846, and of Niederingelheim 2474.

Niederingelheim is, according to one tradition, the birthplace of Charlemagne, and it possesses the ruins of an old palace built by that emperor between 768 and 774. The building contained one hundred marble pillars, and was adorned with sculptures and mosaics from Italy. It was extended by Frederick Barbarossa, and continued to be a favourite residence of the emperors till 1356, when Charles IV. resigned it to the Palatinate. The building suffered much damage during the Bavarian feud of 1504, the Thirty Years' War, and the French invasion in 1689. Only few remains of it are now standing, but some of the pillars are still to be found in different parts of Germany. Inside the boundaries there is an old church, apparently dating from the time of Frederick I. See Hiltz, *Der Reichspalat zu Ingelheim*, Oberingelheim, 1868.

INGEMANN, BERNHARD SEVERIN (1789-1862), a Danish poet and novelist, was born at Turkildstrup, in the

island of Falster, on the 28th of May 1789. He lost his father in early childhood, was educated at the grammar school at Slagelse, and entered the university of Copenhagen in 1806. His studies were interrupted by the English invasion, and on the first night of the bombardment of the city Ingemann stood with the young poet Blicher on the walls, while the shells whistled past them, and comrades were killed on either side. All his early and unpublished writings were destroyed by the English when they burned the town. In 1811 he published his first volume of poems, and in 1812 his second, followed in 1813 by a book of lyrics entitled *Proene*. These three volumes were extremely well received, and so was his cycle of romances in verse, called *The Black Knight*, 1814. With these books he attained at once the leading position in Denmark as a lyricist, and he then turned his attention to the drama. In 1815 he published two tragedies, *Masaniello* and *Blanca*, followed by *The Voice in the Desert*, *The Shepherd of Tolosa*, and other romantic plays. After a variety of publications, all enormously successful, he travelled in 1818 to Italy. At Rome he wrote *The Liberation of Tasso*, and returned in 1819 to Copenhagen. In 1820 he began to display his real power in a volume of delightful tales. In 1821 his dramatic career closed with the production of an unsuccessful comedy, *Magnétism in a Barber's Shop*. In 1822 the poet was nominated lector in Danish language and literature at Söro College, and he now married. *Valdemar the Great and his Men*, an historical epic, appeared in 1824. The next few years were occupied with his best and most durable work, his four great historical novels of *Valdemar Seier*, 1826; *Erik Menved's Childhood*, 1828; *King Erik*, 1833; and *Prince Otto of Denmark*, 1835. He then returned to epic poetry in *Queen Margaret*, 1836, and *Holger Danske*, 1837. The number of his later writings is too great to permit us to chronicle them. They consist of religious and sentimental lyrics, epic poems, novels, short stories in prose, and fairy tales. His last publication was *The Apple of Gold*, 1856. In 1816 Ingemann was nominated director of Söro College, a post from which he retired in 1819. He died peacefully and happily on the evening of the 24th of February 1862. Ingemann enjoyed during his lifetime a popularity which was unapproached even by that of Oehlenschläger, and in fact it may be said that no Danish poet has ever been nearly so popular as he. But criticism has been busy since his death in reversing this decision of the public, and Ingemann now takes a place in Danish literature below four or five of his immediate contemporaries. His boundless facility and fecundity, his sentimentality, his religious melancholy, his direct appeal to the domestic affections, gave him instant access to the ear of the public. His novels are better than his poems; of the former the best are those which are directly modelled on the manner of Sir Walter Scott. As a dramatist he has entirely outlived his reputation, and his unwieldy epics are now little read. Ingemann was a purely sentimental writer, and his reputation has proved no less ephemeral than the fashion for sentiment.

INGOLSTADT, a fortified town in the government district of Upper Bavaria, is situated on the left bank of the Danube at its junction with the Schutter, 50 miles north of Munich by rail. As the chief town of the district it is the seat of the usual authorities. The town is well built. The principal buildings are the old castle of the dukes of Bavaria-Ingolstadt, now used as an arsenal; the remains of the earliest Jesuits' college in Germany, founded in 1553; the former university buildings, now a school; the theatre; the large Gothic church of Our Lady, founded in 1425, with two massive towers, and the grave of Dr Eck, Luther's opponent; the Franciscan convent and nunnery; and several other churches and hospitals. Ingolstadt possesses

several technical and other schools. In 1472 a university was founded in the town by Duke Louis the Rich, which at the end of the 16th century was attended by 4000 students. In 1800 it was removed to Landslut, whence it was finally transferred to Munich in 1826. The industries of Ingolstadt comprise brewing, wax-bleaching, and potash-boiling; there is also trade in vegetables. The station, an important junction  $1\frac{1}{2}$  miles distant, is connected with the town by tramway. The population in 1875 was 14,485.

Ingolstadt, known as *Aureatum* or *Chrysopolis*, was a royal villa in the beginning of the 9th century, and only received its city charter about 1312, from the emperor Louis of Bavaria. After that date it gradually grew in importance, and became the capital of a mediæval dukedom which merged finally in that of Bavaria-Munich. The fortifications, erected in 1539, were put to the test during the contests of the Smalkaldian League, and in the Thirty Years' War. Gustavus Adolphus besieged Ingolstadt in 1632, when Tilly, to whom there is a monument in the church, lay mortally wounded within the walls. In the war of the Spanish succession it was besieged by the margrave of Baden in 1704. In 1743 it was surrendered by the French to the Austrians, and in 1809, after a three months' siege, the French under General Moreau took the town, and destroyed the fortifications. These, however, were rebuilt on a much larger scale under King Louis I.; and since 1834 Ingolstadt has ranked as a fortress of the first class. In 1872 even more important fortifications were begun, which include *têtes-de-pont* with round towers of massive masonry, and the *Reduit Tilly* on the right bank of the river.

INGRES, JEAN AUGUSTE DOMINIQUE (1780-1867), whose name represents one of the most important among the conflicting tendencies of modern art, was born at Montauban August 29, 1780. His father, for whom he always entertained the most tender and respectful affection, has described himself as *sculpteur en plâtre*; he was, however, equally ready to execute every other kind of decorative work, and now and again eked out his living by taking portraits, or obtained an engagement as a violin player. He brought up his son to command the same varied resources, but in consequence of certain early successes—the lad's performance of a concerto of Viotti's was applauded at the theatre of Toulouse—his attention was directed chiefly to the study of music. At Toulouse, to which place his father had removed from Montauban in 1792, Ingres had, however, received lessons from Joseph Roques, a painter, whom he quitted at the end of a few months to become a pupil of M. Vigan, professor at the academy of fine arts in the same town. From M. Vigan, Ingres, whose vocation became day by day more distinctly evident, passed to M. Briant, a landscape-painter who insisted that his pupil was specially gifted by nature to follow the same line as himself. For a while Ingres obeyed, but he had been thoroughly aroused and enlightened as to his own objects and desires by the sight of a copy of Raphael's *Madonna della Sedia*, and, having decisively ended his connexion with Briant, he started for Paris, where he arrived about the close of 1796. He was then admitted to the studio of David, for whose lofty standard and severe principles he always retained a profound appreciation. David recognized the merit of one who soon ranked amongst his most promising pupils, and Ingres, after four years of devoted study, in the course of which (1800) he obtained the second place in the yearly competition, finally carried off the *Grand Prix* (1801). The work thus rewarded—the *Ambassadors of Agamemnon in the Tent of Achilles* (*École des Beaux Arts*)—was admired by Flaxman so much as to give umbrage to David, and was succeeded in the following year (1802) by the execution of a *Girl after Bathing*, and a woman's portrait; in 1804 Ingres exhibited *Portrait of the First Consul* (*Musée de Liège*), and portraits of his father and himself; these were followed in 1806 by *Portrait of the Emperor (Invalides)*, and portraits of M., Mme., and Mlle. Rivière (the first two now in the Louvre). All these and various minor works were executed in Paris, for it was not until



1809 that the state of public affairs admitted of the re-establishment of the Academy of France at Rome, and we find from the journals of the day that they produced a disturbing impression on the public. It was clear that the artist was some one who must be counted with; his talent, the purity of his line, and his power of literal rendering were generally acknowledged; but he was reproached with a desire to be singular and extraordinary. "Ingres," writes Frau v. Hastfer (*Leben und Kunst in Paris, 1806*) "wird nach Italien gehen, und dort wird er vielleicht vergessen dass er zu etwas Grossem geboren ist, und wird eben darum ein hohes Ziel erreichen." In this spirit, also, Chaussard violently attacked his Portrait of the Emperor (*Pausanias Français, 1806*), nor did the portraits of the Rivière family escape. The points on which Chaussard justly lays stress are the strange discordances of colour.—such as the blue of the cushion against which Mme. Rivière leans, and the want of the relief and warmth of life, but he omits to touch on that grasp of his subject as a whole, shown in the portraits of both husband and wife, which already evidences the strength and sincerity of the passionless point of view which marks all Ingres's best productions. The very year after his arrival in Rome (1808) Ingres produced *Œdipus* and the Sphinx (Louvre; lithographed by Sudre, engraved by Gaillard), a work which proved him in the full possession of his mature powers, and began the Venus Anadyomene (Collection Rieset; engraving begun by Pollet), completed forty years later, and exhibited in 1855. These works were followed by some of his best portraits, that of M. Bochet (Louvre), and that of Mme. la Comtesse de Tournon, mother of the prefect of the department of the Tiber; in 1811 he finished Jupiter and Thetis, an immense canvas now in the Musée of Aix; in 1812 Romulus and Acron (École des Beaux Arts), and Virgil reading the *Æneid*—a composition very different from the version of it which has become widely popular through the engraving executed by Pradier in 1832. The original work, executed for a bed-chamber in the Villa Aldobrandini-Miollis, contained neither the figures of Mæcenas and Agrippa nor the statue of Marcellus; and Ingres, who had obtained possession of it during his second stay in Rome, intended to complete it with the additions made for engraving. But he never got beyond the stage of preparation, and the picture left by him, together with various other studies and sketches, to the Musée of his native town, remains half destroyed by the process meant for its regeneration. The Virgil was followed by the Betrothal of Raphael, a small painting, now lost, executed for Queen Caroline of Naples; Don Pedro of Toledo Kissing the Sword of Henry IV. (Collection Deymié; Montauban), exhibited at the Salon of 1814, together with the Chapelle Sistine (Collection Legentil; lithographed by Sudre), and the Grande Odalisque (Collection Seillière; lithographed by Sudre). In 1815 Ingres executed Raphael and the Fornarina (Collection Mme. N. de Rothschild; engraved by Pradier); in 1816 Aretin and the Envoy of Charles V. (Collection Schroth), and Aretin and Tintoret (Collection Schroth); in 1817 the Death of Leonardo (engraved by Richomme) and Henry IV. Playing with his Children (engraved by Richomme), both of which works were commissions from M. le Comte de Blacas, then ambassador of France at the Vatican. Roger and Angelique (Louvre; lithographed by Sudre), and Francesca di Rimini (Musée of Angers; lithographed by Aubry Lecomte), were completed in 1819, and followed in 1820 by Christ giving the Keys to Peter (Louvre). In 1815, also, Ingres had made many projects for treating a subject from the life of the celebrated duke of Alva, a commission from the family, but a loathing for "cet horrible homme" grew upon him, and finally he abandoned the task and entered in his diary—"J'étais forcé par la nécessité

de peindre un pareil tableau; Dieu a voulu qu'il restât en ébauche." During all these years Ingres's reputation in France did not increase. The interest which his Chapelle Sistine had aroused at the Salon of 1814 soon died away; not only was the public indifferent, but amongst his brother artists Ingres found scant recognition. The strict classicists looked upon him as a renegade, and strangely enough Delacroix and other pupils of Guérin—the very leaders of that romantic movement for which Ingres, throughout his long life, always expressed the deepest abhorrence—alone seem to have been sensible of his merits. The weight of poverty too was hard to bear. In 1813 Ingres had married; his marriage had been arranged for him with a young woman who came in a business-like way from Montauban, on the strength of the representations of her friends in Rome to whom the painter was well known. Mme. Ingres speedily acquired a faith in her husband which enabled her to combat with heroic courage and patience the difficulties which beset their common existence, and which were increased by their removal to Florence. There Bartolini, an old friend, had hoped that Ingres might have materially bettered his position, and that he might have aroused the Florentine school—a weak offshoot from that of David—to a sense of its own shortcomings. These expectations were disappointed. The good offices of Bartolini, and of one or two persons who felt a friendly interest in the painter, could only alleviate the miseries of this stay in a town where Ingres was all but wholly deprived of the means of at least gaining daily bread by the making of those small portraits for the execution of which, in Rome, his pencil had been constantly in request. Before his departure he had, however, been commissioned to paint for M. de Pastoret the Entry of Charles V. into Paris, and M. de Pastoret now obtained an order for Ingres from the Administration of Fine Arts; he was directed to treat the Vœu de Louis XIII. for the cathedral of Montauban. This work, which was exhibited at the Salon of 1824, met with universal approbation; even those sworn to observe the unadulterated precepts of David found only admiration for the Vœu de Louis XIII. On his return Ingres was received at Montauban with enthusiastic homage, and found himself celebrated throughout France. In the following year (1825) he was elected to the Institute, and his fame was further extended in 1826 by the publication of Sudre's lithograph of the Grande Odalisque, which, having been scorned by artists and critics alike in 1819, now became widely popular. A second commission from the Government called forth the Apotheosis of Homer, which, replaced by a copy in the decoration of the ceiling for which it was designed, now hangs in the galleries of the second story of the Louvre. From this date up till 1834 the studio of Ingres was thronged, as once had been thronged the studio of David, and he was a recognized *chef d'école*. Whilst he taught with despotic authority, and admirable wisdom, he steadily worked; and when in 1834 he produced his great canvas of the Martyrdom of Saint Symphorien (cathedral of Autun; lithographed by Trichot-Garneri), it was with angry disgust and resentment that he found his work received with the same doubt and indifference, if not the same hostility, as had met his earlier ventures. The suffrages of his pupils, and of one or two men—like Decamps—of undoubted ability, could not soften the sense of injury. Ingres resolved to work no longer for the public, and gladly availed himself of the opportunity to return to Rome, as director of the École de France, in the room of Horace Vernet. There he executed La Vierge à l'Hostie (Imperial collections, St Petersburg), Stratonice (Duc d'Aumale), Portrait of Cherulini (Louvre), and the Petite Odalisque for M. Marcotte, the faithful admirer for whom, in 1814, Ingres had painted the Chapelle Sistine.



The Stratonice, executed for the duke of Orleans, had been exhibited at the Palais Royal for several days after its arrival in France, and the beauty of the composition produced so favourable an impression that, on his return to Paris in 1841, Ingres found himself received with all the deference that he felt to be his due. A portrait of the purchaser of Stratonice was one of the first works executed after this return; and Ingres shortly afterwards began the decorations of the great hall in the Château de Dampierre, which, unfortunately for the reputation of the painter, were begun with an ardour which gradually slackened, until in 1849 Ingres, having been further discouraged by the irreparable loss of his faithful and courageous wife, abandoned all hope of their completion, and the contract with the Duc de Luynes was finally cancelled. A minor work, Jupiter and Antiope, marks the year 1851, but Ingres's next considerable undertaking (1853) was the Apotheosis of Napoleon I., painted for the ceiling of a hall in the Hôtel de Ville; Jeanne d'Arc (Louvre) appeared in 1854; and in 1855 Ingres consented to rescind the resolution more or less strictly kept since 1834, in favour of the International Exhibition, where a room was wholly reserved for his works. In consequence of the effect which they produced, Prince Napoleon, president of the jury, proposed an exceptional recompense for their author, and obtained from the emperor Ingres's nomination as grand officer of the Legion of Honour. With renewed confidence Ingres now took up and completed one of his most charming productions—La Source (Louvre), a figure of which he had painted the torso in 1823, and which seen with other works in London (1862) there renewed the general sentiment of admiration, and procured him, from the imperial government, the dignity of senator. After the completion of La Source, the principal works produced by Ingres were with one or two exceptions (Molière and Louis XIV., presented to the Théâtre Français, 1858; Le Bain Turc, 1859), of a religious character; La Vierge de l'Adoption, 1858 (painted for Mlle. Roland-Gosselin), was followed by La Vierge Couronnée (painted for Mme. la Baronne de Larinthie) and La Vierge aux Enfants (Collection Blanc); in 1859 these were followed by repetitions of La Vierge à l'Hostie; and in 1862 Ingres completed Christ and the Doctors (Musée Montauban), a work commissioned many years before by Queen Marie Amélie for the chapel of Bizy. On the 14th January 1867 Ingres died, in his eighty-eighth year, having preserved his faculties in wonderful perfection to the last. For a moment only—at the time of the execution of the Bain Turc, which Prince Napoleon was fain to exchange for an early portrait of the master by himself—Ingres's powers had seemed to fail, but he recovered, and showed in his last years the vigour which marked his early maturity. It is, however, to be noted that the Saint Symphorien exhibited in 1834 closes the list of the works on which his reputation will chiefly rest; for La Source, which at first sight seems to be an exception, was painted, all but the head and the extremities, in 1821; and from those who knew the work well in its incomplete state we learn that the after-painting, necessary to fuse new and old, lacked the vigour, the precision, and the something like touch which distinguished the original execution of the torso. Touch was not, indeed, at any time a means of expression on which Ingres seriously calculated: his constant employment of local tint, in mass but faintly modelled in light by half tones, forbade recourse to the shifting effects of colour and light on which the Romantic school depended in indicating those fleeting aspects of things which they rejoiced to put on canvas;—their methods would have disturbed the calculations of an art wholly based on form and line. Except in his Sistine Chapel, and one or two slighter

pieces, Ingres kept himself free from any preoccupation as to depth and force of colour and tone; driven, probably by the excesses of the Romantic movement into an attitude of stricter protest, "ce que l'on sait" he would repeat, "il faut le savoir l'épée à la main." Ingres left himself, therefore, in dealing with crowded compositions, such as the Apotheosis of Homer and the Martyrdom of Saint Symphorien, without the means of producing the necessary unity of effect which had actually been employed in due measure—as the Stanze of the Vatican bear witness—by the very master whom he most deeply revered. Thus it came to pass that in subjects of one or two figures Ingres showed to the greatest advantage: in *Œdipus*, in the Girl after Bathing, the *Odalisque*, and *La Source*—subjects only animated by the consciousness of perfect physical well-being—we find Ingres at his best. One hesitates to put Roger and Angelique upon this list, for though the female figure shows the finest qualities of Ingres's work,—deep study of nature in her purest forms, perfect sincerity of intention and power of mastering an ideal conception,—yet side by side with these the effigy of Roger on his hippogriff bears witness that from the passionless point of view, which, as before said, was Ingres's birthright, the weird creatures of the fancy cannot be seen. A graphic account of "Ingres, sa vie et ses travaux," and a complete catalogue of his works, were published by M. Delaborde in 1870, and dedicated to Mme. Ingres née Ramel, Ingres's devoted second wife, whom he married in 1852. Allusions to the painter's early days will be found in Delécluze's *Louis David*; and amongst many less important notices may be cited that by Théophile Silvestre in his series of living artists. Most of Ingres's important works are engraved in the collection brought out by Magimel. (E. F. S. P.)

INGULPHUS [INGULF], abbot of Crowland, for a long period believed to be the author of the *Historia Monasterii Croylandensis*, was born of English parents. The account of him given at the conclusion of the *Historia* has been shown to be incorrect in several particulars, but according to the authority of Ordericus Vitalis, who visited Crowland three years after the death of Ingulf, he became secretary to William, duke of Normandy, and after taking part in a pilgrimage to Jerusalem, lived as a monk in Normandy, where he rose to the rank of prior. After the accession of William to the throne of England, he in 1085 received the abbatial stall of Crowland, Lincolnshire, where he remained till his death, December 16, 1109. Through his influence with the Conqueror he secured for the abbey many valuable privileges and immunities, besides the reconstruction and enlargement of the building itself, which had been greatly damaged by the Danes in 870. The only manuscript of the *History* of Ingulf now known to exist is the Arundel manuscript, No. 178, in the British Museum, which breaks off at the same point as that published by Sir Henry Savile in the *Scriptores Rerum Anglicarum post Bedam*, London, 1596. Other four manuscripts are known to have been at one time in existence; and a more complete copy with a continuation by Peter de Blois was printed by Fulmau in vol. i. of the *Rerum Anglicarum Scriptores veteres*, Oxford, 1684. The authenticity of this work was, however, disputed by Sir Francis Palgrave in the *Quarterly Review* for September 1826, and the errors which it contains show beyond doubt that it must have been written by a later author, and entirely destroy its value as an historical authority. The work, edited by H. T. Riley, forms vol. xxix. of Bohn's Antiquarian Library. Two elaborate papers by Mr Riley in opposition to its authenticity are contained in the *Archæological Journal*, March and June 1862. A full account of it is also given in Hardy's *Rerum Britannicarum Medii Ævi Scriptores*, vol. ii., 1865.

**INHERITANCE.** In English law, inheritance, heir, and other kindred words have a meaning very different from that of the Latin *heres*, from which they are derived. In Roman law the heir or heirs represented the entire legal personality of the deceased—his *universum jus*. In English law the heir is simply the person on whom the real property of the deceased devolves by operation of law if he dies intestate. He has nothing to do as heir with the personal property; he is not appointed by will; and except in the case of coparceners he is a single individual. The Roman *heres* takes the whole estate; his appointment may or may not be by testament; and more persons than one may be associated together as heirs.

The devolution of an inheritance in England is now regulated by the rules of descent, as altered by the Inheritance Act (3 & 4 Will. IV. c. 106), amended by 22 & 23 Vict. c. 35. 1. The first rule is that inheritance shall descend to the issue of the last "purchaser." A purchaser in law means one who acquires an estate otherwise than by descent, *e.g.*, by will, by gratuitous gift, or by purchase in the ordinary meaning of the word. This rule is one of the changes introduced by the Inheritance Act, which further provides that "the person last entitled to the land shall be considered the purchaser thereof unless it be proved that he inherited the same." Under the earlier law descent was traced from the last person who had "seisin" or feudal possession, and it was occasionally a troublesome question whether the heir or person entitled had ever, in fact, acquired such possession. Now the only inquiry is into title, and each person entitled is presumed to be in by purchase unless he is proved to be in by descent, so that the stock of descent is the last person entitled who cannot be shown to have inherited. 2. The male is admitted before the female. 3. Among males of equal degree in consanguinity to the purchaser, the eldest excludes the younger; but females of the same degree take together as "coparceners." 4. Lineal descendants take the place of their ancestor. Thus an eldest son dying and leaving issue would be represented by such issue, who would exclude their father's brothers and sisters. 5. If there are no lineal descendants of the purchaser, the next to inherit is his nearest lineal ancestor. This is a new rule introduced by the Inheritance Act. Under the former law inheritance never went to an ancestor,—collaterals, however remote, of the person last seized being preferred even to his father. Various explanations have been given of this seemingly anomalous rule,—Bracton and Blackstone being content to say that it rests on the law of nature, by which heavy bodies gravitate downwards. Another explanation is that estates were granted to be descendible in the same way as an ancient inheritance, which having passed from father to son *ex necessitate* went to collaterals on failure of issue of the person last seized. 6. The sixth rule is thus expressed by Mr Joshua Williams in his excellent treatise on *The Law of Real Property*: "The father and all the male paternal ancestors of the purchaser and their descendants shall be admitted before any of the female paternal ancestors or their heirs; all the female paternal ancestors and their heirs before the mother or any of the maternal ancestors or her or their descendants; and the mother and all the male maternal ancestors and her and their descendants before any of the female maternal ancestors or their heirs." 7. A kinsman of the whole blood shall come before the same degree of the half blood. The admission of kinsmen of the half blood into the chain of descent is one of the alterations made by the Inheritance Act. Formerly a relative, however nearly connected in blood with the purchaser through one only and not both parents, could never inherit—a half-brother for example; while relatives of the whole blood, however distant, might inherit to the

exclusion of nearer relatives of the half blood. 8. In the admission of female paternal ancestors, the mother of the more remote male paternal ancestor and her heirs shall be preferred to the mother of the less remote male paternal and her heirs; and, in the case of female maternal ancestors, the mother of the more remote male maternal ancestor shall be preferred to the mother of a less remote male maternal ancestor. This rule, following the opinion of Blackstone, settles a point which has been much disputed by text-writers, although its importance was little more than theoretical. 9. When there shall be a total failure of heirs of the purchaser, or when any lands shall be descendible as if an ancestor had been the purchaser thereof, and there shall be a total failure of the heirs of such ancestor, then and in every such case the descent shall be traced from the person last entitled to the land as if he had been the purchaser thereof. This rule is enacted by 22 & 23 Vict. c. 35. It would apply to such a case as the following:—Purchaser dies intestate, leaving a son and no other relations, and the son in turn dies intestate; the son's relations through his mother are now admitted by this rule. If the purchaser is illegitimate, his only relations must necessarily be his own issue. Failing heirs of all kinds, the lands of an intestate purchaser, not alienated by him, would revert by "escheat" to the next immediate lord of the fee, who would generally be the crown. If an intermediate lordship could be proved to exist between the crown and the tenant in fee simple, such intermediate lord would have the escheat. But escheat in any case is a matter of rare occurrence.

The descent of an estate in tail would be ascertained by such of the foregoing rules as are not inapplicable to it by the necessity of the case. By the form of the entail the estate descends to the "issue" of the person to whom the estate was given in tail,—in other words, the last purchaser. The preceding rules after the fourth, being intended for the ascertainment of heirs other than those by lineal descent, would therefore not apply; and a special limitation in the entail, such as to heirs male or female only, would render unnecessary some of the others. When the entail has been barred, the estate of course descends according to these rules. In copyhold estates descent, like other incidents thereof, is regulated by the custom of each particular manor; *e.g.*, the youngest son may exclude the elder sons. How far the Inheritance Act applies to such estates has been seriously disputed. It has been held in one case (*Muggleton v. Barnett*) that the Inheritance Act, which orders descent to be traced from the last purchaser, does not override a manorial custom to trace descent from the person last seized, but this position has been controverted on the ground that the Act itself includes the case of customary holdings.

Husband and wife do not stand in the rank of heir to each other. Their interests in each other's real property are secured by curtesy and dower. See **HUSBAND AND WIFE**.

The personal property of a person dying intestate devolves according to an entirely different set of rules, which will be found under the head of **INTESTACY**.

In the law of Scotland the rules of descent differ from the above in several particulars. Descent is traced, as in England before the Inheritance Act, to the person last seized. The first to succeed are the lineal descendants of the deceased, and the rules of primogeniture, preference of males to females, equal succession of females (heirs-portioners), and representation of ancestors, are generally the same as in English law. Next to the lineal descendants, and failing them, come the brothers and sisters, and their issue as collaterals. Failing collaterals, the inheritance ascends to the father and his relations, to the entire exclusion of the mother and her relations. Even when the estate has descended from mother to son, it can never again revert to the maternal line. As to succession of brothers, a distinction must be taken between an estate of heritage and an estate of conquest. Conquest is whole



the deceased has acquired the land otherwise than as heir, and corresponds to the English term purchase in the technical sense explained above. Heritage is land acquired by deceased as heir. The distinction is important only in the case when the heir of the deceased is to be sought among his brothers; when the descent is lineal, conquest and heritage go to the same person. And when the brothers are younger than the deceased, both conquest and heritage go to the brother (or his issue) next in order of age. But when the deceased leaves an elder and a younger brother (or their issues), the elder brother takes the conquest, the younger takes the heritage. Again, when there are several elder brothers, the one next in age to the deceased takes the conquest before the more remote; and when there are several younger brothers, the one next to the deceased takes the heritage before the more remote. When heritage of the deceased goes to an elder brother (as might happen in certain eventualities), the younger of the elder brothers is preferred. The position of the father, after the brothers and sisters of the deceased, will be noticed as an important point of difference from the English axioms; so also is the total exclusion of the mother and the maternal line. After brothers and sisters and their issue have been exhausted, the heir is sought among the relations of the father; but even when these are exhausted, the estate, although it should have descended *ex parte materna*, can never revert to the maternal line. As between brothers and sisters the half-blood only succeeds after the full blood. Half-blood is either consanguinean, as between children by the same father, or uterine, as between children having the same mother. The half-blood uterine is excluded altogether. Half-blood consanguinean succeeds thus: if the issue is by a former marriage, the youngest brother (being nearest to the deceased of the consanguinean) succeeds first; if by a later marriage than that from which the deceased has sprung, the eldest succeeds first.

In the United States the English law of inheritance has been more completely repudiated than any other portion of our system. Each State has established rules of descent for itself, and the observation of Chief Justice Reeve that the action "has no general law of descents, which probably has not fallen to the lot of any other country," is to some extent justified by the great differences in detail between the rules obtaining in the different States. The following are the rules of most general application, as stated in Kent's *Commentaries on American Law*, twelfth edition, edited by O. W. Holmes, jun. 1. Real estate shall descend to the lawful descendants of the owner, in the direct line of lineal descent; and if there be but one person, then to him or her alone; and if more than one person, and all of equal degrees of consanguinity to the ancestor, then to the several persons or tenants in common in equal parts, however remote from the intestate the common degrees of consanguinity may be. 2. When the lawful issue are of unequal degrees of consanguinity to the intestate, the inheritance shall descend to the children and grandchildren, if any be living, and to the issue of such as shall be dead, as tenants in common; but such grandchildren and their descendants inherit only such shares as their parents respectively would have taken if living. These two rules are stated to prevail in all the United States, with some important variations, however, in the case of the first rule. 3. In the absence of descendants the inheritance goes to the parents, either first to the father and next to the mother, or jointly under certain conditions. This canon is described as prevailing "to a considerable extent." 4. If the intestate dies without issue or parents the estate goes to his brothers and sisters and their representatives. If the relatives are of equal degrees of consanguinity they take in equal parts; but if, of the same degree, some be dead, leaving issue, and others living, the descendants of those who are dead take only their parents' share. Collaterals under this rule would be preferred to ascendants—after parents. "It is perhaps universally the rule that brothers and sisters are preferred to grandparents, though the latter stand in an equal degree of kindred" (Kent, vol. iv. p. 401). In some States there is no essential distinction left between the whole and the half-blood, in others the half-blood is postponed, but nowhere is it totally excluded. 5. In default of the foregoing, the inheritance generally goes to grandparents, but in some States (New York, New Jersey, and North Carolina) grandparents are excluded, and in others postponed. 6. Next come uncles and aunts and their descendants, taking *per capita* if of equal degree, and *per stirpes* if not. 7. If the inheritance came to the deceased on the part of his father, the father's brothers and sisters would exclude the mother's brothers and sisters, and the mother's brothers and sisters would have a similar preference in respect of property coming to the deceased *ex parte materna*. A similar distinction is observed in some States in applying the fourth rule. 8. On failure of heirs under the preceding rules, recourse is had to the "next-of-kin" as ascertained by the English statute of distributions. In many of the States the harshness of the English rule that natural children have no inheritable blood is greatly mitigated. In Louisiana, if duly acknowledged, they may inherit from both father and mother in the absence of lawful issue.

A full summary of the rules of descent prescribed by the statute law of the various States of the Union, will be found in a note appended to the first chapter of Washburn's *American Law of Real Property*, vol. iii., Boston, 1868.

INJUNCTION, in English law, is a judicial process whereby a party is required to refrain from doing a particular thing according to the exigency of the writ (Daniel's *Chancery Practice*). Formerly it was a remedy peculiar to the Court of Chancery, and was one of the instruments by which the jurisdiction of that court was established in cases over which the courts of common law were entitled to exercise control. The Court of Chancery did not presume to interfere with the action of the courts, but, by directing an injunction to the person whom it wished to restrain from following a particular remedy at common law, it effected the same purpose indirectly. Under the present constitution of the judicature, the peculiar features of the injunction have been considerably altered. It is now equally available in all the divisions of the high court of justice, and it can no longer be used to prevent an action in any of them from proceeding in the ordinary course.

From the definition given above it is apparent that an injunction is properly a restraining order, although there are instances in which, under the form of a prohibition, a positive order to do something is virtually expressed. Thus in a case of nuisance an injunction was obtained to restrain the defendant from preventing water from flowing in such regular quantities as it had ordinarily done before the day on which the nuisance commenced. But generally, if the relief prayed for is to compel something to be done, it cannot be obtained by injunction, although it may be expressed in the form of a prohibition—as in the case in which it was sought to prevent a person from discontinuing to keep a house as an inn, which is the same thing as ordering him to keep an inn. The injunction was used to stay proceedings in other courts "wherever a party by fraud, accident, mistake, or otherwise had obtained an advantage in proceeding in a court of ordinary jurisdiction, which must necessarily make that court an instrument of injustice." As the injunction operates personally on the defendant, it may be used to prevent applications to foreign judicatures; but it is not used to prevent applications to parliament, or to the legislature of any foreign country, unless such applications be in breach of some agreement, and relate to matters of private interest. In so far as an injunction is used to prohibit acts, it may be founded either on an alleged contract or on a right independent of contract. The jurisdiction of the court to prevent breaches of contract has been described as supplemental to its power of compelling specific performance; *i.e.*, if the court has power to compel a person to perform a contract, it will interfere to prevent him from doing anything in violation of it. In the case of contracts to abstain from doing, injunction is in fact a means of compelling specific performance. But even when it is not within the power of the court to compel specific performance, it may interfere by injunction; thus, *e.g.*, in the case of an agreement of a singer to perform at the plaintiff's theatre and at no other, the court, although it could not compel her to sing, could by injunction prevent her from singing elsewhere in breach of her agreement. In other matters, an injunction may as a general rule be obtained to prevent acts which are violations of legal rights, except when the same may be adequately remedied by an action for damages at law. Thus the court will interfere by injunction to prevent waste, or the destruction by a limited owner, such as a tenant for life, of things forming part of the inheritance. Injunctions may also be obtained to prevent the continuance of nuisances, public or private, the infringement of patents, copyrights, and trade marks. Trespass might also be prevented by injunction, in certain cases, alluded to below. Under the Common Law Pro



cedure Act of 1854, and by other statutes in special cases, a limited power of injunction was conferred on the courts of common law. But the Judicature Act, by which all the superior courts of common law and chancery are consolidated, enacts that an injunction may be granted by an interlocutory order of the court in all cases in which it shall appear to be just or convenient; . . . and, if an injunction is asked either before or at or after the hearing of any cause or matter, to prevent any threatened or apprehended waste or trespass, such injunction may be granted whether the person against whom it is sought is or is not in possession under any claim of title or otherwise, or if not in possession does or does not claim to do the act sought to be restrained under colour of any title, and whether the estates claimed are legal or equitable.

An injunction obtained on interlocutory application during the progress of an action is superseded by the trial. It may be continued either provisionally or permanently. In the latter case the injunction is said to be perpetual. The distinction between "special" and "common" injunctions—the latter being obtained as of course—is now abolished in English law. The practice as to injunctions obtains in the United States of America. "In the courts of the United States, as injunctions are grantable only on notice to the adverse party, all interlocutory injunctions are regarded as within the class of special injunction; and this is believed to be also the practice of the State courts generally" (*Abbott's Law Dictionary*). For the analogous Scotch practice see INTERDICT.

INK (French, *encre*; German, *Tinte*), in its widest signification, is the medium employed for producing graphic tracings, inscriptions, or impressions on paper or similar materials. The term includes two distinct conditions of pigment or colouring matter:—the one fluid, and prepared for use with a pen or brush, as writing ink; the other a glutinous adhesive mass, printing ink, used for transferring to paper impressions from types, engraved plates, and other like surfaces. The latter class may be more properly dealt with under LITHOGRAPHY and PRINTING (*q.v.*).

Writing inks are fluid substances which contain colouring matter either in solution or in suspension, and very commonly partly in both conditions. They may be prepared in all shades of colour, and contain in their composition almost every pigment which can be dissolved or suspended in a suitable medium; but by far the most important of all varieties is black ink, after which red and blue are the colours most commonly employed. Other colours are only occasionally employed; but apart from colour there are special qualities which recommend certain inks for limited applications, such as marking inks, ineradicable ink, sympathetic ink, &c.

*Black Ink.*—Among the qualities which should characterize a good black ink for ordinary purposes, the following are important. It should continue limpid, and flow freely and uniformly from the pen; it should not throw down a thick sludgy deposit on exposure to the air; nor should a coating of mould form on its surface. It should yield distinctly legible characters immediately on writing, which ought to become a deep blue-black, not fading or decaying with age; and the fluid ought to penetrate into the paper without spreading, so that the characters will neither wash out nor be readily removed by erasure. Further, it is desirable that ink should be non-poisonous, that it should as little as possible corrode steel pens, that characters traced in it should dry readily on the application of blotting paper without smearing, and that the writing should not present a glossy varnished appearance. To obtain these characteristics is the chief object of the ink manufacturer; and upon the whole they have hitherto been found best combined in ink prepared from galls, or

other sources of tannin, and a salt of iron, with the addition of some colouring matter. Such a compound indeed forms the staple black ink of commerce, which is essentially a ferroso-ferric gallate in extremely fine division held in suspension in water.

The essential ingredients of this ordinary black ink are—first, tannin-yielding bodies, for which Aleppo or Chinese galls are the only eligible materials; second, a salt of iron, the ferrous sulphate (green vitriol) being alone employed; and third, a gummy or mucilaginous agent to keep in suspension the insoluble tinctorial matter of the ink. For ink-making the tannin, from whatever source obtained, has first to be transformed into gallic acid; and, as has been shown by Viedt, in the case of Aleppo galls that change takes place by fermentation when the solution of the galls is exposed to the air, the tannin splitting up into gallic acid and sugar (see GALLIC ACID, vol. x. p. 41). Chinese galls, which formerly were considered unsuitable for the manufacture of ink, do not contain the ferment necessary for inducing this change; and therefore to induce the process yeast must be added to their solution. To prepare a solution of Aleppo galls for ink-making, the galls are coarsely powdered, and intimately mixed with chopped straw. This mixture is thrown into a narrow deep oak vat, provided with a perforated false bottom, and having a tap at the bottom for drawing off liquid. Over the mixture is poured lukewarm water, which, percolating down, extracts and carries with it the tannin of the galls. The solution is drawn off and repeatedly run through the mixture to extract the whole of the tannin, the quantity of water used being in such proportion to the galls as will produce as nearly as possible a solution having 5 per cent. of tannin. The object of using straw in the extraction process is to maintain the porosity of the mixture, as powdered galls treated alone become so slimy with mucilaginous extract that liquid fails to percolate the mass. For each litre of the 5 per cent. solution about 45 grammes of the iron salt are used, or about 100 parts of tannin for 90 parts of crystallized green vitriol. These ingredients when first mixed form a clear solution, but on their exposure to the air oxidation occurs, and an insoluble blue-black ferroso-ferric gallate in extremely fine division, suspended in a coloured solution of ferrous gallate, is formed. To keep the insoluble portion suspended, a mucilaginous agent is employed, and that most available is gum senegal. An ink so prepared develops its intensity of colour only after some exposure; and after it has partly sunk into the paper it becomes oxidized there, and so mordanted into the fibre. But, as the first faintness of the characters is a disadvantage, it is a common practice to add some adventitious colouring matter to give immediate distinctness, and for that purpose either extract of logwood or a solution of indigo is used. When logwood extract is employed, a smaller proportion of extract of galls is required, from the fact that logwood itself contains a large percentage of tannin. Black ink in which the provisional colouring matter is indigo was introduced about the year 1856, under the name alizarin ink, although the substance alizarin has nothing whatever to do with the preparation. The indigo for this ink is dissolved in strong sulphuric acid, and the ferrous sulphate, instead of being used direct, is prepared by placing in this indigo solution a proper quantity of scrap iron. In order to free the solution from excess of uncombined acid, chalk or powdered limestone is added, whereby the free acid is fixed and a deposit of sulphate of lime formed. A solution so prepared, mixed with a tannin solution, yields a very limpid sea-green writing fluid, and as all the constituents remain in solution, no gum or other suspending medium is necessary. In consequence the ink flows freely, is easily dried, and is free from the glossy

appearance which arises through the use of gum. C. H. Viedt of Brunswick, who has written very exhaustively on all kinds of ink, gives the following as the standard ingredients of these three varieties of ink:—

	Galls Ink	Galls-logwood Ink	Galls-indigo Ink.
Tannin extract, 5 per cent.	1 litre	$\frac{3}{4}$ litre	1 litre
Ferrous sulphate.....	45 grammes	45 grammes	..
Gum senegal.....	20-30 ,,	20-30 ,,	..
Logwood solution, 3 per cent.	..	$\frac{1}{2}$ litre	..
Metallic iron.....	..	..	9 grammes
Indigo.....	..	..	6 $\frac{1}{2}$ ,,
Concentrated sulphuric acid.....	..	..	25 ,,
Chalk.....	..	..	1 ,,

On long exposure to air, as in inkstands, or otherwise, all these varieties of ink gradually become thick and ropy, depositing a slimy sediment. This change on exposure is inevitable, resulting as it does from the gradual and at the same time essential oxidation of the ferrous compound, and it can only be retarded by permitting access of air to as small surfaces as possible. The inks also have a tendency to become mouldy, an evil which may be obviated by the use of a minute proportion of carbolic acid; or, should that body be objectionable on account of its smell, salicylic acid may be used.

Under the name of chrome ink a black ink was discovered and prepared by the chemist Runge, which held out the promise of cheapness combined with many excellent qualities. It is prepared by dissolving 15 parts of extract of logwood in 900 parts of water, to which 4 parts of crystallized sodic carbonate are added. A further solution of 1 part of chromate (not bichromate) of potassium in 100 parts of water is prepared, and is added very gradually to the other solution with constant agitation. Thereby is obtained an ink which possesses an intense blue-black colour, which flows freely and dries readily, which being neutral in reaction does not corrode steel pens, and which so adheres to and sinks into paper that manuscripts written with it may be freely washed with a sponge without danger of smearing or spreading. It forms a good copying ink, and in short it possesses all the qualities essential to the best ink; but unfortunately on exposure to air it very readily undergoes decomposition, the colouring matter separating in broad flakes, which swim in a clear menstruum. It is affirmed by Viedt that this drawback may be overcome by the use of soda, a method first suggested by Böttger.

Logwood forms the principal ingredient in various other black inks which are now much used, especially as copying ink. A very strong decoction of logwood or a strong solution of the extract with ammonia-alum yields a violet ink which darkens slowly on exposure. Such an ink is costly, however, on account of the concentrated condition in which the logwood must be used. If, however, a metallic salt is introduced, a serviceable ink is obtained with the expenditure of much less logwood. Either sulphate of copper or sulphate of iron may be used, but the former, which produces a pleasing blue-black colour, is to be preferred. The following is the formula most highly recommended for this ink. A clear solution of 20 kilos of extract of logwood in 200 litres of water is obtained, to which is added, with agitation, 10 kilos of ammonia-alum dissolved in 20 litres of boiling water. The solution is acidified with 0.2 kilo of sulphuric acid, which has the effect of preventing any deposit, and finally there is added a solution of 1.5 kilos of sulphate of copper dissolved in 20 litres of water. This compound is exposed to the air for a few days to allow the colour to develop by oxidation, after which it is stored in well-corked bottles. The acid condition of this ink has a

corrosive influence on steel pens; but in all other respects it is a most valuable writing fluid.

A black ink under the name of vigrosin is prepared from a soluble aniline colour, which, although not producing a black so intense as common ink, is possessed of various advantages. Being perfectly neutral, it does not attack pens; it can easily be kept of a proper consistency by making up with water; and its colour is not injuriously affected by the action of acids.

*Copying Ink.*—Ink which yields by means of pressure an impression, on a sheet of damped tissue paper, of characters written in it is called copying ink. Any ink soluble in water, or which retains a certain degree of solubility, may be used as copying ink. Runge's chrome ink, being a soluble compound, is, therefore, so available; and the other logwood inks as well as the ordinary ferrous gallate inks contain also soluble constituents, and indeed are essentially soluble till they are oxidized in and on the paper after exposure to the air. To render these available as copying inks it is only necessary to add to them a substance which will retard the oxidizing effect of the air for some time. For this purpose the bodies most serviceable are gum arabic or senegal, with glycerin, dextrin, or sugar, which last, however, has the disadvantage of rendering the ink sticky. These substances act by forming a kind of glaze or varnish over the surface of the ink which excludes the air. At the same time when the damp sheet of tissue paper is applied to the writing they dissolve and allow a portion of the yet soluble ink to be absorbed by the moistened tissue. As copying ink has to yield two or more impressions, it is necessary that it should be made stronger, *i.e.*, that it should contain more pigment or body than common ink. It, therefore, is prepared with from 30 to 40 per cent. less of water than non-copying kinds; but otherwise, except in the presence of the ingredients above alluded to, the inks are quite the same.

*Red Ink.*—The pigment most commonly employed as the basis of red ink is Brazil-wood, a dye-stuff which yields a good durable ink. Such an ink is prepared by adding to a strong decoction of the wood a proportion of stannous chloride (tin spirits), and thickening the resulting fluid with gum arabic. In some instances alum and cream of tartar are used instead of the stannous chloride. Cochineal is also employed as the tinctorial basis of red ink; but, while the resulting fluid is much more brilliant than that obtained from Brazil-wood, it is not quite so permanent. A very brilliant red ink may be prepared by dissolving carmine in a solution of caustic ammonia, but it is necessary to keep this preparation in closely stoppered bottles. A useful red ink may also be made by dissolving the rosein of Brooke, Simpson, and Spiller in water, in the proportion of 1 to from 150 to 200 parts.

*Blue Ink.*—For the production of blue ink the pigment principally used is Prussian blue. To render this colour soluble in water it is first digested for two or three days with either strong hydrochloric acid, sulphuric acid, or nitric acid, the digested mass is next very largely diluted with water, and after settling the supernatant liquid is siphoned away from the sediment. This sediment is repeatedly washed, till all traces of iron and free acid disappear from the water used, after which it is dried and mixed with oxalic acid in the proportion of 8 parts of Prussian blue to 1 of the acid, and in this condition the material is ready for dissolving in water to the degree of colour intensity necessary. An aniline blue ink may be prepared by dissolving 1 part of bleu de Paris in from 200 to 250 parts of water.

*China ink or Indian ink* is the form in which ink was earliest prepared, and in which it is still made and used in China and Japan for writing with small brushes instead of pens. It is extensively used by architects, engineers, and artists generally, and for various special uses. China ink is prepared in the form of sticks and cakes, which are rubbed down in water for use. It consists essentially of lamp-black in very fine condition, baked up with a glutinous substance; and the finer Oriental kinds are delicately perfumed. The following description of the manufacture as conducted in Japan is from a native source:—"The body of the ink is soot obtained from pine wood or rosin, and lamp-black from sesamum oil for the finest sort. This is mixed with liquid glue made of ox skin. This operation is effected in a large round copper bowl, formed of two spherical calottes, placed 1 inch apart, so that the space between can be filled up with hot water to prevent the glue from hardening during the time it is being mixed by hand with the lamp-black. The cakes are formed in wooden moulds, and dried between paper and ashes. Camphor, or a peculiar mixture of scents which comes from China, and a small quantity of carthamine (the red colouring substance of safflower), are added to the best kinds for improving the colour as well as for scenting the ink. There is a great difference both in price and in quality of the various kinds of ink, the finest article being rather costly." It is said that the size used in Chinese kinds is of vegetable origin.



**Marking Ink.**—The ink so called, used principally for marking linen, is composed of a salt of silver, usually the nitrate, dissolved in water and ammonia, with a little provisional colouring matter and gum for thickening. The colour resulting from the silver salt is developed by heat and light; and the stain it makes, although exceedingly obstinate, gradually becomes a faint brownish-yellow. The following yields a good marking ink. Equal parts of nitrate of silver and dry tartaric acid are triturated in a mortar, and treated with water, when a reaction takes place, resulting in the formation of tartrate of silver and the liberation of nitric acid. The acid is neutralized, and at the same time the silver tartrate is dissolved by the addition of ammonia, and this solution with colouring matter and gum forms the ink, which may be used with an ordinary steel pen.

**Gold and silver inks** are writing fluids in which gold and silver, or imitations of these metals, are suspended in a state of fine division; in place of gold, Dutch leaf or mosaic gold is frequently substituted, and bronze powders are also used for preparing a similar kind of ink. The metallic foil is first carefully triturated into a fine paste with honey, after which it is boiled in water containing a little alkali, and then repeatedly washed in hot water and dried at a gentle heat. A solution is prepared consisting of 1 part of pure gum arabic and 1 part of soluble potash glass in 4 parts of distilled water, into which the requisite quantity of the metallic powder prepared as above is introduced. Owing to the superior covering nature of pure gold, less of the metal is required than is necessary in the case of silver and other foils; but the proportion varies according to the colour and condition of the surface upon which the ink is to be used. In general 1 part of foil to 3 or 4 parts of solution is sufficient. The metallic lustre of writing done with this solution may be greatly lightened by gently polishing with a burnishing point.

**Indelible or incorrallible ink** is the name given to various combinations of lamp-black or other carbonaceous material with resinous substances used for writing which is exposed to the weather or to the action of strong acids or alkaline solutions. An ink having great resisting powers may be conveniently prepared by rubbing down Indian ink in common ink till the mixture flows easily from the pen. Other combinations have more the character of coloured varnishes.

**Sympathetic inks** are preparations used for forming characters which only become visible on the application of heat or of some chemical reagent. Many chemicals which form in themselves colourless solutions, but which develop colour under the influence of reagents, may be used as sympathetic ink, but they are all of little practical utility. Characters written in a weak solution of galls develop a dark colour on being treated with a solution of coppers; or, *vice versa*, the writing may be done in coppers and developed by the galls solution. Writing done in various preparations develops colour on heating which fades as the paper cools. Among such substances are solutions of the acetate and the chloride of cobalt and of the chloride of nickel. Very dilute solutions of the mineral acids and of common salt and a solution of equal parts of sulphate of copper and sal-ammoniac act similarly. Characters traced in a weak solution of nitrate of silver darken on exposure to light, and terchloride of gold solution develops a purple colour on exposure. (J. P. A.)

**INLAYING** is a method of ornamentation, by incrusting or otherwise inserting in one material a substance or substances differing therefrom in colour or nature. The art is practised in the fabrication of furniture and artistic objects in all varieties of wood, metal, shell, ivory, and coloured and hard stone, and in compound substances; and the possible combinations, styles, and varieties of effect are exceedingly numerous. There are several special classes of inlaying, long established and well recognized, which may be here enumerated and defined, details regarding most of which will be found under their separate headings. In the ornamental treatment of metal surfaces *Niello* decoration, applied to silver and gold, is an ancient and much practised species of inlaying. It consists in filling up engraved designs with a composition of silver, copper, lead, and sulphur incorporated by heat. The composition is black, and the finished work has the appearance of a drawing in black on a metallic plate. An art, analogous in effect, called *Bidri*, from Bider in the Deccan, is practised in India. In bidri work the ground is an alloy of zinc, with small proportions of copper and lead, in which shallow patterns and devices are traced, and filled up with thin plates of silver. When the surface has been evened and smoothed, the bidri ground is stained a permanent

black by means of a paste the chief ingredients of which are sal-ammoniac and nitre, leaving a pleasing contrast of bright metallic silver in a dead black ground. The inlaying of gold wire in iron or steel is known as *DAMASKEENING* (*q. v.*, vol. vi. p. 793). It has been very largely practised in Persia and India for the ornamentation of arms and armour, being known in the latter country as *Kuft work* or *Kuftgari*. In Kashmir, vessels of copper and brass are very effectively inlaid with tin,—an art which, like many other decorative arts, appears to have originated in Persia. In the ornamental inlaying of metal surfaces the Japanese display the most extraordinary skill and perfection of workmanship. In the inlaying of their fine bronzes they use principally gold and silver, but for large articles and also for common cast hollow ware (for with them inlaying is common and profuse) commoner metals and alloys are employed. In inlaying bronzes they generally hollow out and somewhat undercut the design, into which the ornamenting metal, usually in the form of wire, is laid and hammered over so as to be firmly inserted. Frequently the famous lacquer work of the Japanese is inlaid with mother-of-pearl and other substances, in the same manner as is practised in ornamenting lacquered papier-mâché among Western communities. The Japanese also practise the various methods of inlaying alluded to under *DAMASKEENING*. The term *Mosaic* (see *MOSAIC*) is generally applied to inlaid work in hard stones, marble, and glass, but the most important class of mosaics—those which consist of innumerable small separate pieces—do not properly come under the head of inlaying. Inlaid mosaics are those in which coloured designs are inserted in spaces cut in a solid ground or basis, such, for example, as the modern Florentine mosaic, which consists of thin veneers of precious coloured stones set in slabs of marble. The famous Taj Mahal at Agra is an example of inlaid mosaic in white marble, and the art, carried to that city by a French artist, is still practised by native workmen. *Pietra Dura* is a fine variety of inlaid mosaic in which hard and expensive stones—agate, carnelian, amethyst, and the like—are used in relief in marble. Under the head *Buhl Work* (vol. iv. p. 446) will be found a description of the kind of inlaying, principally brass and tortoiseshell, which was introduced and carried to great perfection by André Charles Boule, who gave his name to this particular style of inlaying. Closely allied to buhl work is the more ancient *Tarsia* work or *Marquetry*, which consists of inlaid woods alone. It has been practised from remote times, but came into prominence, for the decoration of furniture, in Italy during the Renaissance epoch, and has continued to be a favourite decorative art, varying with changing tastes and styles, to the present day. From India, under the name of Bombay boxes, comes a variety of minute and elaborate work, inlaid in geometrical patterns on wood. The inlaying materials consist of tin wire, sandal wood, sapan wood, ebony, ivory, and stag's horns, and the effect produced by the combination of minute pieces of these various substances is altogether peculiar and distinctive. Certain kinds of *ENAMEL* (vol. viii. p. 182) might also be included among the varieties of inlaying.

**INNKEEPERS, LAW RELATING TO.** By the common law of England innkeepers are under certain peculiar obligations, the most important of which are the duty of supplying accommodation to such travellers as may desire it, and their responsibility for the safety of the goods belonging to persons staying in their inns. An inn is a place "instituted for passengers and wayfaring men," and in a recent case, in which the proprietor of a restaurant was prosecuted for refusing refreshment on demand, it was held that a tavern, or shop for the retail of spirits across the counter, is not within the definition, and that a person



resident in the neighbourhood of the inn is not a traveller. An innkeeper may be indicted for refusing accommodation to a traveller, who may also of course have a remedy by civil action. To render an innkeeper liable for loss of goods at common law, the following are stated by Chitty (*Law of Contracts*) to be necessary conditions:—(1) that the inn be a "common" inn; (2) that the guest be a traveller or passenger; (3) that the goods or chattels must be in the inn, or at all events under the protection of the innkeeper as such; (4) that there be default on the part of the innkeeper, which is, however, implied in all cases not arising from the negligence of the guest, the act of God, or of the queen's enemies. An innkeeper receiving goods in any other capacity, *e.g.*, as a warehouseman or generally as bailee, or allowing the guest exclusive possession of a room for special purposes, is not liable for loss. Nor is the innkeeper liable for loss of goods by the theft of the guest's servant or companion, or by the negligence of the guest himself. A recent Act, 26 & 27 Vict. c. 4, limits the liability of the innkeeper by the following provisions:—No innkeeper shall be liable to make good loss or injury to goods or property (not being a horse, or other live animal, or gear appertaining thereto, or a carriage) to a greater sum than £30, except in the following cases—(1) when the loss has been caused by the default or neglect of the innkeeper or his servants, (2) when such goods have been deposited expressly for safe custody with the innkeeper, who may require them to be deposited in a safe or other receptacle and sealed by the person depositing the same. Innkeepers are not entitled to the benefit of the Act if they refuse to receive goods for safe custody, or otherwise prevent their deposit as before provided for, or if they fail to have one copy at least of the first section of the Act exhibited in a conspicuous place in the inn. The liability of innkeepers was recognized in the civil law. On the other hand, the innkeeper has a lien on the goods of his guest for the amount of his bill. It does not extend to the clothes of the guest or justify his personal detention, but it includes articles in the possession of the guest belonging to third persons, at least when they are of a kind that travellers might ordinarily be expected to have. When a professional artist living at an inn had a piano on hire, the innkeeper, who knew it did not belong to her, was held to have no lien thereon. In a recent case the lien has been held to cover a hired piano in the possession of a family staying at an inn. In some American cases it has been held that the possession of a licence does not produce, nor does the absence of a licence prevent, the liabilities of an innkeeper at common law. An inn is distinguished from a boarding-house in this, that in the latter the guest is under an express contract for a certain time at a certain rate, in the former under an implied contract from day to day. Even if a boarding-house keeper entertains guests in the capacity of an innkeeper, he is not liable as such to his boarding-house guests.

INNOCENT I., pope from 402 to 417, was, according to his biographer in the *Liber Pontificalis*, the son of a man called Innocent of Albano; but, according to the more trustworthy Jerome, his father was Pope Anastasius I., whom he was called by the unanimous voice of the clergy and laity to succeed. It was during his papacy that the siege of Rome by Alaric (408) took place, when, according to a doubtful anecdote of Zosimus, the ravages of plague and famine were so frightful, and divine help seemed so far off, that papal permission was granted to sacrifice and pray to the heathen deities; the pope happened, however, to be absent from the city on a mission to Honorius at Ravenna at the time of the sack in 410. He lost no opportunity of maintaining and extending the authority of the

Roman see as the ultimate resort for the settlement of all disputes; and his still extant communications to Victorius of Rouen, Exuperius of Toulouse, Alexander of Antioch, and others, as well as his action on the appeal made to him by Chrysostom against Theophilus of Alexandria, show that opportunities of the kind were numerous and varied. He took a decided view on the Pelagian controversy, confirming the decisions of the synod of the province of proconsular Africa held in Carthage in 416, which had been sent to him, and also writing in the same year in a similar sense to the fathers of the Numidian synod of Mileve who, Augustine being one of their number, had addressed him. Among his letters are one to Jerome and another to John, bishop of Jerusalem, regarding annoyances to which the first-named had been subjected by the Pelagians at Bethlehem. He died March 12, 417, and in the Romish Church is commemorated as a confessor along with Saints Nazarius, Celsus, and Victor, martyrs, on July 28. His successor was Zosimus.

INNOCENT II., pope from 1130 to 1143, whose family name was Papearesi, his own baptismal name being Gregory, was probably one of the clergy in personal attendance on the antipope Clement III. (Guibert of Ravenna). By Pascal II. he was created cardinal-deacon. In this capacity he accompanied Pope Gelasius II. when driven into France; and by Calixtus II. he was employed on various important missions, such as on that to Worms for concluding the peace concordat with the emperor in 1122, and on that to France in 1123. On February 14, 1130, he was hurriedly chosen to succeed Honorius II.; soon afterwards an opposition asserted itself which issued in the counter-election of Pietro Pierleoni as Pope Anacletus II. Unable to maintain his position in Rome, Innocent took ship for Pisa, and thence sailed by Genoa to France, where the influence of Bernard of Clairvaux readily secured his cordial recognition by the clergy and the court; in October of the same year he was duly acknowledged by Lothaire of Germany and his bishops at the synod of Würzburg. In January 1131 he had also a favourable interview with Henry II. of England; and in August 1132 Lothaire undertook an expedition to Italy for the double purpose of being crowned by the pope, and of setting aside the antipope. The coronation ultimately took place in the Lateran church (June 4, 1133), but otherwise the expedition proved abortive. A second expedition by Lothaire in 1136 was not more decisive in its results, and the protracted struggle between the rival pontiffs was terminated only by the death of Anacletus on January 25, 1138. By the Lateran council of 1139, at which Roger of Sicily, Innocent's most uncompromising foe, was excommunicated, peace was at last restored to the church. The remaining years of this pope's life were almost as barren of permanent results as the first had been; his efforts to undo the mischief wrought in Rome by the long schism were almost entirely neutralized by a struggle with the town of Tivoli in which he became involved, and by a quarrel with Louis VII. of France, in the course of which that kingdom was laid under an interdict. Innocent died September 23, 1143, and was succeeded by Celestine II. The doctrinal questions in which he was called on to interfere were those connected with the names of Abelard and Arnold of Brescia.

INNOCENT III., pope from 1198 to 1216, by far the most remarkable of the popes who have reigned under this name, and, if Gregory VII. is excepted, perhaps the greatest of all who have occupied the see of St Peter, was born at Anagni about 1160. His father, Count Trasimundo of Segni, was a member of the famous house of Conti, from which nine popes, including Gregory IX., Alexander IV., and Innocent XIII., have sprung; his mother, Claricia,

belonged to the noble Roman family of Scotti. His own baptismal name was Lothario. After receiving the rudiments of his education in Rome, he studied theology under Peter of Corbeil at Paris, and canon law at Bologna. On his return to Rome in 1181 he became a canon of St Peter's; and through family influence, combined with the increasing evidence he gave of remarkable ability, his subsequent promotion was rapid. By Gregory VIII. he was appointed one of the subdeacons, and in 1190 (while barely thirty) he was, at the instance of his maternal uncle Clement III., made cardinal-deacon of St Sergius and St Bacchus. On the death of Clement (1191), who was succeeded by Celestine III., a member of the rival house of Orsini, Cardinal Lothario was but little employed in church affairs; the unsought leisure which he now possessed he devoted to the composition of three works, two of which have come down to our times. Of these the most remarkable by far is that entitled *De Contemptu Mundi, sive de Miseria Humanæ Conditionis*, written "in not inelegant Latin," full of the best learning of that age, and everywhere manifesting the moral depth, earnestness, and insight, if also the somewhat gloomy and severe temperament, of its author.<sup>1</sup> On the death of Celestine III. (January 8, 1198), Lothario was without a day's delay unanimously chosen to succeed him; his ordination to the priesthood (hitherto he had held only deacon's orders), his episcopal consecration; and his coronation as pope (February 22, 1198), followed one another in rapid succession. The state of Europe and of the known world at that juncture was such as might have suggested even to a less able and energetic man than Innocent the ambition of once more seeking to obtain for the papacy that absolute supremacy, both spiritual and temporal, in the struggle for which his great predecessor Gregory, more than a century before him, had lost his throne, and, one might almost say, his life. The owner of the crown of Naples (Frederick II., born 1197) was an infant, incapable of protecting his dominions from the numerous adventurers by whom they were overrun; the Lombard republics were at deadly feud with one another, or rent by increasing domestic faction; the empire was convulsed by the struggles of the rival claimants to the throne rendered vacant by the death of Henry VI.; in France Philip Augustus since 1180 had been disgusting his subjects with his tyranny and scandalous vice; at Constantinople the cruel and wicked Alexius III., after dethroning his elder brother Isaac Angelus, was struggling to maintain his precarious grasp of the sceptre, while the kingdom of Jerusalem, which half a century before had extended along nearly the whole coast of Syria, was now almost entirely confined to the city of Acre. Innocent's first care was to deliver Rome itself from the claims to supreme authority asserted by the prefect, who for many years had been nominated by the emperor, but whom now he compelled to swear allegiance to himself, thus for the first time practically establishing the temporal sovereignty of the bishop of Rome over his own city. In another direction the popular rights in connexion with the choice of a "senator" were curtailed. Measures were next taken to free the so-called patrimony of St Peter from the various German adventurers who, professing to hold of the empire, had divided it amongst them. Markwald of Anweiler, duke of Ravenna, was by a papal army driven from the March of Ancona, with which he had been invested, and compelled to withdraw to the south of Italy; Conrad of Lutzenberg, duke of Spoleto, was driven into Germany; Innocent personally visited Reate, Spoleto, Perugia, Todi,

and everywhere was welcomed as sovereign and deliverer. His claim to the sovereignty of the duchy of Tuscany as heir of the countess Matilda, Hildebrand's friend, was successfully asserted next; and on the death of Constantia, widow of Henry VI. of Germany, Innocent, who had been acknowledged by her as liege lord, became, as guardian of the young Frederick II., master of the kingdom of Naples and Sicily. By the help of Walter of Brienne, Diéphold of Acerra was compelled to relax his hold of Apulia; and in 1202 the death of Markwald at Palermo removed one of the most vigorous of the many troublers of Italian peace. The rivalry between Philip of Swabia, brother of Henry VI., and the Guelph Otto of Brunswick, for the imperial crown, in the next place offered a favourable opportunity for intervention in German politics after the more immediately pressing affairs of Rome and Italy had been settled. The tardy (but not reluctant) decision finally given (March 1201) by Innocent in favour of the Guelph did not indeed avert protracted civil war, resulting in humiliation and disaster both to emperor and pope; yet ultimately the murder of Philip (June 21, 1208) paved the way for the peaceful coronation of Otto in the following year, and the long-continued efforts of Innocent seemed to have met with an absolute success when the new emperor not only ratified previously exacted promises faithfully to maintain the territories, fiefs, and rights of the see of Rome as these had been defined by the see itself, but also renounced even the small share in episcopal elections which had been reserved to the empire in the concordat of Worms. The triumph, it is true, proved a hollow one; Otto soon broke his oath, claiming the kingdom of Apulia as a fief of the empire, and losing no time in commencing a war for the subjugation of Naples. Nor did his excommunication in 1211 result greatly to the advantage of the papacy, except in so far as it strikingly showed how dangerous to the individual was a collision with the supreme spiritual power. The battle of Bouvines (July 27, 1214) finally disposed of the last hopes of Otto, but by it there was left master of the field one who was destined to prove still more formidable in his opposition to ecclesiastical ascendancy. The immense influence which the energy, persistence, and political skill of Innocent enabled him to wield throughout the whole duration of his pontificate in the affairs of the empire was equally exemplified in his relations with almost every other state of Christendom. Thus one of his first acts after his accession was to signify his disapproval of the conduct of Philip Augustus of France in dismissing his lawful wife Ingeburga of Denmark. By a rigorous interdict laid upon the kingdom from December 1199 to September 1200, the headstrong and refractory king was at last compelled to take her back with all the honour due to the queen of France. So, when in England King John began to persecute the clergy in consequence of their adherence to the cause of Stephen Langton, the papal nominee to the archbishopric of Canterbury (1207), his own excommunication followed forthwith; the kingdom was laid under an interdict (March 24, 1208), his subjects released from their allegiance, and his throne offered to any conqueror, with effects which again were far from being such as Innocent had anticipated, but which could not fail to impress the minds of the men of that time with a new and deep sense of the vigour and far-reaching power of the vicars of Christ. In Castile, in Portugal, in Leon, in Navarre, in Denmark, Bohemia, Poland, Hungary, the same story repeats itself, with equal distinctness, if with less prominent results. Another outlet of the zeal and ambition of Innocent was found in the fifth crusade, the leading events of which, including the pact with Venice and the fall of Constantinople, have been elsewhere related (vol. vi. p. 628-9). In the west also, a new crusade against here

<sup>1</sup> The other extant work belonging to this period of Innocent's life is the *Mysteriorum Evangelicæ Legis et Sacramenti Eucharistiæ Libri VI.* The *De Quadrupartita Specie Nuptiarum* has not survived.



tics was set on foot with relentless energy, which has been described in the article ALBIGENSES. The principles upon which such enterprises ought to be conducted were formulated under the presidency of Innocent at the fourth Lateran council (1215). It was there decreed that all rulers should promise to tolerate no heretics within their dominions, and that any prince who should refuse to comply with an injunction of the church to purge his dominions of heresy was to be punished with excommunication, and in case of contumacy to be deposed,—if necessary, by force of arms. To those who should take part in such application of armed force when declared necessary, immunities similar to those enjoyed by the Eastern crusaders were guaranteed. At the same time very stringent laws were made with reference to the Jews. Their disability to hold any public appointment of trust was declared, and they were prohibited from at any time wearing Christian apparel, and also from appearing in public at all during Holy Week. This council was held by Innocent in the full consciousness of his approaching dissolution, which took place at Perugia on July 16, 1216. He was succeeded by Honorius III. Apart from his other claims to fame as a sovereign and statesman of remarkable breadth of view, unity of purpose, and boldness of action, Innocent deserves notice as a canonist and as a preacher. His decisions in canon law are characterized by a learning and an acuteness which have made him an important authority. The decretals of the first three years of his pontificate were collected by Rainer of Pomposi, and afterwards Bernardus Compostellanus undertook the editing of those of the first nine years, which appeared in a collection known as the *Compilatio Romana*. This, however, contained some spurious documents, which were eliminated from the *Compilatio tertia*, brought down by Petrus Callivacinus to the twelfth year, and sent to the university of Bologna. The *Compilatio quarta*, published shortly after his death, contains the bulls and briefs of the closing six years. Some indication of Innocent's power as a preacher, which is known to have been great, can still be found in his extant sermons; while fully partaking of the curious artificiality and mannerism of the period, they abound in passages of fervid eloquence, and are everywhere characterized by deep religious and moral feeling.

For the works of Innocent III., see Migne, *Patrol. Cours. Compl.*, vols. 214-217. For his life and pontificate, vol. v. of Milman's *Latin Christianity* may be consulted; also Jorry, *Histoire du Pape Innocent III.*, Paris, 1853; Deutsch, *Papst Innocenz III. u. sein Einfluss auf die Kirche*, 1876; Wattenbach, *Gesch. d. röm. Papstthums*, 1876.

INNOCENT IV., Sinibaldo de Fieschi, pope from 1243 to 1254, belonged to one of the first families of Genoa, and, educated at Parma and Bologna, passed for one of the best canonists of his time. He had for his immediate predecessor Celestine IV., who, however, was pope for eighteen days only, and therefore the events of Innocent's pontificate practically link themselves on to those of the reign of Gregory IX. It was on occasion of Innocent's election (June 28, 1243) that Frederick II. is said to have remarked that he had lost the friendship of a cardinal and gained the enmity of a pope; the letter which he wrote, however, expressed in respectful terms the hope that an amicable settlement of the differences between the empire and the papal see might be reached. The negotiation which shortly afterwards began with this object speedily proved abortive, Frederick being unable to make the absolute submission to the pope's demands which was required of him. Finding his position in Rome insecure, Innocent secretly withdrew in the summer of 1244 to Genoa, and thence to Lyons, where he summoned a general council which met in 1245 and deposed Frederick. The agitation caused by this act throughout Europe terminated only with Frederick's death in 1250, which permitted the pope to return, first to Perugia,

and afterwards in 1253 to Rome. The remainder of his life was largely devoted to schemes for compassing the overthrow of Manfred, the natural son of Frederick II., whom the towns and the nobility had for the most part received as his father's successor. It was on a sick bed at Naples that Innocent heard of Manfred's victory at Foggia, and the tidings are said to have precipitated his death (December 7, 1254). His learning gave to the world an *Apparatus in quinque libros decretalium*, which is highly spoken of; but essentially Innocent IV. was a small-souled man, whose avarice, cowardice, cunning, and vindictiveness suggest a striking contrast with Innocent III., whose character and career, if his selection of a name may be taken as an indication, he seems to have admired and sought to follow. He was succeeded by Alexander IV.

INNOCENT V., pope from January 20 to June 22, 1276, was a native of Turantasia in Burgundy, where he was born in 1225. In early life he joined the Dominican order, in which he acquired great fame as a preacher. The only noteworthy feature of his brief and uneventful pontificate was the practical form assumed by his desire for union with the Eastern Church. He was proceeding to send legates to the Greek emperor in connexion with the recent decisions of the council of Lyons when he died. He was the author of several works in philosophy, theology, and canon law, including commentaries on the Pauline epistles and on the *Sentences* of Peter of Lombardy, and is sometimes referred to as "famosissimus doctor." His predecessor was Gregory X., and he was succeeded by Hadrian V.

INNOCENT VI., Stephen Aubert, pope at Avignon from 1352 to 1362, the successor of Clement VI., was a native of the diocese of Limoges, and, after having taught civil law at Toulouse, became bishop successively of Noyon and of Clermont. In 1342 he was raised to the dignity of cardinal. On the death of Clement VI., after the cardinals had each bound himself by a solemn agreement as to a particular line of policy should he be elected, Aubert was chosen (December 18, 1352); one of the first acts of his pontificate was to declare the paction to have been illegal and null. His subsequent policy compares favourably with that of the other Avignon popes. He brought about many needed reforms in the administration of church affairs, and by his legate, Cardinal Albornoz, who was accompanied by Rienzi, he sought to restore order in Rome, where in 1355 Charles IV. was with his permission crowned, after having previously come under an oath that he would quit the city on the day of the ceremony. It was largely through the exertions of Innocent that the peace of Bretigny (1360) between France and England was brought about. During this pontificate also John Palæologus offered to submit the Greek Church to the Roman see on condition of assistance being rendered him against John Cantacuzenus. The resources at the disposal of the pope, however, were all required for exigencies nearer home, and the offer was declined. Innocent was a liberal patron of letters, and, if the extreme severity of his measures against the Fraticelli be kept out of account, had a deservedly high reputation for justice and mercy. He died September 12, 1362, and his successor was Urban V.

INNOCENT VII., Cosimo de Migliorati, pope from 1404 to 1406, was a native of Solmona in the Abruzzi, and early distinguished himself by his learning both in civil and in canon law. By Urban VI. he was called to the papal court, and entrusted with various responsible offices, being finally promoted to the archbishopric of Ravenna, and afterwards to the bishopric of Bologna. Boniface IX. made him cardinal, and employed him as legate in several delicate and important missions. On the death of Boniface, Migliorati was unanimously chosen (October 17,



1404) to succeed him, after each of the cardinals had bound himself by a solemn obligation to employ all lawful means for the restoration of the church's unity in the event of his election, and even to resign the papal dignity should that be considered necessary to this end. The election was resisted at Rome by the Ghibelline party, but peace was maintained by the aid of Ladislaus of Naples, who thus laid Innocent under embarrassing obligations, from which he freed himself at the earliest possible moment. The assassination of some leading members of the city party by Ludovico Migliorati (a nephew of Innocent) and his friends compelled the pope to take refuge, in August 1405, at Viterbo, whence he did not return until January of the following year. These troubles furnished him with a pretext, of which he was not unwilling to avail himself, for postponing the meeting of a general council which was urged by Charles of France, the university of Paris, Rupert of Germany, and John of Castile, as the only means of healing the schism which had prevailed so long. It is hardly necessary to say that he showed no favour to the proposal that he as well as the antipope Benedict XIII. should resign in the interests of peace. He died somewhat suddenly at Rome on November 6, 1406; there is no evidence for the truth of the allegation that his death was not due to natural causes. His successor was Gregory XII.

INNOCENT VIII., Giovanni Battista Cibo, pope from 1484 to 1492, was born at Genoa (1432), and was the son of a man of senatorial rank. His early years were spent at the Neapolitan court, and subsequently he went to Padua and Rome for his education. In the latter city the influence of his friends procured for him, from Paul II., the bishopric of Savona, and in 1473 he was made cardinal by Sixtus IV., whom he succeeded on August 29, 1484. Shortly after his coronation he addressed a fruitless summons to Christendom to unite in a crusade against the infidels; the amount of his own zeal may in some degree be estimated from the fact that in 1489, in consideration of a yearly sum of 40,000 ducats and a gift of the spear-head which had pierced the Saviour's side, he consented to favour the sultan Bajazet II. by detaining his fugitive brother in close confinement in the Vatican. In 1486 Henry VII. of England was declared to be the lawful holder of the English crown by the threefold right of conquest, inheritance, and popular choice. Innocent, in his bull "Summis desiderantes" (5th December 1484), instigated very severe measures against magicians and witches in Germany; the principles enunciated by him were afterwards embodied in the *Malleus maleficarum* (1487). He it was also who in 1487 appointed Torquemada to be grand inquisitor of Spain; he also urged a crusade against the Waldensians, offering plenary indulgence to all who should engage in it. In 1486 he prohibited, on pain of severe ecclesiastical censures, the reading of the nine hundred propositions of Pico Mirandola. An important event of his pontificate was the fall of Granada (January 1492), which was celebrated in the Vatican with great rejoicings. He died July 25, 1492, leaving behind him numerous children ("Octo nocens pueros genuit, totidemque puellas; Hunc merito poterit dicere Roma patrem"), towards whom his nepotism had been as lavish as it was shameless. His successor was Alexander VI.

INNOCENT IX. succeeded Gregory XIV. on October 29, 1591, and died on December 30 of the same year. His pontificate was unimportant. Clement VIII. was his successor.

INNOCENT X., Giovanni Battista Pamphili, pope from 1644 to 1655, was born at Rome in 1574, attained the dignity of cardinal in 1629, and through French influence was chosen to succeed Urban VIII. on September 15, 1644.

Throughout his reign the influence exercised over him by Olympia Maidalchini, his deceased brother's wife, was very great, and such as to give rise to gross scandal, for which, however, there appears to have been no adequate ground. He naturally enough objected to the conclusion of the peace of Westphalia, against which his uncles in his name vainly protested, and against which he issued the bull "Zelo domus Dei" in November 1648. The most important of his doctrinal decisions was his condemnation of the five Jansenist propositions in 1653. The avarice of his female counsellor gave to his reign a tone of oppression and sordid greed which probably it would not otherwise have shown, for personally he was not without noble and reforming impulses. He died January 5, 1655, and was succeeded by Alexander VII.

INNOCENT XI., Benedetto Odescalchi, pope from 1676 to 1689, was born at Como in 1611, studied law at Rome and Naples, held successively the offices of protonotary, president of the apostolic chamber, commissary of the Marca di Roma, and governor of Macerata; in 1647 Innocent X. made him cardinal, and he afterwards successively became legate to Ferrara and bishop of Novara. In all these capacities the simplicity and purity of character which he displayed had combined with his unselfish and openhanded benevolence to secure for him a high place in the popular affection and esteem; and two months after the death of Clement X. he was (September 21, 1676), in spite of French opposition, chosen his successor. He lost no time in declaring and practically manifesting his zeal as a reformer of manners and a corrector of administrative abuses. He sought to abolish sinecures and to put the papal finances otherwise on a sound footing; beginning with the clergy, he sought to raise the laity also to a higher moral standard of living. Some of his regulations with the latter object, however, may raise a smile as showing more zeal than judgment. In 1679 he publicly condemned sixty-five propositions, taken chiefly from the writings of Escobar, Suarez, and the like, as "propositiones laxorum moralistarum," and forbade any one to teach them under penalty of excommunication. Personally not unfriendly to Molinos, he nevertheless so far yielded to the enormous pressure brought to bear upon him as to confirm in 1687 the judgment of the inquisitors by which sixty-eight Molinist propositions were condemned as blasphemous and heretical. His pontificate was marked by the prolonged struggle with Louis XIV. of France on the subject of the so-called "Gallican Liberties," and also about certain immunities claimed by ambassadors to the papal court. He died after a long period of feeble health on August 12, 1689. Hitherto repeated attempts at his canonization have invariably failed, the reason popularly assigned being the influence of France. The fine moral character of Innocent has been sketched with much artistic power as well as with historical fidelity by Mr Robert Browning in *The Ring and the Book*. Innocent XI. was succeeded by Alexander VIII.

INNOCENT XII., Antonio Pignatelli, pope from 1691 to 1700, was the successor of Alexander VIII. He came of a distinguished Neapolitan family, and was born March 13, 1615. Educated at the Jesuit college in Rome, he in his twentieth year became an official of the court of Urban VIII.; under successive popes he served as nuncio at Florence and Vienna and in Poland; and by Innocent XI. he was made cardinal (1681) and archbishop of Naples. Immediately after his election (July 12, 1691) he declared against the nepotism which had too much and too long been one of the greatest scandals of the papacy; the bull "Romanum decet Pontificem," issued in 1692, prohibited popes in all times coming from bestowing estates, offices, or revenues on any relative; at the same time he sought

to check the simoniacal practices of the apostolic chamber, and in connexion with this to introduce a simpler and more economical manner of life into his court. He introduced various much-needed reforms into the States of the Church, and for the better administration of justice erected the Forum Innocentianum. In 1693 he compelled the French bishops to retract the four propositions relating to the "Gallican Liberties" which had been formulated by the assembly of 1682. In 1699 he decided in favour of Bossuet in his controversy with Fénelon about the *Explication des Maximes des Saints sur la Vie Intérieure* of the latter. His pontificate contrasted with that of a series of predecessors in having marked leanings towards France instead of Germany. This benevolent, self-abnegating, and pious pope died on September 27, 1700, and was succeeded by Clement XI.

INNOCENT XIII., Michael Angelo Conti, pope from 1721 to 1724, was born in 1655, and became cardinal under Clement XI. in 1706. From 1697 to 1710 he acted as papal nuncio to the kingdom of Portugal, where he is believed to have formed those unfavourable impressions of the Jesuits which afterwards influenced his conduct towards them. In 1721 his high reputation for ability, learning, purity, and a kindly disposition secured his election to succeed Clement XI. His pontificate was prosperous, but comparatively uneventful. He prohibited the Jesuits from prosecuting their mission in China, and ordered that no new members should be received into the order. This indication of his sympathies encouraged some French bishops to approach him with a petition for the recall of the bull "Unigenitus" by which Jansenism had been condemned; the request, however, was peremptorily denied. Innocent XIII., like his predecessor, showed much favour to the English Pretender "James III.," and liberally supported him. He died March 7, 1724, and was succeeded by Benedict XIII.

INNSBRUCK, or INNSPRUCK (18,000), the chief town of Tyrol, Austria, is situated on the right bank of the Inn, not far from its junction with the Sill, in a beautiful valley surrounded by lofty mountains, which seem to overhang the town. It is connected with its suburbs on the left bank of the stream by three bridges. The old wooden bridge, which was the scene of a fierce struggle between the Tyrolese and the Bavarians in 1809, was replaced in 1871-72 by a handsome iron structure, and the banks of the Inn have, during the last few years, been widened and planted with trees. Innsbruck is the seat of the law courts and the usual administrative offices for the district of Tyrol and Vorarlberg. The town has broad streets, with four open places. The houses are handsome; many of those in the old town date from the 17th and 18th centuries, and are built in the Italian style, adorned with frescoes, and having arcades beneath used as shops. The Franciscan or court church (1553-1563), in the Renaissance style, contains several works of art, of which the chief is the imposing cenotaph of the emperor Maximilian I. This monument of art, one of the most important on the Continent, represents the emperor kneeling in prayer on a marble sarcophagus, surrounded by twenty-eight colossal bronze statues of his ancestors; while on the sides of the sarcophagus there are twenty-four reliefs, depicting the chief events in Maximilian's life. Alexander Colin executed most of the reliefs (see vol. vi. p. 141); and Gilg Sesselschreiber, court-painter, had the general superintendence of the work, and designed many of the statues. In the same church are the monuments of the patriots Hofer, Haspinger, and Speckbacher, and one in memory of the Tyrolese who fell in defence of their country between 1796 and 1809. The silver chapel of the church contains a silver Madonna and altarpiece, and the graves of Archduke

Ferdinand II. and his wife Philippa. In this church Christina of Sweden, daughter of Gustavus Adolphus, publicly adopted the Roman Catholic faith in 1654. Other churches worthy of note are the Pfarr-church, the Jesuits' church, the Serviten church, and St John's of Nepomuk. There are numerous monastic institutions, including a Jesuits' college, and a Capuchin convent, begun in 1593 as the first of the order in Germany. The university, founded in 1672 and, after being twice suspended, finally reinstated in 1826, had in 1880-81 a teaching-staff of 76, and (1879-80) 607 students. It possesses a fine library, and exhibitions to the annual value of £1200. The Ferdinand-eum, an interesting national museum, was founded in 1845, and is maintained by private enterprise. The other chief buildings are the palace, completed in 1771, the theatre, the post-office, the landhaus, town-house, and other official buildings, and several schools and benevolent institutions.

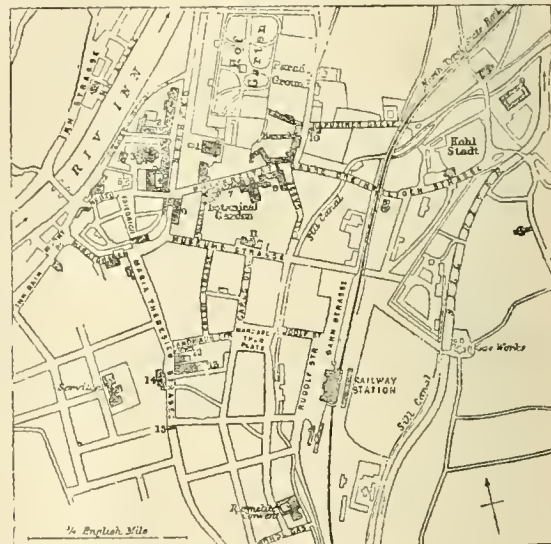

Plan of Innsbruck.

- |                              |                                |                      |
|------------------------------|--------------------------------|----------------------|
| 1. National Theatre.         | 6. Franciscan or Court Church. | 11. Museum.          |
| 2. Town-house, Custom-house. | 7. University.                 | 12. Landhaus.        |
| 3. Pfarr Church.             | 8. Jesuits' Church.            | 13. Post-Office.     |
| 4. Burg or Palace.           | 9. Jesuits' College.           | 14. Serviten Church. |
| 5. Goldne Dachl.             | 10. Capuchin Monastery.        | 15. Triumphal Arch.  |

The Golden Roof (Goldne Dachl) is prominent on the front of a mansion built in 1425 at great expense by Frederick of the Empty Pockets, as a practical refutation of his nickname. Among the several monuments in the town are St Anna's pillar, erected in 1706 to commemorate the repulse of the French and Bavarians in 1703; the fountain, with a bronze statue of Duke Rudolf IV., raised in 1863-77 in memory of the five hundredth anniversary of the union of Tyrol with Austria; statues of the archduke Leopold V. and of Walter von der Vogelweide; and the triumphal arch erected in 1765, on the occasion of the marriage of the emperor Leopold II. to the infanta Maria Ludovica. The manufactures of Innsbruck comprise woollen and cotton goods, stained glass, leather, and machinery; and there is considerable transit trade between Italy and Austria. The population in 1869 was 16,324; but in 1879 it was estimated at about 18,000, with a garrison of 2000 men.

The ancient name of the town was Eni Pons or Cnipontum, of which Innsbruck (Bridge of Inn) is the German equivalent. It received town privileges in 1234 from Duke Otto I. of Meran; from that date till about 1665 it was the capital of the Tyrolese counts; and after the union of Tyrol with Austria in 1363 it became a favourite residence of the emperors. In 1552 Maurice



of Saxony surprised and took Innsbruck, almost capturing the emperor Charles V., to whom a mutiny among Maurice's troops afforded time for a hasty flight. In the war of the Spanish succession, and again in the patriotic Tyrolese wars at the beginning of the 19th century, Innsbruck suffered severely. During the commotions of 1848, it was the temporary refuge of the emperor Ferdinand.

**INNS OF COURT.** The Inns of Court and Chancery are voluntary non-corporate legal societies seated in London, having their origin about the end of the 13th and the commencement of the 14th century.

Dugdale (*Origines Juridicales*) states that the learned in our laws were anciently persons in holy orders, the justices of the king's court being bishops, abbots, and the like. But in 1207 the clergy were prohibited by canon from acting in the temporal courts. The result proving prejudicial to the interests of the community, a commission of inquiry was issued by Edward I. (1290), and this was followed up (1292) by a second commission, which among other things directed that students "apt and eager" should be brought from the provinces and placed in proximity to the courts of law now fixed by Magna Charta at Westminster. These students were accordingly located in what became known as the Inns of Court and Chancery, the latter designated by Fortescue (*De Laudibus*) as "the earliest settled places for students of the law," the germ of what Sir Edward Coke subsequently spoke of as our English juridical university. In these Inns of Court and Chancery, thus constituted, and corresponding to the ordinary college, the students, according to Fortescue, not only studied the laws and divinity, but further learned to dance, sing, and play instrumental music, "so that these hostels, being nurseries or seminaries of the court, were therefore called Inns of Court."

Stow in his *Survey* (1598) says: "There is in and about this city a whole university, as it were, of students, practisers or pleaders, and judges of the laws of this realm;" and he goes on to enumerate the several societies, fourteen in number, then existing, corresponding nearly with those recognized in the present day, of which the Inns of Court, properly so-called, are and always have been four, namely, *Lincoln's Inn*, with the subordinate Inns of Chancery, *Furnival's Inn* and *Thavie's Inn*; the *Inner Temple*, with *Clifford's Inn* and *Clement's Inn*; the *Middle Temple*, with *New Inn*; and *Gray's Inn*, with *Staple's Inn* and *Barnard's Inn*. In addition to these may be specified *Serjeant's Inn*, a society composed solely of serjeants-at-law, which, however, ceased to exist in 1877. Besides the Inns of Chancery above enumerated, there were others, such as *Lyon's Inn*, which was pulled down as recently as 1868, and *Serape's Inn* and *Chester or Strand Inn*, spoken of by Stow, which have long been removed, and the societies to which they belonged have disappeared. The four Inns of Court stand on a footing of complete equality, no priority being conceded to or claimed by one inn over another. Their jurisdictions and privileges are equal, and upon affairs of common interest the benchers of the four inns meet in conference. From the earliest times there has been an interchange of fellowship between the four houses; nevertheless the *Middle Temple* and *Lincoln's Inn*, and the *Inner Temple* and *Gray's Inn*, have maintained a closer alliance.

The members of an Inn of Court consist of benchers, barristers, and students. The benchers are the governing bodies of the inns, and are composed of the senior members, designated also more formally "masters of the bench." They are self-elected, and unrestricted as to numbers; usually, but not invariably, a member of an inn, on attaining the rank of queen's counsel, is invited to the bench. Other members of long standing are also occasionally chosen, but no member by becoming a queen's

counsel or by seniority of standing acquires the right of being nominated a bencher. The benchers thus elected vary in number from twenty in *Gray's Inn* to seventy and upwards in *Lincoln's Inn* and the *Inner Temple*. The powers of the benchers are practically without limit within their respective societies; their duties, however, are restricted to the superintendence and management of the concerns of the inn, the admission of candidates as students, the calling of them to the bar, and the exercise of discipline generally over the members. The judges of the superior courts are the visitors of the inns, and to them alone can an appeal be had when either of the societies refuses to call a member to the bar, or to reinstate in his privileges a barrister who has been disbarred for professional or other misconduct. The meetings of the benchers are variously denominated a "parliament" in the *Inner* and *Middle Temples*, a "pension" in *Gray's Inn*, and a "council" in *Lincoln's Inn*. The presiding or chief officer is the treasurer, one of the benchers, who is elected annually to that dignity. Other benchers fulfil the duties of master of the library, master of the walks or gardens, dean of the chapel, and so forth, while others are readers, whose functions are referred to below. Under the term barrister are included generally all those members of an Inn of Court who, after due probation, and being at least twenty-one years of age, have been called to that rank by the benchers of the inn of which they have been students. For a notice of these the reader is referred to the article **BARRISTERS** (vol. iii. p. 394), but some further details respecting their connexion with these societies may be fitly given here. Each inn confers this status or degree on its own members only. The grade of barrister comprehends the attorney-general and solicitor-general (appointed by and holding office solely at the will of the Government of the day), who rank as the heads of the profession, queen's counsel, and ordinary practitioners, sometimes technically known as "utter barristers." There is also the practitioner "below the bar," the lowest in the ranks of the forensic hierarchy, who limits his practice to those special branches of the law designated pleading and conveyancing, and is precluded by the fact of his not having been "called" from appearing in court.

The usages of the different inns varied somewhat formerly in regard both to the term of probationary studentship enforced and to the procedure involved in a call to the bar. In the present day complete uniformity is observed in all respects, the entrance examination, the course of study, and the examinations required to be passed on the completion of the curriculum being identical and common to all the inns alike. When once called to the bar, the barrister is left to follow his own will in regard to entering into active practice or with respect to the special branch of the law he may elect to pursue, no hindrance beyond professional etiquette limiting his freedom of action in any way; so also members may on application to the benchers, and on payment of arrears of dues (if any), leave the society to which they belong, and thus cease altogether to be members of the bar likewise. Barristers rank as esquires, and are privileged from arrest whilst in attendance on the superior courts and on circuit, and also from serving on juries. They enjoy unfettered freedom of speech, though this confers no right to utter slander. On the other hand, a barrister has no legal remedy for the recovery of his fees, and it is not competent for him to enter into any contract for payment by his client with respect to litigation. A member of an Inn of Court retains his name on the lists of his inn for life by means of a small annual payment varying from £1 to £5, which at one or two of the inns is now compounded for by a fixed sum taken at the call to the bar. A distinctive dress is



worn by barristers when attending the courts, consisting of a stuff-gown, exchanged for one of silk when the wearer has attained the rank of queen's counsel, both classes also having wigs dating in pattern and material from the 18th century. Those who practise below the bar as pleaders or conveyancers are under the necessity of taking out a certificate, which is granted for one year only, but is renewable, and is subject to a small payment. This certificate is issued by the benchers of the Inn of Court of which the practitioner is a member, and is given to those only who are qualified to be called to the bar.

During the reign of Edward III. the Inns of Court and Chancery, based on the collegiate principle, prospered under the supervision and protection of the crown. In 1381 Wat Tyler invaded the Temple, and in the succeeding century (1450) Jack Cade meditated pulling down the Inns of Court and killing the lawyers. It would appear, moreover, that the inmates of the inns were themselves at times disorderly and in conflict with the citizens. Fortescue (*circa* 1464) describing these societies thus speaks of them: "There belong to the law ten lesser inns, which are called the Inns of Chancery, in each of which there are one hundred students at least, and in some a far greater number, though not constantly residing. After the students have made some progress here they are admitted to the Inns of Court. Of these there are four, in the least frequented of which there are about two hundred students. The discipline is excellent, and the mode of study well adapted for proficiency." This curriculum had probably existed for two centuries before Fortescue wrote, and continued to be enforced certainly down to the time of Sir Thomas More (1498) and of Chief Justice Dyer (1537), and yet later to that of Sir Edward Coke (1571). From this time, however, the attorneys were gradually closing the doors of the Inns of Chancery against students for the bar; and these preparatory schools of law, once the stepping stones to the Inns of Court (who directed their studies), have long since severed their relations with the bar and with legal education, and are now of no account whatever in connexion with the law, their members being chiefly, though not entirely, solicitors meeting solely for convivial purposes. By the time of Sir Matthew Hale (1629) the custom for law students to be first entered to an Inn of Chancery before being admitted to an Inn of Court had become obsolete, and thenceforth the Inns of Chancery have been entirely abandoned to the attorneys. Stow in his *Survey* succinctly points out the course of reading enforced at the end of the 16th century. He says that the Inns of Court were replenished partly by students coming from the Inns of Chancery, who went thither from the universities and sometimes immediately from grammar schools; and, having spent some time in studying the first elements of the law, and having performed the exercises called "bolts," "moots," and "putting of cases," they proceeded to be admitted to, and become students in, one of the Inns of Court. Here continuing for the space of seven years or thereabouts, they frequented readings and other learned exercises, whereby, growing ripe in the knowledge of the laws, they were, by the general consent either of the benchers or of the readers (who down to 1664 enjoyed a special privilege in this respect), called to the degree of barrister, and so enabled to practise in chambers and at the bar. There is thus abundant evidence that ample provision for legal study was formerly made, and that this continued with more or less vigour down to nearly the commencement of the 18th century. A languor similar to that which affected the church and the universities then gradually supervened, until the fulfilment of the merest forms sufficed to confer the dignity of advocate and pleader. This was maintained until recent years, when (from 1845)

the necessity for suitable training of young men aspiring to forensic honours has again become recognized, and steps have been taken for reviving and extending the ancient discipline and course of study, bringing them into harmony with modern ideas and requirements.

In the present day the four Inns of Court have combined in framing and enforcing regulations having for their end a preliminary or matriculation examination prior to admission to an inn, the keeping of terms, the attendance at lectures and private classes, and finally an examination preparatory to the call to the bar, which, as at the universities, is divided into an honour and a simple pass examination, the former carrying with it certain studentships of some pecuniary value and certificates of honour. The scope of the examinations is tolerably wide, and includes jurisprudence (with international law, public and private), the Roman civil law, constitutional law and legal history, common law, equity, the law of real and personal property, and criminal law. These studies, and the examinations consequent upon them, are superintended and controlled by a council of legal education consisting of twenty benchers nominated in equal numbers by each inn, and by a permanent committee of education and examination consisting of eight members, appointed by and taken from the council itself. A body of examiners has been likewise constituted, whose payment, together with the attendant expenses of the council, is provided for by annual contributions, in certain fixed proportions, made by the four inns. The arrangements in force would appear, however, to be regarded as tentative only, several attempts having been made to carry out a more systematic scheme of education, to be developed eventually into a regular legal university. The assistance of the legislature to this end has even been sought, but as yet without result, in the shape of a statutory enactment. The fees payable at the different inns vary from £136, 11s. 10d. at Gray's Inn to £154, 1s. 3d. at the Middle Temple. These sums cover all expenses from admission to an inn to the call to the bar, but the addition of tutorial and other expenses may augment the cost of a barrister's legal education to £400 or £500. The period of study prior to call has now become limited to twelve terms, equivalent to about three years. In the case of solicitors, however, the regulations have been altered in 1881 so as to enable them to be called after the lapse of one year.

It has been seen that the studies pursued in ancient times were conducted by means of "readings," "moots," and "bolts." The *readings* were from the very first deemed of vital importance, and were delivered in the halls with much ceremony; they were frequently regarded as authorities and cited as such at Westminster in argument. Some statute or section of a statute was selected for analysis and explanation, and its relation to the common law pointed out. Many of these readings, dating back to Edward I., are extant, and well illustrate the importance of the subjects and the exhaustive and learned manner in which they were treated by the able, experienced men upon whom this duty was cast. The function of "reader" involved the holder in very weighty expenses, chiefly by reason of the profuse hospitality dispensed,—a constant and splendid table being kept during the three weeks and three days over which the readings extended, to which were invited the nobility, judges, bishops, the officers of state, and sometimes the king himself. In 1688 the readers were paid £200 for their reading, but by that time the office had become a sinecure. In the present day the readership is purely honorary and without duties. The privilege formerly assumed by the reader of calling to the bar was taken away in 1664 by an order of the lord chancellor and the judges. *Moots* were exercises of the nature of formal argu-

ments on points of law raised by the students and conducted with much care under the supervision of a bencher and two barristers sitting as judges in the halls of the inns. *Bolts* were of an analogous character, though deemed inferior to moots. Both had fallen into complete desuetude until lately, when the society of Gray's Inn has revived mootings, it is understood with some success.

In the early history of the inns discrimination was exercised in regard to the social status of candidates for admission to them. Ferne, a writer of the 16th century, referred to by Dugdale, states that none were admitted into the houses of court except they were gentlemen of blood. So also Pliay, writing in the 1st century of the Christian era (*Letters*, ii. 14), says that before his day young men even of the highest families of Rome were not admitted to practice except upon the introduction of some man of consular rank. But he goes on to add that all barriers were then broken down, everything being open to everybody,—a remark quite applicable to the bar of England and elsewhere in the present day. It may here be noted that no dignity or title confers any rank at the bar. A privy councillor, a peer's son, a baronet, the speaker of the House of Commons, or a knight,—all rank at the bar merely according to their legal precedence. Formerly orders were frequently issued both by the benchers and by the crown on the subject of the dress, manners, morals, and religious observances of students and members. No such interference with the liberty of the subject is now recognized in the inns of court; and, although there is some semblance of a collegiate discipline maintained, this is restricted to the dining in hall, where many ancient usages survive, and to the closing of the gates of the inns at night.

Each inn maintains a chapel, with the accompaniment of preachers and other clergy, the services being those of the Church of England. The Inner and the Middle Temple have joint use of the Temple church, a fabric of high antiquity and much dignity. The chapels of Lincoln's Inn and Gray's Inn are also very interesting. The office of preacher is usually filled by an ecclesiastic of learning and repute chosen by the benchers. The principal functionary of this rank in connexion with the Temple church is, however, constituted by letters patent by the crown without episcopal institution or induction, enjoying, nevertheless, no authority independently of the benchers. He bears the title of Master of the Temple.

It has already been stated, on the authority of Fortescue, that the students of the Inns of Court learned to dance, sing, and play instrumental music; and those accomplishments found expression no doubt in the "masques" and "revels" for which the societies formerly distinguished themselves, especially the Inner Temple and Gray's Inn. These entertainments were of great antiquity and much magnificence, involving very considerable expense. Evelyn (*Diary*) speaks of the revels at the Middle Temple as an old and riotous custom, having relation neither to virtue nor to policy. The last revel appears to have been held at the Inner Temple in 1734, to mark the occasion of the elevation of Lord Chancellor Talbot to the woolsack. The plays and masques performed were sometimes repeated elsewhere than in the hall of the inn, especially before the sovereign at court. A master of the revels was appointed, commonly designated Lord of Misrule, whose authority in making the necessary arrangements was paramount. Abundant information as to the scope and nature of these entertainments has come down to us: one of the festivals is minutely described by Gerard Leigh in his *Accedence of Armorie*, 1612; and a tradition ascribes the first performance of Shakespeare's *Twelfth Night* to a revel held in the Middle Temple hall in February 1601. At the present day no

entertainments are given; excepting on very rare occasions, the hospitality of the inns has ceased to find expression save in the "Grand Day" held once in each of the four terms, when it is customary for the judges and other distinguished visitors to dine with the benchers (who sit apart from the barristers and students on a dais in some state), and "Readers' Feasts," on both which occasions extra commons and wine are served to the members attending.

The *Inner* and the *Middle Temple*, so far as their history can be traced back, have always been separate societies. Fortescue, writing between 1461 and 1470, makes no allusion to a previous junction of the two inns. Dugdale (1671) speaks of the Temple as one society, and states that the students so increased in number that at length they divided into two bodies, becoming the Inner and Middle Temple respectively. He does not, however, give any authority for this statement, or furnish the date of the division. The first reliable mention of the Temple as an inn of court is to be found in the *Paston Letters*, where, under date November 1440, the Inner Temple is spoken of as a college, as is also subsequently the Middle Temple. The Temple, as the name would serve to indicate, was the seat in England of the famous monastic order known as the Knights Templars, on whose suppression in 1312 it passed with other of their possessions to the crown, and after an interval of some years to the Knights Hospitalers of St John of Jerusalem, who in the reign of Edward III. denied the mansion and its surroundings to certain professors of the common law who came from Thavie's Inn. Notwithstanding the destruction of the muniments of the Temple by fire or by popular commotion, sufficient testimony is attainable to show that in the reigns of Edward III. and Richard II. the Temple had become the residence of the legal communities which have since maintained there a permanent footing. The two societies continued as tenants to the Knights Hospitalers of St John until the dissolution of the order in 1539; they then became the lessees of the crown, and so remained until 1609, when James I. made a grant by letters patent of the premises in perpetuity to the benchers of the respective societies on a yearly payment by each of £10, a payment which has long ceased to be made, having been bought up in the reign of Charles II. In this grant the two inns are described as "the Inner and the Middle Temple or New Temple," and as "being two out of those four colleges the most famous of all Europe" for the study of the law. Excepting the church, nothing now remains of the edifices belonging to the Knights Templars, the present buildings having been almost wholly erected since the reign of Queen Elizabeth or since the Great Fire, in which the major part of the Inner Temple perished. The church, a noble structure, has been in the joint occupation of the Inner and Middle Temple from time immemorial,—the former taking the southern and the latter the northern half. The round portion of the church was consecrated in 1185, the nave or choir in 1240. It is the largest and most complete of the four remaining round churches in England, and is built on the plan of the church of the Holy Sepulchre at Jerusalem. Narrowly escaping the ravages of the fire of 1666, this beautiful building remains to this day one of the most perfect specimens of early Gothic architecture in England, and is maintained in the highest order in respect not merely to the edifice itself but to the services conducted within its walls. In former times the lawyers awaited their clients for consultation in the Round Church, as similarly the serjeants-at-law were accustomed to resort to St Paul's Cathedral, where each serjeant had a pillar assigned him.

The *Inner Temple*, comprehending a hall, parliament chamber, library, and other buildings, occupies the site of the ancient mansion of the Knights Templars, built about the year 1240, and has from time to time been more or less re-erected and extended, the most recent changes in this direction dating from 1870, when the present handsome range of buildings, including a new dining hall, was completed. The library owes its existence to William Petyt, keeper of the Tower Records in the time of Queen Anne, who was also a benefactor to the library of the Middle Temple. The greatest addition by gift was made by the Baron Maseres in 1825. The number of volumes now in the library is 30,000, arranged in suitable rooms adjoining the hall. Of the Inns of Chancery belonging to the Inner Temple *Clifford's Inn* was anciently the town residence of the Barons Clifford, and was denised in 1345 to a body of students of the law. *Clement's Inn* was an Inn of Chancery before the reign of Edward IV., taking its name from the parish church of St Clement Danes, to which it had formerly belonged.

The *Middle Temple* possesses in its hall one of the most stately and interesting of existing Elizabethan structures. Commenced in 1562, under the auspices of the learned Plowden, then treasurer, it was not completed until 1572, the richly carved screen at the east end in the style of the Renaissance being put up three years later, in 1575. The idea long commonly received that the screen was constructed of timber taken from ships of the Spanish Armada (1588) is therefore baseless. The noble edifice, which through many vicissitudes of fire and popular tumult has been preserved unaltered to



the present day, has been the scene of numerous historic incidents, notably the entertainments given within its walls to regal and other personages from Queen Elizabeth downwards. The library, which now contains 28,000 volumes, dates its origin from 1641, when Robert Ashley, a member of the society, bequeathed his collection of books in all classes of literature to the inn, together with a large sum of money; other benefactors were Ashmole (the antiquary), William Petyt (a benefactor of the Inner Temple), and Lord Stowell. From 1711 to 1826 the library was greatly neglected; few works were added either by presentation or purchase, and many of the most scarce and valuable were lost. The present handsome library building, which stands apart from the hall, was completed in 1861, the Prince of Wales attending the inauguration ceremony on October 31st of that year, and becoming a member and bencher of the society on the occasion. The MSS. in the collection are few in number, and of no special value. In civil, canon, and international law, as also in divinity and ecclesiastical history, the library is very rich; it contains also some curious works on witchcraft and demonology. There is but one Inn of Chancery connected with the Middle Temple, that of *New Inn*, which, according to Dugdale, was formed by a society of students previously settled at St George's Inn, situated near St Sepulchre's Church without Newgate; but the date of this transfer is not known.

*Lincoln's Inn* stands on the site partly of an episcopal palace erected in the time of Henry III. by Ralph Nevill, bishop of Chichester and chancellor of England, and partly of a religious house, called Black Friars House, in Holborn. In the reign of Edward II., Henry Lacy, earl of Lincoln, possessed the place, which from him acquired the name of Lincoln's Inn, probably becoming an Inn of Court soon after his death (in 1310), though of its existence as a place of legal study there is little authentic record until the time of Henry VI. (1424), to which date the existing monuments reach back. The fee simple of the inn would appear, however, to have remained vested in the see of Chichester; and it was not until 1580 that the society which for centuries had occupied the inn as tenants acquired the absolute ownership of it. The old hall, built about 1506, still remains (and is temporarily used as one of the courts of the High Court of Justice), but has given place to a modern structure designed by Philip Hardwick, R.A., which, along with the buildings containing the library, was completed in 1845, the Queen attending the inauguration ceremony (October 13). The chapel, built after the designs of Inigo Jones, was consecrated in 1623. The library—as a collection of law books the most complete in the country—owes its foundation to a bequest of John Nethersale, a member of the society, in 1497, and is the oldest of the existing libraries in the metropolis. Various entries in the records of the inn relate to the library, and notably in 1608, when an effort was made to extend the collection, and the first appointment of a master of the library (an office now held in annual rotation by each bencher) was made. The library has been much enriched by donations and by the acquisition by purchase of collections of books on special subjects. It includes also an extensive and valuable series of MSS., the whole comprehending 43,000 volumes. The Inns of Chancery affiliated to Lincoln's Inn are *Thavie's Inn* and *Furnival's Inn*. *Thavie's Inn* was a residence of students of the law in the time of Edward III., and is mentioned by Fortescue as having been one of the lesser houses of Lincoln's Inn for some centuries. It thus continued down to 1769, when the inn was sold by the benchers, and thenceforth it ceased to have any character as a place of legal education. *Furnival's Inn* became the resort of students about the year 1406, and was purchased by the society of Lincoln's Inn in 1547. In 1817 the inn was rebuilt, but from that date it has ceased to exist as a legal community.

There is no reason to suppose that *Gray's Inn* is of less antiquity than the other Inns of Court. The exact date of its becoming the residence of lawyers is not known, though it was so occupied before the year 1370, and there is abundant evidence of its existence as an Inn of Court after that date. The inn stands upon the site of the manor of Portpoole, belonging in ancient times to the dean and chapter of St Paul's, but subsequently the property of the noble family of Grey de Wilton and eventually of the crown, from which a grant of the manor or inn was obtained, many years since discharged from any rent or payment. The hall of the inn is of handsome design, similar to the Middle Temple hall in its general character and arrangements, and was completed about the year 1560. The chapel, of much earlier date than the hall, has, notwithstanding its antiquity, but little now to recommend it to notice, being small and insignificant, and lacking architectural features of any kind. The library, including about 18,000 volumes, contains a small but important collection of MSS. and missals, and also some valuable works on divinity. Little is known of the origin or early history of the library, though mention is incidentally made of it in the society's records in the 16th and 17th centuries. The gardens, laid out about 1597, it is believed under the auspices of the lord chancellor Bacon, at that time treasurer of the society, continue to this day as then planned, though with some curtailment owing to the erection of additional buildings in recent years.

Among many curious customs maintained in this inn is that of drinking a toast on grand days "to the glorious, pious, and immortal memory of Queen Elizabeth." Of the special circumstances originating this display of loyalty there is no record. The Inns of Chancery connected with Gray's Inn are *Staple's* and *Barnard's Inns*. *Staple's Inn* was an Inn of Chancery in the reign of Henry V., and is probably of yet earlier date. Readings and moots were observed here with regularity. Sir Simonds d'Ewes mentions attending a moot in February 1624. *Barnard's Inn*, anciently designated *Mackworth Inn*, was an Inn of Chancery in the reign of Henry VI. It was then and still is held of the dean and chapter of Lincoln, to whom a fine of £1400 is payable every fourteen years.

The *King's Inns, Dublin*, the legal school in Ireland, corresponds closely to the English Inns of Court, and is in many respects in unison with them in its regulations with regard to the admission of students into the society, and to the degree of barrister-at-law, as also in the scope of the examinations enforced, though no final examination is now required for call to the bar. Of the twelve terms required to be kept, however, by a student, four must be spent at an Inn of Court in London, admission to which is obtained in the usual manner, but exempt from stamp duty, on the certificate of the under treasurer that such duty has been paid in Ireland. Until lately two years were required to be thus passed in London,—the stipulation dating as far back as 1542 (33 Henry VIII. c. 3). Down to 1866 the course of education pursued at the King's Inns differed from the English Inns of Court in that candidates for admission to the legal profession as attorneys and solicitors carried on their studies with those aspiring to the higher grade of the bar in the same building under a professor specially appointed for this purpose,—herein following the usage anciently prevailing in the Inns of Chancery in London, which, as has already been stated, has long since fallen into desuetude. This arrangement was put an end to by the statute 29 & 30 Vict. c. 84. The origin of the King's Inns may be traced back to the reign of Edward I., when a legal society designated *Collett's Inn* was established; but, being situated without the walls of the city, the inn was destroyed by an insurrectionary band. In the reign of Edward III. Sir Robert Preston, chief baron of the exchequer, gave up his residence within the city to the legal body, which then took the name of *Preston's Inn*, where for two centuries the study of the law was pursued and a collegiate discipline maintained. In 1542 the land and buildings known as *Preston's Inn* were restored to the family of the original donor, and in the same year Henry VIII. granted the monastery of Friars Preachers for the use of the professors of the law in Ireland. In consequence of this grant the legal body removed to the new site, and thenceforward were known by the name of the King's Inns. Possession of this property having been resumed by the Government in the middle of the last century (1742), and the present Four Courts erected thereon, a large space of ground at the top of Henrietta Street was purchased by the society, and the existing hall built in the year 1800. The library, numbering over 50,000 volumes, with a few MSS., is housed in buildings specially provided in the year 1831, and is open, not only to the members of the society, but also to strangers upon proper introduction. The collection is not entirely legal, but comprises all kinds of literature. It is based principally upon a purchase made in 1787 of the large and valuable library of Mr Justice Robinson, and is maintained chiefly by an annual payment made from the Consolidated Fund to the society in lieu of the right to receive copyright works which was conferred by the Act of 1801 (41 George III. c. 107), but abrogated in 1836 (6 & 7 Will. IV. c. 107). In discipline and professional etiquette the members of the bar in Ireland differ but little from their English brethren. The same style of costume is enforced, the same gradations of rank—



attorney-general, solicitor-general, queen's counsel, and ordinary barristers—being found. There are also serjeants-at-law limited, however, to three in number, and designated 1st, 2d, and 3d serjeant; and, unlike their English brethren, these are not as yet in course of extinction. The King's Inns do not provide chambers for business purposes; there is consequently no aggregation of counsel in certain localities, as is the case in London in the Inns of Court and their immediate vicinity.

The corporation known as the *Faculty of Advocates* in Edinburgh corresponds with the Inns of Court in London and the King's Inns in Dublin (see *ADVOCATE*, vol. i. p. 178). The constitution of the faculty differs in many respects, however, from the English and Irish societies. There is no resemblance to the quasi-collegiate discipline and the usages and customs prevailing in an Inn of Court. There is no governing body similar to the benchers. The president is elected by general vote of the whole body of the advocates, and is designated dean of faculty. Until a recent date no precedence excepting that of the lord advocate (who performs many of the duties of the attorney-general in England), the dean of faculty, and the solicitor-general was recognized. Now these officers and the ex-law-officers of the crown obtain patents as queen's counsel. The faculty is possessed of a hall and extensive library buildings situated beneath and adjoining the Parliament House, which have been much added to in the present century. The body regulates all matters connected with admission to its ranks.

Advocates are not required to pass any portion of their studentship in London, as is the case with members of the Irish inn. On the other hand, advocates of the Scottish bar desiring to change the scene of their professional labours to the English metropolis derive no advantage as such (excepting when pleading in appeals at the bar of the House of Lords and in cases before the judicial committee of the privy council), but have to pass through the ordinary curriculum of the English student before acquiring the necessary status; and in like manner an English or Irish barrister seeking admission to the Scottish bar must go through the course prescribed by the faculty.

*Authorities.*—Fortescue, *De Laudibus Legum Angliæ*, by A. Amos, 1925; Dugdale, *Origines Juridicales*, 2d ed., 1671; Foss, *Judges of England*, 1848-64, 9 vols.; Herbert, *Antiquities of the Inns of Court*, 1804; Pearce, *History of the Inns of Court*, 1848; Report of the Commissioners appointed to inquire into the Inns of Court and Chancery, 1855; Ball, *Student's Guide to the Bar*, 1878; Stow, *Survey of London and Westminster*, by Strype, 1754-5; Nichols, *Progresses of Elizabeth and James I.*; Lane, *Student's Guide through Lincoln's Inn*, 2d ed., 1805; Spilsbury, *Lincoln's Inn, with an Account of the Library*, 2d ed., 1873; Douthwaite, *Notes illustrative of the History and Antiquities of Gray's Inn*, 1876; *Paston Letters*, 1872; *Law Magazine*, 1859-60; *Quarterly Review*, October 1871; Cowel, *Law Dictionary*, 1727; Duhigg, *History of the King's Inns in Ireland*, 1806; Mackay, *Practice of the Court of Session*, 1879. (J. C. W.)

**INOCULATION.** See **SMALL-POX.**

**INOWRAZLAW** (9147), anciently Jung-Breslau, the chief town of a circle in the government district of Bromberg, is situated on an eminence in the most fertile part of the Prussian province of Posen, 25 miles south-east of the town of Bromberg. It is the seat of a local court, and has several churches, a synagogue, and a gymnasium. Iron-founding, the manufacture of machinery, and an active trade in cattle and country produce are carried on. In the vicinity are important salt works and a sulphur mine, and since 1876 there has been a brine bath establishment within the town. Inowrazlaw is mentioned as early as 1185, and appears several times in the mediæval history of the Teutonic knightly order. The population in 1877, including the garrison and the neighbouring Grotznów, was 9147.

**INQUEST.** See **COBONE.**

**INQUISITION, THE**, is the name usually given to that organization which was established in Spain in the 15th century for the detection and suppression of heresy. The "Holy Office," as it was styled, was, however, only the development of a system which, in the hands of the preaching orders, had existed from the beginning of the 13th century; and this in turn did but enforce anew the old view that the church is bound to correct all immorality or misbelief. The subject has therefore three distinct periods:—(1) the treatment of heresy and vice before the 13th century; (2) the Dominican Inquisition, dating from the council of Toulouse in 1229; (3) the Spanish Inquisition, which began in 1480. The second and third periods express a different principle from that which guided the first; for the earlier inquiry into heresy or vice was a part of the episcopal functions, while the second period sprang out of the anti-episcopal and anti-feudal revival of the preaching orders, and the third went with the establishment of a centralized monarchy in Spain, and its claims to a political-religious supremacy in Europe. The first was not directed against any special heresy; the second was called forth by the Albigensian movement, and the literary and artistic independence of southern France; the third expressed the views of Spanish orthodoxy in its struggle with Jew and Moor, and, when that contest was done, it attacked Protestantism, becoming, in union with the Jesuits, the fighting power of the Catholic reaction of the 16th century. The original episcopal Inquisition never forgave its more vigorous and better organized successor; the Spanish Office was nowhere introduced without a struggle, but the Reformation left episcopacy almost powerless in northern Europe, while in the south the renewed and autocratic papacy discouraged the independence of bishops, and trusted itself mainly to the order of Jesus and the Holy Office.

The Inquisition was an outcome of that desire for safety in the truth which distinguishes Christianity from most other forms of faith. If men feel safe, they charitably wish others to be also safe,—hence missionary heroisms; they fear whatever may endanger their safety, and long to clear it away,—hence persecution; they argue that if they make a convert they save a soul, and if not that the stiff unbeliever is too dangerous to be left,—whence come imprisonments and the stake. So long as church and state were distinct, the heretic simply forfeited his privileges as a member of a religious body; but when state and church became, in theory at least, conterminous, this process availed no longer, and the heretic had to be put away by the state, while the church became ever more industrious in seeking out error. Now, in religious matters, men have always tried to make things easier by multiplying difficulties; they secure safety by exact statement and minute definition. Creeds and formularies cease to be symbols of a general consent, and become, instead, tests of orthodoxy. And though, in theory, the church was as anxious for the moral purity as for the right faith of her members, the moral questions were presently eclipsed by the dogmatic; church discipline judged conduct lightly, while it controlled opinion with an iron hand.

1. The germ of the Inquisition lies in the duty of searching out and correcting error entrusted to the deacons in the early churches. The promise in the Anglican Ordinal that the priest will be "ready with all faithful diligence to banish and drive away all erroneous and strange doctrines contrary to God's word" is a pale reflexion of this ancient charge. The episcopacy thus providing the instruments, the temporal power soon offered to enforce the sentences of the church: the edicts of Constantine and his successors now began that double system which, by ordaining that heretics should be dealt with *διὰ τῆς ἐξουσίας*

ἐξουσίας, by the secular arm, enabled the church to achieve her object without dipping her own hands in blood. Thus, about 316, Constantine issued an edict condemning the Donatists to lose their goods; and in 382 Theodosius declared the Manichæans guilty of death, and confiscated their goods. Later on, in 769, we learn in the capitularies of Charles the Great that each bishop must visit all his "Parœchia," or diocese, teach truth, correct morals, see that the clergy hold the right faith, and, on the Saxon border, stop the use of any pagan rites. Charles the Bald in 844 orders the bishops to preach and confirm the people, and to inquire into and correct their errors, "ut populi errata *inquirant* et corrigant." In this inquisition, as in other matters, the church long felt the impress of the organizing power of Charles the Great; it helped forwards the episcopal dominance in the 9th and 10th centuries. Still, it claimed no special authority, and its action was very partial, and dependent on the temper and energy of each particular bishop. Sometimes it was raised into activity by some bolder movement of independence, as when in Italy in the 11th century the bishops attacked the Patarines, under the impulse of Hildebrand, or as when it was used as an implement for the reduction of the archbishopric of Milan under the papal authority.

2. But when a time of new life came to Europe early in the 13th century, and orthodoxy was threatened by the brilliant speculations of southern France, a great revival in the church met the independent movement outside, and the rise of the Preaching Friars gave a new direction to the relations between religion and the world. Then, as in later days, the "Renaissance shook off many restraints, the good with the bad"; and art went with religious speculation and moral licence. The action of the new orders, as a development of the inquisitorial system, was directed almost entirely against opinions, and moral questions were left on one side. To this period we owe the technical use of the terms Inquisitor and Inquisition. Hitherto they had signified, specially in France, officers inquiring into matters of taxation; henceforth they are applied to the more ominous inquiry into orthodoxy. At the council of Tours in 1163, in the time of Alexander III., the title of Inquisitor was first applied in this sense; and, at the council of Toulouse in 1229, the apostolical legate "mandavit *inquisitionem fieri contra hæreticos suspectos de hæretica pravitate.*" But the thing was far older than the name. In 1184 the synod of Verona cursed all heretics and their shelterers, ordered relapsed persons to be handed over to the secular arm for capital punishment, confiscated their property, and clearly indicated that the new Inquisition would go far beyond the older episcopal function. The synod did not hesitate to threaten easy-going bishops, urging them to more frequent and more searching visitations, standing over them as a superior power. And henceforward Inquisition becomes more systematized, with papal not episcopal authority; it was developed by those three masterful pontiffs, Innocent III. (1198-1216), Gregory IX. (1227-1241), and Innocent IV. (1243-1254), who all, regarding the supremacy of Rome as the keystone of society, claimed authority over men's souls and bodies, above the authority of prince or bishop. Thus, soon after his accession, Innocent III. sent two Cistercians, Guy and Regnier, to visit the dioceses of southern France and Spain, "to catch and kill the little foxes," the Waldensians, Cathari, and Patarines, to whose tails were fastened firebrands to burn up the good corn of the faithful. The bishops and lay authorities were instructed to give all help; a new power, with special papal authorization, had come in, and would interfere with every bishop in his diocese, rouse new activity in the old system, and also act independently as a new engine of inquiry.

Similarly, in 1203, Innocent III. sent Peter of Castelnau and Ralph, two Cistercians of Fontevault, to preach down the Albigensian heresy; and when persuasion availed little he added to them Arnould, abbot of Fontevault, and named the three his apostolical legates, ordering them to deal more sharply with the heretics. The murder of Peter (henceforward styled St Peter Martyr) in 1209 led to the outbreak of that cruel and disastrous war, the crusade of Simon of Montfort against the Albigensians. But little success attended the effort of these earlier Inquisitors till they were joined by the too famous Castilian Dominic, who, having in 1215 accompanied the bishop of Toulouse to Rome, laid before the pope a scheme for a new order of preaching friars, whose special function should be the overthrow of heresy; Innocent III. approved the order in 1215, and Honorius III. confirmed it in 1216. It spread swiftly through Europe, and the charge of the Inquisition was soon entrusted almost entirely to it. Hitherto there had been no regular tribunal; now, as the war in southern France went on and the strife became more fierce, a stricter organization was introduced. While the strong current of independent opinion was being stemmed in Italy, Provence, France, and Spain, the resistance gave compactness to the new system. St Dominic established three orders—(1) his friars, (2) a female order, and (3) the "Militia of Christ," an order of laymen, married chiefly and noble, who became the working force of the inquisitorial system; they were also styled "the Familiars of the Holy Office."

It is, however, to Gregory IX. that the Inquisition owes its definite form. In the synod of Toulouse in 1229 it was agreed that each bishop should appoint one priest, and one, two, three, or even more laymen, to inquire, under oath and with much secrecy, into heresy. In 1234 the Dominicans were specially entrusted with the inquisitorial office in Toulouse. From their tribunal there was no appeal to the bishop, who fell into the background, all appeals being directed to Rome alone. To this end Urban IV. appointed, in 1263, an inquisitor-general to be the medium of communication between the papacy and the local inquisitors, in hopes of stopping the delay of business caused by the absence of officials in Rome on appeal questions. This office, however, fell into abeyance till revived by Paul III. in the person of Caraffa in 1542.

From Provence the organization of the Inquisition soon passed into France, where, in 1255, Alexander IV. named the provincial of the Dominicans and the head of the Franciscans at Paris his inquisitors-general for France at the urgent request of Saint Louis, whose piety was of the narrowest crusading type. The Gallican Church stoutly resisted this ultramontane interference; the bishops gave it no help; churches and abbeys became asylums for the victims of the Holy Office; and the new movement had consequently but very partial success. It was more effectively used by Philip the Fair to crush the Templars, though that greedy prince quickly interfered when he found the Inquisition laying hands on his special preserve, the wealthy Jews. Charles V., moved to new efforts by Gregory XI., imprisoned large crowds of Frenchmen for heresy, and to meet the pressure erected several new prisons, among them the ill-omened Bastille. After this the Inquisition was quiet in France till the Reformation once more aroused it in the time of Francis I. In Spain it was introduced by Pope Gregory IX. in 1232, and had a far more active and continuous life; we have a minute account of its system and procedure in the *Directorium Inquisitorum* of N. Eymerich, inquisitor-general for Castile in 1356. This work, based entirely on the writer's personal knowledge and experience, gives us full insight into the way in which cases were got up and handled: we see the spy system, the delation, the mysterious secrecy, the scandal of the "question"; the



shameless union in one person of accuser and judge, the unscrupulous hindrances put in the way of the victim's defence, the direct interest of the tribunal in condemning,—for condemnation affirmed vigilance and orthodoxy, while it secured to the Holy Office the wealth of the accused, and the accused were usually among the wealthiest in the land. We can trace the absolute injustice of the institution on every page, and must only wonder that even in those days men could endure its existence. In Italy the Inquisition was established under Dominican supervision as early as 1224; Simone Memmi's famous fresco of the "Domini Canes" in S. Maria Novella at Florence, with its black and white hounds chasing off the wolves from the holy fold, bears living witness to the power of the institution and its influence over the Italian imagination. If Eyerich's book gives us a view of the rules of procedure, the MS. *Liber Sententiarum*, or Book of Judgments, printed in part by Limborch, and containing the acts of the Toulouse Office from 1308 to 1322, gives us a full account of those rules reduced to practice in the earliest tribunal of the reconstructed Office. Between the two we can create for ourselves a complete image of the institution, and judge of its power over the intellects, souls, and bodies of the quick-witted southerners. Inquisitors were at a later time brought into England to combat the Wickliffite opinions.

3. Though it succeeded, with help of the terrible lay-crusade, in southern France, the Inquisition seemed unequal to the problem laid before it in Spain, where, instead of simple-hearted Albigensians, it had to deal with rich and crafty Jews and highly-trained Moors. Forced to profess a Christianity which they hated, they loathed the worship of virgins or saints, the pictured or graven effigy of the Christ, the thousand objects of mediæval worship, all which to their eyes were mere idolatries; their allegiance to such a faith was that of compulsion, which fostered the bitterest sense of wrong. Between them and the old Catholic Spaniards smouldered a perpetual grudge; the Inquisition seemed unable to overcome the evil. When, however, Castile and Aragon were united by Ferdinand and Isabella, political aims as well as religious fanaticism demanded more stringent measures against independent thought; the war of Louis XIV. against freedom of opinion was not more distinctly political than that of the two monarchs, although his machinery was more civil and military than theirs.

Three chief motives led to the reorganization of the Inquisition in Spain:—(1) the suspicious and ill-feeling against the new Christians; (2) the wish of Ferdinand and Isabella to strengthen the compactness of their union, threatened by the separatist tendencies of the wealthy Jews and Moors; and (3) above all, the hope of a rich booty from confiscations, a characteristic which specially marks the history of the Spanish Inquisition. The motive of strictly religious fanaticism influenced, not the monarchs, but the Dominican instruments of the Holy Office. And so when in 1477 Friar Philip de Barberi, inquisitor for Sicily, came to Seville for the confirmation of his office, and pressed on Ferdinand the great advantages of a revived system on the Sicilian plan, the king, led by his hunger for gold, and the queen, guided by her piety, were easily persuaded, and sent to Rome to solicit the establishment of such a tribunal as Barberi suggested. Sixtus IV. in 1478 acceded to their request; his bull for this purpose is, however, lost. But as Isabella wished first to try gentler measures, and as both monarchs were rather alarmed by the independence the proposed tribunal claimed, the papal permission was not made known or acted on till 1480. The monarchs bargained that they should nominate the Inquisitors, hoping thereby to secure a control over the institution; but the real centre of authority was inevitably Rome, and from its

outset the Holy Office was ultramontane. Nor indeed is there good ground for Hefe's contention, in which he is followed by the Benedictine Gams of Ratisbon, that the Inquisition was entirely a state institution; the state did take part in it, and tried to draw its own selfish advantages from it, and it was also in name a royal tribunal; but its spirit was completely Dominican, and the impulse of it papal; nor can the church be relieved from the just odium which presses on the memory of the institution.

The first inquisitors named in 1480 were Dominicans; their tribunal was established at Seville, where they were but sullenly received. Early in 1481 they began work, and before that year was out had burnt 298 victims in Seville alone, besides many effigies of those who had happily escaped. The Jesuit historian Mariana assures us that in this year full 2000 were burnt in the archbishopric of Seville and the bishopric of Cadiz; the Quemadero, or cremation-place, built at this time by the prefect of Seville, not far from that city, a square platform of stone, was a grim altar on which the lives of almost daily victims ascended in clouds of smoke to heaven. This new blessing, however, was but unwillingly welcomed by the Spaniards; the capital of Castile remembered its ancient learning and splendour, and the wealth and intelligence of its old Moorish inhabitants; complaints and protests poured in on Sixtus IV., especially from the bishops; and in 1483, in one of his briefs the pope actually ordered a softening of the rigours of the Holy Office; he also named the archbishop of Seville, D. Inigo Manriquez, his sole judge of appeals in matters of faith, hoping thereby to still the strong jealousy of the episcopate. He was also somewhat offended because Ferdinand and Isabella held back the papal share of the spoils.

Shortly afterwards, October 1483, the Dominican father Thomas of Torquemada (de Turrecremata) was named by Sixtus IV. inquisitor-general for Castile and Leon. From him the institution received its full organization. He became its president; by his side were two lawyers as assessors, and three royal counsellors. This scheme was not large enough for the work; it was shortly amended, and there was now a central court styled the Consejo de la Suprema, composed of the grand inquisitor-general, six apostolical counsellors, a fiscal procurator, three secretaries, an algazil (or head policeman), a treasurer, four servants of the tribunal, two reporters or informers, and as many consultors as might be needful. Under this central tribunal four local tribunals were also appointed. All the officials were well paid from the confiscation-fund; it was the interest of all that that stream of wealth should never run dry; Torquemada was to the full as eager as Ferdinand for profit from this unholy source: the chief spoils of the institution fell to the crown; the true accession of strength was at Rome.

This royal council of the Inquisition, as it was now styled, proceeded next to draw up its rules. Torquemada in 1484 summoned to Seville all heads of local tribunals, who presently published a code of thirty-nine articles. The dreary list regulates the procedure of the Holy Office. The articles were originally twenty-eight; of these 1 to 10 deal with the summons to heretics to come forward and confess, and with the penalties to the submissive; 11 to 13 with penitents in the prisons of the Office; 14 to 19 treat of the procedure of trial, including torture; 20 and 21 extend the jurisdiction of the tribunal to dead heretics and the vassals of living nobles; the remainder are on points of detail in the management. Afterwards eleven more rules were added, on points of less interest: they deal with the organization of the smaller tribunals, guard against bribery of officials, establish an agent at Rome, and make fresh and minute directions as to confiscations and the payment of inquisitors' salaries; the money ques-



tion comes up perpetually. In no part of Spain was the system well received; the resistance in Aragon passed into revolt and assassination, which were only overcome by the united efforts of the Dominicans, the papacy, and the sovereign, aided to some extent by the "Old Christians" (i.e., those not of Jewish origin), whose jealousy towards the new Christians and the Moors led them to favour a system which repressed their rivals.

The Holy Office had now free scope for its work, and its procedure, arranged by Torquemada, will explain how thoroughly it succeeded in terrifying all who came within its reach. When an accused or suspected person was first delated to the Inquisition, a preliminary inquiry was held, and the results of it laid before the tribunal. If the tribunal thought it a case for interference, and it usually did so, the informers and witnesses were re-examined, and their evidence, with all suspicious circumstances which zeal could rake together, drawn out and submitted to a body of monastic theologians called "the Qualifiers of the Holy Office." The character of these officials was at stake, and their honour involved; they could hardly be expected to report well of the accused, or there might be a suspicion as to their own orthodoxy. When they had given in their opinion against the accused, he was at once removed to the secret prison of the Office, where all communication with the outer world was entirely cut off from him. Then followed three "first audiences," in which the officials did their utmost to wring a confession out of him, so that he might be made to rank as a penitent, and enjoy the charity of his persecutors. If, however, he was stiff, the charges against him were re-formed, and the fiscal in charge of the case demanded torture to extort confession. This in the earlier times of the institution followed frequently, and had many forms of ingenious cruelty, as to which Llorente, who had good means of judging, declares that "none of the descriptions of them can be accused of exaggeration." After torture, the shattered victim was carried to the audience chamber, and called on to make his answer to the charges, which were now read to him for the first time. He was next asked whether he desired to make any defence. If so, he had to choose a lawyer from a list of those employed by his accusers, and the defence was little but a mockery. After this process, which sometimes lasted for months, the qualifiers were again called in, and gave their final opinion, which was almost always adverse, on the whole case. Then followed the sentence, with opportunity of an appeal either to the "Suprema"—which was useless, as being an appeal to the tribunal again—or to Rome. The papal treasury by these appeals obtained a large income; for money was the only valid argument. Thus the Inquisition got the victim's property by confiscation, and the papacy the wealth of his friends in the appeal. If the sentence was, as did sometimes occur, an acquittal, the poor wretch might slink home without redress or recompense for imprisonment, and the agony of the trial and the torture; if it was a condemnation, the victim was made the centre of an *auto-da-fé*, dressed in a sanbenito, or condemned man's robe, and eventually, at the open place of execution, informed as to his fate. He might be either "reconciled," and then, as a penitent, had to undergo penalties almost worse than death, or "relaxed," that is, handed over to the secular arm for burning,—for the Holy Office shed no blood.

This then was the instrument by which the purity of Christendom was to be assisted and defended, "*misericordia et justitia*," as the motto of the institution runs, by the most flagrant injustice, and by the infliction of those cruel "tender mercies" of which the Book of Proverbs speaks.

In 1492 the great work began with the persecution and expulsion of the Jews; they were ejected, and their wealth

confiscated. There was an enormous crowd of exiles, who wandered to different shores of the Mediterranean, carrying misery and plague in their train. A few years later, under supervision of Cardinal Ximenes, the Moors were also ordered to be converted or to go; the Morescoes, or Christianized Moors, suffered constant persecution throughout the 16th century, until finally they too were expelled by Philip III. in 1609. Jews, Moors, and Morescoes made up over three millions of the wealthiest and most intelligent inhabitants of Spain; the loss in trade, agriculture, and manufactures was incalculable; in seventy years the population fell from ten to six millions.

Ximenes was the greatest organizer, after Torquemada, of the Office; he divided the whole Inquisition into ten tribunals,—Seville as the capital, Jaen, Toledo, Estremadura, Murcia, Valladolid, Majorca, Pampeluna, Sardinia, and Sicily; and, though the bishops still resisted his authority, he carried his will through with a high hand. The Inquisition was set up in all the colonies and dependencies of Spain; it established itself, as a theological quarantine, at all the harbours, and greatly checked the development of Spanish trade. The horror of the English at the institution was much due to the collision of the English traders and adventurers of Queen Elizabeth's day with the Inquisition on the Spanish main, and to its interference with that freedom of traffic which they desired. The new Inquisition was set up in the Netherlands by Charles V. in 1522; it was exceedingly severe, and greatly hated by the people (see HOLLAND) under Philip II. and Alva. In Portugal the Holy Office established itself in its sharpest form, and continued there in full force even when the Jesuits were suppressed. It was introduced into France under Henry II. (1557), though its hold on that country was small. In Italy it had free course during the 16th century and vigorously supported the Catholic reaction, especially when the very soul of the Inquisition, Michele Ghislieri, had ascended the pontifical throne as Pius V. Its organization was also strengthened by Sixtus V., who secured it at Rome.

The hand of the Holy Office was outstretched against all; no lofty dignity in church or state, no eminence in art or science, no purity of life, could defend from its attacks. It is said to have threatened Charles V. and Philip II.; it persecuted Archbishop Carranza, head of the church in Spain; destroyed De Dominis, archbishop of Spalatro; it smote Galileo, murdered Giordano Bruno, attacked Pico di Mirandola, and even is said to have threatened Cesar Borgia. With equal vigour, in combination with the Jesuits, the Inquisition made war on books and learning, religious or secular alike; we have seen how baleful was its effect in earlier days on literature and art in Provence, and in the time of the Catholic sovereigns on the material well-being of Spain. "In the love of Christ and his mother," says Queen Isabella, "I have caused great misery, and have depopulated towns and districts, provinces and kingdoms."

The statistics of death at the hands of the Inquisition in Spain given by Llorente show how the institution gradually lost force; the average number in each year steadily diminished after the beginning of the 17th century; and in the 18th torture was abandoned, and the deaths dropped to two or three or even less in the year. In Italy it was abolished in Parma and Tuscany about 1769, in Sicily in 1782; the spirit of the 18th century was all against the Office, though it lingered on. In the Revolution wars Napoleon sternly crushed it wherever he came across it, in Spain in 1808, and in Rome in 1809. Down to 1809 Llorente gives as the figures for Spain alone—burnt alive 31,912, in effigy 17,659, and imprisoned, &c., as penitents, 291,450—a total of 341,021. After the hand of Napoleon was taken off, the institution revived again at Rome and at

Madrid; but its teeth were gone; and it could do little but show a murderous will. The last capital punishments were those of a Jew who was burnt, and a Quaker schoolmaster hanged, in Spain in 1826. Still, its voice is sometimes heard; in 1856 Pius IX. issued an encyclical against somnambulism and clairvoyance, calling on all bishops to inquire into and suppress the scandal, and in 1865 he uttered an anathema against freemasons, the secular foes of the Inquisition.

The occupation of Rome in 1870 (see ITALY) drove the papacy and the Inquisition into the Vatican, and there at last John Bunyan's vision seems to have found fulfilment. Yet, though powerless, the institution is not hopeless; the Catholic writers on the subject, after long silence or uneasy apology, now acknowledge the facts, and seek to justify them. In the early times of the Holy Office its friends gave it high honour; Paramo, the inquisitor, declares that it began with Adam and Eve ere they left Paradise; Paul IV. announced that the Spanish Inquisition was founded by the inspiration of the Holy Spirit; Muzarelli calls it "an indispensable substitute to the church for the original gift of miracles exercised by the apostles." And now again, from 1875 to this day, a crowd of defenders has risen up:

Father Wieser and the Innsbruck Jesuits in their journal (1877) yearn for its re-establishment; Orti y Lara in Spain, the Benedictine Gams in Germany, and C. Pouillet in Belgium take the same tone; it is a remarkable phenomenon, due partly to despair at the progress of society, partly to the fanaticism of the late pope, Pius IX. It is hardly credible that any one can really hope and expect to see in the future the irresponsible judgments of clerical intolerance again humbly carried out, even to the death, by the secular arm.

In the mass of literature on the subject, the most important works are—N. Eyerich, *Directorium Inquisitorium*, Rome, 1587; F. Valdes, *Edict establishing Procedure, &c.*, Madrid, 1561; L. de Paramo (a Sicilian inquisitor), *De origine et progressu Officii Sancte Inquisitionis, ejusque dignitate et utilitate*, Madrid, 1598; Philip van Limborch, *Historia Inquisitionis, cui subjungitur Liber Sententiarum inquisitionis Tholosane*, Amsterdam, 1692; and the Abbé Marsollier's *Histoire de l'Inquisition et de son Origine*, Cologne, 1693, a work based on Limborch; J. A. Llorente, *Historia crítica de la inquisición de España*, Madrid, 1812, 1813; Gams, *Kirchengeschichte von Spanien*, vol. iii. pt. 2, Ratisbon, 1876; F. Hoffmann, *Geschichte der Inquisition*, 2 vols., Bonn, 1878; Molinier, *L'Inquisition dans le midi de la France au treizième et au quatorzième Siècle*, 1880. The modern defenders of the Inquisition are F. J. G. Rodrigo, *Historia verdadera de la Inquisición*, 3 vols., Madrid, 1876, 1877; and J. M. Orti y Lara, *La Inquisición*, Madrid, 1877. (G. W. K.)

## INSANITY

INSANITY is a generic term applied to certain morbid mental conditions produced by defect or disease of the brain. The synonyms in more or less frequent use are mental disease, alienation, derangement or aberration, madness, unsoundness of mind. There are many diseases of the general system productive of disturbance of the mental faculties which, either on account of their transient nature, from their being associated with the course of a particular disease, or from their slight intensity, are not included under the head of insanity proper. From a strictly scientific point of view it cannot be doubted that the fever patient in his delirium, or the drunkard in his excitement or stupor, is insane—that, the brain of either being under the influence of a morbid agent or of a poison, the mental faculties are deranged; yet such derangements are regarded as functional disturbances, *i.e.*, disturbances produced by agencies which experience tells will, in the majority of cases, pass off within a given period without permanent results on the tissues of the organ. The comprehensive scientific view of the position is, that all diseases of the nervous system, whether primary or secondary, congenital or acquired, should, in the words of Griesinger, be regarded as one inseparable whole, of which the so-called mental diseases comprise only a moderate proportion. However important it may be for the physician to keep this principle before him, it may be freely admitted that it cannot be carried out fully in practice, and that social considerations compel the medical profession and the public at large to draw an arbitrary line between such functional diseases of the nervous system as hysteria, hypochondriasis, and delirium on the one hand, and such conditions as mania, melancholia, and dementia on the other.

All attempts at a short definition of the term insanity have proved unsatisfactory; perhaps the nearest approach to accuracy is attained by the rough statement that it is a chronic disease of the brain inducing chronic disordered mental symptoms—the term disease being used in its widest acceptance. But even this definition is at once too comprehensive, as under it might be included certain of the functional disturbances alluded to, and too exclusive, as it does not comprehend certain rare transitory forms. Still, taken over all, this may be accepted as the least defective short definition; and moreover it possesses the

great practical advantage of keeping before the student the primary fact that insanity is the result of disease of the brain, that it is not a mere immaterial disorder of the intellect. In the earliest epochs of medicine the corporeal character of insanity was generally admitted, and it was not until the superstitious ignorance of the Middle Ages had obliterated the scientific, though by no means always accurate, deductions of the early writers that any theory of its purely psychical character arose. At the present day it is unnecessary to combat such a theory, as it is universally accepted that the brain is the organ through which mental phenomena are manifested, and therefore that it is impossible to conceive of the existence of an insane mind in a healthy brain. On this basis insanity may be defined as consisting in morbid conditions of the brain, the results of defective formation or altered nutrition of its substance induced by local or general morbid processes, and characterized especially by non-development, obliteration, impairment, or perversion of one or more of its psychical functions. Thus insanity is not a simple condition; it comprises a large number of diseased states of the brain, which have been gathered under one popular term on account of mental defect or aberration being the predominant symptom.

The insanities are sharply divided into two great classes—the Congenital and the Acquired. Under the head of Congenital Insanity fall to be considered all cases in which, from whatever cause, brain development has been arrested, with consequent impotentiality of development of the mental faculties; under that of Acquired Insanity all those in which the brain has been born healthy, but has suffered from morbid processes affecting it primarily, or from diseased states of the general system implicating it secondarily. In studying the causation of these two great classes, it will be found that certain remote influences exist which are believed to be commonly predisposing; these will be considered as such, leaving the proximate or exciting causes until each class with its genera comes under review.

In most treatises on the subject will be found discussed the bearing which civilization, nationality, occupation, education, &c., have, or are supposed to have, on the production of insanity. Such discussions are generally



eminently unsatisfactory, founded as they are on common observation, broad generalizations, and very imperfect statistics. As they are for the most part negative in result, at the best almost entirely irrelevant to the present purpose, it is proposed merely to shortly summarize the general outcome of what has been arrived at by those authorities who have sought to assess the value to be attached to the influence exercised by such factors, without entering in any detail on the theories involved. (1) *Civilization*.—Although insanity is by no means unknown amongst savage races, there can be no reasonable doubt that it is much more frequently developed in civilized communities; also that, as the former come under the influence of civilization, the percentage of lunacy is increased. This is in consonance with the observation of disease of whatever nature, and is dependent in the case of insanity on the wear and tear of nerve tissue involved in the struggle for existence, the physically depressing effects of pauperism, and on the abuse of alcoholic stimulants; each of which morbid factors falls to be considered separately as a proximate cause. (2) *Nationality*.—In the face of the imperfect social statistics afforded by most European and American nations, and in their total absence or inaccessibility amongst the rest of mankind, it is impossible to adduce any trustworthy statement under this head. (3) *Occupation*.—There is nothing to prove that insanity is in any way connected with the prosecution of any trade or profession *per se*. Even if statistics existed (which they do not) showing the proportion of lunatics belonging to different occupations to the 1000 of the population, it is obvious that no accurate deduction *quoad* the influence of occupation could be drawn. (4) *Education*.—There is no evidence to show that education has any influence over either the production or the prevention of insanity. The general result of discussions on the above subjects has been the production of a series of arithmetical statements, which have either a misleading bearing or no bearing at all on the question. In the study of insanity statistics are of slight value from the scientific point of view, and are only valuable in its financial aspects.

Of much greater importance is the question of hereditary predisposition to nervous disease. There is a general and warrantable position taken up by the medical profession, founded on the observation of ages, that a constitutional condition may be generated in a family, which, although it may never manifest itself in a concrete form of disease, may materially influence development, or may make itself felt in a more subtle manner by a mere tendency to degenerative changes. In this wise hereditary predisposition may be regarded as a common factor in all insanities—in the congenital class as an arrester of brain development, in the acquired as the producer of the nervous diathesis. How the constitutional condition is generated, and in what its pathological nature consists, is beyond the ken of science; it may in fact be freely admitted that the proof of its existence hangs more on popular observation than on scientific evidence. The observation is not confined to the nervous system; it extends itself to others, as is shown by hereditary predisposition to gout, consumption, cancer, and other diseases.

It has been strongly asserted that consanguineous marriage is a prolific source of nervous instability. There is considerable diversity of opinion on this subject; the general outcome of the investigations of many careful inquirers appears to be that the offspring of healthy cousins of a healthy stock is not more liable to nervous disease than that of unrelated parents, but that where there is a family history of diathesis of any kind there is a strong tendency in the children of cousins to degeneration, not only in the direction of the original diathesis, but also

towards instability of the nervous system.<sup>1</sup> The objection to the marriage of blood relations does not rise from the bare fact of their relationship, but has its ground in the fear of their having similar vitiations in their constitution, which, in their children, are prone to become intensified. There is sufficient evidence adducible to prove that close breeding is productive of degeneration; and when the multifarious functions of the nervous system are taken into account, it may almost be assumed not only that it suffers concomitantly with other organs, but that it may also be the first to suffer independently.

Of the other causes affecting the parents which appear to have an influence in engendering a predisposition to insanity in the offspring, the abuse of alcoholic stimulants and opiates, over-exertion of the mental faculties, advanced age, and weak health may be cited. Great stress has been laid on the influence exercised by the first of these conditions, and many extreme statements have been made regarding it. Such must be accepted with reserve, for, although there is reason for attaching considerable weight to the history of ancestral intemperance as a probable causating influence, it has been generally assumed as the proved cause by those who have treated of the subject, without reference to other agencies which may have acted in common with it, or quite independently of it. The question has not as yet been fairly worked out. However unsatisfactory from a scientific point of view it may appear, the general statement must stand—that whatever tends to lower the nervous energy of a parent may modify the development of the progeny. It is merely a matter of probabilities in a given case.

Constitutional tendency to nervous instability once established in a family may make itself felt in various directions,—epilepsy, hysteria, hypochondriasis, neuralgia, certain forms of paralysis, insanity, eccentricity. It is asserted that exceptional genius in an individual member is a phenomenal indication.

Confined to the question of insanity, this morbid inheritance may manifest itself in two directions,—in defective brain organization manifest from birth, or from the age at which its faculties are potential, *i.e.*, congenital insanity; or in the neurotic diathesis, which may be present in a brain to all appearance congenitally perfect, and may present itself merely by a tendency to break down under circumstances which would not affect a person of originally healthy constitution.

In systematic works and in asylum reports, it has been too much the fashion to accept the evidence of the existence of insanity in a relative as a proof of hereditary predisposition in a given case. In estimating the value to be attached to such histories, two things must be taken into account,—first, the amount and quality of proved ancestral nervous disease, and, secondly, the period of life at which it appeared in the alleged insane ancestor. Take, for instance, the case of a lunatic whose father or mother is reported to have died insane; this may be true in fact, but may still have no bearing on the causation of the patient's insanity; for the parent may have been the subject of mental disease at a period subsequent to the birth of the child, he may have drunk himself into alcoholic mania late in life, or disease of the cerebral arteries in old age may have produced senile insanity. It is difficult to limit the remote-

<sup>1</sup> See Report of Committee appointed by New York State Medical Society, in *American Journal of Insanity*, 1870; G. H. Darwin, *Statistical Society's Journal*, June 1875; Dr Langdon Down, "On Marriages of Consanguinity," *London Hospital Clinical Lectures and Reports*, 1866; Dr Arthur Mitchell, "On Consanguineous Marriages," in *Edin. Med. Journ.*, 1865; Mandley, "On Hereditary Tendency," *Journal of Mental Science*, Jan. 1863 and Jan. 1864; Trousean, *Clinique Médicale de l'Hôtel de Dieu de Paris*, 1868, vol. ii, pp. 129-137; Alfred Henry Huth, *The Marriage of Near Kin*, 1875.

ness of relationship in tracing hereditary predisposition, mainly from the fact that it frequently skips a generation. As a rule it does not confine itself to a single individual of a family, but makes itself felt in one form or another in several members. According to Esquirol and Baillarger, it is more frequently transmitted through the female than through the male branch, but this opinion is called in question by Koch of Würtemberg, whose statistics show that hereditary tendency to insanity acts more strongly through the father than through the mother.

#### CONGENITAL INSANITY.

The morbid mental conditions which fall to be considered under this head are *Idiocy* (with its modification *Imbecility*) and *Cretinism*.

*Idiocy*.—In treating of idiocy it must be carefully borne in mind that we are dealing with mental phenomena dissociated from active bodily disease, and that, in whatever degree it may exist, we have to deal with a brain condition fixed by the pathological circumstances under which its possessor came into the world, or by such as had been present before full cerebral activity could be developed, and the symptoms of which are not dependent on the intervention of any subsequent morbid process. From the earliest ages the term *Amentia* has been applied to this condition, in contradistinction to *Dementia*, the mental weakness following on acquired insanity.

The causes of congenital idiocy may be divided into four classes:—(1) hereditary predisposition, (2) constitutional conditions of one or both parents affecting the constitution of the infant, (3) injuries of the infant head prior to or at birth, and (4) injuries or diseases affecting the infant head during infancy. All these classes of causes may act in two directions: they may produce either non-development or abnormal development of the cranial bones, as evidenced by microcephalism, or by deformity of the head; or they may induce a more subtle morbid condition of the constituent elements of the brain. As a rule, the pathological process is more easily traceable in the case of the last three classes than in the first. For instance, in the case of constitutional conditions of the parents we may have a history of syphilis, a disease which often leaves its traces on the bones of the skull; and in the third case congenital malformation of the brain may be produced by mechanical causes acting on the child in utero, such as attempts to procure abortion, and deformities of the maternal pelvis rendering labour difficult and instrumental interference necessary. In such cases the bones of the skull may be injured; it is only fair, however, to say that more brains are saved than injured by instrumental interference. With regard to the fourth class, it is evident that the term congenital is not strictly applicable; but, as the period of life implicated is that prior to the potentiality of the manifestation of the intellectual powers, and as the result is identical with that of the other classes of causes, it is warrantable to connect it with them, on pathological principles more than as a mere matter of convenience.

Dr Ireland, in his work *On Idiocy and Imbecility*, classifies idiots from the standpoint of pathology as follows:—(1) Genetous idiocy: in this form, which he holds to be complete before birth, he believes the presumption of heredity to be stronger than in other forms; the vitality of the general system is stated to be lower than normal; the palate is vaulted and narrow, the teeth misshapen, wrongly placed, and prone to decay, and the patient dwarfish in appearance; the head is generally unsymmetrical, and the commissures occasionally atrophied; (2) Microcephalic idiocy, a term which explains itself; (3) Eclampsic idiocy, due to the effects of infantile convulsions; (4) Epileptic idiocy;

(5) Hydrocephalic idiocy, due to water on the brain; (6) Paralytic idiocy, a rare form, due to the brain injury causing the paralysis; (7) Traumatic idiocy, a form produced by the third class of causes above mentioned; (8) Inflammatory idiocy; (9) Idiocy by deprivation of one or more of the special senses. Dr Ireland's wide experience has enabled him to differentiate these groups further by describing the general characteristics, mental and physical, of each.

The general conformation of the idiot is often very imperfect; he is sometimes deformed, but more frequently the frame is merely awkwardly put together, and he is generally of short stature. Only about one-fourth of all idiots have heads smaller than common. Many cases are on record in which the cranial measurements exceed the average. It is the irregularity of development of the bones of the skull, especially at the base, which marks the condition. Cases, however, often present themselves in which the skull is perfect in form and size. In such the mischief has begun in the brain matter. The palate is very often highly arched, in some cleft; hare-lip is not uncommon; in fact congenital defect or malformation of other organs than the brain is more commonly met with amongst idiots than in the general community. Of the special senses, hearing is most frequently absent. Sight is good, although coordination may be defective. Many are mute. On account of the mental dulness it is difficult to determine whether the senses of touch, taste, and smell suffer impairment; but the impression is that their acuteness is below the average. It is needless to attempt a description of the mental phenomena of idiots, which range between utter want of intelligence and mere weakness of intellect.

The term *Imbecility* has been conventionally employed to indicate the less profound degrees of idiocy, but in point of fact no distinct line of demarcation can be drawn; the application of either term to a given case depends more on the opinion of the observer than on the condition of the observed. As the scale of imbeciles ascends, it is found that the condition is evidenced not so much by low obtuseness as by irregularity of intellectual development. This serves to mark the difference between the extreme stupidity of the lowest of the healthy and the highest form of the morbidly deprived type. The two conditions do not merge gradually one into the other. Extreme stupidity and sottishness mark many cases of idiocy, but only in the lowest types, where no dubiety of opinion can exist as to their nature, and in a manner which can never be mistaken for the dulness of the man who is less talented than the average of mankind. Where in theory the morbid (morbid in the sense of deprivation) and the healthy types might be supposed to approach each other, in practice we find that, in fact, no debatable ground exists. The uniformity of dulness of the former stands in marked opposition to the irregularity of mental conformation in the latter. Comparatively speaking, there are few idiots or imbeciles who are uniformly deprived of mental power; some may be utterly sottish, living a mere vegetable existence, but every one must at least have heard of the quaint and crafty sayings of manifest idiots indicating the presence of no mean power of applied observation. In institutions for the treatment of idiots and imbeciles, children are found not only able to read and write, but even capable of applying the simpler rules of arithmetic. A man may possess a very considerable need of receptive faculty and yet be idiotic in respect of the power of application; he may be physically disabled from relation, and so be manifestly a deprived person, unfit to take a position in the world on the same platform as his fellows.

Dr Ireland subdivides idiots, for the purposes of education, into five grades,—the first comprising those who can neither



speakers nor understand speech, the second those who can understand a few easy words, the third those who can speak and can be taught to work, the fourth those who can be taught to read and write, and the fifth those who can read books for themselves. The treatment of idiocy and imbecility consists almost entirely of attention to hygiene, and the building up of the enfeebled constitution, along with endeavours to develop what small amount of faculty exists by patiently applied educational influences. The success which has attended this line of treatment in many of our public and private institutions has been very considerable. It may be safely stated that all idiotic or imbecile children have a far better chance of amelioration in asylums devoted to them than by any amount of care and teaching lavished upon them at home.

In the class of idiots just spoken of imperfect development of the intellectual faculties is the prominent feature,—so prominent that it masks the arrest of potentiality of development of the moral sense, the absence of which, even if noticed, is regarded as relatively unimportant; but, in conducting the practical study of congenital idiots, a class presents itself in which the moral sense is wanting or deficient, whilst the intellectual powers are apparently up to the average. It is the custom of writers on the subject to speak of "intellectual" and "moral" idiots. The terms are convenient for clinical purposes, but the two conditions cannot be disassociated, and the terms therefore severally only imply a specially marked deprivation of intellect or moral sense in a given case. The everyday observer has no difficulty in recognizing as a fact that deficiency in receptive capacity is evidence of imperfect cerebral development; but it is not so patent to him that the perception of right and wrong can be compromised through the same cause, or to comprehend that loss of moral sense may result from disease. The same difficulty does not present itself to the pathologist; for, in the case of a child born under circumstances adverse to brain development, and in whom no process of education can develop an appreciation of what is right or wrong, although the intellectual faculties appear to be but slightly blunted or not blunted at all, he cannot avoid connecting the psychical peculiarity with the pathological evidence. The world is apt enough to refer any fault in intellectual development, manifested by imperfect receptivity, to a definite physical cause, and is willing to base opinion on comparatively slight data; but it is not so ready to accept the theory of a pathological implication of the intellectual attributes concerned in the perception of the difference between right and wrong. Were, however, two cases pitted one against another—the first, one of so-called intellectual, the second, one of so-called moral idiocy—it would be found that, except as regards the psychical manifestations, the cases might be identical. In both there might be a family history of tendency to degeneration of the nervous system, a peculiar cranial conformation, a history of nervous symptoms during infancy, and of a series of indications of mental incapacities during adolescence, differing only in this, that in the first the prominent indication of mental weakness was inability to add two and two together, in the second the prominent feature was incapacity to distinguish right from wrong. What complicates the question of moral idiocy is, that many of its subjects can, when an abstract proposition is placed before them, answer according to the dictates of morality, which they may have learnt by memory. If asked whether it is right or wrong to lie or steal they will say it is wrong; still, when they themselves are detected in either offence, there is an evident non-recognition of its concrete nature. The question of moral idiocy will always be a moot one between the casuist and the pathologist; but, when the whole natural history of such cases is compared, there are

points of differentiation between them and mere moral depravity which must appeal to even biased observers. Family history, individual peculiarities, the manifest imbecility of the acts committed, the general bizarre nature of the phenomena, remove such cases from the ordinary category of crime.

*Statistics.*—According to the census returns of 1871 the total number of persons described as Idiots and Imbeciles in England and Wales was 29,452, the equality of the sexes being remarkable—namely, 14,728 males and 14,724 females. Compared with the entire population, the ratio is one idiot or imbecile to 771 persons, or 13 per 10,000 persons living. Whether the returns are defective, owing to the natural sensitiveness of persons who would desire to conceal the occurrence of idiocy in their families, we have no means of knowing; but such a feeling is no doubt likely to exist among those who look upon mental infirmity as humiliating, rather than as one of the many physical evils which afflict humanity. According to Ireland, this number (29,452) is 25 per cent. below the mark. The following table shows the number of idiots according to official returns of the various countries; probably they are subject to the same criticism as the census returns for England.

	Males.	Females.	Total.	Proportion to 100,000 of population.
England and Wales.....	14,728	14,724	29,452	139
Scotland.....	2,304	2,317	4,621	134
Ireland.....	...	...	8,151	150
France (including Cretins).....	20,456	14,677	35,133	97
Germany (1871).....	16,133	14,395	33,739	82
Sweden (1870).....	...	...	1,632	38
Norway.....	...	...	2,039	116
United States (1870).....	13,219	9,209	22,428	58

The relative frequency of congenital and acquired insanity in various countries is shown in the following table, taken from Koch's statistics of insanity in Württemberg, which gives the number of idiots to 100 lunatics:—

Prussia.....	153	France.....	66
Bavaria.....	154	Denmark.....	58
Saxony.....	162	Sweden.....	22
Austria.....	53	Norway.....	65
Hungary.....	140	England and Wales.....	74
Canton of Bern.....	117	Scotland.....	68
America.....	79	Ireland.....	69

It is difficult to understand the wide divergence of these figures, except it be that in certain states, such as Prussia and Bavaria, dements have been taken along with aments, and in others cretins. This cannot, however, apply to the case of France, which is stated to have only 66 idiots to every 100 lunatics. In many districts of France cretinism is very common; it is practically unknown in England, where the proportion of idiots is stated as higher than in France; and it is rare in Prussia, which stands at 153 idiots to 100 lunatics. Manifestly imperfect as this table is, it shows how important an element idiocy is in social statistics; few are aware that the number of idiots and that of lunatics approach so nearly.

*Cretinism.*—*Crétin* probably comes from *Chrétien*, either from the idea that the person was innocent in the sense in which that word is employed occasionally to imply a person who cannot sin, or from the religious respect in which cretins were held. Cretinism is a form of congenital insanity inasmuch as the cretino-genetic miasma acts before birth; it is endemic in many mountainous countries, and is said to occur most frequently on magnesian limestone formations, but never at an elevation above 3000 feet. Although all cretins have not goitre, and all goitrous persons are not cretins, there is a very intimate relationship between the two conditions. The districts in Europe in which it is most common are the departments of Hautes-Pyrénées, Haute-Savoie, and Hautes-Alpes; Styria, Upper Austria, the province of Aosta, and Sardinia. It is found more sparsely in other parts of Europe, and also among the Himalayas and Andes. It occasionally presents itself in flat countries,—a remarkable instance being the island of Niederwerth below Coblenz, where out of 750 inhabitants there are 131 cretins (Dr Ireland). Notwithstanding the circumscribed area in which this disease exists, affording, it might be supposed, data founded on the conditions of

life common to their inhabitants for arriving at conclusions as to its cause, nothing has been definitely determined. Cretinism has occupied the attention of many eminent observers, but the various theories they have advanced have been in succession overturned. It has been suggested that the condition is due to the constant use of snow water, or to the presence of sulphate of iron or of lime in water, but none of these theories admit of universal application. That the disease is due to some geological or climatic cause appears certain from the fact, stated by Baillarger, that it disappears from a family in one or two generations after removal to a healthy climate, and may even be prevented by the gravid mother leaving a valley where it is rife for localities where cretinism is unknown. The physical and mental symptoms of cretinism are so closely allied in essentials to those of congenital idiocy as not to demand a separate description. The marked features of the disease are its endemic nature and its intimate connexion with goitre. See CRETINISM.

*Bibliography.*—*Rapport de la Commission de S. M. le Roi de Sardaigne, pour étudier le Crétinisme*, Turin, 1848; B. Nilpce, *Traité du Goitre et du Crétinisme*, Paris, 1851; *Leobachtungen über den Crétinismus*, published by the physicians of the hospital at Maria-berg, Tübingen, 1850, 1851, and 1852; Guggenbühl, *Die Crétinien-Heilstadt auf dem Abendberg*, Bern and St Gall, 1853; Virchow, *Untersuchungen über die Entwicklung des Schädelsgrundes im gesunden und krankhaften Zustande und über den Einfluss derselben auf Schädelform, Gesichtsbildung, und Gehirnbau* (Berlin, 1857), and *Gesammte Abhandlungen zur wissenschaftlichen Medicin* (Frankfurt, 1856); Saint Lager, *Études sur les Causes du Crétinisme et du Goitre endémique*, Paris, 1867, and *Deuxième Série d'Études sur les Causes du Crétinisme*, Lyon, 1868; Baillarger, *Enquête sur le Goitre et le Crétinisme*, Paris, 1873; Max Parchappe, *Études sur le Goitre et le Crétinisme*, edited and annotated by L. Lunier, Paris, 1874; Lombrosa, *Rivista Clinica di Bologna*, pt. 7, July 1873, and pt. 11, November 1873; Ireland, *Edinburgh Medical Journal* for August and September 1875, and *On Idiocy and Imbecidity*, 1877. The last-named is the standard work on idiocy.

## ACQUIRED INSANITY.

### *Pathology.*

It is predicated in treating of Acquired Insanity that we have to deal with brains congenitally perfect, the exercise of whose functions has been normal until the incidence of disease. A full description of the tissues of the healthy brain will be found in the article ANATOMY (vol. i. pp. 869–880), a careful perusal of which will very materially assist the reader in following the present remarks on pathology. A short recapitulation of certain anatomical facts is, however, necessary. The purely nervous structures of the brain consist of very delicate fibres and cells, the latter occurring only in the grey matter. It is richly supplied with blood vessels, the supply being six times greater to the grey matter than to the white. These tissues are supported and separated one from the other by a connective tissue, or interstitial matter, the *neuroglia*; the whole organ is enveloped in membranes which separate it from the skull. By one system of independent fibres (the expansion system) communication is maintained between the spinal cord, the central ganglia, and the cortical grey matter; by a second system of fibres (the commissural), corresponding and identical regions of the grey matter of the two opposite hemispheres are united; and by a third system (the horizontal) communication is maintained between parts of the same hemisphere. The cells communicate one with the other by means of processes or poles, fine projections from the body of the cell. The observations of Cleland and Boll show that the apical processes become connected with the fibres as they go to the periphery; the basal processes loop with the horizontal fibres, and also, by means of their recurrent poles, with those of the expansion series. But it is of great importance to observe that we have no

evidence of fibre communicating directly with fibre, or no certain proof that one series of fibres communicates directly with others; in fact, all anatomical demonstration goes to prove the individuality and isolation of fibre, the processes of the cells being the connecting link. It is universally accepted that the cerebral cells possess the vital property of generating, receiving, and transmitting nervous influences, and that the fibres are the organs by means of which these influences are received and communicated. In the words of Herman, “in a part of the central organs (the cortical cells) certain material processes are accompanied in an inexplicable manner with wholly undefinable phenomena which characterize what we term *consciousness*.” The term *mind* may be applied to the combination of all the actual and possible states of consciousness of the organism. “We have a right to presuppose that in the brain, as in other organs of the body, the normal exercise of function is dependent on a perfect maintenance of the anatomical relations of the component structures, and conversely that morbid conditions of these structures must affect the whole economy more or less seriously” (Bucknill and Tuke). In studying brain pathology it must be kept in view that the brain cannot, like the lungs, liver, and kidneys, cast any of its functions on other organs; it must do its own work, rid itself of its effete matter, and of the products of injury or disease, and provide within itself for the resumption of functions, the exercise of which has become impaired from whatever cause.

Solutions of continuity, preventing perfect maintenance of the component cerebral tissues, may arise from—(1) idiopathic causes, *i.e.*, causes originating primarily in the brain; (2) traumatic causes (injury to the head); (3) the effects of other neuroses (morbid nerve conditions); (4) adventitious products (tumours, &c.); (5) morbid conditions of the general system secondarily implicating the brain; (6) evolutionary conditions of the system concurrently affecting the brain; (7) toxic agents (poisons). In the case of insanity the results of morbid action are confined to the convolutions of the superior surface of the brain, and to the upper part of its lateral aspects; for the most part its base and inferior lateral aspects and the cerebellum are unaffected. It is true that in old standing cases the central ganglia present lesions, but these are for the most part secondary, and are due to the action of disease in the superior convolutions.

1. Idiopathic changes occur from disease affecting the tissues, the cause of which it may be impossible to trace, —as, for instance, acute inflammation, which, however, is not a frequent cause of insanity. Diffused subacute inflammation is held to be a much more fruitful cause, producing increase (sclerosis) of the neuroglia, degeneration of the cells, destruction (atrophy) and displacement of fibres, and aneurism, distortion, and obliteration of vessels.

A large and important class of causes of idiopathic morbid action is due to over-excitation of the brain. The causes of over-excitation of the brain functions are those which, in most works on insanity, are spoken of as “moral” (grief, anxiety, domestic complications, disappointment, terror, sorrow or joy, religious or political excitement, the exercise of the mental faculties by study unduly prolonged or conducted under adverse circumstances) in contradistinction to “physical” causes,—a distinction which implies some material difference in their method of operation. To the most superficial observer, the deformed head of the idiot, and the paralysis of mind and body which follows on the rupture of a cerebral vessel, are coarsely material conditions; but when mental aberration follows on mental excitement, men are prone to regard it more as a derangement of function than as an evidence of deteriora-



tion of brain structure. If, however, we give due weight to the results of physiological research, the matter is not quite so obscure. Arguing from the analogies of other organs and from direct observation, there is reason to believe that when the brain functions are being actively exerted there is a dilatation of the vessels and an increased blood supply (hyperæmia) to its superior and lateral surfaces. This functional hyperæmia is caused by the direct action of the cerebral cells, which, along with the sympathetic system of nerves, exercise control over the muscular coats of the arteries, the immediate regulators of blood supply to any given part. Control over muscular tissue implies, of course, control in two directions, dilatation and contraction. Functional hyperæmia is in every respect a healthy condition, one necessary for the provision of temporary nutriment during temporary action, ceasing with the withdrawal of stimulus, when the calibre of the vessels is reduced to its original dimensions through the contracting influence of the cells. But if the excitement is unduly prolonged a new result appears; the cells themselves become exhausted, and therefore, even if the stimulus is withdrawn, they are unable to assert their ordinary control over the arterial muscular coats in the direction of contraction, so that the increased blood supply continues although the stimulus which caused it has been removed. Instead of functional hyperæmia we have a hyperæmia caused, not by functional excitement, but by exhaustion of the controlling organs. In a minor degree the results of this condition are matters of everyday observation; over-taxation of the brain functions, by study for instance, is very generally followed by sensations of fulness and aching of the head, loss of sleep, and general exhaustion,—a condition which is recovered from when the primary irritation is withdrawn, *i.e.*, when the arteries reacquire healthy tone. But if relief from the causes of irritation is not obtained, a sequence of events ensues tending to deterioration of tissue. In the first place, sleep, the condition necessary for rest and recuperation of the cells, becomes unattainable. Physiological research has shown that during sleep the supply of blood to the brain is diminished (anæmia), that anæmia is necessary for, and hyperæmia is inimical to, its production. Further deterioration of cell activity follows on non-recuperation, and concomitant diminished control over the vessels tends to the establishment of morbid hyperæmia and more or less blood stagnation (stasis). It would be far beyond the compass of this article to follow out in detail the various pathological processes which ensue on paralysis of vaso-motor action; two only need be alluded to—(1) the various changes which take place in the behaviour of the constituents of the blood, producing congestion and greater or less obstruction to its normal distribution, and (2) the effects which congestion produces on the lymphatic system of the brain, the system by which effete matter is largely removed from it. It is now generally recognized that the lymphatics of the brain are perivascular, *i.e.*, that they are tubes surrounding the arteries, patent under ordinary conditions; when, however, the arteries are distended, it is easy to comprehend that the lymphatic system becomes occluded by the artery filling up the space provided for it, and therefore that the removal of waste products becomes difficult or impossible. It is a pathological axiom that the structural integrity of a part is dependent on the maintenance of its vascular unity, in other words, on the regular supply and withdrawal of blood by its regular channels. This if impaired or destroyed is necessarily followed by histological changes and by disturbance of function.

By this exposition of a probable sequence of pathological events it is desired to indicate that disturbance of function directly referable to over-excitation of the brain is not a

mere functional derangement, not a mere morbid increase of a normal emotion, but that it is the manifestation of a pathological condition,—that, in effect, so-called moral causes may be the producers of physical cerebral disease. This meets with support from the clinical observation that, with very rare exceptions, a considerable period of time elapses between the incidence of the moral cause and the first indication of mental alienation,—an interval during which sleep has been absent in consequence of continued hyperæmia. Instances of melancholy or mania being suddenly produced by mental shock must be searched for in works of fiction. Sudden fright, more especially, is stated to produce immediate convulsion, epilepsy, and catalepsy, but not insanity; except in certain comparatively rare instances, in which it appears to induce with great rapidity a cataleptic mental state, presently to be spoken of as acute primary dementia. Over-exercise of the intellectual function is not by any means such a prolific cause of brain disease as undue emotion. It is not work but worry that kills the brain. When both are combined the result is often rapid.

On the removal or persistence of congestion depends the issue of a case—recovery, or further and permanent solution of continuity. Unless relief is soon obtained, the changes in the cells are followed by lesions of other brain structures which are productive of important pathological conditions affecting the general system; these in their turn render recovery more difficult or impossible, or may even cause death. (For a full account of the various lesions found in the brains of the insane, consult Bucknill and Tuke, *Manual of Psychological Medicine*, 4th ed., cap. vi.; Fox's *Pathological Anatomy of the Nervous Centres*, London, 1874; J. Batty Tuke, "On the Morbid Histology of the Brain and Spinal Cord as observed in the Insane," *Brit. and For. Medico-Chirurgical Review*, 1873-74.)

2. The second class comprises all accidents and injuries affecting the brain, and is most conveniently termed *traumatic*. Violence to the head may produce fracture of the skull with or without depression, extravasation of blood in or on the brain, or concussion. There is no relation between the apparent extent of the injury and the results in insanity; extensive fractures of the frontal, lateral, and superior surfaces of the skull, even when complicated with rupture of the envelopes and loss of brain matter, are not, taken over all, more productive of insanity, if so much so, as the apparently less serious condition of concussion. The reason of this is not far to seek; by the open wound free egress is afforded for extravasated blood and the products of inflammation, whereas in concussion, which may also involve extravasation of blood in or on the brain, foreign substances have no means of escape, and so may set up morbid action of a grave nature. Occasionally insanity follows rapidly on the injury, but much more frequently weeks or even months elapse before development of mental symptoms amounting to insanity. During this period morbid action is proceeding on the inner surface of the skull, in the membranes, or in the brain itself. On the inner table of the skull bony growths may be in process of formation, subacute inflammation of the membranes may be going on, and from the same cause the brain may be undergoing progressive changes generally in the direction of sclerosis, *i.e.*, increase of connective tissue.

3. The nervous diseases in the train of which insanity occasionally follows are Epilepsy, Hysteria, and Locomotor Ataxy. In the case of Epilepsy the brain lesions are doubtless the result of the frequently asphyxiated condition of the patient and of the blood poisoning due to the retention of carbonic acid gas (see EPILEPSY). As might be expected, lesions of the arteries in the form of hypertrophy of their coats is frequently observed. The canals in the brain

matter through which the vessels pass are very frequently found dilated to from two to six times their normal dimensions. If the richness of the blood supply to the grey matter is considered, this condition of dilatation must imply an immense loss of brain tissue; moreover, the cells are frequently found suffering degeneration. In dealing with the subject of Hysteria, we have, as stated in the article especially bearing on the subject (HYSTERIA), to do with a disease which, although marked by very prominent symptoms, possesses no anatomical seat, and thus when the disease amounts to insanity we are equally in the dark as to the cerebral conditions. The insanity following or accompanying hysteria is not a fatal one in its earlier stages, and there is no report extant of an autopsy on a recent case of this disease. Locomotor Ataxy is a disease of the spinal cord, sclerosis of its posterior columns (see ATAXY). It implicates other parts of the nervous system,—for instance, the optic tracts and nerves. Insanity occasionally is concurrent with, and probably, if not certainly, is produced by an extension of the sclerosis to the cerebral convolutions. This theory meets support from the fact that the mental symptoms associated with locomotor ataxy resemble very closely those of general paralysis, in which hypertrophy of the connective tissue of the superior convolutions has been demonstrated.

4. By the term adventitious products it is meant to indicate all forms of tumours of the brain, skull-cap, and membranes. Such foreign bodies have three distinct effects on the brain structure:—“1st, They create an irritation tending to ramollissement in the nerve substance, with which they are in contact from their first appearance. 2d, They cause pressure on distant parts, which in its turn causes an alteration of the structure and nutrition. 3d, They set up progressive disease and degeneration of certain parts of the nerve structure, the true nature of which is as yet not very well known; but it seems to be in some way directly connected with the essential nature and constitution of all sorts of nerve substance, whether cells or fibres. Its results pathologically are an increase of the connective tissue in the form of granules, and enlargement and thickening of the coats of the blood-vessels; but all these seem to be secondary changes” (Clouston, “On Tumours of the Brain,” *Journal of Mental Science*, vol. xviii.). Apoplectic clots are practically tumours.

5. Morbid conditions of the general system secondarily implicating the brain. It is of great interest from an etiological point of view to note that insanity is seldom if ever the immediate result of diseases of individual organs, but that it is more or less intimately associated with those forms of disease which result from a general constitutional instability, such as tuberculosis, rheumatism, gout, and syphilis. There are many diseases painful in character and very depressing to the nervous system, such as stone, fistula (in fact all the so-called surgical diseases of the rectum and bladder), cancer of the uterus, &c., which might be presupposed to be probable causes of insanity, yet in point of fact are not inimical to mental health. They may be so indirectly, inasmuch as they prevent sleep, but even in this wise their effect is very slight. Nor does there appear sufficient reason to connect diseases of the heart, liver, kidneys, directly with insanity. Much stress has been laid on diseases of the uterus and ovaries, and more especially on tumours of these organs, being the primary factors in the production of insanity. Skac laid down as a special form ovario- or utero-mania; and Wergt of Illnau has described the various morbid conditions of the female organs of generation found on post-mortem examination, and has connected with them mental symptoms. But authors on gynaecology make no mention of insanity being a sequela of uterine disease, except in so far as the mental

depression which in most women follows on the knowledge that they are affected by serious, perhaps fatal, disease, and the pain and anxiety inseparable therefrom, may produce sleeplessness, and consequent melancholy; and there is no proof of such tumours exercising an extensive influence on causation by peripheral irritation. The fallacy has in the great majority of instances probably arisen from the observation often made in asylums that insanity arising from whatever cause is conditioned by the presence of uterine growths, and that delusions of a sexual character may arise from the sensations thereby produced. Of the very few instances on record in which a direct connexion between uterine disease and insanity has been traced may be cited a case reported by Van der Kolk, in which deep melancholy and prolapsus uteri coexisted; the mental symptoms were at once relieved by the organ being restored to its normal position. Such cases are very rare.

It is still a moot point whether a true tubercular or plithisical insanity exists; if it does, it certainly does not arise from tubercular deposits in the brain—a very rare condition in the insane. Those authorities who deny the existence of plithisical insanity hold that, although mental symptoms do frequently present themselves in cases of consumption, and although consumption is very frequent amongst the insane, the insanity is not directly dependent on the diathesis, but more probably results from the general lowering of the system, and at most is only conditioned by the primary disease. In the case of rheumatism and gout there are strong reasons for believing that an actual translation (metastasis) of the *materies morbi* occasionally takes place from affected joints to the connective tissue of the brain and cord,—the evidence being choreic movements of the limbs (St Vitus's Dance) accompanied by acute mental symptoms, both of which disappear contemporaneously with the return of inflammatory swellings of the joints. Syphilis may act on the brain by the production of tumours (which, however, do not differ in their effects from those of other adventitious products), and by specific changes in the coats of the arteries, which become thickened and even occluded. As a consequence the tissues in their neighbourhood suffer deterioration.

The pathological relation between sun-stroke (insolation) and brain disease has not been ascertained. A certain amount of brain congestion has been observed, but not invariably. The cerebral lesion is more probably due to the extreme depression of the whole nervous system; but the *modus operandi* is unknown.

The morbid condition of the general system which most frequently implicates the brain is anæmia, not itself a disease, but the result of many diseases, such as fever, and of such drains on the constitution as lactation (suckling) and imperfect nourishment. The operativeness of these drains may be assisted by over-work under unhealthy conditions. As a typical example may be cited the dress-maker, poorly paid, poorly fed, working for many hours daily in an ill-ventilated room, and sleeping in an unhealthy garret. The term anæmia is not used here to indicate a condition antithetical to hyperæmia—it does not imply any mechanical deprivation of blood supply; on the contrary, the amount of blood, such as it is, is not reduced in quantity. The temporary mechanical anæmia which results from extreme cold produces its effects rapidly,—short delirium and profound sleep. But it is qualitative anæmia, an impoverished state of the blood, which produces more or less permanent results on cerebral health. Inanition acts rapidly on the brain: in the case of those cast away at sea on rafts or in boats the general story is that of short delirious mania, suicide, or death from nervous exhaustion, before emaciation (*i.e.*, before the reserve food of the system is consumed) takes place. So in cases where inanition is



more slowly produced, the nervous system is first depressed. And here the position becomes somewhat complicated; for not only is, under such circumstances, the relative amount of the blood constituents different from the normal standard, but its corpuscular elements change in quality; they acquire a degree of viscosity which tends to cause the red corpuscles to coalesce and hang together, and the white to lag and wander into surrounding tissues; and further, this unphysiological behaviour of the corpuscles is apt to become aggravated in regions whose nervous energy is depressed. Anæmia thus acts and reacts in procuring a condition of stasis.

6. The effects of evolutionary periods concurrently affecting the brain: puberty, adolescence, utero-gestation, the climacteric period, and old age. "Although from the time when the human being comes into the world to the final cessation of his corporeal existence the various functional operations of organic life are carried on with ceaseless activity, whilst those of animal life are only suspended by the intervals of repose which are needed for the renovation of their organs, yet there are very marked differences, not only in the degree of their united activity, but also in the relative degrees of energy which they severally manifest at different epochs" (Carpenter's *Principles of Human Physiology*, chap. xviii.). These differences in degree imply physiological modifications of nutrition, and the observation of ages has caused it to be accepted as a fact in the etiology of disease that numerous and various degenerations occur contemporaneously with such modifications, more especially in the subjects of diathetic conditions. The development of phthisis during adolescence, and of cancer amongst persons at the climacteric period, may be cited as instances. It may be freely admitted that the nexus between the physiological and the pathological position is, as regards certain of the periods, obscure, and that it is dependent more on induction than on demonstration; but it may be pleaded that it is not more obscure in respect of insanity than of other diseases. The pathological difficulty obtains mostly in the relation of the earlier evolutionary periods, puberty and adolescence, to insanity; in the others a physiologico-pathological nexus may be traced; but in regard to the former there is nothing to take hold of except the purely physiological process of development of the sexual function, the expansion of the intellectual powers, and rapid increase of the bulk of the body. Although in thoroughly stable subjects due provision is made for these evolutionary processes, it is not difficult to conceive that in the nervously unstable a considerable risk is run by the brain in consequence of the strain laid on it. Other adjuvant influences may be at work tending to excite the system which will be spoken of when the insanity occurring at these periods is described. Between the adolescent and climacteric periods the constitution of the nervous, as of the other systems, becomes established, and disturbance is not liable to occur, except from some accidental circumstance apart from evolution. In the most healthily constituted individuals the "change of life" expresses itself by some loss of vigour. The nourishing (trophesial) function becomes less active, and either various degrees of wasting occur, or there is a tendency towards restitution in bulk of tissues by a less highly organized material. The most important instance of the latter tendency is fatty degeneration of muscle, to which the muscle of the arterial system is very liable. In the mass of mankind these changes assume no pathological importance: the man or woman of middle life passes into advanced age without serious constitutional disturbance; on the other hand, there may be a break down of the system due to climacteric disease of special organs, as, for instance, fatty degeneration of the heart. In all probability the insanity of the climacteric

period may be referred to two pathological conditions: it may depend on structural changes in the brain due to fatty degeneration of its arteries and cells, or it may be a secondary result of general systemic disturbance, due to cessation of menstruation in the female, and, possibly, to some analogous modification of the sexual function in men. The senile period brings with it further reduction of formative activity; all the tissues waste, and are liable to fatty and calcareous degeneration. Here again the arteries of the brain are very generally implicated: atheroma in some degree is almost always present, but is by no means always followed by insanity. Whewell retained his faculties to the last, notwithstanding that his cerebral arteries were much diseased. Still this condition must be taken into account in studying the causation of senile insanity, as it necessarily implicates the nutrition of the brain. It must assist in preventing recuperation of the cells; it may in certain instances diminish suddenly the blood supply to a particular area; but the stronger probability is that senile mental decay lies at the door of senile degeneration of the cells.

The various and profound modifications of the system which attend the periods of utero-gestation, pregnancy, and child-bearing do not leave the nervous centres unaffected. Most women are liable to slight changes of disposition and temper, morbid longings, strange likes and dislikes during pregnancy, more especially during the earlier months; but these are universally accepted as accompaniments of the condition not involving any doubt as to sanity. But there are various factors at work in the system during pregnancy which have grave influence on the nervous system, more especially in those hereditarily predisposed, and in those gravid for the first time. There is modification of direction of the blood towards a new focus, and its quality is changed, as is shown by an increase of fibrin and water and a decrease of albumen. How much these changes structurally affect the encephalon may be deduced from the fact of the presence of bony plates (osteophyte) on the surface of the dura mater and the inner table of the skull, and how much functionally, by constant congestions and flushings. To such physical influences are superadded the discomfort and uneasiness of the situation, mental anxiety and anticipation of danger, and in the unmarried the horror of disgrace. In the puerperal (recently delivered) woman there are to be taken into pathological account the various depressing influences of child-bed, its various accidents reducing vitality, the sudden return to ordinary physiological conditions, the cessation of the occasional physiological condition, the rapid call for a new focus of nutrition, the translocation as it were of the blood supply from the uterus to the mammae,—all physical influences liable to affect the brain. These influences may act independently of moral shock; but, where this is coincident, there is a condition of the nervous system unprepared to resist, or, it may rather be said, prepared to succumb.

7. Among the toxic agents which affect the brain, alcohol holds the foremost place. On the action of this poison the article DRUNKENNESS supplies full information. Considerable difficulty exists as to the estimation of the importance to be attached to alcohol in the production of brain disease from the fact that excess in the use of stimulants is very frequently a symptom of incipient insanity, and that the symptom is often mistaken for the cause. The habitual use of opium and Indian hemp (*Cannabis indica*), which first stimulate and then paralyse the action of the cerebral cells, is a frequent cause of lesion.

Difficulties may arise in individual cases in establishing a theory of causation from the presence of what are generally spoken of in systematic works on insanity as "mixed" causes, *i.e.*, the presence of two morbid factors in one individual. So long as these consist in variety in

character of excited psychical action, such as grief and anxiety of business, over-prolonged study and domestic affliction, the combination does not affect the position; but when we have a history of one or more of such psychical influences being associated with a depraved condition of the general system; with poverty, with excess in alcoholic stimulants, or with hereditary predisposition, it appears at the first glance difficult to assess the value to be attached to each in the production of brain disease. This complication is, however, more apparent than real; weakness of the system, whether produced by disease or by malnutrition, only implies a condition in which cerebral degeneration is more likely to occur, but where there is no reason to believe it would have occurred if the brain, weakened along with the other organs of the body, had not been subjected to over-excitation. It may be argued that the brain excitation would not have produced the lesion if the tone of the general system had not been lowered: that is as it may be,—it is a proposition which cannot be accepted or denied positively in the absence of positive data. But negative data obtain which warrant its refusal. These are twofold:—a depraved condition of the general system is a frequent result of over-excitation of the brain, the result being liable to be mistaken for the efficient cause; and the history and symptoms of insanity resulting from special morbid conditions of the system differ materially from those produced by over-excitation.

The action of all these varied morbid factors is in the direction of solution of continuity of cerebral elements, and consequently of perversion of psychical function. And here a wide gap opens itself in the study of brain pathology in its relation to morbid psychology. No adequate theory has been advanced to account for the sequence of a particular type or train of morbid mental symptoms on a particular morbid condition of the brain. In the most definite forms of insanity, those of which the morbid anatomy is pretty definitely determined, there is not the slightest suggestion afforded of the causation of the peculiar type of mental symptoms which symptomatize them, or for the alternation of symptoms in an individual case, or for diversity of symptoms apparently starting from the same cause. All that is known is that when the hemispherical ganglia are diseased we may have excitement or depression of feeling, delusion, or obfuscation of the intellectual and moral qualities; but why in one case excitement, in another delusion, and in a third both, is an utter mystery.

#### *Classification.*

The mental symptoms of acquired insanity have been classified from the time of Pinel—it might, save from some slight difference in the application of the terms, be said from the time of Hippocrates—as mania, melancholia, and dementia, according as exaltation or depression of feeling or weakness of intellect presents itself most prominently in a given case. To these has been added delusional insanity, spoken of by certain authors as monomania. Numberless classifications founded on psychological considerations have been advanced, involving, however, more variety in terminology than in principle; all such, when analysed, are reducible to the primitive mania, melancholia, and dementia. Pritchard asserted that mental symptoms were divisible into two great classes, according as the intellectual and moral faculties were implicated. This principle falls to the ground from the simple but most important fact that the primary symptom in all insanities is perversion of the moral sense, and that this perversion pervades all cases of mental disease to their termination. This change of morale amounts to various degrees of perversion of the ordinary character and disposition of the individual. He becomes indifferent to social considerations,

apathetic and neglectful of the personal and family duties, evinces dislike and suspicion of friends and relatives, and may betake himself to excess in alcoholic stimulants and other forms of dissipation. There is a general concentration of his ideas on himself, which is often spoken of as the selfishness of the insane. According to the direction in action in which perversion of the moral sense is manifested such so-called forms of insanity have been constructed as dipsomania, kleptomania, erotomania, &c., which, however, are to be regarded as merely accidental phenomena. Moral insanity may appear to exist alone at certain times in certain cases, but it is greatly to be doubted whether it really ever exists apart from intellectual perversion. The mere fact that a person cannot appreciate the change in himself, cannot, as it were, disapprove of his own actions, is evidence that the moral faculties are not alone implicated. The converse proposition may be stated even more strongly—intellectual insanity never exists without moral perversion.

Moral perversion is, however, only one of the initial symptoms. In most insanities a “period of incubation” is observed, generally spoken of as the prodromal or initial period. Sudden and violent outbursts of insanity are occasionally reported, but, when these are carefully examined into, a train of prodromal symptoms, physical as well as psychical, can almost invariably be traced. These symptoms are for the most part insidious in character. Founding on the statements of patients suffering from premonitory symptoms, on those made by others, who, having recovered, are able to carry back their recollection to the incidence of the prodromal stage, and on the direct observation of the physician, physical indications are the first to present themselves. These consist in a feeling of fulness in the head, throbbing of the forehead and eyeballs, flashes of light before the eyes, and general malaise. The mental symptoms follow closely, and consist, in addition to the change in morale already spoken of, in restlessness, irritability, inability to apply the mind to the everyday affairs of life, and sleeplessness. In certain forms this description of the prodromal symptoms requires some slight modification. They are very generally accompanied by impairment of general health.

The classification of the insanities according to the predominant mental symptom is adopted in almost all treatises on the subject; but there is a growing conviction that this basis is neither so scientific nor so convenient as a classification based on pathology. Mania, melancholia, and dementia are merely symptoms of brain disease. If these symptoms were constant in even a considerable majority of all cases, there would be better warrant for employing them as a basis of nosology; but they vary so widely in kind and degree, they run so closely one into the other, they may all appear in an individual case within so very short a space of time, that their use is generally misleading, even as indicating the mental condition of a patient. In many cases of insanity mania may present itself to-day, melancholia to-morrow, and dementia the day after, being, in fact, indications of the course of the complaint. It is undoubtedly true that in a proportion of the insane there is a general predominance of one or other of these conditions, but it is equally true that there is an equal proportion in which the application of any one of these terms is open to question. Thus we may have a melancholic mania or a maniacal melancholia. Moreover, there are many forms of insanity of which the connexion with the causation is so intimate that even those authors who adhere to the archaic classification cannot refuse to acknowledge them as pathological classes, and are compelled to treat of them under their pathological designations; puerperal insanity, epileptic insanity, senile insanity, and general paralysis may be cited as prominent examples.



To say of a man that he is maniacal is not saying more than to say of one who has lost power over his limbs that he suffers from palsy, a diagnosis which no scientific physician of the present day would be content with, as it conveys no definite idea as to the pathological character or cause of impairment of mobility. It may be freely admitted that medical science is not yet able to base a nosology of the insanities on the highest pathological platform, that of morbid anatomy. Considerable advances have been made in this direction, but the observations of pathologists, with the exception of those bearing on three or four classes of brain disease, are vague and quite insufficient for the purpose. Clinical observation, however, has served to relate symptoms with cause to such an extent as to enable the observer of mental disease to fall back on the second pathological position—etiology, and has enabled him to assert, in a very large proportion of cases, causation as a scientific and convenient standpoint for classification. After all, classifications are matters of convenience. It is not asserted that the classification adopted in this article is more than provisional; but it is asserted that it is more convenient to study the insanities in connexion with the bodily conditions of their subjects than to rely on a general description of mental symptoms which are inconstant in kind and degree, and often so complex as to render analysis impossible.

When Esquirol's definition of the mental conditions is quoted, little more need be added, for further description would merely involve an amplified account of psychological peculiarities. Esquirol thus describes the conditions:—(1) Melancholia, or, as he terms it, Lypemania, disorder of the faculties with respect to one or a small number of objects, with predominance of a sorrowful and depressing passion; (2) Monomania, in which the disorder of the faculties is limited to one or a small number of objects, with excitement, and predominance of a gay and expansive passion; (3) Mania, in which the insanity extends to all kinds of objects, and is accompanied by excitement; (4) Dementia, in which the insensate utter folly, because the organs of thought have lost their energy and the strength requisite for their functions. In 1852 Schröder van der Kolk and in 1860 Morel laid the foundation of a classification more in accordance with pathological science. The former included the different forms of the disease under two great classes:—"idiopathic insanity," comprising all cases produced by primary affections of the brain; and "sympathetic insanity," including those due to morbid conditions of the general system. Morel divided the insanities into six groups:—(1) hereditary insanity; (2) toxic insanity; (3) insanity produced by the transformation of other diseases; (4) idiopathic insanity; (5) sympathetic insanity; (6) dementia, a terminative stage. Notwithstanding faults of detail, it may be fairly said that these propositions marked a great advance in the study of insanity, and that all later classifications based on the same principles have been derived from study of them. The following system admittedly is so.

I. Idiopathic insanities.	} Idiopathic mania, melancholia, and dementia. General paralysis of the insane.
II. Traumatic insanity.	
III. The insanities associated with other neuroses.	} Epileptic insanity. Hysterical insanity. Hypochondriacal insanity.
IV. Insanity resulting from the presence of adventitious products.	
Insanities resulting from morbid conditions of the general system.	} Phthisical insanity. Rheumatic insanity. Gouty insanity. Syphilitic insanity. Insanity from sunstroke. Anæmic insanity.

VI. Insanities occurring at evolutionary periods.	} Insanity of pubescence and adolescence. Climacteric insanity. Senile insanity. Insanity of pregnancy. Puerperal insanity.
---	---

#### VII. Toxic insanity.

I. IDIOPATHIC MANIA AND MELANCHOLIA.—It is proposed to consider under the head of idiopathic mania and melancholia the large and important class of cases which result from over-excitation of the brain due to so-called moral causes. In considering this form of insanity, a difficulty arises in reconciling the dependence of two such apparently widely divergent morbid psychological states as mania and melancholia on one common pathological condition. That they are so is maintained by the following clinical observations—1st, that during the prodromal period, *i.e.*, the period during which over-excitation is using its influence on the brain tissues, the symptoms of excitement and depression generally alternate; 2d, that in certain acute cases mania and melancholia coexist, that is to say, it is impossible for the observer to say whether they are cases of maniacal melancholia or melancholic mania; 3d, that, as many cases run their course towards recovery, the symptoms are consecutively mania, melancholia, and dementia; 4th, that the effects of irritating poisons applied to the brain, alcohol markedly, produce these symptoms in some individuals in a very short space of time. These observations point, not to a difference of pathological causation, but to variation in symptoms in conformity with the progress of pathological processes. It must be borne in mind that congestion is not a condition constant in quality or in quantity, and, further, that it is an inconstant condition acting on an inconstant subject, and therefore productive of cumulative inconstant results. Brain congestion, due to over-excitation, produces functional excitement of that organ. It must be remembered that although mania is accompanied by exaltation, and melancholia by depression of feeling they are both manifestations of excitement of feeling. Given this common psychological condition of excitement, a reason must be sought for the variety of its manifestation either in some peculiarity of the irritating cause or in some idiosyncrasy of the affected individual. In either case no material assistance is gained from psychological considerations, for there is no necessary connexion between depressing emotions and melancholia; intense grief often produces acute mania, and the insanity of the man of saturnine mind is as often as not characterized by mania. The peculiarity of the irritating cause appears to be, not its psychological characteristic, but its intensity. The more rapidly excitement of feeling is produced, the more likely is mania to be the symptom of the insanity. That melancholia often supervenes on depressing emotions gradual in their incidence does not imply a psychological nexus, but that, as their irritating influence is slowly applied, so the results of the irritation are slowly produced and (as in the case of every tissue of the body) there is variety of degree of symptoms in conformity with the rapidity of the progress of pathological events. There are also various underlying conditions difficult to treat of in the mass, any one of which may have considerable bearing on an individual case. Constitutional predisposition (diathesis) may render a person more prone to the sub-acute forms of disease, and the condition of the body at the time of irritation may influence the nature of the symptoms in either direction. In the absence of the possibility of applying to the brain the mechanical aids which have given the physician an insight into the sequence of pathological events occurring in other organs, the pathologist has nothing to depend on save clinical observation. He has presented to him a diseased organ, complex in function, of the physiology of which he is, as regards its psychical action, profoundly

ignorant; all he can say is that, when its histological integrity is impaired, he has reason to believe that "some functions become torpid and oppressed, while others are excited into preternatural activity" (Bucknill and Tuke). It must be stated, however, that in a considerable proportion of cases the nature of the ultimate condition is foreshadowed from the very commencement by the character of the initial symptoms. Simple depression of feeling may be the first and last symptom of insanity, or it may gradually increase in intensity till it attains the extreme and most complicated form of melancholia. In like manner simple excitement and exaltation of feeling may characterize a case from beginning to end, or it may culminate more or less rapidly in active mania without the intervention of other psychical symptoms.

As to the duration of the prodromal period, in the mass of cases nothing can be stated with certainty; it can only be said that, as a general rule, the incidence of melancholia is more slow than that of mania. Putting aside exceptional cases, it may be stated that, whereas the former is a matter of months or weeks, the latter is a matter of weeks or days.

The initial mental symptoms having been already described, it remains only to say that the general system becomes coincidentally affected; functional disturbances of the digestive organs soon manifest themselves, and the nutrition of the body becomes defective. To this implication of other systems consequent on impairment of the trophesial (nourishment-regulating) function of the brain can be traced a large amount of the errors which exist as to the causation of idiopathic melancholia and mania. Very frequently this secondary condition is set down as the primary cause; the insanity is referred to derangements of the stomach or bowels, when in fact these are, concomitantly with the mental disturbance, results of the cerebral mischief. Doubtless these functional derangements exercise considerable influence on the progress of the case by assisting to deprave the general economy, and by producing depressing sensations in the region of the stomach. To them may probably be attributed, together with the apprehension of impending insanity, that phase of the disease spoken of by the older writers as the *stadium melancholicum*, which so frequently presents itself in incipient idiopathic cases.

During the earlier stages of the prodromal period it is impossible, in the majority of cases, for the physician to predict, with anything like certainty, whether the case may culminate in acute melancholia or acute mania. But as it progresses the irritability and restlessness which ushered in the malady become intensified; sleep is either irregular or may be lost for nights together; further degeneration of the brain constituents necessarily follows, and the loss of controlling power over ideas is manifested in excitement in one of two ways—(1) by the domination of one set of ideas, which are for the most part of a depressed character, or (2) by a tendency to follow lines of thought suggested by accidental external circumstances. Although in the one case there is a concentration and in the other a diffusion of ideas, there is the common result of occlusion of the individual from a normal process of thought, in consequence of his inability to review external circumstances correctly.

1. *Acute Idiopathic Melancholia* presents itself in three degrees of intensity:—(1) simple depression of feeling, (2) depression of feeling with delusion, (3) depression of feeling with mania or delirium. The second and third of these conditions may supervene on the first or any one of them may singly characterize the case.

*Simple Depression of Feeling.*—In no form of insanity is the sane mind more prone to project a psychological scheme of causation than in that of which simple depression of feeling is the predominant symptom. The restlessness and irritability which accompany anxiety, grief, and worry,

and the consequent exhaustion and depression, suggest a psychological continuity. There is, however, a very distinct difference between depression of feeling within the limits of health and the depression of feeling resulting from morbid processes going on in the brain, and in symptoms there is a distinct line of demarcation. A mere fit of depression, from whatever cause, does not prevent a man from using his intellectual faculties; circumstances influence him, and he can review his position; but where the limit of health is passed the normal influence of external circumstances is lost. This indication is accompanied by a gloomy apathy; the memory of the past is misery, the present is unendurable, and there is no hope in the future; everything is black within and without, every incident feeds the melancholy, every suggestion of hope is parried, and every appeal to the reason falls dead on the ear of the sufferer. This latter symptom—the inoperativeness of appeals to the reason—is a feature of all forms of insanity, and it is therefore well to notice it particularly when treating of the simplest. What to the sane mind is the simplest proposition, to the insane appears either utterly false in itself, or to have no bearing on the position. The power of comparing idea with idea, the faculty of discriminating their differences, or the perception of agreement in the midst of difference is lost—in a word, the judgment is impaired or utterly in abeyance. The common everyday expression "out of his judgment," employed to indicate that a man is insane, is psychologically accurate, and logically applicable in all forms of insanity. A strong tendency to suicide frequently presents itself; the utmost ingenuity is exercised to accomplish this object, the whole mental energies being concentrated upon it. It is impossible to render in terms the general as well as facial expression of the melancholic; it cannot be simulated with success before any one conversant with the condition.

*Depression of Feeling with Delusion.*—Idiopathic melancholia symptomatized by simple depression of feeling may become gradually complicated with delusion and hallucination, or this complicated condition may follow immediately on the initial symptoms. The delusions and hallucinations of idiopathic melancholia may be divided into three classes:—(1) those traceable to perverted sensation produced by implication of the functions of the general system; (2) those apparently dependent on the nature of the primary causing train of emotion; and (3) those which it is impossible to connect with any particular influence, either psychical or somatic. The first class contains the delusional symptoms resultant on atony of the alimentary canal, which, by producing obstinate constipation, catarrhal affections of the stomach and bowels, and dyspepsia, cause sensations which are referred by the insane mind to supernatural influences: he believes that he has serpents or worms inside him, that his gullet is closed, or that his bowels are so obstructed as to render relief by the natural passage impossible. As a direct result of this delusion food is systematically refused, and it often becomes necessary to resort to artificial feeding by the stomach-pump or some allied apparatus. Hallucinations and illusions of smell and taste may be referred to the same causes as the delusions just spoken of: the fetor of the breath due to dyspepsia may suggest to the melancholic that he is surrounded by a poisonous atmosphere, and that everything near him stinks; and the foul tongue of the same condition may be productive of hallucinations of taste, and may even lead up to the very common delusion that his food is poisoned. Such distinct objective starting points, however, do not suggest themselves for hallucinations of vision and hearing; these can only be regarded as incidental results of the morbid cerebral condition of which the process of production is unknown. Hallucinations of sight are comparatively rare; when they



do occur it is generally in the form of spectres, which prompt to suicide, self-mutilation, or homicide. Hallucinations of hearing are more common, and are believed to be of graver import. As a rule the hallucination takes the form of words emanating from a something or some one of whose personality the patient has no conception. That an apparent connexion can often be traced between the character of the delusion and that of the primary causing emotion is particularly true of the melancholic delusions which follow on religious emotionalism, so much so that many writers regard religious melancholia as a distinct form of insanity. This is a term, however, very loosely employed, and it is, in fact, by no means easy to ascertain what it implies; by one section of authors it is regarded as that form of melancholia in which the insanity centres upon religious ideas, by another as the form of insanity produced by depressing religious emotion. The latter position is tenable on purely clinical considerations, if the insanity retains the character of the causing emotion, which it very frequently does not; the former is open to the objection that the delusions may be mere accidents in a case, and may bear no relation whatever to the exciting psychical cause. One reason why the term is so strongly impressed on the mind of the public is, that it may appear as pseudo-epidemic. The waves of religious emotionalism, which almost periodically disturb society in the form of "revivals," are apt to produce explosion of psychical action in those members of the community predisposed to nervous degradation. The public never considers, in fact does not know, that any other equally potent cause of emotion might be as effectual, and therefore sets down such accidental congeries of cases as "religious melancholia," accepting that term as representing all the abnormal psychical conditions which may result from "revivals." It is better to consider religious influences in the common category of emotions producing over-excitation of the brain. The deep despondency which follows on religious emotionalism may be productive of such predominating ideas as that the soul is irrevocably lost, that the unpardonable sin has been committed, and that there is no hope of salvation. Although in the abstract it is open to question whether such predominating ideas are strictly delusions, inasmuch as they may be considered as morbid exacerbations of fears and anxieties suggested by certain schools of religious thought, still in the concrete they amount to delusion; for, even supposing they have been arrived at by a normal process of reasoning—which in most cases is extremely doubtful—they are maintained at the expense of all other religious considerations, and by the exclusion of all arguments founded on the experience of others.

The delusions which it is impossible to connect with any particular physical or psychical influence are for the most part characterized by suspicion and fear, and take such forms in the mind of the patient as that spies surround him, that all his actions are watched, that all connected with him are plotting against him, that conspiracies are being organized with a view to deprive him of his estate, procure his ruin, or do him some evil of which he can give no definite explanation. Occasionally delusions of fear and suspicion are connected with persons whom the patient has never seen, or with sections of society, such as political parties or religious communions. Self-accusation of serious crime is a frequent result of delusion. This idea of crime may be entirely unsubstantial, or it may possess some very slight foundation in fact, one which has no rational bearing on the existing position. When insane self-accusations are critically examined, it is found that remorse is very rarely connected with the real or imaginary crimes, from the consequences of which others have or might have suffered. The poetic stories of insanity produced by remorse of con-

science for crimes involving the ruin or disgrace of others than the actual offenders may be set down as in the main apocryphal.

The delusions of the melancholic are often fearfully intense, and produce very serious results in action; they are apt to extend beyond himself. By a process of reasoning which the sane mind cannot appreciate, he may argue himself into the belief that his misery is also the misery of his friends and family, that his relatives are cognizant of or implicated in his imaginary crimes, and that they must suffer the consequences along with him. As death offers to him the only chance of relief, so he believes it best that those nearest and dearest to him should die also. From this state of feeling follow those fearful acts of homicide which occasionally startle society—a parent destroys several of his children, a lover his mistress, or a husband his wife, before committing self-destruction. It is as well to attract attention here to the appearance of a tendency to homicide and suicide as an incident in a case, as the subject will have to be recurring to when adverting to the question of homicidal and suicidal insanity.

*Depression of Feeling associated with Delirium or Mania.*—In this class of cases it is impossible to say whether they should be called melancholic mania or maniacal melancholia. The wildest delirious excitement coexists with the deepest depression of feeling; delusions of fear and horror are given expression to in the most extravagant manner, and relief from them is sought in frantic attempts at suicide; the patient dashes his head against the floor or wall, tries to cast himself down stairs, holds his breath in the hope that he may suffocate. In this condition there is a strong tendency towards death, which not unfrequently occurs within a few days of the development of the graver symptoms, and which is generally produced by congestion of the lungs as a direct result of the cerebral condition, *i. e.*, by a true cerebral pneumonia.

2. *Acute Idiopathic Mania* presents itself in three forms—(1) simple exaltation of feeling, (2) exaltation of feeling with delusion, (3) acute delirious mania. The second and third of these psychical conditions may supervene on the first, or any one of them may singly characterize a case; in all, the period of transition from the prodromal stage is much more rapid than in acute idiopathic melancholia.

*Simple exaltation of feeling* manifests itself in all degrees of intensity between mild general excitement and the extreme forms of maniacal furor; in kind it may not amount to more than a decided increase of the initial symptoms of restlessness, irritability, and change of disposition; in degree it is characterized by greater or less excitement of thought, word, and action. The general vague restlessness and irritability of the prodromal period not only become exacerbated, but manifest a tendency to produce results in action. Excited action may show itself either in a general exaltation or in the suspension of normal trains of thought. A prominent example of the first psychical condition is found in the naturally devout mind under certain conditions of excitement: the habitually religious man may have meditated on schemes for self-conduct, the good of mankind, or the spread of religion, schemes which, so long as mental action was under control, were mere projects, things to be hoped for, but which under morbid excitement assert themselves so powerfully as to be regarded by the unbalanced mind as immediate necessities, to be procured at the expense of all considerations. The real distinction of religious mania from religious enthusiastic excitement consists, not in the form of the ideas, for which parallel cases might be found in sanity and insanity, but in the *per saltum* manner in which it is sought to carry them into action, in the leaving out of those links which the sane mind uses to decide on the

adoption or rejection of a scheme, but the omission of which transfers the scheme suddenly from the region of imagination and hope to one of present reality. There is an absence of religious totality; the patient is bound up in some scheme for the advancement of religious knowledge, in some project for the building of a church, the founding of a school, the establishing of a mission, or, more probably, for all at once; for this he neglects his family, all social considerations, and those duties which are the precepts of his faith. Whether the apparently efficient cause be religion, politics, or the prominent social question of the day, the results are identical, being only conditioned by the nature of the original idea. The ordinary behaviour of the man is changed; he is ever on the move; his gestures, loud tone of voice, volubility of talk, and general manner are such as to cause his friends distinctly to mark the change. A large proportion of such cases recover under appropriate treatment, but they not unfrequently pass into acute delirious mania. When the disease is manifested by the suspension of the ordinary trains of thought, the symptoms consist, for the most part, in recklessness of action and conversation; there is a sort of exalted joyousness, a strong tendency to dissipation, loud and wild though not necessarily incoherent talk, extreme restlessness, and utter want of respect for all conventionalities. Such patients (reputable members of society, be it remembered, a month or a week before) outrage all sense of decency; they may walk the street with strumpets, and appear drunk in public, forcing their behaviour on the notice of the police. They care nothing for the feelings of friends or the prospects of their families. The intellectual faculties may be active; thus wit and humour, uncontrolled by any feelings of consideration for others, may stand out all the more prominently. The condition, taken over all, is very closely allied to that stage of intoxication in which the poison of alcohol sets free all controlling influences. When the restraining power of association is lost, there is no difficulty in comprehending that the uncontrolled brain may act in any direction. This class of cases is specially emphasized, because they are apt to be mistaken by the public for instances of mere moral obliquity.

The relation of amount of mental disturbance to the degree of excitement is not definable; mania may be extreme, and the disturbance of ideas apparently slight, and *vice versa*. It is of great importance that the two following facts should be insisted on—(1) that mania of an extreme description can exist without delusion; and (2) that mania of a dangerous nature may exist without furious excitement. It is in this class of mania that cases of so-called *folie raisonnée* are for the most part met with—a class strongly insisted on by many Continental authorities as of great pathological importance. By one section of foreign writers it is spoken of as *folie raisonnée*, by another under the original name suggested by Pinel *mania sine delirio*, while by a third both are used promiscuously to indicate a class of cases in which, although considerable disturbance and excitement may exist, the sufferer is able to justify his course of action by a line of reasoning not illogical in itself, although founded on false premises.

*Exaltation of feeling with delusion or delusional mania*, whether it follows on a period of simple exaltation of feeling, or is coexistent with the first symptoms of excitement, is not to be connected with the originating psychical cause; indeed the intellectual confusion is so great and of such a kind as to render any analysis impossible. It is well to mark here the psychological difference between maniacal and melancholic delusions; the latter are persistent in character and appear to proceed from within, the former are changeful and are readily acted on from without. The general expansiveness of ideas, the rapidity with which they are produced and influenced by external objects, along

with the inability to correlate idea with idea, are productive of incoherence in thought, word, and action. For instance, a man may imagine and state that he is the king of the universe, at the same time that he enters no remonstrance against herding and eating with his fellow paupers; he may assert his superiority, but may not object to obey the behests of a common keeper.

*Acute delirious mania* is a condition often rapidly produced and not unfrequently fatal. It may be the culmination of a case which has passed through the stages of simple exaltation of feeling and mania with delusion—the latter rarely; or it may appear in a few days or even a few hours as the result of some severe mental shock. It may persist for only a short time, and is then spoken of as acute transitory mania. The symptoms are very definite,—the wildest yells and screams, a frenzied rushing to and fro, a reckless casting of the body on the ground or against the walls and furniture, smashing everything that comes in the way without any definite purpose save smashing, flushed features, clammy sweat, and a high bounding rapid pulse; nothing can control the patient but physical force, for his fury renders him blind to all influences.

3. *Acute Primary Dementia*.—This disease is of rapid incidence. It may result from sudden psychical disturbance, especially fright; occasionally no cause can be traced. After a few days or hours, during which the patient is somewhat stupid and apathetic, these symptoms increase to such a degree as to cause him to be, to all outward appearance, utterly demented; he sits unaffected by anything that goes on around him; he is completely helpless, cannot take off or put on his clothes nor feed himself, and passes urine and feces where he sits or stands; he is speechless, and cannot be roused to action by any appeal; his movements are slow, when he can be got to move at all; but the chief motor symptom is a degree of catalepsy. It may be said with truth that the condition is one of mental and bodily catalepsy. Such cases to the ordinary observer appear utterly hopeless. There is a strong tendency towards death; but, when this is overcome, it often happens that the sufferer gradually emerges from the condition, and can give an account of the sensations experienced during his illness. It may terminate in dementia of a very low type. Post-mortem examination of recent cases frequently reveals dropsy of the brain, or changes in interstitial tissues producing pressure. (See Blandford, *Insanity and its Treatment*; Bucknill and Tuke, *Psychological Medicine*; Griesinger, *On Mental Diseases*.)

4. *General Paralysis of the Insane*.—General paresis, progressive paralytic dementia, or, as it is more frequently spoken of, *general paralysis*, is a disease of the superior and lateral convolutions of the brain, which gradually extends over the whole nervous system, producing a peculiar impairment of motor power, and invariably accompanied by insanity. It is marked by well-defined series of physical and psychical symptoms, and terminates in a peculiar manner within a definite period.

General paralysis was first recognized as a special disease in France; it was indicated by Esquirol, and its history was fairly elucidated by Bayle, Delaye, and Calmeil, the latter giving it the name of *paralyse générale des aliénés*. General paralysis is a common disease, and is generally spoken of as "softening of the brain," a term diametrically opposed to its pathological anatomy. The condition is essentially a chronic diffuse subinflammatory overgrowth of the connective tissue of the cerebral hemispheres, leading to destruction of the true nerve elements, and principally affecting that region of the brain in which recent observers have localized the cortical motor centres. General paralysis is said to be a disease of middle life; this is to a certain extent true, for, in the large majority of cases, its incidence



occurs between the ages of thirty-five and fifty; it is, however, met with prior to the first-mentioned age, less frequently after the latter period of life. Statistics show that the decade between forty and fifty is the one during which the disease is most likely to occur. Men are more subject to it than women, in the proportion of, at least, eight to one; in women the symptoms are less strongly pronounced, and the disease runs its course more slowly. Although the relative frequency of the disease appears to be equal in the higher and lower classes of society, statistics show that the town artisan is more liable to it than the agricultural labourer. In the lower grades of society general paralysis is much more common in England than in Scotland or Ireland; in certain English asylums general paralytics constitute from a sixth to an eighth of the inmates, whilst in Scotch and Irish district asylums the proportion does not amount to more than 2 or 3 per cent.

The progressive character of the disease is marked by three stages, termed the prodromal, the acute, and the terminative. The *prodromal stage* is marked by a somewhat incongruous congeries of mental symptoms, consisting of total change in the habits and disposition, general restlessness and irritability, impairment of memory, extravagance in thought and action, and a peculiar facility closely followed by, or intercurrent with, the bodily symptoms of impaired mobility of the face and tongue. For the purposes of diagnosis the physical are more important than the mental phenomena. As a rule the *bouleversement* of disposition is peculiarly well marked; the impairment of memory consists, not only in the blurring and confusion of past events, but in the forgetting of the occurrence of one minute in the next,—purposes formed and intentions expressed are forgotten almost as soon as formed and expressed. This want of fixity is also shown by the non-recognition of the lapse of time, and by the manner in which violent passion is suddenly changed into amiability. To the same cause may probably be traced the peculiar facility of disposition of the general paralytic; even at this early stage there are indications of the optimism which, as the case progresses, affords the characteristic psychological symptom. In the prodromal period it is manifested by a degree of morbid vanity, general exaltation, and a tendency to regard all things in the brightest possible light. The physical symptoms consist in a finely fibrillar action of the muscles of the tongue, twitching of the upper lip, hesitancy of speech, and a loss of facial expression; the tongue symptom consists of a rapid agitation of its surface, the voluntary movements of the whole organ not being entirely under control, *e.g.*, it is protruded with a jerk; the upper lip hangs and trembles before utterance like that of one struggling against weeping; the hesitancy of speech can best be illustrated by saying that it is identical with the slurring of words in the first stage of intoxication,—the patient “speaks thick;” the face assumes a mask-like want of expression—the muscular power being impaired to such a degree as to cause change of expression to be a comparatively slow process. As the disease advances there is greater excitability, and the general exaltation of ideas becomes so great as to lead the patient to the commission of insanely extravagant actions, such as purchases of large numbers of useless articles, or of lands and houses far beyond his means, numerous indiscriminate proposals of marriage, the suggestion of utterly absurd commercial schemes, or attempts at feats utterly beyond his physical powers. Not unfrequently he is found committing theftuous acts. The *acute period* is frequently ushered in by maniacal symptoms which generally assume the type of what is termed by French writers *délire ambitieux*. Delusion of the wildest character may now present itself; the patient may believe himself to be in possession of millions

of money, to be unsurpassed in strength and agility, to be a great and overruling genius, and the recipient of the highest honours. Every idea is expanded and exalted, whether it relates to time, space, or personal attributes. Although grandiose and extravagant delusion is very frequent, existing as it does in about one-half of all cases, it is by no means such a persistent symptom as the *bien être*, which condition is the diagnostic of the disease in that it is invariably present. This is shown by perfect contentment with himself and all things around him, by the constant use of superlatives and such expressions as “all right,” “splendid,” “first rate”; he speaks of his health as robust, “never better in my life,” even when there is grave constitutional disturbance; he is unaffected by the death of child, or wife, or nearest friend. He is utterly unsuspecting, lost to all appreciation of social relations, and facile in the extreme. Synchronously with this condition, the physical symptoms become exacerbated; the tongue and facial symptoms already spoken of increase in intensity, and in addition impairments of the motor powers of the extremities present themselves, consisting in a loss of co-ordinating power, not in a loss of muscular strength. Thus the gait becomes straddled and uncertain; there is a widening of the basis of support; he has to pick his steps as he goes up and down stairs, and is apt to trip over small obstacles; the action of walking resembles that of a half-drunk man. Later on the arms become involved. The pupils are often irregular. The third or *terminative stage* is marked by “epileptiform” or more properly apoplectiform attacks, the general condition becoming more and more degraded. By this time the patient is almost bedridden; actual palsy often occurs. Towards the end certain of the semivoluntary muscles are affected; bed-sores may form; and he may die slowly of exhaustion or suddenly during an apoplectiform attack. General paralysis runs its course in from one to four years; more rapid and more protracted cases are on record, but, taken over all, eighteen months may be stated as its average duration. The disease is incurable.

II. TRAUMATIC INSANITY.—Generally speaking, insanity is not developed for some months or even years after receipt of the injury, but in the interval the patient suffers from headache, more especially after mental effort, irascibility of temper, confusion of thought, and consequent inaptitude for business, weakened memory, and a constant feeling of fatigue. If this condition is not overcome, a progressive dementia sets in, of which the special character is violence of temper, and a tendency to impulsive action. This dementia is generally complicated with maniacal attacks intervening at uncertain periods and marked by furor or violence. Dipsomania or insane drinking is a not very uncommon result, apart from all other indications of aberration. Prognosis is unfavourable.

III. INSANITY ASSOCIATED WITH OTHER NEUROSES.—*Epileptic Insanity*.—In the intervals between the fits the patient is generally stupid and dull of apprehension. Immediately before or after fits, or, as some believe, occasionally taking their place, mania of a violent and furious, or a subacute, or of an ecstatic character presents itself. All authorities recognize epileptic insanity as the form most dangerous to the public. Prognosis is unfavourable. *Hysterical Insanity*.—The symptoms described in the article HYSTERIA may become so exacerbated as to amount to insanity. Superadded to these may be delusions of a sexual nature. The most extreme form of mental disturbance supervening on hysteria is acute mania of a very violent character; it is generally of a delirious nature, but does not usually continue for any great length of time. It is open to question whether the “fasting girls” and women with “stigmata” should not be included among the

hysterically insane. Men, although very rarely, are liable to this form of insanity. In a sense the prognosis is favourable, inasmuch as prolonged treatment procures great abatement of symptoms, if not actual recovery. *Insanity occurring with locomotor ataxy* strongly resembles general paralysis. Taken over all, it may be stated that the symptoms differ more in degree than in kind, not being so intense. There is not the same extravagance of delusion or violence of mania.

IV. INSANITY FROM THE PRESENCE OF ADVENTITIOUS PRODUCTS is marked by progressive dementia of a dull heavy character and the absence of delusion. Prognosis is unfavourable.

V. INSANITIES ASSOCIATED WITH MORBID CONDITIONS OF THE GENERAL SYSTEM.—*Phthisical insanity* is stated to be characterized by a short period of mania, melancholia, or delusion, which soon passes into a mixture of subacute mania and dementia. The symptom, according to Clouston, is a tendency to be suspicious. (Consult Clouston, "Tuberculosis and Insanity," *Journ. of Mental Science*, April 1863.) *Rheumatic insanity* is characterized by hallucinations of sight, touch, and taste, loss of memory, acute delirium succeeded by confusion of ideas and sluggishness of mind, accompanied by choreic movements of the limbs, deadening of reflex action, and even paralysis. These symptoms appear as the articular affection diminishes or disappears; they are, as it were, one vicarious of the other. Prognosis is favourable. (See Griesinger *On Mental Diseases*, p. 189; Clouston, *Journ. of Mental Science*, July 1870; Sibson, in Reynold's *System of Medicine*, vol. iv. p. 286.) In *gouty insanity* the alternation of the joint and head symptoms is also well marked. The latter are general mania with delusions of suspicion. Prognosis favourable. (Vide Bertier, *Annales Médico-Psychologiques*, 1869. Sydenham also alludes to the condition.) *Syphilitic insanity* frequently commences with acutely maniacal symptoms, shortly followed by hypochondriasis of marked character, paralysis of energy, and rapid progressive dementia. Extravagant delusions often present themselves so strongly as to render the diagnosis between this condition and general paralysis difficult. Prognosis unfavourable. (The most important paper on this form of insanity is by Mickel, *Brit. and For. Médico-Chirurgical Review*, July and August 1876.) In *aneuric insanity*, however produced, the general train of symptoms is violent mania of short continuance followed by melancholic dementia. Prognosis favourable.

VI. INSANITIES OCCURRING AT EVOLUTIONAL PERIODS OF LIFE.—*Insanity of pubescence and adolescence* is manifested by various trains of symptoms. Acute mania is on the whole the most common: it is characterized by motor restlessness; the patient walks, talks, smokes, drinks, must ever be on the move. Where self-abuse comes in as a factor, the sufferer is melancholic and suspicious, self-accusing. Dipsomania is a not unfrequent symptom. But whatever may be the general symptoms of these three sets of patients, they have one common symptom, a perversion or increase of the sexual instinct. Prognosis is favourable as regards the attack present, unfavourable as to the probability of recurrence. *Climacteric insanity*, which is nearly as common in men as in women, is marked by pretty constant symptoms of a melancholic character. Prognosis generally favourable. *Senile insanity* is symptomatized by dementia with frequent intercurrent attacks of mania. Prognosis unfavourable. The most frequent symptoms of the *insanity of pregnancy* are melancholy and moral perversion, the latter taking the form of dipsomania. *Puerperal insanity* shows itself during the first seventeen days after labour, and is of sudden incidence; the mental symptom is acute delirious mania. Prognosis is favourable in this, as in the

insanity of pregnancy. (Vide J. Batty Tuke, "On Puerperal Insanity," *Edin. Med. Journ.*, May 1865 and June 1867.)

VII. TOXIC INSANITY.—*Insanity of alcoholism* in the acute form may be marked by acute mania of a transient nature, *mania a potu*; by melancholia, frequently accompanied by delusions and hallucinations of a frightful character; in the chronic, by a type of dementia frequently simulating general paralysis. Prognosis of the acute form favourable, in the chronic the reverse.

In employing the above classification it must be clearly borne in mind that the term of the symptom should, whenever possible, be appended to the pathogenetic term; thus, puerperal mania, climacteric melancholia, senile dementia, acute idiopathic mania, epileptic mania, &c. If the terms are combined, the nature of the disease and its general psychological characteristics are expressed in terse language.

It will be noted that no separate notice has been taken of such popular terms as homicidal or suicidal insanity. They in no wise indicate a class of the insane; they are symptoms common to many insanities, especially to epileptic, traumatic, puerperal, and idiopathic insanity, and as such must be regarded as incidents in a given case.

#### Terminations of Acquired Insanity.

Insanity terminates in recovery, in death, or in chronic mania or chronic dementia. Accurate statistics of the two first-named terminations are unattainable, as a large number of patients are treated at home; and asylum statistics do not therefore show the result overhead, only that of the more aggravated cases. The result of treatment in lunatic hospitals gives about 40 per cent., calculated on the admissions, which, however, include idiocy, chronic terminative insanity, and such acknowledged incurable forms of the disease as general paralysis. This figure does not of course represent the results of treatment of all the insanities, which, although there are no figures at command to support the assertion, may be fairly estimated at not less than 70 per cent., excluding idiocy. There is a general tendency of all insanities to shorten life; as already noted, some are in themselves fatal, or render their subjects less able to withstand disease. Asylum statistics show from 7 to 8 per cent. per annum as the average mortality calculated on the numbers resident.

It is needless to attempt a description of the various phases of chronic terminative dementia and mania. Delusion may continue, or the patient may become more or less sottish and degraded in habits; or, on the other hand, he may retain a considerable amount of mental power, still not sufficient to render him a responsible member of society. The great mass of the inmates of asylums belong to this class of lunatics, mostly harmless, yet precluded from mixing with the world as much for the convenience and safety of society as for their own benefit. A small proportion are detained on account of their liability to suffer from recurrence of attacks of insanity, although they are not actually insane during the intervals. To this condition foreign authorities have applied the term *folie circulaire*, and some have asserted that it is the characteristic of certain cases *ab initio*. It is mostly confined to persons strongly hereditarily predisposed. The term explains itself: after intervals of comparative sanity, the patient manifests symptoms which run their course through the prodromal, the acute, and the demented stages, on again to recovery, in manner similar to a recent case.

#### Treatment.

In speaking of the treatment of the insanities, it will simplify matters to eliminate, in the first place, those forms



of the disease which are not amenable to remedial agents in the present state of medical knowledge. Medicine, whether hygienic or therapeutic, cannot touch general paralysis, the insanity produced by adventitious products, or senile insanity, except in the reduction of intensity of symptoms. Traumatic insanity is for the most part hopeless; it is probable that sufficient attention has not been directed to surgical measures in such cases.

In the insanities due to morbid conditions of the general system, in those associated with other neuroses, and in toxic insanity, the physician attacks the head symptoms through treatment of the causating factor. It is true that in these forms symptoms have to be attacked directly, but ultimate cure is to be looked for through treatment of the diathetic condition. It is rare, and then only in the earlier stages of the initial symptoms, that the progress of these diseases is cut short by therapeutic measures, inasmuch as they seldom come under the cognizance of the physician at that period. The exception to this statement is to be found in the case of puerperal insanity, where the patient is very generally under immediate medical supervision; in her case, therefore, the prodromal indications are often observed, and the disease arrested by the timely administration of drugs. But in the great mass of cases the last idea which occurs to the minds of friends is the possibility of impending insanity, and it is not till the disease has considerably advanced that the fact is recognized and the physician called in. When he has the opportunity of applying his art during the initial stages, he directs his attention to the procuring of sleep by means of opium and other narcotics, the bromides of potash and ammonium and chloral hydrate, and by rectifying the disorders of the digestive system. But when the disease has reached the congestive stage the treatment becomes for the most part expectant, as it does in analogous complaints of other systems. "Change of scene" is often adopted, and properly so in the very earliest stages; but when the disease is confirmed it is much more apt to aggravate the condition, fatigue and excitement only fanning the flame; it is much the same as if a man with a congested lung were asked to walk a mile uphill, in the hope that he would breathe more freely at the top. Till within the last few years treatment by bleeding, cupping, and blistering, shaving the head, and cold applications, was much in vogue. In asylums of the present day a shaved head is never seen. It was likewise the custom to administer large doses of sedatives. The system of treatment which now generally obtains is almost purely hygienic. Opiates are much less used, and are to be deprecated in those forms characterized by excitement; in idiopathic and climacteric melancholia, however, they often produce good results. General constitutional treatment is what is usually adopted. In such forms as idiopathic mania and melancholia, the mania of adolescence, puerperal mania, and climacteric melancholia, the disease, like many others, runs its course, not very materially affected by remedial agents apart from those applied to the maintenance of the system, and its cure is similarly dependent on rest and nursing. And the main question concerning treatment is, Where are these best to be obtained? In the case of the poor there is no alternative, even in comparatively mild cases, but to send the patient to an asylum. In the case of the rich it resolves itself very much into a question of convenience, for, with plenty of money at command, the physician can convert any house into an asylum. But under ordinary circumstances, when the patient is violent, noisy, suicidal, homicidal, or offensive to society, it becomes necessary to seclude him, both for the purposes of cure and for the safety and comfort of the family. Except amongst the very affluent, treatment at home is for the most part unsatisfactory; it is very generally tried, but breaks down

under the constant strain to which the friends are subjected. In a well-ordered hospital for the insane there is every possible appliance for treatment, with trained nurses who are under constant supervision; and it therefore affords the best chance of recovery.

*History.*—The history of the treatment of insanity has been stated to be divisible into three epochs—the barbaric, the humane, and the remedial. But this does not take into account the very highly humane and probably highly remedial system of treatment which obtained in very ancient times. In Egypt the temples of Saturn, and in Greece the Asclepia, were resorted to by lunatics, and the treatment there adopted was identical in principle with that of the present day. The directions given by all the classical medical authors, and especially Hippocrates and Galen, are of the soundest character. How long their influence existed it is difficult to say, but in the Middle Ages, and up to the middle of the last century, little attention was paid to the care or cure of the insane. A small proportion were received into monastic hospitals or immured in common jails. In 1537 a house in Bishopsgate Street, London, fell into the possession of the corporation, and was appropriated for the reception of fifty lunatics. This, the first Bethlehem Hospital or Bedlam, was removed in 1675 to Moorfields, and in 1814 the present hospital in St George's Fields was erected. St Luke's was instituted in 1751. Bedlams or houses of detention for lunatics appear to have existed in other cities, but, with these exceptions, no provision was made for the insane, who were allowed to wander at large. There is good reason for believing that many were executed as criminals or witches. About 1750 the condition of the insane attracted some amount of public attention, and the incarceration in madhouses of a considerably larger number than formerly followed, not on account of any philanthropic sympathy with their condition, but as a measure demanded for the public safety and comfort. But this measure by no means brought about the termination of the barbaric period. The houses, misnamed asylums, were in the hands of private parties, under little or no supervision, and were in fact merely prisons of the very worst description. The unhappy inmates were immured in cells, chained to the walls, flogged, starved, and not unfrequently killed. It is almost impossible to believe that this condition of matters existed far on into the present century. According to Conolly, "there is clear proof of the continued existence of the abuses in 1827; and it cannot be denied that not a few of them survived in some public and private asylums in 1850." Matters were no better in France when Pinel was appointed in 1792 to the charge of the Bicêtre, the great hospital of Paris for male lunatics. In that establishment, and in the Salpêtrière, the condition of the inmates was as degraded as in the British madhouses. This great philanthropist adopted the bold step of striking off the chains and other engines of restraint from those under his care. About the same time, the most gross abuses having been brought to light in connexion with the management of the city of York asylum, William Tuke, a member of the Society of Friends, was mainly active in instituting the York Retreat for the care and cure of insane members of that sect. This real asylum was conducted on non-restraint principles. The names of Pinel and Tuke are indissolubly connected with the history of the humane treatment of the insane, and to their efforts must be ascribed the awakening not only of the public but of the medical profession to the true principles of management. It took, however, many years before the principles laid down by these men were universally adopted. In 1815 a committee of the House of Commons brought to light many gross abuses in Bethlehem Hospital, and it was not till 1836 that mechanical restraint

was entirely abolished in an English public asylum. This took place at Lincoln, where Dr Gardiner Hill did away with all engines of restraint. Shortly afterwards Conolly adopted the same line of treatment at Hanwell, near London, and through the influence of his example and precept the measure extended over the whole of Great Britain. Experience has shown that, as restraint of all forms is abandoned, the management of lunatics becomes easier. Walled-in airing-courts, barred windows, and strong dark rooms have almost entirely disappeared, and in some Scotch asylums it is found practicable to discontinue the use of lock and key. It has been said that the type of insanity has changed within the last forty years; it would be more true to say that the type of treatment has changed. It is much less common nowadays to meet with those extremely violent forms of madness which entered into the descriptions of many authors. With the reduction of restraint a higher order of supervision on the part of attendants is demanded, and as they are trained to rely more and more on the moral influence they can exercise over their charges, and less on mechanical apparatus, the patient is not so apt to resent control, and therefore a greater calm and contentment pervades the atmosphere of our asylum wards. This has been mistaken for a change in the type of the disease.

*Statistics.*—The statistics of lunacy are merely of interest from a sociological point of view; for under that term are comprised all forms of insanity. It is needless to produce tables illustrative of the relative numbers of lunatics in the various countries of Europe, the systems of registration being so unequal in their working as to afford no trustworthy basis of comparison. Even in Great Britain, where the systems are more perfect than in any other country, the tables published in the Blue Books of the three countries can only be regarded as approximately correct, the difficulty of registering all cases of lunacy being insuperable.

On the 1st January 1850, according to the returns made to the offices of the Commissioners in Lunacy, the numbers of lunatics stood thus on the registers:—

	Males.	Females.	Total.
England and Wales .....	32,164	39,027	71,191
Scotland .....	4,541	5,083	9,624
Ireland .....	6,359	6,460	12,819
Grand total .....	43,064	50,570	93,634

These figures show the ratio of lunatics to 100,000 of the population to be 279 in England and Wales, 217 in Scotland, and 236 in Ireland.

The next table is of interest as bearing on the question of the alleged increase of lunacy as a disease. Similar returns are not available for Ireland.

*Numbers of Lunatics on the 1st January of the Years 1858–80, inclusive, according to Returns made to the Offices of the Commissioners in Lunacy for England and Wales and Scotland.*

	England and Wales.	Scotland.		England and Wales.	Scotland.
1858	...	5,823	1870	51,713	7,571
1859	36,762	6,072	1871	56,755	7,729
1860	38,058	6,273	1872	53,640	7,849
1861	39,647	6,327	1873	69,296	7,932
1862	41,129	6,398	1874	62,027	8,069
1863	43,118	6,386	1875	63,793	8,225
1864	44,795	6,422	1876	64,916	8,509
1865	45,950	6,533	1877	66,636	8,862
1866	47,648	6,710	1878	68,538	9,097
1867	49,036	6,860	1879	69,855	9,386
1868	51,000	7,055	1880	71,191	9,624
1869	52,177	7,310			

There is thus an increased ratio in England and Wales of lunatics to the population (which in 1859 was 19,686,701, and in 1880 was estimated at 25,480,000) of 186.7 per 100,000 as against 279.4, and in Scotland of 157 as against 217 per 100,000. The publication of these figures has naturally given rise to the question whether lunacy has actually become more prevalent during the last twenty years, whether there is real increase of the disease. There is a pretty

general consent of all authorities that if there has been an increase it is but very slight, and that the apparent increase is due, first to the improved systems of registration instituted by the boards of lunacy, which have brought under their cognizance a mass of cases which were formerly neglected, "who would not have been dealt with as paupers in 1855, but who are now dealt with as such, so as to obtain for them the advantage of accommodation in pauper asylums." Secondly, a further and far more powerful reason is to be found in the increasing tendency among all classes, and especially among the poorer class, to recognize the less pronounced forms of mental disorder as being of the nature of insanity, and requiring to be dealt with as such. Thirdly, the grant of four shillings per week which in 1876 was made by parliament from imperial sources for the maintenance of pauper lunatics has induced parochial authorities to regard as lunatics a large number of weak-minded paupers, and to force them into asylums in order to obtain the benefit of the grant and to relieve the rates. These views receive support from the fact that the increase of private patients, *i.e.*, patients who are provided for out of their own funds or those of the family, has advanced in a vastly smaller ratio. In their case the increase, small as it is, can be accounted for by the growing disinclination on the part of the community to tolerate irregularities of conduct due to mental disease, and the consequent relegation of its victims to asylums for the sake of family convenience. And again, careful inquiry has failed to show a proportional increase of admissions into asylums of such well-marked forms as general paralysis, puerperal mania, &c. The main cause of the registered increase of lunatics is thus to be sought for in improved registration, and parochial and family convenience. If there is an actual increase, and there is reason for believing that there is a slight actual increase, it is due to the tendency of the population to gravitate towards towns and cities, where the conditions of health are inferior to those of rural life, and where there is therefore a greater disposition to disease of all kinds.

*Bibliography.*—The following are systematic works:—Bucknill and Tuke, *Psychological Medicine*, 4th edition, 1879; Blandford, *Insanity and its Treatment*, 1877; Griesinger, *On Mental Diseases*, New Sydenham Society, 1867; Maudsley, *The Pathology of Mind*, 1879. Conolly, *On the Treatment of the Insane*, 1856, bears chiefly on asylum management. Every question connected with lunacy will be found discussed in the *Journal of Mental Science*, to the first twenty-four volumes of which a general index has been prepared by Dr Fielding Blandford, 1879. The works of Pinel and Esquirol are well worthy of attention. Consult also Krafft-Ebing, *Lehrbuch der Psychiatrie*, Stuttgart, 1879, and Dr Heinrich Schüle, *Handbuch der Geisteskrankheiten*, the latter being the sixteenth volume of Von Ziemssen's *Handbuch der speciellen Pathologie und Therapie*, Leipsic, 1878. (J. B. T.)

LAW.

The effect of insanity upon responsibility and civil capacity has been recognized at an early period in every system of law. In the Roman jurisprudence its consequences were very fully developed, and the provisions and terminology of that system have largely affected the subsequent legal treatment of the subject. Its leading principles were simple and well marked. The insane person having no intelligent will, and being thus incapable of consent or voluntary action, could acquire no right and incur no responsibility by his own acts; his person and property were placed under inquiry by the magistrate under the control of a *curator*. The different terms by which the insane were known, such as *demens*, *furiosus*, *fatuus*, although no doubt signifying different types of insanity, did not infer any difference of legal treatment. They were popular names which were used somewhat indifferently, but which all denoted the complete deprivation of reason. During the Middle Ages the insane were but little protected or regarded by law. Their legal acts were annulled, and their property placed under control, but little or no attempt was made to supervise their personal treatment. In England the wardship of idiots and lunatics, which was annexed before the reign of Edward II. to the king's prerogative, had regard chiefly to the control of their lands and estates, and was only gradually elaborated into the systematic control of their person and property now exercised in chancery. Those whose means were insignificant were left to the care of their relations or to charity. In criminal law the plea of insanity was unavailing except



in extreme cases. About the beginning of this century a very considerable change commenced. The public attention was very strongly attracted to the miserable condition of the insane who were incarcerated in asylums without any efficient check or inspection; and at the same time the medical knowledge of insanity entered on a new phase. The possibility and advantages of a better treatment of insanity were illustrated by eminent physicians both in France and England; its physical origin became generally accepted; its mental phenomena were more carefully observed, and its relation was established to other mental conditions which had not hitherto been regarded as insane in the proper sense of the word. From this period we date the commencement of legislation such as that known in England as the Lunacy Acts, which aimed at the regulation and control of all constraint applied to the insane. And at the same time we find the commencement of a new state of matters in the courts. Hitherto, the criteria of insanity had been very rude, and the evidence was generally of a loose and popular character; but, whenever it was fully recognized that insanity was a disease with which physicians who had studied the subject were peculiarly conversant, expert evidence obtained increased importance, and from this time became prominent in every case. The newer medical views of insanity were thus brought into contact with the old narrow conception of the law courts, and a controversy arose in the field of criminal law which in England, at least, is not yet settled.

The fact of insanity may operate in law—(1) by excluding responsibility for crime; (2) by invalidating legal acts; (3) by affording ground for depriving the insane person by a legal process of the control of his person and property; or (4) by affording ground for putting him under restraint.

1. Responsibility for crime may be destroyed by insanity. The theory of the limitations under which this plea is recognized by English law is first clearly stated by Hale (*Pleas of the Crown*, i. c. 2) in these terms: "When there is no will to commit an offence there can be no transgression, and, because the choice of the will presupposes an act of the understanding, it follows that when there is a total defect of the understanding there is no free act of the will in the choice of things or actions." This doctrine was closely followed by the courts, and in the subsequent cases we find nothing admitted in defence short of a total defect of the understanding. In later times, however, frequent attempts were made on the part of the defence to break through this stringent rule, and in 1843 the case of *Macnaughton*, which resulted in an acquittal, attracted so much public attention, and seemed to cast so much doubt on the law as previously understood, that a series of questions were put by the House of Lords to the judges with the view of determining conclusively how the law really stood. These answers practically affirmed the old law. They decided that, in order to establish a defence on the ground of insanity, "it must be clearly proved that at the time of the committing of the act the party accused was labouring under such a defect of reason from disease of the mind as not to know the nature and quality of the act he was doing, or if he did know it he did not know that he was doing wrong." These answers are now the ruling authority both in England and Scotland, although there have been undoubtedly many instances in which the defence of insanity has been sustained either through the judge abstaining from pressing the law very strictly or from the jury taking a wider view of the case. Frequently, also, a more lenient view has practically been given effect to by the intervention of the home secretary, many of the most puzzling cases having been disposed of in this way. When the prisoner is unable to plead or has been acquitted on the ground of insanity, the jury are obliged to state whether they find the prisoner

to be insane, and in that case he is ordered to be detained during her majesty's pleasure; and the home secretary has power to order him to be detained at such place as he may direct. Prisoners who become insane while in prison upon any form of legal process may also be removed by warrant of the home secretary to whatever asylum he thinks fit. All these are known technically as criminal lunatics, and an asylum has been provided for their detention at Broadmoor, from which they can only be discharged by warrant of the home secretary. (39 & 40 Geo. III. c. 94; 3 & 4 Vict. c. 54; 23 & 24 Vict. c. 65; 27 & 28 Vict. c. 29; 30 & 31 Vict. c. 12.)

The law thus clearly laid down by the courts has been strongly condemned by most medical authorities, who maintain that it is founded upon an ignorant and imperfect view of insanity. There can be no doubt that insanity does not wholly or even chiefly affect the will through the intellectual faculties. The disturbance of emotion and feeling is at least of equal consequence. We have cases where a criminal act seems to spring entirely from this source, and very many others where we have a complex of morbid intelligence and feeling which it is impossible to disentangle. In cases like those it is impossible by any analysis to separate the intellectual from the emotional phenomena, and to assess the amount of intelligence which, although morbid or defective, ought to be sufficient to restrain the equally morbid emotional condition. It seems clear that in judging of responsibility we ought to take the mental condition of the insane as a whole; and the present view of the law seems to have originated partly from ignorance of the more obscure phenomena of insanity, and partly from the metaphysical conception of a will whose freedom is only limited by its intelligence. It must, however, be remembered, on the other hand, that the courts have had serious difficulties to encounter. The views of insanity and consequent irresponsibility presented to them in medical evidence were often so vague that they seemed capable of indefinite extension, and there is no subject on which the experts have appeared so much at variance with each other. But these difficulties, however much they may call for the watchfulness of the courts, seem no sufficient ground for limiting the effect of insanity in relation to responsibility to the intellectual faculties. Such a limitation seems opposed, not merely to our present knowledge of insanity, but to the experience of ordinary psychology. These controversies are not confined to England. In the United States the law may generally be said to be the same as that of England, but, as the judges have been by no means so tightly bound down as the English judges have been by the opinions in *Macnaughton's* case, a considerable tendency has been shown in many (or indeed most) States to take a more liberal view of the question. In France the provision of the Code Napoléon, "il n'y a ni crime ni délit lorsque le prévenu était en état de démence," depends for its effect upon the interpretation given to the word *démence*, and for some time the tribunals were inclined to interpret it in such a manner as to make the law very much the same as that of England; but the view of the physicians is now generally prevalent. In Germany the matter is dealt with in a section (§51, *R. G. B.*) of the criminal code, which was the result of very careful discussion both by physicians and lawyers. It runs thus: "There is no criminal act when the actor at the time of the offence is in a state of unconsciousness or morbid disturbance of the mind, through which the free determination of his will is excluded."

2. In the case of all civil acts, the general rule is that capacity must be measured in relation to the act. The mere fact of insanity will not in itself make void a will, for example, if it appears that the testator had a fairly clear

conception of the nature of his property and the objects of his bounty. But it is needless to say that the least appearance of insanity in the deed itself, or any appearance of fraud or undue persuasion on the part of any one, is immediately fatal to the deed. In the case of contracts an additional element is knowledge of the insanity by the other party. When the contract was entered into *bona fide*, and the insanity of the one party was not known to the other, the contract may not be set aside unless the parties can be exactly restored to their previous condition.

3. Both the property and person of the insane may be placed under control by a legal process. In England this right was early annexed to the prerogative of the crown, and is even yet in consequence not exercised by the ordinary courts, but by the lord chancellor and such other judges as may be entrusted with it by the sign manual. The procedure is now governed by the Lunacy Regulation Acts (16 & 17 Vict. c. 70; 18 Vict. c. 13; 25 & 26 Vict. c. 86). The question of insanity is tried before one of the masters in lunacy, either with or without a jury, according to circumstances. The terms of the inquiry are—whether the party is of unsound mind and incapable of managing himself and his affairs; and on this being found his person and property are placed in charge of one or more persons called committees, whose administration is subject to the masters in lunacy, and through them to the chancellor. Persons thus found insane (technically known from the old form of procedure as lunatics so found by inquisition) are under the inspection of the board of chancery visitors, consisting of two medical men and a barrister, who are appointed to visit them at intervals. They are not subject to the provisions of the Lunacy Acts.

In Scotland the old procedure is by a brieve or writ from chancery, formerly tried before the judge ordinary and now before the lord president of the court of session. The nearest male agnate of twenty-five years of age is appointed tutor, but, latterly at least, is not entrusted with the personal custody, the court, if necessary, selecting some one for the purpose, generally the nearest cognate. The procedure by briefs is now becoming infrequent. More generally application is made to the court of session to appoint a *curator bonis* to take charge of the estate. This procedure is in many ways simpler and more convenient, especially in the numerous cases which are unopposed, as the court when they are satisfied that every person concerned has had due notice will grant the application on the certificate of two medical men. In America and on the Continent similar forms of procedure exist, which cannot be gone into in detail. In the United States the law is mostly, as is natural, derived from the English sources, but the procedure is regulated by statute in the different States. In many other countries, where the common law is based on Roman jurisprudence, the procedure seems to differ in many points from the English forms, but in substance the law on the subject has in nearly all countries reached very much the same results.

4. Insane persons (although not lunatics so found by inquisition) may be placed under personal restraint. At common law this power is limited to cases where the insane person is dangerous to himself or others, but in practice it used frequently to be exercised with little discretion and often with great barbarity. The care and restraint of the insane (other than that exercised by their friends and relatives in their own homes) is now strictly controlled by the Lunacy Acts (8 & 9 Vict. c. 100; 16 & 17 Vict. c. 96; 16 & 17 Vict. c. 97; 25 & 26 Vict. c. 111), the general nature of whose provisions may be thus briefly described. The chief supervision of the insane is vested in a body called the Commissioners of Lunacy. No insane person can be received for profit, or detained in any house or

asylum except upon an order by a person who becomes responsible for his detention, accompanied by certificates of two qualified medical practitioners that he is insane, and a proper person to be taken charge of and detained under care and treatment. Every such case must at once be reported to the commissioners, who must also be informed of the patient's death, discharge, change of residence, and similar circumstances. Not more than one insane person can be received into a house unless a licence has been previously obtained. In the metropolitan districts such licences are granted after due examination by the commissioners, and in the provinces by the justices of peace in quarter sessions. Every house thus licensed, together with public hospitals and asylums (which are not under licence), and every patient under private treatment, are subjected to a more or less frequent inspection by the commissioners, as well as by visitors appointed in their respective districts by the quarter sessions. The private licensed houses are under especially frequent inspection; their regulations and arrangements are subject to the approval of the commissioners, and especial precautions are taken that the patients shall have full opportunity of having their cases examined and of communicating with the commissioners. Patients may be discharged as cured, or on the direction of the person who ordered their detention, or on the order of the commissioners, all these modes of discharge, however, being guarded by various conditions. The order for detention of a lunatic may be given by any person having an interest in him, and he is liable in damages if there prove to have been no sufficient ground for the order, his position differing in this respect from that of the physicians and keeper of the asylum, who are only liable in the event of negligence or mala fides.

In Scotland the equivalent Acts are 20 & 21 Vict. c. 71, 25 & 26 Vict. c. 54, and 29 & 30 Vict. c. 51. The system is in its main features the same as that of England, the leading differences being that the Commissioners of Lunacy are the only licensing body, and that an order granted on application by the sheriff takes the place of the order by a private person.

The regulations applicable to pauper lunatics differ in some respects from the ordinary case. The provisions applicable to them are for the most part to be found in 16 & 17 Vict. c. 97, and in 20 & 21 Vict. c. 71.

The nature of the evidence, and the manner in which it is to be presented to the court, is an important question in every department of the legal treatment of insanity. In England the courts, although giving increasing prominence to expert evidence, have gone a good deal on the theory that the medical evidence is merely a part of the general evidence in the case. In most Continental countries, on the other hand, the whole evidence is presented in the shape of reports by medical men (in most instances officials) who have previously examined the case; and in this way every piece of evidence as to the state of mind of the insane person is commented on by an expert who is presumably better acquainted with its true import than an ordinary court or jury.

*Literature.*—The most recent book on the general law and procedure in insanity is *A Treatise on the Law and Practice of Lunacy*, by H. M. R. Pope (London, 1877); Archibald's *Statutes relating to Lunacy* (2d ed., London, 1877) contains the statutory law on all branches; Bertrand, *Loi sur les Aliénés* (Paris, 1872), presents a comparative view of English and foreign legislations: In forensic medicine the works of Taylor (*Medical Jurisprudence*, 2d ed., London, 1873) and of Wharton and Stillé (*A Treatise on Medical Jurisprudence*, Philadelphia, 1873) are probably the English authorities in most common use. See also Casper and Liman, *Practisches Handbuch der Gerichtlichen Medicin*, Berlin, 6th ed., 1 76; Tardieu, *Étude médico-légale sur la Folie*, Paris, 1872; Legrand du Sautle, *La Folie devant les Tribunaux*, Paris, 1864; and especially Krafft-Ebing, *Lehrbuch der gerichtlichen Psychopathologie*, Stuttgart, 1875. (A. G.)



INSCRIPTIONS<sup>1</sup>

## I. CUNEIFORM.

**Plate I** INSCRIPTIONS in characters sometimes termed cuneiform or wedge-shaped, sometimes arrow-headed, have been found throughout a large part of western Asia,—in Persia and Babylonia, Assyria and Media, Armenia and Mesopotamia. The names given to the characters are derived from their form, as some of them resemble the points of arrows, though most have the appearance of wedges, thicker at one end than at the other. This appearance is due to the fact that the characters were originally impressed upon moist clay by a metal stylus, and the form consequently assumed by them was subsequently imitated by the engraver upon stone and metal. The characters were primarily pictorial, but in course of time the outlines of the primitive pictures came to be alone preserved, while the nature of the writing materials caused curves to become angles, and rounded lines straight ones.

*Varieties of Cuneiform Writing.*—The original home of the cuneiform system of writing was either Elam or Babylonia, the inventors of the hieroglyphics in which it originated being the ancient Accadian population of Chaldea. It passed from the latter to a number of other nations, undergoing at the same time a variety of modifications. It was first borrowed by the Semitic settlers in Babylonia and Assyria, and from them it was handed on to the Turanian tribes of India, the Alarodians of ancient Armenia, and the Aryans of Persia, while the Turaoian inhabitants of Elam or Susiania preserved the system as it had been in use among the Accadians of Chaldea.

In Babylonia, Assyria, Susiania, and Media the forms of the characters underwent several changes at successive periods, the tendency in each case being to simplify the characters by dropping superfluous wedges. In Babylonia we have to distinguish between the archaic, the linear, the hieratic, and the later forms of the characters. The archaic forms are principally found on bricks and cylinders of the Accadian epoch (before 2000 B.C.), and are the oldest forms of the characters of which we have contemporary specimens. The linear forms were in use at the same time, and are marked off from the archaic forms by being written in continuous lines instead of a series of wedges, and sometimes also by a closer resemblance to the original pictures from which they were derived. The hieratic forms were mainly employed between the overthrow of the Accadian power (about 1700 B.C.) and the 8th century B.C., more especially for contracts and similar documents. The later forms may be seen on the monuments of Nebuchadnezzar and his successors, a further modification of them being used for the Babylonian transcripts of the Persian cuneiform inscriptions. In Assyria also we may classify the characters as archaic, hieratic, and later (or Ninevite), though the forms they assumed in Assyria were not identical with those used in Babylonia which we have

called by similar names. The hieratic forms were mainly employed in Assyria for ornamental or religious purposes, and may be compared with our own black letter. In Susiania the archaic forms of the characters lingered to the last, though in the northern part of the country simplified forms were in use. In Media a considerable difference may be observed between the peculiar forms of many characters in the older inscriptions of Mal-Amir and the forms borne by them in the Protomedic transcripts of the Persian monuments. The Armenian or Vandaic characters were the same as those of Assyria, except that where one line or wedge had to be drawn across another, it was broken into two. But this was to prevent the stone from breaking at the point of section.

It will be noticed that the cuneiform characters were employed to express very different languages. The Accadian, like the allied dialects of Susiania and primitive Media, was agglutinative, and probably belonged to the Ural-Altaic family of speech; Assyrian and later Babylonian were Semitic; Persian was East Aryan; while the Armenian of Van seems to claim affinity with that Alarodian group of tongues of which Georgian may be regarded as the modern representative.

*The Origin and Development of the Cuneiform System of Writing.*—As already stated, the cuneiform characters were in their origin pictorial. In many cases it is possible to restore the primitive hieroglyphics or ideographs by the help of the archaic and linear Babylonian forms, and a fragment of a clay tablet has been discovered on which the pictorial originals of a few characters are given. In order to restore the primitive pictures, it is frequently necessary to turn a character upon its side, from which we may infer that the ideographs were once written vertically like Chinese. Thus , the ideograph of "an eye," is plainly a representation of the eye in a vertical position.

The primitive pictures denoted either objects or ideas, the latter being represented metaphorically by the picture of one or more objects. "Life," for example, was expressed by the picture of a growing flower, "a month" by placing the numeral xxx. within the circle of the sun, which symbolized the day. But the same picture might denote more than one idea or object. Thus the circle of the sun represented not only "the sun" and "the day," but also "light," "brilliance," and the like; and a pair of legs represented the ideas of "going," "walking," and "running." By combining two or more ideographs together, fresh ideas might be symbolized to an almost infinite extent; "drinking," for example, is denoted by placing the three drops which denoted water within the picture of the mouth, "language" by substituting the tongue for the three drops of water, and "a tear" by setting the ideograph of water before that of the eye.

Out of this early picture-writing there soon grew a syllabary. Accadian was an agglutinative language, which was already largely affected by phonetic decay, the result being that on the one hand the same word might be used indifferently for noun, verb, and adverb, as in English, while on the other hand the loss of final sounds had reduced a great part of the vocabulary to the condition of monosyllables. Ideographs consequently came to be associated with the sounds of the words which they primarily or most usually represented, and these words were mostly monosyllabic. Thus the ideograph of "month" (*itii*) was known as *id* or *it*, that of "going" (*dun*) as *du*, that of "drinking" as *nak*, that of a "tear" as *er*.

<sup>1</sup> Description of Plate I.

1-4, Cuneiform inscriptions on clay; 5, Pisistratus inscription, on marble, from Athens (*Athenaion*, vi. p. 149); 6, 7, inscriptions from Dodona, bronze (Carapanos, *Dodone*, pl. xxvii., fig. 1, and pl. xxiii., fig. 5); 8, archaic inscription on brown sandstone, from Olympia (*Arch. Zeitung*, 1879, p. 153); 9, inscription on bronze spear-head, from Olympia (*Ibid.*, p. 149); 10, boustrophedon inscription on base at Athens (*C. I. Gr. Att.*, i. No. 463); 11, treaty between Elis and Heræa, on bronze tablet, found at Olympia in 1813, now in British Museum (*C. I. Gr.*, No. 11); 12, archaic inscription on base at Athens (*C. I. Gr. Att.*, i. No. 480); 13, Latin inscription from Pompeii (Zangemeister, *Inscript. Piet. Pomp.*, pl. xxiv., fig. 7); 14, Latin inscription (Ritschl, *Prisc. Lat. Mon. Epig.*, pl. xxxviii., fig. d); 15, Latin inscription, tessera (*Ibid.* pl. ii. fig. n).

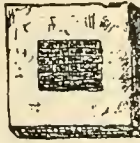
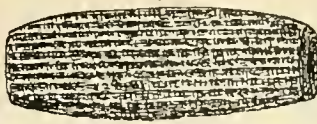

1-4 CUNEIFORM INSCRIPTIONS ON CLAY



5 ΠΙΣΤΕΡΑΤΥΣ INSCRIPTION ON MARBLE FROM ATHENS

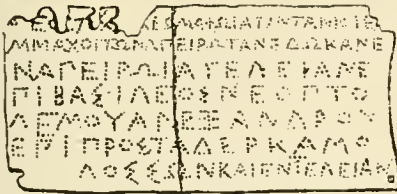

6 INSCRIPTION FROM ODONNA BRONZE



7 INSCRIPTION FROM ODONNA BRONZE

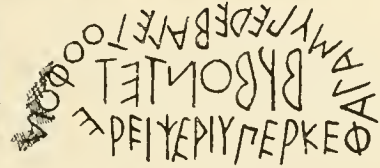

8 ARCHAEIC INSCRIPTION ON BROWN SANDSTONE FROM OLYMPIA

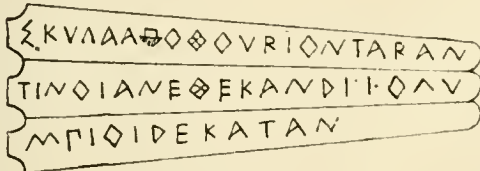

9 INSCRIPTION ON BRONZE SPEAR HEAD FROM OLYMPIA

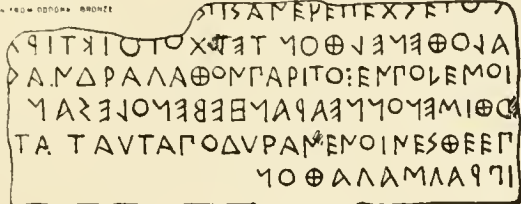

10 DIOSTROPHICUM INSCRIPTION ON BASE AT ATHENS

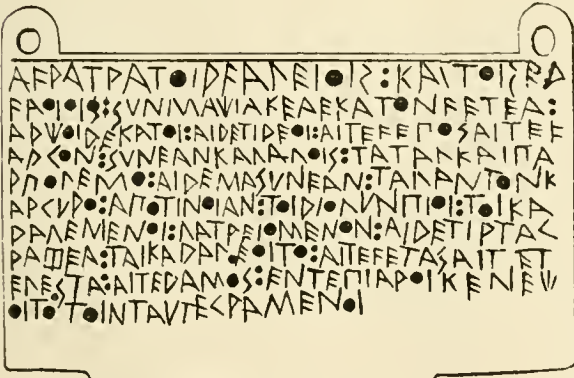

11 TREATY BETWEEN EUS AND HEREA ON BRONZE TABLE FOUND AT OLYMPIA IN B.C.



12 ARCHAEIC INSCRIPTION ON BASE AT ATHENS

C. P. V. M. I. D. I. V. S. D. I. P. L. V. S. H. E. I. G. F. V. I. T.  
A. D. V. N. O. N. A. S. O. C. T. U. B. R. E. I. S. M. L. E. P. I. D. O. S. T. X. L. C. U. S.  
C. V. K.

13 LATIN INSCRIPTION FROM POMPEII

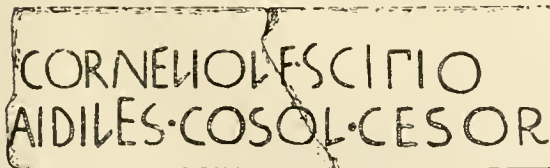

14 LATIN INSCRIPTION



15 LATIN INSCRIPTION TESSERA





But the same object or idea was frequently expressed by more than one name, while each of the ideas represented by a single sign was naturally denoted by a different word. Hence the same ideograph, or character, as we may now term it, had varying pronunciations assigned to it according to its meaning and use; the ideograph of the "sun," for instance, was called, not only *ut* or *ud* (for *utu*), but also *par* (for *para*), *tam*, *lakh*, and *khis*. Thus the ideographs, as soon as they came to appeal to the ear as well as to the eye, were necessarily polyphonous.

A further step in advance was now taken. An ideograph continued to represent the pronunciation of the word for which it originally stood even when it no longer represented the word itself; that is to say, the pronunciation of the word it denoted became attached to it as a mere phonetic value. This important innovation, which amounted to a change of the old picture-writing into a syllabary, must have taken place at an early period in its history. Though native proper names, which were always significant, could be written ideographically, it was necessary to find some other way of denoting foreign proper names, which had no meaning in Accadian. The pronouns, moreover, must have been a difficulty from the first, and the fact that these are invariably represented in Accadian, not by ideographs, but by characters used phonetically, indicates a very early date for the employment of the characters to represent syllabic sounds as well as ideas. This is borne out by the existence of several compound characters, in which the second element denotes only the pronunciation of the words for which they stand. The picture of a corpse, for example, had the phonetic value of *bat*, since *bat*, meant "corpse" and "death" in Accadian; but, as *bat* also signified "a fortress," the ideograph of "corpse" was inserted within the ideograph of "enclosure," not because there was any relationship between the ideas of "death" and "fortress," but to indicate that the character which meant an enclosure was to be interpreted as signifying "a fortress," and to be pronounced *bat*. So, too, the usual word for "going" was *du* or *du*; but there was another word *ara* or *ra* with the same meaning, and when the latter was intended to be read the fact was pointed out by attaching the character which had the phonetic value of *ra* to the ideograph which expressed the idea of "going."

While the characters could thus be used as mere phonetic symbols, some few of them could be employed, on the other hand, for the language of the eye only. These were the determinative prefixes and affixes, such as the eight-rayed star, which represented a deity, or the shaded circle, which denoted a country or place. Their original use seems to have been to mark out those groups of characters which had to be read phonetically, and not as ideographs.

Like the lexicographers of China, the lexicographers of Accad attempted to classify and arrange the characters of their syllabary. Every character received a name of its own, so that literary works could be copied from dictation. A list of primary characters was first drawn up, each of which was named from the object it originally represented. The remaining characters were regarded as compounds, and divided into two classes. The first class consisted of characters which differed from the primary ones in having extra wedges, the second class of those that were really compounds. This classification of the syllabary must have been completed at a very remote date, since the analysis of many of the compound characters can only be explained by the forms they bear in archaic Babylonian, and in some cases even the archaic Babylonian forms are not sufficiently primitive. We may gather from this some idea of the epoch to which the invention of the cuneiform system of writing reaches back.

*The Transmission of the Cuneiform Characters.*—As far

back as the second millennium B.C. Semitic tribes were in possession of a part of Chaldea. Duigi, the son and successor of the first Accadian monarch of whom we have contemporaneous record, has left us an inscription in which the cuneiform system of writing is adapted to the expression of a Semitic language. By the 17th century B.C. the Accadian language seems to have been wholly superseded by Semitic Babylonian and its northern dialect Assyrian. Along with other elements of civilization, the Semites received the cuneiform system of writing from their predecessors, and in the process of transmission the transformation of the old picture-writing into a syllabary was completed. The Accadian words represented by the characters when used as ideographs became phonetic values, and, since the same ideograph usually represented several different words, almost every character was polyphonous. It is true that some of these Accadian words, and even some of the phonetic values borne by the characters in Accadian, were rejected by the Semites, but on the other hand new phonetic values attached themselves to a few of the characters derived from the Semitic pronunciation of the latter when employed ideographically. For the Semites continued to use the characters on occasions ideographically as well as syllabically.

A greater extension was also given to the employment of determinative prefixes; the name of an individual, for instance, is always preceded by an upright wedge, the names of a country and a city by the ideographs which stand for these two ideas. The reader was assisted towards knowing when a character was used as an ideograph by the employment of phonetic complements, that is to say, characters which denoted the last syllable of the word intended to be read. Thus, when the ideograph "to conquer," is followed by the syllable *ud*, we may infer that it must be pronounced *acsud*, "I conquered," or some other person of the past tense of the same verb.

The real difficulty the cuneiform syllabary offers to the decipherer is not the polyphony of the characters, but one which would not have been felt by the Assyrians themselves. Accadian and Assyrian phonology did not always agree, and in borrowing the Accadian system of writing the Assyrians had to adapt the sounds of their own language, as best they could, to the phonetic symbols of another. Consequently no distinction in writing is made between final *b* and *p*; *g*, *c*, and *k*; and *d*, *dh*, and *t*. *Teth* is inadequately represented sometimes by *d*, sometimes by *t*; and there is but one character for *za* (𐎠) and *tsa* (𐎡). No difference could be drawn between *u* and *yu*, and *i* and *yi*, while the representative of the consonantal *ayin* has to stand also for the diphthong *ê*.

The Assyrians continued to follow the example of the Babylonians in writing on clay, but they also made use of papyrus and stone. This literature on clay is very extensive, and embraces every branch of study known at the time. For an account of it see BABYLONIA, vol. iii. p. 191.

The learned court of Assur-bani-pal in the 7th century B.C. amused itself with essays in Accadian composition, the extinct language of primitive Babylonia standing in much the same relation to the Assyrians that Latin does to us. But literary Assyrian itself was fast becoming an artificial dialect. The Aramaean alphabet was introduced into Nineveh at least as early as the 8th century B.C., and, though Nebuchadnezzar and his successors continued to employ the cuneiform syllabary, the conquest of Babylon by Cyrus was a blow from which the old mode of writing never recovered. The literary dialect and the characters in which it was inscribed were more and more disused, and finally disappeared altogether. Commercial tablets, however, dated in the reigns of the earlier Arsacid princes



have been found written in cuneiform, and if M. Oppert's identification is correct, a deed of sale, now in the Zurich museum, and written in cuneiform characters, is dated in the fifth year of Pacorus, the contemporary of Domitian.

The Assyrian syllabary was borrowed by the Armenians and Mithriates of Lake Van in the reign of a certain king named Lutipri in the 9th century B.C. The characters both in form and use are identical with those of Nineveh, except that the Armenians rejected the polyphony of the Assyrian syllabary, and with one or two exceptions used each sign with one phonetic value only.

After the occupation of Armenia by the Aryans, the use of the cuneiform character seems to have been discontinued, and no "Vannic" or Armenian cuneiform inscriptions are known to exist of later date than the 7th century B.C.

The example set by the Armenians seems to have been soon followed by their Turanian neighbours in Media. The earliest specimens of the so-called Protomedic (or Amardian) syllabary are to be found in the inscriptions of Mal-Anuir and Sherif Khan. The syllabary of Nineveh appears to have been again the source from which the new script was borrowed. As among the Armenians, polyphony was rejected, a few ideographs only were used, and a selected number of characters employed. The Protomedic transcripts of the Persian inscriptions are written in this syllabary. In Susiana or Elam the archaic Babylonian form of cuneiform continued in use up to the last.

It was reserved for the Aryans of Persia to discover the ultimate capabilities of the cuneiform system of writing by reducing its characters to an alphabet of forty letters. These were divided into two classes, those with an inherent vowel *a*, and those which were followed by *u* and *i*. At the same time all superfluous wedges were thrown away, and the forms of the characters thus simplified as much as their pronunciation. Dr Oppert has pointed out the principle upon which the formation of this new alphabet was carried out. Some one meaning was selected among those a character might bear when used as an ideograph, and this was rendered by its Persian equivalent. The initial sound of the latter was the alphabetic value henceforth represented by the character. Thus  $\blacktriangleright\blacktriangleleft$ , "time of life," *Zaya* in Persian, was contracted into  $\blacktriangleright\blacktriangleleft$  and made to represent 'z (*a*, *u*). A few ideographs were retained along with the alphabetic characters. The Persian cuneiform alphabet, called "Assyrian letters" by Herodotus, seems to have been invented in the early part of the reign of Darius, and, being confined to monumental purposes, soon fell into disuse.

Possibly the reduction of the cuneiform syllabary into an alphabet was suggested by a previous acquaintance with alphabetic writing. In the Persian inscriptions the words are divided from one another by an oblique wedge. A similar division of words is found in one or two Assyrian inscriptions.

See Méhant, *Le Syllabaire Assyrien*, 1861-73; Sayce, *Lectures upon the Assyrian Language and Syllabary*, 1877. (A. II. S.)

## II. SEMITIC.

An account has already been given (see ALPHABET) of the derivation of the Phœnician alphabet from the hieratic alphabet of the Egyptian papyri of the middle empire. No early monuments written in it have as yet been found; the first known examples belong to a time when the alphabet had been widely spread and a literature had long existed. At this time we find the alphabet divided into two branches, the Phœnician and the Aramaean, the first being again subdivided into archaic and Sidonian. The last two are chiefly distinguished by the form of the  $\aleph$ , which is angular in the first and rounded in the second.

The earliest inscription in the Phœnician alphabet known to us is the stele of Mesha, king of Moab, found at Dhibân and belonging to the 9th century B.C. In this Mesha relates that after the death of Abah his god Chemosh enabled him to shake off the yoke of Israel, to drive the Gadites out of Ataroth, and to fortify Kir-hareseth, Aroers, Hironaim, Dibon, and other places. The language of the inscription differs only dialectically from Hebrew.

To the same form of the alphabet belong most of the Phœnician inscriptions on the engraved gems brought of late years from Assyria and Babylonia, among which may be mentioned a cone with the image of a "golden calf" and the names Shemaiah and Azariah (לשמעיהו בן עזריהו). The Aramaic legends on the bilingual lion-weights of Ninrud, which date from the reign of Tiglath-Pileser II. (745-727 B.C.) downwards, also belong to the same form of the alphabet. With these inscriptions may be classed the Phœnician inscription on a bowl lately restored by M. Clermont Ganneau, which mentions a King Ithram, and had been brought with other merchandise from Phœnicia to Cyprus, where it was found. Of later date are the graffiti scratched on the legs of the colossi at Abu-Simbel in Nubia by Phœnician travellers or mercenaries.

The most important monument of the Sidonian period of the Phœnician alphabet is the sarcophagus of Eshmun'azar, son of Tabnith (?Tennes), "king of the Sidonians," which is probably of the 6th century B.C. It may, however, be later. The inscription upon it states that Eshmun'azar had restored the ruined temple of Sidon, and prays the gods to preserve to that city the possession of "Dor, Joppa, and the rich cornlands in the plain of Sharon." Other noteworthy monuments of the same period are the so-called "Second Sidonian Inscription," which records the installation of a subordinate "king of Sidon" by a "king of the Sidonians" of Phœnicia; the inscriptions from Citium in Cyprus of King Pomyathon and his father Melecyathon in the 4th century B.C., as well as the bilingual Phœnician-Greek and Phœnician-Cypriote inscriptions from the same island, the Phœnician-Cypriote inscription of Melecyathon having furnished Mr George Smith with the key to the Cypriote syllabary; together with six inscriptions from Athens and two from Malta; and the three inscriptions found by M. Renan at Umm-el-Awâmid on the Phœnician coast.

The numerous dedicatory inscriptions found on the site of Carthage are written in what is termed the Punic development of the Sidonian alphabet; all apparently belong to the Greek period. The most important Punic inscription is the tariff of sacrifices found at Marseilles in 1845, an abridged edition of which was discovered on the site of Carthage by Mr Davis in 1860. The regulations contained in it have a striking analogy to many of those of Leviticus. Its date, however, cannot be very early, since it makes no mention of human sacrifices. The Punic alphabet was the source of those of Numidia and Bœtica, where inscriptions have been found.

The series of Aramaean inscriptions begins with the dockets on Assyrian contract-tablets of the age of Tiglath, Pileser II. and his successors, when Nineveh and Carchemish became the chief centres of trade in western Asia. To the same period may be assigned an interesting gem from Babylonia inscribed בנה עבריה לבקשת אש well as the cylinder of the eunuch Achadban, son of Gebrod, from Babylonia, and the cone of Hadrakia, son of Hurbad, from Nineveh. As already observed, the inscriptions on the Assyrian lion-weights, though in the archaic Phœnician form of the alphabet, are Aramaic in language. Passing over the engraved stones of the Achaemenian epoch, we may notice the famous bronze lion of Abydos, belonging probably to the 5th century B.C., on which an Aramaic legend is written. Of considerably later date is the inscrip-

tion on an altar found by M. Mariette in the Serapeum, in characters which resemble those of the Aramaean papyri of Ptolemaic Egypt. The alphabet of the latter, however, is still more closely represented by certain funeral monuments found in Egypt with Aramaean inscriptions, the best known of which is the inscription of Carpentras, which records the death of a priestess of Osiris.

Starting from the 1st century B.C., the ruins of Palmyra and Taiba have furnished us with a large number of inscriptions in the Aramaic dialect of the locality. MM. de Vogué and Waddington alone have discovered more than a hundred of them. Most of them are written in what may be termed uncial characters, but there are a few in a cursive hand. Among the persons mentioned in them is Odeinath (Odenatus), the husband of Zenobia. Palmyrene inscriptions have been met with in Africa and Rome, and a bilingual one (in Palmyrene and Latin) has lately been found at South Shields.

Professor Sachau has recently discovered two inscriptions in Old Syriac characters, one at Zebed, near Palmyra, accompanied by Greek and archaic Arabic transcripts, and the other among the early Christiana tombs of Edessa.<sup>1</sup>

Passing over an Aramaic legend found by M. de Sauley on a sarcophagus of the tombs of the kings at Jerusalem, and the coins of the kings of Edessa, we may notice the Mendaite inscription of twenty lines discovered in a tomb at Abu-Shadr in southern Babylonia, and first explained by Dietrich. It probably belongs to the 4th or 5th century. Inscriptions in Western Aramaic have been found in the Hauran. Among these is one on a tomb at Sueydeh, raised by Odeinath to his wife Hamrath in the time of Herod the Great, accompanied by a Greek transcript. Six other inscriptions of the same period come from the temple of Siah; one of them is dedicated to the god Katsiu, the Zeus Kastios of the Greeks.

The Hauran, more particularly the neighbourhood of Bozra, has also yielded a number of Nabathean inscriptions, written in a sort of Aramaic running hand. Nabathean inscriptions have further been found at Umû' er-Russas in Moab, and at Petra, as well as on the coins of Aretas and other Nabathean princes. But they are specially numerous on the rocks of Sinai, where they were scratched by pilgrims in the 3d and 4th centuries of our era, and were first deciphered by Beer. They consist for the most part of proper names, preceded or followed by the word *shalom*, "peace." The Aramaic dialect of these inscriptions is tinged by Arabisms, among which may be mentioned the use of the article *el*. Two Nabathean inscriptions have been discovered at Pozzuoli, where, as we learn from the Acts, there was a Jewish colony.

The Nestorian Syrians carried their language and letters as far even as China. The celebrated inscription of Si-gan-fu is written in good Estrangelo of the 8th century. A Hebrew inscription has also been found at Khai-fong-fu.

Ancient Hebrew epigraphy is poorly represented. The earliest Hebrew inscriptions are three from Siloam, one of which is addressed to "Baal of the temple," a fragment found in the streets of Jerusalem by M. Vernes, and a boundary stone discovered by M. Ganneau near Gezer. The royal names on the pottery found near the foundations of Solomon's temple are not Hebrew, but Phœnician. The Maccæan period has left us several inscribed monuments and coins. The oldest are the epitaph of eight members of the priestly family of Hezir (1 Chr. xxiv. 15) on the Doric tomb of St James at Jerusalem, the beginning of an

inscription on a monument to the north-west of Jerusalem, and an inscription on the sarcophagus found by De Sauley in the tomb of the kings, which probably belongs to a female relative of Helen, queen of Adiabene, in the 1st century of our era. Other early inscriptions have been copied in Galilee, especially in the synagogues of Kefer-Bereim as well as in the Jewish catacombs on the Via Portaensis at Rome. From the 10th century onwards the Jewish cemeteries in Spain, Italy, the south of France, Turkey, and Egypt enable us to trace the history of Hebrew writing up to the close of the Middle Ages; and Professor Ascoli has lately drawn attention to the inscriptions in the Jewish cemetery of Venosa, which enable us to fill up the gap that had previously existed between the memorials of the 10th century and those of the 4th. We must not forget also the exorcisms, written in a dialect allied to that of the Mishna on bronze bowls found at Babylon by Sir A. H. Layard, or the sepulchral inscriptions collected by Firkowitz in a Karaite cemetery of the Crimea, dated sometimes from the creation, sometimes from the capture of Samaria. The latter belong to the 9th and following centuries, though the discoverer falsified the dates of many of them in order to assign them to an earlier period (see Strack in the *Z. D. M. G.*, xxxiv. 1, 1880). Hebrew inscriptions in ancient characters have further been met with from Tiflis to Derbend.

Arabic epigraphy begins with the rise of Islam. Two systems of writing were used concomitantly, the Cufic or uncial, and the Neski or running hand, neither of which, however, can be derived from the other. The earliest inscriptions yet known are two sepulchral ones, the first of which has been published by Wetzstein, Waddington, and De Vogué, while the other has lately been discovered by Sachau at Zebed. A Cufic inscription, dated 693 A.D., has been copied by De Vogué, at Jerusalem, and the old cemetery near Assuan contains a large number of similar inscriptions, some of which, as deciphered by Count Amari, contain the names of the companions of the prophet. Unfortunately this cemetery has never been thoroughly examined. Mention may also be made of Cufic inscriptions at Bozra, in Sicily, and elsewhere. Inscriptions in Greek and Neski Arabic have been found at Damascus, Tiberias, and other places, one of which is dated 696 A.D., while others are even older.

Passing to the north, we find the rocks of the desert of Safa (south-east of Damascus) covered with graffiti written in peculiar characters which long defied decipherment. About six hundred and eighty of them have been copied. M. Halévy, however, has now succeeded in reading them (see *Journal Asiatique*, Jan.-Feb., 1877, and *Z. D. M. G.*, xxxii. 1, 1878), and showing that they are mostly the productions of Thamudite soldiers in the Roman army. The alphabet turns out to be intermediate between the Phœnician and the Himyaritic. The Himyaritic is the name usually given to the form of the Phœnician alphabet used in southern Arabia. Here a considerable number of pre-Islamic inscriptions have been found, belonging partly to the kingdom of Sabâ, partly to that of Ma'n or the Miueans, where a dialect allied to that of Hadramaut was spoken. Many of them contain the names of kings, while most make us acquainted with various deities, among others 'Athtar, the equivalent of Ashtoreth. The Himyaritic alphabet was carried to Abyssinia, where it became the Ghe'ez or Ethiopic syllabary. The earliest specimens of Ethiopic writing are two inscriptions of King Tazêna copied by Rùppell on the monuments of Axum, which belong to the 5th century.

Inscriptions in still undeciphered characters, some of which resemble those of the Himyaritic alphabet, though the larger number is more closely related to the demotic

<sup>1</sup> The inscription at Zebed was first noticed by Dr Bischoff. The letters seem to be derived from an Aramaic alphabet. Some of them resemble the enigmatical characters on gems from Diarbekir and the neighbouring district, published by Dr Mordtmann in the *Z. D. M. G.*, xxxi. 4 (1877).



and hieratic characters of Egypt, have been copied (in 1880) by Professor Robertson Smith on the rocks of Taif near Jeddah. (Compare the inscription from the neighbourhood of El-Wijh given by Wellsted, ii. 189.) Captain Burton has also found an inscription in characters not unlike the Himyaritic, in the Wady Intaysh, with which he compares two semi-Nabathean inscriptions from Wady Unayyid copied by Dr Wallin, and an inscription at Mecca given by Dozy (*The Gold Mines of Midian*, 1878).

The inscriptions of the Semitic Babylonians and Assyrians are separately treated above. The curious Hittite hieroglyphics found of late years at Carchemish, Aleppo, Hamath, and various places in Asia Minor do not seem to conceal a Semitic language.

See Fr. Lenormant, *Essai sur la Propagation de l'Alphabet phénicien dans l'ancien Monde*, 1872-75; E. Renan, *Histoire générale et Système comparé des Langues Sémitiques*, 1863; Gesenius, *Scripturæ Linguaeque Phœnicæ Monumenta*, 1837; Schröder, *Die phönizische Sprache*, 1869; De Vogüé, *Mélanges d'Archéologie orientale*, 1868. Clermont-Ganneau's work on the *Moabite Stone* will supersede previous monographs. (A. H. S.)

### III. INDIAN

The inscriptions of India are very numerous and of great variety. They are found upon rocks, pillars, and buildings, in caves, tops, and temples, and on plates of copper. These last are grants of land made by kings for religious purposes, and they are historically valuable because they contain, not only the name of the grantor, but a more or less complete list of his predecessors. Implicit reliance cannot be placed on these documents. Vanity has sometimes led to the invention of an illustrious ancestry. So far back as the old lawgiver Mann, punishments were denounced upon the forgers of grants, and plates that are palpable forgeries have been discovered.

The oldest and most important of the inscriptions are the religious edicts of King Piyadasi, who is styled *Devánam-piya*, "the beloved of the gods." Their date is clearly proved to be about 250 B.C. This Piyadasi is now by universal consent admitted to be identical with the great Maurya king Asoka, grandson of Chandra-gupta, whose identification by Sir W. Jones with Sandrakoptos or Sandracottus, the ally of Seleucus Nicator, is the cornerstone of that very tottering structure, Hindu chronology. The first published inscription of Piyadasi was copied from a stone column 42 feet high, and known as the *Lát* or pillar of Firoz Sháh, a sultan who, about the middle of the 14th century, conveyed it to Delhi from a village in the hills about 250 miles distant, and re-erected it as an ornament to his capital. The same monarch brought from Meerut and re-erected near his palace another similar column, but this was thrown down by an explosion in the year 1719, and, although it has lately been raised again, it is so much mutilated that scarcely half of the inscription remains. A copy of the inscription on the first of these columns was published by Captain Hoare in the *Asiatic Researches* in 1801. It was a subject of great curiosity and speculation, but it baffled all attempts to decipher it until the year 1837, when the acute sagacity of James Prinsep surmounted the difficulty.<sup>1</sup> This particular alphabet having been first

discovered on and translated from a *Lát*, or pillar inscription, obtained the name of the "*Lát* alphabet," but the name "Indian Páli" is now generally preferred.

The mystery of the alphabet being thus penetrated, the longer and more important rock inscriptions were taken in hand. Two versions were then known, one at Girnár in Káthiáwár, the other discovered and copied by Kittoe at Dhauli in Orissa, at the extreme opposite side of India. Dr Wilson of Bombay and Captain Postans furnished Prinsep with copies of the former, and he collated the two versions. He then transliterated them in modern characters, and with the help of a pandit he rendered them into English. Not long afterwards Prinsep's brilliant discoveries were brought to a close by his untimely death in April 1840.

In the year 1836 M. Court, an officer in the service of Ranjit Singh, the ruler of the Punjab, made known the existence of a rock inscription at Kapur-di-giri, west of the Indus, and not very far from Attock. Subsequent explorations show that the rock is really situated in the village of Sháhbáz-garhi. No copy was obtained until October 1838, when the traveller Masson most carefully and perseveringly made a calico stampage and an eye copy. These he presented to the Royal Asiatic Society, whose acute and laborious secretary, Edwin Norris, proceeded to make a reduced copy of the calico stampage. This inscription was not in the *Lát* character, but in that now known as the Bactrian Páli or Ariano-Páli, which bears strong indications of a Phœnician origin. The *Lát* alphabet or Indian Páli is written, like the character of the Sanskrit, from left to right; the Ariano-Páli runs from right to left. This character had previously been found on the bilingual coins of the Greek kings of Bactria, the obverse of which bore a Greek legend, and the reverse had some letters which proved to be a rendering of the same in Ariano-Páli. Masson first detected the connexion between the two legends, and Prinsep following up his suggestion soon settled the value of several of the Ariano-Páli letters. Similar discoveries were made simultaneously by Lassen in Germany. The letters so discovered were available as keys for the interpretation of the Sháhbáz-garhi inscription, but only as keys, for the inscription contained many dubious and unknown characters, and, unlike the alphabet of the Indian Páli, it possessed numerous compound letters. It was in the process of copying that Norris, like Prinsep, hit upon a clue. He remarked a frequently repeated group of letters, and he came to the conviction that these represented the words *Devánam-piya*. He made known this opinion (*J. R. A. S.*, viii. 303), and gave a copy of a short separate part of the inscription to a young student, afterwards Professor Dowson, who accepted the reading. Knowing that these words were the oft repeated title of Piyadasi in the Girnár inscription, Mr Dowson proceeded to make a comparison of the two and discovered their identity. The whole inscription eventually proved to be a third version of Asoka's edicts. In the year 1850 a fourth version was discovered and copied, though it was not made public, by Mr (now Sir Walter) Elliot, at Jangada near Ganjam in Orissa, about 50 miles south of Dhauli. Lastly, a fifth copy was discovered by Mr Forrest early in 1860, at Khálsi, west of the Jumna, about 15 miles from Masúrf or Mussooree. The late Captain Chapman (*J. R. A. S.*, xiii. 176) brought from Ceylon a copy of a small fragment of rock inscription, and in this the words *Devánam-piya* are distinct, but the copy was made by eye and is unintelligible. These inscriptions show the extent of Asoka's influence, if not of his direct empire. Their

<sup>1</sup> He found the key to it by a very happy guess. He was engaged in copying some short inscriptions engraven upon the pillars of a temple at Sanchi, and he observed that, although each inscription was in the main different, all of them terminated with the same two letters. Knowing that devout Buddhists were in the habit of making votive offerings of pillars, rails, and ornaments to their temples, and of inscribing upon them a record of the gift with the name of the donor, Mr Prinsep assumed that the oft repeated two letters represented the word *dánam*, "gift," and this surmise proved to be correct. He thus obtained the consonants *d* and *n*, and as the name preceding the word *dánam* must necessarily be in the genitive case, this fact made him

master of the letter *s*. He used this key with such ardour and success that in the course of a month he was able to make a transliteration and translation of the whole inscription.

positions are Afghanistan, the foot of the Himalayas, the extreme east and west of the centre of India, and presumably Ceylon, where it is known from other sources that Asoka ruled. The inscription of Shāhbāz-garhi is the only one in the Ariano-Pāli character, the others are in the Lāt or Indian Pāli alphabet. The language of all of them is a Prākṛit or a sort of Pāli, the immediate descendant of Sanskrit, but bearing marks of a long process of detrition. There are dialectical differences in the different versions, and there are also divergences of spelling, as *lāja = rāja, dipi = lipi*, &c. The Khālsī inscription differs from the other Indian Pāli versions in having two of the three distinct sibilants of the Sanskrit, while the others have only one. The inscriptions at Gīrnār, Khālsī, and Shāhbāz-garhi consist of fourteen distinct edicts; those at Dhaulī and Jangada omit three of them, but add two new ones, which, being written apart, are known as the "detached edicts."

When Prinsep and his pandit made their translations, they had before them only the two versions of Gīrnār and Dhaulī. On the publication of the Shāhbāz-garhi version Professor H. H. Wilson made a comparison of the three, and brought out an amended translation which was certainly an improvement upon Prinsep's; but he was far from satisfied with his performance, and declared it "open to correction on every page." The learned and critical Burnouf subsequently studied them, and made fresh translations of parts, which again marked an advance, but he declared that "personne ne peut se flatter d'arriver du premier coup à l'intelligence définitive de ces monuments difficiles." Professor Kern of Leyden has since worked upon them, and his method is turning the language back into Sanskrit and then translating into English. This process only carries out more systematically that of the previous translators. They all interpreted the inscriptions through Sanskrit, making use of such knowledge of Pāli and the other Prākṛits as they possessed or could acquire. The translations are acknowledged to be imperfect and unsatisfactory, and no great improvement can be expected through Sanskrit alone. The words vary greatly in form from their Sanskrit originals, and some changes of meaning and construction no doubt accompanied their alterations in form. Comparative philology, in tracing back the modern tongues of India through the Prākṛits to the Sanskrit, will probably throw fresh light upon the language of the inscriptions, and make more perfect translations possible. All the known inscriptions of Asoka are now accessible to the student. General Cunningham, the Archaeological Surveyor of Hindustan, has published the first volume of his *Corpus Inscriptionum Indicarum*, in which he has given carefully corrected facsimiles, with parallel transliterations of the five versions and all published translations. Mr Burgess also has published an excellent colotype of the Gīrnār version, with transcriptions and translations, in his *Archæological Survey of Kāthiāwār*. Asoka was a convert to Buddhism, but his edicts bear few distinctive marks of that or any formal religion, and they are entirely free from vaunts of his power and dignity. They inculcate a life of morality and temperance, a practical religion, not one of rites and ceremonies. They proscribe the slaughter of animals, and they enjoin obedience to parents, affection for children, friends, and dependants, reverence for elders, Buddhist devotees, and Brahmans, universal benevolence, and unreserved toleration. They would seem to have been set up at a time when there were few differences between Buddhists and Brahmans, and their apparent object was to unite the people in a bond of peace by a religion of morality and charity free from dogma and ritual. One of the edicts provides for the appointment of missionaries to spread the religion. The thirteenth edict refers to Asoka's foreign relations. It mentions the Greek king Antiochus,

and refers to some connexion through him with four other kings, Ptolemy, Antigonus, Magas, and Alexander, or, to quote the words of the Shāhbāz-garhi version, "Antiyokena nama Yona-rajā parancha tena Antiyokena' chaturō (III) rajane Turamaye nama Antikini nama Maka nama Alikasandare nama." The four strokes are numerals, equivalents of the word *chaturō* (four), and in the Khālsī version the numerical sign used is +. Prinsep and his pandit gave a confused rendering of this edict, but no one else has attempted to translate it. There has been some difference of opinion as to the identification of these Greek kings, but the most approved names are Antiochus Theos of Syria, Ptolemy II. of Egypt, Antigonus of Macedonia, Magas of Cyrene, and Alexander II. of Epirus, 253-251 B.C.

Besides the five great inscriptions of Asoka, there are six other rock inscriptions consisting of single edicts, three of which, found at Salsarān, Rūpnāth, and Bairāt are the same, but the last is imperfect. Dr G. Bühler has translated them. A second and different inscription at Bairāt has been translated by Wilson, Burnouf, and Kern. These separate edicts are not found among the fourteen, but they are of similar style and spirit. Two of them have the distinction of being dated thus: "256 [years have elapsed] since the departure of the Teacher," i.e., since the death of Buddha, the time of which has been variously assigned to 544 and 478 B.C. In these two edicts Asoka, after stating that he had been "a hearer of the law" more than thirty-two years and a half, adds, "I did not exert myself strenuously. But it is a year and more that I have entered the community of [ascetics]."

The pillars erected by Asoka would appear to have been numerous, but only a few now remain. Six of these, at Delhi (2), Allāhābād, Lauriya (2), and Sānchi, are inscribed. Five of them present in a slightly variant form the text of a series of six edicts that were promulgated by Asoka in the twenty-seventh year of his reign, 236 B.C. These pillar inscriptions, which are beautifully cut, are not repetitions of those on the rocks, but they are of similar purport. The pillars at Delhi and Allāhābād have since been covered, wherever space was left, and even between the lines of Asoka's inscription, with records and scribbles of later dates. The only one of consequence is the inscription of Samudra-gupta on the Allāhābād pillar. The "iron pillar" of Delhi belongs to a later age, and its inscription is dated 1052 A.D.

In immediate succession to the rock and pillar inscriptions of Asoka come the inscriptions of the caves and rock-cut temples. There are caves in Bihār, Cuttack, and elsewhere with inscriptions showing that they were constructed by Piyadasi or Asoka. Soon after these, about the 2d century A.D., come the caves at Khandagiri in Cuttack, over which there is an important but much defaced inscription. It records the construction of the caves by a king Aira of Kalinga, a convert from Brahmanism to Buddhism, and it gives glimpses of his religious and beneficent life that make its defacement a matter of especial regret.<sup>1</sup> The letters of the inscriptions in the oldest caves show a slight departure from the forms of the Lāt alphabet, and would seem to have been written from about the beginning of the Christian era to the 5th century. The caves at Ajanta, Karlen, Kanhari, Nāsik, and Junir are Buddhist, and contain many inscriptions, but most of these records are of no historical value, as they simply commemorate the dedication of a cave, chamber, cistern, or some other votive gift, coupled with the name of the donor. The same observation applies generally to

<sup>1</sup> Bābū Rājendra Lāt in vol. ii. of his *Antiquities of Orissa*, just published, has proposed some emendations of a few lines of Prinsep's version, but the rock is now in a worse condition than it was in Prinsep's time, and a full translation is hopeless.



the topes at Amarāvati, Sānchi, and elsewhere. In the caves of Nāsik there are some historical records, and the great cave-temple of Karlen is recorded to have been constructed for an emperor named Devabhūti, by a foreigner called "Dhanukakata" or "Dhānukakati," which name is understood to represent Xenocrates. In a Jain cave-temple at Bādāmi there is an inscription of the Chālukya dynasty, dated in 578 A.D. The caves of Elephanta and Ellora are of a much later date. There have been many explorers of the caves and copyists of the inscriptions. Dr J. Wilson successfully interpreted some of the inscriptions, but Dr Stevenson has been the greatest decipherer. The letters of the inscriptions in the caves are often formed with a want of precision and distinctness, and the copies obtained are not always satisfactory, so the translations are open to some doubt, and are capable of improvement.

Soon after the inscriptions of Asoka we have those of the Turushka or Indo-Scythic kings Kanishka and Huvishka, the Kanerke and Oerke of the bilingual coins, whose names are linked with a third as "Hushka, Jushka, and Kanishka" in the Kashmir chronicle called Rāja Tarangini. Their inscriptions have been found in Afghānistān, in the Punjab, and in the hills, and as far east as Mathurā. With the exception of those at Mathurā, they are in the Ariano-Pāli character. They are all short; some consist of only six or seven words. The majority of the inscriptions are dated. The Macedonian months are used, but there is no certainty as to the era. The word used is "Samvatsara,"  $\pi\alpha\delta$ , as there is an era so called, some maintain that they are dated in that era, but as the word "samvatsara" means also year, it may imply a year of some unknown era or of a king's reign. Their period is about the beginning of the Christian era. The first inscription discovered was on a stone slab found by General Court in a large tope at Manikyāla in the Punjab; the longest is one punched on a brass vase extracted by Masson from a tope at Wardak in Afghānistān. The former was discovered just before Prinsep's death, but he did no more with it than picking out the king's name as "Kaneshm," and conjecturing that the date figured  $xx\ 2$  signified  $exx$ . General Cunningham subsequently interpreted the date as 446, and the title of the king correctly as "Kanishka, maharaja of the Gushang tribe." No further discoveries of importance were made until the year 1862, when Mr Roberts obtained, at Hasan Abdāl in the Punjab, a copper plate with five lines of inscription, which he sent to the Royal Asiatic Society. The letters on this plate were clearly written, and, when read by Professor Dowson, the record furnished the long desired key to the numeral system, for the date was given both in words and figures. The forms of the numerals had made Prinsep and others suspect a Roman influence, but the figure 7 proved to be 10 and the x equivalent to 4. The inscription was a record made by a satrap named Liako Kusuluko of his having deposited a relic of Sākyamuni (Buddha) in an institution near Taxila. Before the publication of the translation copies of this inscription were sent to India with the explanation of the date, and with a call for independent translations of the text. General Cunningham made a translation which was revised by Bābū Rājendra Lal, and when brought together the versions were found to be in close agreement.

Professor Dowson succeeded in making out considerable portions of the Manikyāla, Wardak, and other inscriptions, and found that all had reference to the deposit of relics. No progress has since been made in the interpretation of these inscriptions, although there is ample scope for further study. The Manikyāla-inscription is dated in the year 18, and was made in the reign of Kanishka; the Wardak urn is dated in the year 51, and was inscribed in the reign of his successor Huvishka. There are other inscriptions, in

which the names of these kings appear, and the names of King Moga or Moe and of Gondophares have also been found. Several short inscriptions in this character owe their discovery to General Cunningham, who has been most persevering in his search and constant in his endeavours to interpret them. Another series of inscriptions of these Indo-Scythian rulers was obtained by General Cunningham from the ruins of the Buddhist temples and other buildings at old Mathurā. These inscriptions are in the Indian Pāli character and the Sanskrit language, and have been translated by Professor Dowson. Several of them are dated "Sam," the common abbreviated form of Samvatsara. The earliest certain date is 44, and as one of the dates is as high as 280, it is clear that some era is intended. If it be the Samvatsara era, the dates range from 13 B.C. to 337 A.D. These inscriptions have two peculiarities in which they agree with the practice of the inscriptions in western India: instead of months they use the triple series of seasons, and the numerals are arbitrary symbols having little or no arithmetical relation to each other. The explanation of these figures has occupied the attention of Prinsep, Dr Stevenson, General Cunningham, Dr Bhau Dāji, and Mr E. Thomas, and may be said to be accomplished. Some further inscriptions have since been found at Mathurā and translated by General Cunningham. The whole series furnishes the names of Kanishka, Huvishka, and Vāsudeva [ $\pi\alpha\delta\alpha\delta\alpha\delta\alpha\delta\alpha$  of the coins], all of whom bear the arrogant title *Devaputra*, "son of God." One of the last discovered inscriptions is dated as early as the year 5.

About the period of the Indo-Scythians there was in Surāshtra, on the western coast of India, a dynasty of rulers who called themselves Kshatrapas or satrapas, and are known as the Sāh or more properly Sinha kings. These have left some inscriptions commencing with their founder Nahapāna, but they are better represented by their coins, the legends on which are in the Indian Pāli character. On some of the earlier ones the distinctive name of the king is given also in Ariano-Pāli. An inscription in a cave at Nāsik records its construction and dedication by Nahapāna. The most important of their inscriptions is that of Rudra Dāma, the seventh king of the dynasty, dated in the year 72, but of what era is undetermined. This is engraven on the famous rock of Gīrnār near Junāgarh, the same as that on which the edicts of Piyadasi are inscribed. It is in Indian Pāli, and was first deciphered by Prinsep. Since then the translation has been revised by Professor Wilson, Dr Bhau Dāji, and Professor Eggeling. It commemorates the repair of a dam or embankment of the river Palāsini. Its most interesting passage records the fact that the same dam had been formerly repaired by "the Maurya rāja Chandragupta," the classical Sandrakoptos, and it is the only monumental mention known of that king. It also names Asoka specifically as "Asoka Maurya," not as Piyadasi. Mr Burgess has published a fine collotype of this inscription in his *Archaeological Survey*.

After the Sāhs come the Guptas of Kanauj, a dynasty which must not be confounded with the Maurya dynasty of which Chandragupta (Sandrakoptos) was a member. The inscriptions of the Guptas are in a slightly advanced form of the Indian Pāli. One, the first known, translated by Dr Mill, was inscribed by Samudra-Gupta on the old Asoka column at Allāhābād, another is inscribed on the Asoka rock at Gīrnār, being the third on that rock. It records another repair of the Palāsini dam by Skanda-Gupta, and a copy with a translation by Bhau Dāji is published in Burgess's *Survey*. All the Gupta inscriptions are dated in the *Gupta-kāla*, the Gupta era, the epoch of which has long been and still remains a subject of dispute. Other inscriptions of this dynasty have been found at Mathurā, on a

pillar at Bhitari in Ghazipur, at Sanchi, Eran, and other places. After the Guptas come the inscriptions of Toramana, who seems to have succeeded them in Central India.

The Guptas were overthrown by the Vallabhi or Ballabhi kings, the founders of Vallabhi-pura in Kathiawar, who established themselves in the latter half of the 5th century A.D. No monumental inscriptions of this dynasty have been discovered, but their copper grants are numerous, and fresh discoveries are constantly being made. Far down in the south the Kongu kings have left grants of the 4th century, and one of questionable authenticity corresponds in date to 188 A.D. In the Deccan reigned the great family of the Chalukyas, which in course of time divided into two branches. They reigned from the 5th to the 12th century A.D., and their inscriptions, especially their copper grants, are very numerous. Sir Walter Elliot made the history of this dynasty his especial pursuit, and succeeded in collecting and epitomizing some hundreds of inscriptions. Mr Burgess, the archaeological surveyor of western India, and other explorers are constantly making fresh discoveries of inscriptions relating to the Chalukyas and other dynasties of the west and south; and these are quickly translated by the indefatigable Mr Fleet, Mr Rice, Dr Burnell, and other busy translators. Many other dynasties have left copper plate inscriptions which cannot be here described, and a mere list would be of greater length than value. The inscriptions are found in all parts of the country, and date from the early periods above stated until the establishment of the Mahometan rule. They are almost all in Sanskrit, but in the south inscriptions are found in Tamil and Old Canarese. Through all of them the gradual change of the letters from the old Indian Pali to the modern forms is distinctly traceable. Mr Rice has published a thick volume of inscriptions discovered in Mysore, and the pages of the *Indian Antiquary* add every month to the store. A very handsome volume of photographs of inscriptions has been prepared by Mr Fleet at the expense of the Government, but only ten copies have been made.

The inscriptions of the Mahometans in India are also numerous. They are either in Arabic or in Persian, and are often engraved with exquisite skill and grace.—Some celebrate victories, but most of them record the erection of mosques, palaces, tombs, and other edifices. These inscriptions are occasionally valuable in settling dates, but as the Mahometans are good historians their inscriptions are of less importance than those of their Hindu predecessors, who did not write history.

(J. D.\*)

#### IV. GREEK.

Etymologically the term inscription (*ἐπιγραφή*) would include much more than is commonly meant by it. It would include words engraved on rings, or stamped on coins,<sup>1</sup> vases, lamps, wine-jar handles,<sup>2</sup> &c. But Boeckh was clearly right in excluding this *varia suppellex* from his *Corpus Inscriptionum Græcarum*, or only admitting it by way of appendix. Giving the term inscription a somewhat narrower sense, we still include within it a vast store of documents of the greatest value to the student of Greek civilization. It happens, moreover, that Greek inscriptions yield the historian a richer harvest than those of Rome.

<sup>1</sup> The legends on coins form part of numismatics, though closely connected with inscriptions.

<sup>2</sup> The amphore which conveyed the wine and other products of various localities have imprinted on their handles the name of the magistrate and other marks of the place and date. Large collections have been made of them, and they repay inquiry. See Dumont, *Inscriptions Céramiques*, 1872; Paul Becker, *Henkelinschriften*, Leipsic, pt. i. 1862, pt. ii. 1863.

Partly from fashion, but partly from the greater abundance of the material, the Romans engraved their public documents (treaties, laws, &c.) to a large extent on bronze. These bronze tablets, chiefly set up in the Capitol, were melted in the various conflagrations, or were carried off to feed the mint of the conqueror. In Greece, on the contrary, the mountains everywhere afforded an inexhaustible supply of marble, and made it the natural material for inscriptions. Some Greek inscribed tablets of bronze have come down to us,<sup>3</sup> and many more must have perished in the sack of cities and burning of temples. A few inscriptions on small thin plates of lead, rolled up, have survived; these are chiefly imprecations on enemies<sup>4</sup> or questions asked of oracles.<sup>5</sup> But as a rule the material employed was marble. These marble monuments are often found *in situ*; and, though more often they were used up as convenient stones for building purposes, yet they have thus survived in a more or less perfect condition.<sup>6</sup>

Inscriptions were usually set up in temples, theatres, at the side of streets and roads, in *τεμένη* or temple-precincts, and near public buildings generally. At Delphi and Olympia were immense numbers of inscriptions,—not only those engraved upon the gifts of victorious kings and cities, but also many of a more public character. At Delphi were inscribed the decrees of the Amphictyonic assembly, at Olympia international documents concerning the Peloponnesian cities; the Parthenon and Acropolis were crowded with treaties, laws, and decrees concerning the Athenian confederation; the Heraeum at Samos, the Artemisium at Ephesus, and indeed every important sanctuary, abounded with inscriptions. It is a common thing for decrees (*ψηφίσματα*) to contain a clause specifying where they are to be set up, and what department of the state is to defray the cost of inscribing and erecting them. Sometimes duplicates are ordered to be set up in various places; and, in cases of treaties, arbitrations, and other international documents, copies were always set up by each city concerned. Accordingly documents like the *Marmor Ancyranum* and the *Edict of Diocletian* have been restored by a comparison of the various fragments of copies set up in diverse quarters of the empire.

Greek inscribed marbles varied considerably in their external appearance. The usual form was the *στήλη*, the normal type of which was a plain slab, from 3 to 4 or even 5 feet high,<sup>7</sup> 3 or 4 inches thick, tapering slightly upwards from about 2 feet wide at bottom to about 18 inches at the top, where it was either left plain or often had a slight moulding, or still more commonly was adorned with a more or less elaborate pediment; the slab was otherwise usually plain. Another form was the *βωμός* or altar, sometimes square, oftener circular, and varying widely in size. Tombstones were either *στήλαι* (often enriched beneath the pediment with simple groups in relief, commemorative of the deceased), or *κίονες*, pillars, of different size and design, or sarcophagi plain and ornamental. To these must be added statue-bases of every kind, often inscribed, not only with the names and honours of

<sup>3</sup> E.g., treaty between Elis and the Heraeans, about 500 B.C., from Olympia (Boeckh, *C. I. G.*, 11); a similar bronze from Olympia, recently discovered (*Archäol. Zeitung*, 1877, p. 196); a similar bronze treaty from the Locri Ozolei (Rangabé, *Ant. Hellén.*, 356b); bronze plate from Dodona, recording the victory of Athens over the Lacedæmonians in a sea-fight, probably 459 B.C. (*Archäol. Zeitung*, 1878, p. 71).

<sup>4</sup> See Franz, *Elem. Epigr. Gr.*, p. 168, &c.

<sup>5</sup> See Karapanos, *Dodone et ses ruines*.

<sup>6</sup> What was done by Themistocles under stress of public necessity (Thucyd., i. 93) was done by others with less justification elsewhere; and from Byzantine times onward Greek temples and inscriptions were found convenient quarries.

<sup>7</sup> It appears from Cicero, *De Legibus*, ii. 26, 27, that the size of Athenian gravestones was limited by law.



individuals, but also with decrees and other documents. All these forms were intended to stand by themselves in the open air. But it was also common to inscribe state documents upon the surface of the walls of a temple, or other public building. Thus the cella-walls of the temple of Athena Polias at Priene were covered with copies of the awards made concerning the lands disputed between Samos and Priene (*C. I. G.*, 2905, and *infra*); similarly the walls of the Artemesium at Ephesus contained a number of decrees (Wood's *Ephesus*, appendix), and the *proscenium* of the Odeum was lined with *crustæ*, or "marble-veneering," under 1 inch thick, inscribed with copies of letters from Hadrian, Antoninus, and other emperors to the Ephesian people (Wood, *ibid.*, p. 44). The workmanship and appearance of inscriptions varied considerably according to the period of artistic development. The letters incised with the chisel upon the wall or the *στήλη* were painted in with red or blue pigment, which is often traceable upon newly unearthed inscriptions. When Thucydides, in quoting the epigram of Pisistratus the younger (vi. 54), says, "it may still be read ἀνδροῖς γράμμασι," he must refer to the fading of the colour; for the inscription was brought to light in 1877 with the letters as fresh as when they were first chiselled (see Kummandes in *Ἀθήναιον*, vi. p. 149; *Corpus Inscr. Att.*, suppl. to vol. i. p. 41). The Greeks found no inconvenience, as we should, in the bulkiness of inscriptions as a means of keeping public records. On the contrary they made every temple a prominent room; and while the innumerable *σῆλαι*, *Ἡέρμα*, bases, and altars served to adorn the city, it must also have encouraged and educated the sense of patriotism for the citizen to move continually among the records of the past. The history of a Greek city was literally written upon her stones.

Value of inscriptions.

The primary value of an inscription lay in its documentary evidence (so Eripiides, *Suppl.* 1202, foll.). In this way they are continually cited and put in evidence by the orators (e.g., see Demosth., *Fals. Leg.*, 428; Æschin., *In Ctes.*, § 75). But the Greek historians also were not slow to recognize their importance. Herodotus often cites them (iv. 88, 90, 91; v. 58 sq.; vii. 228); and in his account of the victory of Plataea he had his eye upon the tripod-inscription (ix. 81; cf. Thuc. i. 132). Thucydides's use of inscriptions is illustrated by v. 18 foll., 23, 47, 77; vi. 54, 59. Polybius used them still more. In later Greece, when men's thoughts were thrown back upon the past, regular collections of inscriptions began to be made by such writers as Philochorus (300 B.C.), Polemo (2d century B.C., called *σηλοκόπας* for his devotion to inscriptions), Aristodemus, Craterus of Macedon, and many others.

Modern collectors and editors.

At the revival of learning, the study of inscriptions revived with the renewed interest in Greek literature. Cyriac of Ancona, early in the 15th century, copied a vast number of inscriptions during his travels in Greece and Asia Minor; his MSS. collections were deposited in the Barberini library at Rome, and have been used by other scholars. (See *Bulletin* of the French archaeological school at Athens, vol. i.) Succeeding generations of travellers and scholars continued to collect and edit, and Englishmen in both capacities did much for this study.

Thus early in this century the store of known Greek inscriptions had so far accumulated that the time had come for a comprehensive survey of the whole subject. And it was the work of one great scholar, Augustus Boeckh, to raise Greek epigraphy into a science. At the request of the Academy of Berlin he undertook to arrange and edit all the known inscriptions in one systematic work, and vol. i. of the *Corpus Inscriptionum Græcarum* was published in 1828, vol. ii. in 1833. He lived to see the work completed, al-

though other scholars were called in to help him to execute his great design; vol. iii., by Franz, appeared in 1853; vol. iv., by Kirchhoff, in 1856.<sup>1</sup> The work is a masterpiece of lucid arrangement, profound learning, untiring industry, and brilliant generalization. Out of the publication of the *Corpus* there grew up a new school of students, who devoted themselves to discovering and editing new texts, and working up epigraphical results into monographs upon the many-sided history of Greece. In the *Corpus* Boeckh had settled for ever the methods of Greek epigraphy; and in his *Staatshaushaltung der Athener* (well known to English readers from Sir G. C. Lewis's translation, *The Public Economy of Athens*, 2d ed., 1842) he had given a palmary specimen of the application of epigraphy to historical studies. At the same time Franz drew up a valuable introduction to the study of inscriptions in his *Elementa Epigraphicæ Græcæ* (1840).

Meanwhile the liberation of Greece and increasing facilities for visiting the Levant combined to encourage the growth of the subject, which has been advanced by the labours of many scholars, and chiefly Ludwig Ross, Leake, Pittakys, Rangabé, Le Bas, and later by Meier, Sauppe, Kirchhoff, Kumanudes, Waddington. Together with the development of this school of writers, there has gone on a systematic exploration of some of the most famous sites of antiquity, with the result of exhuming vast numbers of inscriptions. Cyrene, Halicarnassus, Cnidus, Priene, Rhodes, and Ephesus have been explored by the English; Athens, Eleusis, and Dodona by the English and the Greeks; Olympia by the Greeks and Germans; Cyprus by General Cesnola; Delphi and Delos by the French; and Pergamos by the Germans. A German and a French institute have been established at Athens, chiefly engaged in the study of inscriptions. And still the work proceeds at a rapid rate. For indeed the yield of inscriptions is practically inexhaustible: each island, every city, was a separate centre of corporate life, and it is significant to note that in the island of Calymnos alone Mr Newton collected over one hundred inscriptions, many of them of considerable interest.

The result of this has been that Boeckh's great work, though it never can be superseded, yet has ceased to be what its name implies. The four volumes of the *C. I. G.* contain about 10,000 inscriptions. But the number of Greek inscriptions now known has been estimated at 20,000 or 30,000. Many of these are only to be found published in the scattered literature of dissertations, or in Greek, German, and other periodicals. But several comprehensive collections have been attempted, among which may be named—Rangabé, *Antiquités Helléniques*, 2 vols., 1842–1855; Keil, *Sylloge Inscriptionum Græcarum*, 1847; Kumanudes, *Ἀττικῆς ἐπιγραφαὶ ἐπιτύμβιοι*, 1871; Le Bas, *Voyage Archéologique*, vols. i.–iii., in course of continuation by M. Waddington; *Greek Inscriptions in the British Museum*, edited by C. T. Newton, pt. i., "Attika," by E. I. Hicks, 1874; and above all the *Corpus Inscriptionum Atticarum*, undertaken by the Berlin Academy, of which there have already appeared vol. i. by Kirchhoff, 1873 (with supplement, by the same, 1877); vol. ii. pt. 1, by Köhler, 1877; vol. iii. pt. 1, by Dittenberger, 1878.

The oldest extant Greek inscriptions appear to date from the middle of the 7th century B.C. During the recent excavations at Olympia a number of fragments of very ancient inscriptions have been found, which have been published in the recent numbers of the *Archäologische Zeitung* (1878–1880). But what is wanted is a sufficient number of very early inscriptions of fixed date. One such exists upon the leg of a colossal Egyptian statue at Abu-Simbel on the upper Nile, where certain Greek mercenaries in the service of King Psammetichus recorded their names, as having explored the

Oldest Greek inscriptions

<sup>1</sup> An index to the four volumes was long wanting: it was at length completed and appeared in 1877.

river up to the second cataract (*C. I. G.*, 5126). Even if Psemmachus II. is meant, the inscription dates between 594 and 589 B.C. Documents earlier than the Persian war are not very frequent; but after that period the stream of Greek inscriptions goes on, generally increasing in volume, down to late Byzantine times.

Classification.

Political inscriptions.

Greek inscriptions may most conveniently be classified under the following heads:—(1) those which illustrate political history; (2) those connected with religion; (3) those of a private character.

1. Foremost among the inscriptions which illustrate Greek history and politics are the decrees of senate and people (*ὑποτάγματα βουλῆς, ἐκκλησίας, &c.*) upon every subject which could concern the interests of the state. These abound from every part of Greece. It is true that a large number of them are honorary, *i. e.*, merely decrees granting public honours (crowns, statues, citizenship, and other privileges) to strangers who have done service to the particular city. But the importance of an honorary decree depends upon the individual and the services to which it refers. And even the mere headings and datings of the decrees from various states afford curious and valuable information upon the names and titles of the local magistrates, the names of months, and other details. Droysen in his *Hellenismus* (1877-78) has shown how the history of Alexander and his successors is illustrated by contemporary *ὑποτάγματα*. And when the student of Athenian politics of the 5th and 4th centuries turns to the 2d volume of the *C. I. A.*, he may wonder at the abundance of material before him; it is like turning over the minutes of the Athenian parliament. One example out of many must suffice:—No. 17 in *C. I. A.*, ii. pt. 1, is the famous decree of the archonship of Nausinicus (378 B.C.) concerning the reconstruction of the Athenian confederacy. The terms of admission to the league occupy the face of the marble; at the bottom and on the left edge are inscribed the names of states which had already joined.

Inscribed laws (*νόμοι*) occur with tolerable frequency. The following are examples:—A citation of a law of Draco's from the *πρότος ἔξων* of Solon's laws (*C. I. A.*, i. 61; cf. *Hermes*, ii. p. 27); a reassessment of the tribute payable by the Athenian allies in 425 B.C. (*C. I. A.*, i. 37; Köhler, *Urkunden und Untersuchungen zur Geschichte des Delisch-attischen Bundes*, 1870, p. 63); a law passed by the Amphictyonic council at Delphi, 380 B.C. (Boeckh, *C. I. G.*, 1688; *C. I. A.*, ii. 545); law concerning Athenian weights and measures (Boeckh, *Staatshaushaltung*, vol. ii. p. 356; *C. I. G.*, 128); the futile sumptuary law of Diocletian concerning the maximum prices for all articles sold throughout the empire (Waddington, *Édit de Dioclétien*, 1884; Mommsen, *C. I. Lat.*, vol. iii. pt. 2, 801 sq.).

Besides the inscribed treaties previously referred to, we may instance the following:—Between Athens and Chalcis in Euboea, 445 B.C. (*C. I. A.*, suppl. to vol. i., 27a); between Athens and Rhegium, 433 B.C. (*C. I. A.*, i. 33, and suppl. *ibid.*, p. 13); between Athens and Leontini, dated the same day as the preceding (*C. I. A.*, suppl. to vol. i., 33a); between Athens and Bœotia, 395 B.C. (*C. I. A.*, ii. 6); between Athens and Chalcis, 378 B.C. (*ibid.*, p. 398); between Athens and Sparta, 271 B.C. (*C. I. A.*, ii. No. 332); between Hermias of Atarneus and the Iolian Erythra, about 350 B.C. (Le Bas and Waddington, *Voyage Arch.*, iii. 1536a); treaties in the local dialect between various cities of Crete, 8d century B.C. (*C. I. G.*, 2554-6; Rangabé, *Ant. Hellén.*, 2478; *Hermes*, iv. 266). Egger's *Études historiques sur les traités publics chez les Grecs et chez les Romains* (Paris, 1866) embraces a good many of these documents.

The international relation of Greek cities is further illustrated by awards of disputed lands, delivered by a third city called in (*ἐκκλητος πόλις*) to arbitrate between the contending states, *e. g.*, Rhodian award as between Samos and Priene (*C. I. G.*, 2905; Le Bas and Wadd., *Voy. Arch.*, iii. No. 189 sq.); Milesian between Messenians and Spartans, recently discovered at Olympia (*Arch. Zeit.*, 1876, p. 128; see Tac., *Ann.* iv. 43); and many others. Akin to these are decrees in honour of judges called in from a neutral city (*γενικόν δικαστήριον*) to try suits between citizens which were complicated by political partisanship (see *C. I. G.*, No. 2349b, and Boeckh's remarks).

Letters from kings are frequent; as from Lysimachus to the Samians (*C. I. G.*, 2254); from Antigonus I. directing the transfer of the population of Lebedus to Teos (Le Bas-Wadd., *Voy. Arch.*, iii. No. 86). Letters from Roman emperors are commoner still; such as *C. I. G.*, 3175, 3176, 3178, 3334.

The internal administration of Greek towns is illustrated by the minute and complete lists of the treasures in the Parthenon of the time of the Peloponnesian war (Boeckh, *Staatshausl.*, vol. ii.); public accounts of Athenian expenditure (*ibid.*); records of the Athenian navy in the 4th century, forming vol. iii. of the same work. The management of public lands and mines is specially illustrated from inscriptions (*ibid.*, vol. i. *passim*); and the political constitution of different cities often receives light from inscriptions which cannot be gained elsewhere (*e. g.*, see the document from Cyzicus, *C. I. G.*, 3665, and Boeckh's note).

Inscriptions in honour of kings and emperors are very common. The *Marmor Ancyranum* has already been mentioned; but an earlier example is the *Monumentum Adulitanum* (from Abyssinia, *C. I. G.*, 5127) reciting the achievements of Ptolemy Euergetes I.

Offerings in temples (*ἀναθήματα*) are often of great historical value; *e. g.*, the helmet of Hiero, now in the British Museum, dedicated at Olympia after his victory over the Etruscans, 474 B.C. (*C. I. G.*, 16); and the bronze base of the golden tripod dedicated at Delphi after the victory of Plataea, and carried off to Constantinople by Constantine (Détlier und Mordtmann, *Epigraphik von Byzanzion*, 1874).

2. The religion of Greece in its external aspects is the subject of a great number of inscriptions. The following are a few specimens. (1) Institution of festivals, with elaborate ritual directions—see inscription Sauppe, *Die Mysterieninschrift aus Andania*, 1860, and the singular towns document from the Ephesian theatre, in Wood's *Ephesus*, appendix vi. 1; the following also relate to festivals—*C. I. G.*, 1845, 2360, 2715, 3059, 3599, 3641b. (2) Laws defining the appointment, duties, or perquisites of the priesthood—*C. I. G.*, 2656; *Staatshausl.*, ii. p. 121 sq. (3) Curious calendar of sacrifices from Myconus, *Ἀθήναιον*, ii. p. 237. (4) Fragment of angry rules, Ephesus, 6th century B.C., *C. I. G.*, 2953. (5) Leases of *τεμένη* and sacred lands—*C. I. G.*, 103, 104, 2693d, 2694; Le Bas and Wadd., *Voy. Arch.*, iii. No. 415, &c. (6) Imprecations written on lead, and placed in tombs or in temples—Franz, *El. Epigr. Gr.*, p. 168; Newton, *Cnidus, Halicarnassus, and Branchidae*, pl. 7, 13. (7) Oracles are referred to—*C. I. G.*, ii. p. 1091 (Ross, *Archæol. Aufs.*, p. 495); *C. I. G.*, 2717. (8) Among the inscriptions from Delphi few are more curious than those relating to the enfranchisement of slaves under the form of sale to a god (see Foucart, *Sur l'affranchissement des esclaves par forme de vente, &c.*, Paris, 1857). This catalogue might be enlarged indefinitely.

3. There remain a large number of inscriptions of a more strictly private character. The famous Parian marble (*C. I. G.*, 2374) falls under this head; it was a system of chronology drawn up, perhaps, by a schoolmaster, in the 3d century B.C. The excessive devotion of the later Greeks to athletic and other competitions at festivals is revealed by the numerous dedications made by victorious competitors who record their successes (see *C. I. G.*, *passim*). The dedications and honorary inscriptions relating to the Ephēbi of later Athens (which occupy half of *C. I. A.*, iii. pt. 1), dreary as they seem, have yet thrown a curious light upon the academic life of Roman Athens (see A. Dumont, *Essai sur l'Éphébie Attique*); and from these and similar late inscriptions the attempt has been made to construct *Fasli* of the later archons (Dumont, *Essai sur la chronologie des Archontes Athéniens*, 1870; R. Neubauer, *Commentationes Epigraphicæ*, 1869; Westermann in Pauly's *Real-Encyclopædie*, vol. i., new ed., *s. v.* Archontes). The sepulchral monuments have been beautifully illustrated in Stackelberg's *Gräber der Hellenen* (cf. Pervanoglou, *Die Grabsteine d. alt. Griechen*, Leipzig, 1863). Some of the most interesting epitaphs in the *C. I. G.* are from Aphrodisias and Smyrna. Kumanudis's collection of Attic epitaphs has been mentioned above; they yield a good deal of information about the Attic demes, and some of them are of high importance, *e. g.*, the epitaph on the slain in the year 458 B.C. (*C. I. G.*, 165), and on those who fell before Potidea (*C. I. A.*, i. 442). Closely connected with sepulchral inscriptions is the famous "Will of Epicteta" (*C. I. G.*, 2448). It was also customary at Athens for lands mortgaged to be indicated by boundary-stones inscribed with the names of mortgager and mortgagee, and the amount (Franz, *El. Epigr. Gr.*, p. 168, 338); other *ῥοι* are common enough.

The names of sculptors inscribed on the bases of statues were collected in 1871 by G. Hirschfeld (*Tituli Statuariorum Sculptorumque*); but since then the number has been greatly increased by excavations at Olympia and elsewhere. In most cases the artists are unknown to fame. Among the exceptions are the names of Pythagoras of Rhegium, whom we now know to have been a native of Samos (*Arch. Zeit.*, 1873, p. 82), Polyclitus the younger (*Arch. Zeit.*, 1878, p. 12), and Pœonius of Mende, who sculptured the marble Nike at Olympia (*Arch. Zeit.*, 1875, p. 178).

The bearing of inscriptions upon the study of dialects is very obvious. A handy collection has been made by Caner (*Delectus dialectæ. Inscr. Gr.*, Leipzig, 1877) of the principal inscriptions illustrating this subject; and the dialect of the Athenian dramatists has been illustrated from inscriptions by Wecklein (*Curæ Epigr. ad Grammaticam Græcam et Poetas scenicos pertinentes*, Leipzig, 1869).

The date of inscriptions is determined partly by the internal evidence of the subject, persons, and events treated of, and the character of the dialect and language. But the most important evidence is the form of the letters and style of execution. Much of this evidence is of a kind difficult to appreciate from a mere description. Yet—besides the *βουττροφῆδον* writing of many early documents—we may mention the contrast between the stiff, angular characters which prevailed before 500 or 450 B.C. and the graceful yet simple forms of the Periclean age. This development was part of the general movement of the time. Inscriptions of this period are usually written *στοιχηδόν*, *i. e.*, the letters are in line vertically as well as horizontally. From the archonship of Euclides (403 B.C.) onwards, the Athenians adopted the fuller alphabet which had obtained in Ionia since the 6th century. Before 403 B.C. ξ and ψ were expressed in Attic inscriptions by ΧΞ and ΦΞ, while E did duty for η, ε, and sometimes ει, O for ο, ου, and ω,—H being used only for the aspirated



The documents of Augustus's administration are recognized by their small, neat characters, very carefully inscribed. The Macedonian period betrays a falling off in neatness and firmness of execution, — the letters being usually small and scratchy, excepting in inscriptions relating to great personages, when the characters are often very large and handsome. At this time came in the use of *apices* as an ornament of letters. These tendencies increased during the period of Roman dominion in Greece, and gradually, especially in Asia Minor, the *iota adscriptum* was dropped. The Greek characters of the Augustan age indicate a period of restoration; they are uniformly clear, handsome, and adorned with *apices*. Under the empire the characters fast degenerated, combining increased ornament with less delicacy of execution. In the 2d or 3d century, if not earlier, the circular and square *sigma* (C, □) occur, together with the circular *epsilon* (ϵ). There are a good many pretty inscriptions under the Antonines; but later the writing grows more coarse and clumsy until Byzantine times, when the forms appear barbarous indeed beside an inscription of the Augustan or even Antonine age.

The finest collections of inscribed Greek marbles are of course at Athens. There are also good collections, public and private, at Smyrna and Constantinople. The British Museum contains the best collection out of Athens (now being edited); the Louvre contains a good many (edited by Fröhner, *Les inscriptions Grecques du musée du Louvre*, 1865); the Oxford collection is very valuable, and fairly large; and there are some valuable inscriptions also at Cambridge.

The following essays give good outlines of the whole subject:—Boeckh, *C. I. G.*, preface to vol. 1.; Westermann in Pauly's *Real-Encycl.*, s. v. *Inscriptiones*; Eger, "Des collections d'inscriptions Grecques" in *Journal des Savants*, 1871; C. T. Newbun, *Essays on Art and Archaeology*, 1880, p. 95, 209. Besides the works already quoted, the following should be mentioned:—Boeckh's *Kleine Schriften*; Wescher-Foucart, *Inscriptions recueillies à Delphes*, 1863; Michaelis, *Der Parthenon*; Waddington, *Fastes des Provinces Asiatiques*, part 1., 1872, and *Mémoire sur la chronologie de la vie du rhéteur Aristide*; Krehhoff, *Studien zur Geschichte der griechischen Alphabets*, 1867; Kell, *Specimen Onomatologiæ Græci*, 1849, and *Analecta Epigraphica et Onomatologica*, 1842; C. Curtius, *Studien und Urkunden zur Geschichte von Samos*, Lübeck, 1877; Meier, *De proxenia*, 1843, and *Die Privatschiedsrichter und die öffentlichen Diakten Athens*, Halle, 1849; Bétant, *Anfaresint apud Græcos iudices certis litibus inter civitates componendis*, diss. inaug., Berl., 1862; Foucart, *Des Associations Religieuses chez les Grecs*, Paris, 1873; Lüders, *Die Dionysischen Künstler*, Berl., 1875. (E. L. H.)

## V. ROMAN.

I. Roman Inscriptions (by which general name are designated, in classical archaeology, all non-literary remains of the Latin language, with the exception of coins, letters and journals) fall into two distinct classes, viz. (1) those which were written upon other objects of various kinds, to denote their peculiar purpose, and in this way have been preserved along with them; and (2) those which themselves are the objects, written, to be durable, as a rule, on metal or stone. The first class is that of *inscriptions* in the stricter sense of the word (styled by the Romans *tituli*, by the Germans *Aufschriften*); the second is that of instruments or charters, public and private (styled by the Romans first *leges*, afterwards *instrumenta* or *tabulae*, and by the Germans *Urkunden*).

No ancient Latin authors have professedly collected and explained or handed down to us Roman inscriptions. Some of the orators and historians, such as Cicero, Livy, Pliny the elder, and Suetonius among the Latins, and Polybius, Dionysius of Halicarnassus, and Josephus among the Greeks, occasionally mention inscriptions of high historical interest. A few grammarians, as for example, Varro, Verrius Flaccus, and Valerius Probus of Berytus, quote ancient words or *formulae* from them, or explain the abbreviations used in them. Juridical instruments, laws, constitutions of emperors, *senatus consulta*, and the like appear here and there in the various collections of Roman jurisprudence.

Inscriptions (in the wider sense, as we shall henceforth call them without regard to the distinction which has been drawn) have been found in nearly every centre of ancient Roman life, but, like many other remains of antiquity, only seldom in their original sites. The great mass of them has to be sought for in the large European museums of ancient art, and in the smaller local collections of ancient remains which occur nearly everywhere in the European provinces of the former Roman empire, as well

as in the north of Africa, and also here and there in Asia Minor.

Only those copies of inscriptions are to be received with full confidence which are furnished by experienced and well-equipped scholars, or which have been made with the help of mechanical methods (casts, photographs, moist and dry rubbings), not always applicable with equal success, but depending on the position and the state of preservation of the monuments.<sup>1</sup> From the first revival of classical learning in the Carolingian age, attention was paid anew, by pilgrims to Rome and other places worth visiting, to epigraphic monuments also. In the time of the Renaissance, from the end of the 14th century downwards, some of the leading Italian scholars, like Poggio and Signorili, and the antiquarian traveller Cyriacus of Ancona, collected inscriptions, Greek and Latin.<sup>2</sup> In the 15th century large collections of the inscriptions of all countries, or of limited districts, were made by Giovanni Marcanova, Fra Felice Feliciano, Fra Michele Ferrarino, Fra Giocondo the architect of Verona, Marino Sanudo the Venetian polyhistor, and others. At the end of the 15th and the beginning of the 16th, the first printed collections can be recorded (Spreti's for Ravenna, 1489; Peutinger's for Augsburg, 1508; Huttich's for Mainz, 1520; Francesco degli Alherini's for Rome, printed in 1521 by Jacopo Mazochi), while during the same century, a long list of epigraphic travellers, like Pighius, Rambertus, and Accursius, or antiquarian collectors, like Sigonius, Panvinius, Antonius Augustinus with his collaborators Ursinus and Metellus, and many others, were busy in augmenting the stock of epigraphic monuments. The series of printed epigraphic *Corpora* begins with that of Apianus (Ingolstadt, 1534), the only one arranged in geographical order, and is continued in those of Smetius (1558, but edited only after the author's death by Justus Lipsius, 1588), Gruter (with Joseph Scaliger's *Indices*, 1603, and re-edited by Grævius, 1707), Gudius (about 1660, edited by Hessel, 1731), Reinesius (1682), Fabretti (1699), Gori (1726), Doni (1731), Murateri (1739), Maffei (1749), Donati (1765-75). These collections, manuscript and printed, will never altogether lose their value, as great numbers of inscriptions known to the ancient collectors have since been lost or destroyed. But, inasmuch as even towards the beginning of the 15th century, as well as afterwards, especially from the 16th down to a very recent period, all sorts of inaccuracies, interpolations, and even downright falsifications, found their way into the *Corpora*, these can be employed only with the greatest caution. Modern critical research in the field of epigraphy began with the detection of those forgeries (especially of the very extensive and skilful ones of Pirro Ligorio, the architect to the house of Este) by Maffei, Olivieri, and Marini. The last-named scholar opens a new era of truly critical and scientific handling of Roman inscriptions (especially in his standard work on the *Atti dei Fratelli Arvali*, Rome, 1795); his disciple and successor, Count Bartolomeo Borghesi (who died at San Marino in 1860), may be rightly called the founder of the modern science of Roman epigraphy.<sup>3</sup> Orelli's handy collection of Roman inscriptions (2 vols., Zurich, 1828) is a first attempt to make accessible to a larger scientific public the results of the researches of Marini and his successors; but it was not completed (and thoroughly corrected) until nearly thirty years later, by Henzen (Orelli, vol. iii., with the indispensable *Indices*, Zurich, 1856), who,

<sup>1</sup> See E. Hübner, *Ueber mechanische Copieen von Inschriften*, Berlin, 1881.

<sup>2</sup> Compare De Rossi, *Bullettino dell' Instituto archeologico*, 1871, p. 1 sq.

<sup>3</sup> Of his works, published by the French Government, nine volumes 4to (Paris, 1862-66) have already appeared.

with Mommsen and De Rossi, carried out the plan of a universal *Corpus Inscriptionum Latinarum*, previously projected by Maffei (1732), by Kellermann and Sarti (1832), with Borghesi's help, and by Letronne and Egger (1843). After the appearance of Mommsen's *Inscriptiones regni Neapolitani Latinæ* (Leipsic, 1852) and his *Inscriptiones Confœderationis Helveticæ Latinæ* (vol. x. of the publications of the Zurich Antiquarian Society, 1854), the publication of the *C. I. L.*, following the similar work on the Greek inscriptions, was undertaken by the Royal Academy of Sciences of Berlin. This work, in which the previous literature is fully described and utilized, consists of the following parts:—vol. i., *Inscriptiones Antiquissimæ ad C. Cæsaris mortem*, by Mommsen (Berlin, 1863), with the *Fasti Consulares* by Henzeu, and the *Indices* by Hübner; Ritschl's *Priscæ Latinitatis monumenta epigraphica* (Berlin, 1862, fol.) form the graphic illustration to vol. i., giving all extant monuments of the republican epoch (with five *Supplementa*, Bonn, 1862-65; R. Garracci's *Sylloge Inscriptionum Latinarum ævi Romanæ reipublicæ usque ad C. Iulium Cæsarem plenissima*, 2 vols., Turin, 1875-77, must be used with caution); vol. ii., *Inscr. Hispaniæ* by Hübner (1869); vol. iii., *Inscr. Asiæ, provinciæ Europæ Græcarum, Illyriæ*, by Mommsen; vol. iv., *Inscr. parietariæ Pompeianæ Herculanses Stabianæ* (the scratched and painted inscriptions chiefly of Pompeii) by Zangemeister (1871); vol. v., *Inscr. Galliæ cisalpinæ*, that is, *regionis Italiæ decimæ et undecimæ et novæ* (1872-77); vol. vi., part i., *Inscr. urbis Romæ*, by Henzeu (part ii. in the press); vol. vii., *Inscr. Britannia*, by Hübner (1873); vol. viii., *Inscr. Africa*, by Wilmaus and Mommsen (to be published in 1881; here Renier's *Inscriptions Romaines de l'Algérie*, Paris 1855-1860, though not finished, may be consulted); vols. ix. and x., *Inscr. Italiæ inferioris*, by Mommsen (to be published in 1881 or 1882); vol. xi., *Inscr. Italiæ superioris*, by Bormann, vol. xii., *Inscr. Galliæ*, by Hirschfeld (a subject partly treated in W. Brambach's *Corpus Inscriptionum Rhenanarum*, &c., Elberfeld, 1866), vol. xiii., *Inscr. Italiæ mediæ*, by Dessau, and a concluding volume of general indexes are either in the press or in preparation. The arrangement observed in the *Corpus* is the geographical (as in Apianus); within the single towns the order of subjects (*tituli sacri, magistratuum, privatorum*, &c., as in Smetius) is followed, with some few exceptions, where the monuments are so numerous (as in the *forum* of Rome—see H. Jordan, "Sylloge inscr. fori Romani," *Ephem. epigr.*, iii. p. 237 sq.—and at Pompeii and Lambæsis) that they can be assigned to their original places. Running supplements to the *C. I. L.* are given in the *Ephemeris epigraphica, Corporis Inscr. Latinarum Supplementum* (4 vols., Berlin, 1872-80). The inscriptions in the other Italian dialects have been published by Aufrecht and Kirchhoff (*Die umbrischen Sprachdenkmäler*, 2 vols., Berlin, 1849-51), Mommsen (*Die unteritalischen Dialecte*, Leipsic, 1850), Fabretti (*Corpus Inscriptionum Italicarum antiquioris ævi*, Turin, 1867, with three supplements, *ibid.*, 1872-77), Corssen (*Ueber die Sprache der Etrusker*, 2 vols., Leipsic, 1874-75; see also Deecke, *Etruskische Forschungen*, i. to iv., Stuttgart, 1875-80); for farther particulars on the Italian dialects see Hübner's *Grundriss zu Vorlesungen über die lateinische Grammatik*, 2d ed., Berlin, 1880, p. 9). For the Christian inscriptions of Rome, and of Gaul, Spain, and Britain, see De Rossi's *Inscr. Christianæ urbis Romæ septimo sæculo antiquiores*, vol. i. (Rome, 1857), and the same author's *Roma sotterranea* (3 vols., Rome, 1861-77), with the *Bullettino di Archeologia cristiana* (Rome, 1873-80), the *Inscriptions Chrétiennes de la Gaule* of Le Blant (2 vols., Paris, 1857-65), and the *Inscr. Hispaniæ Christianæ* and *Inscr. Britannia Christianæ* of Hübner (Berlin, 1871, 1876). As splendidly illustrated works on the Latin

inscriptions of some districts, Alphouse de Boissieu's *Inscriptions antiques de Lyon* (Lyons, 1846-54), Ch. Robert's *Epigraphie romaine de la Moselle* (Paris, 1875), and J. C. Bruce's *Lapidarium septentrionale* (London and Newcastle, 1875) can be recommended. Besides the above-mentioned Orelli-Henzen collection, G. Wilmanns's *Exempla Inscriptionum Latinarum* (2 vols., Berlin, 1873, with copious indexes) gives a general synopsis of the materials.

II. The alphabet used by the Romans is identical with that of the Chalcidian colonies in southern Italy and Sicily (viz., Cyme, Neapolis, Rhegium, Zancle, Naxos, and Himera), except the three aspirates  $\theta$ ,  $\phi$ ,  $\chi$ ; these, being of no use in ancient Latin, which had no such aspirates, were employed as numerals. The old Z, which occupied the seventh place in the alphabet, being of rare employment, was replaced, as early as the 4th century A.U.C., by G, a letter formed by the addition of a stroke out of the old gamma C, which became identical in sound with K, though remaining in use as an abbreviation for *Gaius* and *Gnaeus*. To that standard alphabet of twenty-one letters were appended, in Cicero's time, the Greek letters  $\upsilon$  and  $\zeta$ . In this alphabet (A B C D E F G H I K L M N O P Q R S T V X Y Z, in this form found written on the walls of Pompeii, on tiles and other monuments) the forms of the single letters vary not inconsiderably, according to the material of the monuments, their age, and their origin. Carefully cut letters, especially when on a large scale, naturally differ from those scratched or painted on walls by non-professional hands, or hewn on rocks by soldiers; and small incised (or dotted) letters on metal or ivory and bone, and those painted on earthenware, or impressed on it or on glass before burning, are also necessarily of a different character. The letters, ordinarily drawn with *minium* on the monument before being cut (and also often painted, after having been cut, with the same colour), sometimes have been painted with a brush, and thence receive a peculiar form. A, in the most ancient period (before the Second Punic War), appears in these forms,  $\Delta$   $\Lambda$   $\Delta$ ;  $\perp$ , in the same epoch, is acute-angled (as in the Chalcidian alphabet),  $\perp$ ; P is rectilinear,  $\Gamma$ ; Q has a perpendicular stroke,  $\rho$ ; B, D, R, S are often not rounded, but acute-angled ( $\beta$   $\triangleright$   $\rho$   $\zeta$ ); O and Q appear sometimes not closed ( $\circ$ ,  $\alpha$ ). Besides E and F (which usually have their horizontal strokes of equal length and not as in modern printing), there were in use some quasi-cursive forms,  $\mu$  and  $\mu$ ; and besides M (which, at the best periods, has its two exterior strokes inclined, not perpendicular, and the middle point extended to the foot of the line), a *carsivo* IIII is to be found. In later periods, F is sometimes elevated above the other letters (and afterwards not F only), G assumes the form  $\mathcal{G}$ , H appears as h, and L as l,—to mention only some prominent diversities, for a complete history of the paleographic changes of the Roman alphabet has not yet been written. In general, the old quadrate forms of the letters, with equal breadth of strokes above and below, become, by degrees, more slender and elegant, the tops and angles being slightly curved, &c. Additions to the Roman alphabet were made, but without permanent success, by the emperor Claudius ( $\mathcal{A}$  for V the consonant, to distinguish it from v the vowel,  $\mathcal{C}$  for the Greek  $\psi$ ,  $\mathcal{T}$  for the sound between i and u, as in *bybliotheca*; he wrote also *ai* for *ae*). To distinguish, after the later Greek usage, long from short vowels, in the course of the 7th century A.U.C. the plan of doubling them was introduced for a, e, and o (not u), while the long i was written *ei*, and afterwards indicated by the prolonged form  $\mathcal{I}$ . At the end of the republic these distinctions disappear, and long vowels are distinguished, when at all, by an *apex* (a stroke or a curved line upon



them, not an accent), down to the epoch of the emperor Marcus Aurelius. In some very rare instances the doubling of consonants is indicated by a *scilicet*, a hook (') upon them. The double *i* indicates, in some examples, from Cæsar down to Domitian, the consonantal *j* (as in *cuivus*, *ciivus*). To save space, on coins first and afterwards in inscriptions also, two or three or even more letters were joined, especially at the end of the lines, to a *nexus* or a *ligatura*. This system of compendious writing, very rare in the republican epoch, and slowly extending itself during the 1st century, became rather frequent in the 2d and 3d, especially in Spain and Africa. There is no constant system in these *nexus litterarum*, but generally the rule is observed that no substantial element of a single letter is to be counted for twice (thus, e.g., † is *it* or *ti*, not *Titi*). In the republican period, the numbers from one to nine are mostly written in the *additive* form (I II III IIII V VI VII VIII VIII), and similarly in combination with X, XX, and so on (XXXX, LXXXX); V, for five, seems to be a graphic division of X. The  $\chi$  of the Chalcidian alphabet,  $\psi$ , is the numeral for fifty (afterwards L and L, which has originally nothing to do with the letter L); the 9,  $\Theta$ , is that for a hundred (replaced early by the initial of the word *centum*, C); the  $\Phi$ ,  $\Theta$ , is that for a thousand (afterwards M, the initial of *mille*), of which  $\Upsilon$ ,  $\text{C}$  are only slight graphic alterations. The multiples of a thousand by 10 are written thus  $\text{M}$  (10,000),  $\text{MM}$  (100,000). From  $\Theta$  came, by graphic division,  $\text{D}$  (not D the letter) for 500 (with  $\text{D}$  5000,  $\text{DD}$  50,000). A peculiar mark ( $\text{C}$ ) appears rarely for 500,000 (*Hermes*, iii., 1868, p. 467). Numerals are usually distinguished from letters in the ancient period, down to the end of the republic, by a stroke drawn through them, as in  $\text{H VIR}$ , *duo(m) vir(om)*  $\text{HS duo semis (sestertius)}$ ,  $\text{D 500}$ ; it was afterwards put above them, as in  $\text{IVIR}$ ,  $\text{XVIR}$ ,  $\text{IIVIR}$ , (*duovir, decemvir, sevir*).<sup>1</sup>

The direction of the writing is, even in the oldest inscriptions, from left to right; there exists only one very ancient example of an inscription, found at the lake Fucinus, written in a kind of  $\beta\omega\sigma\tau\rho\phi\eta\delta\acute{o}\nu$  arrangement (H. Jordan, *Hermes*, vol. xv., 1880, p. 5), while in the Sabellic inscriptions similar arrangements are not infrequent. Each word is separated from the other by a sign of interpunction, which is not wanted, therefore, at the end of lines or of the whole text. Exceptions to this rule occur only in the later period (from the 2d century downwards), and sometimes under special conditions, as when abridged words form the end of the line. Here and there even the different syllables of each word are separated by interpunction. The interpunction is formed by a single dot (except in some very ancient inscriptions, such as those of Pisaurum, where, as in Greek and other Italian monuments, three dots : are used), which, according to the technical skill of the different periods in stone-cutting, is in some very ancient inscriptions quadrangular, or similar to an oblique cross ( $\times$ ), or oblong (as a bold stroke), but, as a rule, triangular, and never circular. This triangular dot changes, by ornamentation, into a hook ( $\text{?}$ ) or a leaf ( $\text{?}$ ); the ivy-leaf-shaped dot is especially frequent in inscriptions from about the 2d century downwards. The dot is always placed at the middle height of the letters, not, as now, at the foot of the line. In large texts of instruments the interpunction is often omitted; in the later period it is often entirely wanting; and in short texts, in the disposition of the lines, in the varying sizes of the letters employed, in the division of words at the end of the lines, &c., certain rules are observed, which cannot be detailed here. In some instances older inscriptions have

been cancelled and more recent ones substituted, e.g., on milestones), especially in the case of the *damnatio memorie* (in cases of high treason), in consequence of which the names of consuls and emperors are often cancelled; but in modern times also inscriptions have been deliberately destroyed or lost ones restored.

For understanding the texts of the inscriptions an accurate knowledge of the system of abbreviations used in them is necessary. These are almost invariably *litteræ singulares*, that is to say, the initial letter is employed for the entire word (in all its grammatical forms), or, if one initial, as belonging to more than one word, is not sufficiently clear, the first two or even the first three letters are employed; rarely more than three. Abbreviations in the true sense of the word (by dropping some letters at the end) are to be found, in the older period, only at the end of lines, and not frequently. In the later period some instances of them have been observed. The *litteræ singulares*, as Valerius Probus taught, are either generally employed (*usus generalis*) in all classes of written documents (and so in literature also), as, for instance, those of the individual names (the *prænominâ*), the names of days and feasts (*kal.* for *kalendæ*), and those of the chief magistrates (*cos.* for *consul*) and the like; or they belong chiefly (but not exclusively) to certain classes of documents, such as those used in juridical acts (*l.* for *lex*, *h.* for *heres*, *s. d. m.* for *sine dolo malo*, and so on), in sepulchral inscriptions (*h. s. e.*, *hic situs est*) or in dedicatory inscriptions (*v. s. l. m.*, *votum solvit libens merito*), &c.<sup>2</sup>

It may be observed here that the *prænominâ* are, as a rule, always written in the universally known abbreviations (in the few instances where they are written in full, it is a consequence of Greek influence or of peculiar circumstances). The *gentilicia* in *-ius* are abridged, in the republican period, in *-i* (in the nominative, perhaps for *-is*). In the always abbreviated indications of ancestors or patrons (in the case of slaves and freedmen), as *C. f. Gai filius, M. l., Marci libertus* (*s.* for *servus* is not frequent), the feminine gender is sometimes indicated by inversion of the letters. Thus *J. l.* (or *lib.*) or *W* (an inverted *M*) *l.* designates a *mulieris libertus*;  $\text{?}$  and  $\text{?}$  are used for *filia, pupilla*. On the *tribus* and their abbreviations, and on the so-called military *tribus* (which are names of colonies collocated, for the sake of symmetry, at the place usually occupied, in the nomenclature, by the *tribus*), and on the other indications of origin used in the designation of individuals, the indexes to the above-named works give sufficient information; on the geographical distribution of the *tribus*, see Grotefend's *Imperium Romanum tributim descriptum* (Hanover, 1863). For the abbreviations of official charges, urban and municipal, and, in the imperial period, civil and military (to which, beginning with the 4th century, some Christian designations are to be added), see also the explanations given in the indexes. Among these abbreviations the first instances are to be found of the indication of the plural number by doubling the last letter; thus *Augg.*, *Caess.*, *cos.*, *qd. nn.* (*domini nostri*), are used from the 3d century downwards (see De Rossi's preface to the *Inscriptiones Christ. urbis Romæ*) to distinguish them from *Aug.*, *Caes.*, as designating the singular. In the later period, a dot or a stroke over the abridged word, like that upon numerals, here and there indicates the abbreviation.

<sup>1</sup> On the system of Roman nomenclature and the abbreviations employed in it, see Orelli, cap. viii. (with Wilmann's *Analecta*, ii. p. 197), and especially Mommsen in *Römische Forschungen*, vol. i. p. 1 sq., and in *Hermes*, iii., 1869, p. 70; on the *cognominâ* (but only those occurring in ancient literature), Ellenst. (*De cognomine et agnomine Romano*, Königsberg, 1853), and on the local *cognomina* of the Roman patriciate, Mommsen, *Röm. Forsch.* ii. p. 290 sq.; on the *nominâ gentilicis*, Hübn. (*Ephem. cypri.* ii. p. 25 sq.). The indexes to Orelli, Wilmanns, and the volumes of the *Corpus* may also be consulted.

<sup>2</sup> For other details of numerical notation, fractions, &c., see the manuals of metrology.

III.—1. Among the inscriptions in the stricter sense (the *tituli*), perhaps the oldest, and certainly the most frequent, are the *sepulchral inscriptions (tituli sepulchrales)*. Of the different forms of Roman tombs, partly depending upon the difference between burial and cremation, which were in use side by side, the latest and a very complete account is given in Marquardt's *Handbuch der römischen Alterthümer* (vol. vii. part i., Leipzig, 1879, p. 330 sq.). The most ancient examples are those of a *sepulchrum* at Preneste (*C. I. L.*, i. 74, 165, 1501 a-d; *Ephem. epigr.*, i. 25-131, Wil. 153); the oldest of these contain nothing but the name of the deceased in the nominative; those of more recent date give it in the genitive. The oldest and simplest form remained always in use down to Christian times; it is that used on the large tectonic monuments of the Augustan age (e.g., that of Cæcilia Metella, *C. I. L.*, vi. 1274) and in the *mausolea* of most of the emperors, and is still frequent in the *tituli* of the large *columbaria* of the same age (*C. I. L.*, vi., part ii.). It was early succeeded by the lists of names, given also in the nominative, when more than one individual, either dead or alive, were to be indicated as sharers of a tomb. To distinguish the members still alive, a *v* (*vivit, viros, vivi*) was prefixed to their names (e.g., *C. I. L.*, i. 1020, 1195, 1271); the deceased were sometimes marked by the *θήρα nigrum* (*C. I. L.*, i. 1032; Wil. 158; see also *C. I. L.*, vi. 10251 sq.). Only the names in the nominative are shown, too, on the sarcophagi of the *Turpelli* and *Fourti* at Tusculum (*C. I. L.*, i. 65-72; Wil. 152), and in the oldest inscriptions on those of the *Scipiones*, painted with *minium* (*C. I. L.*, i. 29; Wil. 537), to which were added afterwards the insignia of the *magistratus curules* (*C. I. L.*, i. 31; Wil. 538) and the poetical *elogia*. Of a somewhat different kind are the inscriptions scratched with much care on very simple earthen vessels which belonged to a *sepulchrum* of the lower class, situated outside the *porta Capena* at Rome, on the Appian road, near the old church of San Cesario (*C. I. L.*, i. 882-1005, 1539, 1539 a-d = *C. I. L.*, vi. 8211-8397; Wil. 176); they can be ascribed to the period of the Gracchi. On these *olla*, besides the name of the deceased, also for the most part in the nominative, but on the more recent in the genitive, the date of a day, probably that of the death, is noted; here and there *obit* (or *o.*) is added. About the same epoch, at the beginning of the 6th century, along with the growing taste for tectonic ornamentation of the tombs in the Greek style, poetical epigrams were added to the simple sepulchral *titulus*, especially amongst the half-Greek middle class rapidly increasing in Rome and Italy; Saturnian (*C. I. L.*, i. 1006), iambic (1007-1010), and dactylic (1011, compare *Annali dell' Istituto Archeologico*, vol. xxxvii., p. 308) verses become more and more frequent in epitaphs (see Wil. 548 sq.). In prose also short designations of the mental qualities of the deceased (*homo bonus, misericors, amans pauperum, or uxor frugi bona pudica*, and the like), short dialogues with the passer-by (originally borrowed from Greek poetry), as *vale-salve, salve-ire, vale et tu*, &c. (Wil. 180), then indications of his condition in his lifetime, chiefly among the Greek tradesmen and workmen, e.g., *lanius de colle Fimiale* (*C. I. L.*, i. 1011), *margaritarius de sacra via*, 1027, and the like), and some formulae, such as *ossa hic sita sunt, hic cubat, hic situs est* (in republican times mostly written in full, not abridged) were added. The habit of recording the measurement of the sepulchre, on the sepulchral *cippus*, by such formulae as *locus patet in fronte pedes tot, in agro (or in via, or retro) pedes tot*, seems not to be older than the Augustan age (*C. I. L.*, i. 1021, with Mommsen's note; Wil. 188). About the same time also the epitaphs more frequently state how long the deceased lived, which was formerly added only on certain occasions (e.g., in the case of a premature death), and mostly in poetical form. The worship of the *dei Manes*, though undoubtedly very ancient, is not alluded to in the sepulchral inscriptions themselves until the close of the republic. Here and there, in this period, the tomb is designated as a (*locus*) *devum Manium* (e.g., at Hispellum, *C. I. L.*, i. 1410); or it is said, as on a *cippus* from Corduba in Spain (*C. I. L.*, ii. 2255; Wil. 218), *C. Sentio Sal(urmino) co(n)s(ule)*—that is, in the year 19 n.c.—*dei Manes receperunt Abullium N(umerii) (libertam) Nigellam*. In the Augustan age the *titulus sepulchralis* begins to be confounded with the *titulus sacer*; it adopts the form of a dedication *dei Manibus*, offered to the *dei Manes* (or *dei inferi Manes*, the *dei parentum* being the *Manes* of the parents) of the deceased (see Orel. 4351; Wil. 217-228). This formula, afterwards so common, is still very rare at the end of the republic, and is usually written in full, while in later times it is employed, both simply and in many varied forms (as *dis manibus sacrum*, or *d. m. et memoria*, *d. m. et genio*, or *memoriae aeternae, paci et quieti, quieti aeternae, somno aeternali*, and so on; Wil. 246), in thousands of monuments. By similar degrees the *titulus sepulchralis* adopts many of the elements of the *titulus honorarius* (the indication of the *cursor honorum*, of the military charges, &c., as, e.g., in the inscription of Cn. Calpurnius Piso, *C. I. L.*, i. 598 = vi. 1276, Wil. 1105, on the pyramid of Cestius, *C. I. L.*, vi. 1374, and on the monument at Ponte Lucano of Ti. Plautius Silvanus Ælianus, consul 74 A.D.,

Orel. 750, Wil. 1145, and many others), of the *tituli operum publicorum* (e.g., *monumentum fecit, sibi et suis*, &c.), and of the *instrumenta*. Testaments (like those of Dasumius of the year 100 A.D.—*C. I. L.*, vi. 10229, Wil. 314, and T. Flavius Syntrophus—*C. I. L.*, vi. 10239, Henz. 7321, Wil. 313), or parts of them (like that on the tomb of a Gaul of the tribe of the Lingones, belonging to Vespasian's time, Wil. 315), funeral orations (as those on Turia, the wife of Q. Lucretius Vespillo, consul 19 n.c.—*C. I. L.*, vi. 1527, in Orel. 4859 incomplete; on Mordia—*C. I. L.*, vi. 10230, Orel. 4860, Rudorff, *Abhandlungen der Königl. Akademie der Wissenschaften zu Berlin*, 1868, p. 217 sq.; and that of Hadrian on the elder Matidia, found at Tivoli—Mommsen in the same *Abhandlungen*, 1863, p. 483 sq.), numerous statements relating to the conservation and the employment of the monuments (*C. I. L.*, vi. 10249; Wil. 287-290), to their remaining within the family of the deceased,—from which came the frequent formula "*h(oc) m(onumentum) h(eredem) n(on) s(equetur)*" and the like (Wil. 280),—and relating to the annual celebration of *parentalia* (Wil. 305 sq.), down to the not uncommon prohibition of violation or profanation of the monument (compare, for instance, *C. I. L.*, i. 1241, Wil. 267, from Naples, "*deis inferum parentum sacrum, ni violato*"; *C. I. L.*, iii. 3955, from Siscia, "*ne quis in hac ar[e]a porcos agi facere velit*"; *C. I. L.*, ii. 2703, from Portugal, in a distich, "*quisquis honorem agiles, ita te tua gloria servet, præcipias puero ne linat hunc lapidem*"; *C. I. L.*, vi. 2357, "*hospes ad hunc tumulum ne meias ossa præcantur*," &c.; and Wil. 271-273), and the addition of the name of the stone-cutter (*C. I. L.*, v. 7670; Wil. 2490; Orel.-Henz. 6344) and of the writer of the *titulus* (Do Rossi, *Inscr. Christ.*, i. p. 9; Wil. 1285, 2490), with many other particulars (on which the index of Wil. p. 678 sq., may be consulted), form the text of the sepulchral inscriptions of the later epoch from Augustus downwards. To these are to be added many local peculiarities of provinces (as Spain and Africa), districts (as the much-disputed *sub aescia* dedicatee of the stones of Lyons and other parts of Gaul), and towns, of which a full account cannot be given here.

2. Of the *dedicatory inscriptions* (or *tituli sacri*), the oldest known are the short indications painted (along with representations of winged *genii*, in the latest style of Greco-Italian vase painting), with white colour on black earthen vessels, by which those vessels (*paucula*) are declared to be destined for the worship, public or private, of a certain divinity (*C. I. L.*, i. 43-50; *Ephem. epigr.* i. 5-6; Wil. 2827 a-i); they give the name of the god, as that of the possessor, in the genitive (e.g., *Saeturni poculum, Lavernai poculum*). The proper form of the dedication, the simple dative of the name of a divinity and often nothing else (as *Apolenci, Fidei, Junone*, &c., which are all datives), is shown on the very primitive altars found in a sacred wood near Pisaurum (*C. I. L.*, i. 167-180; Wil. 1-14); but also the name of the dedicants (*matrona, matrona Pisavrese*, which are nomin. plur.) and the formulae of the offering (*dono dedit* or *dedro, donu dat*, where *dono* and *donu* are accus.) are already added to them. This most simple form (which is the perfect or in the present) never disappeared entirely; it occurs not infrequently also in the later periods. Nor did the dative alone, without any verb or formula, go entirely out of use (see *C. I. L.*, i. 630; Wil. 36; *C. I. L.*, i. 814 = vi. 96; Orel. 1850; Wil. 32; *C. I. L.*, i. 1153; Henz. 5789; Wil. 1775). But at an early date the verb *donum dare* and some synonyms (like *donum portare, ferre, mancipio dare, parare*) were felt to be insufficient to express the dedicator's good will and his sense of the justice of the dedication, which accordingly were indicated in the expanded formula *dono dedit lib(c)s merito* (*C. I. L.*, i. 183, cf. p. 555; Wil. 21; *C. I. L.*, i. 190; Wil. 22), or, with omission of the verb, *dono mere(to) lib(c)s* (*C. I. L.*, i. 182). The dative case and this formula, completely or partially employed (for *merito* alone is also used, as *C. I. L.*, i. 562, cf. *Ephem. epigr.*, ii. 353, Wil. 29), remained in solemn use. To *libens* (or *libens*) was added *letus* (so in Catullus, 31, 4), and, if a vow preceded the dedication, *votum solvit* (or *voto condamnatus dedit*; see *C. I. L.*, i. 1175; Henz. 5733; Wil. 142; and *C. I. L.*, ii. 1044); so, but not before the time of Augustus (see *C. I. L.*, i. 1462 = iii. 1772), the solemn formula of the dedicatory inscriptions of the later period, *v. s. l. m.* or *v. s. l. l. m.*, arose. To the same effect, and of equally ancient origin with the solemn words *dare* and *donum dare*, the word *sacrum* (or other forms of it, as *sacra[ra]*), conjoined with the name of a divinity in the dative, indicates a gift to it (e.g., *C. I. L.*, i. 814; Wil. 32; *C. I. L.*, i. 1200-1201; Wil. 33 a b); the same form is to be found also in the later period (e.g., *C. I. L.*, i. 1124; Henz. 5624-5637), and gave the model for the numerous sepulchral inscriptions with *dis Manibus sacrum* mentioned before. *Sacrum* combined with a genitive very seldom occurs (Orel. 1824; Wil. 34); *ara* is found more frequently (as *ara Nephuni* and *ara Ventorum*, Orel. 1340). Dedications were frequently the results of vows; so victorious soldiers (such as L. Mummius, the conqueror of Corinth—*C. I. L.*, i. 541 sq.; Orel. 563; Wil. 27), and prosperous merchants (e.g., the brothers Vertuleii—*C. I. L.*, i. 1175; Henz. 5733; Wil. 142) vow a tenth part of their booty (*de præcibus*, as is said on the basæ erected by one of the Fourii of Tusculum—*C. I. L.*, i. 63, 64;



Henz. 5674; Wil. 18) or gain, and out of this dedicate a gift to Hercules or other divinities (see also *C. I. L.*, i. 1503; Wil. 24; *C. I. L.*, 1113; Wil. 43). Again, what one man had vowed, and had begun to erect, is, by his will, executed after his death by others (as the *propylaeum Ciceris et Proserpinae* on the Eleusian temple, which Appius Claudius Pulcher Cicero's well-known predecessor in the Cilician proconsulate, began—*C. I. L.* i. 619 = iii. 327; Wil. 31); or the statue that an *adilis* vowed is erected by himself as *duovir* (*C. I. L.*, iii. 500; Henz. 5684); what slaves had promised, they fulfil as freedmen (*C. I. L.*, 1233, *scrvos vocit liber solvit*; *C. I. L.*, 816, W. 51, "*scr(ros) vor(it) leibert(us) solv(it)*"), and so on. The different acts into which an offering, according to the circumstantially detailed Roman ritual, is to be divided (the *consecratio* being fulfilled only by the solemn *dedicatio*) are also specified on dedicatory inscriptions (see, for instance, *consecrare* or *consecrare*, Orel. 2503, and Henz. 6124, 6123; for *dedicare*, *C. I. L.*, i. 1169, Henz. 7024, Wil. 1782, and compare Catullus's *hunc lucum tibi dedico consecroque* *Præp.*, fragm. 2 ap. Lachmann and Müller; for *dicare*, see the *arae loci Albani dicata* to Vediovius by the *gentilices Iulici*, *C. I. L.*, i. 807, Orel. 1287, Wil. 101). Not exactly dedicatory, but only mentioning the origin of the gift, are the inscriptions on the pedestals of offerings (*ἀναθήματα, donaria*) out of the booty, like those of M. Claudius Marcellus from Enna (*C. I. L.*, i. 530; Wil. 25, "*Hinnud cepit*") or of M. Fulvius Nobilior, the friend of the poet Ennius, from Ætolia (*C. I. L.*, i. 534; Orel. 562; Wil. 26a, and *Bullettino dell' Instituto*, 1869, p. 8; *C. I. L.*, vi. 1307; Wil. 26b, "*Ætolia cepit*" and "*Ambracia cepit*"); they contain only the name of the dedicator, not that of the divinity. Of the similar offerings of L. Mummius, already mentioned, two only are preserved in their original poetical form, the Roman in Saturnian verses of a *carmen triumphale* (*C. I. L.*, i. 541; Orel. 563; Wil. 27a) and that found at Reate in dactylic hexameters (*C. I. L.*, i. 542; Wil. 27b); the rest of them contain only the name of the dedicant and the dative of the community to which they were destined (*C. I. L.*, i. and Wil. l.c.). Of a peculiar form is the very ancient inscription on a bronze tablet, now at Munich, probably from Rome, where two *adiles*, whose names are given at the beginning as in the other *donaria*, "*vicesma(m) parti(m) or [ex] vicesma parti Apolones* (that is, *Apollinis*) *dederit* (that is, *dedecere*)" (*C. I. L.*, i. 187; Orel. 1433). Many, but not substantial, varieties arise, when old offerings are restored (e.g., *C. I. L.*, i. 638, 632 = Orel. 2135, and Wil. 48; *C. I. L.*, i. 803; Henz. 5669, 6122); or the source of the offering (e.g., *de stipite*, *C. I. L.*, i. 1105; Henz. 5633a; *ex reditu pecunie*, *ex patrimonio suo*, *ex ludis, de munere gladiatorio*, and so on); or the motive (*ex jussu*, *ex imperio*, *ex visu*, *ex oraculo*, *monitu*, *viso moniti*, *sonnio admonitus*, and the like), or the person or object, for which the offering was made (*C. I. L.*, i. 183, *pro populo*; *Ephem. epigr.*, ii. p. 308, *pro trebitos*; *pro se*, *pro salute*, *in honorem domus divinae*, &c.), are indicated; or, as in the *tituli operum publicorum*, the order of a magistrate (*de senati sententia*, *C. I. L.*, i. 560 = vi. 1306; Orel. 5351; i. 632 = vi. 110; Orel. 2135; Wil. 48; *decurionum decreto*, &c.), and the magistrates or private persons executing or controlling the work, the place where and the time when it was erected, are added. On all these details the indexes, especially that of Wil. (ii. p. 675), give further information. The objects themselves which are offered or erected begin to be named only in the later period just as in the *tituli operum publicorum* ("*basim domum dant*," *C. I. L.*, i. 1107; "*stignum basim*," *C. I. L.*, i. 1154; "*aram*," *C. I. L.*, i. 1468; Orel. 1466; Wil. 52; *C. I. L.*, i. 1109; Wil. 54); in the later period this custom becomes more frequent. It is hardly necessary to observe that all kinds of offerings have very frequently also been adorned with poetry; some of these *carmina dedicatoria* are given by Wil. 142–151.

3. Statues to mortals, whether living or after their death (but not on their tombs), with *honorary inscriptions* (*tituli honorarii*), were introduced into the Roman republic after the Greek model, and only at a comparatively late date. One of the oldest inscriptions of this class comes from Greek soil and is itself Greek in form (*C. I. L.*, i. 633; Wil. 649), "*Italiici L. Cornelium Scipionem (i.e., Asiagenum) honoris causa*," lost and of not quite certain reading, belonging to 561 A.U.C. (193 B.C.); the same form (in the accusative) appears in other (Latin or Latin and Greek) inscriptions from Greece (*C. I. L.*, i. 596 = iii. 532; Wil. 1103; *C. I. L.*, iii. 365; *Ephem. epigr.*, iv. 77; compare also *C. I. L.*, i. 587, 588; Orel. 3036). The same Greek form occurs also, curiously enough, in an honorary inscription of the age of Constantine (*C. I. L.*, i. 1708; Wil. 1227). But at an earlier date, at the end of the 5th century A.U.C., the noble house of the Scipios had already introduced the use of poetical *elogia*, in the ancient form of the *carmina triumphalia* in Saturnian verses (from the 6th century in *elogia* distichs). As has been stated above, they were added to the short *tituli*, painted only with *menium* on the sarcophagi, giving the name of the deceased (in the nominative) and his curial offices (exclusively), which were copied perhaps from the well-known *imagines* preserved in the atrium of the house (*C. I. L.*, i. 29 sq.; Orel. 550 sq.; Wil. 537 sq.; and elsewhere). They hold, by their

contents, an intermediate place between the sepulchral inscriptions, to which they belong properly, and the honorary ones, and therefore are rightly styled *elogia*. What the Scipios did thus privately for themselves was in other cases done publicly at a period nearly as early. The first instance preserved of such a usage, of which Pliny the elder speaks (*Hist. Nat.*, xxxiv. § 17 sq.), is the celebrated *columna rostrata* of C. Duilius, of which only a copy exists, made in the time of the emperor Claudius (*C. I. L.*, i. 195 = vi. 1300; Orel. 549; Wil. 609). Then follow the *elogia* inscribed at the base of public works like the *Arcus Fabianus* (*C. I. L.*, i. 606, 607, and p. 278, *elog.* i.–iii. = vi. 1303, 1304; Wil. 610), or of statues by their descendants, as those belonging to a *sacrarium domus Augustæ* (*C. I. L.*, i. *elog.* iv.–vi. = *C. I. L.*, vi. 1310, 1311) and others belonging to men celebrated in politics or in letters, as Scipio, Hortensius, Cicero, &c., and found in Rome either on marble tablets (*C. I. L.*, i. vii.–viii. = *C. I. L.*, vi. 1312, 1279, 1283, 1271, 1273; Wil. 611–617; or on busts (*C. I. L.*, i. xv.–xix. = *C. I. L.*, vi. 1327, 1295, 1320, 1309, 1325, 1326; Wil. 618–621; see also *C. I. L.*, i. 40 = vi. 1280; Wil. 1101; and *C. I. L.*, i. 631 = vi. 1278; i. 640 = vi. 1323; vi. 1321, 1622, where T. *Quincti* seems to be of the nominative), and in divers other places (*C. I. L.*, i. xiii., xiv.; Wil. 614, 615). This custom seems to have been resumed by Augustus with a political and patriotic aim, praised by the poet Horace (*Od.*, iv. 8, 13, "*incisa notis marmora publicis, per quæ spiritus et vita redit bonis post mortem ducibus*"); for he adorned his *forum* with the statues of celebrated men from Æneas and Romulus downwards (*C. I. L.*, i. xxiv., xxv., xxvii., xxxii. = *C. I. L.*, vi. 1272, 1308, 1315, 1318; Wil. 625, 626, 627, 632), and other towns followed his example (so Pompeii, *C. I. L.*, i. xx., xxii. = Wil. 622, 623; Lavinium, *C. I. L.*, i. xxi., Wil. 617; Arretium, *C. I. L.*, i. xxiii., xxviii., xxix., xxx., xxxi., xxxiii., xxxiv. = Wil. 624, 625, 629–633). All these *elogia* are written in the nominative. In the same way in the colonies statues seem to have been erected to their founders or other eminent men, as in Aquileia (*C. I. L.*, i. 538 = v. 873, Wil. 650; compare also *C. I. L.*, v. 862; Orel. 3827) and Luna (*C. I. L.*, i. 539 = Wil. 651).

But along with this primitive and genuine form of the *titulus honorarius* another form of it, equivalent to the dedicatory inscription, with the name of the person honoured in the dative, begins to prevail from the age of Sulla onwards. For the oldest examples of this form seem to be the inscriptions on statues dedicated to the dictator at Rome (*C. I. L.*, i. 584 = vi. 1297; Orel. 567; Wil. 1102a) and at other places (Caieta and Clusium, *C. I. L.*, i. 585, 586; Wil. 1102b, c), in which the whole set of honours and offices is not enumerated as in the *elogia*, but only the *honores præsentis*; compare also the inscription belonging to about the same date, of a *questor urbanus*, *C. I. L.*, i. 636). Within the Greek provinces also, at the same period, this form is adopted (*C. I. L.*, i. 595 = iii. 531; Henz. 5294; Wil. 1104). Similar dedications were offered to Pompey the Great (at Auximum and Clusium, *C. I. L.*, i. 615, 616; Orel. 574; Wil. 1107) and to his legate L. Afranius (at Bologna, but erected by the citizens of the Spanish colony Valentia, *C. I. L.*, i. 601; Henz. 5127; Wil. 1106). They are succeeded by the statues raised to Cæsar (at Iovianum, *C. I. L.*, i. 620; Orel. 582; Wil. 1108), and, after his death, *iussu populi Romani*, in virtue of a special law, at Rome (*C. I. L.*, i. 626 = vi. 872; Orel. 586; Wil. 877). With him, as is well known, divine honours begin to be paid to the *princeps*, even during life. In this same form other historical persons of high merit also begin to be honoured by posterity, as, for example, Scipio the elder at Saguntum (*C. I. L.*, ii. 3836; Wil. 653), Marcellus, *Romanorum ensis*, at Nola (Mommson, *Inscr. Ncap.*, 1984; Henz. 5347), Marius at Cereate Mariane, the place which bears his name (Mommson, *Inscr. Ncap.*, 4487; Wil. 654). Of statues erected by the community of a municipium to a private person, that of L. Popilius Flæcus at Ferentinum seems to be the oldest example (*C. I. L.*, i. 1164; Wil. 655, and his note). In Rome, Augustus and his successors in this way permitted the erection of statues, especially to *triumphatores*, in the new *fora*, including that of Augustus (*C. I. L.*, vi. 1386; Orel. 3187; Wil. 634; *C. I. L.*, vi. 1444; Henz. 5448; Wil. 636) and that of Trajan (*C. I. L.*, vi. 1377; Henz. 5478; Wil. 636; vi. 1549; Henz. 5477; Wil. 639; iv. 1549; Orel. 1386; Wil. 637; *C. I. L.*, 1565, 1566; Wil. 640); and this custom lasted to a late period (*C. I. L.*, vi. 1599; Henz. 3574; Wil. 638), as is shown by the statues of Symmachus the orator (*C. I. L.*, vi. 1693, 1699; Orel. 1186, 1187; Wil. 641), Claudian the poet (*C. I. L.*, vi. 1710; Orel. 1182; Wil. 642), Nicomachus Flavianus (*C. I. L.*, vi. 1782, 1783; Orel. 1188; Henz. 5593; Wil. 645, 645a), and many other eminent men down to Stilicho (*C. I. L.*, vi. 1730, 1731; Orel. 1183, 1134; Wil. 648, 648a), who died in the year 408. In similar forms are conceived the exceedingly numerous dedications to the emperors and their families, in which the names and titles, according to the different historical periods, are exhibited, in the main with the greatest regularity. They are specified in detailed indexes by Henzen and Wilmanns, as well as in each volume of the *Corpus*. In the provinces, of course, the usages of

the capital were speedily imitated. Perhaps the oldest example of a *titulus honorarius* in the form of an *clogium* (but in the dative), with the full *cursum honorum* of the person honoured, is a *bilinguis* from Athens, of the Augustan age (*C. I. L.*, iii. 551; Henz. 6456a; Wil. 1122); the honours are here enumerated in chronological order, beginning with the lowest; in other instances the highest is placed first, and the others follow in order.<sup>1</sup> In the older examples the formula "*honoris causa*," or *virtutis ergo* (*Hermes*, vol. vi., 1871, p. 6), is added at the end, as in an inscription of Mytilene belonging to the consul of the year 723 A.V.C., i.e., 31 B.C. (*C. I. L.*, iii. 455; Orel. 4111; Wil. 1104b); the same, abbreviated (*h.c.*), occurs on an inscription of about the same age from Circa in Africa (*C. I. L.*, viii. 7099; Wil. 2384). Shortly afterwards the honour of a statue became as common in the Roman *municipia* as it was in Athens and other Greek cities in the later period. Each province furnishes numerous examples, partly with peculiar formulae, on which the indexes of Wilmanns (p. 673, 696 *sq.*) may be consulted. Special mention may be made of the numerous honorary inscriptions belonging to *aurigae*, *histriones*, and *gladiatores*; for those found in Rome see *C. I. L.*, vi. 10044-10210.

He who erects a temple or a public building, or constructs a road, a bridge, an aqueduct, or the like, by inscribing his name on the work, honours himself, and, as permission to do so has to be given by the public authorities, is also honoured by the community. Therefore the *tituli operum publicorum*, though in form only short official statements (at least in the older period) of the origin of the work, without any further indications as to its character and purpose, partake of the style of the older honorary inscriptions. Of the ancient and almost universally employed method of erecting public buildings by means of the *locutio censoria* one monument has preserved some traces (*Ephem. epigr.*, ii. 199). The oldest instance of this class is that commemorating the restoration of the temple of the Capitoline Jupiter, begun, after its destruction by fire in the year 671 (83 B.C.), by Sulla and continued five years later by the well-known orator and poet Q. Lutatius Catulus, but completed only about twenty years afterwards. Here, after the name of Catulus in the nominative and the indication of the single parts of the building (as, for example, *substructionem et tubularium*) follows the solemn formula *de senati* (*sententia*) *fecerunt* *coeravit* *eidemque* *probravit* (*C. I. L.*, i. 592 = vi. 1314; Orel. 31, 3267; Wil. 700). With the same formula the pretor M. Calpurnius Piso Frugi (of about the same period) dedicated an unknown building (*C. I. L.*, i. 594 = vi. 1275), restored afterwards by Trajan. On a work executed by the *collegium triumvirorum plebis* (*C. I. L.*, i. 593 = vi. 1299; Wil. 787), perhaps the public streets within the town, the sum employed for it is also inscribed. Precisely similar is the oldest inscription of one of the bridges of Rome, the *ponte dei quattro capi*, still preserved, though partly restored, on its original site, which commemorates its builder, the tribune of the year 692 (62 B.C.), L. Fabricius (*C. I. L.*, i. 600 = vi. 1305; Orel. 50; Wil. 788); it was restored by the consuls of the year 733 (21 B.C.).<sup>2</sup> On privately erected buildings the founder after his name puts a simple *fecit* (as also on sepulchral inscriptions); so, possibly, did Pompey, when he dedicated his theatre as a temple of Venus Victrix and, on Cicero's clever advice, as Varro and Tiro had it from Cicero himself, inscribed on it *cos-tert* (not *tertium* or *tertio*) (see Gellius, *Noct. Att.*, x. 1). So Agrippa, when he dedicated his Pantheon in the year 727 (27 B.C.), inscribed on it only the words *M. Agrippa L. f. eos. tertium fecit* (*C. I. L.*, vi. 896; Orel. 34; Wil. 731), as all who visit the Eternal City know. Of municipal examples it will be sufficient to name those of the majestic temple of Cora (*C. I. L.*, i. 1149-1150; Wil. 722, 723), of Ferentinum, with the measurements of the foundation (*C. I. L.*, i. 1161-1163; Wil. 708), of the walls and towers at Eclanum (*C. I. L.*, i. 1230; Orel. 566; Henz. 6583; Wil. 699), of the theatre, amphitheatre, baths, and other structures at Pompeii (*C. I. L.*, i. 1246, 1247, 1251, 1252; Orel. 2416, 3294; Henz. 6153; Wil. 730, 1899-1901). At Alatrium a munificent citizen gives an enumeration of a number of works executed by him in the period of the Gracchi, in his native town ("*hæc quæ inferu scripta sunt de senatu sententia faciendâ coeravit.*" *C. I. L.*, i. 1164; Orel. 3892; Wil. 706); and, more than a century later, the same is done at Cartima, a small Spanish town near Malaga, by a rich woman (*C. I. L.*, ii. 1956; Wil. 7416). Military works, executed by soldiers, especially frequent in the Danubian provinces, Africa, Germany, and Britain, give, in this way, manifold and circumstantial information as to the military administration of the Romans. On a column found near the bridge over the Minho at

Aque Flavie, the modern Chaves in northern Portugal, ten communities inscribed their names, probably as contributors to the work, with those of the emperors (Vespasian and his sons), the imperial legate of the province, the legato of the legion stationed in Spain, the imperial *procurator*, and the name of the legion itself (*C. I. L.*, ii. 2477; Wil. 803); and similarly, with the name of Trajan, on the famous bridge over the Tagus at Alcântara, in Spanish Estremadura, the names of the *municipia provincie Lusitanie stipe conlata quæ opus pontis perfecerunt* are inscribed (*C. I. L.*, ii. 759-762; Orel. 161, 162; Wil. 804).

As in some of the already-mentioned inscriptions of public works the measurements of the work to which they refer (especially, as may be supposed, in the case of works of great extent, such as walls of towns or lines of fortification, like the walls of Hadrian and Antoninus Pius in Britain) are indicated, so it early became a custom in the Roman republic to note on *milestones* the name of the founder of the road and, especially at the extremities of it and near large towns, the distances. So in the *cal di Diana* in Lucania P. Popilius Lænas, the consul of the year 622 (132 B.C.), at the end of a road built by him, set up the *miliarium Popilianum* (*C. I. L.*, i. 551; Orel. 3308; Wil. 797), which is a general *clogium* to himself, in which he speaks in the first person (*erum feci ab Regio ad Capuam*, &c.). One of the single *miliaria* set up by him is also preserved (*C. I. L.*, i. 550; Henz. 7174d; Wil. 808), which contains only his name and the number of miles. In the same brief style are conceived the other not very frequent republican *miliaria* found in Italy (*C. I. L.*, i. 535-537; Henz. 5348; Wil. 567; *C. I. L.*, i. 540; Henz. 5350, 6226; Wil. 807; *C. I. L.*, i. 558, 559; Henz. 5353; Wil. 808; *C. I. L.*, i. 561; Henz. 5180; Wil. 811; *C. I. L.*, i. 633; Wil. 812) down to the time of Augustus (Mommsen, *I. N.*, 6244; Wil. 813), and also the even more rare specimens from the provinces (from Asia—*C. I. L.*, i. 557 = iii. 479, Wil. 826, *C. I. L.*, i. 622 = iii. 462, Wil. 827; from Spain—*C. I. L.*, i. 1484-1486 = ii. 4920-4925, 4956, Wil. 828, 829). Augustus inscribed on each milestone on his road across Spain "*a Bæle et Juno Augusto ad Oceanum*" (e.g., *C. I. L.*, ii. 4701; Wil. 832), Claudius on those of a road in Upper Italy founded by his father Drusus "*viam Claudium Augustam quam Drusus pater Alpinus bello pacificis decreverat munil ab Alino (or a flumine Pado) ad flumen Danuvium*" (*C. I. L.*, v. 8002, 8003; Orel. 648, 708; Henz. 5400; Wil. 818). The later milestones vary greatly in form, but all contain most precious and not yet nearly exhausted materials for ancient geography and topography; in the volumes of the *Corpus* they are taken together under the special head *via publica* (and here and there *privata*) at the end of each chapter.

A similar character, resulting from the combination of a more authentic record with the peculiar form of the honorary inscription, belongs to the kindred classes of *inscriptions of the aqueducts* and of the different *boundary-stones*. The aqueducts of Rome are known to have their origin in remote antiquity; but no inscriptions belonging to them, so far as has been as yet discovered, go farther back than to the age of Augustus.<sup>3</sup> The large dedicatory inscriptions of the celebrated aqueducts of Rome (as the Aque Marcia, Tepula, and Julia, *C. I. L.*, vi. 1244-1246, Orel. 51-53, Wil. 765; the Virgo, *C. I. L.*, vi. 1252, Orel. 703, Wil. 763; the Claudia, etc., *C. I. L.*, vi. 1256-1258, Orel. 54-56, Wil. 764) have quite the character of honorary inscriptions, while the various *cippi terminales*, which mark the ground belonging to the aqueduct, show the greatest analogy to the milestones (e.g., *C. I. L.*, vi. 1243a-y; Henz. 6635, 6636; Wil. 775-779). The other Italian and provincial varieties cannot be specified here. Of boundary-stones, or *cippi terminales*, some very ancient specimens have been preserved. To the age preceding the Second Punic War belong two, found at Venusia and erected by municipal magistrates (*C. I. L.*, i. 185, 186; Orel. 3527, 3528; Wil. 863); they give a short relation of a decree, by which certain localities were declared to be sacred or public ("*aut sacrom aut publicum locum esse*"). Then follow the *cippi Gracchani*, by which Gaius Gracchus and his two colleagues, as *tres viri agris iudicandis assignandis*, measured the *ager Campanus*, for its division among the plebs. They contain the names of the *tres viri* in the nominative, and in addition, on the top, the lines and angles of the *caridi* and *decumanus*, according to the rules of the *agrinensores*, or the boundary lines between the *ager publicus* and *privatus* (*C. I. L.*, i. 552-556; Henz. 6464; Wil. 859-861). From the age of Sulla we still have various boundary-stones giving the line of demarcation between different communities (between Fanum and Pisaurum—*C. I. L.*, i. 583, Orel. 570, Wil. 861; between Atene, Vicetia, and Patavium—*C. I. L.*, i. 547-549, Orel. 3110, Henz. 5114, 5115, Wil. 865, 866). To the town of Rome belong the *termini ripæ Tiberis* (*C. I. L.*, i. 608-614 = vi. 1234a-l), beginning in the Augustan age, and the *termini of the pomerium* of Claudius and Vespasian as censors, and of the *collegium augurum* under Hadrian (*C. I. L.*, vi. 1231-1233; Orel. 710, 811; Wil. 843, 844), while others, of the consuls of the year 4 A.D. (*C. I. L.*, vi. 1263; Orel. 3260; Wil. 856), of Augustus,

<sup>1</sup> This observation, applied to a large number of monuments, gave rise to many of the splendid epigraphical labours of Borghesi (see *eg.* his dissertation upon the inscription of the consul L. Muntilius, *Æneses*, iv. p. 103 *sq.*).

<sup>2</sup> The character of an *clogium* is assumed in a special way by the inscriptions on triumphal arches, such as that of Augustus on the arch of Susa in Piedmont, dating from the year 745 (B.C.) (*C. I. L.*, v. 7291; Orel. 626), and the similar one on the *tropæa Augusti* (in Turin) (*C. I. L.*, v. 7817) of the year 747 (B.C.), which Pliny also (*Hist. Nat.*, iii. § 126) records, and those of the other emperors at Rome, of which only that of Claudius, the conqueror of Britain (*C. I. L.*, vi. 826, 827; Orel. 715; Wil. 829), with the statues of himself and his family, need be mentioned.

<sup>3</sup> See the recent important work of R. Lanclani, *Commentari di Frontino intorno le acque e gli acquedotti*, &c., Rome, 1880.



(*C. I. L.*, vi. 1265; Henz. 6455; Wil. 852), &c., show the boundary between the *ager publicus* and *privatus*. With similar objects boundary-stones were erected by the emperors, or, under their authority, by magistrates, mostly military, in the rest of Italy also (as in Capua—Mommson, *I. N.* 3590, Orel. 3683, Wil. 855; at Pompeii—*I. N.* 2314, Wil. 864) and in the provinces (as in Syria—*C. I. L.*, iii. 183; in Macedonia—*C. I. L.*, iii. 594; in Dalmatia—*C. I. L.*, iii. 2383; in Africa—*C. I. L.*, viii. 7084-90, 8211, 8263, 10803, 10838, Wil. 869, 870; in Spain—*C. I. L.*, ii. 2349, 2916, Wil. 871—where the *pratum* of a legion is divided from the territory of a *municipium*; in Gaul—Wil. 867; in Germany, in the column lately found at Miltenberg on the Main, *Bonner Jahrbücher*, vol. lxxiv., 1878, p. 46, &c.). The recent attempt to combine under some boundary system the numerous stones found in Britain on military buildings, as on the wall of Hadria and in divers *castra*, which indicate the *centuriæ* of legions and cohorts employed in the work and its measurements as executed by them, has been finally refuted by Mr Clayton (in the *Archæologia Eliana*, 1880). Private grounds (*pedaturæ*) were frequently marked off by terminal *cippi*. To this class of *tituli* must be added also the curious inscriptions incised upon the steps of Roman circuses, theatres, and amphitheatres (see Hübner, *Annali dell' Instituto archeologico*, vol. xxviii., 1856, p. 52 sq., and vol. xxxi., 1859, p. 122 sq.), as, for instance, upon those of the Coliseo at Rome (*C. I. L.*, vi. 1796, 1-37; compare R. Lanciani, *Bullettino archeologico municipale*, 1881).

4. We now come to the last class of *tituli*, viz., those which in the *Corpus* are arranged, at the end of each volume, under the head of *Instrumentum*. By this very comprehensive term are designated objects which vary greatly among themselves, but which are of such a character as not to fall within any of the classes of *tituli* described before, or the class of the *instrumenta* in the proper sense of that word,—the laws, &c. The *tituli* of the *instrumentum* embrace movable objects, destined for public and private use, and illustrate almost every side of the life of the ancient Romans. As systematic treatment of them is hardly possible, a simple enumeration only of their different classes can be given, without citing special examples. The first species of them is metrological, comprehending the inscriptions on measures and weights. The gold and silver plate used in the best Roman houses was also always marked with a note of its weight,—as is seen, for instance, on the different objects belonging to the Hildesheim find (see *Hermes*, iii., 1863, p. 469 sq.; *Philologus*, xxviii., 1869, p. 369), the Corbridge lance in Northumberland House (*C. I. L.*, vii. 1268), and many others. A second species is formed by the *tesserae*, tokens, or marks, mostly in bronze, bone, and ivory, but also earthen, of which the most interesting are the so-called *tesserae gladiatoria*, little staves of bone with holes at the top, and with names of slaves or freedmen and consular dates upon them, the relation of which to the *munera gladiatoria* is by no means certain (see *C. I. L.*, i. 717 sq., and Hübner, *Monatsberichte der Berl. Acad. der Wissenschaften*, 1867, p. 747 sq., *Revue archéologique*, vol. xv., 1868, p. 469 sq., and *Ephem.*, iii. 203). The other circular *tesserae* of ivory or bone, with emblems and short inscriptions, partly Greek and Latin, may with more confidence be attributed to the *ludi scenici* (see Henzen, *Annali dell' Instituto archeologico*, vol. xx., 1843, p. 273 sq., and vol. xxii., 1850, p. 357 sq.) and to other *ludi*; but the uses of many of them remain very uncertain. A third species is that of inscriptions carved, inscribed, painted, or stamped upon various materials, raw or manufactured, for trade or household use. Such are, to begin with the most solid and heavy, the inscriptions carved or painted on masses of stone, mostly columns, in the quarries, and preserved either on the rocks themselves in the quarries or on the roughly hewn blocks transported to the Roman *emporium* on the Tiber bank. Curious specimens of the first kind are preserved in Lebanon, and in the north of England, near Hadrian's Wall and elsewhere; on the second may be consulted a learned treatise by Padre L. Bruzza ("Iscrizioni dei marmi grezzi," in the *Annali dell' Instituto archeologico*, vol. xlii., 1870, p. 106-204). Of a kindred character are the inscriptions, mostly stamped or engraved in the mould, of pigs of silver, bronze, and lead (and pewter), found in the Roman mines in Spain and England (see Hübner, "Römische Bleigruben in Britannien," in *Rheinisches Museum für Philologie*, vol. xi., 1857, p. 347 sq., and *C. I. L.*, vii. p. 220 sq.; A. Way, *Archæological Journal*, vol. xvi., 1859, p. 23, and vol. xxiii., 1866, p. 63). A fourth species of *tituli* of this class is strictly related to the military institutions of the Roman empire. Many of the weapons are marked with the names of the bearer and of the military corps to which he belonged,—so, for example, the buckles of their shields (see Hübner, "Römische Schildbuckel," in *Archäologisch-epigraphische Mittheilungen aus Oesterreich*, vol. ii., 1878, p. 105 sq.; by far the best extant specimen is the umbo of a legionary soldier of the eighth legion found in the Tyne near South Shields, *C. I. L.*, vii. 495), and sometimes the swords, as that of Tiberius from Mainz (now in the British Museum, see *Bonner Winkelmannsprogramm* of 1848). The leaden *glandes* used by the *funditores*, the slingers, in the Roman army bear curious historical inscriptions (see *C. I. L.*, i. 642 sq., and, on the question

of the authenticity of many of them, much discussed of late, Bergk, *Bonner Jahrbücher*, vols. lv., lvi., 1875, p. 1 sq., and Zangemeister, *Monatsberichte der Berliner Akademie der Wissenschaften*, 1875, p. 465, 1876, p. 65 sq.; *Bullettino dell' Instituto archeologico*, 1877, p. 172, 1879, p. 190 sq.). Special mention must be made also of the leaden seals or marks, evidently of military origin (perhaps to be borne by the soldiers as a countersign), which have been found in many parts of England, but nowhere else as yet (*C. I. L.*, vii. 1269; *Ephem. epigr.*, iii. p. 144, 318, iv. p. 209). Of the highest interest are the manifold productions of the Roman tile and brick kilns. Next to the tiles with consular dates made at Veveis (*C. I. L.*, i. 777 foll.), those signed with the name of legions or other military corps, and employed in the various military buildings of these, are especially worthy of mention; they form an important chapter in every geographical part of the *Corpus*. But private persons, too, especially the rich landed proprietors, and afterwards the emperors and their kinsmen, kept large *figlinae*, and their manufactures—tiles of every description and other earthenware—were spread over the Roman empire. The different sorts of earthen vessels and lamps, the fragments of which are found in great quantities wherever Roman settlements occurred, are arranged at the end of each volume of the *Corpus*. But a scientific inquiry into their origin, age, and employment, difficult on account of the enormous and always increasing mass of the extant remains, has not yet been undertaken, the small works of Froehner (*Inscriptiones terræ coctæ vasorum*, Göttingen, 1858) and Schürmann (*Sigles figulines*, Brussels, 1867) being by no means satisfactory. On Roman lamps and their inscriptions the accurate catalogue of the Vienna collection by Kenner ("Die antiken Thonlampen des K. K. Münz- und Antiken-Cabinetes und der K. K. Ambraser Sammlung," in the *Archiv für Kunde österreichischer Geschichtsquellen*, vol. xx., Vienna, 1858) may be consulted with advantage. But a good beginning to a thorough treatment of the question has been made by an accurate exploration of the chief deposit of those fragments, the *Monte testaccio* at Rome, by Dressel ("Ricerche sul Monte testaccio," in the *Annali dell' Instituto archeologico*, vol. i., 1878, p. 118-192). Inscriptions are found on various classes of vessels, painted (as the consular dates on the large *dolia* for wine oil, &c., see Schöne *C. I. L.*, iv. p. 171 sq., and *Ephem. epigr.*, i. p. 160 sq.), stamped on the clay when still wet or in the mould, and scratched in the clay when dry, like those on the walls of ancient buildings in Pompeii, Rome, and other places of antiquity. Like the corresponding Greek ware, they contain chiefly names of the makers or the merchants or the owners, and can be treated in a satisfactory manner only when brought together in one large collection, inasmuch as, besides being made in many local potteries, they were exported principally from some places in Italy (e.g., Arezzo) and Spain, in nearly every direction throughout northern and western Europe, the countries outside the Roman frontiers not excluded. Vessels and utensils of glass and of metal (gold, silver, and especially bronze) were also exported from Italy on a large scale, as is being more and more readily recognized even by those antiquaries who formerly were wont to assume a local origin for all bronze finds made in the north of Europe. These utensils, ornaments, and other objects made of precious metals (such as cups, spoons, mirrors, *fibulae*, rings, gems), not unfrequently bear Latin inscriptions. On the very ancient silver and bronze caskets, for holding valuable articles of the female toilet, which have been found at Preneste, are inscribed, in addition to the names of the artist and of the donor, occurring once, the names of the persons in the mythical representations engraved upon them (*C. I. L.*, i. 54-60, 1500, 1501; Jordan, *Kritische Beiträge zur Geschichte der lateinischen Sprache*, Berlin, 1879, p. 3 sq.). In the ancient well of the *Aqua Apollinaria*, near Vicarello in Tuscany, three silver cups have been found with circumstantial itineraries ("a Gades (sic) usque Romam" engraved upon them, evidently gifts to the divinity of the bath for recovered health presented by travellers from the remote city named (Henzen 5210). Similar is the Rudge Cup, found in Wiltshire and preserved at Alnwick Castle, which contains, engraved in bronze, an itinerary along some Roman stations in the north of England (*C. I. L.*, vii. 1291). The inscriptions of the Hildesheim silver find and others of a similar character have been already mentioned; and many examples might be enumerated besides. On the ancient glass ware and the inscriptions on it the splendid works of Deville (*Histoire de l'art de la verrerie dans l'antiquité*, Paris, 1873) and Froehner (*La verrerie antique, description de la collection Charvet*, Paris, 1879) may be consulted; on the Christian glasses that of Garrucci (*I vetri ornati di figure in oro trovati nei cimiteri dei cristiani primitivi di Roma*, Rome, 1858). The last species of *tituli* is formed by the stamps themselves with which the inscriptions on many of the objects already named are produced. They are mostly of bronze, and contain names; but it is not easy to say what sort of objects were marked with them, as scarcely any article stamped with a still existing stamp has been found. Amongst the materials stamped leather also is to be mentioned. One class only of stamps differs widely from the rest,—the oculists' stamps, engraved mostly on steatite



(or similar stones), and containing remedies against diseases of the eyes, to be stamped on the glass bowls in which such remedies were sold, or on the medicaments themselves (see Grotefend, *Die Stempel der römischen Augenärzte gesammelt und erklärt*, Göttingen, 1867; since its publication many new examples have come to light).

IV. The other great class of inscriptions above referred to, the *instrumenta* or *leges*, the laws, deeds, &c., preserved generally on metal and stone, from the nature of the case have to be considered chiefly with regard to their contents; their form is not regulated by such constant rules as that of the *tituli*, so far as may be inferred from the state of completeness in which they have been preserved. The rules for each special class therefore, though, generally speaking, maintained—as was to be expected of Roman institutions—with remarkable steadiness from the earliest times down to a late period, must be based upon a comprehensive view of all the examples, including those preserved by ancient writers, and not in the monumental form. These documents are, as a rule, incised on bronze plates (only some private acts are preserved on wood and lead), and therefore have their peculiar form of writing, abbreviation, interpunction, &c., as has been already explained. A complete collection of these monuments, although projected by many workers in the field of Roman jurisprudence from Antoninus Augustinus downwards, has not yet been made. The older Roman laws are now collected, in trustworthy texts, in the *Corpus*, vol. i.; of the documents belonging to the later period a very comprehensive though not quite complete *sylloge* is given in the late lamented C. G. Bruns's *Fontes juris Romani antiqui* (Tübingen, 4th ed., 1879).

1. Among the earliest occasions for committing to writing agreements, which may be supposed to have been originally verbal only, must certainly be reckoned international transactions (*leges fœderis* or *fœdera*). At the head of the prose records written in the Latin language we find the treaties of alliance of Tullus Hostilius with the Sabini (Dionysius Halic., iii. 33), of Servius Tullius with the Latini (Dionysius, iv. 26; Festus, p. 169; this was, partly, at the same time, as will afterwards appear, the oldest document of the sacred class), of the second Tarquinius with Gabii (Dionysius, iv. 58. Festus, *epit.*, p. 56). They are followed, in the oldest republican period, by the celebrated *fœdera* with Carthage, so much discussed of late; by the pacts of Sp. Cassius Vecellinus with the Latini of the year 261 (493 n. c.), which Cicero seems to have seen still in the *forum* behind the *rostra*, written on a bronze column (*Pro Balbo*, 23, 53; see also Livy, ii. 23; Festus, p. 166; and Mommsen's *Römische Forschungen*, ii. p. 153 sq.); and by the *fœdus Ardicatum* of 310 (444 n. c.) mentioned by Livy (iv. 7). Of all these documents nothing has been preserved in an authentic form, save some few words quoted from them by the ancient grammarians. Of one *fœdus* only is there a fragment still in existence, relating to the Oscan civitas *libera Bantia* (*C. I. L.*, i. 197); it was drawn up between 621 and 631 (133 and 123 B. C.), and contains the *clausula* of the *fœdus*, which was written in Latin and in Oscan. On account of this peculiar circumstance, the document gave occasion to Klenze, and afterwards to Mommsen, to resume (for the sake of Roman jurisprudence, in the first instance) inquiry into the Oscan and other Italian dialects. Some other Roman *fœdera* are preserved only in Greek, *e. g.*, that with the Jews of the year 594 (160 B. C.) (Josephus, *Ant.*, xii. 6, 10). Some others, made with the same nation between 610 and 615 (144 and 139 B. C.) (Jos., *Ant.*, xiii. 6, 6 and 7, 8), are mentioned in an abridged form only (see Mendelssohn, "Senati consulta Romanorum que sunt in Josephi antiquitatibus," &c., in the *Acta Societ. Philol. Lips.*, vol. v., 1875, p. 87 sq., and compare *Rheinisches Museum für Philologie*, vol. xxx., 1875, p. 118 sq., xxxii., 1877, p. 249; Ritschl's *Opuscula*, vol. v. p. 99 sq.; Mommsen, *Hermes*, vol. ix., 1874, p. 281 sq.; Niese, *Hermes*, vol. xi., 1876, p. 466 sq.), or given in that of a *senatus consultum*, to which they must formally be ascribed. Amongst the *fœdera* may be reckoned also the curious oath, sworn, perhaps, according to a general rule obtaining for all *civitates federate*, by the citizens of a Lusitanian *oppidum*, Arithum, to Gaius Cæsar on his accession to the throne in A. D. 37 (*C. I. L.*, ii. 172; Wil. 2839).

Closely related to the *fœdera* are the pacts between communities and private individuals, respecting *patronatus* or *hospitium* (*tabula patronatus et hospitii*, also, when in small portable form, *tesseze hospites*), of which many specimens from the end of the republic down to a late period of the empire have been preserved (see Gazzera, *Memorie dell' Accademia di Torino*, vol. xxxv., 1831, p. 1 sq., and Mommsen, *Römische Forschungen*, i. p. 341 sq.). There is at present no complete collection of these; for since Gazzera's time many new ones have been found. Of the numerous examples scattered through the different volumes of the *Corpus* may be quoted the *tesseza Fundana*, containing the pact of hospitality between the community of Fundi and a certain Ti. Claudius (who cannot, with certainty, be identified), the oldest hitherto known, in the form of a bronze fish (*C. I. L.*, i. 532; Henz., 7000; Wil. 2849); the *tabula* of the *pagus Gurgensium* in Africa, delivering the patronate to L. Domitius Ahenobarbus, Nero's

grandfather, in 742 (12 B. C.), in the afterwards solemn form of a *tabella fastigata*, to be fixed in the *atrium* of the person honoured (*C. I.*, 3693; Wil. 2850); that of the *civitas Palanlina* with a *peregrini*, named *Acces Licirni* of the year 752 (2 B. C.) (*Ephem. epigr.*, i. 141; *Hermes*, v., 1871, p. 371 sq.); that of *Lacituba*, in Spain, with one Q. Marius Balbus, of 5 A. D. (*C. I. L.*, ii. 1393); that of the *Bocchoritani* on the island of Majorca, of 6 A. D. (*C. I. L.*, ii. 2695; Wil. 2851); the four relating to C. Silius Aviola, dating from 27 to 28 A. D., all found at Brescia (*C. I. L.*, v. 4919-4922); that of the *colonia Julia Ang. legionis vii. Tapyssætu*, in Africa, with the imperial legate Q. Julius Secundus, of 55 A. D. (*C. I. L.*, viii. 8837; Wil. 2851); that of two *gentilitates*, the *Desonici* and *Tridiavi*, of the *gens* of the *Zælex*, in Spain, now in the Museum of Berlin, which contains an older act of the year 27, and another more recent of the year 127 A. D. (*C. I. L.*, ii. 2633; Orel. 156); that of the *respublica Pompeionensis* (Pampluna in Spain) of 185 A. D. (*C. I. L.*, ii. 2960; Wil. 2854); that of the *Segisamonenses*, in Spain, of 239 A. D., now in the museum at Burgos (*Ephem. epigr.*, ii. 322); that of the *fabri subidiavi* (*i. e.*, subediavi, qui sub ade consistunt) of Coriotra, of 348 A. D. (*C. I. L.*, ii. 2911; Wil. 2861); and, in addition to many others, those found together at Rome, on the site of the palace of Q. Aradius Valerius Proculus, and belonging to him and other members of his family, from divers African cities and executed in 321 and 322 A. D. (*C. I. L.*, vi. 1684-88; Orel. 1079, 3058).

2. Hardly inferior in antiquity, and of superior value, are the remains of laws in the stricter sense of the word (*leges* and *plebiscita*), preserved to us in the originals, although unfortunately only in fragments more or less extensive. Of those laws the oldest and most important are the *lex Acilia* (for so it is in all probability to be styled) *repetundarum* of the year 631 (*C. I. L.*, i. 198), which is incised on a bronze table about 2 metres broad, in 90 lines of about 200 to 240 letters each, and therefore extremely inconvenient to read, and the *lex agraria* of 643 (111 B. C.), written on the reverse of the table of the *Acilia*, abrogated shortly afterwards (*C. I. L.*, i. 200); this is the third of the celebrated laws of C. Gracchus bearing upon the division of public lands. Then follow the *lex Cornelia de cunctis quæstoribus*, a fragment of Sulla's legislation, the eighth table only, of the whole set, being preserved (*C. I. L.*, i. 202); the *plebiscitum de Thermesibus*, on the autonomy of Thermessus in Pisidia, proposed by the *tribuni plebis*, in 682 (72 B. C.), one of four or five large bronze plates (*C. I. L.*, i. 204); the *lex Rubria de civitate Gullizæ cisalpinæ* of 705 (49 B. C.), written in a new and more convenient form (belonging as it does to Cæsar's legislation), in two columns, with numbered divisions, being the fourth out of an unknown number of plates (*C. I. L.*, i. 205); the *lex Julia municipalis*, or, from the place where it was found, the *tabula Heracleensis* of 709 (45 B. C.), written on the reverse of the much older Greek law of that community, preserved partly at Naples, partly in the British Museum (*C. I. L.*, i. 206), also a fragment of Cæsar's general municipal institutions; it contains a curious passage relating to the public promulgation of laws (v. 15). These are the laws of the Roman republic preserved in important fragments; some minor ones (brought together in *C. I. L.*, i. 207-211) may be left out of account here. In the imperial age, laws in general were replaced by *senatus consulta*, or by imperial decrees. It was also in the form of a *senatus consultum* that the *leges de imperio*, on the accession of the emperors, seem to have been promulgated. An example of such a law, preserved in part on a bronze tablet found at Rome, is the *lex de imperio Vespasiani* (*C. I. L.*, vi. 930; Orel. vol. i. p. 567). There is, besides, one special category of imperial constitutions which continued to be named *leges*, *viz.*, the constitutions given by the emperors to the divers classes of *civitates*, based upon the ancient traditional rules of government applied to Rome itself as well as to the *coloniæ* and *municipia*. Of this sort of *leges* some very valuable specimens have come from Spanish soil, *viz.*, the *lex coloniæ Julizæ Genetivæ Urbanorum sive Ursonis* (now Osuna), given to that colony by Cæsar in 710 (44 B. C.), but incised, with some alterations, in the time of Vespasian, of which three bronze tables out of a much larger number remain (Hübner and Mommsen, *Ephem. epigr.*, ii. p. 150 sq. and 221 sq.); the *lex Salpentina* and the *lex Malacitana*, given to these two *municipia* by Domitian, between 81 and 84 A. D., each on a large bronze plate, written respectively in two and in five columns, with the single chapters numbered and rubricated (*C. I. L.*, ii. 1963, 1964, compare Mommsen, "Die Stadtrechte der orteinischen Gemeinden Salpensa und Malacca in der Provinz Bætica," in the *Abhandlungen der sechsichen Gesellschaft der Wissenschaften, philol.-histor. Classe*, vol. iii., 1857, p. 363 sq.); the *lex metalli Vipsæensis*, given, with all probability, by one of the three Flavii, as a constitution to a mining district of southern Portugal, one bronze plate numbered iii.—three or more, therefore, being lost (see Hübner, *Ephem. epigr.*, iii. p. 165 sq. and, for a popular account, the *Deutsche Rundschau*, August 1877, p. 196 sq.). The so-called military diplomas, although in certain respects nearly related to the *leges* of the later period, are better placed along with the imperial decrees.



8. A third species of official documents is formed by decrees of the senate of Rome, of the analogous corporations in the *coloniae* and *municipia*, and of the divers *collegia* and *sodalicia*, constituted, as a rule, after a similar fashion and debating in nearly the same way as the Roman and the municipal senates. The oldest Roman *senatus consulta* are those translated into the Greek language and containing treaties of alliance, as already mentioned. They are preserved either on monuments or by ancient authors, as Josephus:—*e.g.*, the fragment found at Delphi, from the year 568 (186 B.C.), and the *sc. Thisbeum*, from Thisbe in Beotia, 584 (170 B.C.) (*Ephem. epigr.*, i. p. 278 sq., ii. p. 102, and Joh. Schmidt, *Zeitschrift der Savigny-Stiftung*, vol. iii., 1881), those of 616, 619, 621, 649 (138–105 B.C.) (*C. I. Græc.*, 2905, 2908, ii. 2485, 2737; Le Bas and Waddington, vol. iii. p. 195–198; *Annali dell' Istituto*, vol. xix., 1847, p. 113; *Ephem. epigr.*, iv. p. 213 sq.), and those relating to the Jews, dating from 615, 621, and 710 (139, 133, and 44 B.C.) (Josephus, *Ant.*, xii. 9, 2, xiv. 8, 5 and 10, 9). The two oldest *senatus consulta* written in Latin are also preserved in a more or less complete form only by ancient authors; they are the *sc. de philosophis et rhetoribus* of 593 (161 B.C.) (Gellius, *Noct. Att.*, xv. 11. 1) and that *de hostis Martii* of 655 (99 B.C.) (Gellius, iv. 6, 2). The only one belonging to the oldest period preserved in the original Latin form, of which only a part exists, together with the Greek translation, is the *sc. Lutatianum*, relating to Asclepiades of Clazomenæ and his companions, dating from 676 (77 B.C.) (*C. I. L.*, i. 203). The rest, belonging to the later epoch from Cicero downwards, about twenty in number, are mostly preserved only in an abridged form by ancient writers,—such as Cicero, Frontinus, Macrobius,—or in Justinian's *Digesta* (see Hübner, *De senatus populique Romani actis*, Leipsic, 1859, p. 66 sq.); a few exist, however, in a monumental form, complete or in fragments—as the two *sc.* on the *ludi sæculares*, dating from 17 B.C. and 47 A.D., preserved on a marble slab found at Rome (*C. I. L.*, vi. 877); the fragments of two *sc.* in honour of Germanicus and the younger Drusus, from Rome, on bronze tablets (*C. I. L.*, vi. 911–912; Henz. 5381–5282); the two *sc. Hostidianum* and *Volusianum*, containing regulations for the demolition and rebuilding of houses in Rome, incised on the same bronze plate, found at Herculaneum, dating from Nero's time, between 41 and 46 and from 56 A.D. (Orel. 3115; Mommsen, *Berichte der sächs. Gesellschaft der Wissenschaften, philol.-histor. Class.*, 1852, p. 272 sq.); and, of a later period, the *sc. Cassianum* or *Novianum* of 138 A.D., containing a market regulation for the *sallus Beguensis* in Africa, where it has been found preserved in two examples on stone slabs (*Ephem. epigr.*, ii. p. 271 sq., not complete in Wil. 2838), and the fragment of that for Cyzicus, belonging to the reign of Antoninus Pius (*Ephem. epigr.*, iii. p. 156 sq.). There exists, besides, a chapter of a *sc.*, relating to the *collegia*, inserted in the decree of a *collegium* at Lanuvium, to be mentioned below. Of the municipal decrees, of which a greater number is preserved (see Hübner, *De sen. populique Rom. actis*, p. 71 sq.), only a few of the more important may be mentioned here:—the *lex Puteolana de parieti faciundo* of 649 (105 B.C.) (*C. I. L.*, i. 577; Orel. 3697; Wil. 697); the two *decreta* (or so-called *centaphia*) *Pisana* in honour of Lucius and Gaius Cæsar, the grandsons of Augustus, of 3 A.D. (Orel. 642, 643; Wil. 883); the *decretum Lanuvianum* of 133 A.D., containing the regulations of a *collegium funeraticium*, styled *collegium salutare Dianæ et Antinoc* (Or. 6086; Wil. 319); and the *decretum Tergestinum*, belonging to the time of Antoninus Pius (*C. I. L.*, v. 532; Henz. 7167; Wil. 693). There are, however, more than thirty others preserved, some of them, such as those from Naples, written in the Greek language. Of the third speciality, the *decreta collegiorum*, only the *lex collegii aquæ* of the first century (Marini, *Atti de' fratelli Arvali*, p. 70; Rudorff and Mommsen, *Zeitschrift für Rechtsgeschichte*, vol. xv., 1850, p. 203, 345 sq.), and the *lex collegii Æsculapii et Hygiæ*, of 153 (*C. I. L.*, vi. 10234; Orel. 2417; Wil. 320) need be mentioned here; many more exist. One of them, the *lex collegii Jovis Cerveni*, dating from 167 A.D., found at Alburnum major in Dacia, is preserved on the original *tabella cerata* on which it was written (*C. I. L.*, iii. p. 924; Henz. 6087; Wil. 321).

4. The fourth species of *instrumenta* are the decrees, sometimes in the form of letters, of Roman and municipal magistrates, and of the emperors and their functionaries, incised, as a rule, on bronze tablets. The oldest decree in the Latin language which has been preserved is that of L. Æmilius Paulus, when prætor in Hispania Bætica, dating from 189 B.C., for the Turris Lascutana in southern Spain (*C. I. L.*, ii. 6041; Wil. 2837); of the same date is a Greek one of Cn. Manlius, consul of the year 565, for the Heracleenses Carie (Le Bas and Waddington, n. 588). Then follow the famous *epistula consulum* (falsely styled commonly *senatus consultum*) *ad Teuranos de bacchanalibus*, dated 568 (186 B.C.) (*C. I. L.*, i. 196); the sentence of the two Mincii, the delegates of the senate, on a dispute concerning the boundaries between the Genuates and Viturii, 117 B.C. (*C. I. L.*, i. 199; Orel. 3121; Wil. 872); and the *epistula* of the prætor L. Cornelius (perhaps Sisenna), the prætor of 676 (78 B.C.) *ad Tiburtes* (*C. I. L.*, i. 201). These belong to the republican age. From the imperial period a great many

come down to us of varying quality. Some of them are decrees or constitutions of the emperors themselves. Such are the decree of Augustus on the aqueduct of Venafrum (Henz. 6428; Wil. 784); that of Claudius, found in the Val di Nona, belonging to 46 A.D. (*C. I. L.*, v. 5050; Wil. 2842); of Vespasian for Sabora in Spain (*C. I. L.*, ii. 1423), and for the Vanacini in Corsica (Orel. 4031); of Domitian for Faleri (Orel. 3118); the epistles of Hadrian relating to Ezani in Phrygia, added to a Greek decree of Avidius Quietus (*C. I. L.*, iii. 355; Henz. 6955), and relating to Smyrna, in Greek, with a short one of Antoninus Pius, in Latin (*C. I. L.*, iii. 411; Orel. 3119); the decrees of Commodus relating to the *sallus Burenitanus* in Africa (Mommsen, *Hermes*, vol. xv., 1880, p. 358 sq.); of Severus and Caracalla for Tyra (Akerman in Mæsia), Latin and Greek (*C. I. L.*, iii. 781; Henz. 6429); of Valerian and Gallienus for Smyrna, also Latin and Greek (*C. I. L.*, iii. 412); of Diocletian *de pretiis rerum venalium*, containing a long list of prices for all kinds of merchandise, preserved in divers copies more or less complete, in Latin and Greek (*C. I. L.*, iii. p. 801 sq.; compare *Ephem. epigr.*, iv. p. 180, and, as similar monuments, the *lex portus* of Cirra, of 202 A.D., Wil. 2738, and the fragment of a regulation for the importation of wines into Rome, Henz. 5089, Wil. 2739); and some of the age of Constantine, as that relating to Hispellum in Umbria (Henz. 5580; Wil. 2843), that of Julian found at Amorgos (Henz. 6431), and some others, of which copies exist also in the juridical collections. Of two imperial rescripts of a still later age (413 A.D.), fragments of the originals, written on papyrus, have been found in Egypt (see Mommsen and Jaffé, *Jahrbuch des gemeinen deutschen Rechts*, vol. vi., 1861, p. 398; Hânel, *Corpus legum*, p. 281). Imperial decrees, granting divers privileges to soldiers, are the *diplomata militaria* also, mentioned above, incised on two combined bronze tablets in the form of *diptycha*, of which about seventy examples have been brought together in the *Corpus* (vol. iii. p. 842 sq.); some specimens are given in Wil. 2862–2869, and in the *Ephem. epigr.* (vol. ii. p. 452, and vol. iv. p. 181 sq.), belonging to nearly all emperors from Claudius down to Diocletian. Though not a decree, yet as a publication going back directly to the emperor, and as being preserved in the monumental form, the speech of the emperor Claudius, delivered in the senate, relating to the Roman citizenship of the Gauls, of which Tacitus gives an abstract (*Ann.* xi. 23), ought also to be mentioned here; it was engraved on large bronze slabs by the public authority of Lugdunum (Lyons), where a large fragment of it is still preserved (Boissien, *Inscriptions antiques de Lyon*, p. 132 sq.). Another sort of decrees, relating to a great variety of subjects, has to be mentioned, emanating not directly from the emperors, but from their functionaries. Such are the decree of the proconsul L. Helvius Agrippa, of the year 68 A.D., on the boundaries of some tribes on the island of Sardinia (Wil. 872 a); that of the prefect of Egypt, Tiberius Julius Alexander, written in Greek, of the same year (*C. I. Græc.*, 4957); that of C. Helvidius Priscus, on a similar question relating to Histonium, belonging perhaps to the end of the first century (Wil. 873); that of the legate of Trajan, C. Avidius Quietus, one of the friends of Plutarch, found at Delphi, in Greek and Latin (*C. I. L.*, iii. 567; Orel. 3671; Wil. 874); a rescript of Claudius Quartinus, perhaps the imperial legate of the Tarraconensis, of the year 119 A.D., found at Pampluna (*C. I. L.*, ii. 2959; Orel. 4032); the epistle of the *præfecti prætorio* to the magistrates of Sæpium, of about 166–169 A.D. (Mommsen, *I.N.*, 4916; Wil. 2841); the decree of L. Novius Rufus, another legate of the Tarraconensis, who *ex tertia recitavit*, of 193 A.D. (*C. I. L.*, ii. 4125; Orel. 897; Wil. 876); and the sentence of Alfeius Senecio, then subprefect of the *classis prætoria Misensis*, belonging to the beginning of the third century, formerly existing at Naples (Mommsen, *I.N.*, 2646); and some others of the fourth and fifth centuries, not requiring specific mention here. Quite a collection of epistles of high Roman functionaries is found in the celebrated inscription of Thorigny (Mommsen, *Berichte der sächs. Gesellschaft der Wissenschaften*, 1862, p. 235 sq.). The letter of a provincial functionary, a priest of Gallia Narbonensis, to the *fabri subædiani* of Narbonne, of the year 149, may also be mentioned (Henz. 7215; Wil. 696a). To these must be added the *tabula alimentaria*, relating to the well-known provision made by Trajan for the relief of distress among his subjects, such as that of the Ligure Bæbiani (Mommsen, *I.N.*, 1354; Wil. 2844) and that of Veleia near Parma (Wil. 2845); while evidence of similar institutions is furnished by inscriptions at Tarracina, at Sicca in Africa, and at Hispalis in Spain (Wil. 2846–48; *C. I. L.*, ii. 1174). At the close of this long list of official documents may be mentioned the *libellus* of the *procurator operum publicorum a columna divi Marci* of the year 193 (*C. I. L.*, vi. 1685; Orel. 39; Wil. 2840) and the *interlocutions* of the *præfecti vigillum* on a lawsuit of the *fullones* of Rome, of 244 A.D., inscribed on an altar of Hercules (*C. I. L.*, vi. 266; Wil. 100). These documents form a most instructive class of *instrumenta*.

5. Many documents, as may be supposed, were connected with religious worship, public and private. The oldest *lex templi*, which continued in force until a comparatively late period, was the regulation made by Servius Tullius to the temple of Diana on the



Aventine, after the conclusion of the federal pact with the Latini, noticed above. Mention is made of this ancient law as still in force in two later documents of a similar character; viz., the dedication of an altar to Augustus by the plebs of Narbo in southern France, of 764 A.D., but existing only, at Narbonne, in a copy, made perhaps in the 2d century (Orel. 2489; Wil. 104), and that of an altar of Jupiter, dedicated at Salona in Dalmatia in 137 A.D., still existing in part at Padua (*C. I. L.*, iii. 1933; Orel. 2490; Wil. 163). Another *lex fœderis* still existing is that of a temple of Jupiter Liber at Furfo, a vicus of southern Italy, of the year 696 (58 B.C.), but copied, in vernacular language, from an older original (*C. I. L.*, i. 603; Orel. 2488; Wil. 105; compare Jordan in *Hermes*, vol. vii., 1872, p. 201 sq.). The lists of objects belonging to some sanctuaries or to the ornaments of statues are curious, such as those of the *Diana Nemorensis* at Nemi (Henz., *Hermes*, vol. vi., 1871, p. 8 sq.), and of a statue of Isis in Spain (Hübner, *Hermes*, vol. i., 1866, p. 345 sq.; compare *C. I. L.*, ii. 2060, 3386, Orel. 2510, Wil. 210), and two *synopses* from a temple at Cirta in Africa (Wil. 2736, 2737). The *sortes* given by divinities may also be mentioned (see *C. I. L.*, i. p. 267 sq.; Wil. 2822). To a temple also, though in itself of a secular character, belonged a monument of the highest historical importance, viz., the *Index rerum a se gestarum*, incised on bronze slabs, copies of which Augustus ordered to be placed, in Latin and Greek, where required, in the numerous Augustæ erected to himself in company with the Dea Kona. This is known as the *Monumentum Ancyranum*, because it is at Angora in Asia Minor that the best preserved copy of it, in Greek and Latin, exists; but fragments remain of other copies from other localities (see *C. I. L.*, iii. p. 779 sq., and the special editions of Mommsen, Berlin, 1865, and Bergk, Göttingen, 1873). Among the inscriptions relating to sacred buildings must also be reckoned the numerous fragments of Roman calendars, or *fasti anni Juliani*, found at Rome and other places, which have been arranged and fully explained by Mommsen (*C. I. L.*, i. p. 293 sq.; compare *Ephem. epigr.*, i. p. 33, ii. p. 93, iii. p. 5, 85, iv. p. 1 sq., and for those found in Rome, *C. I. L.*, vi. 2294-2306). Local, provincial, or municipal *kalendaria* have likewise been found (as the *feriale Cumanum*, *C. I. L.*, i. p. 310, and the *Capuanum*, Mommsen, *I. N.*, 3571). Many other large monumental inscriptions bear some relation, more or less strict, to sacred or public buildings. Along with the official calendar exhibited on the walls of the residence of the *pontifex maximus*, the list of the eponymous magistrates, inscribed by the order of Augustus on large marble slabs, was publicly shown,—the *fasti consulares*, the reconstruction and illustration of which formed the life-work of Borghesi. These have been collected, down to the death of Augustus, by Henzen, and compared with the additional written testimonies, by Mommsen, in the *Corpus* (vol. i. p. 293 sq.; see also *Ephem. epigr.*, i. p. 154, ii. p. 210, 285, iii. p. 11 sq.; compare Hirschfeld and Mommsen in *Hermes*, vol. iii., 1874, pp. 93, 267 sq.), along with the *acta triumphorum* and other minor fragments of *fasti* found in various Italian communities (*C. I. L.*, i. p. 453 sq.; *Ephem. epigr.*, i. p. 157, iii. p. 16), while the *fasti sacerdotum publicorum populi Romani*, together with the *tabula feriarum Lalinarum*, are given in the volume devoted exclusively to the monuments of Rome (vol. vi. p. 441 sq.; compare *Hermes*, vol. v., 1870, p. 379, and *Ephem. epigr.*, ii. p. 93, iii. pp. 74, 205 sq.). Documents of the same kind, as, for example, the *album ordinis Thamugadensis* from Africa (*Ephem. epigr.*, iii. p. 77 sq.), and a considerable mass of military lists (*litterulae*, of which those belonging to the garrison of the metropolis are brought together in *C. I. L.*, vi. p. 651 sq.), are given on many dedicatory and honorary monuments, chiefly from Lambesis in Africa (*C. I. L.*, viii.). As those documents, though having only a partial claim to be ranked with the sacred ones, derive, like many other dedicatory monuments, their origin and form from that class, so also the protocols (*acta*), which, from Augustus downwards, seem to have been preserved in the case of all important *collegia magistratuum*, now survive only from one of the largest and most distinguished *collegia sacerdotum*, in the *acta collegii fratrum Arvalium*, to which Marini first drew the attention of epigraphists; they form one of the most important masses of epigraphic monuments preserved to us in the Latin language (see *C. I. L.*, vi. p. 459 sq., *Ephem. epigr.*, ii. p. 211 sq., and Henzen's *Acta fratrum Arvalium*, Berlin, 1874).

6. Another species of instruments is formed by private documents. They have been incidentally preserved (inserted, for instance, into sepulchral and honorary inscriptions), in the later period not unfrequently in monumental form, as the testaments, given partly or in full, mentioned above (viz., that of Dasumius and the Gaul, *C. I. L.*, vi. 10229, Wil. 314, 315, and some *capita testamentorum* or *codicilli*, as that of M. Meconius Leo found at Petelia—Mommsen, *I. N.*, 78, 79; Orel. 3677, 3678; Wil. 696), and the donations, such as those of T. Flavius Syntrophus (*C. I. L.*, vi. 10239; Wil. 313), of T. Flavius Artemidorus (Wil. 310), of Stata Irene and Julia Monime (*C. I. L.*, vi. 10231, 10247; Wil. 311, 318). Of a peculiar description is the *paetum fiducie*, found in Spain, engraved on a bronze tablet, and belonging, in all probability, to the 1st century (*C. I. L.*, ii. 5042), which seems to be a formulary. Other

documents relating to private affairs exist in their original form, written on *tabellæ ceruleæ*. Those found together in a mining district of Dacia have been arranged and explained by Mommsen and Zangemeister (*C. I. L.*, iii. p. 291 sq., with facsimiles); those found at Pompeii in 1875, containing receipts of the banker L. Cæcilius Jucundus, have been published by De Petra ("Le tavolette cerate di Pompei," *Atti dell' Accademia de' Lincei*, vol. iii., 1876) and explained by Mommsen (*Hermes*, vol. xii., 1877, p. 88 sq.). These documents are written in cursive letters; and so mostly, too, are some other curious private monuments, belonging partly to the sacred inscriptions,—the *defixiones*, imprecations directed against persons suspected of theft or other offences, who, according to a very ancient superstition, were in this way believed to be delivered to punishment through the god to whom the *defixio* was directed. The numerous Greek and Latin (and even Oscan) examples of this usage have been brought together by Wachsmuth (*Rheinisches Museum*, vol. xviii., 1863, p. 559 sq.; Henz., *Bullettino dell' Istituto*, 1866, p. 252; compare *C. I. L.*, i. 818-820, *C. I. L.*, vii. 140). Only a few of them are incised on stone (as that to the *Dea Ataccina* from Spain, *C. I. L.*, ii. 462); for the most part they are written, in cursive letters, or in very debased capitals, on small bronze or lead tablets (so *C. I. L.*, i. 818, 819; Henz. 6114, 6115; Wil. 2747, 2748), to be laid in the tombs of the "defixi," or deposited in the sanctuaries of some divinity. Some new specimens of this class have been lately added from Pavia and Arezzo in Italy (Mommsen, *Hermes*, vol. iii., 1868, p. 302, and vol. iv., 1869, p. 282 sq.; Wil. 2749, 2753, 2754); one was lately found at Bath (Zangemeister, *Hermes*, vol. xv., 1880, p. 588 sq.).

7. Many of the private documents just alluded to have not a monumental character similar to that of the other inscriptions in the wider sense of the word, as they are written on materials not very durable, such as wood and lead,—in the majority of cases, in cursive characters; but, nevertheless, they cannot be classed as literature. As a last species, therefore, of *instrumenta*, there remain some documents, public and private, which similarly lack the strict monumental character, but still are to be reckoned among inscriptions. These are the inscriptions painted or scratched on the walls of the buildings of ancient towns, like Pompeii, where, as was to be expected, most of them have been preserved, those from other ancient cities buried by the eruptions of Vesuvius and from Rome being very small in number. All the various classes of these inscriptions—public and private advertisements, citations for the municipal elections, and private scribbles of the most diverse (and sometimes most indecent) character, once partly collected by Chr. Wordsworth (*Inscriptiones Pompeianæ*, &c., London, 1837, 1846)—are now arranged by Zangemeister in the *Corpus*, vol. iv. (see also *Ephem. epigr.*, i. pp. 49, 177 sq., and some specimens in Wil. 1951 sq.), whence their peculiar paleographic and epigraphic rules may be learned. And, lastly, as related to some of these advertisements, though widely differing from them in age and character, may be mentioned the so-called *diptycha consularia*, monuments, in the first instance, of the still very respectable skill in this branch of sculpture to be found at this late period. They are, as is generally known, carved-ivory tablets, in the form of *pugillarum*, and seem to have been invitations to the solemnities connected with the accession of high magistrates, especially to the spectacles of the circus and amphitheatre; for they contain, along with representations of such spectacles, the names, and often the portraits, of high functionaries, mostly of the 5th and 6th centuries. Since Gori's well-known work on this class of monuments (*Thesaurus veterum diptychorum*, &c., 3 vols., Florence, 1759) no comprehensive collection of them has been published; as specimens see *C. I. L.*, ii. 2699, and v. 8120, 1-9.

*Bibliography.*—There is no "Textbook" of Roman epigraphy which can be recommended to the student. Brissonius, in his work *De formulis et solemnibus populi Romani verbis libri VIII.* (first published at Paris, 1583; edited, with additions by Conradi and Bach, at Frankfurt and Leipsic, 1754), gives some useful information about the *instrumenta*; Maffei, in his *Ars critica lapidaria* (published, after his death, in Donati's *Supplementum* to Muratori, 1765), goes too far in his suspicions about forgeries; Morelli's *Tricon epigraphicum* (in his *Opera epigraphica*, 5 vols., Padua, 1819) is made for use in the composition of modern Latin inscriptions. Zaccaria's *Istituzione antiquaria-lapidaria ossia introduzione allo studio delle antiche latine iscrizioni* (Rome, 1770, and Venice, 1793) has its merits, though it is somewhat antiquated, and is, besides, a rather scarce book. But students must be warned against Zell's *Handbuch der römischen Epigraphik* (2 vols., Heidelberg, 1850-1852), which is a work in every respect thoroughly unsatisfactory. For Christian inscriptions De Blant's *Manuel d'épigraphie chrétienne d'après les marbres de la Gaule* (Paris, 1869), on which the article in Martigny's *Dictionnaire des antiquités chrétiennes* (2d ed., Paris, 1877, p. 357 sq.) is based, and that in Smith and Cheetham's *Dictionary of Christian Antiquities* (vol. i., London, 1875, p. 841 sq.), may be consulted with advantage. (E. H.)



**INSECTIVOROUS PLANTS.** Insectivorous or, as they are sometimes more correctly termed, carnivorous plants are, like the parasites, the climbers, or the succulents, a physiological assemblage belonging to a number of distinct natural orders. They agree in the extraordinary habit of adding to the supplies of nitrogenous material afforded them in common with other plants by the soil and atmosphere, by the capture and consumption of insects and other small animals. The curious and varied mechanical arrangements by which these supplies of animal food are obtained, the ways and degrees in which they are utilized, and the remarkable chemical, histological, and electrical phenomena which accompany these processes of prehension and utilization, can only be understood by a separate and somewhat detailed examination of the leading orders and genera. It is convenient to follow the order adopted by Mr Darwin in his work on *Insectivorous Plants* (Lond., 1875), to which our knowledge of the subject is mainly due, incorporating, however, as far as possible the leading observations of other writers on the subject. We must preface this, however, by a brief summary of the facts of taxonomy and distribution.

**Taxonomy.**—The best known and most important order—the *Droseraceæ*—is placed among the calycifloral exogens, and has obvious affinities with the *Saxifragaceæ*. It includes six genera—*Byblis*, *Roridula*, *Drosera*, *Drosophyllum*, *Aldrovanda*, and *Dionæa*, of which the last three are monotypic, *i.e.*, include only one species. The curious pitcher-plant, *Cephalotus follicularis*, is usually raised to the dignity of a separate natural order *Cephaloteæ*, though Bentham and Hooker (*Gen. Plant.*) place it among the *Ribesaceæ*. The *Sarraceniaceæ* are thalamiflorals, and contain the genera *Sarracenia*, *Darlingtonia*, *Heliamphora*, while the true pitcher plants or *Nepenthaceæ*, consisting of the single large genus *Nepenthes*, are placed near the *Aristolochiaceæ* among the *Apetalæ*. Finally the genera *Pinguicula*, *Utricularia*, *Genlisea*, and *Polypompholix* belong to the gamopetalous order *Utriculariæ*. Thus all the four leading divisions of the exogenous plants are represented by apparently unrelated orders; certain affinities, however, are alleged between *Droseraceæ*, *Sarraceniaceæ*, and *Nepenthaceæ*.

**Distribution.**—While the large genus *Drosera* has an all but world-wide distribution, its congeners are restricted to well-defined and usually comparatively small areas. Thus *Drosophyllum* occurs only in Portugal and Morocco, *Byblis* in tropical Australia, and, although *Aldrovanda* is found in Queensland, in Bengal, and in Europe, a wide distribution explained by its aquatic habit, *Dionæa* is restricted to a few localities in North and South Carolina, mainly around Wilmington. *Cephalotus* occurs only near Albany in Western Australia, *Heliamphora* on the Roraima Mountains in Venezuela, *Darlingtonia* on the Sierra Nevada of California, and these three

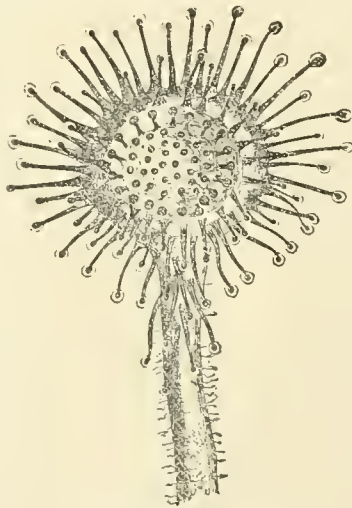

FIG. 1.—Leaf of Sundew (*Drosera rotundifolia*).  $\times 4$ . (After Darwin.)

genera too are as yet monotypic; of *Sarracenia*, however, there are six or eight known species scattered over the eastern States of North America. The 36 species of *Nepenthes* are mostly natives of the hotter parts of the Indian Archipelago, but a few range into Ceylon, Bengal, Cochin China, and some even occur in tropical Australia on the one hand, and in the Seychelles and Madagascar on the other. *Pinguicula* is abundant in the north temperate zone, and ranges down the Andes as far as Patagonia; the 150 species of *Utricularia* are mostly aquatic, and some are found in all save polar regions; their unimportant congeners, *Genlisea* and *Polypompholix*, occur in tropical America and south-western Australia respectively. It is remarkable that all the insectivorous plants agree in inhabiting damp heaths, bogs, marshes, and similar situations where water is abundant,—a peculiarity perhaps due to their habit of copious secretion and consequent need of water.

**Drosera.**—The Common Sundew (*D. rotundifolia*) has extremely small roots, and bears five or six radical leaves horizontally extended in a rosette around the flowerstalk. The upper surface of each leaf is covered with gland-bearing filaments or “tentacles,” of which there are on an average about two hundred. Each gland is surrounded by a large dew-like drop of a viscid but transparent and glittering secretion, and the popular names (Sundew, French *Rosolis*, German *Sonnenhau*) as well as the Linnæan (from *δρόσος*, dew) have been thus suggested. The stalk of the tentacle has the essential structure of a leaf. A small fibro-vascular bundle, consisting mainly of spiral vessels, runs up through the stalk and is surrounded by a

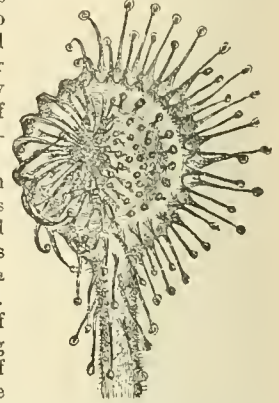

FIG. 2.—Leaf of Sundew, enlarged, with the tentacles on one side inflected over a bit of meat placed on the disk. (After Darwin.)

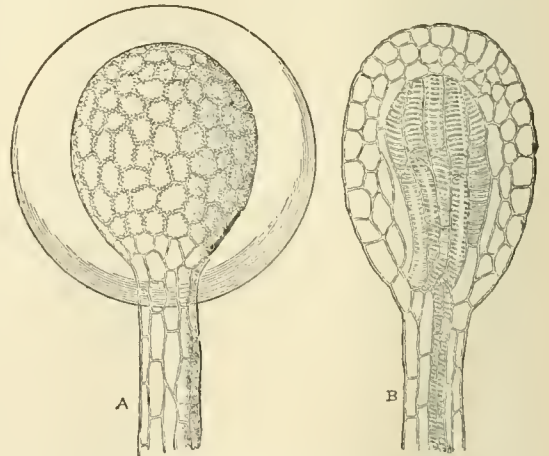

FIG. 3.—Glands of Sundew magnified. (After Dodel-Port.) A, external aspect with drop of secretion; B, internal structure.

layer of elongated parenchyma cells lined by a thin layer of colourless circulating protoplasm, and filled with a homogeneous fluid, tinted purple by a modification of chlorophyll (erythrophyll, Sorby). The epidermis bears small multicellular prominences. The glandular head of the tentacle contains a central mass of spirally thickened cells in immediate contact with the upper end of the fibro-vascular bundle. Around these (but separated from them by a

layer of much elongated cells, Warming) there is a layer of cells filled with purple fluid, and outside these lies a similar series of cells, whose contents differ slightly in tinge, and in behaviour when treated with reagents.

Insects seem to be attracted by the leaves of *Drosera*, but whether by their colour, their glittering secretion, their odour, or by all three, remains as yet unsettled. A fly alighting on the disk, or even only touching one or two of the exterior tentacles, is immediately entangled by the viscid secretion; the tentacles to which it is adhering begin to bend, and thus pass on their prey to the tentacles next succeeding them inwards, and the insect is thus carried by a curious rolling movement to the centre of the leaf. The tentacles on all sides become similarly inflected; the blade or the leaf may even become almost cup-shaped; and the insect, bathed in the abundant secretion which soon closes up its tracheae, is drowned in about a quarter of an hour. The leaves clasp also, but for a much shorter time, over inorganic bodies.

The bending of the tentacle takes place near its base, and may be excited (1) by repeated touches, although not by gusts of wind or drops of rain, thus saving the plant from much useless movement; (2) by contact with any solid, even though insoluble and of far greater minuteness than could be appreciated by our sense of touch,—a morsel of human hair weighing only  $\frac{1}{15710}$  of a grain, and this largely supported too by the viscid secretion, sufficing to induce movement; (3) by the absorption of a trace of certain fluids, mostly nitrogenous. During the inflexion of the tentacle, and even before it touches the stimulating object, the secretion of the gland increases in quantity, and, instead of remaining neutral, becomes acid.

The stalk of a tentacle whose gland has been stimulated by repeated shocks, continuous pressure, or the absorption of any nitrogenous fluid, particularly a solution of ammoniac carbonate, shows a mottled appearance; and, when examined under the microscope the formerly homogeneous fluid contents of its constituent cells are seen to have separated into purple masses of constantly varying number, shape, and size, suspended in a colourless fluid, and the layer of colourless circulating protoplasm which lines the cells thus becomes much more distinctly visible. This process, which is termed by Darwin "aggregation of the protoplasm," commences in the glands and gradually travels down the tentacles, being temporarily arrested at each cell-wall. The process of redissolution of the protoplasm commences at the base of the tentacles and proceeds upwards. Aggregation is a vital process: the cells must



FIG. 4.—Diagram of the same cell of a tentacle of *D. rotundifolia*, showing the various forms successively assumed by the aggregated masses of protoplasm. (After Darwin.)

be alive, uninjured, and oxygenated; if they are crushed or treated with carbonic acid the phenomenon does not take place. It is not necessarily related to inflexion, for one may be induced without the other; it is totally unlike the "plasmolysis," or shrinking away of the protoplasm from the cell-wall, which takes place on treating a portion of vegetable tissue with any dense fluid, and which is simply due to exosmosis; and it does not depend upon increased secretion. Darwin has also observed aggregation in the sensitive hairs of *Dionaea*, and in the roots of various plants; it seems indeed to be of wide distribution and profound importance in the physiology of the vegetable cell.

*Effects of Heat.*—Sachs asserts that plants are killed by immersion for ten minutes in water at  $45^{\circ}$  to  $46^{\circ}$  C., and that their protoplasm coagulates at  $50^{\circ}$  or  $60^{\circ}$ . Darwin, however, found that the immersion of leaves of *Drosera* for ten minutes in water at  $50^{\circ}$ , instead of killing the leaves, excited the tentacles into quick movement, that a temperature of  $54^{\circ}$  paralyzed the leaves without killing them, and that some even survived a temperature of  $62^{\circ}$  C. Some of the lowest plants have frequently been described as living in hot springs, but that so highly organized a native of temperate and even almost arctic regions should withstand so high a temperature is very remarkable.

*Action of Ammonia Salts.*—All the salts of ammonia produce inflexion, the carbonate strongly, the nitrate even more so, and the phosphate most of all. The immersion of a leaf in a solution of the last-mentioned salt, so weak that each gland could only absorb about  $\frac{1}{1000000}$  of a grain, is sufficient to produce complete inflexion of the tentacles. Though the particles of solid matter which stimulate the olfactory nerves, and so produce the sensation of odour in animals, must be infinitely smaller than this, as Mr Darwin remarks, the fact remains truly wonderful that the absorption of so minute a quantity by a gland should induce some change in it, which leads to the transmission of a motor impulse down the entire length of the tentacle, causing the whole mass to bend, often through an angle of more than  $180^{\circ}$ , and this too in the absence of any specialized nervous system.

*Action of various Salts and Acids.*—In the case of salts the nature of the base seems to be of much more importance than that of the acid, a conclusion already arrived at by animal physiologists. Thus nine salts of sodium caused inflexion, and were not poisonous; seven of the corresponding salts of potassium did not cause inflexion, and some were poisonous. This is interesting in connexion with the fact that large doses of sodium salts may be introduced into the circulation of mammals with impunity, whereas small doses of potassium salts speedily cause death. Of twenty-four acids tried, nineteen caused inflexion, and the majority, even including most of the organic acids, were poisonous, which is the more remarkable since juice of many plants seems much more strongly acid than the solutions which were employed. The poisonous action, however, is not improbably connected with the negative osmose which is known to be induced by dilute acids.

*Action of Alkaloid Poisons, of other Substances, and of Vapours.*—Acetate and sulphate of quinine, citrate of strychnine, nicotine, digitaline, act more or less strongly on the glands and kill them; on the other hand, nitrate of quinine, atropine, veratrine, colchicine, theine, are quite harmless. Curare is not poisonous, and cobra poison, which kills animals by paralyzing their nerve centres, causes "strong and rapid inflexion of the tentacles, and soon discharges all colour from the glands," stimulating also the movements of their protoplasm. Since alkaloids which act strongly on the nervous system of animals are without effect on *Drosera*, it seems probable that the sensibility of its glands, and their power of transmitting a stimulus to other parts of the leaf, are not due to elements analogous to nerve. Camphor in solution acts as a stimulant; the vapours however, of camphor, chloroform, alcohol, ether, and carbonic acid have a narcotic or anesthetic action, and kill the plants after a time.

*Effects of Organic Fluids.—Digestive Power of Secretion.*—Darwin treated sixty-one leaves of *Drosera* with non-nitrogenous solutions (gum-arabic, sugar, starch, dilute alcohol, olive-oil, tea). The tentacles were not in a single case inflected. He then applied to sixty-four other leaves various nitrogenous fluids (milk, urine, albumen, infusion of meat, mucus, saliva, isinglass), and sixty-three had the tentacles and often the blades well inflected. Finally, taking twenty-three of the leaves which had served for the first experiment and treating them with bits of meat or drops of nitrogenous fluids, all save a few, apparently injured by exosmosis caused by the density of the former solution of gum, sugar, &c., were distinctly inflected.

We are thus led to inquire whether the leaves have only the power of absorbing matter already in solution or whether they can render nitrogenous matter soluble, that is, whether they have the power of true digestion. The digestion of albuminous bodies by animals is effected by means of a ferment, pepsin, acting in presence of weak hydrochloric acid,—neither the acid nor the ferment having the power of digesting in the absence of the other, though almost any other acid may be substituted for hydrochloric. When the stomach is mechanically excited, acid is secreted, but not pepsin; this requires for its production the absorption of a minute quantity of already soluble animal matter (peptogene of Schiff). These propositions all held good of *Drosera*. Frankland analysed the secretion obtained by stimulating four hundred and forty-five leaves with particles of glass, and came to the conclusion that its acidity was due to some acid of the acetic series, apparently either propionic or a mixture of acetic and butyric acids. Analysis of larger quantities enabled Will to show that the secretion contained formic as well as probably butyric and propionic acid, and Rees and Will prepared a glycerin extract which when acidulated rapidly digested fibrin.



Lawson Tait also separated a substance possessing the property of a digestive ferment.

Darwin fed numerous plants with roast meat and minute cubes of boiled white of egg, and placed other cubes in wet moss as a check. Solution soon took place in the former cases; and, just as in animal digestion, the edges of the cubes of egg were first rounded off, and the striation of muscle was replaced by dark points, while the bits of egg left in moss putrefied. On neutralization of the acid by alkali, digestion stops; on reacidification, it goes on again. Neither the watery nor the glycerin extract of leaves stimulated by fragments of glass was able to digest, showing that the ferment is not secreted until the glands have absorbed a trace of animal matter. The leaves digested fibrin, connective tissue, cartilage, bone, enamel, and dentine, gelatin, chondrine, casein of milk, &c., but could not digest epidermic productions (nails, hairs, feathers), fibro-elastic tissue, mucin, pepsin, urea, chitin, chlorophyll, cellulose, gun-cotton, oil, fat, and starch, thus completing the analogy with the gastric digestion of animals. Pollen-grains had their protoplasmic contents dissolved, and seeds were usually killed.

**Irritability and Movements.**—Cutting and pricking the leaf does not induce movement; the petiole is quite insensible, nor do the pedicels of the glands bend when rubbed or stimulated by contact with food. Only the glands remain, and these at once respond to stimuli, yet their irritability seems to extend for a very slight distance below them, since when the glands are cut off their pedicels often become inflected. When a tentacle receives an impulse either from its own gland or from the central tentacles, it bends towards the middle of the leaf, the short tentacles on which do not bend at all; in all other cases all the tentacles, even those of the centre, bend towards the point whence the stimulus comes. Thus all the tentacles of a leaf may be made to converge into two symmetrical groups by placing a fragment of phosphate of ammonia in the middle of each half of the blade. Contrary to the opinion of Ziegler, vivisection shows that the motor impulse is not transmitted through the fibro-vascular bundles, but through the cellular tissue. An impulse thus travels more rapidly along than across the leaf, since, from the elongated shape and the position of the cells, fewer cell-walls have to be crossed in a given distance. Thus, when the central glands are excited, they send centrifugally some influence to the exterior glands, where aggregation of the protoplasm is set up, which may be watched descending their tentacles, and the whole process is not without analogy to a reflex action. The motor impulse seems to be allied to the aggregating process, and it has been attempted to explain the bending which takes place at the base of the tentacles by assuming either (1) a rapid passage of fluid out of the cells in that region, which would thus contract, at least if we suppose them to be previously in a state of high tension and to possess great elasticity, (2) a contraction of the protoplasm of these cells, (3) the contraction of the cell-walls as well as the protoplasm, or (4) a shrinkage of the fluid contents of the cells, owing to a change in their molecular state with the subsequent closing in of the walls.

**Absorption.**—Bennett has described what he terms absorptive glands beneath the epidermis, consisting of two nearly hemispherical cells, filled with brownish protoplasm and bearing papillæ, which sometimes rise above the surface of the leaf, or the filaments of the tentacles. He finds similar organs in *Dionæa* and *Nepenthes*, but in no plants other than carnivorous, except *Callitriche*. Clark fed *Drosera* with flies soaked in chloride of lithium, and after several days found that all parts of the plant when burned showed the characteristic spectrum of lithium; and Tait, by cultivating plants with roots cut off and leaves buried in pure sand watered with an ammoniacal solution, showed that the sundew can not only absorb nutriment from its leaves, but can actually live and thrive by their aid alone, if supplied with small quantities of nitrogenous material.

*Dionæa Muscipula*, L.—This plant, the well-known Venus's Fly-trap, was first described in 1768 by Ellis in a remarkable letter to Linnæus, in which he gave a substantially correct account of the structure and functions of its leaves, and even suggested the probability of their carnivorousness. Linnæus declared it the most wonderful of plants (*miraculum nature*), yet only admitted that it showed an extreme case of sensitiveness, supposing that the insects were only accidentally captured and subsequently allowed to escape. Two American botanists, Curtis and Canby, successively advanced our knowledge of the mode of capture and digestion, which has also been investigated by Mrs Treat, T. A. G. Balfour, and others, and most fully by Darwin.

The leaves are all radical, with broad foliaceous footstalks. Each leaf has two lobes, standing at rather less than a right angle to each other, their edges being produced

into spike-like processes. The upper surface of each lobe is covered with minute circular sessile glands, each consisting of from 20 to 30 cells filled with purplish fluid. It bears also three fine-pointed sensitive filaments arranged

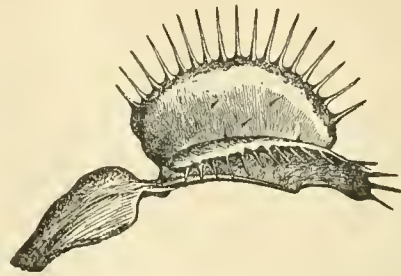
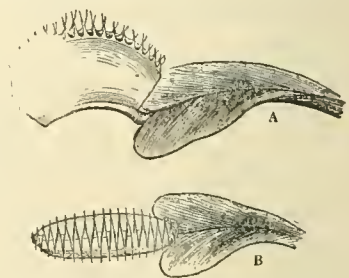

FIG. 5.—Leaf of Venus's Fly-trap (*Dionæa muscipula*), viewed laterally in its expanded state. (After Darwin.)

in a triangle. These contain no fibro-vascular bundles, but present an articulation near their bases, which enables them to bend parallel to the surface of the leaf when the lobes close.

When the filaments are touched by an insect, the lobes close very sharply upon the hinge-like midrib, the spikes interlock, and the insect is imprisoned. If very minute, and so not worth digesting, it is able to escape between the interlocked spines; more



usually, however, it is retained between the lobes, which gradually but firmly compress it, until its form is distinguishable from without. The leaf thus forms itself into a temporary stomach, and

the glands, hitherto dry, commence, as soon as excited by the absorption of a trace of nitrogenous matter, to pour out an acid secretion containing a ferment, which rapidly dissolves the soft parts of the insect. This is produced in such abundance that, when Darwin made a small opening at the base of one lobe of a leaf which had closed over a large crushed fly, the secretion continued to run down the footstalk during the whole time—nine days—during which the plant was kept under observation. Aggregation may be observed in the glands, and, at least on treatment with carbonate of ammonia, the aggregative process may be watched ascending the sensitive hairs.

Though the filaments are exquisitely sensitive to the slightest contact with solid bodies, yet they are far less sensitive than those of *Drosera* to prolonged pressure, a singular difference in evident relation to the habits of the two plants. Like the leaves of *Drosera*, however, those

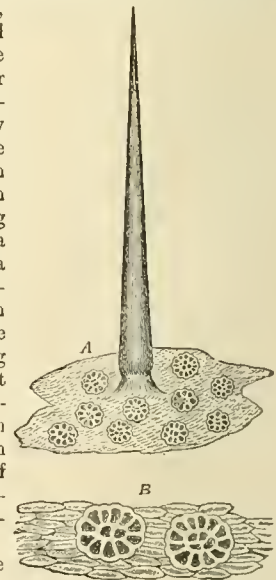

FIG. 7.—A, sensitive filament and glands of *D. muscipula*,  $\times 50$ ; B, glands,  $\times 300$ .

of *Dionæa* are completely indifferent to wind and rain. The surface of the blade is very slightly sensitive; it may be roughly handled or scratched without causing movement, but closes when its surface or midrib is deeply pricked or cut. Irritation of the triangular area on each lobe enclosed by the sensitive filaments causes closure. The footstalk is quite insensitive. Inorganic or non-nitrogenous bodies, placed on the leaves without touching the sensitive filaments, do not excite movement, but nitrogenous bodies, if in the least degree damp, cause after several hours the lobes to close slowly. So too the leaf which has closed over a digestible body applies a gradual pressure, which serves to bring the glands on both sides into contact with the body, and may also, as Balfour suggests, aid in absorption. Thus we see that there are two kinds of movement, adapted for different purposes, one rapid, excited mechanically, the other slow, excited chemically. Leaves made to close over insoluble bodies reopen in less than twenty-four hours, and are ready, even before being fully expanded, to shut again. But if they have closed over nitrogen-yielding bodies, they remain closely shut for many days, and after re-expanding are torpid, and never act again, or only after a considerable time. Even in a state of nature, the most vigorous leaves are very rarely able to digest more than twice, or at most thrice, during their life. The secretion is a true gastric juice containing formic acid, and like gastric juice has remarkable antiseptic powers. Lindsay fed leaves with such quantities of meat as to kill them with indigestion, yet showed that the meat inside the leaf remained perfectly fresh while portions hanging outside putrefied.

While evidence is thus afforded of the absorption of the products of digestion by the complete disappearance of fibrin, albumen, &c., placed upon the leaf of *Dionæa*, Fraustadt was able, by feeding leaves with albumen dyed with aniline-red, to colour the contents and nuclei of the gland-cells.

The motor impulse, as in *Drosera*, is transmitted through the cellular tissue. Burdon Sanderson has demonstrated the existence of a normal electric current in the leaf of *Dionæa*, and the negative variation undergone by that current at the moment of closure of the leaf due to the conversion of electromotive force into mechanical work. This discovery, which is of the highest importance as showing the profound resemblance between the closure of the leaf of *Dionæa* and the contraction of a muscle, has been followed up and extended by Munk. C. de Candolle ascribes the closure of the valves to variations in the turgescence of the parenchyma of their upper surface.

*Aldrovanda vesiculosa*. — This "minute aquatic *Dionæa*" floats freely, and is destitute of roots. Its whorled leaves have two lobes, with slightly inflected margins, which open only about as much as the valves of a living mussel-shell, and thus capture the more easily the

small crustaceans and mollusks which may get between them. Part of the upper surface of each lobe next the midrib bears colourless glands (like those of *Dionæa*, but stalked), together with numerous long sensitive filaments which have both median and basal articulations; the outer thinner portion bears small quadrifid hairs. Darwin holds that the glands secrete and digest, while the quadrifids are destined to the absorption of decaying animal matter, the two regions of the leaf thus serving for very different purposes.

*Drosophyllum lusitanicum*. — This plant catches such vast numbers of flies in a state of nature that the Portuguese cottagers call it the fly-catcher, and hang up branches of it in their houses for this purpose. Its linear leaves are thickly covered with stalked glands which resemble in the main the tentacles of *Drosera*, save in that they are incapable of movement, and that their secretion is acid before excitement. The secretion too is less viscid, and freely leaves the gland to wet the insect, which, creeping onward, soon clogs its wings and dies. There are, moreover, many minute colourless sessile glands which only begin to secrete when stimulated by the absorption of nitrogenous matter, with which they seem to be mainly concerned.

*Roridula* and *Byblis* resemble *Drosophyllum*, but their glands are of simpler structure than those of the latter, scarcely differing appreciably from the glandular hairs of other plants. Mr Darwin has thrown considerable light upon the question of how far the glands of plants not adapted for capturing insects share the power of absorption exhibited by those of the *Droseraceæ*. Choosing a number of plants at hazard, he found that the glands of two species of *Saxifraga*, a genus distantly allied to *Drosera*, of a *Primula*, and of *Pelargonium* have the power of rapid absorption, and exhibit movements of aggregation in their protoplasm, whereas those of *Erica*, *Mirabilis*, and *Nicotiana* appear to have no such power. Hechel has made similar observations on the floral glands of *Parnassia palustris*, and on the leaf-glands of *Geranium sparmannia*, &c. The glandular hairs of at least some plants are known to be capable of absorbing ammonia, both in solution and in vapour, and probably some obtain animal matter from the insects which are occasionally entangled in the viscid secretion.



FIG. 9.—Part of leaf of *Drosophyllum lusitanicum*, x 7. Showing lower surface. (After Darwin.)

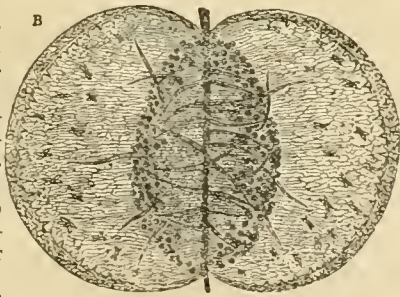
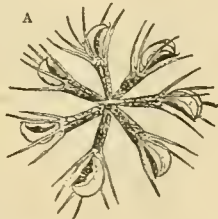

FIG. 8.—*Aldrovanda vesiculosa*.—A, whorl of leaves; B, leaf pressed open and enlarged, showing glands, sensitive filaments, and quadrifid hairs. (After Darwin.)

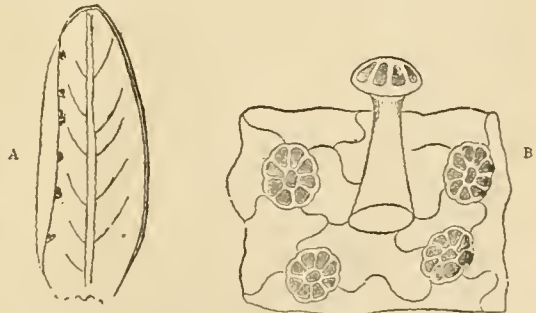

FIG. 10.—A, leaf of Butterwort (*Pinguicula vulgaris*), with left margin inflected over a row of small flies. (After Darwin.) B, glands from surface of leaf (x 300).

*Pinguicula* or *Butterwort*. — The large thick radical leaves of this genus have a very viscous surface and a pale colour, and bear two sets of glands, the larger borne on usually unicellular pedicels, the smaller almost sessile. When a fly is captured, the viscous secretion becomes strongly acid, the naturally incurved margins of the leaf



are excited to curve still farther inwards, and in short all the phenomena of secretion, aggregation, digestion, absorption, &c, may be observed which have been described in *Drosera*.

*Utricularia*.—The aquatic species of this plant are found floating in foul and stagnant water. Their much divided filamentous leaves bear bladders (fig. 11, A), averaging about  $\frac{1}{10}$  of an inch in length, each of which bears six or seven long bristles around the mouth, which is fitted with a thin transparent valve, that opens inwards and is covered with peculiar glands. The interior of the bladder is lined by quadrifid hairs (fig. 11, B), like those described in *Aldrovanda*. Aquatic crustaceans, worms, insect larvae, and other small animals easily enter by pushing inwards the posterior free edge of the valve, which is highly elastic.

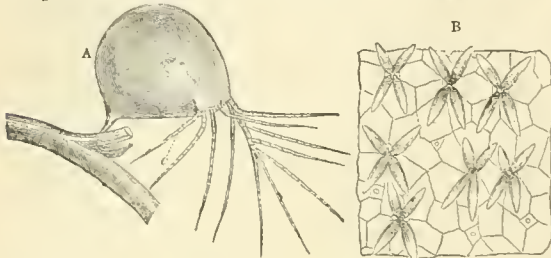

FIG. 11.—A, bladder of *Utricularia neglecta* (after Darwin), showing at *c* collar indistinctly seen through walls. B, quadrifid hairs from interior of bladder of *U. vulgaris* ( $\times 300$ ).

This instantly shuts against an interior thickened collar or projection around the mouth, and so renders escape impossible. The means by which the plant attracts its victims are unknown, but their success is very remarkable. Few bladders fail altogether, and many are found quite filled with crustaceans, as many as ten having been counted by Darwin within a single bladder. These bladders, however, have no secretion, and are quite unable to digest; they merely absorb the products of decomposition by means of their quadrifid hairs.

The terrestrial species (e.g., *U. montana*), as also those of *Polypompholix*, bear numerous minute bladders of essentially similar structure along their creeping subterranean rhizomes, and these usually contain the decomposed remains of small terrestrial articulate animals. *Genlisea* has curious long-necked pitchers, lined with long downward directed hairs, which at once aid an animal in its entrance and prevent its retreat.

*Sarracenia*.—Long supposed to be reservoirs of water for the birds, as was suggested by Linnæus, or refuges for insects from their pursuers, as was supposed by Catesby, the true function of the leaves of this curious plant has only been elucidated of recent years, mainly by the labours of Mellichamp and Hooker. The mouths of the long radical trumpet-shaped leaves are protected by a large spreading lid, the inner surface of which is abundantly smeared with nectar, and often gaily coloured. Into one form of pitcher rain enters easily, into the other with difficulty. This with the mouth of the pitcher is furnished with numerous honey-secreting glands, and furnishes the attractive surface (fig. 12, A). A pathway too leads upwards from the ground along the broad wing of the pitcher, and is at least in some species also honey-baited; along this creeping insects are lured to their destruction. Below it is the conducting surface (B) of glassy epidermic cells, with short downward-directed points, which like those of *Genlisea* facilitate the descent, but impede the ascent of an insect. Then come the glandular surface (C), which is formed of smooth polished epidermis with numerous glands, that secrete the fluid contents of the pitcher, and finally the detentive surface (D), of which the cells are produced

into long and strong bristles which point downwards and meet in the centre of the diminishing cavity so as to render escape impossible. The secretion wets an insect very rapidly, and appears to have remarkable anæsthetic effects. It seems to be completely destitute of digestive power, indeed rather to accelerate decomposition. The pitchers accumulate vast quantities of insects in the course

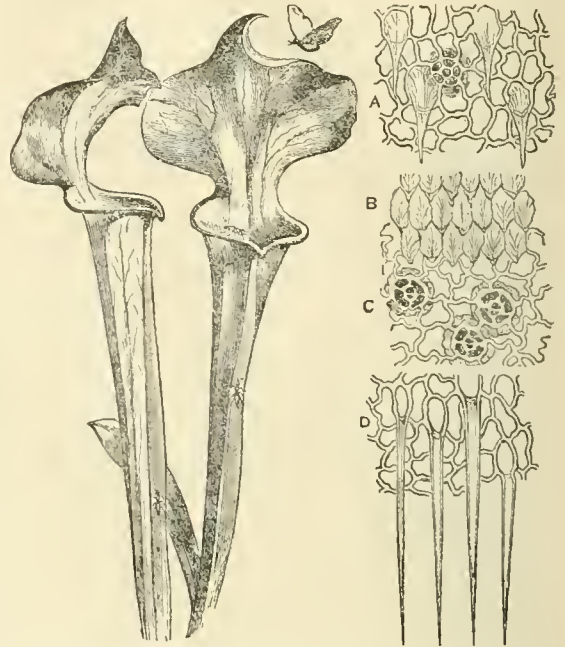

FIG. 12.—Leaves of *Sarracenia purpurea*. A, attractive surface of lid; B, conducting, C, glandular, and D, detentive surface; magnified. A and D are taken from *S. flava*.

of a season, and must thus abundantly manure the surrounding soil when they die. Moreover, the feast is largely shared by unbidden guests (commensals). Not to speak of insects which feed upon the pitcher itself, some drop their eggs into the putrescent mass, where their larvae find abundant nourishment, while birds often slit open the pitchers with their beaks and devour the maggots in their turn.

*Darlingtonia*.—Of the two forms of pitcher in this genus the larger and ordinary form, that of the adult plant, is somewhat twisted, and instead of a lid has a large inflated hood overarching the small mouth. A large bilobed nectariferous and brightly coloured expansion hangs down from this, and attracts insects, particularly moths. As in *Sarracenia*, the plant seems merely to absorb the products of their putrefaction.

*Nepenthes*.—The pitchers of this genus are borne at the ends of long tendril-like prolongations of the leaves, and are of considerable size, varying from an inch to a foot or more in depth. Again we have two varieties of pitchers, one belonging to the young state of the plant, short, broad, and provided with broad external wings, adapted for the capture of ground game, while the adult form, intended for winged game, is long, narrow, and often destitute of lateral appendages. The mouth of the pitcher is strengthened and kept open by a thickened rim, which, like the under surface of the lid, secretes honey, and is frequently produced inwards and downwards into a short funnel-shaped tube which prevents the escape of insects, or into a row of incurved hooks sometimes strong enough to retain a small bird. The younger form of pitcher has its whole interior lined by secreting glands; the other and more common form

has an attractive, a conductive, and a secreting surface analogous to those of *Sarracenia*, but wholly different in histological details. The detentive surface is represented by the fluid secretion which is invariably present. This is developed before the pitcher opens, and has generally a



FIG. 13.—*Darlingtonia californica*.

faintly acid reaction; it contains, as shown by Voelcker, malic and citric acids, together with chloride of potassium, and carbonates of soda, magnesia, and lime. Hooker proved the digestive powers of the fluid, even on substances

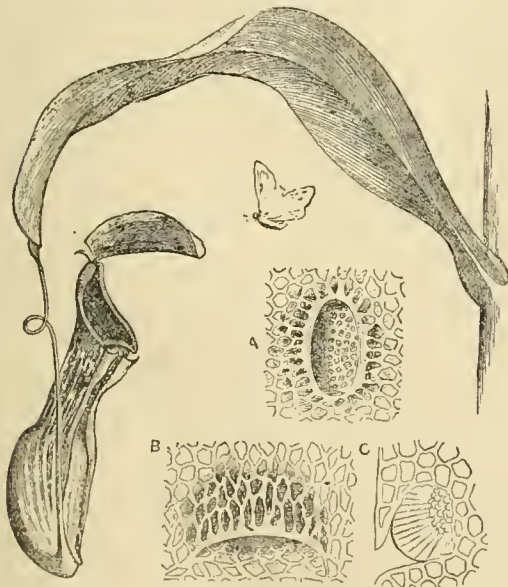

FIG. 14.—Pitcher of *Nepenthes distillatoria*. A, honey-gland from attractive surface of lid; B, digestive gland from interior of pitcher, in pocket-like depression of epidermis, opening downwards; C, transverse section of the same. A, B, and C magnified about 100 diameters.

so resisting as cartilage; Rees and Will found that fibrin was dissolved even more rapidly by the secretion of the excited pitchers than in a test experiment with pepsin from the pig's stomach; and Lawson Tait, Vines, and others have obtained the ferment in a separate state. Tait indeed

finds two substances, both possessing great antiseptic powers, and both being apparently, together with acid, essential to digestion—one a greyish-white precipitate with alkalis, which he terms "droserin," and which seems the analogue of pepsin; the other, "azerin," a transparent straw-coloured substance precipitated by alcohol, he compares to ptyalin, the ferment of saliva. Droserin seems to be present in the secretion of all those insectivorous plants which possess the power of digestion, azerin perhaps in all without exception. The latter substance has the property of rapid deliquescence, so that it can only be preserved in hermetically sealed tubes, and its solution, like glycerin, quickly wets any body with which it comes in contact. A fly thrown into water never gets completely wetted, while one which falls into the secretion of any insectivorous plant is rapidly soaked and drowned by the fluid entering its tracheæ.



FIG. 15.—*Cephalotus follicularis*, showing ordinary leaves and pitchers, the right hand one cut open to show internal structure.

*Cephalotus*.—This plant bears ordinary leaves as well as pitchers. The latter somewhat resemble in general form those of *Nepenthes*, but are more complicated in histological details. Tait has proved the digestive action of their secretion.

*Morphology of Pitchers*.—Baillon, and indeed first of all Linnæus, have pointed out how by exaggerating the concavity of a peltate leaf like that of *Nymphaea* we obtain a pitcher of the type of *Sarracenia*. Intermediate forms are frequently shown by a variety of *Piperomia arifolia*. Hooker has given reason to believe that the pitcher of *Nepenthes* is not a transformed leaf, but a mere leaf-appendage answering to the water-secreting gland found at the end of many leaves. The apex of the leaf, instead of forming the lid as in *Sarracenia*, is represented by a filiform appendage (see fig. 16, F). Finally, Dickson has

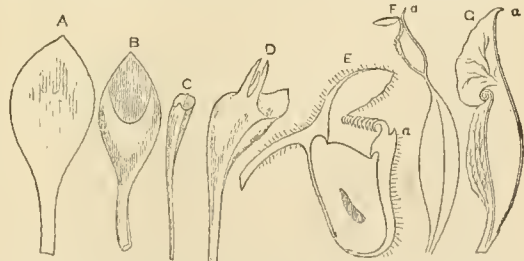

FIG. 16.—Morphology of Pitchers. (Chiefly after Dickson.) A, ordinary leaf of *Cephalotus*; B, monstrous leaf with spoon shaped depression; C and D, other abnormal forms more deeply pouched, showing formation of pitcher; E, ordinary pitcher of *Cephalotus*; F, pitcher of *Nepenthes*; G, pitcher of *Sarracenia*; a, apex of leaf.

proved by comparison with monstrous forms that the pitcher of *Cephalotus* arises in a third and totally distinct way, by a calceolate pouching from the upper surface of the ordinary spatulate leaves, the lid here arising from the proximal side of the pitcher-orifice.

*Other Insectivorous Plants*.—*Dischidia*, an Asiatic genus



of *Asclepiadaceæ*, and *Martynia*, one of the *Pedalinæ*, have also been described as insectivorous, as well as *Caltha dionæifolia* and several Aroids. Even *Anomoclada*, a South American liverwort, and a fern (*Elaphoglossum glutinosum*) have been described by Spruce as capturing numerous insects. All these cases, however, require much further investigation. The connate leaves of *Dipsacus* frequently enclose water in which insects are drowned, and Francis Darwin has discovered protoplasmic filaments which are emitted by the cells of certain glands within these cups, and which appear to absorb the products of decomposition. A similar process has recently also been shown by Ludwig to occur in *Silphium*, an allied genus.

*Conclusion.*—When Mr Darwin's work appeared, numerous objections were made to accepting his conclusions, on the *a priori* ground that digestion was too purely an animal function to be conceivable of plants. Morren demolished these by showing that digestion—the conversion of insoluble and indiffusible proteids, fats, and amyloids into soluble and diffusible compounds by means of appropriate ferments—is not confined either to animals or to carnivorous plants, but is a universal property of living beings, in fact the necessary preliminary of all assimilation. Not only are all the important animal digestive ferments represented among plants, but vegetable physiologists have made us acquainted with several ferments—synaptase, erythrozyme, myrosine, &c.—which have no known analogues in the animal kingdom. It is merely the exudation, not the existence, of the ferment, then, which is remarkable in carnivorous plants, and this Darwin suggests might begin by an exosmose accompanying the absorption of animal matter by any plant possessing viscid glandular hairs, and, once set up, would be perfected by natural selection. Insectivorous plants too are not the only ones which exhibit peculiarities of nutrition. The true parasites absorb the juices of the plants which they infest, and, not to mention the fungi, many of which subsist partly or wholly on animal matter, the phanerogamous saprophytes (*Neottia*, *Monotropa*, &c.) live by absorbing the partially decomposed materials of other plants; and from the absorption of vegetable to that of animal matter the transition is easy. The reciprocal case too occurs in the animal kingdom; animals possessing chlorophyll have been shown to nourish themselves like plants, without feeding, by decomposition of carbonic acid and the formation of starch in sunlight, and thus carnivorous plants—trespassers into the animal kingdom—are paralleled by vegetating animals. Thus, then, we have only to change our standpoint, and look, not at the anomalous plant or animal, but at the essentially similar cells, and the yet more essentially similar protoplasm of which both are composed, to see that their apparent anomalies are but additional proofs of the unity of nature.

But a more serious criticism affected the completeness of Darwin's work. Though Knight in 1818 had thought plants of *Dionæa* on which he placed morsels of beef grew more luxuriantly than others not so treated, many observers have since failed to see any improvement on insectivorous plants when regularly fed, or any disadvantage when prevented from obtaining animal food altogether; while others have even asserted that animal food was hurtful, having injured or killed their plants by feeding. In the latter case the explanation was of course that the feeding was excessive, but to meet the objections of the former a very careful research was undertaken by Francis Darwin. He took six plates full of thriving plants of sundew, and divided off each by a transverse bar. Then, choosing the least flourishing side of each, he placed, on June 12, 1877, roast meat, in morsels of about  $\frac{1}{50}$  of a grain on the leaves, and renewed the dose occasionally. The plants on the fed sides were soon clearly greener than those on the starved sides, and

their leaves contained more chlorophyll and starch. In less than two months the number of flowerstalks was half as numerous again on the fed as on the unfed sides, while the number and diameter of the leaves and the colour of the flowerstalks all showed a great superiority. The flowerstalks were all cut at the end of August, when their numbers were as 165 to 100, their total weight as 230 to 100, and the average weight per stem as 140 to 100 for the fed and unfed sides respectively. The total numbers of seed capsules were as 194 to 100, or nearly double, and the average number of seeds in each capsule as 12 to 10 respectively. The superiority of the fed plants over the unfed was even more clearly shown by comparing their seeds, the average weights per seed being as 157 to 100, their total calculated number as 240 to 100, and their total weight as 380 to 100. The fed plants, though at the commencement of the experiment in a slight minority, at the end of the season exceeded the unfed by more than 20 per cent., while the following spring the young plants which sprang up on the fed side exceeded those on the other by 18 per cent. in number and by 150 per cent. in total weight, so that, in spite of the relatively enormous quantity of flowerstalk produced by the fed plants during the previous summer, they had still been able to lay up a far greater store of reserve material.

It is to be remarked that the beneficial effect of feeding, although distinct in the vegetative system, is much more remarkable in the reproductive, a fact which explains the unfavourable opinion of previous observers.

These results were also independently arrived at by three German observers, Rees, Kellerman, and Von Ränner, who used aphides instead of roast meat. The question of the utility of the carnivorous habit may thus be considered as no less indisputable than its existence.

*Bibliography.*—Besides Darwin, *Insectivorous Plants*, 1875, and Hooker, *Brit. Assoc. Report*, 1874, p. 102, the reader may with advantage consult the following authorities. From them he can easily obtain complete references to the minor papers, which are too numerous for mention here. General Subject:—Planchon, "Les Plantes Carnivores," *Rev. d. Deux Mondes*, February, 1876; Dodel-Port, *Illustrirtes Pflanzenleben*, Zurich, 1880; Morren, *La Théorie des Plantes Carnivores et Irritables*, 2d ed., Liège, 1876; Cramer, *Ueb. d. Insectfressenden Pflanzen*, Zurich, 1877; Drüde, in *Encyc. d. Naturwissenschaften*, "Bot.," bd. i., 1879; Magnin, *Bull. Soc. d. Études Sci. de Lyon*, No. 2, 1877. *Drosera*:—Trécul, "Organ d. Glandes Péd. des Feuilles d. D. rot.," *Ann. Sc. Nat. Bot.*, 1855; Nitschke, "Anat. d. Sonnenhaublatte," *Bot. Zeit.*, 1861, and other papers in *Bot. Zeit.*, 1860-61; Morren, "Note sur le *Drosera binata*," *Bull. de l'Acad. Roy. de Belgique*, 1875. *Dionæa*:—Sanderson, *Proc. Roy. Soc. Lond.*, No. 147, 1878, and *Nature*, x., 1874; C. de Candolle, "Sur la Struct. et les Mouvements des Feuilles du *D. muscipula*," *Archives des Sci. de Geneve*, April 1876; Kutz, "Anat. d. Blattes d. *D. muscipula*," *Archiv f. Anat. u. Physiol.*, 1876; Munk, "Die elekt. u. Bewegungerschein." &c., *Archiv f. Anat. u. Physiol.*, 1876; Fraustadt, "Anat. d. Veget. Organe v. *D. muscipula*," *Cohn's Beitr. z. Biol. d. Pfl.*, 1876; T. A. G. Balfour, "Exp. on *D. muscipula*," *Trans. Bot. Soc. Edin.*, 1874-5, and Nov. 1878. *Aldrovanda*, *Utricularia*, *Pinguicula*:—Duval-Jouve, "Notes s. q. plantes dites insectivores," *Bull. Soc. Bot. Fr.*, lxxiii., 1876; Benisch, "Ueb. U. vulgaris," *Denkschr. d. k. bot. Gesellsch.*, bd. iv., 1859; Cohn, "Ueb. d. Function d. Blasen v. *Aldrovanda* u. *Utricularia*," *Beitr. z. Biol. d. Pfl.*, bd. i.; Morren, "Observ. s. l. procédés insecticides du *Pinguicula*," *Bull. Acad. Roy. de Belg.*, 1875; Klein, "Pinguicula Alpina," *Beitr. z. Biol. d. Pfl.*, bd. iii., hft. 2. *Sarracenia*, *Darlingtonia*, *Cephalotus*, &c.:—Lawson Tait, "On Structure of Pitcher Plants," *Midland Naturalist*, 1879; Dickson, "On the Morphology of the Pitcher of *Cephalotus*," *Journ. of Bot.*, May 1881; Spruce, "On *Anomoclada*," *Journ. of Bot.*, 1876; Heckel, *Bull. Bot. Soc. Fr.*, 1876. Digestion and Absorption:—Rees u. Will, "Einige Bemerk. ü. fleischfr. Pflanzen," *Bot. Zeit.*, 1875; Bennett, "On Absorptive Glands of Carnivorous Plants," *Monthly Micro. Journ.*, 1876; Clark, "On Absorption by Leaves of Carniv. Pl.," *Journ. of Bot.*, 1875; Lawson Tait, "On the Digestive Princ. of Plants," *Phil. Soc. Birmingham*, 1878; Morren, "La Digestion Végétale," *Bull. Acad. Roy. de Belg.*, 1875; Geddes, "On the Physiol. and Histol. of *Convolutus*," *Proc. Roy. Soc. Lond.*, 1879; F. Darwin, "Exp. on Nutrition of *Drosera*," *Journ. Linn. Soc. Bot.*, 1878. (P. G.E.)

# I N S E C T S

**T**HE INSECTA, or INSECTS, form the largest class of that division of the animal kingdom formerly called *Articulata*, but for which the more expressive term *Arthropoda* (joint-footed) is now more generally employed. This term includes, besides *Insecta*, the classes *Crustacea*, *Arachnida*, and *Myriopoda*.

The chief diagnostic characters of an Insect, as combinedly distinguishing it from a Crustacean, an Arachnid, or a Myriopod, are as follows:—Legs usually (never more than) six in number; two antennæ; ordinarily two pairs of more or less membranous wings; a head, thorax, and abdomen distinctly separated; respiration effected by means of internal tracheæ, which communicate with the air by lateral openings termed spiracles or stigmata, or by external plates or filaments (these ordinarily only in the preparatory conditions of aquatic forms), which absorb air and convey it to the tracheæ. A reference to the articles on the other classes of *Arthropoda* will indicate in what way these diagnostic points are modified in them.

As in all organized beings, the limits of the class are not strongly defined, for, although it is not difficult to indicate an insect, speaking broadly, there are certain small groups that do not satisfactorily fall into the class as limited by strongly marked lines of demarcation. These will be especially alluded to hereafter.

*Number of Species of Insects.*—At the head of this article it is stated that the *Insecta* form the largest group of the *Arthropoda*; it might probably be said with justice that they far outnumber all the other members of the animal kingdom combined. It is certain that at the present time 80,000 presumably distinct species of beetles have been described, and it is safe to assume that the number of known species of other orders is greater, thus giving a total of about 200,000. And yet we are only on the threshold of a knowledge of the forms that actually exist in nature, many enormous groups of minute forms being still only very partially studied. In fact, it may be confidently anticipated that some day the number of known forms will not fall far short of 1,000,000.

*Antiquity of Insects.*—Fossil indications have been discovered in the Devonian series, and in the Carboniferous they become rather more numerous; but, with few exceptions, these all belong to those orders in which the metamorphoses are incomplete, and there is no evidence that any anthophilous insects (such as *Lepidoptera* or *Hymenoptera*) were then in existence. Ascending the geological scale to the Mesozoic age, the representatives of the older groups become very numerous, and often of gigantic size. *Coloptera* are fairly well indicated; and the flower-loving *Lepidoptera* and *Hymenoptera* make their appearance, but in very small numbers. In the Tertiary rocks remains become sometimes very abundant, and of all orders; and in the post-Tertiary or Quaternary period these remains consist largely of those of species now existing. One of the most interesting features in fossil entomology is the well-known occurrence of myriads of insects entombed in the fossil resin known as amber, preserved in the most beautiful manner, and belonging for the most part to genera now existing, but differing specifically. In alluding to this it is well to mention that the insects found in gum copal and other recent resins are, on the contrary, of existing species. As in other animals, and also plants, the fossil remains prove that the distribution of heat and cold on the earth was once very different from what it now is: a fossil beetle of rather large size was discovered by our last Arctic Expedition almost at the highest northern point attained.

*Geographical Distribution.*—It may be asserted that no part of the earth's surface is without insects. They have been discovered in the Arctic and Antarctic regions at the highest point reached, and even showy butterflies of several species enliven the dreary solitudes of almost everlasting ice, as was abundantly proved by the naturalists of the "Alert" and "Discovery," who found them almost up to 83° N. lat. But, as a rule, the larger and more brilliant forms occur within the tropics. Yet it must not be assumed, as is sometimes erroneously done, that the majority of tropical insects are large and brilliant, and the smaller and more obscure forms comparatively less numerous. Recent investigations by competent observers show that the latter are at least as abundant in the tropics as in temperate regions, and that it is the wealth of large forms that has caused the others to be overlooked.

The attempts at subdivision of the globe into zoological regions, so successful with regard to mammals, and in a smaller degree with birds, have not been so entirely satisfactory with regard to insects, more especially as concerns the separation of the Palearctic and Nearctic regions (see **DISTRIBUTION**); still there is often a very marked localization in particular groups, which divide themselves specifically to an infinite extent within very circumscribed areas, and are found nowhere else. The results obtained from minute investigation of insular faunæ have derived much of their value from insects, and have occasioned much valuable philosophical speculation on the origin both of the islands themselves and of their faunæ and floræ. Space will not permit of detailed allusion to the apparent affinity shown by the insect inhabitants of regions now very widely separated, such, for instance, as that of Western Europe with Western (rather than Eastern) North America, of Australia and New Zealand with Chili, of Chili and the southern extremity of South America with the Palearctic region, &c.

As special points of distribution may be mentioned the occurrence of insects in hot springs, in brine, in the deepest caves (these are usually blind), below low-water mark, and even on the surface of the ocean (the genus *Halobates* in the *Hemiptera*) very far from land.

The power of many insects to acclimatize themselves rapidly when accidentally introduced into new regions is very marked, and adds to the difficulty often experienced in considering what species are really endemic and what introduced, especially in islands. Some of the common and noxious British species thrive enormously when introduced into Australia and New Zealand; and there is every reason to believe that the grape-vine pest (*Phylloxera*) was originally an importation from America.

*Duration of Life.*—The maximum duration of the life of a perfect insect is probably attained in bees and ants, the females or queens of which are known to live at least seven years; the minimum is found in some species of May-flies (*Ephemerida*), in which twenty-four hours is perhaps the limit. But the length of life of a perfect insect is sometimes in direct opposition to that of the same insect in its preparatory stages, and some of the *Ephemerida* that live at most but a few days in their aerial form have taken three years to complete their growth in their sub-aquatic stages. Temperature also has a marked effect on some species. The common house-fly, for instance, will complete its whole life cycle, from embryo to fly in a few days in the heat of summer, but requires very much longer in cold weather.

*Economic Entomology.*—Within the limits of an encyclo-



pædia article it is impossible to give even a sketch of this subject. Those who desire an exhaustive résumé cannot do better than consult Kirby and Spence's delightful *Introduction*, even although it may be now somewhat out of date. Some especially noxious species—such, for instance, as the grape-vine pest, the Colorado beetle, and the Rocky Mountain locust—had not then been alluded to as occasioning damage, or were even altogether unknown. As concerns American species, Riley's *Reports on the Noxious, &c., Insects of Missouri* are mines of information. Amongst insects that are of direct benefit to man the hive-bee and the silk-worm moth stand pre-eminent, and the cochineal and lac insects are scarcely of less importance. No substitutes for silk, honey, and beeswax have been or are likely to be discovered; but, on the other hand, chemical discoveries have now occasioned the disuse of some insect products that were formerly valuable articles of commerce, and in this category nothing is more remarkable than the manner in which the oak-gall of commerce has given way to inorganic substances in the manufacture of ink. As food for man, insects play a very unimportant part, and they can scarcely be said now to form part of the diet of the more highly civilized races, notwithstanding an attempt lately made in America so to utilize the masses of the destructive Rocky Mountain locust. Yet locusts themselves (with other large insects) are eaten raw or cooked by the inhabitants of more than one part of the globe, and the large fleshy grubs or larvæ of beetles and other insects are as much esteemed as delicacies by the natives of some countries as the *Cossus* (the precise identity of which appears involved in some uncertainty) was by the luxurious Romans. The aborigines of Australia make a cake of the pounded bodies of a night-flying moth (*Noctua spinii*), termed the Bugong moth; the natives of the Lake region of Central Africa make a kind of bread of the multitudes of small dead insects (chiefly *Epheméridæ* and *Diptera*) that collect on the shores; in Central America the eggs of a large water bug supply materials for a kind of bread.

Noxious insects are legion, and cannot here be alluded to even in the most general manner. The number of those that cause injury to man by direct attacks is comparatively small; it is by their attacks on the produce of our fields and gardens that insects assert their importance. But it should not be overlooked that the especial province of insects is to act as scavengers, and very frequently they are not the initiating cause of damage, which is rather to be sought in a previously unhealthy condition of the trees or plants; they simply step in to complete the work of destruction commenced by disease or by a low state of the vital functions.

*Insects and the Fertilization of Plants.*—Such is the importance of insects in the economy of nature, and as conferring indirect benefit on man, in this particular, that this subject might have been alluded to under the preceding heading. That the action of insects in fertilizing plants was often necessary had long been known. But it is owing to the patient and laborious researches of living naturalists (amongst whom the names of Darwin, Hermann Müller, and Lubbock stand prominently forward) that the vast importance of the subject has come to be understood. They have proved incontestably that in a multitude of plants the condition of the reproductive organs is such that self-fertilization is impossible; but what is of greater importance is the proof afforded that, although many plants are perfectly capable of self-fertilization, the weight and number of the seeds or fruit are often vastly increased when cross-fertilization is effected, and that this is mainly done by the action of insects, the wind and other causes playing only a minor rôle. It may be truly said that such is the correlation between plants and insects that the majority of the former

would more or less gradually disappear from the earth's surface were the latter to be destroyed. In New Zealand the red clover has been introduced and flourishes, but all hopes of spreading it there have to be abandoned; the plant never perfects its seeds, owing to the absence of humble bees, which appear absolutely necessary for its fertilization.

*Parasitism.*—Among the varied relations of insects to other classes of the animal kingdom and their mutual relations, no subject is more interesting than is that of parasitism. It occurs in almost all the orders, but in very different degrees. Whole groups are naturally epizöic, others entozöic, while a few (such as fleas and bed bugs) can scarcely be arranged in either of these divisions, inasmuch as, although in one sense epizöic, it appears probable that they may occasionally be able to go through the whole of their life cycle without contact with the animals to which they otherwise appear especially attached. As true epizöa the whole group of true lice, *Anoplura* (which are probably degraded *Hemiptera*), and bird lice (*Mallophaga*, a group of uncertain affinities) are especially familiar. These cannot exist without their hosts, and their whole life is passed on them, each mammal or bird having its especial parasite (or more than one), which affects it only, or is at any rate confined to it and allied species. Such also are certain degraded forms of *Diptera*, including the bat parasites (*Nycteribia*), the bird flies (*Ornithomyia*), and others. Such also is a curious creature (*Platysylla*) parasitic upon the beaver, the affinities of which are so little marked that it has been formed into a distinct order (*Achveioptera*) by Westwood, placed in the *Hemiptera* by Ritsema, and declared to be a true beetle by Leconte. Such also is a curious little moth (*Epipyrops*, Westwood), an external parasite upon certain homopterous insects; another moth (*Tinea vastella*) lives in its larval state on the horns of living animals; and many others might be cited.

As entozöic insects, the large dipterous family *Æstridæ* is especially characteristic, all its members living at the expense of *Mammalia* in very varied manners, the stomach, throat, frontal air passages, the subcutaneous system, and even the genital organs being attacked by various species, but only as larvæ, the perfect insects being winged and strong flyers. Furthermore, a genus of *Diptera* (*Butrachomyia*) belonging to quite another family (*Mucidæ*) is said to attack frogs. It is scarcely just, however, to class as true parasites certain insects whose larvæ have been discharged (still living) from the nostrils, intestines, or urethra of man. Many such cases have been perfectly authenticated, but the insects have been such as certainly do not of necessity require such conditions, and these latter are not natural habitats. Accident introduced them, and they were fitted to exist, at any rate for short periods, in the interior of the human body. But the largest class of insect parasitism is that which exists between insects themselves, as exhibited in an enormous number of certain families (*Ichneumonidæ*, *Evanidæ*, *Proctotrypidæ*, *Chalcididæ*, &c.) of *Hymenoptera*, &c. These are essentially parasitic in their preparatory stages, and the parasitism is of the class that may be termed entozöic. The eggs are laid either in or on the bodies of the larvæ (chiefly of other insects, and even in the eggs, the young larvæ of the parasites feeding mostly on the adipose tissue of their hosts, often enabling the latter to undergo most of their transformations (but very rarely that to the perfect insect). To such a class belong also many dipterous insects, chiefly belonging to the *Tachinidæ*. Hyper-parasitism exists in many minute species of *Chalcididæ*, which do not directly affect the hosts themselves, but which feed in the bodies of other parasites.

*Luminosity.*—This is another subject that should have

more than passing notice bestowed upon it. Modern scientific travellers have not succeeded in confirming Madame Meriau's well-known statements with regard to the luminosity of the so-called lantern-flies (*Fulgora*), hence these have to be eliminated from the category of luminous insects. It is among the *Coleoptera* that the phenomenon especially occurs, and in them is almost confined to certain skip-jack beetles (the genus *Pyrophorus*), and probably the entire family of glow-worms (*Lampyridæ*). The luminosity is confined to certain distinct patches, differing in position and number according to the species and also according to sex,—usually most observable in the female, although this does not appear to be always the case. The property is distinctly under the control of the insect, and is often exercised in an intermittent manner at stated intervals, when the insects are not under the influence of extraordinary excitement. It is probable that luminosity exists in some *Diptera*, and also in the larvæ of certain exotic *Lepidoptera*, a recent traveller having assured us that in South America a larva of this order has luminous patches along either side, so that when in motion it has been compared to a lighted-up railway train. Some occasional instances of luminosity appear to be accidental, probably owing to the insects having been feeding upon, or otherwise in contact with, decaying phosphorescent matter. With regard to the nature of the luminous substance no very precise results have been arrived at by investigators. That it is phosphorus in some form or other appears certain, and the latest experimenter (Jousset de Bellesme) asserts as his belief that it is no other than phosphoretted hydrogen gas stored up in the cellular tissue, and in direct communication with the nervous and respiratory systems.

*Galls*.—These well-known insect-productions are alluded to chiefly in order to call attention to the mystery that surrounds their growth. Galls are occasioned by the presence of the larvæ of certain species in nearly all orders of true insects, though it is amongst the *Cynipidæ* in *Hymenoptera* and the *Cecidomyiidæ* in *Diptera* that they are most characteristic. And they may be in almost any position on a plant, according to the species of gall-maker. The most striking, however, are clearly modified leaf or flower-buds.

The mystery surrounding galls is their cause. The indirect cause is the puncture of the insect, and the presence of its eggs or larvæ, but no explanation has been offered of the reason why this presence sets up the growth termed a gall. Two insects of differing species will deposit their eggs in the same position: in the one case no abnormal growth follows; in the other some peculiar irritation sets up a tumour, often enormous in size. Two insects, also of different species, but both gall-makers, do the same: in both cases a tumour ensues, but its form is totally different in the two. A most noticeable recent discovery is that by Dr Adler (since confirmed by others) to the effect that in certain European *Cynipidæ* dimorphism to a remarkable extent occurs, and that certain genera are only conditions of others, the two forms of insects, and the totally different galls occasioned by them, being alternate in appearance.

*External Structure*.—Taking any large insect, we recognize in it three more or less distinctly separated divisions, the head, thorax, and abdomen. Taking the majority of insects, and especially of their larvæ, we recognize thirteen segments or somites, counting the head as one, the thorax as consisting of three, and the abdomen as nine. From a classificatory point of view, it is probably convenient to retain this idea, though in the abdomen of a dragon-fly (for instance) there are 10 quite distinct segments. But, seen in the light of embryology and morphology, a different aspect is put on. The abdomen in the embryo of some

insects clearly consists of 11 segments. Moreover if each appendage of the head be considered as a modified limb, we get in some insects as many as 7 segments in this portion of the body alone. Thus although 13 segments is a usual and convenient number as regards the structure of an insect, this number must be vastly increased if we consider the animal in regard to other divisions of the Arthropod series. In the abdomen the actual number is sometimes very much reduced, owing to several of the segments becoming obsolete, coalescent, or retracted.

The exoskeleton, or outer covering, is more or less horn-like in its nature. But its elements are by no means similar to those of either horns or bones. It is composed to a varying extent of phosphate of lime, with the addition of a peculiar substance termed *chitine*, especially characteristic of, though not strictly confined to, the *Insecta*. According to recent analysis, the constituents of chitine are said to be as follows:—

Carbon.....	45.69	Nitrogen.....	7.00
Hydrogen.....	6.42	Oxygen.....	40.89

The head, or anterior of the three main divisions of the body, of a perfect insect is of very varying form and structure, both as regards outline, the condition of its attachment to the trunk, and the details of its special appendages. No account of these variations can be given here; they will be briefly alluded to in the classificatory portion of this article. The various organs and appendages may be stated as follows. On each side of the anterior portion are inserted two long and usually multi-articulate processes termed "antennæ," which are tubes containing nerve-prolongations and tracheæ, and undoubtedly associated in a high degree with the special senses; but, notwithstanding all the controversy on the subject that has existed and still exists, we do not yet know clearly what is their special function. They have been considered organs of touch, of hearing, of smell, or simply as balancers assisting and directing flight. No one who has watched the proceedings of many insects (and especially of ants), when meeting others of their kind, can doubt that they act in some way (but perhaps not in all insects) as means of intercommunication, and thus take a high rank as important structures. They are, as a rule, much less developed in those insects having very large eyes; and in the larvæ of those that undergo a complete metamorphosis they are usually rudimentary only, notwithstanding their often enormous development in the perfect insects produced from the same larvæ.

The compound eyes are two in number (though each is occasionally divided into two portions), usually of large, sometimes of enormous size, and each consisting of very numerous facets, which but indicate the faces of so many independent angular tubes separated by layers of pigment. In the larval state the eyes are ordinarily simple, and each eye is usually a congregation of separate eye-spots. Besides the compound eyes, there are two or three (or no) small simple eyes, "ocelli" or "stemmata," each with a simple nerve, and never present in the larvæ or (probably) pupæ.

The organs of the lower surface of the head are of a most complicated nature, and are excessively modified according as the insect takes nutriment by biting or by sucking. Below the eyes is the "front"; this is succeeded by a piece termed the "clypeus" (or "epistome" or "nasus"), which is followed by the "labrum" or upper lip. On either side are the "mandibles" (usually dentate within) articulated to the cheeks, and below these a second pair of jaws, compound in structure, and consisting of a hinged base, afterwards frequently dividing into two portions, the "maxillæ" and maxillary lobes, and provided externally with articulated appendages known as the maxillary palpi. Below the mouth is the "labium" with its labial palpi, articulated to the "mentum" or chin-piece; lying within this lower



mouth-covering is the "lingua" or tongue. The same general arrangement is present throughout all insects, and also in the larval and pupal stages; but the differing conditions of the food cause extreme modification, not only between differing groups or orders of the perfect insects, but also in the metamorphic stages of the one and the same species. In some insects there are additional small structures, such as the "paraglossæ."

The "thorax" is the next main division. It is composed of three distinct portions, the prothorax, mesothorax, and metathorax, all subject to excessive modifications; but the last is, on an average, the smallest; at any rate it seldom exceeds the intermediate, and is usually very much smaller. According to surface, each portion receives two different names; thus the upper side consists of the pronotum, mesonotum, and metanotum, the lower of the prosternum, mesosternum, and metasternum. It will be noticed also that each subdivision is again subdivided by more or less distinct grooves, especially above and on the sides, indicating its compound nature, and each of these has its special term, so that some authors go so far as to say that each thoracic division is formed of nine separate pieces (a text book on entomology, which this article cannot be, should be consulted as to these). In those insects in which the wing-power is great, the attachments of the muscles are strongly indicated externally.

The appendages of the thorax are the legs and wings. The legs are articulated members, of which one pair is attached to the sides of each subdivision. All true insects have but six actual legs, but in the larvæ of some orders there are simple fleshy prolegs on the abdominal segments, considered as representing the homologues of those abdominal legs so conspicuous in the *Myriopoda*. Of the true legs the anterior (or prothoracic) pair are directed forward, the two other pairs backward. Each leg consists of a basal joint or coxa (frequently not movable) inserted in sockets termed the acetabula; this is followed by a small joint termed the trochanter placed between the coxa and femur or thigh, which is ordinarily the largest joint, and is enormously developed in saltatorial insects. To this succeeds the tibia, followed again by the tarsus, which is ordinarily compound, but may consist of any number of joints from one to five. The tarsus is terminated by a pair (seldom one only) of claws, between which are more or less membranous arolia or plantulæ (much marked in the feet of *Diptera*, which climb polished surfaces, &c., by means of them), and also a pulvillus or cushion.

Wings are appendages of the mesothorax and metathorax (never of the prothorax), and, viewed simply as organs of locomotion, may be considered as expansions of the integument, though some morphologists object to this simple definition, and one at least (F. Plateau) regards them as tracheal extensions. Although in all orders there are cases in which they are never developed, the exceptions being so few as abundantly to prove the rule, yet the posterior (or "hind" or "under") pair may be absent, and the anterior (or "fore" or "upper") ample. So strongly are they attributes of a perfect insect, that in some cases in which neither pair is developed the creatures strongly incline to retain their larval form. Normally the first external indications may be said to appear in the pupal stage (but we will show that in insects with imperfect metamorphoses the line of demarcation between larva and pupa is not marked), and they only attain their full development some little time after the exclusion of the perfect insect. A wing consists of an upper and lower membrane (readily separable in a recently excluded insect, or afterwards by maceration), strengthened by more or less numerous strong ribs, more or less connected transversely, termed nervures or veins (neither term being very appropriate), which are

chitinous tubes (containing special trachææ), through which the blood circulates. The varying condition of the wings will be alluded to in the systematic portion of this article, as also to some extent the scheme of neurition, one of the most important factors in systematic entomology, but rendered unsatisfactory in consequence of the utterly different nomenclature employed by writers on special orders, though doubtless the general scheme is capable of being homologized.

The last of the three great divisions of the body is the abdomen, which consists of a number of segments (normally nine), having an upper (dorsum) and lower (venter) chitinous surface, which two surfaces (in the most characteristic condition) are connected by a membranous lateral line, with lateral stigmata or spiracles. But almost every conceivable modification is presented both in its attachment to the thorax, its general outline, and the number of segments present. Of the appendages of the abdomen it is necessary to say but little. In a perfect insect there are no abdominal legs, and rarely any indications of breathing plates (so usual in some groups of aquatic larvæ). The appendages are therefore almost entirely connected with the sexual apparatus, which vary enormously, and occasionally there are terminal articulated thread-like tails, strongly simulating antennæ both in form and structure.

*Nervous System.*—This may be said to consist of a more or less double cord lying along the ventral portion of the body, connected at intervals by thickened masses termed ganglia. But the large mass in the head is termed the brain, in contradistinction to the others. The brain usually consists of a bilobed mass giving off nerve masses to the eyes, and threads to the other cephalic appendages or organs; recent researches prove that, at any rate in some cases, the brain has convolutions analogous to those of the higher animals. Immediately below the brain is a large ganglion, usually termed the infra-oesophageal, connected with the mouth-organs and digestive functions. Then follow, in the thorax and abdomen, a series of ganglia, each of which gives off numerous lateral threads. But the number of these ganglia varies very greatly, not only in insects of different orders, or in species of the same order, but also in the larvæ, pupæ, and perfect insects of the same species; and it is impossible to enter here into the most rudimentary analysis of these variations. It has been said that normally there should be a ganglion for each segment (or for each movable segment) of the body, and to some extent this would appear to hold good, for, in those insects in which some of the segments coalesce, a similar arrangement is seen in the system of ganglia, but this would not appear to be a universal law, and in some the abdominal ganglia are virtually obsolete. Similar variations exist in the extent to which the double central column becomes united or remains divided. In addition to this column, a simple sympathetic nerve is also distinguished, without ganglia, but giving off threads to the respiratory and other systems. This lies above the main ganglionic chain. In minute structure the nervous cord of the *Insecta* is analogous to that of higher animals. The simplicity of the nervous system has caused it to be believed that insects do not suffer pain in the sense of that experienced by higher animals, and their behaviour when subjected to treatment that should cause intense pain, in the ordinary sense of the word, appears to warrant such an opinion; but the existence of such a condition cannot be held to justify wanton cruelty. Those who desire minute information on the nervous system should especially consult Newport's article "Insecta" in Todd's *Cyclopædia of Anatomy and Physiology*, and a series of articles by E. Brandt, now appearing in the publication of the Russian Entomological Society.

*Respiratory System.*—Respiration by tracheæ is one of the main characteristics of an insect. Tracheæ are tubes ramifying in the interior of the body, the walls of which are composed of two membranes with a spiral thread between, and extending into the wings and other appendages; but in the perfect insect the main tracheæ are subject to modification, and are more or less expanded into vesicles to suit the requirements of creatures with great powers of flight, or of strong movement in other ways. The manner in which air is communicated to these tracheæ, in order that the necessary oxygen may be obtained from it, is twofold in its nature. In insects that live in free air the latter is received through lateral openings termed spiracles or stigmata, which vary in number in different insects, but there is usually one on each side of most of the segments. A spiracle usually consists of a longitudinal slit in a membrane, protected by delicate mechanism, and also by special muscles, which can close it hermetically if necessary. Many aquatic insects also breathe through spiracles, and in these cases a quantity of air is collected (or entangled) in delicate pubescence on the surface of the body, the insect coming to the surface to obtain a fresh supply at intervals. But in the majority of aquatic insects, and especially of their larvæ or pupæ, air is obtained by means of external threads or plates, expansions of the integument, the function of which is to absorb air from water and convey it to the tracheæ by means of delicate ramifications of the tracheal system in their substance. The number and position of these external appendages (or branchiæ) is as varied as are the conditions under which the insects live; in some only a single elastic tube is present, which can be protruded to the surface of the water, and its length adapted to the varying depth of that element; in some (as in many dragon-flies) the plates are in the rectum, and the air is obtained by the forcible taking in and expulsion of water by means of powerful anal valves (which serve also for locomotion). It is obvious that those larvæ that exist parasitically in the substance of the body of other larvæ, &c., must still obtain air, and it is presumed that this is sometimes effected at the expense of the respiratory system of their hosts. It has long been known that rudimentary branchiæ exist in aerial insects, and, though this was at one time supposed to be an attribute of one or two forms only, it is now known to occur frequently. According to the researches of Gegenbaur and Palmén, these branchiæ exist side by side with the ordinary spiracles; hence they conclude that there is no direct connexion between the branchial system of the larva and the spiracles of the imago. It is still perhaps an open question whether these branchiæ in the imago serve any functional purpose.

*Alimentary and Digestive Systems.*—The food of insects is either solid or liquid, and the parts of the mouth are modified, according to requirements, into two main conditions, termed mandibulate and haustellate; but the latter term is somewhat vague, inasmuch as the modifications are by no means homologous in all haustellate insects, although the structure is subservient to the same function. Again, in both divisions the food may be either vegetable or animal in its nature, and according as this may be the parts of the digestive system are modified. The most simple digestive system consists merely of a tube extending from mouth to anus, with no very distinct division into parts. But in insects the arrangement is considerably more complex, yet varying enormously. The most complete system consists of œsophagus, with the salivary glands (modified into silk-producing glands in *Lepidoptera*, &c.), crop or proventriculus, gizzard, stomach, small and large intestines, and an arrangement of small canals termed the Malpighian tubes. Some authors distinguish also other divisions of the intestines answering to those of higher

animals. By some the term proventriculus is applied to the crop, by others to the gizzard. The gizzard is usually absent in haustellate insects; but, as most of these are truly mandibulate in their larval stage, much modification is undergone during metamorphosis. The digestive secretion of all parts of the system appears to be essentially alkaline, and assimilation goes on from all (excepting perhaps the lower intestine) *pari passu* with digestion, the latter being commenced in the crop. The Malpighian tubes are a set of long slender vessels (varying much in number) situated in the lower portion of the system at the junction of the small and large intestines. Their function has been warmly contested amongst physiologists, many considering them biliary organs, while probably an equal number maintain they are solely urinary, and a few hold that both these functions may be attributed to them. The recent researches of Plateau and others are in favour of their being solely urinary. Von Siebold has asserted that the biliary system consists of certain cells in the walls of the stomach. It is possible the whole intestinal canal is at times called upon to play a rôle quite independent of digestion and assimilation; it may be made subservient to metamorphosis through being distended with air, thus assisting the rupture of the integuments for the escape of the imago; but this can probably only obtain in insects with incomplete metamorphoses.

*Circulatory System.*—Almost as much uncertainty exists, or has existed, as to the true nature of this system as in other points of internal structure and physiology. Originally it was believed that no circulatory system existed, an idea that was speedily dissipated. If we examine a larva of which the integuments are tolerably transparent, we perceive, even without dissection, a large vessel running along the dorsal portion of the creature just beneath the integument, and we perceive also that it distinctly pulsates. This is the “dorsal vessel” or “heart,” and it terminates anteriorly in a cephalic aorta. Examined more minutely by dissection, it is seen to consist of a number of chambers and constrictions, each chamber having a lateral valvular opening on either side, through which the blood is received into the vessel by regular currents and conveyed to the cephalic aorta, whence it escapes into the body in currents which have no vascular walls, and is again received into the dorsal vessel from lateral currents,—such, at least, is the most generally received opinion. Certain it is that the blood (which is ordinarily a colourless liquid) circulates through all parts of the body, even to the antennæ, legs, and wings, and the circulation can be well observed in the wings of some insects in which these organs are unusually transparent, in that case distinctly following the course of the nervus. But many physiologists have believed that the blood is conveyed over the body by means of the tracheæ, some distinguishing certain tracheæ to which this function alone, and not that of respiration, is proper. The majority of these, however, state that the blood simply flows between the two integuments of which the walls of a trachea are composed, and to this system the term “peritracheal” has been given. According to the results obtained from the experiments of the most recent observers, we prefer to doubt the existence of this peritracheal circulation. The relative frequency of pulsations varies much according to the insect and its state of activity or excitement. They disappear almost entirely in insects in a state of hibernation, and are much reduced in the pupæ of those that undergo complete metamorphoses.

*Muscular System.*—The muscles are attached to the inner side of the chitinous integument, and lie just beneath it. They are composed of numerous parallel fibres without any tendinous sheaths, but the fibres are apparently sometimes united at their extremity into a kind of tendon, which has



been considered as only an extension of the chitinous integument. According to their position and function, they act variously, as do these of higher animals, and have received similar names. Their number is often enormous, and when we consider the great powers of flight, or of locomotion by other means, possessed by many insects, it is not difficult to understand that their strength must be proportionately great. Lyonet's celebrated treatise on the anatomy of *Cossus* remains a masterpiece of research on this subject, and in England Lubbock's recent memoir on the subcutaneous muscles of *Pygæra bucephala* is equally remarkable, and should be studied by those desiring minute information on the complex muscular system.

*Generative System.*—In all insects the sexes are separate. True hermaphrodites do not exist, though individual monstrosities, in which the form, coloration, and even internal organization of both sexes are combined, are not rare. The external organs are placed at or near the extremity of the abdomen, and are usually accompanied by secondary or accessory appendages often of most complex structure, serving to ensure complete contact during the sexual act, and probably also to some extent excitatory. In the dragon-flies, however, the intromittent organ of the male is in the under side of the second abdominal segment, which explains the extraordinary position of the sexes when coupled. In the male the testes are very varied in form, ordinarily separated, but sometimes united into one mass, each of the two halves of which has its special duct. But the separate form is by far the most usual. As in higher animals, there are the usual parts, the *ductus ejaculatorius*, the *vesiculæ seminales*, and the *vasa deferentia*, the conditions of which vary infinitely in different insects. Whether the intromittent organ is always traversed by an inner canal or not is a little doubtful. Ordinarily such is no doubt the case, but in others it would appear probable that the *ductus ejaculatorius* does not end absolutely in the organ, and that a groove on the surface of the latter receives the sperm. Some such arrangement must certainly exist in dragon-flies, in which the testes and the opening of the duct have no direct connexion with the intromittent organ. In the female the ovaries occupy much of the abdomen that is not taken up by the intestinal canal. Each consists of a very varying number of tubes, branching off externally, in which the eggs are contained; these eggs are conveyed by oviducts, and before extrusion receive the fertilizing fluid stored in the spermatheca, which latter may be simple or compound; they pass out by the vagina. In close connexion with these parts in the female is the poison gland and sting found in some insects. In the gravid female of *Termes* the ovaries become enormously distended, so that the entire insect may be said to consist of little else than eggs. The rudiments of the sexual organs may be detected in the larva when in a very young state, and the sex of the future perfect insect determined,—a sufficient answer to those who assume that sex can be controlled by the nutriment furnished to the larva. It was formerly considered that, pairing once effected, the male died almost immediately, and the female followed after having deposited her eggs. Recent observations go to prove that this is to a large extent erroneous, that pairing may be effected several times by both sexes (the female laying her eggs intermittently), in effect that polygamy and polyandry exist.

There are certain anomalous conditions of the generative system that may be conveniently noticed here, under different headings.

*Neuters or Workers.*—In bees, wasps, and ants, and also in *Termes* (or white ants), the majority of the members of a colony is made up of individuals which as a rule have no reproductive powers. In the first three, these are

aborted females, and it has been proved (at any rate for ants) that occasionally these workers lay eggs, which, however, always produce males, the production of a queen depending apparently upon special feeding in the larval stage. In *Termes* the conditions are different. There are both workers and soldiers, both incapable of reproduction, but not exclusively consisting of aborted females, since both sexes are represented. Also in *Termes* there are what have been termed complementary males and females, distinct from the pair that were once supposed to be the exclusive founders of a new colony; of these the females lay comparatively few eggs, their ovaries not acquiring the extraordinary development of those of the true queen.

*Viviparous Insects.*—Oviparous generation is the rule in insects; but there are certain departures from the rule. In the *Aphides* it is well known that both the oviparous and viviparous exist in the same species. In *Lepidoptera* there is a well-authenticated instance of an Australian insect closely allied to the clothes-moth bringing forth larvae already hatched. A similar condition is asserted to exist in a species of cockroach. In *Coleoptera*, Schödté has noticed that two species of *Staphylinidæ*, living in the nests of white ants in Brazil are viviparous, as is likewise *Oreina* in *Chrysomelidæ*; so also are the *Strepsiptera*. In *Diptera* flesh-flies of the genus *Sarcophaga* are known to be viviparous. But the most extraordinary instance is in certain minute flies, to be noticed below, of which the larvae produce living larva.

*Alternation of Generations, Parthenogenesis or Agamogenesis.*—In the bee, ant, many gall-flies, some *Lepidoptera* and (as is now known) also some *Coleoptera*, and insects of other orders, females are capable of producing fertile eggs without any contact with the male, and the produce of these eggs is frequently male. This property varies considerably in details. In the case of the bee or the ant, it would appear that one impregnation suffices for the life of the queen (which may last for seven or eight years), but the power of producing females does not probably extend beyond the immediate influence of the impregnation. In some hymenopterous gall-flies a true alternation probably sometimes occurs, combined with dimorphism; but absolute parthenogenesis, in which females are produced generation after generation, is the common condition in many lepidopterous insects. This process is effected by internal budding. In the *Aphides* the conditions are still more remarkable, owing to the existence of both winged and apterous forms of both sexes, and of both oviparous and viviparous generation; but it is not proved that the same individual insect is capable of producing both forms. In the case of the minute fly (*Miastor metroloas*) mentioned above, the production of larvae from larvae is continued throughout the winter and spring, until in June the breed goes through its ordinary metamorphosis, and results in mature males and females, and so the cycle recommences. Of all the marvels in the history of insects, this is the most astonishing; no wonder that the assertions of R. Wagner (the discoverer) were met with incredulity from the best physiologists until abundantly confirmed by others, and in other species.

*Metamorphoses.*—Hundreds of volumes have been written on this fascinating subject, one or more of which are in almost every library; hence there is no necessity for giving more than a rudimentary outline here. All true insects may be said to undergo a metamorphosis. Such a condition is absent in the small groups known as *Thysanura* and *Collembola*; and, although these are here retained amongst *Insecta* as a matter of convenience, the writer is disposed to agree with Lubbock that they are outside the pale of true insects. Metamorphosis may be broadly grouped into two main divisions—

(1) that in which the larva changes into a pupa which, as a rule, is inactive, and which never eats, and (2) that in which there is no true pupa state, the animal continuing active, and eating, from the egg to the perfect insect. In the former the larva changes its skin, or moults, several (often many) times before it changes to the pupa, the last moult (or ecdysis) happening when it is in what may be called the pseudo-pupal condition (which may last from a few hours to several months) immediately before the pupa state is assumed; this division is usually characterized as "metabolic." In the latter ecdysis goes on continuously at intervals from the egg to the winged-insect, and the form of the larval condition much resembles that of the perfect, the wings budding out gradually as the creature approaches maturity; the term "hemimetabolic" is applied to this division. In the first division the conditions are rather more varied than in the second. In the pupa of some *Diptera* the larval skin hardens, and within this the true pupa is formed (such a pupa is termed "coarctate"); in other *Diptera* the pupa is not contained within the larval skin (which much resembles a true cocoon), but is free and even sometimes active, the various appendages not being connected with the body, as is usually the case in that of a lepidopterous insect. The pupæ of *Hymenoptera* and *Coleoptera* are also much in the same condition, but they are not strictly active. Many writers have attempted to draw a broad distinction between such a pupa as that of a moth and that of an ant-lion or caddis-fly, cited here as extremes, because in the latter the members are free, and the pupa is really active shortly before the change into the perfect state, and thus the metamorphosis is supposed to be in some respects intermediate between that of true *Metabola* and true *Hemimetabola*. But such distinctions are more apparent than real. In many of the small moths the limbs and other appendages are scarcely consolidated with the body, but simply concealed in sheaths of which the ends at any rate are free. Also in the second (or hemimetabolic) division distinction has been drawn between the larva of a May-fly and that of a bug (as instances), because the changes from an absolutely apterous condition to one in which the wings are rudimentary and from this to the perfect state are more marked in the latter. This is probably due to the number of moults being less; the form with rudimentary wings is in no way a true pupa.

The metamorphosis of the internal organs, and even of the mouth parts, is much more marked in the *Metabola* than in the *Hemimetabola*. Respiration is maintained by means of spiracles or branchiæ, as in larvæ.

"Hypermetamorphism" is a term applied to certain conditions in which the larva at one period of its life assumes a very different form and habit from those of another period. Such a condition exists in several *Coleoptera*, such as *Meloe* and *Cantharis*, in which the larva is at first very active, with long legs, slender form, and anal setæ, and attaches itself to the bodies of bees, afterwards becoming almost apodal, short, and stout, and living in the bees' nests. Other *Cantharidae* live in the egg-tubes of *Orthoptera*. In *Sitaris* a still more remarkable intermediate condition has been observed: the larva after having attained its second condition assumes that of the coarctate pupa of a fly, from which it changes again to a state more analogous to the second condition before finally transforming to a pupa. This kind of metamorphosis has been closely observed by Newport, Fabre, Lichtenstein, Riley, and others. Brauer has recorded a somewhat similar condition in the larva of *Mantispa* (*Neuroptera*), which is at first free and very active, and afterwards becomes nearly apodal and obese, and lives parasitically in the nests of spiders. Advanced evolutionists hold the idea that larvæ are only acquired conditions.

### Classification.

It is necessary to reduce what may be termed the systematic portion of this article to the smallest possible limits. The various orders are noticed under separate articles, and similar articles are devoted to the consideration of many of the more prominent, interesting, and familiar insects. All we can do here is to allude briefly to classification as a whole, with indications of the higher groups under each order. We also have nothing to do here with *Crustacea*, *Arachnida*, and *Myriopoda*, now considered as distinct classes, although American writers have recently again included the last two in *Insecta* as orders, placing the more subordinate groups (or orders in the general acceptance of the term) as suborders. Still more impossible is it for us to enter into an examination of the history of classification; those of our readers who are specially interested in this subject cannot do better than consult vol. iv. of Kirby and Spence's *Introduction to Entomology*, where a most full and painstaking "history of entomology" is to be found up to the date (1826) at which it was published; or they may consult with equal advantage Westwood's *Introduction to Modern Classification*, and Burmeister's *Manual of Entomology* (Shuckard's English translation). The different classifications proposed by authors mainly resolve themselves under three headings,—the "metamorphic" (of which Swammerdam may be considered the founder), the "alary" (or wing-system, due to Linnæus), and the "cibarian" (or mouth-system, originating with, or at any rate elaborated by, Fabricius). The metamorphic system divides insects into those that undergo complete and incomplete metamorphoses; the alary is based upon the presence of two or four wings, or their absence altogether; the cibarian depended upon the conditions of the mouth organs, and more especially as to their being fitted for biting or sucking (mandibulate or haustellate). But experience proved that each of these systems had its defects; there were always some groups, of more or less importance and extent, that would never fit satisfactorily into any of the proposed systems. To remedy this varying means were adopted, such as a combination of the several systems into what has been termed the "eclectic" system, the erection of numerous orders for certain aberrant groups, and that most ingenious idea of MacLeay, the author of what is termed the "circular" system. We are disposed to consider that of all systems the one that combines the greatest amount of convenience with the nearest approach to being natural is the metamorphic, and this we shall accordingly follow here. It is not intended to acknowledge the subsidiary orders, excepting the *Collembola* and *Thysanura*, which are probably scarcely true insects, but which it is necessary to place here, were it only to avoid the risk of their being overlooked altogether, inasmuch as the writers on the other classes of *Arthropoda* are not likely to recognize them as coming within their scope.

The stumbling-block of all systems has been the Linnæan order *Neuroptera*, inasmuch as its members combine the characters of most of the other orders, and ingenious American writers have attempted to overcome this difficulty by considering it a collection of "synthetic types." In adopting metamorphosis as the basis of classification, we prefer to take another course, and to follow Erichson, who (in 1839) boldly transferred all these *Neuroptera* with incomplete metamorphoses to the *Orthoptera* as a suborder, although, in dealing with the *Neuroptera* in the light of a specialist, division into several orders appears the more natural course.

The sequence of orders we propose to follow is—as under:—



	HYMENOPTERA.	
	COLEOPTERA.	
Metamorphoses complete ( <i>Metabola</i> ).	DIPTERA.	{ <i>Genuina.</i> <i>Pupipara.</i> <i>Aphaniptera.</i>
	LEPIDOPTERA.	
	NEUROPTERA.	{ <i>Trichoptera.</i> <i>Planipennia.</i> <i>Pseudo-Neuroptera.</i>
Metamorphoses incomplete ( <i>Hemimetabola</i> ).	ORTHOPTERA.	{ <i>Genuina.</i> <i>Heteroptera.</i>
	HEMIPTERA.	{ <i>Homoptera.</i>
No metamorphoses ( <i>Aberant Insecta</i> ).	COLLEMBOLA.	
	THYSANUTA.	

The obvious innovation in this arrangement is the position assigned to the *Diptera*, rendered necessary by the intimate relationship of *Lepidoptera* and *Trichoptera*, but in a metamorphic sense no particular outrage on more generally adopted systems is occasioned, and we see no alternative other than that of widely separating the two subdivisions of *Neuroptera*.

**HYMENOPTERA.**—In accordance with the system adopted by many modern writers, this order heads the scale as containing amongst its members those insects that appear to be endowed with the highest intellectual faculties. But at the same time it must be remembered that if the economy of the *Termitidæ* in the *Pseudo-Neuroptera* had been as fully investigated as has that of bees, wasps, and ants, it is probable that the importance of this idea might be considerably weakened. The main characteristics are as follows:—

Wings four (frequently absent altogether in ants, &c.), membranous, naked, transparent, with open reticulation and very few transverse nervules. Mouth mandibulate. Metamorphosis complete, but the pupa has its members free. Larva mostly apodal, but in the saw-flies much resembling that of *Lepidoptera*.

A convenient subdivision into three great groups is generally adopted, viz., *Aculeata*, *Entomophaga* (or *Pupivora*), and *Phytophaga*.

The *Aculeata* may be again divided into four:—*Mollifera* (or Bees), *Fossores* (Wasps, &c.), *Heterogyna* (Ants and allies), and *Tubulifera* (Ruby-tailed Flies), but the last is perhaps more generally considered as forming a special division. In these the females (and workers, when present) are provided with a sting at the apex of the abdomen, connected with a poison gland. The abdomen is petiolate. The antennæ are mostly thirteen-jointed in the males and twelve-jointed in the females. In the bees the mouth parts are greatly modified, so as to form a suctorial apparatus, by the elongation of the maxillæ, labium, and lingua, the small palpi being borne at its end. The neuration of the wings is tolerably complete. The legs are much modified, according to requirements, such as pollen-gathering, burrowing, &c. The larvæ are apodal, hatched in cells constructed by the parent insects, the food usually provided by them being either honey or other insects. The habits of the group are frequently social (in this case neuters or workers are present); many are parasitic on insects of their own group (in the broad sense), and in many instances the parasites strikingly resemble those species in the nests of which they live (as in the familiar instance of *Bombus* and *Apathus*). Each division includes several families (to which we cannot allude here), and the group as a whole includes some of the most familiar insects, such as bees, wasps, and ants.

The *Entomophaga* are invariably true parasites in the larval stage (excepting the *Cynipidæ*), the perfect insects depositing their eggs in or on the larvæ or eggs of other insects, and their larvæ living upon the adipose tissue or contents of the eggs. There are no true sting and poison gland, but the female usually has the end of the abdomen provided with a long slender ovipositor, with which she can (in some cases) pierce the skin if roughly handled (but no inflammatory symptoms follow). The antennæ are usually long, slender, and multiarticulate. The abdomen is strongly petiolate. The neuration of the wings is variable (often almost absent). The main divisions are *Ichneumonidæ*, *Proctotrypidæ*, *Chalcididæ*, and *Cynipidæ*, chiefly founded on the neuration, which in *Chalcididæ* (and in a lesser degree in *Proctotrypidæ*) is almost absent. Many members of this group are of extreme interest in consequence of their economy, and especially some extremely minute species (in *Proctotrypidæ*) that infest the eggs of other insects, some of which can swim by means of the wings in search of the eggs of aquatic insects. The *Cynipidæ*, although agreeing in main points of structure with

the other divisions, are totally different in habits, and the term *Entomophaga* as applied to them is erroneous (a few, however, are parasitic upon aphides). They lay their eggs in the tissues or buds of plants, and there results therefrom a swelling termed a gall, inside which the larva feeds, either solitarily, or many in one gall in separate cells.

True Phytophagous *Hymenoptera* (or *Terebrantia*) comprise the two divisions known as *Tenthredinidæ* and *Siricidæ*. In these the abdomen, instead of being petiolate, is sessile; the females are provided with a double saw in the *Tenthredinidæ*, and with a borer in *Siricidæ*. The antennæ have seldom more than ten joints. The neuration of the wings is complete. The larvæ differ from those of all other *Hymenoptera* in possessing well-developed thoracic legs, and in addition (excepting in the *Siricidæ*) a varying number of abdominal prolegs, and are so like those of *Lepidoptera* as often to require a practised eye to distinguish them therefrom. All are phytophagous, but their habits are very varied; in fact, all the conditions known in *Lepidoptera* are probably here present also. Some species cause galls. Some (such as the Turnip Saw-Fly) occasion great damage. The *Siricidæ* are wood or stem borers; the familiar *Sirex gigas* often appears in the midst of large towns, through the larvæ or pupæ having been brought in with pine timber.

**COLEOPTERA.**—This is probably the largest, and certainly the best studied, of all the orders.

Four-winged insects, but the upper pair of wings are modified, hard and horny in texture, and are termed "elytra," lying longitudinally over the meso- and meta-thorax and abdomen, and when closed divided by a line or suture (occasionally the elytra are united, and in this case the second pair of wings is usually absent, and the insects are incapable of flight; more rarely the wings are absent altogether, both the elytra and hind-wings). Mouth mandibulate. Antennæ seldom more than 11-jointed (often much less). Metamorphosis complete; the pupa having its members free. Larva extremely variable as to form; usually with thoracic legs, sometimes apodal.

Latreille divided the enormous amount of materials comprised in this order into four great groups according to the number of joints in the tarsi. Thus the *Pentamera* have five joints in all the tarsi; the *Heteromera* have five in the anterior and intermediate tarsi, and four in the posterior; the *Tetramera* have four in all the tarsi, the *Trimera* three in all. More minute investigation and better knowledge have proved, however, that this system is essentially artificial, and in part founded on misapprehension; and it is the custom amongst many modern entomologists to ignore these great divisions, and to consider the order as composed of about 75 families, without collecting them into larger groups. It would be impossible to notice here each of these families in detail, and the old system, still regarded with favour by some of our most intelligent coleopterists as the most useful, will be followed.

The general structure is so marked that but little controversy has been occasioned. A beetle is recognized as such universally, notwithstanding the great diversity of details that exists. The only disputed elements are the *Strepsiptera* (Bee-parasites) and *Platypsylla* (an epizotic parasite on the beaver). The diversity in the larval condition is much greater, and as extremes may be cited the larvæ of the *Staphylinidæ* (in which there is little difference in form and structure from those of the imago, excepting the absence of wings) and the apodal maggots of the *Curculionidæ*. In the pupal condition this divergence mainly disappears.

The *Pentamera* are usually considered to comprise the following superior subdivisions. *Adephaga* alone possess an inner palpiiform lobe to each maxilla; the larvæ are predaceous, and feed on other insects and on flesh generally: they include the *Cicindelidæ* (Tiger-Beetles) and *Carabidæ* (these two groups often termed *Geodephaga*), which are terrestrial, and the *Dytiscidæ* and *Cyprinidæ*, familiar aquatic groups, with the addition of *Amphizoa*, an anomalous American genus, recently referred to *Dytiscidæ*. *Palpicornia* have short clavate antennæ, and comprise a number of small and mostly aquatic genera. *Brachelytra* (including *Staphylinidæ*, known as Rove-Beetles or Devil's Coach Horses) are known by the very short elytra (usually much shorter than the abdomen), and form an exceedingly numerous

group of often minute insects, of which the larvæ are predaceous, and differ but little in form from the imago; with these the curious and aberrant *Psolophidæ* are usually united. *Claricornia* have clavate antennæ, and are sometimes termed *Necrophaga*, from the habit many of the species have of feeding upon dead and decaying animal matter; the forms are very numerous, and include the well-known Burying Beetles (*Necrophorus*) and the destructive *Dermestidæ* (in which is the Bacon-Beetle); *Parnidæ* are aquatic; *Pausidæ* are wonderfully curious creatures with singularly formed antennæ, living in ants' nests: in this division are now placed the almost microscopic *Trichopterygidæ*, most of which are not larger than small grains of sand, and remarkable for their narrow ciliated hind wings, and also other groups sometimes placed in the *Trimera*. *Lamellicornia* have the apex of the antennæ pectinate or provided with lamelliform plates: they include the Stag-Beetles and the very numerous Dung-Beetles, amongst which is the *Scarabæus* of the Egyptians, together with the numerous Chafers. *Sternori* have the prosternum produced and pointed, and mostly filiform antennæ, with ordinarily an elongate oval form: in this division are the beautiful *Buprestidæ* and the familiar *Elateridæ*, the latter known as Click-Beetles, and able to spring by means of the process of the prosternum acting on a peculiar structure of the mesosternum: the larvæ are all vegetable feeders, and have the legs only slightly developed; those of *Elateridæ* are known as Wire-Worms, and are often very destructive; some of the exotic *Elateridæ* are brilliantly luminous. *Malacodermi* are a group of mostly soft-bodied insects very variable in form and habits; the prosternum is not produced, and the antennæ are usually pectinate or serrate: included in it are the *Tephroidæ* (Soldier-Beetles), *Lampyridæ* (Glow-Worms), *Cleridæ* (often parasitic in the nests of bees), the wood-eating *Plinidæ* (in which is *Anobium*, or the Death-Watch), and *Bostrychidæ*.

The *Heteromera* are a large group of forms connected together by the tarsal structure, but otherwise of the most diversified nature; in fact it may be said that, so far as outward appearance is concerned, there are forms in it that might be readily mistaken as belonging to almost all the other principal groups, so protean are they both in structure and in habits. Two principal points of structure have been used for separating them into two great divisions. In one of these they have been divided into *Globicoræ* and *Conicoræ*, according to the form of the anterior coxæ; in the other the two divisions are termed *Atrachelia*, in which the head does not form a neck, and *Trachelida*, in which the head is narrowed into a neck. To some extent both these points of structure are correlated; we adopt the latter; but it must be remarked that the protean nature of the group as a whole is equally exemplified in its primary subdivisions. They appear to be invariably terrestrial, and for the most part phytophagous. The *Atrachelia* are mainly composed of a large number of genera of which *Tenebrio* (the Meal-Worm) may be taken as a type, and *Blaps* (the Churchyard Beetle) is also amongst its members. In the *Trachelida* the forms are more varied, and include some of the most remarkable instances of anomalies of form and structure, and even of metamorphosis, that exist amongst *Coleoptera*. Here are placed the *Cantharidæ* (Blister-Beetles, &c.), so remarkable for the hypermetamorphosis that exists in the larvæ, and parasitic in the nests of bees and locusts; the extraordinary genus *Silaris* (equally hypermetamorphic), a parasite in bees' nests; *Meloe* (the Oil-Beetles, the history of which reads almost like a romance, the very young larvæ being active little creatures living on the bodies of bees, but afterwards becoming obese and almost footless, and feeding on the bee larvæ in the nests); and *Rhipidius*, parasitic on cockroaches. As a crowning point of eccentricity the extraordinary *Strepsiptera* (or *Stylopidæ*) seem likely to find their resting place here, after having been considered a distinct order, as *Diptera*, as *Hymenoptera*, and as *Neuroptera*; but even yet it is probable their position may be warmly disputed. These anomalous creatures are parasitic in the bodies of bees, and the female, which is vermiform, and without antennæ, legs, or wings, never leaves its host, and is viviparous. The male has very large eyes, and extraordinary short antennæ; the anterior wings (or elytra) are represented by small narrow processes, not unlike the halteres of *Diptera*; the posterior wings are folded in repose, but when expanded are extraordinarily broad, whitish in colour, and almost without nervures. The metathorax occupies the greater part of the body; the abdomen is terminated by a short stout process. The very young larvæ are minute, active, and not unlike the young larvæ of *Cantharis* and *Meloe* in form, and escape from the body of the mother by a slit in the neck; they are conveyed into the nests of their hosts, and penetrate the larvæ of the latter, where they undergo hypermetamorphosis. Although originally supposed to be exclusively parasites on *Hymenoptera*, one species has recently been detected in the body of an homopterous insect.

*Tetramera*.—Although the beetles of this great division have apparently only four-jointed tarsi, it was long ago demonstrated by Westwood that there is actually a very minute joint between the lobes of the third joint, so that they are actually pentamerous, but the concealed joint is probably functionless; thus the terms *Pseudo-Tetramera* and *Crypto-Tetramera* have been proposed in lieu

of *Tetramera*. The chief groups are the *Rhyncophora*, *Xylophaga*, *Langicornia*, *Phytophaga*, and *Claripalpi*. All are vegetable feeders. The *Rhyncophora* (or Weevils) have the head produced into a rostrum, varying enormously in length, and in its lowest condition scarcely appreciable. The larvæ are footless grubs, feeding almost universally in the interior of the stems or seeds of plants, and occasionally causing galls. Some exotic members of this group are amongst the most beautiful of insects. A peculiarity exists in the antennæ, which are attached to the rostrum, and usually elbowed, the basal joint being ordinarily very long (and termed the "scape") and the rest shorter, the terminal joints usually forming a club (the portion between the scape and the club is termed the "funiculus"). *Rhyncophora* have been very variously subdivided. Schönherr separated them into *Orthoceri* and *Gonaloceri*, according to the absence or presence of an elbow to the antennæ; Westwood has three families, *Bruchidæ*, *Atelabidæ*, and *Curculionidæ*, founded on the antennæ and palpi; Lacordaire's groups are *Adelognathes* and *Phanerognathes*, founded on the covered or uncovered meotum. Adopting Westwood's system, we have three families. *Bruchidæ* have only a short flattened snout, unelbowed antennæ, and filiform palpi; they are probably universally seed or nut feeders in the larval stage. *Bruchus granarius* causes great destruction to grain; species of the genus *Caryoborus* affect palm-nuts, some even living in the so-called vegetable-ivory nuts; *Anthrribidæ*, which form a subfamily of *Bruchidæ* according to Westwood, live in dead wood. *Atelabidæ* have the antennæ unelbowed, the palpi conical, and the rostrum long and curved; the genera *Brenthus* and *Atelabus* form the types of two subfamilies differing chiefly in the form of the club of the antennæ; the first of these is almost entirely extra-European, and its members appear to feed on dead wood; the second includes the brilliant species of *Rhynchites* (the larvæ of which roll up leaves and feed on them, or live upon fruits) and the minute species of *Apion*, of which the larvæ variously attack seeds, the interior of the stems of plants, &c. *Curculionidæ* have elbowed antennæ and conical palpi, and are further subdivided into two main groups according to the length of the rostrum, each again forming numerous smaller groups; the family contains many of the most familiar weevils, and some of the most destructive; the habits are extremely diversified: *Sitophilus* feeds on grain, *Calandra* in the stems of palms, sugar-cane, &c., *Balaninus* on nuts, *Hylobius* on the wood of pine trees, and a multitude of other instances of peculiar habits might be cited. It must be remarked that other main groupings of *Rhyncophora* considerably modify both the sequence and family position of many genera to an extent that cannot even be glanced at here. *Xylophaga* form a small group sometimes united with the *Rhyncophora*, consisting of small wood-boring beetles, in which the rostrum may be termed obsolete, and the insertion of the antennæ is close to the eyes. Some of the members of this group (of which *Tomicus* and *Scolytus* are familiar examples) are supposed to cause great damage through their larvæ feeding beneath the bark of trees; but it is possible they only appear when an unhealthy condition has been set up from other causes. The *Langicornia* may be mainly distinguished by their elongate elegant form, long antennæ, which are generally filiform, but often pectinate, serrate, or ornamented with tufts of hair, the head not rostrate and armed with powerful jaws, the femora often clavate, and the tarsi having on the basal three joints cushioned beneath. The larvæ mostly feed on dead or dying timber, boring into its interior, and but seldom on living healthy wood, the females being provided with an ovipositor; these larvæ are fat, with very strong mandibles, and extremely short legs; in some species several years elapse before they attain their full growth. The most modern classification recognizes three families, *Prionidæ*, *Cerambycidæ*, and *Lamiidæ*. The *Prionidæ* have the sides of the prothorax margined, and usually toothed, and comprise the largest known beetles in length, even if not in bulk. *Cerambycidæ* have the head porrect, and the prothorax not margined; some authors separate from these a family *Lepturidæ* as of equal value. *Lamiidæ* have the head vertical. The *Phytophaga* form a large group of beetles feeding essentially, in all their stages, on the leaves of plants (hence the name). They are usually of short and thick form, with filiform, moniliform, or serrate (never clavate) antennæ, the head ordinarily immersed in the prothorax and without rostrum, and the elytra covering the sides of the abdomen; the mandibles comparatively weak; the femora often enlarged. The larvæ are usually external feeders, with well-developed legs, and often very curious in form. Much diversity in the classification of *Phytophaga* exists, and as to the number of families and the value of their characters. By Latreille they were divided into *Eupoda* (*Parameræ*, Westwood) and *Cyclica*, of which the most prominent character is in the external form, the *Eupoda* having the head and thorax narrower than the abdomen, whereas in the *Cyclica* the base of the elytra is not broader than the hinder part of the thorax; hence the form is more rounded. Another grouping is according to the insertion of the antennæ at the sides, or on the middle, of the front. The number of families varies from four to nine according to different authors. A glance at the prominent forms, according to later ideas, is here given. *Crioceridæ* (by some divided into *Crioceridæ*, *Doma-*



*ciadæ*, and *Sagridæ*) belong to the *Eupoda*, and include the well-known Asparagus Beetle (*Crioceris asparagi*), the genus *Donacia* (and allies), which is aquatic in its earlier stages, and the brilliant exotic genus *Sagra* (remarkable for its enormously thickened hind femora), the larva of which forms galls on the stems of plants and lives therein. *Cryptocphalidæ* (including *Clythridæ*) are remarkable for the habits of the larvæ, which form hard cases of excrement (?) in which they live. *Chrysomelidæ* are a group of often beautiful insects, mostly remarkable for their nearly hemispherical form; they include, *inter alia*, *Tinarcha* (the Bloody-nosed Beetle), the well-known genus *Chrysomela*, and the Colorado Potato-Beetle (*Doryphora* or *Longitarsus*); most of them distil an acrid fluid; the larvæ are short and obese, feeding exposed and the pupæ often have the remarkable peculiarity of being suspended by the tail. *Halticidæ* are noted for their thickened hind femora and their jumping powers; though small in size, some of the members (e.g., the Turrip-Flea) are most destructive. *Cassididæ* (or Tortoise-Beetles) usually have the sides of the elytra expanded; the larvæ have the very singular habit of concealing themselves under a covering formed of their own excrement, which is sustained by means of a forked appendage at the extremity of the body. Other families (such as *Hispidæ* and *Galerucidæ*) must be passed over. The last division of the *Tetramera* is the *Clavipalpi*, often placed with the *Trimeræ*, and forming a connecting link therewith. They are a small group, with the last three joints of the antennæ forming a compressed club, and the last joint of the maxillary palpi also broadly clavate. The family *Erotylidæ* mainly constitutes the group; the larvæ probably all live upon fungi. In proof of the wide divergence of opinion as to the relationship of special groups, it may be mentioned that one author places certain genera of this group amongst the *Clavicornia* of the Pentamerous division.

The last of the great divisions of *Coleoptera* forms the *Trimeræ*. As in the *Tetramera*, it was discovered that the term is not strictly applicable, and that a minute joint is concealed between the lobes of the second joint of the tarsi, hence they have been called *Pseudo-Trimeræ* and *Crypto-Trimeræ*. Some authors have made this group a place of refuge for many almost isolated forms, the natural position of which it is difficult to suggest. At present, however, only a small number of more homogeneous materials are usually located here, and these are divided into *Aphidiphaga* and *Fungicola*. The *Aphidiphaga* comprise the familiar Lady-Birds (*Coccinella*) and allies; these have the last joint of the maxillary palpi hatchet-shaped, have short-clubbed antennæ, and have the body remarkably hemispherical. They appear to feed chiefly on other small insects in both larval and perfect stages, and aphides are especial articles of diet with them; but the writer has seen a larva of *Coccinella* with its head deeply immersed in the juicy body of a recently formed pupa of its own species. *Fungicola* have the last joint of the maxillary palpi filiform, with longer antennæ, and, as a rule, less hemispherical body. They contain a number of mostly small and little familiar forms, and, as their name indicates, are often found in fungi, on which they no doubt principally subsist.

**DIPTERA.**—Only the anterior (mesothoracic) wings present, membranous, usually naked, with varying longitudinal nervures and but few transverse nervules. Posterior wings replaced by knobbed filaments termed "halteres." Mouth consisting of a rostrum formed chiefly by the extended labium, forming a canal in which the other usual organs, modified into lancet-shaped pieces, are contained, the whole forming a sucker; only the maxillary palpi developed. Thorax consisting almost entirely of the greatly enlarged mesothorax, the two other divisions very small, and scarcely separable from the mesothorax. Tarsi 5-jointed; the end joint with a pair of more or less disciform pulvilli. Metamorphosis complete.

Although it is the generally received opinion that the halteres are the representatives of the posterior wings, there have been those who regard them rather as connected with respiration or hearing, and by some they have even been considered as belonging to the base of the abdomen rather than to the thorax; this latter idea results from the difficulty of defining the true limits of the metathorax. At the base of each anterior wing is a small membranous portion termed an "alulet," not absolutely connected with the wing itself, but which must be considered an adjunct, and certainly not representing a posterior wing.

*Diptera* form one of the most extensive orders. The *Genuina* are commonly divided into two great groups, according to the structure of the antennæ, and termed *Nemocera* and *Brachycera* respectively; but it has long

been seen that these divisions are not natural, especially with regard to metamorphoses, and Brauer proposed division according to whether the larval skin at the last moult opens by a slit down the back or in a curvilinear manner, a proposal he has since extended by demonstrating that those two divisions—*Orthorhapha* and *Cyclorhapha*—are rendered the more natural by the pupal condition being correlated with differences in the larva and perfect insect, and eventually it is probable his views will be generally adopted. Another basis for division is according to whether the pupa is free (sometimes active, but not taking nutriment) or enclosed within the hardened skin of the larva ("obtect" or "coarctate"). The division into *Nemocera* and *Brachycera* is here followed.

In the *Nemocera* the antennæ are long and slender, and composed of a considerable number of small joints, which are often verticillate or plumose. They include the families *Culicidæ*, *Chironomidæ*, *Psychodidæ*, *Cecidomyidæ*, *Mycetophilidæ*, *Tipulidæ*, and *Bibionidæ*, but some authors make a more minute subdivision. All these, and a multitude of others, fall into Brauer's suborder *Orthorhapha*, and the pupa is obtect. Here come some of the most familiar and bloodthirsty members of the order, such as Gnats (or Mosquitos), Midges, Gall-Midges, "Daddy Long Legs," &c., and some of them cause incalculable mischief to the agriculturist. In those species in which the earlier stages are aquatic, the pupa is active.

The *Brachycera* have the antennæ short and thick, not more than three-jointed, but the terminal joint has a bristle (*arista*) which is sometimes articulate. These again have been divided into *Hexachætæ*, *Tetrachætæ*, and *Dichætæ*, according to the number of setæ concealed in the mouth. They are "cyclophagous," and the pupa is coarctate. It is not possible to enumerate here all the families, nor to allude to the extreme diversity of habit and structure that exists. House-Flies, Blow-Flies, Flesh-Flies, Bot-Flies, and Gad-Flies, the beautiful *Syrphidæ* (many of which devour aphides in the larval state), the parasitic *Tachinæ*, the plant-eating *Phytomyzæ*, &c., all belong to this division.

The *Pupipara* are a small group distinguished especially by the fact that the larvæ and pupæ are developed in the body of the mother, and the head is sunk in the thorax; they have even been considered a distinct order termed *Homaloptera*. All are parasitic. They include *Ornithomyia* (Bird-Flies), *Melophagus* (the Sheep-Tick), the extraordinary wingless genus *Nycteribia*, parasitic upon bats, and the perhaps still more extraordinary genus *Braula*, a minute creature known as the Bee-Louse. Brauer terms them *Cyclorhapha pupipara*.

With the *Diptera* (as a distinct section) it is now the all but universal practice to include the *Apheniptera* or Fleas, at one time considered as forming a distinct order. They differ from true *Diptera* in their laterally compressed form, well-defined thoracic divisions, absence of wings (which are represented only by scales), aborted antennæ, developed labial palpi, &c. The mouth of the imago is (as is too well known) formed for suction, and its parts can be homologized with those of the true *Diptera*. The larva is slender and worm-like, and is mandibulate, in all probability feeding on the scaly dæbris or scurf from the skins of the animals attacked; it is not found on the animals themselves, but in their beds or other resting-places. The pupa is inactive. For all practical purposes the *Apheniptera* include only two genera—*Pulex* and *Sarcopsylla*, the Flea and the Chigoe or Jigger. Many mammals and some birds have each its own peculiar species of flea, or more than one, and the size of the tormentor is often in an inverse proportion to that of the tormented, the flea of the mouse being of gigantic proportions. The chigoe is notorious in tropical America for its habit of penetrating the skin of man, especially on the feet, the abdomen of the insect swelling and causing troublesome ulcers. Formerly it was believed that the eggs were deposited in the ulcers and that the larvæ fed therein, but more recent observations tend to prove that the habits are much those of ordinary fleas.

**LEPIDOPTERA.**—Four membranous wings (frequently rudimentary, or sometimes wanting, in the female) clothed with flattened striated scales; neuration open; transverse nervules few; at the base of the anterior margin of the posterior pair is frequently a bristle used for connecting the two pairs in flight. Mouth haustellate, the maxillæ being much elongated and very slender, forming two closely-applied pieces, which together make the suctorial apparatus by means of which the nectar of flowers is pumped up for food; in some groups this apparatus is rudimentary. Labial palpi strongly developed, the maxillary ordinarily rudimentary (but more developed than the other pair in a

few small groups). Prothorax very narrow, with a pair of lateral organs termed *patagia*. Legs slender; tibiae spurred. Metamorphosis complete, all the appendages of the pupa enclosed in common covering with the body, but leaving the parts visible (occasionally, in some of the lower groups, the extremities of the appendages are free). Larva (termed a caterpillar) with six thoracic legs, and with a varying number (never more than 4 pairs) of fleshy abdominal and two anal prolegs (rarely the larva is apodal). With few exceptions, they are phytophagous.

These insects are familiarly known as Butterflies and Moths, and the order contains the most beautiful insects that exist, and forms the most popular and attractive of all for collectors. The scales of the wings (and other parts of the insect) are really modified hairs. Each is a flattened sac, striated on one side, containing variously coloured pigments, the arrangement of scales of different colours causing the beautiful markings and patterns so universal; but metallic colours are due also to interference caused by minute inequalities of the surface, combined with the contained pigment.

The classification of *Lepidoptera* is still in a state of much uncertainty. By collectors they are fancifully divided into *Macro-* and *Micro-Lepidoptera*. A more familiar division is into Butterflies and Moths,—the former being termed *Rhopalocera* (or *Diurna*), the latter *Heterocera* (or *Nocturna*).

The *Rhopalocera* are especially distinguished by their clubbed antennae. The following great groups are tolerably well marked (but each has been much subdivided)—viz., *Papilionidae*, *Nymphalidae*, *Erycinidae*, *Lycanidae*, and *Hesperiidae*. Some split the division into two, according as the pupa is suspended by the tail only, or has a thread round the body as well (these groups are termed *Suspensae* and *Sarcinidae* respectively); the *Nymphalidae* are especially characteristic of the first of these. In the *Nymphalidae* the anterior legs are not fully developed in either sex; in the *Erycinidae* and *Lycanidae* this occurs only in the males. The *Hesperiidae* have the club of the antennae terminated by a hook, and the position of the wings in repose differs ordinarily from that in the other groups; the pupa is enclosed in a rudimentary cocoon, and may even be subterranean.

The *Heterocera* are subdivided roughly into *Sphingidae*, *Bombycidae*, *Noctuidae*, *Geometridae*, *Pyralidae*, *Tortricidae*, *Trichidae*, and *Pterophoridae*; but much more minute subdivision is adopted by specialists. In these the form of the antennae is very variable (as the name implies), and the bristle on the posterior wings is usually (not always) present. The *Sphingidae* (which comprise some of the largest and most robust moths) usually have the antennae fusiform towards the tips. *Bombycidae* generally have the antennae of the male strongly pectinate, and those of the female simple or nearly so; the larva with four pairs of abdominal prolegs (and the anal pair); but this is a group of extremely heterogeneous materials, if taken in its widest sense; it includes the Silk-Worm Moths as familiar examples, and many extraordinary forms, amongst which may be mentioned the curious *Psychidae*, in which the larvae manufacture portable cases wherein they live, and in which the females are apterous. Perhaps allied to this group, or intermediate between it and the *Sphingidae*, is the curious and abnormal collection of pretty insects termed *Castaniidae*, at one time considered to be butterflies, and even yet included with them by some authors. The haustellum is rudimentary in the true *Bombycidae*. The *Noctuidae* are stout-bodied moths, mostly (but by no means always) of nocturnal habits; the antennae greatly varying, but not thickened; the bristle on the posterior wings present; the haustellum present (in one genus, *Ophideres*, it is strong enough to pierce the skin of oranges). They are mostly divided into two groups according to the number of the prolegs in the larva (four, or only three, abdominal pairs), and the venation of the posterior wings. The larva are usually nearly smooth (those groups with hairy larva are by some transferred to the *Bombycidae*), and the pupae subterranean. *Geometridae* are especially distinguished by the presence of usually only one pair of abdominal prolegs, occasioning a peculiar form of locomotion, termed "looping"; antennae varying; bristle of posterior wings present; the wings usually expanded when at rest. With apparent relations to these is the small group *Uranidae*, consisting of beautiful papilioniform insects, still by some placed with the butterflies. *Pyralidae* form a special group of varying, and for the most part rather small, insects, with simple (or nearly simple) antennae; long slender legs; the bristle of the posterior wings present; long palpi; larva with three to five pairs

of abdominal prolegs, and mostly smooth and glossy in appearance. *Tortricidae* are small insects of nocturnal form when at rest (the wings being horizontal and not expanded); antennae simple; bristle of posterior wings absent; haustellum short; palpi short; larva with four pairs of abdominal prolegs. Many of the species of this group do immense damage to trees and garden plants. The *Tineidae* is an immense group of mostly small (often very minute) insects, with extremely varying structure and habits. They may always be distinguished from the *Tortricidae* by the long palpi (the maxillary pair being sometimes strongly developed and exceeding the labial); the fringes of the wings are usually very long. Some of these minute forms are excessively beautiful. The group as a whole is made up of very incongruous materials. *Pterophoridae* are a small group at once distinguished by the wings being split up into linear divisions, hence they have been termed "plumes." By some they are not considered distinct from the *Pyralidae*, with which there is considerable structural affinity.

**NEUROPTERA.**—Four membranous and for the most part densely reticulate wings, more or less clothed with hairs, but without true scales; very frequently the hairs are on the venation only. Mouth mandibulate. Metamorphosis complete, but the pupa has its members free.

In the outline of classification (at p. 147) proposed to be adopted in this article, it is stated that the *Neuroptera* as there indicated are considered as forming a single order, more as a matter of convenience than from any conviction of the homogeneity of the two divisions.

The *Trichoptera* (or Caddis-Flies) form a very natural and sharply defined group distinguished by their rudimentary mouth-parts, with the exception of the two pairs of palpi, which are strongly developed, the maxillary pair being the longer, and with often the greater number of joints; the antennae setaceous; wings with comparatively simple venation and but few transverse nervules, ordinarily covered with hair (which sometimes simulates scales); larva (known as Caddis-Worms) with well-developed thoracic legs, and anal crotchets, but without prolegs, living in tubes covered with extraneous materials; pupa lying free in the case, or occasionally in a special cocoon, only active just before its metamorphosis; habits (with one or two exceptions) aquatic.

It is considered by the writer that there is direct relationship of the *Trichoptera* with the *Lepidoptera*, and this idea acts as the key to the scheme of classification adopted. They are divided into seven families, viz., *Phryganidae*, *Limnophilidae*, *Sericostomatidae*, *Lalocoridae*, *Hydropsychidae*, *Rhyacophilidae*, and *Hydroptilidae*, chiefly according to the structure of the maxillary palpi. In the *Rhyacophilidae* and *Hydropsychidae* the larva inhabit fixed cases, in the others the cases are free, and carried about by the inmates; in the *Rhyacophilidae* the pupa is enveloped in a special cocoon. The venation shows strongly-marked homology with that of *Lepidoptera*.

The *Planipennia* (or true *Neuroptera* according to modern ideas) have strongly-developed mandibulate mouths; for the most part moniliform or filiform (often clavate) antennae; the wings ordinarily densely reticulate, with very numerous transverse nervules, the membrane hairless or nearly so. The larva is more divergent from the *Lepidopterous* type. The pupa is ordinarily in a cocoon; it is active just before its transformation. A convenient subdivision is into *Panorpidae*, *Stictidae*, and *Megaloptera*.

The *Panorpidae* (Scorpion-Flies, &c.) are remarkable for the mandibles, &c., being situated at the end of a long beak, formed by the much-elongated clypeus above and the lower lip beneath. The wings have open reticulation, and the larva is more vermiform than in the succeeding groups, so that the relationship to the *Trichoptera* is close. They are carnivorous both in imago and larva, and the latter is subterranean. *Panorpa* is remarkable for the cheiliform termination of the abdomen, *Diltacus* for its tipuliform aspect, *Dorcus* for its nearly apterous condition.

The *Stictidae* form a heterogeneous group of small subdivisions with setaceous antennae (which are sometimes pectinate); strongly developed prothorax; the third or fourth joint of the tarsi cordate. They are again divided into two sections (or families), of which *Rhaphididae* and *Stictis* may be taken as the types. The former (Snake-Flies) are especially remarkable for the enormously elongated prothorax (the anterior legs at its posterior extremity); the larva sub-cortical. The latter comprise mostly large insects with strong (but not greatly elongated) prothorax and ample wings, the larva of which are aquatic, and provided with lateral branchial plates; the genus *Cryptalis* is remarkable for the enormously elongated mandibles of the male (but not in all species).

*Megaloptera* contain many groups of insects, with mostly moniliform (or clavate) antennae; densely reticulate broad wings; varying prothorax; tarsal joints not dilated. The number of subfamilies is large. The most prominent forms are the *Mantispidae*, with their long prothorax (the anterior legs at its anterior end), the larva of



which live in the nests of spiders (and also tree wasps), and in *Mantispa* undergo a kind of hypermetamorphosis; the *Nemopteridae*, with their linear posterior wings; the Ant-Lions, with their clavate antennæ and trap-forming larvæ; the *Chrysopidae* and *Hemerobiidae*, known to feed on aphides in their larval stage,—the former often emitting a disgusting odour; and the very curious little *Conopsepygidae*, covered with a whitish waxy secretion, and differing from all others in the extremely simple neurulation. In *Osmylus* and *Sisyra* the larvæ are aquatic; and those of the latter have been found in the interior of the freshwater sponge.

**ORTHOPTERA.**—Typically with four densely reticulate unequal wings (or apterous), whereof the anterior are more or less coriaceous, the posterior folded under them, and membranous; in the most typical groups they are deflexed, and closely applied to the body longitudinally in repose. Mouth mandibulate. Metamorphosis incomplete.

Having adopted metamorphosis as a basis for classification, it became necessary to view this order after the manner universal amongst German systematists, and to include in it many groups that are ordinarily accepted as neuropterous, the only plan possible without the erection of independent orders for their accommodation. The result is that more absolute homogeneity from a general point of view is attained, and we have to deal with an order made up of otherwise most incongruous elements, but somewhat relieved by the sharpness with which the great groups are defined. Regarding the two great divisions, *Pseudo-Neuroptera* and *Orthoptera genuina*, as a whole, the main distinction really consists in the fact that in the former the four wings pair are more or less coriaceous; whereas in the latter the anterior pair are more or less coriaceous; another difference is in the head, which in the former is horizontal, whereas in the latter it may be described as vertical; but this distinction only applies to the typical groups. Thus there is really little more difference than exists between the two great divisions of *Hemiptera*, now almost universally placed in one order.

Naturally allowing the *Pseudo-Neuroptera* the first place as following on from the true *Neuroptera* (though some would say the Dragon-flies are really the typical *Neuroptera* of Linnæus), these must be first considered. Adopting the descending scale, the main groups may be glanced at as follows:—

The *Odonata* (Dragon-flies; constituted an order by Fabricius) may be considered the most highly organized, with regard to their powerfully mandibulate mouth, strong, densely reticulate wings, &c. The special peculiarities of this group (including the extraordinary structure of the mouth in the preparatory stages, and the anomalous position of the genital organs in the male) have been fully discussed in the article DRAGON-FLY (*q.v.*).

The *Ephemeroidea* (see EPHEMEROIDEÆ) follow. After these come the *Perlidae*, aquatic insects in their preparatory conditions, remarkable for the comparatively weak development of the mouth parts (shared with the *Ephemeroidea*) in the perfect state, the four wings longitudinally horizontal and overlapping, the stout quadrate or oblong prothorax, the frequent presence of two articulated tails, the long setaceous antennæ, &c. This group is also remarkable as being the first in which the persistence of external branches in the imago was detected (a peculiarity since found to be of frequent occurrence in them, and extending to other orders). They are known familiarly as Stone-Flies, and form a large portion of the stock-in-trade of an angler.

The *Embiidæ* constitute a very small group, which in general form much resemble *Perlidae*, but have, on the other hand, affinities with the white ants. The larvæ live habitually under stones in little galleries, and a recent discovery appears to prove that they feed on roots.

*Termitidæ* (or White Ants, placed by some authors in the true *Orthoptera*) are social insects living in immense communities, and forming nests on the ground or on trees. In some respects there is analogy between these and social *Hymenoptera*, and the diversity of condition in a single species is even greater. Winged forms of both male and female exist (the wings being shed at a certain time), and there are also commonly apterous forms known as workers and soldiers, whose office it is to build the dwellings and protect the inmates, the soldiers having the head provided with a powerful horn or elongated mandibles. Each condition has its own special immature form, so that it is probable no more specially polymorphic insects exist. The wings are carried horizontally and overlapping in repose; the prothorax is well developed, and the

tarsi are four-jointed. Recent observations tend to show that specially prepared food (comminuted wood) is provided for the larvæ.

*Psocidæ* are a small group of small insects remarkable for their swollen face, setiform antennæ, narrow prothorax, and large mesothorax, four-jointed maxillary palpi, and rudimentary labial palpi, two- or three-jointed tarsi. The wings are deflexed (often absent), with ordinarily very open venuration. These insects live on fungi and debris and also occasionally on dry animal substances, as in the case of the Book-Louse, ordinarily so abundant in neglected collections of insects, and erroneously supposed to occasion a ticking like that of *Anobium*.

There remain two groups the position of which has occasioned much controversy, but which are now often placed here, not, perhaps, because the affinities are very marked, but more to accommodate them with a resting-place in a division of *Insecta* the characters of which are so very elastic.

The first of these are the *Thysanoptera*, considered a distinct order by Haliday, the founder of the name, and by Burmeister placed in his order *Gymnognatha* as a distinct group termed *Physopoda*; by some authors they are placed in the *Hemiptera*. It is true that the mouth forms a short rostrum with only bristle-like mandibles, but the presence of distinct palpi would appear definitely to inviolate the position in *Hemiptera*. The wings are four in number, lying horizontally on the back and crossing at the tips; they are very slender, membranous, without nervures or nearly so, and strongly ciliated, or they may be wanting in some species, even in the perfect state. These insects are familiarly known as *Thrips*, and sometimes occasion much damage to various kinds of plants by sucking the juices, which the almost haustellate nature of the mouth enables them to do. They are mostly very minute insects, and have been divided into many sections and genera on structural characters.

The second of the above-mentioned groups is the *Mallophaga* (or Bird-Lice), which it is convenient to separate from the *Anoplura* (or true Lice) on account of the structure of the mouth, which is mandibulate and also carries palpi. On account of the absence of metamorphoses, some place them (with the *Anoplura*) as outside the pale of the *Insecta*, but they may be regarded as degraded *Pseudo-Neuroptera*. They for the most part live on the feathers of birds (each bird having its particular parasites), but a few also on mammals.

What may be termed *Orthoptera genuina* consist of groups for the most part very sharply defined.

The *Blattidæ* (or Cockroaches) form the order *Dictyoptera* of Leach. These are insects of flattened form, with four horizontal wings (or apterous), of which the anterior pair are considerably coriaceous, but with distinct venuration; the head small; tarsi five-jointed. The eggs are not laid separately, but are contained in a common capsule which is carried about by the female at the extremity of her abdomen. There are many genera and species, of which latter the abundant *Periplaneta orientalis* is the most familiar.

*Forficulidæ* (or Earwigs) form the order *Euplectoptera* of Westwood and the group *Dermatoptera* of Burmeister. Externally they much resemble *Colcoptera* of the family *Staphylinidæ* in form (but with pincer-like appendages at the extremity of the abdomen), the anterior wings being abbreviated and coriaceous, separated by a suture, and concealing the ample but folded posterior wings (but some forms are apterous); the tarsi three-jointed. The eggs are deposited in cavities in the earth, and are guarded (at any rate in some) by the mother.

*Mantidæ* are mostly large elongate insects with strongly developed raptorial anterior legs (hence the insects are carnivorous). The prothorax very long; tarsi five-jointed; wings often ample or frequently wanting, all reticulate, but the anterior pair slightly more coriaceous. The earlier states greatly resemble the perfect insect without wings. The eggs are contained in a kind of case formed of a secretion voided with them, in which they are arranged in rows, the whole mass being attached to twigs, &c.

*Phasmidæ* (Spectres, or Walking-Sticks) have considerable external resemblance to the former, but the anterior legs are not raptorial, and the insects are phytophagous. The wings (when present) are usually much shorter than the abdomen. Most of the species mimic (as do those of the last family) leaves or twigs, often to such a degree that it is hard to imagine one is regarding an insect.

*Gryllidæ* form the first of a division termed *Salutaria* (as opposed to *Cursoria* or *Gressoria*), from the structure of the hind legs fitting them for jumping. The antennæ are long and setaceous; tarsi three-jointed; anterior wings lying horizontally over the folded posterior. The males mostly produce sound by a special structure at the base of each anterior wing acting on the posterior. This family is made up of materials presenting considerable diversity, but may be grouped roughly in two, according as the anterior legs are formed for digging (Mole-Crickets) or for running (Crickets).

*Locustidæ* have the antennæ very long and slender; the tarsi four-jointed. The anterior wings longitudinally deflexed. The female ordinarily has a broad curved ovipositor suitable for forming



grooves in bark, or earth, in which the eggs are deposited. They are mostly phytophagous, but in some cases carnivorous also. The males are usually very noisy,—with special sound-producing organs at the base of the anterior wing.

*Acrydiidæ* differ from the last chiefly in the antennæ, which are shorter and thick, and in the three-jointed tarsi. The female has no produced ovipositor. They are phytophagous, and the eggs are mostly laid in earthen tubes. This family includes (according to modern classification) the true Locusts, notwithstanding the application of the term to the last-mentioned. Sound is produced by friction of the hind thighs against the nervures of the anterior wings.

The *Orthoptera* have here been treated in a somewhat more detailed manner than other orders, on account of the bearing of the materials on the classification of insects in general, and the sharply differentiated nature of these materials in particular.

**HEMIPTERA.**—This order consists of insects of very varying structure. Primarily there are two great divisions, known as *Heteroptera* and *Homoptera*, by some considered distinct orders. The points in which they agree consist especially in an imperfect metamorphosis, and the structure of the mouth, which latter is of a very simple nature, consisting of an elongated articulate tube formed by an extension of the labium into a suctorial organ, concealed in which are bristle-like mandibles and maxillæ, and probably rudiments of maxillary palpi. The tarsi have from one to three joints.

In the *Heteroptera* (or true Bugs) the anterior wings are horizontal, and composed of two distinct parts, the basal portion (or corium) being coriaceous, and the apical portion (or membrane, often undeveloped) being membranous with distinct longitudinal venation, which latter is only faintly indicated in the coriaceous portion. In repose the membranous portion of one wing overlaps that on the other. The posterior wings are concealed under the anterior, folded, membranous, and with only few nervures. Apterous forms are not uncommon, and sometimes the posterior wings are wanting. This division is again divided into two, *Gymnocerata* and *Cryptocercata*, in the former of which the antennæ are composed of few elongate slender joints, while in the latter the joints are still fewer, short and thick, and ordinarily concealed under the head. Modern writers have erected a multitude of small subdivisions which cannot be enumerated here. The *Gymnocerata* are broadly divided into the following families, viz., *Scutelleridæ*, *Pentatomidæ*, *Coreidæ*, *Leptidæ*, *Lygæidæ*, *Copidæ*, *Tingididæ*, *Reduviidæ*, *Emesidæ*, and *Saldidæ*, founded on different points in the structure of the antennæ, rostrum, scutellum of mesothorax, tarsi, &c. They are terrestrial, and suck the juices of plants or animals. The entire family *Reduviidæ* are probably blood-suckers, and members of other families as above given are notorious for a similar habit, amongst which may be particularly noticed the genus *Acanthia* (including the Bed Bug); but the greater part are plant bugs. Most of them are remarkable for emitting a peculiar and often disgusting odour. The *Cryptocercata* are entirely water bugs, often of extraordinary form, and sometimes gigantic in size. They include the families *Hydrometridæ*, *Gerridæ*, *Galgulinæ*, *Nepidæ*, and *Notonectidæ*. They prey upon animals. One genus (*Halobates*) is remarkable for its pelagic habits, being found on the surface of the ocean very far from land. Many others, such as *Notonecta* (Water Boatmen or Toe-biters), *Nepa*, *Ranatra*, &c., are very familiar insects.

The *Homoptera* have the wings for the most part deflexed, and the anterior pair not separated into two parts. Often all the wings are membranous, with strong nervures; in others the anterior pair is coriaceous. The division regarded as a whole is very polymorphic. The true *Homoptera* have three-jointed tarsi. They may be divided into *Cicadidæ* (remarkable for the sound-producing organs at the base of the abdomen of the male), *Fulgoridæ* (known as Lantern-flies, but now known to produce no light; having the head greatly prolonged in front), *Lystridæ*, *Cixiidæ* (comprising many little plant-hoppers), *Issidæ*, *Derbidæ*, *Flatidæ*, *Tettigometridæ*, *Membracidæ* (often of most extraordinary forms), *Cercopidæ* (included in which is the Cuckoo-Spit Insect), *Ledridæ*, and *Jussidæ*,—all vegetable feeders. The more aberrant *Homoptera* include well-marked groups. The *Psyllidæ* are small plant-sucking saltatorial insects with four membranous wings which lie longitudinally deflexed in repose, and with very narrow prothorax, and eight- to ten-jointed antennæ; they often occasion much damage; the larvæ are frequently covered with a cottony secretion. The *Aphidæ* are the familiar Plant-Lice, the winged forms of which have those organs membranous, and often extended in repose. The antennæ are five- to seven-jointed. The diversity in form and habits is enormous, and, as is well-known, there are winged and apterous forms in the same species, and parthenogenetic generation of the most extraordinary nature; and the same species may be both oviparous and viviparous.

Most of them void a sweet secretion from abdominal tubes, known as honey-dew, for which they are "milked" by ants. The destruction they occasion to plants is very great; as a now too familiar instance of this, the *Phylloxera vastatrix* of the grape-vine may be cited. *Coccidæ* (or Scale Insects) have the male two-winged, the female apterous, and living all her life as a fixed "scale" on plants, the organs being of the most rudimentary nature; the eggs lying under the scale in great numbers; the tarsi with only one joint; parthenogenesis occurs also in this group; the male in its earlier stages lives under a special scale. The Cochineal Insect is one of the best known in this group. The little family *Aleurodidæ* consists of minute insects covered with a white waxy secretion. They have four almost nerveless wings in both sexes, two-jointed tarsi, the abdomen without secreting tubes, and do not live under scales. In the *Hemiptera* it is now the fashion to include the *Anoplura*, or true Lice (some also place here the *Mallophaga* or Bird-Lice), a degraded form of this order, without metamorphosis. Here it is preferred to let them rest in this article, even although some writers do not consider them true insects. The mouth parts certainly have indications of a rostrum, and there are no palpi, and, but for the absence of metamorphosis, there would be little difficulty in fixing the position here as without doubt. All, as is well-known, are epizotic parasites on man and other *Mammalia*, each species being confined to a special host, while attempts have been made to prove that the Head-Louse (*Pediculus capitis*) varies according to the races of men to which it is attached. Perhaps the Crab-Louse (*Phthirus pubis*) is regarded with greater disgust than is bestowed upon any other living creature.

**COLLEMBOLA and THYSANURA.**—In the introductory notes to this article (p. 141) it is stated that "although it is not difficult to define an insect, speaking broadly, there are certain small groups that do not satisfactorily fall into the class as limited by strongly-defined lines of demarcation." The writer there had especially in view those lice known as *Mallophaga* and *Anoplura*, and the two groups indicated in the heading of this section, groups in which metamorphosis, the key of his ideas as to classification, and embodying an essential requisite in an insect according to common acceptance, is wanting. In the time of Linnæus, when we were only outside the threshold of knowledge, it may have been sufficient (and perhaps prudent) to include these groups in an order *Aptera*. But accumulation of knowledge soon dispersed that incongruous order. Such of its elements as could with justice be considered insects have been distributed amongst the various orders. We have not hesitated here to regard the *Mallophaga* as degraded *Pseudo-Neuroptera*, nor the *Anoplura* as equally degraded *Hemiptera*, notwithstanding that some veterans in entomological science may still dispute their position as true insects. There is a breaking-point to elasticity even in ideas of classification, and with regard to the *Collembola* and *Thysanura* we gladly avail ourselves of the assertion of Lubbock to the effect that they are scarcely within the pale of the true *Insecta*, notwithstanding the efforts made to locate them in that convenient refuge for the destitute, the *Pseudo-Neuroptera*. It is certain that the writers in the present work on other classes of *Arthropoda* will not accept them, and it becomes necessary that they should not be forgotten. If insects at all, they have in the process of evolution lost the chief attributes of insects, or have never acquired them. Generally both groups are accepted as *Thysanura*, or as forming two families—*Poduridæ* (= *Collembola*) and *Lepismatidæ* (= *Thysanura*).

In the *Collembola* the antennæ are short, thick, and few-jointed; the eyes are composed of groups of simple "eye-spots" (much as in the larvæ of true insects) varying in number; the mouth organs mandibulate, subject to modifications of a haustellate nature; the palpi quite rudimentary; the abdomen consisting of six segments, and ordinarily provided beneath with a saltatory apparatus (which may, however, be rudimentary); no caudal setæ. The body is often clothed with prismatic scales, not unlike those of *Lepidoptera*. Ordinarily they are minute animals, living in damp places, and sometimes found gregariously. An elongate form is the most general, but *Sminthurus* and *Papirus* are short and obese. Lubbock recognizes six families.

The true *Thysanura* are elongate creatures, not unlike the larvæ of *Ephemeridæ* in form. The antennæ are long, slender, and multi-articulate; the eyes large, compound, and contiguous (or absent);



the mouth mandibulate; the palpi well developed; the abdomen consisting of ten segments, with long caudal appendages. Lubbock forms three families. In some of the genera the scales form beautiful microscopic objects; in others they are replaced by hairs. *Lepisma saccharina*—sometimes termed the "Silver Fish"—is a familiar example of *Thysanura*. The genus *Campodea* is especially interesting as being considered by some as the representative of the primitive form of insect, whence all others have been evolved.

**Bibliography.**—Bibliotheca and Annual Records.—H. A. Hagen, *Bibliotheca Entomologica*, 2 vols., Leipzig, 1862-3, notices all that has been written on the subject up to date; "Berichte über die wissenschaftlichen Leistungen im Gebiete der Entomologie," in Wiegmann's *Archiv*, 1835-1889; *Zoological Record*, London, 1865-1881. General Handbooks.—W. Kirby and W. Spence, *An Introduction to Entomology*, 4 vols., 1815, 1817, and 1826, new edition in 1 vol., 1856; the latter practically includes only vols. I. and II. of the first edition; J. O. Westwood, *An Introduction to the Modern Classification of Insects*, 2 vols., 1833-1810; H. Burmeister, *Mammal of Entomology*, translated by Shuckard, London, 1836; A. S. Fockard, *Guide to the Study of Insects*, 6th edition, New York, 1878; E. Blanchard, *Histoire des Insectes*, 2 vols., Paris, 1845; C. E. A. Kräckel, *Handbuch der Zoologie*, vol. II., Leipzig, 1863; M. Girard, *Les Insectes; Éléments d'Entomologie*, Paris, 1873-1880, in progress. Geographical Distribution.—A. R. Wallace, *The Geographical Distribution of Animals*, 2 vols., London, 1876; Id., *Island Life*, London, 1880. Economic Entomology.—J. Cresson, *Farm Insects*, London, 1850; J. T. Ratzeburg, *Die Forst-Insekten*, 3 vols., Berlin, 1839-1844; J. H. Kaltenbach, *Die Pflanzenfresser aus der Klasse der Insekten*, Stuttgart, 1874; B. Altum, *Forstzoologie Insekten*, 2 vols., Berlin, 1874-1877; E. L. Taschenberg, *Entomologie für Gärtner und Gartenfreunde*, Leipzig, 1874; C. V. Riley, *Reports*

on Noxious and Beneficial Insects of the State of Missouri, 6 vols., Jefferson City, 1870-1877; see also Kirby and Spence, *et supra*. Insects and the Fertilization of Plants.—C. Darwin, *On the various Contributions by which British and Foreign Orchids are Fertilized by Insects*, 1862; Id., *Animals and Plants under Domestication*, 2 vols., 1868; Id., *Different Forms of Flowers*, 1880; J. Lubbock, *British Wild Flowers in relation to Insects*, 1875; H. Müller, *Die Befruchtung der Pflanzen durch Insekten*, Leipzig, 1873; Id., *Algenblumen, ihre Befruchtung durch Insekten und ihre Anpassungen an dieselben*, Leipzig, 1881. Anatomy, Physiology, Chemistry, &c.—Works by Kirby and Spence, Westwood, Burmeister, Packard, and Blanchard, *et supra*; G. Newport, article "Insecta" in Todd's *Cyclopædia of Anatomy and Physiology*, 1839; R. Owen, *Lectures on the Comparative Anatomy and Physiology of Invertebrata*, 2d edition, 1855; C. T. E. von Siebold, *Lehrbuch der vergleichenden Anatomie der wirbellosen Thiere*, Berlin, 1848; Id., *A True Parthenogenesis in Moths and Bees*, translated by W. S. Dallas, London, 1857; C. Gegenbaur, *Grundriss der vergleichenden Anatomie*, 2 vols., Leipzig, 1877; T. H. Huxley, *Mammal of the Anatomy of Invertebrated Animals*, 1877; E. Brandt, articles in the *Horæ Societatis Entomologicae Rossicae*, St Petersburg; F. M. Bal-four, *A Treatise on Comparative Embryology*, 2 vols., 1880; A. Guineec, *Physiological Chemistry of the Animal Body*, vol. II., 1880. Metamorphosis.—J. Lubbock, *Origin and Metamorphoses of Insects*, 1874; M. Girard, *Les Métamorphoses des Insectes*, Paris, 1874, and the general handbooks noticed above. Classification and Special Entomology.—An analysis of the various schemes proposed by the principal systematists is to be found in the works noticed under the heading "General Handbooks," up to the date of their publication; those by Kirby and Spence, Westwood, Burmeister, Packard, and Gerstaecker are most recommended. For a much condensed account, F. P. Pascoe's *Zoological Classification*, 2d edition, 1880, will be found useful. For information on special orders or groups of insects, reference should be made to the "Register" at the end of the second volume of Hagen's *Bibliotheca Entomologica*, or to the German *Derichtel* and the English *Zoological Record*. (R. McL.)

INSPIRATION is the Latin equivalent of *θεοπνευστία*, and is used to express the fact that holy men of old spoke as they were moved by the Spirit of God. The idea is not exclusively Christian or Jewish; pagans have had their inspired speakers and writers and their ideas of inspiration, and these earlier pagan notions have had their effect on some of the forms which the Christian doctrine has assumed.

The classical languages contain many words and phrases expressive of this idea, e.g. *θεοφόροι* (Æsch., *Agam.* 1150), *θεοπνευστοι* (Plut., ii. 904 *sq.*; cf. 2 Tim. iii. 15), *θεορόπου* (*Iliad* and *Odyssey*, *passim*), *ἐθεο* (Plato, *Phædr.* 244), *μανόμενοι*, *divino numine affliti*, *divino spiritu instincti*, *inspirati*, *furentes*. Artistic powers and poetic talents, gifts of prediction, the warmth of love, and the battle frenzy were all ascribed to the power of the god possessing the man inspired. And these words were taken over into Christian theological writing, and used to describe what Jewish and Christian divines have called inspiration. This transference of terms, which was unavoidable, produced, however, a certain confusion of thought; for pagans and Christians meant by inspiration two different things. When a pagan described inspiration, he did so by stating the marks of the state into which the inspired person fell when the fit seized him; a Christian theologian on the other hand was chiefly concerned with the result of inspiration. What the inspired person said or did or commanded was of less moment to the pagan philosopher than the fact that he was possessed, that he was passive in the hands of the inspiring deity, that he was no longer himself but the god who for the moment dwelt in him and used him as he might an inanimate instrument. But in Christian theology inspiration always has to do with the belief that God has "wholly committed to writing" His revelation, and the psychological character of the state of inspiration is of small account compared with the fact that inspiration, whatever it may be, has for its result that God's revelation has so been committed to writing that men have it permanently, fully, and in an infallibly trustworthy way. In pagan literature *θεόπνευστος* is applied primarily to men who have been possessed; in Biblical and ecclesiastical language its primary use is to denote the writings which are the result of inspiration. The words in the mouth of a pagan mean primarily the psychological state, in the mouth of a Christian they mean the characteristics of a book or set of writings.

The doctrine of inspiration in Christian theology contains very little reference to the psychological state of the persons inspired, and when it does enter into such details we may

generally trace their presence back to the influence of pagan ideas or words; it has to do with the characteristics of the writings which have been inspired. In short, the problem of inspiration in Christian theology very much comes to this:—In the Bible we have God's revelation wholly committed to writing; what are we to infer from this about the Bible? And the varying answers given to this question form the history of the doctrine. Theology distinguishes between revelation, inspiration, and the canon of Scripture. Revelation is the objective approach of God to man, God entering into human life and history for man's salvation; Scripture is the record of this revelation, and inspiration provides that the record is complete and trustworthy; while the canon of Scripture gives the list of inspired writings.

It does not belong to an historical article like this to describe more minutely the doctrine of inspiration or its basis in Scripture and in the Christian experience; all that can be done here is to state as concisely as possible various answers made to the main problem involved.

1. *Jewish Theologians.*—Our knowledge of the opinions of ancient Jewish thinkers about inspiration comes chiefly from the Apocrypha, from Josephus, and from Philo Judæus. The writers of the Apocrypha do not give us any theory or doctrine of inspiration, but it may be easily gathered from what they say that they regarded the Scriptures of the Old Testament as the word of God, and therefore worthy of all reverence. It is in 1 Macc. xiii. 9 that the expression *τὰ βιβλία τὰ ἅγια* is first used of Old Testament books; and it is evident that the Pentateuch or the books of the law were held in special reverence, but beyond this we do not find a doctrine of inspiration. Nor does Josephus formally state or discuss the dogma in his writings, but his language shows that he and his contemporaries believed that the Old Testament Scriptures were the word of God. The Old Testament he calls prophecy, and he declares that down to the time of Artaxerxes there was a regular succession of prophets which since then has ceased (*Contra Apion*, lib. i. c. 8.). It is Philo who first seeks to give a theory of inspiration, and he does so by bringing the reflexions of Plato upon the pagan inspiration or *mania* to explain the Jewish doctrine. Following Plato, Philo says that inspiration is a kind of "ecstasy," and he seems to imply that the degree of inspiration is greater in proportion to the unconsciousness or at least to the passivity of the man inspired. The prophet, he says, does not speak any words of his own, he is only the instrument of God, who inspires and who speaks through him (*De*

*Specialibus Legibus*, § 8); but he says that there are degrees of inspiration, and that all portions of Scripture are not equally inspired, or at least have not the same depth of inspiration. Moses has the first place in the scale of inspired writers; he is ἀρχιπροφήτης, while others are Μουσῶν ἑταῖροι, μαθηταί, θασσῶται, φοιτηταί, γινώριμοι; but this idea of degrees of inspiration, a conception borrowed from Plato, does not seem to prevent Philo from thinking that the very words of the Old Testament were all inspired of God (*Vit. Mos.*, 2, § 7). It was also a common opinion among the Rabbins of the early Middle Ages that the inspiration of the Old Testament required that, not merely the thoughts and words of Scripture, but even the vowel points and accents were themselves of divine origin; but this idea seems to have been compatible with the theory that there were three degrees of inspiration, the highest being the inspiration of the Pentateuch and the lowest that of the Hagiographa.

2. *The Church Fathers.*—The early Christian church seems to have simply taken over the Jewish views about the inspiration of the Old Testament; and, when the New Testament canon was complete, they transferred the same characteristics to the New Testament writings also. It is evident that the early fathers of the church wished to teach that the complete knowledge of the salvation of God revealed in Christ was to be found in the Holy Scriptures because they were the book of God, but it is difficult to gather any consistent doctrine of inspiration from their writings, and when they do speak of inspiration it seems as if they were thinking more of the psychological process going on in the mind of the inspired man than of the result in the character of an inspired book. It was perhaps difficult for men educated in the principles of heathen philosophy to avoid applying their early belief about the pagan *μανία* to explain or define the Christian idea of inspiration. At all events we find the doctrine of inspiration described under such metaphors as the Platonists were accustomed to use: the inspired writer was the lyre, and the Holy Spirit the plectrum; the writer was the vase, and the Spirit filled it; and Montanus could appeal to the almost unanimous idea of the church that prophecy implied both passivity and ecstasy. This view of inspiration was strengthened by the Apologists, who were accustomed to plead for the credibility of the inspiration of the Scriptures by appealing to the oracle of Dodona, to the supernatural character of the Sibylline books, and to the universally accepted fact of *μανία*. Origen, who so frequently anticipates later criticism, was one of the earliest theologians who really attempted to construct a theory of inspiration. He said that the Scriptures contain the plenitude of the Holy Spirit, and that there was nothing in the law nor in the gospel which had not come down to us from the fulness of the Divine Majesty. Inspiration, he declared, preserved the writers from any faults of memory, and made it impossible to say that there was anything superfluous in Scripture. He got over difficulties either by allegorical interpretations, or by declaring that God, like a teacher, accommodates Himself to the degree of civilization in various ages. But the church of the early centuries was hindered from considering the doctrine of inspiration on all its sides by two influences. Throughout the early church the common opinion prevailed that the Scriptures were of great practical importance and promoted the edification of believers. But the church scarcely set itself seriously to ask how the Scriptures edified believers and in what their practical importance consisted; yet these questions bore upon a right understanding of their inspiration. It seems evident, however, that ever since the early conflicts with Gnosticism the church was tempted to look upon Scripture as primarily

a means of information, and not so much a means of grace. The Scriptures edified because they instructed, and were of importance because they gave information not otherwise attainable; and so inspiration, whatever else it was, came to be regarded as the means whereby that information was kept correct. It had been always held that the divine agent in inspiration was the Holy Spirit, but the precise function of the Spirit was not clearly defined. The early theologians, when discussing the inspiration of the apostles, forgot the writing in describing the writers, and enlarged on the powers communicated to them by the Spirit of God to guide the church, to work miracles, and to foretell the future. The promise of the Spirit, however, was not confined to the apostles; all believers were to share in it. Justin Martyr speaks of the miraculous powers of the apostles, and of the spiritual gifts of all Christians, as if the two were the same; and Tertullian, while he does draw a distinction between the inspiration of the apostles and that common to all believers, declares that the difference is one of degree, the inspiration of believers being only partial inspiration. Out of these conflicting tendencies there emerged in due time a double doctrine of inspiration. The Scriptures were inspired to teach infallible truth, and believers were inspired also with something of the same kind of inspiration to interpret this infallible truth. For though it was not distinctly stated, yet still there were intimations of what was to come. Whenever the Bible is looked on as altogether or even chiefly a means of knowledge, and not as a means of grace also, the intellectual aspect overcomes or drives into the background the conception of the Bible as a grace-giving power, and there is need of infallible interpretation as well as of infallible delivery of the propositions which convey the knowledge. In short, the doctrine was in such a state that at any moment it might crystallize into a theory that would practically deny to the ordinary believer the saving use of Scripture as a means of grace. The occasion was furnished by Montanism, which revived within the Christian church the old pagan idea of *μανία*, and applied it not to the original Scriptures but to the infallible interpretation of Scripture. The Montanist prophets claimed to be possessed of the Spirit as the Old Testament prophets had been, but this inspiration they used, not so much to give additional Scriptures, as to give authoritative exposition of the Scriptures already delivered to the church. Theologians rejected the Montanist *μανία*, denied that passivity and ecstasy were marks of inspiration, but none the less did the real essence of Montanist prophecy find its way into the church, for the result was a double doctrine of inspiration, --the inspiration of Scripture, which insured that the knowledge they communicated was correct, and the official inspiration of the church, which insured that the knowledge infallibly communicated was infallibly understood. This brings us to the scholastic period.

3. *The Schoolmen* accepted the doctrine of inspiration as it came to them from the fathers, and methodized it. They held that the Bible, which was the word of God and therefore inspired, was the source of doctrinal truth; and so this inspiration of the Bible came out in the fact that the doctrinal truths contained in it were infallibly true. The Schoolmen also recognized that a revelation which is primarily doctrinal, and that only, requires infallibility in interpretation as well as infallibility in delivery; and so the inspiration of the church was as important as the infallibility of Scripture. As time went on the infallible interpretations were collected, and side by side with an infallible Scripture was the infallible tradition or the official interpretation of Scripture. The logical Schoolmen, however, perceived, what was not so distinct to the fathers of the church, who were accustomed to think in pictures



rather than in propositions, that if the Bible was altogether a communication of doctrinal truth there was much in the Scriptures which had not at first sight that appearance. The long histories, the tables of genealogy, did not contain doctrinal statements, or give rules of holy living. Were these portions inspired? The question does not require to be raised if we believe that inspiration implies simply that God has fully committed His revelation to writing, and that revelation is above all things God entering into human life and history for the salvation of His people; for then the whole course of the history, with all the facts as well as the doctrines, contains the revelation. But if we take revelation to be only the delivery of doctrines, the question arises and disturbs our theory of inspiration. The fathers solved every difficulty here by appealing to allegorical interpretation, for allegory will turn the driest statistical details into a moral or doctrinal code; but the Schoolmen were too dryly logical to be quite content with this explanation. They accepted the allegorical senses of Scripture, but many of them held, like Thomas Aquinas (*Summa* ii. 2, qu. 1, art. 6; qu. 2, art. 2), that there were two kinds of inspiration in Scripture, the *direct*, which is to be found where doctrinal and moral truths are directly taught, and the *indirect*, which appears in historical passages, whence the doctrinal and moral can only be indirectly evolved by the use of allegorical interpretation. Many different opinions, however, were held about the details of the doctrine. Gregory the Great called the writers of Scripture the *calami* of the Holy Spirit, to denote how entirely the Bible was the work of God; while Agobard of Lyons asserted that the inspiration of Scripture did not exclude the presence of grammatical errors. Thomas Aquinas was content to say simply that God is the author of Scripture (*Summa* I, qu. 1, art. 10); but elsewhere he discusses at some length the psychological aspects of the inspiration of the prophets.

4. The Reformers placed the authority of Scripture above the decrees of popes and councils, above the opinions of the fathers, above the whole digest of official interpretations of Scripture which made tradition. They regarded Scripture as the judge in all controversies in matters of faith and doctrine, and as the source whence came every article of belief; but besides this they held that Scripture was a means of grace, a principle of salvation, a means of awakening the new life in the hearts of God's people. This was the real gist of the Reformation doctrine of Scripture; this was the main part in the contribution which the Reformers made to the doctrine of the word of God. The fathers had spoken of the practical importance of Scripture and its power for edification, but they had placed these qualities in a secondary position, and in the scholastic period Scripture came to be regarded as little more than a quarry for doctrines. The Reformers insisted that all doctrines must come from Scripture; they held that the Scripture was the book of the all-wise God, and was therefore the touchstone in matters of religious controversy, but they also held that above all the Scripture was the sword of the Spirit, and that its main use was to pierce the heart and conscience. According to the Reformers, the revelation of God was fully committed to writing in the Scriptures, and the inspiration of Scripture lay in this fact; but they held that the special nature of inspiration must be derived from the purpose of God in this matter. God fully committed His revelation to writing, they argued, not merely to impart new knowledge to men, but also and principally to awaken His people to a new life; and this purpose must appear in the statement of the doctrine of inspiration. Thus the Reformation doctrine of inspiration, while capable of statement in terms somewhat similar, was really different from the patristic and mediæval theories,

and it became more closely allied with the written Scriptures, and paid less attention to the writers. It taught that Scripture as a whole, and the parts of Scripture looked at as parts of the one whole, were designed to be a means of grace, to awaken a new life in God's people, through the work of the Spirit, and thus the doctrine of inspiration was at once brought into connexion with and yet clearly separated from the spiritual illumination shared by all believers. It is allied because both the inspiration of Scripture and the enlightening work of the Spirit in the hearts of believers are parts of the plan of God whereby by His means of grace through the work of the Spirit He gathers believers into His kingdom; it is quite distinct, for by it God wholly commits His revelation to writing, and so makes the Scripture able to appeal with the very power of God to the hearts and consciences of men. In this way the doctrine of inspiration was advanced a stage beyond what it had before reached, and indeed was raised to a higher platform. It was now seen that inspiration secured that the Scriptures should be instinct with God's power for salvation, as well as full of the knowledge which God has pleased to communicate to man. And thus in the hands of Luther, Calvin, and Zwingli the doctrine of inspiration had for its correlative the doctrine of the *Testimonium Spiritus Sancti*; the two doctrines supported and explained each other. The second raised the first out of the region of mechanical dictation, the first prevented the second degenerating into a mystical enthusiasm. The Reformers were content to leave the doctrine of inspiration without much further definition, but they took the full advantage of the spiritual form of the doctrine to use great freedom with the letter of Scripture. Their successors acted otherwise.

5. The *Protestant Scholastic* for the most part treated the Reformers' doctrine of inspiration very much in the same way as the Schoolmen had treated the doctrine of the fathers. They did not deny the spiritual side of the doctrine; they maintained that Scripture was a means of grace, a power of God to salvation; but they did not bring this side forward much in their discussions about inspiration. They dwelt on the fact that inspiration secured accuracy, rather than on the fact that it brought with it spiritual power. They asked, When Scripture is the word of the all-wise God, what does this imply? And the answers were various. Gerhard held that it implied that the writers were the "pens," the "hands," the "amanuenses" of the Holy Ghost. We may with propriety, he says, call the prophets and the apostles "amanuenses Dei, Christi, manus et Spiritus sive tabelliones sive notarios." Calovius and Quenstedt say the same. Quenstedt holds that everything in Scripture comes from the infallible divine assistance and direction, from a special suggestion and dictation of the Holy Spirit; and he says that because Scripture is inspired it is of infallible truth and free from every error; canonical Scripture contains no lie, no falsehood, not the very slightest error either in fact or in word; whatever things it relates, all and every one of them, are of the very highest truth, whether they be ethical or historical, chronological, topographical, or verbal; there is no ignorance, no want of knowledge, no forgetfulness, no lapse of memory in Scripture. The framers of the *Formula Consensus Helvetica* went further, and declared that the Old Testament was "tum quoad consonantiam, tum quoad vocalia, sive puncta ipsa, sive punctorum saltem potestatem, et tum quoad res, tum quoad verba θεόπνευστος." On the other hand, Cappellus, led by his investigations into the antiquity of the Hebrew points, maintained that the inspiration of Scripture did not necessarily demand perfect accuracy in details; and he declared that such accuracy not only did not exist in such editions as we have now, but never did exist for manuscripts

show discrepancies which cannot be explained on the theory of wilful or involuntary mistakes of copyists.

The Socinians and certain Arminians, such as Episcopius, who started with the idea that the Bible is simply a communication of knowledge, and so revived the mediæval idea, also resuscitated the scholastic doctrine of partial inspiration. They did not admit the allegorical method of interpretation, and were therefore compelled to reject the "indirect inspiration" of Thomas Aquinas; but they held that inspiration was only required to communicate knowledge which the writer could not otherwise obtain, and they usually asserted that only the doctrinal parts of the Bible were inspired while the historical were not. Calixtus in the Lutheran Church held a somewhat similar opinion.

6. In more recent times the doctrine of inspiration has assumed various forms, many of which have but slight connexion with either the Reformation or the mediæval theories. All admit that the inspiration of Scripture implies that the revelation of God has been committed to writing. Those who hold naturalistic views of revelation reduce inspiration to a peculiar aptitude for and sympathy with religious and moral truth. Others, although believing in the supernatural character of revelation, hold that there is no warrant to suppose anything specially supernatural about the committal of the revelation to writing, and believe that God left His revelation to be recorded in the natural course of providence by men who had perhaps a larger share than their fellows of the spiritual enlightenment common to all believers. Others again have revived the old Thomist doctrine that parts of the Bible are inspired and that parts are not. To meet such theories, orthodox theologians have invented the terms plenary inspiration and verbal inspiration, but the phrases are neither very exact nor very enlightening. Meanwhile it is interesting to observe that a number of modern theologians, among whom may be named the late Adolphe Monod of Paris, have sought to revive the old simple Reformation form of the doctrine divested of its 17th century subtleties.

See Sonntag, *Doctrina Inspirationis ejusque ratio*, &c., Heidelberg, 1810; Hagenbach, *History of Doctrines*; Baur, *Vorlesungen über die Christliche Dogmengeschichte*; Schaff, *History of the Creeds of Christendom*; Bannerman, *Inspiration*; Gaussens, *Théopneustie*; Lee, *The Inspiration of the Holy Bible*, &c. (T. M. L.)

INSTERBURG (16,303), the chief town of a circle in government district of Gumbinnen, East Prussia, is situated at the point where the Angerap and Inster join to form the Pregel, about 55 miles east of Königsberg. It is the seat of an appeal and other courts, and of a reformatory for the district, and has a chamber of commerce, a hospital, a gymnasium, a real-school of the first class, and several other schools. Insterburg is an active manufacturing town, and, besides flax-spinning and iron-founding, carries on the manufacture of machinery, shoes, cement, leather, and furs, along with a considerable trade in cereals, vegetables, flax, linseed, and wood. Close to the town is a large stud-farm, and about 2 miles off is the old castle of Gorgenburg. Including the garrison, the population in 1875 was 16,303.

Insterburg was founded in the 14th century as a castle and commandery of the knights of the Teutonic order. The commandery was removed in 1525, but the village which had sprung up round the castle received town privileges in 1583 from the margrave of Brandenburg. During the next century it made rapid advances in prosperity, owing to the settlement in it of several Scotch trading families. In 1679 it was besieged by the Swedes, in 1690 it suffered severely from a fire, and in 1710-11 from a pestilence.

INSTINCT is a term which does not admit of rigid definition, because, as ordinarily used, the meaning of the term is not rigidly fixed. But for the purposes of scientific exposition from a biological point of view the nearest approach we can make to such a definition is perhaps the following:—Instinct is a generic term comprising all those faculties of mind which lead to the conscious performance of actions

that are adaptive in character, but pursued without necessary knowledge of the relation between the means employed and the ends attained. We must, however, remember that instinctive actions are very commonly tempered with what Pierre Huber calls "a little dose of judgment or reason." But although reason may thus in varying degrees be blended with instinct, the distinction between the two is sufficiently precise; for reason, in whatever degree present, only acts upon a definite and often laboriously acquired knowledge of the relation between means and ends. Moreover, adjustive actions due to instinct are similarly performed by all individuals of a species under the stimulus supplied by the same appropriate circumstances, whereas adjustive actions due to reason are variously performed by different individuals. Lastly, instinctive actions are only performed under particular circumstances which have been frequently experienced during the life history of the species, whereas rational actions are performed under varied circumstances, and serve to meet novel exigencies which may never before have occurred even in the life history of the individual.

All instincts probably arose in one or other of two ways. Origin of (1) By the effects of habit in successive generations, <sup>instincts</sup> mental activities which were originally intelligent become, as it were, stereotyped into permanent instincts. Just as in the life-time of the individual adaptive actions which were originally intelligent may by frequent repetition become automatic, so in the life-time of the species actions originally intelligent may, by frequent repetition and heredity, so write their effects on the nervous system that the latter is prepared, even before individual experience, to perform adaptive actions mechanically which in previous generations were performed intelligently. This mode of origin of instincts has been appropriately called the "lapsing of intelligence." (2) The other mode of origin consists in natural selection, or survival of the fittest, continuously preserving actions which, although never intelligent, yet happen to have been of benefit to the animals which first chanced to perform them. Thus, for instance, take the instinct of incubation. It is quite impossible that any animal can ever have kept its eggs warm with the intelligent purpose of hatching out their contents, so we can only suppose that the incubating instinct began by warm-blooded animals showing that kind of attention to their eggs which we find to be frequently shown by cold-blooded animals. Thus crabs and spiders carry about their eggs for the purpose of protecting them; and if, as animals gradually became warm-blooded, some species for this or for any other purpose adopted a similar habit, the imparting of heat would have become incidental to the carrying about of the eggs. Consequently, as the imparting of heat promoted the process of hatching, those individuals which most constantly cuddled or brooded over their eggs would, other things equal, have been most successful in rearing progeny; and so the incubating instinct would be developed without there having been any intelligence in the matter.

That many instincts must have been developed in this way is rendered evident by the following considerations. (1) Many instinctive actions are performed by animals too low in the scale to admit of our supposing that the adjustments which are now instinctive can ever have been intelligent. (2) Among the higher animals instinctive actions are performed at an age before intelligence, or power of learning by individual experience, has begun to assert itself. (3) Considering the great importance of instincts to species, we are prepared to expect that they must be in large part subject to the influence of natural selection. As Mr Darwin observes, "it will be universally admitted that instincts are as important as corporeal structures for the welfare of each species under its present



conditions of life. Under changed conditions of life it is at least possible that slight modifications of instinct might be profitable to a species; and if it can be shown that instincts do vary ever so little, then I can see no difficulty in natural selection preserving and continually accumulating variations of instinct to any extent that was profitable. It is thus, I believe, that all the most complex and wonderful instincts have originated."

But here it is of importance to note that there is no reason why instincts should be restricted to one or other of these two modes of origin. On the contrary, there seems to be every reason to suppose that many instincts may have had, as it were, a double root—intelligent adjustment and natural selection blending their influences to a joint production. For example, the grouse of North America display the curious instinct of burrowing a tunnel just below the surface of the snow. In the end of this tunnel they sleep securely; for, when any four-footed enemy approaches the mouth of the tunnel, the bird, in order to escape, has only to fly up through the thin covering of snow. Now in this case the grouse probably began to burrow for the sake of protection, or concealment, or both, and if so, thus far the burrowing was probably an act of intelligence. But the longer the tunnel the better would it have served the purposes of escape, and therefore natural selection would almost certainly have tended to preserve the birds which made the longest tunnels, until the utmost benefit that length of tunnel could give had been attained. And similarly the origin of many other instincts may be satisfactorily explained by thus supposing the combined operation of two causes—intelligent adjustment and natural selection—where there is a difficulty in explaining their origin as due to either cause alone. And if even in fully formed instincts we often find "a little dose of judgment or reason," we can have no cause to doubt that in the formation of instincts by natural selection such small admixtures of judgment or reason may often greatly assist the process, while, conversely, it is even more evident that an instinct which is developing from the habitual performance of an intelligent action might be greatly assisted by natural selection favouring the individuals which most frequently or most promptly performed that action.

Varia-  
bility.

It is necessary to the above interpretation of the origin of instincts that the latter should not be immutably fixed. A few words may therefore be added to show that the view commonly entertained as to the unalterable character of instincts is erroneous. As a matter of fact, instincts are eminently variable, and therefore admit of being modified as modifying circumstances may require; their variability gives them plasticity whereby they may be moulded always to fit an environment, however continuously the latter may be subject to gradual change.

For the sake of brevity we may confine our attention to a single instinct, and for the sake of procuring a good test we may again take as our example the instinct of incubation. This affords a good test because it must be regarded, not merely as one of the most important, but also as one of the oldest of instincts, and therefore one which for both these reasons we should deem least likely to exhibit variability. Yet we find it to exhibit variability in every imaginable direction. Thus the complicated effects of domestication and artificial selection on some of our breeds of poultry appear to have almost completely destroyed this instinct, while in other breeds it remains intact, if indeed it has not even been intensified. Among the latter breeds experiment shows that the natural period of incubation may be indefinitely prolonged by substituting "dummies" for eggs, while the following experiment, which we owe to Mr Spalding, shows "how far the time of sitting may be interfered with in the opposite direction. Two hens," he

says, "became broody on the same day, and I set them on dummies. On the third day, I put two chicks a day old to one of these two hens; she pecked at them once or twice, seemed rather fidgety, then took to them, called them to her, and entered on all the cares of a mother. The other hen was similarly tried, but with a very different result; she pecked at the chickens viciously, and both that day and the next stubbornly refused to have anything to do with them." Similarly the period of maternal supervision after the chickens have been hatched admits of being greatly modified, as is proved by some experiments made and published several years ago by the present writer. In one of these experiments there was given to a Brahma hen a pea-fowl's egg to hatch; the hen was an old one, and had previously reared several broods of ordinary chickens. A pea-chicken requires a much longer period of maternal care than does an ordinary chicken, and for the wonderfully long period of eighteen months the old Brahma hen continued to pay unremitting attention to her supposed offspring. Through all this time she never laid any eggs, and eventually the separation seemed to take place from the side of the peacock. In other cases, however, where the conditions of the experiment were exactly parallel, the pea-chickens were abandoned by their Brahma mothers at the time when the latter ordinarily abandon their chickens. But not only will a hen thus take to a brood of birds so unlike her natural chickens as are pea-fowl, and adapt her instincts to their peculiar needs; she may even take to young animals belonging to a different class, and adapt her instincts to their still more peculiar needs. Thus the writer gave to a hen, which for several weeks had been sitting on dummies, three newly-born ferrets; she took to them almost immediately, and remained with them for more than a fortnight, when they were taken away from her. During the whole of this time she had to sit upon the nest, for of course the young ferrets were not able to follow her about as young chickens would have done. Two or three times a day she would fly off her nest, calling upon her brood to follow; but, on hearing their cries of distress from cold, she always returned immediately, and sat with patience for six or seven hours more. She only took one day to learn the meaning of these cries, and after that she would always run in an agitated manner to any place where the crying ferrets were concealed. Yet it would not be possible to conceive a greater contrast than that between the shrill piping note of a young chicken and the hoarse growling noise of a young ferret. It is of importance to add that the hen very soon learnt to accommodate herself to the entirely novel mode of feeding that her young ones required; for, although at first she showed much uneasiness when the ferrets were taken from her to be fed, before long she used to cluck when she saw the milk brought, and surveyed the feeding with satisfaction. But she never became accustomed to the attempt of the ferrets at sucking, and to the last used now and then to fly off the nest with a cackle when nipped by the young mammals in their search for the teats.

Enough then has been said on the variability of instinct to show that there is supplied to natural selection abundant opportunity for the development of new and more highly wrought instincts from previously formed and less elaborated instincts. But in order to show that this opportunity has been utilized it is not enough to show that hereditary instinct may be modified by individual experience; it must also be shown that such a modification when successively repeated through a number of generations itself becomes inherited. Now, although the evidence on this point is necessarily scanty, it is sufficient for the purpose here required. The evidence is scanty because there are only a very few cases in which human observation has, as it were, the opportunity of watching the continuance of effects of

Heredi-  
tary  
trans-  
mission

recently acquired or altered experiences over a number of generations; but in the few cases in which we have this opportunity we find good evidence that new or changed experience, when continued over a number of generations, is bequeathed to future generations as a legacy of intuitive knowledge, and that any newly acquired adjustive actions may in time be similarly transmitted as instinctive actions which no longer require to be separately learnt by each individual. Perhaps the best instance that can be quoted is that of the many species of birds, and some mammals, which when first found by man on oceanic islands were perfectly tame, but whose descendants now show a dread of man which is, in the most rigorous sense of the word, instinctive.

The only other instances in which we have an opportunity of actually observing the transmission of newly acquired mental habits are those in which such habits have been artificially taught to domesticated animals. It so happens that these instances are very few in number, but it is not too much to say that, in all the cases where such habits have been taught for a long series of generations, some tokens of their hereditary transmission may now be observed. Thus, to quote Mr Darwin, whose accuracy on such a subject is not likely to be disputed by any one, "it cannot be doubted that young pointers—I have myself seen a striking instance—will sometimes point and even back other dogs the very first time they are taken out; retrieving is certainly in some degree inherited by retrievers; and a tendency to run round instead of at a flock of sheep by shepherd dogs. If we were to behold one kind of wolf when young and without any training, as soon as it scented its prey, stand motionless like a statue, and then slowly crawl forward with a peculiar gait, and another kind of wolf rushing round instead of at a herd of deer, and driving them to a distant point, we should assuredly call these actions instinctive. Domestic instincts, as they may be called, are certainly much less fixed than natural instincts, but they have been acted on by far less rigorous selection, and have been transmitted for an incomparably shorter period, under less fixed conditions."

Now these three habits, or mental attainments, are the only ones that have been systematically taught to any animals for a number of generations, and the fact that they all show a marked tendency to become intuitive may be taken as lending a greater amount of confirmation to the present theory of the origin of instincts than we might on *a priori* grounds be led to expect. The only other facts bearing upon this point are those which are thus tersely rendered by Mr Darwin. "How strongly these domestic instincts, habits, and dispositions are inherited, and how curiously they become mingled, is well shown when different breeds of dogs are crossed. Thus it is well known that a cross with a bull-dog has affected for many generations the courage and obstinacy of greyhounds, and a cross with a greyhound has given to a whole family of shepherd dogs a tendency to hunt hares. These domestic instincts resemble natural instincts, which in like manner become curiously blended together, and for a long time exhibit traces of the instincts of either parent."

The above doctrine as to the nature, origin, and development of instincts serves very satisfactorily to explain nearly all the enormous number of instincts with which we are acquainted. There are, however, several special cases where there is still some difficulty in applying the above doctrine as a full and satisfactory explanation of the observed facts. This article may therefore fitly conclude with a brief enumeration of these cases.

1. The so-called "migratory instinct" is one that is still shrouded in much obscurity. The main difficulty with regard to it is to account for the "sense of direction," whereby the animals are guided to their destinations. Thus, for instance, many migratory birds fly at night, when it would seem impossible that they can be guided on their way by the sight and memory of landmarks. Moreover, it is asserted on good authority that among some species it is the habit for the young brood to fly separately by themselves, or

apart from the older birds, and therefore to travel over enormous tracts of land and sea without either guidance or previous experience of the way; such is unquestionably the case with the young of the cuckoo. Lastly, it is certain that several species fly across immense tracts of ocean, where it is impossible that they can be guided on their way by landmarks. Several theories have been propounded to account for these facts; but, as none of them are satisfactory, we need not here occupy space with their enumeration.

2. Closely allied to, if not identical with, this so-called "sense of direction" as manifested in migration, is the faculty whereby various species of animals which may not be migratory in their habits are enabled to find their way over greater or less distances. This has been called the "homing" faculty, and is chiefly manifested by various species of domesticated mammals. It is very generally believed that it is also manifested by carrier-pigeons; as a matter of fact, however, there is no trustworthy instance on record of one of these birds having found its way back over a tract of country with which it was previously unacquainted. In order that a carrier-pigeon should find its way home, it is necessary first to teach the animal, by flying it at a series of points along the route, the landmarks of the country which it is afterwards to traverse. But, although the "sense of direction" may be a figment as regards the carrier-pigeon, there can be no doubt that it is a fact as regards many species of our domesticated mammals. Thus the evidence is unequivocal with regard at least to dogs, cats, horses, sheep, pigs, and cattle. Judging from hitherto unpublished correspondence received from Australia and South America, there seems to be practically no limit to the distance over which these animals may be able to return; and, what is of more importance, there can be no doubt that these animals, when finding their way home, do not require to traverse the exact routes by which they came; on the contrary, they generally seem to select the shortest or the straightest course, however circuitous the way may have been by which they were taken; or, if their outward journey is over two sides of a triangle, their homeward journey will probably be taken over the third side. The sense by which they are guided therefore cannot be, as has been suggested by more than one eminent naturalist, the sense of smell; and for the same reasons it cannot be either the sense of sight or that of hearing. More plausible is the hypothesis that the faculty consists in an automatic process of "brain registration," every change of direction in the outgoing journey leaving behind it a record in the cerebral nervous system, and therefore in the mind of the animal, so that as a total result the general direction of the starting place is retained in the memory,—just as we are ourselves able in a smaller degree to preserve our general sense of direction when winding through the streets of a town. One great difficulty attaching to this view appears to be that the animals in question are able to find their way home over land even when they have made their outward journey by sea, for it is evident that the difficulties of "brain registration" must in such cases be indefinitely increased, not only by the many meaningless movements of a vessel at sea, but still more by the fact that the changes of direction made by the vessel, being made in long and easy curves, and without muscular effort on the part of the animals, are movements which we can scarcely suppose to be appreciated by the cerebral organization of the animals. On the whole, therefore, with regard to the faculty of "homing," as with regard to the analogous if not identical faculty exhibited in migration, it can only be said that further investigation is required in order to explain that which, in the present state of our knowledge, must properly be regarded as inexplicable.

3. Mr Darwin has pointed out a serious difficulty lying against his theory of the origin of instincts by natural selection, and one which, as he justly remarks, it is surprising that no one should have hitherto advanced against the well-known doctrine of inherited habit, as taught by Lamarck. The difficulty is that among various species of social insects, such as bees and ants, there occur "neuter" or asexual individuals, which manifest entirely different instincts from the other or sexual individuals, and as the neuters cannot breed it is difficult to understand how their peculiar and distinctive instincts can be formed by natural selection, which, as we have seen, requires for its operation the transmission of mental faculties by heredity. The only possible way in which this difficulty can be met is the way in which it has been met by Mr Darwin, viz., by supposing "that selection may be applied to the family as to the individual." "Such faith may be placed in the power of selection that a breed of cattle always yielding oxen with extraordinarily long horns could, it is probable, be formed by carefully watching which individual bulls and cows, when matched, produced oxen with the longest horns; and yet no one ox would ever have propagated its kind"; and similarly, of course, with regard to the instincts of neuters. As Mr Darwin has argued on this difficulty at length, it seems unnecessary to say more with regard to it than that he has shown it to be not so formidable as to exclude his doctrine as fully explanatory of such cases, when we have already accepted his doctrine as explanatory of other cases.

4. There are two or three other special instincts of minor import-



ance the explanation of which is not as yet completely clear. Thus it is not yet ascertained what hereditary influence it is that leads the Norwegian lemming periodically to migrate westwards, with the result that enormous numbers of the species are destroyed by drowning. But there can be little doubt that this influence, whatever it was, was originally of benefit to the species, for it would be a case standing out of all analogy if this instinct should from its first origin have been, as it now appears to be, detrimental. The only other instance that could be pointed to as wearing any such appearance is that which has been alleged, but on very doubtful evidence, with regard to the scorpion committing suicide by stinging itself to death when surrounded by a ring of fire. It may be here incidentally observed that the fact of all the innumerable multitude of animal instincts, with the exception of the two dubious cases just mentioned, being of obvious use to the species which manifest them, may properly be taken as the strongest possible evidence of the theory that ascribes all instincts to the operation of natural selection.

5. Lastly, we have an instinct which is pointed to by Mr Mivart as one that cannot be explained by the influence of natural selection, or, as he would appear to suggest, by the operation of any other natural cause. This instinct is manifested by a certain wasp-like animal, and consists in this animal stinging spiders in the particular part of the cephalo-thorax which contains the principal nervous centre. The effect of stinging this nervous centre is that of paralyzing the spider without killing it, and the spider in this maimed condition is then stored up with the larvae of the fly, to serve as their food when they quit the egg. It will be observed that there is here no question as to the utility of the instinct to the species which manifests it, and the difficulty to which Mr Mivart points consists merely in understanding how the insect was in the first instance led to sting the spiders in precisely the right spot to produce the particular results required. The answer to this single remaining difficulty is that as yet the case has not been sufficiently observed with a view to a possible solution of the difficulty. I seem, for instance, not at all improbable that the striking of the spider's ganglion by the sting of the wasp is, as it were, wholly accidental, being determined only by the circumstance that both the ganglion and the sting are organs which occur in the median line of their respective possessors. Whether or not this is the explanation of the supposed difficulty, it at least seems clear that the latter is not one of any considerable magnitude. (G. J. R.)

INSTITUTE OF FRANCE, an association constituted under the name of the *Institut National* by the French Republican Convention, in October 1795, to occupy a similar position to that of the old academies suppressed by an Act of the Convention, 8th April 1793 (see ACADEMY). The affix to the word "Institut" has undergone a variety of changes corresponding to changes in the form of the government of France. The Institute owed its existence chiefly to the efforts of three persons, Lakanal, Daunou, and Carnot, and, according to the terms of the law by which it was founded, its purpose was to "advance the sciences and arts of research by the publication of discoveries and by correspondence with other learned societies, and to prosecute those scientific and literary labours which shall have for their end general utility and the glory of the republic." It was composed of three classes—the first for sciences physiques et mathématiques, the second for sciences morales et politiques, and the third for littérature et beaux-arts. Originally it consisted of 144 members (the 48 nominated by the Convention electing 96 others), an equal number of associates in the provinces, and 24 foreigners of distinction who held the position of correspondents. Each class was divided into several sections, 6 members and 6 associates being assigned to each section. The first class was composed of ten sections, viz., (1) mathématiques, (2) arts mécaniques, (3) astronomie, (4) physique expérimentale, (5) chimie, (6) histoire naturelle et minéralogie, (7) botanique et physique générale, (8) anatomie et zoologie, (9) médecine et chirurgie, (10) économie rurale et art vétérinaire. The second class was composed of six sections, namely, (1) analyse des sensations et des idées, (2) morale, (3) science sociale et législation, (4) économie politique, (5) histoire, (6) géographie. The third class consisted of eight sections, viz., (1) grammaire, (2) langues anciennes, (3) poésie, (4) antiquités et monuments, (5) peinture, (6) sculpture, (7) architecture, (8)

musique et déclamation. To the first class were thus assigned 60 members and as many associates, to the second 36, and to the third 48, the foreign correspondents being divided equally among the classes. No member was permitted to belong to more than one class; but any one might be present at the meetings and assist in the labours of the other classes. The Institute was installed at the Louvre in the building formerly occupied by the Académie Française, but in 1806 its locality was changed to the Collège des Quatre-Nations. The First Consul on the 23d January 1803 decreed for it a new constitution, the leading features of which were—that the approval of the head of the Government was essential in the election of members; the suppression of the second class; and a redivision into the four classes of (1) sciences physiques et mathématiques, (2) la langue et la littérature Françaises, and (3) histoire et littérature anciennes, (4) beaux-arts. The first class was composed of the ten sections of the old first class, and an additional section of geography and navigation with 3 members, with power to nominate 100 correspondents. The second class was composed of 40 members not separated into sections. The third class was composed of 40 members and of 8 foreign associates, and had the power to nominate 60 correspondents. The fourth class, which was composed of 28 members and of 8 foreign associates, was divided into five sections:—peinture with 10 members, sculpture with 6, architecture with 6, gravure with 3, and musique (composition) with 3 members. It had the power to nominate 36 correspondents. All classes had power to elect a stipulated number of members from the other classes. After the Restoration Louis XVIII. on the 21st March 1816 decreed the revival of the names of the old academies to the four classes of the Institute:—(1) L'Académie Française, corresponding to the old second class; (2) L'Académie royale des inscriptions et belles lettres, corresponding to the third class; (3) L'Académie royale des sciences, corresponding to the first class; and (4) L'Académie royale des beaux-arts, corresponding to the fourth class. On the 5th March 1833 a fifth academy was added to the Institute,—L'Académie des sciences morales et politiques, corresponding to the second class suppressed by Napoleon. As restored, it was composed of 30 members, with a minimum of 30 and a maximum of 40 correspondents. It was divided into five sections, viz., (1) philosophie, (2) morale, (3) législation, droit public, et jurisprudence, (4) économie politique et statistique, (5) histoire générale et philosophique.

Each academy has its own special jurisdiction and work, with special funds and one or more perpetual secretaries, in addition to which there is a general fund and common library, which, as well as other matters connected with the Institute as a whole, are managed by a committee chosen in equal numbers from each of the academies. Matters of common interest to all the academies are discussed at a general meeting of the institute, and a *séance publique annuelle* takes place on the 25th October, the anniversary of the organization of the Institute. All the expenses of the Institute and the academies are defrayed by an annual sum voted by Government. Each member of the Institute receives an annual allowance of 1200 francs, and each secretary of an academy a salary of 6000 francs. A notice of the several academies is given in the article ACADEMY. See also FRANCE, vol. ix. p. 514.

See *Annuaire de l'Institut; Mémoires de l'Institut; J. P. A. Lucas, Qu'est-ce que l'Institut*, Paris, 1845; Rogé de Belloguet, *Pétition adressée à l'opinion publique pour la réforme des élections de l'Institut*, Paris, 1862; *L'Empereur à l'Institut*, Paris, 1865; Alfred Franklin, *Les Origines du palais de l'Institut*, Paris, 1862; Alfred Potiquet, *L'Institut national de France*, 1871; Renan, "L'Institut," in *Questions Contemporaines*, Paris, 1865; Francisque Bouillier, *L'Institut et les Académies de province*, Paris, 1879.

## INSURANCE

**I**NSURANCE is the system or machinery by which it is sought to guard against the pecuniary consequences of certain accidents to which men are liable, such as the loss of property by fire or shipwreck, or the loss of future earnings through disablement or premature death. Insurance does not attempt to prevent these accidents, nor even to protect men against all the consequences of them. It deals only with the main pecuniary loss which such accidents are fitted to occasion, provides for it beforehand, practically distributes it among the persons who are more or less exposed to the same risk; and so, when the accident does light on any one of them, its pecuniary effects are neutralized or greatly mitigated.

The three chief developments of this system—Fire, Life, and Marine Insurance—are separately treated in the following articles. A very important application of the principle has been treated under the heading FRIENDLY SOCIETIES.

Besides the above branches of insurance, which have attained immense proportions in almost all civilized countries, there are many other applications of the principle which have been tried with greater or less success. The conditions which seem necessary to success (in addition to good administration) are chiefly these:—there must be a risk of real loss which it ought to be beyond the power of either the insurer or the insured to avert or to hasten; a large number of persons must be liable to the like risk; the accident contemplated must be likely to fall on a comparatively small number of the persons exposed to the risk of it; the probabilities of its occurrence must be capable of being estimated beforehand with some approximation to certainty; the loss apprehended must be so considerable when it does occur as to be worth providing against; and the cost of that provision must be comparatively so small as not to be prohibitive.

*Accident Insurance.*—Ordinary life assurance protects against the pecuniary loss arising to a man's family or creditors or others by his death, whether that arise from accident or disease; but it has been found that a separate insurance against the consequences of accident meets the requirements of a large class of persons. A company was established in London in 1849 for insuring against the consequences of railway accidents,—the Railway Passengers Assurance Company. In return for a payment of 3d., 2d., or 1d. made by first, second, or third class passengers respectively, for insurance during a single journey, it undertook to pay £1000, £500, or £200 in case of death by such an accident, or a certain weekly allowance in respect of personal injury not resulting in death. In 1856 the business was extended to embrace accidents of all kinds, and there came into use a system of yearly payments proportioned to the degree of risk supposed to attach to various occupations or other conditions of life. Many other similar companies have since been established, and at the present time (1881) there appear to be about eleven such offices in the United Kingdom. The amount insured by them is estimated at nearly £100,000,000 sterling, and their yearly income is between £400,000 and £500,000. The claims absorb about 50 per cent. of the premiums, the remainder, after paying expenses necessarily large, being the profit. Various schemes are at present being organized, in consequence of recent legislation, to enable employers to insure against risk from injuries suffered by their work-people.

The business of insuring against accidents has been developed in Canada, Victoria, and New South Wales, as well as in France, Germany, Switzerland, and the United States. In the country last mentioned the premium in-

come of the principal office engaged in this business was in 1879 close on a million of dollars.

*Fidelity Guarantee.*—The guarantee of employers against the fraud or insolvency of their servants has of late years become a considerable and useful department of insurance business. Private suretyship is attended by many evils, and a bond of indemnity by a joint-stock company, although it has to be purchased by a yearly payment, is now generally preferred. Such a bond is not granted without previous inquiry as to the character of the applicant and the checks which the employer is to use. Seven institutions in the United Kingdom undertake this description of business; some of them insure only against loss arising from embezzlement, while others protect the employer against any failure to make good the sums entrusted to an employé. The yearly premiums required range from 10s. to 60s. per cent. of the sum guaranteed.

*Various Minor Forms of Insurance.*—In those parts of the British Isles which are exposed to violent hail-storms offices have been established successfully for insurance against the loss which these often occasion. Efforts have been made also, not always with equal success, to protect farmers and other owners of horses and cattle against the loss arising from accident or disease among these animals. It has been attempted also to insure traders against loss from bad debts, and house-owners against loss of rent and against defective titles. No fewer than thirteen offices, mostly local in their operation, insure against loss from the breakage of plate glass, and three against the loss from explosion of boilers. In former times, when men were liable to be drawn to serve in the militia but might purchase a substitute, a system of insurance was established to provide them with the necessary funds. These developments of insurance, however, are of an importance quite insignificant compared with the three great departments now to be dealt with.

## I. FIRE INSURANCE.

Fire insurance is a matter of practical interest to a far larger number of persons than either of the other two great departments of insurance—life or marine. There are few persons to whom, in the absence of insurance, the destruction of their dwellings or of their household goods would not be a serious calamity, while to the merchant or manufacturer the burning of his premises or stock or machinery might be ruinous. No age or country has been exempt from such fatalities, and no watchfulness has been able to prevent them. Some protection against the pecuniary consequences seems an essential condition of any extended system of manufactures or commerce.

Fire insurance, however, as an organized system, has had an origin comparatively recent. There are traces, indeed, in earlier times of enforced or voluntary contributions towards the relief of sufferers by fire, but it is only about the beginning of the 17th century that we hear of proposals being made for a more systematic provision, and it was not till after the great fire of London in 1666 that these proposals took practical shape. This seems at first to have been in the form of underwriting by individuals or by clubs, and some attempts were made to engage the corporation of London in a scheme of fire insurance; but in 1681 the first regular office for insuring against loss by fire was opened by a combination of persons "at the back-side of the Royal Exchange," and it was followed shortly afterwards by another. Of the insurance offices that still survive, only one, the Hand-in-Hand, dates from the 17th



century (1696); five date from the first half of the 18th century, the Sun (1710), Union (1714), Westminster (1717), London (1720), and Royal Exchange (1720); while only three date from the second half of that century, the Salop (1780), Phoenix (1782), and Norwich Union (1797). The first fire office in Scotland was established in 1720, the first in Germany in 1750, and the first proprietary company in that country in 1779; the first office in the United States was established at Philadelphia in 1752, one of its early directors having been Benjamin Franklin; the first in France dates from 1816, and the first in Russia from 1827.

The growth of fire insurance business in Britain did not receive much assistance from Government. At a very early period, in 1694 under William & Mary, a stamp duty was imposed on fire policies (now reduced to the nominal rate of one penny), and in 1782, during the administration of Lord North, fire insurances were made liable to an annual duty at the rate of 1s. 6d. for each £100 insured. This tax, which was collected by the offices along with their premiums and accounted for by them to the exchequer, was increased in 1797 to 2s. per cent., in 1805 to 2s. 6d., and in 1816 to 3s., at which rate it continued for about fifty years. It was strongly objected to as a discouragement to prudence, and as disproportionate in rate to the cost of insurance which it was tacked to; but as it was easily collected, and yielded nearly two millions a year (£1,714,622 in 1863), it naturally died hard. In 1864 it was partially remitted, and it expired finally in 1869. The returns of the duty enable us to measure in some degree the progress of fire insurance in the United Kingdom during the eighty-five years of its incidence. Some descriptions of property, such as agricultural produce, were exempt from duty and do not appear in the returns, nor do the sums insured on property situated out of the United Kingdom; but the amount insured by British offices on which duty was paid was

In 1783 about	£135,000,000	In 1840 about	£645,000,000
" 1800 "	200,000,000	" 1860 "	1,000,000,000
" 1820 "	427,000,000	" 1868 "	1,430,000,000

At the present time (1881) there appear to be about sixty offices established in the United Kingdom for insuring against loss by fire either alone or in conjunction with life or marine insurance. A few of these are of very recent origin. The number does not include several foreign companies doing business in Great Britain.

Excepting by the imposition of the duty now repealed, the British legislature has not interfered with the business of fire insurance. Any number of persons may at the present time engage in this business with or without capital, nor is there a necessity even for the publication of their accounts. By the Life Assurance Companies Act of 1870, a deposit of £20,000 is required on the establishment of a life office; certain returns also must be made to the Board of Trade for presentation to parliament, and these regulations apply to offices which conduct fire in conjunction with life insurance, as well as to purely life offices. One consequence is that, while the results of the fire insurance business of these compound offices are published regularly, those of purely fire offices need not be published, and several of the oldest and most important fire companies do in fact keep their accounts strictly private. There is no reason to suppose, however, that their experience differs materially from that of the compound offices whose figures are open to us. From the returns of thirty of these it appears that their aggregate income from fire premiums in the seven years 1870-76 was as follows:—

1870	.....	£3,765,000	1874	.....	£5,824,000
1871	.....	4,733,000	1875	.....	6,072,000
1872	.....	5,306,000	1876	.....	6,162,000
1873	.....	5,600,000			

The increase in six years was therefore nearly two millions and a half of yearly income, the premiums in 1876 being about 63 per cent. more than in 1870. There are no means of ascertaining how far this increase arises from the insurance of property abroad, which is no doubt a considerable item, or from an increase in the quantity of insurable property within the United Kingdom, or in the proportion of it which is insured, or in the average rates charged for insurance, but no doubt all of these causes were at work. It may be mentioned here that the thirty offices to which the above returns relate have a subscribed capital of about 40 millions, and cash assets available for fire losses, not including their life assurance funds, amounting to 20 millions. They have therefore funds in hand equal to more than three years' income from premiums. Another return gives the premium income of forty-five British offices in the year 1879 as £8,271,000, their losses as £4,349,000, their expenses as £2,426,000, and their net profits irrespective of interest as about £1,500,000, or 18 per cent. of the premiums. The whole premium income of British fire offices is probably nearly 10 millions sterling, and the amount insured may be taken at from four to five thousand millions.

The returns of the London Fire Brigade enable us to approximate to the amount of insurances effected on property within the metropolitan area. In 1866 the sum insured was about 316 millions; in 1871, 440 millions; in 1878, 605 millions; and in 1879, 624 millions.

The essential principle of fire insurance is the distribution of loss. It does not aim, directly at least, at the prevention and only in a secondary way even at the minimizing of loss; but what it seeks to accomplish is that such losses as do occur shall not fall exclusively, and possibly with overwhelming effect, on the owner of the property destroyed, but shall be borne in easy proportions by a large number of persons, who are all alike exposed to the risk of a similar catastrophe. This work of distribution is capable of being effected in more ways than one. It might be undertaken by the state or by a municipality, and this plan has been tried in several countries, notably in the canton of Zurich. There it applies to buildings only, not to their contents. The Government insures, and raises the necessary funds for meeting losses by a ratable tax on the owners. Where, as in this case, the exact sum needed is raised and no more, the system is practically one of mutual insurance administered by the cantonal authorities. Such a system yields this collateral benefit that the authorities, and indeed all house owners, become interested in the prevention and extinction of fires, and in Zurich accordingly the construction of buildings is carefully watched and regulated; but the results do not indicate any remarkable measure of success. The rate of assessment in 1870 was nearly equal to 2s. 6d. sterling per cent. The difficulties of carrying out such a system with equity, especially in a great community, seem almost insuperable. To assess the cost fairly it would be necessary, not merely to value each individual building, but to measure the degree of risk it was exposed to from its construction, its surroundings, its uses, and its contents. To place in the hands of public functionaries the power to do this, as well as to adjust the amount of compensation to be paid in the event of a fire, would be a course attended with manifest evils. Still greater would be the difficulty of applying the same principle to household goods, merchandise, and machinery; and, if these must be insured on some other plan, there seems little to be gained by setting up a different system for the insurance of buildings alone.

There is, however, a natural temptation presented to particular classes or communities to speculate in the insurance of their own property, in the hope of making a

profit, or at all events of saving for themselves what would go as profits to the companies which would otherwise insure them. Sometimes this temptation seizes the inhabitants of a particular town, sometimes the persons interested in some particular trade, sometimes an ecclesiastical body. A community which has taken out of the hands of joint-stock companies the supply of its own gas or water, and finds itself as well served as before, perhaps better served and more cheaply, is apt to think that it may insure itself against fire as well. But, besides the complications in the problem which have been already alluded to, and which require technical skill and extended experience for their equitable solution, there are few bodies or communities which possess a sufficiently wide area to make insurance profitable or even safe. If there had been such a system at Boston or Chicago or St John's when these considerable cities were ravaged by fire, the effects would have been still more disastrous to them than they were. Certain classes of property again seem liable almost to epidemic fires, from causes which are often not far to seek; and if, for example, the owners of any particular class of mills were to combine in a scheme of mutual insurance, they might find that, besides the great difficulty of agreeing on how each mill was to be rated, or on the compensation to be awarded on the occurrence of a fire, they were exposed to exceptionally numerous claims just when their own trade was most depressed, or when their relations with their work-people already loaded them with sufficient anxiety. Schemes of so-called mutual insurance are tried from time to time, but scarcely ever without being based on a subscribed or paid-up capital (the contributors to which have to be remunerated), or without looking for outside business to give breadth and ballast to the enterprise.

Accordingly the system of fire insurance which has virtually superseded all others, and has contributed most to the public benefit, is that which is conducted by joint-stock companies, offering to the insured the guarantee of their capital and other funds, and looking to make a profit by the business. It is a department of commercial activity eminently suited for joint-stock enterprise, requiring for its success, and indeed almost for its safe that its transactions should be various in character and spread over wide areas of space and time, and be invested with a certain amount of publicity, and enjoy that prolonged existence which attaches more to corporate than to individual effort.

Fire insurance as a business consists in undertaking a certain risk more or less considerable in amount, in return for a comparatively small sum, received beforehand, called the premium. While the amount of risk undertaken is strictly limited to the sum insured, the degree of risk is an element extremely difficult to measure, and liable to much fluctuation. Whether of ten thousand houses or shops, or stores, or factories, ten will be more or less injured every year by fire or a hundred is a matter partly of experience, but partly also of conjecture and, as we say, of chance. Assuming that the proportion would always be the same under precisely the same circumstances, not perhaps every year but on an average of years, the questions remain whether the circumstances will always be the same, and whether if they be the one thousand cases on which we have made our own calculations are a sufficient basis for dealing with ten thousand cases. The slightest observation reveals an endless diversity in the risks undertaken, and, even if an absolute law could be reckoned on, the risks would require careful and accurate classification before the law could be deduced. But, in point of fact, the risks are always changing. If we take what from an insurance point of view is the simplest and safest "risk," a private dwelling house in a large town, the question suggests itself, How has this risk been affected by the age of the building,

the character of the occupants, the introduction of gas or paraffin or lucifer matches, by the proximity of more dangerous property, and by the improvement or deterioration in the public supply of water and the public arrangements for extinguishing fires? Infinitely greater changes take place in the degree of risk attending warehouses and manufactories, and many of these developments are of an unexpected character. The great fire in Tooley Street, London, in 1861, was aggravated by a prodigious escape of burning tallow, which literally set the Thames on fire, and long defied all efforts to extinguish it. More lately at Leith a highly inflammable spirit recently introduced into trade exhibited similar characteristics. At Newcastle a fusion of nitrates of soda or potash mixed with burning timbers caused a prodigious aggravation of a fire; and at Glasgow and elsewhere the fine flour dust of a corn mill, when mixed with a certain quantity of atmospheric air, was unexpectedly found to be as explosive as gunpowder.

But the speculative hazard of fire insurance as a commercial enterprise is limited by a very important circumstance. The contracts, in the United Kingdom at least, are seldom made for a longer period than one year, and often for less, and need not be renewed on either side unless their safety and reasonableness are confirmed by experience, so that from day to day the insurance company is able in a measure to revise its terms, and to correct the errors arising from imperfect data or a too sanguine generalization. The business on the whole has been a profitable one. There have been comparatively few absolute failures of fire insurance offices in Great Britain, and none of any magnitude; nor do British companies regard it as any distinction that "they have always paid their losses in full." The returns of those companies whose accounts are published indicate general prosperity, and the quotations of the share market and other circumstances show that the companies whose accounts are not made public have had at least equal success. The thirty companies whose experience has been already quoted received in fire premiums during the seven years 1870-76 about 37½ millions sterling, and paid away for losses by fire about 22 millions, or 58·7 per cent. of the premiums received. After providing for expenses, there must have been a satisfactory balance of profit in proportion to the capital at risk.

The conditions of the contract between a fire office and the insured are regulated partly by the terms of the document known as the policy, which embodies them, and partly by law outside these terms, resulting from custom, from statute, or from legal decisions. We will endeavour to set forth as succinctly as possible some of these conditions, having regard chiefly to British contracts.

It is in the first place a contract of indemnity. The insured is guaranteed against loss by fire to the extent of the sum agreed on, but he is in no event to receive more than he has lost, or to make any profit by the occurrence of a fire. The sum named in the policy is not the measure but the limit of what he can recover. Nor does his policy cover all the loss he may sustain, for it will not in any case protect him against consequential damage, such as the loss of trade or of prospective profit; and if he desire to recover, not merely the value of a building, but the loss he will sustain through its being temporarily untenable, he must insure specially against that risk. He must have some substantial interest in the property he insures, but it need not be that of ownership, for, if he might lose as tenant or mortgagee or in any other capacity, he may insure against that loss; and he may insure against the loss which others would sustain for whom he holds the property in any fiduciary character. It is loss by fire only that is insured against, not loss by a fall in the market value of property or by natural tear and wear. If property



which was worth £1000 has come to be worth only £700, and is then destroyed by fire, it is £700 and not £1000 that is recoverable under the policy. In some cases loss by lightning and by explosions of gas are insured against, even where there has been no fire in the ordinary sense. It is the value at the time of the fire, or rather the difference in value which the fire has occasioned, that becomes the sum payable, provided it do not exceed the sum insured. It has been sometimes tried to have "valued policies" by which the sum to be paid in the event of the property being destroyed is fixed definitely beforehand; but the system has been felt to be open to grave objections; for, apart from the labour and cost of valuing a thousand properties in preparation for the total destruction of four or five, it is obvious that, if the value fixed is less than the real value, there is no advantage to the insured, but the contrary; and if it is greater than the real value, then no doubt the insured might make a profit by a fire, but this would offer an inducement to carelessness, if not to incendiarism. In the United States, however, several State legislatures have been so imprudent as to enforce the issue of "valued policies."

According to the general practice of insurance in Great Britain, the insured recovers his loss up to the amount of the policy, although the property may not have been insured to its full value. A different rule prevails on the Continent and elsewhere, and even in England under exceptional circumstances, and wherever several unconnected properties or parcels of goods are insured under one sum. In these cases the rule of "average" is applied, by which the insured recovers only such proportion of his loss as the total sum insured bears to the total value of the property covered. The effect of this rule is virtually to compel persons to insure their property to the full amount of its value, unless they are willing when any loss occurs to bear a share of the loss. Under either system, if property is not fully covered, the owner is to the extent of the deficiency his own insurer; but under the one plan his liability to loss begins only after that of the insurance company has been exhausted, under the other his liability and that of the company run parallel from the first. The difference is most material where the loss is only partial, and practically the English rule is equivalent to a considerable reduction of rate. There are weighty reasons for believing that it might be for the advantage both of the insurance offices and the public to introduce more widely the *pro rata* principle, with a corresponding reduction of the nominal scale of premiums, or even to enforce a participation of risk on the part of the insured.

The contract of insurance is one of good faith. The insured is bound to disclose all special circumstances of risk attaching to his property, and ought to have them described in the policy, otherwise its validity may be endangered. He is bound, moreover, to communicate any change of circumstances which may affect the degree of risk. Special hazards affecting particular kinds of property are often specially warranted against.

Companies do not insure against the loss occasioned by invasion, foreign enemy, civil commotion, riot, or any military or usurped power; and there are some kinds of property which they will not insure,—ready money, books of accounts (their value as documents), bank notes, stamps, bills, bonds, and other written securities.

The almost universal practice in England is to insure a separate sum on each distinct kind of property insured, as on a building and on its contents, on mercantile stock, and on furniture in private use. The same rule prevails with respect to all properties not involved directly in the risk of one fire. Thus two contiguous buildings or their contents may be insured for one sum if the buildings com-

municate with each other internally or have a common roof, but otherwise they must be separately insured.

Very important questions arise out of the circumstance that the same building or goods may be insured by different persons, with various offices, and under dissimilar conditions. Thus a house may be insured by the landlord, the tenant, and the mortgagee; goods may be insured by the owner, by a creditor holding a lien over them, and by the warehouseman or other person who may be responsible for their custody. Where the owner alone has effected insurances, these may be so varied in their character as to give rise to perplexing questions. A merchant may have insured with one office wines in a specified warehouse A; with another, wines and spirits in the same warehouse for one lump sum; and with a third, wines only, but in all or any of the warehouses A, B, and C, subject to the conditions of average. The questions that arise under such circumstances owe their solution as much perhaps to the honour and fair dealing of the several offices interested as to any settled rules of law, but the general practice may be shortly stated. As between a policy covering a specific parcel of goods or goods in a specified place and another embracing a wider range subject to average, the former is exhausted before liability attaches to the latter. As between a policy covering goods in A and B and another covering goods in A, B, and C, if a fire occurs in A or B liability attaches first to the more restricted policy, provided the more extended liability of the other is not merely nominal. On the other hand, if one policy insures stock and machinery together (but without the condition of average), and another insures one or both of these separately, liability attaches to both policies *pari passu*; but the former is placed at some disadvantage in being obliged to contribute ratably to its whole amount with certain limitations, as against each of the separate items of the other. Where the same property is insured under similar conditions with more than one office, it has been the aim of the companies to provide that the loss shall be borne by each in proportion to the sum insured, whether the several insurances may be in favour of the same person or of several persons having different interests. It is plain that if it were in the power of two persons, having each some sort of insurable interest in the same parcel of goods, so to insure them as that each might recover their full value, the goods might come to be paid for by the offices twice over, and it might become the interest of one or both of the persons that they should be burned. The "contribution clause" of policies is intended to guard against this. It has lately received an unexpected interpretation which limits its application to insurances in which the interests insured are identical, while protection against double payments is afforded by another principle, namely, that each person insures only his own special interest. The utmost possible interest which M, N, and P can have in any given property cannot exceed the present value of the property; each may recover what he himself has lost by its destruction, whether he be owner, or mortgagee, or depositary, but he deals separately with the office that insures him, without reference to what other insurances may have been effected by other persons having a different kind of interest in the same property. The application, however, of these principles is often matter of extreme difficulty, and has scarcely yet been definitely settled.

The adjustment of a loss when a fire occurs is not unattended with difficulty, even where there are no such complications as those just referred to. To ascertain the quantity, the quality, and the value of property injured, and the degree of injury, is often a work of no little anxiety. Its destruction has swept away the readiest proof which could have been given; or, where partial damage only has been sustained, it is often scarcely capable

of exact measurement. The insured is naturally bound to state and prove his claim; and the office, while exposed on the one hand to exaggerated and even to fraudulent demands, may on the other endeavour to exact from an honest claimant details and evidence which it is scarcely possible for him to give. Fortunately for both parties to the contract, there are strong motives on either side tending towards a reasonable adjustment. In most cases the office is guided by the advice of an independent professional valuer, who, while attending to the interests of his employers, has a natural desire, even apart from his instructions, to conciliate the claimant, and to avoid landing the company he represents in troublesome controversies. Claims which cannot be adjusted in this way are usually submitted to arbitration, and it is a condition of most policies that both sides must refer the quantum of loss to an arbiter or arbiters. Few claims find their way into the courts of law, and those only where some principle is involved, or where the claim is thought to be fraudulently overstated, or where the still more serious objection is taken that the fire has been the wilful act of the insured.

Many troublesome questions are rendered more easy of solution by the condition that it is in the power of the company to reinstate property rather than to pay the value of it. The insured has not the option of requiring reinstatement. In general an office prefers to settle a claim by payment in cash, but an offer to reinstate may be a convenient as it is a perfectly fair reply to an exaggerated demand, and may adjust the pretensions of competing claimants. The insured is not entitled to "abandon" his property, and the company is not bound to take on itself the care or risk of damaged property; it is for the insured to make the most of the "salvage," and to deduct the value of it from his claim, but in practice it is sometimes found desirable to relieve him of this duty.

A part of the insurance system which has developed into great magnitude is the practice of reinsurance. No one company, however large its resources, deems it prudent to undertake a risk to an unlimited amount in connexion with any one set of goods or one locality. An office might restrict its liabilities by refusing to insure to a larger amount than what it pleased to run the risk of, but the convenience of the insured and the interest of its own agents, to say nothing of other considerations, make it difficult for any office so to limit its responsibilities. It therefore issues a policy for the amount proposed to it, but reinsures a part with some other office or offices. Business to a very large amount is exchanged in this way, and there are some offices which professedly, and some which practically, live by the premiums paid over to them by other offices. The principal British offices have established a code of laws for the regulation of these transactions, and a court of arbitration for the decision of such questions as may arise among themselves in connexion with them. They are often also matter of special contract between office and office. The system is of some benefit to the public. In the earlier periods of fire insurance, when a large sum had to be insured, a higher rate was charged; but this has long ceased to be the rule. A man who wishes now to insure a large amount has not only no extra rate to pay, but has not to take the trouble of arranging with numerous offices, or, if a fire occurs, of adjusting his loss with numerous offices. He can usually, if he pleases, obtain a policy from one company for the full sum he needs to insure, and the company takes all the trouble and risk of distributing the liability, a distribution with which he has nothing to do. He may even benefit in another way, for when a loss occurs he has on the whole, perhaps, a better chance of being liberally dealt with than if he had to make a direct claim on many offices.

What has been said hitherto has had reference chiefly to one side of the fire insurance contract—the obligations undertaken by the company. The consideration they receive in return is the payment made by the insured called the "premium." The premium is calculated at so much per cent. of the sum insured, and is usually paid once a year, at one or other of four quarter days; but many insurances are effected on mercantile property and on ships for periods less than a year—ten days, one, three, or six months—the rate in such a case being higher than an aliquot part of the yearly rate; and insurances may be effected for seven years by a payment of six times the yearly rate, and for other periods at a proportionate discount. Insurances effected for a year, and stated to be renewable, practically remain in force for fourteen or fifteen days after the expiry of the year; that is, they may be renewed by payment of the premium within these "days of grace," and if a fire occurs in the meantime the company will be liable. This will not happen, however, if an intention not to renew has been manifested on either side.

The rate of premium varies with the supposed risk, and in Great Britain runs from 1s. 6d. per cent. yearly, the rate for first-class dwelling-houses and ordinary private furniture, to six or seven guineas per cent. The highest British rates are what are charged for some descriptions of corn-mills and sugar refineries, and for Turkey red dye-works. Large classes of property are insured at the ordinary "hazardous" rate of 2s. 6d., or "extra hazardous" rate of 4s. 6d., but certain descriptions of property are specially and more elaborately rated. This has been done to a considerable extent by common agreement amongst the offices, and the arrangements are known as the "tariff system," which requires here a few words of explanation.

We may suppose the question to arise, What ought to be paid for insuring a cotton-mill, or a flax or woollen mill, or a weaving factory, or a wharf or warehouse in some large city? The experience of any one office scarcely affords adequate data, and a rate based on the combined experience of many offices has a greater chance of being at once safe and fair. The problem, indeed, is a more complicated one than what has been already said would indicate. The property to be insured may consist of several distinct buildings and the contents of them: one building may be devoted to operations involving in a high degree the risk of fire; in another the processes carried on may be more simple and safe; a third may be used only for the storage of materials having little tendency to burn. These several buildings may be more or less connected with each other—under the same roof, under different roofs but with internal communications, contiguous but without any communications, detached but still within reach of fire. Of two mills one may work on fine materials, the other on coarse; in one the machinery may be driven twice as fast as in the other; in one the most hazardous processes may be carried on in the heart of the building, in the other they may be so treated and so guarded as to involve the rest of the property in no peculiar danger. Fairly to measure these various hazards it has been found necessary that the experience and skill at the command of many companies shall be combined, and that the rates shall be the result of consultation and a common understanding.

Now it is clear that no office will contribute its skill and experience to such a common stock if the effect is to be that other offices may avail themselves of the information in order to undersell it. Consultation about rates and a common understanding necessarily involve a reciprocal obligation to charge not less than the rates thus agreed on; in other words, a tariff of rates is developed to which each office binds itself to adhere. The system tends to restrain and moderate the competition for business which inevitably



and to some extent properly exists among the companies, and its value to them is manifest. But it is also of service to the insuring public. At first sight it might seem that free competition would suit the public best, and that a combination among the offices must tend to keep up rates, and to secure for the companies excessive profits, but a little consideration will show that this is a mistake.

It is an unquestionable truth, though one often lost sight of, that all losses by fire must ultimately be borne by the public. The insurance companies are the machinery for distributing these losses, nothing more. If the losses fell on them, their funds, large as they are, would speedily be exhausted, and the service which they render to the public would come to an end. To those who require insurance against loss by fire it must be a manifest advantage that they should have many sound and prosperous offices ready to accept their business, and no less able than desirous to earn or to retain the public favour by fair and liberal conduct. A necessary condition of this state of things is that the rates of premium paid for insurance should be remunerative to the offices, and the main object of the tariff system is to secure such remunerative rates.

This it endeavours to do by two methods,—by an agreement as to what rates are to be charged, and by affixing such a penalty to dangerous constructions, substances, and processes as to induce, if possible, a lessening of the danger. In other words, and reversing the order, it seeks to diminish the risk of fire, and to secure adequate payment for what risk remains. There can be no doubt as to the benefit the public derive from the former of these, in having pointed out to them, not on the authority of one office, still less on hesitating and contradictory authority, but with all the weight arising from the combined experience of numerous companies, that this or that method of construction, this or that combination of materials, this or that mode of conducting a manufacturing process, is attended by imminent hazard of fire, and in having the lesson enforced by a heavy pecuniary penalty. On the supposition that the offices are correct in their estimate of risks, the effect, and indeed the intention, of their rule is not so much to put money into their own coffers as to lessen the danger, and to save themselves in the first instance, and the owners of property ultimately, from the consequences of preventible fires.

These rules, as will readily be seen, must have powerful influences on trade and manufactures. Many individual warehouses and mills are, with their contents, insured for very large sums, £10,000, £20,000, £50,000, £100,000, and more. An additional charge of 5s. or 10s. per cent. in respect of a supposed increase of risk may mean a payment by the owner of several hundred pounds a year, and may operate as a complete veto on some arrangement or some machine which it might otherwise be desirable to resort to. The occurrence of a few severe fires in one town, followed by an increase of insurance rates, may have, and indeed has had, the effect of driving some branch of trade away to another locality, the seat of greater caution or better fortune. It is therefore obviously desirable that so important an influence should be exercised, not precariously or capriciously, but according to the combined wisdom and experience of those associations which may be supposed to understand the subject best, and which obtain their experience in the way that makes it perhaps of most value, by paying for it.

It is equally for the public benefit that rates of insurance should be fixed on some common scale. Suppose the system of unrestricted competition to be tried, the first effect will be a general and great reduction in rates. But it may be said, "So much the better for the insured; if the offices can afford this reduction of rate it will only be

a fair result of competition; if they cannot afford it, they will be the losers, but the public will gain; will the effect not be simply to reduce the rates to the paying point, and no further?" This would be all very well if the paying point could be absolutely ascertained or determined in any way beforehand, but the rate comes first and the losses come afterwards. In other businesses prices are based on some certainty as to the cost of production, but in selling fire insurance the cost is not known till after it has been sold. In a free competition it is the sanguine man's views which regulate the market price, and the rates therefore cease to be remunerative. The consequences are that some offices disappear altogether, others take fright in time to avoid ruin, though not to escape serious loss, persons who might establish new offices are deterred from doing so, the business gets the character of being a highly speculative and hazardous one, requiring extravagant profits to induce men to carry it on at all, and the public have to bear the cost. Unrestricted competition therefore is not for their advantage.

The combination we are considering has another beneficial effect; it serves to distribute the burden of losses fairly. If it is a just thing that cotton-spinners should bear all the losses that arise in cotton-mills, and not leave them to be borne by the owners of private dwelling-houses, or *vice versa*, it is well that the loss by each class of risks should be measured fairly. But, while the experience of any one office, taken by itself, furnishes a very imperfect criterion, each contributes its quota of knowledge and experience to the common stock, and the public get the benefit both of broad and trustworthy data and of that peculiar and intimate acquaintance with each different class of property or process which the conductors of one company or another are sure to possess.

On the other hand, it is beyond question that no association of the kind will ever hold together a large body of independent societies, except under the pressure of some necessity. No conventional or excessive rates can be maintained for any length of time. Some member of the union is sure to perceive that popularity and profit may be gained by introducing a lower rate, if a lower rate is manifestly sufficient, or a new company starts into existence to remedy the grievance. It is to be remembered, too, that the directors and shareholders who control the offices are likewise insurers, quick to raise the question of how far the rates they have to pay as individuals are justified by the risks run; and if it cannot be shown that these rates are a true measure of the risk, offices are soon constrained by a sense of justice or by self-interest or by pressure from without to mitigate them. In short, the association is a union bound together by necessity and tempered by competition.

Adequately to measure the risk of loss by fire demands not merely reference to an extended experience but a watchful regard to current changes. While the profits of fire insurance business fluctuate considerably from year to year, and seem even to follow cycles of elevation and depression, the tendency on the whole appears to be towards a growth of risk, although excessive competition among offices prevents the rates from rising in proportion. Among the causes are the prodigious increase in the use of lucifer matches; the introduction into commerce of such articles as jute and esparto grass and mineral oils, which are either highly inflammable, or have by themselves, or in combination with other substances, a tendency to generate combustion; the great speed of machinery; and the vast accumulation of property exposed to the risk of one conflagration, owing to the larger size of mills and warehouses and their concentration in particular localities. The very development of the insurance system may conduce to

heighten the risk by lessening the motives to carefulness. It is difficult to form an estimate of the average rate of premium paid for property in the United Kingdom, but it is probably not much above or below 4s. or 2 per cent. yearly.

When insurance companies were first established, and for a long time afterwards, they undertook not only to reimburse the insured for losses, but to extinguish fires. In one of the earliest prospectuses put forth (in 1684), there is the promise that "watermen and other labourers are to be employed at the charge of the undertakers to assist at the quenching of fires." A writer in 1690, describing the ingenious and useful invention of a fire insurance office, says, "They have a great many servants in livery with badges, who are watermen, and other lusty persons dwelling in several parts of the city, who are always to be ready when any sudden fires happen, which they are very laborious in and dexterous at quenching"; and De Foe, in an essay published in 1697, refers to the same subject. In 1708 when the Sun Fire Office was first projected, it was proposed that all persons insured with it should have a mark representing the sun nailed up against their houses, that the men whom it employed to extinguish fires and save property might direct their efforts specially for the benefit of the houses so distinguished. Marks of this sort were afterwards generally adopted by the offices, and are often to be seen even at the present day, though they no longer serve their original purpose. For more than a century and a half the insurance offices provided and kept up fire-engines at their own expense, not only in London but in many provincial towns, where frequently no other means of extinguishing fires were available. At first each office provided its own engine, and much rivalry prevailed among the several brigades; but in London ultimately the offices combined to support in common a very effective and very costly fire brigade. This arrangement, however, came to be regarded as objectionable from public points of view, as it had long been distasteful to the offices themselves; and in 1866 the offices handed over their whole establishment to the Metropolitan Board of Works, by whom it has been greatly enlarged and extended, the cost being provided for partly by a contribution from the offices, partly out of the Consolidated Fund, and partly by the rates.

The views of the insurance offices on this subject have undergone a material change, and they have ceased to regard it as any part of their duty to extinguish fires, or to bear the cost of extinguishing them. That ought to be undertaken by the public through municipal or other local authorities, and it is understood that the law regards it as their duty to do so. Parliament is always ready to confer the necessary power of assessment; but there is a disposition on the part of municipal bodies to exact from the insurance offices, directly or indirectly, as much of the expense as they can. Considerable contributions are in this way levied in Liverpool, Manchester, Glasgow, and other towns, but the system is eminently to the disadvantage of the public. Whatever the offices are compelled to pay forms a portion of their general expenditure, which they must recover from the public, at least the insuring part of it, in the form of premiums. The amount would be more equitably levied by means of a general assessment, and would be more likely to be advantageously expended. The business of fire insurance is to meet the losses which happen by fire, not to prevent them; if losses are heavy, the rates of premium must follow; if by care and well-organized appliances losses are diminished, the competition among the offices will inevitably reduce the rates of premium. In other words, if the public themselves bear the cost of these appliances, they obtain the benefit of it

in a reduced cost of insurance; if they transfer the burden to the offices, they have in the end to bear it themselves in the form of increased insurance rates. If there were, as there ought to be, an efficient fire brigade in every town and village, it is obvious that the insurance offices could neither bear the cost nor undertake the care of them, and the best arrangement would be that they should be wholly under local management and wholly at local expense.

But, while it is the business of the public authorities to extinguish fires, the insurance offices regard it as within their province to promote in other ways the safety of the property endangered, and accordingly in London, Liverpool, Glasgow, and other cities they have established at their own expense salvage corps, which act in alliance with the fire brigades, but whose special duty it is, not so much to quench a fire, as to diminish as far as they can the damage which may be occasioned to the property whether by the fire or by the water used to extinguish it.

It only remains to add, with reference to fire insurance in the United Kingdom, that public attention has from time to time been directed to the serious question of how far the crime of arson may be regarded as a consequence of the insurance system, and what can be done to prevent it. There can be no doubt that wilful fire-raising, with a view to defraud insurance offices, is not only a very common offence, but is probably on the increase. In 1867 the subject was inquired into by a committee of the House of Commons, and evidence was submitted to show that between 1852 and 1866 the proportion of fires which were suspicious, doubtful, and unaccounted for had gradually increased from 34½ to 52½ per cent., while well-informed persons testified that the number of fires in insured property is greater in proportion than in uninsured. There is a general agreement that in the interests of the public the origin of all fires should be made the subject of organized inquiry, but there is a difference of opinion as to the proper machinery and as to the incidence of the expense. Of existing functionaries the coroner in England and the procurator-fiscal in Scotland seem the natural persons to conduct the needful investigations, but in neither case is the subject free from difficulties, which in England are enhanced by the want of a public prosecutor. Several attempts have been made to legislate on the subject, but hitherto without success, nor is the public feeling sufficiently strong to give the required impulse. Other crimes than arson thrust themselves on public notice, and all men see the necessity for inquiry and detection. This crime, when successful, too often destroys, not merely the evidence which would go to prove it, but the very circumstances which would indicate that a crime has been committed. The immediate sufferer, too, is probably some wealthy insurance company, whose case naturally excites little sympathy; it is seldom prudent and sometimes scarcely safe for the sufferer to insist on exceptional inquiries, and there is a general disposition rather to put up with a loss than to raise disagreeable questions likely to lead to nothing. But, as the honest portion of the community pay for all dishonest claims, it may be hoped that a due inquiry into the causes of fires will some day come to be regarded as a matter of grave public interest.

The general principles and practice of fire insurance are, in their main features, the same in most parts of the world. In the United States the business has been pursued with characteristic energy, and with some peculiarities of law and practice. As already stated, the earliest American fire insurance company was organized in 1752, and its policies during the first year covered a sum of \$108,360 at an average rate of 1.17 per cent. At the present time there are within the State of New York alone upwards of eighty fire offices, having assets amounting to about 54 millions



of dollars, and in the *Insurance Year-Book* for 1880 there is a list given of about four hundred different native offices in the various States, but this does not include a large number of local offices of small dimensions, mostly established on the mutual principle. The number of fire insurance offices in the United States is probably about nine hundred. Of these a large proportion have a merely nominal existence, but on the other hand important foreign offices—British, French, German, Swiss, and Canadian—transact business in the States.

If sixty offices suffice to transact the insurance business of the United Kingdom and a great deal of foreign business besides, the existence of more than four hundred offices in the States indicates of itself that a large number of them must have very limited resources, quite unfit to cope with the disastrous fires which sometimes occur in the rapidly developed cities of America. The failure of an insurance office is therefore a more familiar event than in England, and it is this perhaps partly which has led to a system of Government supervision intended to guard the public against such misfortunes. Each State of the Union has its own regulations about insurance companies, its insurance department, its insurance commissioner, superintendent, or auditor, its system of accounts and checks and public notices, its fees, taxes, and requirements as to deposits. The trouble and expense to which offices are thus exposed, especially where they do business in many States, is very great indeed, while the resulting benefits are problematical. All attempts of this sort are attended with these disadvantages, that they interfere injuriously with honest and well-conducted companies, and afford but a feeble protection against those of a different class; that they involve the Government in the odium of failures which it is supposed to be their duty to prevent; that they lessen the sense of responsibility among those who control the offices, and the spirit of prudence and watchfulness among the public; and that they place in the hands of public officials a power and influence which are apt to be abused, and are always open to suspicion. More to be admired and imitated are the State regulations in America with respect to building operations, the extinguishing of fires, and the inquiring into their origin. The business of an insurance agent in America is more recognized than in England as a distinct profession, and the agent is entrusted with greater powers. More has been done to facilitate the working of insurance by the surveying and mapping of large cities, and there has been a greater development of periodical literature devoted to the subject.

Since 1866 a national board of fire underwriters of the United States has existed, and has proved of great service to the insurance offices and to the public. At the present time it is unfortunately suffering from disorganization, and there has been a consequent "shrinkage" of rates. It appears from the reports of the superintendent of the fire department in the State of New York that in the year 1879 the sums insured in the United States by the companies reporting to him amounted to 6767 millions of dollars, and the relative premiums to nearly 61 millions of dollars, so that the average rate of premium was 9 per cent., or 90 cents for each hundred dollars insured. Fourteen British fire offices doing business in the States received in the year 1879 premiums to the amount of 11 millions of dollars, and paid losses of 7 millions. Their losses that year were 63 per cent. of their premium, and their expenses in America 31 per cent.

In Canada twenty-seven companies—Canadian, British, and American—made returns, which showed that in 1879 they had insured in Canada, including the maritime provinces, sums amounting to 385 millions of dollars. In the eleven years ending in 1879, the premiums received

had amounted to nearly 33 millions of dollars, and the losses to 27½ millions, and the ratio of loss had been 84·16 per cent. This included the loss arising from the great fire at St John's, New Brunswick, in June 1877, which cost the insurance offices 6½ millions of dollars.

In France there were at a recent date thirty-two proprietary and about twenty mutual fire insurance offices. Of the thirty-two offices founded on capital three are provincial offices, and the others are established in Paris. Two confine themselves to reinsurance. From the returns made by twenty-three of these offices, including all the more important, it appears that in 1879 their income from premiums was about 92 millions of francs, and their losses 47 millions. The average loss during eleven years was 50 per cent. of the premiums. Many of the French offices have been extremely successful; and recently there has been a remarkable increase of new offices in that country.

The *Insurance Cyclopædia* of Mr Cornelius Walford, a work now in progress, and of prodigious industry and completeness, is the best and almost the only available literary authority which covers the whole subject of this article. The *Law of Fire Insurance*, by Mr. C. J. Bunyon, is also of value. (J. M. M'C.)

## II. LIFE INSURANCE.

The system of life insurance embraces a variety of contracts by which the insurers engage to pay capital sums on the decease of policyholders or nominees, in consideration of other sums received during their lifetime. These contracts may be divided into two classes,—(1) those in which the sum insured is certain to become payable, provided only the insurance is duly kept in force, and (2) those which are of a temporary or contingent character, so that the sum insured may or may not become payable according to circumstances.

To the first of those classes belong the great bulk of the transactions of life insurance offices, namely:—

Various  
of life in-  
surances

1. *Whole-Term Assurances on Single Lives.*—These are simply contracts on the part of the insurance office to pay a certain sum (with or without "bonus additions," as the case may be) on the death of the person named in the policy, whenever that may occur. The premium, or consideration for the insurance, is in most cases an annual sum payable during the whole continuance of the policy. It may, however, be arranged in various other ways,—as, for example, by a single payment at the commencement of the transaction; or by a limited number of contributions, each larger in amount than the annual premium for the whole of life; or by payment of a modified rate during a limited period and a correspondingly higher rate thereafter. Insurances for the whole term of life are more common than any other kind.

2. *Endowment-Assurances.*—Next to insurances for the whole term of life, these constitute the most numerous class of insurances on single lives. The sum insured is payable to the person named in the policy, if he should survive a certain period or attain a specified age, or to his representatives at his death, if that should occur before the time has expired.

3. *Insurances on Joint Lives.*—In these transactions two or more lives are included in the policy, and the sum insured is payable when either or any one of them falls.

4. *Longest-Life Insurances, or Insurances on Last Survivor.*—These also are effected on two or more lives, but, instead of falling in by the death of any one of the parties, they do not mature until both or all are dead.

The second class of insurances described above consists principally of two kinds:—

1. *Temporary or Short-Period Insurances.*—These are effected for limited periods to cover special contingencies,

the sum insured becoming payable only if death should occur within the time specified in the policy. Such insurances may be effected on single lives or on two or more lives, and (in the latter case) may be payable either if one life or all the lives should fail within the period, or only if one life should fail before another, as in the case to be next mentioned.

2. *Survivorship Insurances, or Insurances on one Life against Another.*—In these the sum insured is payable at the death of A if that should happen in the lifetime of B, but not otherwise. Should B predecease A, the transaction falls to the ground.

Besides these there are transactions of other kinds dealt in by life insurance offices—such as deferred insurances, where the risk does not commence until the expiry of an assigned period; deferred and survivorship annuities; insurances against issue, for the benefit of expectant heirs; and the like. The system is indeed adapted to nearly every contingency of a pecuniary nature connected with human life.

It may be observed that, while life insurance has much in common with fire and marine insurance, there are some essential differences between it and them. The insurance of houses and goods against fire, or of ships and merchandise against the casualties of the sea, is a contract of indemnity against loss, and in like manner an insurance on human life may be regarded as indemnifying a man's family or his creditors or others interested against the loss of future income by his premature death. But it does not necessarily take the value of such income into account, nor does it relate to any intrinsic value of the *subject* of the insurance—the life of the insured party. Again, in fire and marine insurance loss may be either total or partial. In life insurance the event insured against cannot take place in any limited degree, and there is thus no partial loss. And again (in the first and larger of the two classes into which life insurances are divided) the event is certain to occur, and the time of its happening is the only contingent element. In the other kinds of insurance the events are wholly of a contingent character.

The idea of distinguishing in terms between contracts which differ so widely in reality appears to have early suggested itself. Mr Babbage in his *Comparative View of the various Institutions for the Assurance of Lives*, published in 1826, says—"The terms *insurance* and *assurance* have been used indiscriminately for contracts relative to life, fire, and shipping. As custom has rather more frequently employed the latter term for those relative to life, I have in this volume entirely restricted the word *assurance* to that sense. If this distinction be admitted, *assurance* will signify a contract dependent on the duration of life, which must either happen or fail, and *insurance* will mean a contract relating to any other uncertain event, which may partly happen or partly fail. Thus, in adjusting the price for insurance on houses and ships, regard is always had to the chance of salvage arising from partial destruction."

The distinction proposed by Mr Babbage has not always been observed. Some writers appear to prefer the term *insurance* where life is concerned as well as in other cases; some continue to use the terms indiscriminately; while other recent writers have sought to establish distinctions of a novel character between them. One of these is that a person *insures* his life, his house, or his ships, and the office *assures* to him in each of these cases a sum of money payable in certain contingencies. Another is that *assurance* represents the principle and *insurance* the practice. Of these two suggestions we prefer the former; but, as the more conventional distinction of Mr Babbage is still very widely recognized, we shall adhere to it throughout the remainder of this article.

*Calculation of Premiums.*—The general principles of life contingency calculations are explained in the article *ANNUITIES*, and it is there shown that such calculations are made by means of mortality tables, which exhibit the numbers of persons who out of a given number born or living at a particular age live to attain successive higher ages, and the numbers of those who die in the intervals. A full account of the numerous tables of this kind which have been framed from time to time does not fall within the scope of the present article, but, before passing on to show the application of mortality tables in the various calculations relating to assurances upon lives, it may be useful to mention those tables which have been chiefly employed by assurance offices.

Passing over the earlier tables of Halley, De Parcieux, and others, which for all purposes of calculation have long been obsolete,—and which, however much they contributed in their day to the development of assurance, possess now only an historical interest,—we pause first at the Northampton Table. This was constructed by Dr Thomas Price from the registers kept in the parish of All Saints, Northampton, for the forty-six years 1735 to 1780. Owing to certain faults in its construction, the table gives the chances of death too high at the younger ages, and consequently requires large premiums for assurances; while at the more advanced ages the chances of death are disproportionately low. For a long time, however, this table occupied the foremost place as a basis for life contingency calculations of all kinds, and even after the introduction of other tables, which are now recognized as more accurate, it continued to receive a large share of popularity. The rates of many assurance offices of high standing were calculated from it, and until a comparatively recent date it remained in use by not a few of them.

The Carlisle Table was constructed by Mr Joshua Milne from materials furnished by the labours of Dr John Heysham. These materials comprised two enumerations of the population of the parishes of St Mary and St Cuthbert, Carlisle, in 1780 and 1787 (the numbers in the former year having been 7677 and in the latter 8677), and the abridged bills of mortality of those two parishes for the nine years 1779 to 1787, during which period the total number of deaths was 1840. These were very limited data upon which to found a mortality table, but they were manipulated with great care and fidelity. The close agreement of the Carlisle Table with other observations, and especially its agreement in a general sense with the experience of assurance companies, won for it a large degree of favour. No other mortality table has been so extensively employed in the construction of auxiliary tables of all kinds for computing the values of benefits depending upon human life. Besides those furnished by Mr Milne, elaborate and useful tables based upon the Carlisle data have been constructed by David Jones, W. T. Thomson, Chisholm, Sang, and others. The graduation of the Carlisle Table is, however, very faulty, and anomalous results appear in the death-rates at certain ages.

The mortality experience of the Equitable Assurance Society, the pioneer of the modern system of assurance, has formed the basis of several tables. Of these two in particular have been used to a considerable extent by assurance companies. The first was a table constructed by Mr Griffith Davies and published by him in 1825. It was deduced from accounts given by Mr W. Morgan, the actuary of the society, of the ratio which the death-rates among the members bore to those indicated by certain well-known tables at different ages. The other table was constructed by Mr Arthur Morgan from the statistics of membership of the society from its commencement in 1762 down to 1829. This table was published in 1834.



Seventeen offices' experience.

Shortly afterwards a desire began to be pretty generally felt for a table of observations more extended than the statistics of any single office could supply, and accordingly a movement was set on foot in 1838 by a number of actuaries and others for collecting the experience of various offices "to afford the means of determining the law of mortality which prevails among assured lives." Seventeen offices agreed to contribute their statistics, which were found to embrace in all 83,905 policies, of which 44,877 were in existence at the time of giving in the returns; 25,247 had been "discontinued"; and 13,781 had fallen by the death of the persons assured. The results of the inquiry were in due time published, and upon them was founded a mortality table known as the Seventeen Offices' Experience Table, which came to be used to a considerable extent by assurance companies. A peculiarity of this table is that it is based upon the experience of the offices in regard to the number of policies which existed and became claims, and not the number of persons who were assured and died. There having been in many cases two or more policies issued on one life, the results are not necessarily the same as those which would have been obtained had each life been reckoned only once. The general agreement of the results with those derived from other data referring to persons, and not to policies, seems to show, however, that the peculiarity referred to does not materially affect the accuracy of the table as an exponent of the value of assured life.

English Life Tables.

Three English Life Tables have been constructed by Dr William Farr from the official records of the registrar-general for England and Wales. The first, contained in the *Fifth Report of the Registrar-General* (1843), was founded on the census returns of 1841, and the deaths recorded in that year. The second table, contained in the *Registrar-General's Twelfth Report*, was based on the same census and the deaths of the seven years 1838 to 1844. The third table had a much wider basis than either of the others. It embraced the census returns of 1841 and 1851 and the deaths of seventeen years (1838-1854). This table, with an extensive series of monetary and other tables deduced from it, was published as a separate work in 1864.

Institute of Actuaries' Tables.

The next set of tables demands more special notice in an article like the present, as being the most important collection of observations yet made in regard to the mortality of assured lives. "Nearly a quarter of a century having elapsed since the period to which the combined experience of seventeen life assurance offices was collected, it began to be felt amongst actuaries and the managers of companies that a large mass of valuable materials had accumulated which, if combined, would tend to throw further light on the law of mortality amongst assured lives, and on other points affecting the interest and prosperity of assurance companies." Accordingly steps were taken by the council of the Institute of Actuaries, in co-operation with committees of the Association of Managers of Scottish Life Assurance Offices and of the Faculty of Actuaries in Scotland, "to collect and combine, as far as possible, the experience of the life assurance companies of the United Kingdom to the present time." This movement was begun in 1862, and in 1869 the results of the inquiry were published in a volume containing 282 pages of tabular matter, with a preface (from which the above quotations are taken) by Mr Samuel Brown, then president of the Institute of Actuaries. The preface details the processes employed in collecting and arranging the statistics, and indicates the more important conclusions to be drawn from them.

The experience collected on this occasion embraced the returns of twenty offices—ten English and ten Scotch—the total number of lives assured being 160,426, of whom

26,721 had died, 45,376 had discontinued their policies, and 88,329 remained on the books of the several offices at 31st December 1863, the date to which, as a rule, the observations were brought down.

From these statistics several distinct mortality tables were constructed, viz.:

Table H<sup>M</sup>F, comprising all the *healthy lives, male and female*, included in the observations,—the word "healthy" being used to denote those lives which had been considered eligible for assurance at the ordinary rates of premium.

Table H<sup>M</sup>, comprising the *healthy male* lives only.

Table H<sup>F</sup>, comprising the *healthy female* lives.

Other tables of a subsidiary character were constructed, but they do not appear to have been put to any practical use.

The completed tables were published in 1872, together with an extensive series of monetary values deduced from them, and explanations by Mr W. S. B. Woolhouse and Mr Peter Gray respectively, as to the method of graduation employed in the formation of the tables, and as to the construction and application of the monetary values. In 1873 Mr R. P. Hardy published a series of *Valuation Tables* based upon these data.

It appeared to the two bodies in Scotland already mentioned that considerable advantage might result if the experience of the Scotch offices were separately ascertained, besides being merged in the general inquiry. This was accordingly done, and the results, arranged and tabulated by Mr James Meikle, were published in a report (1869) by the joint committee appointed to collect the information. The investigation embraced 115,254 policies on 94,749 lives, of whom 12,443 had died, 19,284 had discontinued their policies, and 63,022 remained on the books of the ten offices at 31st December 1863. These separate Scotch statistics were intended more particularly to illustrate the effects of the selection of lives for assurance. They have not been commonly employed as a basis for the calculations of offices. In 1872 Mr Meikle published *Observations on the Rate of Mortality of Assured Lives*, in which the materials furnished by these statistics are exhaustively treated. This work forms a most valuable contribution to our knowledge of the subjects with which it deals.

The following tables will serve as a means of general comparison between the various mortality tables that have been mentioned.

I.—TABLE showing the Number of Persons who, out of 1000 living at the age of 10, will live to attain the ages of 20, 30, 40, &c., according to the undermentioned Mortality Tables.

Age.	Northampton 1780.	Carlisle, 1815.	Equitable (Davies), 1825.	Equitable (Morgan), 1834.	Seventeen Offices' Experience 1843.	English, No. 3 (Males), 1864.	Institute of Actuaries' H <sup>M</sup> , 1869.
10	1000	1000	1000	1000	1000	1000	1000
20	904	943	951	928	933	945	962
30	773	873	879	861	863	863	899
40	641	786	786	784	787	771	823
50	503	681	681	692	695	661	727
60	359	564	536	559	560	517	581
70	217	372	361	360	353	324	38
80	83	148	169	140	133	116	139
90	8	22	23	13	13	14	15

II.—TABLE showing the "Expectation of Life" or "Mean After-Life time" of persons aged 10, 20, 30, &c., according to the undermentioned Mortality Tables.

Age.	Northampton 1780.	Carlisle, 1815.	Equitable (Davies), 1825.	Equitable (Morgan), 1834.	Seventeen Offices' Experience 1843.	English, No. 3 (Males), 1864.	Institute of Actuaries' H <sup>M</sup> , 1869.
10	39.78	48.82	48.83	48.32	48.36	47.05	50.29
20	33.43	41.46	41.06	41.37	41.49	39.48	42.06
30	28.27	34.34	33.98	34.53	34.43	32.76	34.68
40	23.08	27.61	27.40	27.40	27.28	26.06	27.40
50	17.99	21.11	20.83	20.36	20.18	19.54	20.31
60	13.21	14.34	15.06	13.91	13.77	13.53	13.83
70	8.60	9.13	9.84	8.70	8.54	8.45	8.50
80	4.75	5.51	5.38	4.75	4.78	4.93	4.72
90	2.41	3.28	2.65	2.56	2.11	2.84	2.36

Having given this table for the purpose of comparing in a general way the characteristics of the several mortality tables to which it relates, it is right we should say, in order to avoid misconception, that the "expectation of life" does not enter into calculations for determining the value of sums dependent on human life, or for ascertaining the premiums required for life assurances. The nature of these latter calculations will be explained presently.

As a specimen of a mortality table deduced from actual observation of assured lives, we give in full the last of the tables from which the foregoing particulars are deduced, viz. :-

III.—The  $H^M$  Table of the Institute of Actuaries.

Age.	Number Living.	Decrement.	Age.	Number Living.	Decrement.	Age.	Number Living.	Decrement.
$x$	$l_x$	$d_x$	$x$	$l_x$	$d_x$	$x$	$l_x$	$d_x$
10	100,000	490	40	82,284	848	70	38,124	2371
11	99,510	397	41	81,436	854	71	35,753	2433
12	99,113	329	42	80,582	865	72	33,320	2497
13	98,784	258	43	79,717	887	73	30,323	2554
14	98,496	272	44	78,830	911	74	28,269	2578
15	98,224	282	45	77,919	950	75	25,691	2527
16	97,942	318	46	76,969	996	76	23,164	2464
17	97,624	379	47	75,973	1041	77	20,700	2374
18	97,245	466	48	74,932	1082	78	18,326	2258
19	96,779	556	49	73,850	1124	79	16,068	2138
20	96,223	609	50	72,726	1160	80	13,930	2015
21	95,614	643	51	71,566	1193	81	11,915	1883
22	94,971	650	52	70,373	1235	82	10,032	1719
23	94,321	638	53	69,138	1286	83	8,313	1545
24	93,683	622	54	67,852	1339	84	6,768	1346
25	93,061	617	55	66,513	1399	85	5,422	1138
26	92,444	618	56	65,114	1462	86	4,284	941
27	91,826	634	57	63,652	1527	87	3,343	773
28	91,192	654	58	62,125	1592	88	2,570	615
29	90,538	673	59	60,533	1667	89	1,955	495
30	89,865	694	60	58,866	1747	90	1,460	408
31	89,171	706	61	57,119	1830	91	1,052	329
32	88,465	717	62	55,289	1915	92	728	254
33	87,748	727	63	53,374	2001	93	469	195
34	87,021	740	64	51,373	2076	94	274	139
35	86,281	757	65	49,297	2141	95	135	86
36	85,524	779	66	47,156	2196	96	49	40
37	84,745	802	67	44,960	2243	97	9	9
38	83,943	821	68	42,717	2274	98	0	0
39	83,122	838	69	40,443	2319			

In order to show the method of calculating assurance premiums, we shall first suppose the premiums to be payable in one sum, and shall employ an illustration founded on the above table. We learn from the table that, of 96,223 persons living at the age of 20, 609 will die before reaching the age of 21; of the 95,614 persons remaining alive at the latter age, 643 will die before reaching the age of 22; and so on. Let it be supposed that 96,223 persons of the age of 20 are desirous to have their lives assured, each for the sum of £1 to be paid at the end of the year in which he shall happen to die; and let it be further assumed that the  $H^M$  table represents correctly the number of deaths that will occur among these 96,223 persons in each successive year, until the last of them dies between the ages of 97 and 98. According to the hypothesis, 609 payments of £1 each will fall to be made at the end of the first year, 643 at the end of the second, 650 at the end of the third, and so on until finally 9 payments fall to be made at the end of the seventy-eighth year. In order, therefore, to ascertain the "present value" of the whole 96,223 payments to be made after the decease of the persons whose lives are to be assured, we must find the value of £609 due one year hence, £643 due two years hence, £650 due three years hence, and so on to the last payments. The sum of all these values will be the total value required. Suppose the interest of money to be 3 per cent. per annum. Then (as explained in the article ANNUITIES) the value of 1 to be paid at the end of one year is  $\frac{1}{1.03}$ ; of 1 to be paid

at the end of two years  $\frac{1}{1.03^2}$ ; and so on. Consequently the total value of the supposed assurances will be the sum of the following terms :-

$$\begin{aligned} \text{Value of first year's payments } & \text{£}609 \times \frac{1}{1.03} = \text{£}591.26 \\ \text{,, second ,, ,, } & 643 \times \frac{1}{1.03^2} = 606.09 \\ \text{,, third ,, ,, } & 650 \times \frac{1}{1.03^3} = 594.84 \\ & \text{\&c.} = \text{\&c.} \end{aligned}$$

The sum of all the terms in this series is £31,644. We have thus found that £31,644 is the present value of 96,223

assurances of £1 each on as many lives, of the same age 20, according to the  $H^M$  mortality table, reckoning interest at 3 per cent. It follows that, if all these persons are to contribute at the same rate for their several assurances, the share payable by each—or the single premium for an assurance of £1 on each life—will be £31,644 ÷ 96,223, or £32886. If twice the number of persons were to be assured, there would be just double the number of claims to satisfy at the close of each year, and the contribution payable by each person would remain the same; and so in proportion for any smaller or larger number of persons. We conclude, therefore, that the single premium at age 20 for a whole-term assurance of £1 according to the  $H^M$  mortality table, reckoning interest at 3 per cent., is £32886, or 6s. 7d.

Passing from numerical illustration to general symbols, the process displayed above may be stated as follows. The number of persons living at any given age ( $x$ ) is represented<sup>1</sup> by the symbol  $l_x$ , and the number dying in the next year (that is, between the ages of  $x$  and  $x+1$ ) by  $d_x$ , which is the equivalent of  $l_x - l_{x+1}$ . Hence the number of claims to be made at the end of successive years in respect of  $l_x$  assurances of 1 each, effected at the age of  $x$ , is represented by the series

$$d_x, d_{x+1}, d_{x+2}, \dots, d_{x+z},$$

where  $z$  is the difference between  $x$  and the highest age completed by any of the lives in the mortality table. The sum of all the terms in this series is of course  $l_x$ , since every person living at age  $x$  must die at one time or another within the period embraced in the table. If money made no interest,  $l_x$  would be the present value of all the assurances, and the premium payable by each person would be  $l_x - l_x^*$ , or 1. To allow for the operation of interest, it is necessary to discount the several yearly payments for the periods during which they are respectively deferred. The series representing the present value of all the assurances thus becomes

$$v d_x + v^2 d_{x+1} + v^3 d_{x+2} + \dots + v^{z+1} d_{x+z},$$

where  $v = \frac{1}{1+i}$ ,  $i$  being the interest of 1 for a year. Hence the premium payable by each of the  $l_x$  individuals is

$$\frac{v d_x + v^2 d_{x+1} + v^3 d_{x+2} + \dots + v^{z+1} d_{x+z}}{l_x}$$

which is usually represented by the symbol  $A_x$ .

The same result may be arrived at by a process of reasoning based on the doctrine of probabilities. Since out of  $l_x$  persons alive at the age of  $x$ , and all (as we must suppose) equally exposed to the risk of death,  $d_x$  will die before completing another year of age, the chance that any one in particular of those  $l_x$  persons will die within the first year is as  $d_x$  to  $l_x$ . Similarly the chance of any particular person dying within the second year is as  $d_{x+1}$  to  $l_x$ ; within the third year as  $d_{x+2}$  to  $l_x$ ; and within the  $n$ th year as  $d_{x+n-1}$  to  $l_x$ . In any particular case, therefore, the probabilities of the sum assured becoming payable at the end of the first, second, third,  $n$ th years, are  $\frac{d_x}{l_x}$ ,  $\frac{d_{x+1}}{l_x}$ ,  $\frac{d_{x+2}}{l_x}$ ,  $\frac{d_{x+n-1}}{l_x}$ , respectively; and the present value of the expectation of receiving 1 at the end of any year, as the  $n$ th, is  $v^n \frac{d_{x+n-1}}{l_x}$ . Hence the value of 1 to be paid at the end of the year in which death occurs is the sum of all the terms in the series

$$v \frac{d_x}{l_x} + v^2 \frac{d_{x+1}}{l_x} + v^3 \frac{d_{x+2}}{l_x} + \dots + v^{z+1} \frac{d_{x+z}}{l_x},$$

an expression which is identical with that given above.

Reverting to the previous expression, it will be seen that by Comm multiplying both numerator and denominator by the same quantity  $v^z$  we obtain, without altering the value of the formula,

$$\frac{v^{z+1} d_x + v^{z+2} d_{x+1} + v^{z+3} d_{x+2} + \dots + v^{z+z+1} d_{x+z}}{v^z l_x}$$

In this new expression the denominator is the product known as  $D_x$  in the commutation method (see again the article ANNUITIES); and the successive terms in the numerator are of the general form  $v^{z+1} d_n$ . This latter product is called  $C_x$ ; so that the whole expression may be written

$$\frac{C_x + C_{x+1} + C_{x+2} + \dots + C_{x+z}}{D_x}$$

In a commutation table the sum of  $C_x, C_{x+1}, C_{x+2}, \dots, C_{x+z}$  is placed in a column headed  $M_x$ ; so that the single premium for an assurance payable after the death of a person aged  $x$  is  $\frac{M_x}{D_x}$ .

The single premium for an assurance on the same life, "deferred"

<sup>1</sup> The notation employed in this article is that recommended by the Institute of Actuaries in an appendix to their tables, published in 1872. Of the alternative forms  $l_{x+n}$  and  $l_x^n$ , to express the number living at age  $x+n$ , we prefer the former as being less liable to create confusion when used in connexion with other symbols.



for  $m$  years—that is, to be payable only if death should occur after that period—is  $\frac{M_{x+m}}{D_x}$ ; which is equivalent to

$$\frac{C_{x+m} + C_{x+m+1} + \dots + C_{x+z}}{D_x}$$

and hence to

$$\frac{v^{m+1}d_{x+m} + v^{m+2}d_{x+m+1} + \dots + v^{x+z+1}d_{x+z}}{I_x}$$

By subtraction, the single premium for a “temporary” assurance for  $m$  years on the same life is  $\frac{M_x - M_{x+m}}{D_x}$ , which is equivalent to

$$\frac{C_x + C_{x+1} + \dots + C_{x+m-1}}{D_x}$$

and hence to

$$\frac{vd_x + v^2d_{x+1} + \dots + v^m d_{x+m-1}}{I_x}$$

A column R is sometimes inserted in commutation tables to facilitate calculations relating to “increasing” assurances.  $R_x$  is the sum of the terms  $M_x, M_{x+1}, \dots, M_{x+z}$ ; so that  $\frac{R_x}{D_x}$  is the value

of an assurance the amount of which shall be 1 if the life fails during the first year, 2 if during the second year, 3 if during the third year, and so on.

Formulas in terms of annuity values.

When the value of any immediate annuity, calculated at a given rate of interest, is known, the value of a sum payable one year after the last instalment of the annuity may be readily deduced from it. The value of any deferred payment is the difference between the sum to be ultimately paid and the discount for the period during which it is deferred. Let  $a$  be the value of an annuity of 1 at the rate of interest  $i$ , and let it be required to find the value of 1 due at the end of the year following the last payment of the annuity. The discount of 1 for one year at the rate of interest,  $i$  is  $\frac{i}{1+i} = 1 - v$ ; and the present value of such annual discount (payable in advance) for the whole period covered by the annuity and one year more is  $(1 - v)(1 + a)$ . Hence the value of the deferred payment of 1 is  $1 - (1 - v)(1 + a)$ . Putting  $a_x$  for the value of an annuity on a life aged  $x$ , we have for the present value of a whole-term assurance on a life of that age  $1 - (1 - v)(1 + a_x)$ .

The agreement of this result with those formerly deduced from the numbers dying in each year may be seen by substituting for  $d_x, d_{x+1}, \&c.$ , their equivalents  $(l_x - l_{x+1}), (l_{x+1} - l_{x+2}), \&c.$ , when the foregoing expression

$$\frac{vd_x + v^2d_{x+1} + \dots + v^{z+1}d_{x+z}}{I_x}$$

becomes

$$\begin{aligned} & \frac{v(l_x - l_{x+1}) + v^2(l_{x+1} - l_{x+2}) + \dots + v^{z+1}(l_{x+z} - 0)}{I_x} \\ &= \frac{vl_x + v^2l_{x+1} + \dots + v^{z+1}l_{x+z}}{I_x} \\ & - \frac{vl_{x+1} + v^2l_{x+2} + \dots + v^z l_{x+z}}{I_x} \end{aligned}$$

$= v(1 + a_x) - a_x$ ; as will be seen from the article ANNUITIES. By a simple transposition this expression takes the form  $v - (1 - v)a_x$ ; which in its turn becomes  $1 - (1 - v)(1 + a_x)$ .

Annual premiums.

Assurances, as formerly mentioned, are usually paid for by annual contributions or premiums, continuing either during the whole subsistence of the assurance or during a limited period only. The annual premium for an assurance is deduced as follows. Since the present value of all the annual payments must be equal to the single premium, and since premiums are always payable in advance, we have (putting  $P$  for the annual premium required)  $P(1 + a) = A$ ;

whence  $P = \frac{A}{1 + a}$ . In this expression  $A$  may represent the single

premium for any benefit whatsoever, whether depending on single or joint lives, or on any other description of status; and  $(1 + a)$  may represent the value, in any such case, of an annuity payable in advance during the period over which the payment of premiums is to extend. The annual premium, payable during the whole of life, for a whole-term assurance on a life aged  $x$  is

$$\frac{1 - (1 - v)(1 + a_x)}{1 + a_x} = \frac{1}{1 + a_x} - (1 - v);$$

or

$$\frac{v(1 + a_x) - a_x}{1 + a_x} = v - \frac{a_x}{1 + a_x};$$

or it may be expressed in a variety of other ways by substituting different equivalents of the single premium and the annuity.

When the premium is to be payable for  $m$  years only, its amount is expressed by  $\frac{A}{1 + a_{\overline{m}|i}}$ , where the symbol  $a_{\overline{m}|i}$  represents the

value of a temporary annuity for  $m - 1$  years; and  $1 + a_{\overline{m}|i}$  is therefore the value of an annuity for  $m$  years payable in advance.

When the premium for the first  $m$  years is to be  $\frac{1}{r}$ th of that for the remainder of life, the ultimate annual payment is found by the expression  $\frac{A}{\frac{1}{r}(1 + a_{\overline{m}|i}) + a_{\overline{m-1}|i}}$  where  $a_{\overline{m-1}|i}$  is the value of an

annuity deferred for  $m - 1$  years, and therefore of an annuity deferred for  $m$  years, but payable in advance.

By the commutation method the annual whole-life premium is  $\frac{M_x \cdot N_{x-1}}{D_x \cdot D_x} = \frac{M_x}{N_{x-1}}$ . The premium limited to  $m$  annual payments, for a whole-term assurance, is  $\frac{M_x}{1 - N_{x+m-1}}$ . The premium pay-

able after  $m$  years, when the payment during that period is  $\frac{1}{r}$ th

of the ultimate annual payment, is  $\frac{M_x}{\frac{1}{r}(N_{x-1} - N_{x+m-1}) + N_{x+m-1}}$

$$\text{or } \frac{rM_x}{N_{x-1} + (r-1)N_{x+m-1}}$$

We do not propose to enter further on the investigation of formulae for the calculation of premiums for the various descriptions of life assurances. These will be found in the works of Milne, Baily, Jones, and other authors who have treated of the subject of life contingencies. The student will find a very clear exposition of the nature and modes of calculation of the more ordinary kinds of premiums in a paper by Mr James Meikle, *The Rationale of Life Assurance Premiums*, reprinted by the Actuarial Society of Edinburgh in 1879.

In the practical calculation of life assurance premiums various devices have been suggested for shortening labour and ensuring accuracy. Mr Peter Gray's method of calculation, by means of logarithmic tables on the plan originated by Gauss, may be specially mentioned. His *Tables and Formulae*, in which this method is explained, is a work of great value to the student of life contingencies.

When the requisite annuity values are available, the tables of assurance premiums constructed by Mr William Orchard afford great facilities, either in forming scales of premiums or in isolated calculations. The foregoing expressions for the single premium in terms of the corresponding values of annuities are of such a character as to be applicable to a great variety of cases—to nearly every case, in fact, where the risk of the assurance is to be entered on immediately, and the sum assured is to be payable at the end of the year following the last payment of the annuity embraced in the formulae.

In like manner the formulae for the annual premium,  $\frac{1}{1+a} - (1-v)$ , and its equivalents are applicable in all such cases, but only when the premium is to be payable during the whole continuance of the assurance, so that in the expression  $\frac{1 - (1-v)(1+a)}{1+a}$  the annuity-

value  $a$  in the denominator corresponds with that in the numerator. Mr Orchard has tabulated the values of  $v - (1-v)a$  and  $\frac{1}{1+a} - (1-v)$  for all probable values of  $a$ , and for the several values of  $v$  corresponding to eight different rates of interest. By means of these tables, when the annuity-value corresponding to any required single or annual premium is known, the premium itself may be obtained by mere inspection. The tables may be employed with annuities derived from any table of mortality, and, as the various cases to which they apply are by far the most frequent in practice, they are found extremely useful by computers.

We have throughout supposed that the payment of the sum assured is to be made at the end of the year in which death occurs. This supposition accords with the theory of annual mortality and annual conversion of interest into capital, upon which the usual system of calculation is based. It also agrees very nearly with fact when the sums assured are payable six months after death; for, if it be supposed that the deaths occurring within each year of age take place at equal intervals of time, or that they occur in equal numbers in the first and second halves of each year respectively, the persons insured will, one with another, complete about half a year of age in the year when they die. When it is thought desirable to make allowance, in the calculation of premiums, for the circumstance of the sums assured being payable earlier than at the end of the year of death, that may be done by a simple modification of the usual formulae. For example,  $A(1+i)^{\frac{1}{2}}$  is an approximation sufficiently near for most purposes to the value of an assurance payable as soon as death occurs.

The more scientific methods of calculation developed by Mr Woolhouse and others, and referred to in the article ANNUITIES, elimin-

ate both the hypothesis of payments being due at the end of the year and that of a uniform distribution of each year's deaths, neither of which is strictly admissible. The lives assured, instead of being regarded as subject to successive yearly decrements, are considered to be diminishing in number continuously; and in like manner interest, instead of being payable annually, is supposed to be growing due from moment to moment. The methods referred to afford great facilities for the solution of various problems which can only be solved approximately, or with extreme labour, by the usual modes of computation, but they are not employed in the ordinary calculations of assurance offices.

The premiums obtained by calculation from the fundamental data of interest and mortality are called "net" or "pure" premiums. In calculating the premiums to be charged by an assurance office, it is to be borne in mind that, while fluctuations will undoubtedly occur in the rates of mortality prevailing at different times among the lives assured, and in the rates of interest realized on the invested funds, the terms on which assurances are undertaken are not subject to variation at the will of the office in order to meet such fluctuations. The office must hold itself absolutely responsible for the fulfilment of its part of the contract, but the premiums cannot be increased beyond the amount fixed at the outset. Hence it is obviously necessary that the premiums should be on such a scale as to keep the office safe under all circumstances. Further, the premiums must contain a sufficient provision for the expenses necessarily incurred in carrying on business. Therefore the rates actually charged must be larger than those which would suffice if only a probable death-rate and a probable rate of interest had to be taken into account. In the earliest days of assurance it seems to have been the practice to make an addition for safety to the rates of premium deduced from the fundamental data, and certain payments were required as "entry-money" to help to meet expenses. Afterwards, when experience had shown that the tables of mortality then in use considerably overstated the death-rate likely to be experienced, the addition made to the premiums was removed, but the offices continued to use tables giving high death-rates in combination with a rate of interest well within that which might safely be expected. With the introduction, however, of mortality tables which approached more closely the death rates among assured lives, there revived the practice of making an addition to the "pure" premiums, in order to provide for expenses, for fluctuations in the death-rate, and for other contingencies. This addition is called the "loading" or "margin," and the premiums which include it are called "office premiums," as being those which enter into the contract between the office and the assured.

Few if any of the older assurance offices continue to base their estimates of liability on the tables which were originally employed in the construction of their scales of premium; but many of them still charge the same rates as formerly, or at all events rates which have not been constructed from the tables of mortality now in use. Hence the terms "loading" and "margin" have come to bear a somewhat extended meaning. They are now used to designate the difference between the premiums payable by the assured and the net premiums deduced from any table that may be employed for the time.

There have been various theories as to the proper method of loading premiums. The plan most commonly employed at first was that of adding a constant percentage of the net premiums at all ages. Some actuaries objected to this method, holding it to be inequitable as between old and young lives, and proposed in its stead the addition of an equal sum for every age (that is, in effect, a constant percentage of the sum assured) as more in accordance with the object in view. By others a combination of these two plans was preferred. The premiums were loaded by a percentage for "profit" and contingencies, and a constant

addition was made to cover the expenses of management. More recently other methods have been proposed, and it has been specially insisted on that the "loading" should be adjusted so as to give due weight to the fact that by far the larger proportion of expense is usually connected with the first year's premium; but most of the scales of premiums now in use by assurance offices have been arrived at by one or other of the methods of loading mentioned above.

The rates of the Northampton Table, at 3 per cent. interest, furnish an example of a scale of net rates used as office premiums, without any specific addition by way of "loading." These are shown in the following table. As an example of a scale of office premiums formed by loading with a constant percentage, we give that obtained by adding 25 per cent. to the net rates of the Carlisle table, reckoning interest at 3 per cent. It will be seen that, owing to the lower death-rate shown by that table, the premiums even with the addition mentioned are lower than those of the Northampton Table up to age fifty. After that age the loaded Carlisle premiums are higher than the Northampton pure premiums, but still the Carlisle rates without loading are lower than the Northampton rates. For the sake of further illustration we give the net premiums deduced from the healthy males table (H<sup>m</sup>) of the Institute of Actuaries at the same rate of interest; and in a separate column is shown what percentage of "loading," on a comparison with those premiums, is contained in the Carlisle rates with their 25 per cent. addition. The premiums are those required for the assurance of £100 for the whole term of life.

Age.	Northampton 3 per cent. rates, net.	Carlisle 3 per cent. rates, with 25 per cent. addd.	H <sup>m</sup> 3 per cent. rates, without loading.	Percentage by which col. (3) exceeds col. (4).
(1)	(2)	(3)	(4)	(5)
1	£1 13 7	£1 13 2	£1 4 6	35.27
20	2 3 7	1 17 4	1 8 7	30 61
25	2 8 1	2 2 7	1 12 6	31 03
30	2 13 5	2 8 10	1 17 7	29 93
35	2 19 10	2 15 10	2 3 10	27 38
40	3 7 11	3 5 0	2 11 9	25 60
45	3 17 11	3 15 5	3 2 3	21 15
50	4 10 8	4 10 7	3 16 0	19 10
55	5 6 4	5 13 8	4 14 6	20 28
60	6 7 4	7 4 9	5 19 9	20 83
65	7 16 9	8 19 3	7 14 1	16 33

*Constitution of Offices.*—The nature of life assurance is such as to render impracticable its successful prosecution as a matter of individual or private enterprise. To secure a sufficiently uniform operation of the laws of average, the transactions must be carried out on a scale quite incompatible with the sufficiency of private credit for their fulfilment; while the indefinite and lengthened periods over which the engagements extend also mark them out as beyond the reach of individual responsibility.

Accordingly, with the limited exception of the insurance scheme of the Government, the business in the United Kingdom may be said to be entirely in the hands of public companies or societies. These bodies have been of three kinds—(1) the purely mutual offices, in which the assured themselves constitute the society; (2) proprietary offices, as they once existed, being joint-stock companies which carried on the business of assurance for the benefit of the shareholders, among whom were divided the whole "profits" or "surplus" arising from the contributions of the assured; and (3) the mixed offices, possessed of a share capital, but dividing among their assured a proportion (generally from two-thirds to nine-tenths) of the "profits" realized. In the present day there are but two kinds of offices, mutual and mixed, the proprietary companies either having dis-



appeared or having adopted the plan of sharing profits with the policyholders.

Into the relative merits of the two classes of offices it is not our purpose to enter. The mutual offices take their stand on the advantage to the assured of sharing the whole profits among themselves, while the mixed offices point to certain features of their system which tend to neutralize the apparent disadvantage of the shareholders taking a portion of the surplus. We believe it will be found that the fact of an office belonging to one class or the other does not of itself afford a presumption either for or against its being an advantageous office to assure in. The comparative advantages of different companies must be sought out by a closer scrutiny than a mere reference to this distinction in the nature of their constitution.

Most assurances are effected on the plan of participating in profits. In both mutual and mixed offices, however, there is generally a class of policyholders who do not share in the profits, but who, requiring only a guarantee of a fixed sum on the happening of the contingency mentioned in their policies, effect their assurances at a reduced rate of premium calculated to cover fully the risk and expenses of business.

**Selection of Lives.** *Selection of Lives.*—It is well known that assurance companies exercise a selection among the lives proposed for assurance, admitting some on the ordinary terms and surcharging or rejecting others whose prospects of longevity appear to be below the average. The necessity for this has been sometimes called in question. Why, it has been asked, should the offices inquire so scrupulously into the state of health of those who offer themselves, if the mortality tables on which the premiums are based exhibit the death-rate among a number of persons in all the degrees of health and sickness? The answer is that without such selection on their part the offices could not reckon on the lives assured being as a body equal to those represented in the tables. It must be remembered that the inducement to become assured is not so great to the healthy and vigorous as it is to the weak and delicate, and if the offices were to open their doors to all comers, or were even to relax their vigilance in scrutinizing the applications made to them, they would inevitably admit an undue proportion of the latter class, and thus expose themselves to greater hazards than those provided for in their tables. Moreover, since the assured have a direct interest in the surplus remaining of their premiums, after providing the cost of the assurances, the admission of all lives on equal terms would be an injustice to those possessing a full measure of health. They would practically be called upon to contribute more than their own cases required, in order to provide a fund sufficient to pay the sums assured on lives having inferior prospects of longevity.

**Means of selection.** The means of selection employed by assurance offices are also well known. Each applicant is required to furnish information as to his own health and habits of life, and some particulars as to his family history, and he undergoes an examination by a medical man named by the office. In former days this examination was not always required, nor does it appear that the same attention was paid as now to the question of hereditary tendencies to disease; and yet, judging from the experience of the older offices, the precautions observed in those days seem to have been not without considerable effect. Unquestionably, however, the improvements which growing experience and the advance of medical science have brought to bear upon the means of selection have had an important influence in increasing its efficacy, although possibly they may have done little more than to defend the offices against a greater risk of the introduction of questionable lives. It is now well understood that hereditary tendencies have a

marked effect in determining the chances of longevity of individuals; the degree of importance to be attached to particular deviations from health is better known than formerly; while the increased prevalence of assurance has led to a better appreciation among medical men of the duties required of them in the examination of proposers. In some of the medical schools special attention is now directed to the subject. Several excellent works on medical selection have appeared, one of the most recent in England being that of Dr Sieveking of London.

It may readily be supposed that selection has an important influence in determining the rates of mortality among assured lives. The extent and nature of this influence have formed a very fruitful and interesting subject of inquiry. So early as 1776 an investigation of the affairs of the Equitable Society revealed that the death-rate among the members had been much lower than that anticipated in the tables on which the premiums were based. Similar results appeared at the subsequent investigations of W. Morgan and A. Morgan, who were successively actuaries of the society; and in many other collections of the statistics of individual offices—those by Galloway of the Amicable (1841), Jellicoe of the Eagle (1854), Spens of the Scottish Amicable (1862), for example—the mortality among assured lives has been exhibited in comparison with the death-rates shown by the mortality tables in common use. Comparisons of this kind may be drawn from the tables on a preceding page. These do not, however, afford the means of observing what is a very marked peculiarity of the mortality experience of assurance companies, namely, the varying death-rates at different periods in the duration of assurances. Mr Spens devoted considerable attention to this subject, but it had been previously investigated in connexion with the statistics of the seventeen offices to 1843 already referred to. These statistics were analysed with this object by Mr E. J. Farren, who pointed out the extremely light mortality experienced during the first year of each assurance. A more exhaustive analysis is given by Mr Higham, in a paper "On the Value of Selection as exercised by the Policyholder," contributed to the *Assurance Magazine*<sup>1</sup> (vol. i. p. 179). Mr Higham traces the lives from their first year of assurance down to the time of their passing from observation, by death or otherwise, and shows that the mortality, light at first in consequence of the initial selection exercised by the offices, gradually increases until it becomes greater than that prevailing among the general population. This latter result he attributes to the selection which the assured exercise against the companies by dropping policies on healthy lives and retaining those on lives which have become bad or doubtful. A still more complete investigation of the subject of selection has been made by Mr Sprague (*Assur. Mag.*, xiv. 328), who shows that the deterioration noticed by Mr Higham attains its maximum some time before the lives pass from observation, and is ultimately reversed after the full effect produced by the withdrawal of good lives has exhausted itself. Mr Sprague's statistics are taken from the Twenty Offices' Experience to 1863. In the collection of that experience the effects of the two kinds of selection that have now been referred to—selection by the assurance offices and selection against the offices—were kept in view as a subject to be investigated; and in the preface to the tables published in

<sup>1</sup> The *Assurance Magazine*—or, as it is now called, the *Journal of the Institute of Actuaries*—continues to be, as it has been for many years, the principal medium of publication for what is new and important in actuarial science. Under the auspices of the Institute of Actuaries, a text-book is in preparation which, when completed, will no doubt bring within a convenient compass much that is now scattered throughout the *Journal* and other works. In the meantime the student will find it indispensable to make himself acquainted with many of the valuable papers contained in the *Assurance Magazine*.

1869 the subject is considered at some length, and several interesting tables are devoted to its illustration. The following figures, extracted from one of those tables, show the rates of mortality at different quinquennial periods of life among the "healthy lives, male and female,"—dividing the lives into groups according to the duration of their assurances.

Age.	Annual Mortality per cent. in periods of Assurance.				
	Under five years.	Five years and upwards.	Under ten years.	Ten years and upwards.	Total.
(1)	(2)	(3)	(4)	(5)	(6)
20 to 24	.67	.90	.71	.64	.71
25 " 29	.66	1.00	.73	.92	.73
30 " 34	.76	.97	.83	1.00	.85
35 " 39	.83	1.10	.93	1.17	.97
40 " 44	.91	1.19	1.00	1.28	1.09
45 " 49	1.17	1.44	1.25	1.52	1.36
50 " 54	1.28	1.85	1.52	1.90	1.72
55 " 59	1.81	2.47	2.10	2.52	2.35
60 " 64	2.71	3.50	3.05	3.55	3.38
65 " 69	3.63	5.06	4.35	5.11	4.90
70 " 74	5.51	7.35	6.51	7.40	7.23

A prominent feature of this table is the divergence of the figures in column 3 from those in column 2, and on the other hand the comparatively close agreement of the figures in column 3 with those in column 5. This seems to indicate that among lives which have been less than five years assured the rate of mortality is materially lower than that prevailing among lives of similar ages who have been assured for longer periods, but that after the first five years the causes which bring about this lessening of the rate of mortality have in great measure ceased to operate. It was this peculiarity of the statistics that led to the construction of the  $H^{(5)}$  table,—the first five years of assurance being regarded as marking, although not in any strict or absolute sense, a distinct period in the value of assured life, after which "for all practical purposes the benefit of selection may perhaps be said to be lost." Mr Sprague has since pointed out that this distinction is not altogether satisfactory, and he has sought by the construction of a series of "Select Mortality Tables" for separate ages at entry (*Ass. Mag.* xx. 95 and xxi. 229) to supply a more exact basis of calculation than the  $H^M$  and  $H^{(5)}$  tables afford.

Besides its influence upon the rates of mortality, selection has also a very noticeable effect in regard to the causes of death among the assured. Diseases to which a predisposition may be inferred from family or personal history, or which admit of detection in an early stage by careful medical scrutiny, are less frequent among this selected class of lives than among the general population, while, on the other hand, assured persons seem to be more liable than others to particular forms of disease. This interesting subject is dealt with by Mr Meikle in his *Observations*, formerly referred to; and it is also illustrated in numerous reports on the experience of different assurance companies by their medical officers.

**Valuations.**—The business of life assurance being founded on well-ascertained natural laws, and on principles of finance which in their broad aspect are of the simplest description, there exists no necessity for frequent close scrutiny of the affairs of an assurance office, in so far as the maintenance of a mere standard of solvency is concerned. We have seen that the premiums charged for assurances are based on certain assumptions in regard to (1) the rate of mortality to be experienced, (2) the rate of interest to be earned by the office on its funds, and (3) the proportion of the premiums to be absorbed in expenses and in providing against unforeseen contingencies. If these

assumptions are reasonably safe, an assurance office proceeding upon them may be confidently regarded as solvent so long as there is no conspicuously unfavourable deviation from what has been anticipated and provided for, and so long as the funds are not impaired by imprudent investments or otherwise. The ascertainment and division of profits, however, require that the affairs should be looked into periodically; but the fluctuations to which the surplus funds are liable within limited periods of time, from variations of the death-rate and other causes, are generally regarded as furnishing a sufficient reason why such investigations should not take place too frequently. Accordingly in most offices the division of profits takes place only at stated intervals of years,—usually five or seven years,—when a complete survey is taken of the whole engagements present and future, and of the funds available to meet these. The mode in which the liability of an office under its current policies is estimated requires explanation.

All statistical observations on the duration of human life point to the conclusion that, after the period of extreme youth is past, the death-rate among any given body of persons increases gradually with advancing age. If, therefore, assurance premiums were annually adjusted according to the chances of death corresponding to the current age of the assured, their amount would be at first smaller, but ultimately larger, than the uniform annual payment required to assure a given sum whenever death may occur. This is illustrated by the following figures, calculated from the  $H^M$  mortality table at 3 per cent. interest. In column 2 is the uniform annual premium at age thirty for a whole-term assurance of £100. In column 3 are shown the premiums which would be required at the successive ages stated in column 1 to assure £100 in the event of death taking place within a year. Column 4 shows the differences between the figures in column 2 and those in column 3.

Age, 30+n.	$P_{30}$	${}_{11}A_{30+n}$	$P_{30}-{}_{11}A_{30+n}$
(1)	(2)	(3)	(4)
30	£1.880	£.750	+ £1.130
31	1.880	.769	+ 1.111
32	1.880	.787	+ 1.093
...	...	...	...
...	...	...	...
...	...	...	...
53	1.880	1.806	+ .074
54	1.880	1.916	- .036
55	1.880	2.042	- .162
...	...	...	...
...	...	...	...
95	1.880	61.848	- 59.968
96	1.880	79.265	- 77.385
97	1.880	97.087	- 95.207

From this table it appears that if a number of persons effect, at the age of thirty, whole-term assurances on their lives by annual premiums which are to remain of uniform amount during the subsistence of the assurances, each of them pays for the first year £1.130 more than is required for the risk of that year. The second year the premiums are each £1.111 in excess of that year's risk. The third year the excess is only £1.093, and so it diminishes from year to year. By the time the individuals who survive have reached the age of fifty-four, their uniform annual premiums are no longer sufficient for the risk of the following year; and this annual deficiency goes on increasing until at the extreme age in the table it amounts to £95.207, the difference between the uniform annual premium (£1.880) and the present value (£97.087) of £100 certain to be paid at the end of a year. Now, since the uniform annual premiums are just sufficient to provide for the ultimate

Naçure of reserve values.

Valuation of liabilities.



payment of the sums assured, it is obvious that the deficiencies of later years must be made up by the excess of the earlier payments; and, in order that the assurance office may be in a position to meet its engagements, these surplus payments must be kept in hand and accumulated at interest until they are required for the purpose indicated. It is, in effect, the accumulated excess here spoken of which constitutes the measure of the company's liability under its policies, or the sum which it ought to have in hand to be able to meet its engagements. In the individual case this sum is usually called the "reserve value" of a policy.

In another view the reserve value of a policy is the difference between the present value of the engagement undertaken by the office and the present value of the premiums to be paid in future by the assured. This view may be regarded as the counterpart of the other. For practical purposes it is to be preferred, as it is independent of the variations of past experience, and requires only that a rate of mortality and a rate of interest be assumed for the future.

According to it, the reserve value ( ${}_nV_x$ ) of a policy for the sum of 1, effected at age  $x$ , and which has been in force for  $n$  years—the  $(n+1)$ th premium being just due and unpaid—may be expressed thus, in symbols with which we have already become familiar.

$${}_nV_x = A_{x+n} - P_x(1 + a_{x+n}) \dots \dots (1).$$

If we substitute for  $A_{x+n}$  its equivalent  $P_{x+n}(1 + a_{x+n})$  this expression becomes

$${}_nV_x = (P_{x+n} - P_x)(1 + a_{x+n}) \dots \dots (2);$$

whence we see that the sum to be reserved under a policy after any number of years arises from the difference between the premium actually payable and the premium which would be required to assure the life afresh at the increased age attained. By substituting for  $P_{x+n}$

and  $P_x$  their equivalents  $\frac{1}{1 + a_{x+n}} - (1 - r)$  and  $\frac{1}{1 + a_x} - (1 - r)$ , we

obtain another useful form of the expression,

$$V_x = 1 - \frac{1 + a_{x+n}}{1 + a_x} \dots \dots (3)$$

$$= \frac{a_x - a_{x+n}}{1 + a_x} \dots \dots (4).$$

Net liability.

The preceding formulæ indicate clearly the nature of the calculations by which an assurance office is able to ascertain the amount of funds which ought to be kept in hand to provide for the liabilities to the assured. In cases other than whole-term assurances by uniform annual premiums, the formulæ are subject to appropriate modifications. When there are bonus additions to the sums assured, the value of these must be added, so that by the foregoing formula (1), for example, the value of a policy for 1 with bonus additions B is  $(1 + B)A_{x+n} - P(1 + a_{x+n})$ . But the general principles of calculation are the same in all cases. The present value of the whole sums undertaken to be paid by the office is ascertained on the one hand, and on the other hand the present value of the premiums to be received in future from the assured. The difference between these (due provision being made for expenses and contingencies, as afterwards explained) represents the "net liability" of the office. Otherwise, the net liability is arrived at by calculating separately the value of each policy by an adaptation of one or other of the above formulæ. In either case, an adjustment of the annuity-values is made, in order to adapt these to the actual conditions of a valuation, when the next premiums on the various policies are not actually due, but are to become due at various intervals throughout the succeeding year.

Provision for expenses &c.

So far in regard to the provision for payment of the sums contained in the policies, with their additions. We now come to the provision for future expenses, and for contingencies not embraced in the ordinary calculations. In what is called the "net-premium" method of valuation, this provision is made by throwing off the whole "loading"

in estimating the value of the premiums to be received.

That is to say, the premiums valued, in order to be set off against the value of the sums engaged to be paid by the office, are not the whole premiums actually receivable, but the net or pure premiums derived from the table employed in the valuation. The practical effect of this is that the amount brought out as the net liability of the office is sufficient, together with the net-premium portion of its future receipts from policyholders, to meet the sums assured under its policies as they mature, thus leaving free the remaining portion—the margin or loading—of each year's premium income to meet expenses and any extra demands. When the margin thus left proves more than sufficient for those purposes, as under ordinary circumstances it always ought to do, the excess falls year by year into the surplus funds of the office, to be dealt with as profit at the next periodical investigation.

There appears to be a decided preference among assurance companies for the net-premium method as that which on the whole is best suited for valuing the liabilities of an office transacting a profitable business at a moderate rate of expense, and making investigations with a view to ascertaining the amount of surplus divisible among its constituents. Under certain circumstances it may be advisable to depart from a strict application of the characteristic feature of that method, but it must always be borne in mind that any encroachment made upon the "margin" in valuing the premiums is, so far, an anticipation of future profits. Any such encroachment is indeed inadmissible, unless the margin is at least more than sufficient to provide for future expenses, and in any case care must be taken to guard against what are called "negative values." These arise when the valuation of the future premiums is greater than the valuation of the sums engaged to be paid by the office, or when in the expression  $(P_{x+n} - P_x)(1 + a_{x+n})$  the value of  $P_x$  is increased so as to be greater than that of  $P_{x+n}$ . It is evident that any valuation which includes "negative values" must be misleading, as policies are thereby treated as assets instead of liabilities, and such fictitious assets may at any time be cut off by the assured electing to drop their policies.

Net-premium method.

Negative values.

In recognition of the fact that a large proportion of the first year's premiums is in most offices absorbed by the expense of obtaining new business, it has been proposed by some actuaries to treat the first premium in each case as applicable entirely to the risk and expenses of the first year. At a period of valuation the policies are to be dealt with as if effected a year after their actual date, and at the increased age then attained.

Another modification of the net-premium method has been advocated for valuing policies entitled to bonus additions. It consists in estimating the value of future bonuses (at an assumed rate) in addition to that of the sum assured and existing bonuses, and valuing on the other hand so much of the office premiums as would have been required to provide the sum assured and bonuses at the time of effecting the assurance. This tends to secure, to some extent, the maintenance of a tolerably steady rate of bonus.

An essentially different method is employed by some offices, and is not without the support of actuaries whose judgment is entitled to every respect. It has been called the "hypothetical method." By it the office premiums are made the basis of valuation. Hypothetical annuity-values, smaller than those which would be employed in the net-premium method, are deduced from the office premiums by means of the relation  $P' = \frac{1}{1 + a'} - (1 - r)$ , and the policies are valued according to the formula

$${}_nV'_x = (P'_{x+n} - P'_x)(1 + a'_{x+n}),$$

where  $P'_x$  and  $P'_{x+n}$  are the office premiums at ages  $x$  and

Hypothetical method.

$x+n$  respectively, and  $a'_{x+n}$  is the hypothetical annuity-value at the latter age. Mr Sprague has shown (*Ass. Mag.*, xi. 90) that the policy-values obtained by this method will be greater or less than, or equal to, those of the net-premium method according as the "loading" is a constant percentage of the net premium or an equal addition to it at all ages, or of an intermediate character, its elements being so adjusted as to balance each other.

When the net-premium method is employed, it is important that the office premiums be not altogether left out of view, otherwise an imperfect idea will be formed as to the results of the valuation. Suppose two offices, in circumstances as nearly as possible similar, estimate their liabilities by the net-premium method upon the same data, but office A charges premiums which contain a margin of 20 per cent. above the net premiums, and office B charges premiums with a margin of 30 per cent. Then, in so far as regards their net liabilities (always supposing the sum set aside in each case to be that required by the valuation), the reserves of those offices will be of equal strength, and if nothing further were taken into account they might be supposed to stand in the same financial position. But it is obvious that office B, which has a margin of income 50 per cent. greater than that of office A, is so much better able to bear any unusual strain in addition to the ordinary expenditure, and is likely to realize a larger surplus on its transactions. Hence it appears that in order to obtain an adequate view of the financial position of any office it is necessary to consider, not only the basis upon which its reserves are calculated, but also the proportion of "loading" or "margin" contained in its premiums, and set aside for future expenses and profits.

Valuations may be made on different data as to mortality and interest, and the resulting net liability will be greater or less according to the nature of these. Under any given table of mortality a valuation at a low rate of interest will produce a larger net liability—will require, that is to say, a higher reserve to be made by the office against its future engagements to the assured—than a valuation at a higher rate. The effect of different assumptions in regard to the rates of mortality cannot be expressed in similar terms. A table of mortality showing a high death-rate, and requiring, consequently, large assurance premiums, does not necessarily produce large reserve values. The contrary indeed may be the case, as with the Northampton Table, which requires larger premiums than the more modern tables, but gives on the whole smaller reserve values. The amount of the net liability depends, not on the absolute magnitude of the rates of mortality indicated by the table, but on the ratio in which these increase from age to age.

If the values deduced by the net-premium method from any two tables be compared, it will be seen that

$$V'_x >, = \text{ or } < {}_x V_x$$

according as

$$1 - \frac{1+a'_{x+n}}{1+a'_x} >, =, \text{ or } < 1 - \frac{1+a_{x+n}}{1+a_x}$$

i.e., as

$$\frac{1+a'_{x+n}}{1+a'_x} >, =, \text{ or } < \frac{1+a_{x+n}}{1+a_x} \dots \dots (1),$$

or as

$$\frac{1+a'_x}{1+a_x} >, =, \text{ or } < \frac{1+a'_{x+n}}{1+a_{x+n}} \dots \dots (2);$$

where the accented symbols throughout refer to one table and the unaccented symbols to the other.

We have thus the means of ascertaining whether the policy-values of any table will be greater or less than, or equal to, those of another, either (1) by calculating for each table separately the ratios of the annuity-values at successive ages, and comparing the results, or (2) by calculating at successive ages the ratios of the annuity-values

of one table to those of another, and observing whether these ratios decrease or increase with advancing age, or remain stationary throughout. The above relations will subsist whatever may be the differences in the data employed, and whether or not the annuity-values by the different tables are calculated at the same rate of interest. When the same rate of interest is employed, any divergence in the ratios of the annuity-values will of necessity be due to differences in the rates of mortality. This interesting subject is investigated by Mr Meikle in a paper on *Policy Life-Lines*, one of the Actuarial Society's publications, and by Mr Sprague in the *Assurance Magazine*, vol. xxi. p. 77.

The following table gives examples of the reserve values of policies for £100, calculated on the net-premium method by three different mortality tables, at a uniform rate of interest, 3 per cent.

Age at Entry.	Northampton.	Carlisle.	Institute of Actuaries H <sup>M</sup> .
<i>Duration of policy five years.</i>			
20	£4.196	£4.534	£4.360
30	5.490	5.464	6.135
40	7.294	7.053	8.708
50	9.571	12.374	12.100
60	13.668	13.698	16.180
<i>Duration of policy ten years.</i>			
20	8.738	9.422	9.440
30	11.572	11.746	12.897
40	15.220	15.655	18.045
50	19.790	24.904	24.573
60	28.236	29.310	31.857
<i>Duration of policy twenty years.</i>			
20	19.299	20.061	21.119
30	25.031	25.562	28.614
40	31.998	36.660	33.183
50	42.438	46.914	48.601
60	55.637	53.315	57.792

Table reserve values.

Something may be said here as to the data on which assurance companies make their valuations. The rates of interest assumed by different offices may be said to range between 3 and 4 per cent., being in most cases lower than 4. It is, however, in regard to the tables of mortality that the greatest diversity exists. The Northampton Table has, for valuation purposes, been all but discarded. The Carlisle Table has so far lost its ground, since the introduction of the more recent Experience Tables, as to be now used by only a minority of the offices as the chief basis of their calculations. The different tables based on the experience of the Equitable Society, the Seventeen Offices' Experience, and the English Life Tables have still some adherents, and (besides those offices which value by the "hypothetical method") a few companies employ tables constructed specially for their own use. But there is an evident tendency towards the general adoption of the Institute of Actuaries (twenty offices) Tables, which have been used by a large proportion of the companies in their latest valuations. Of these, the tables chiefly employed are H<sup>M</sup> and H<sup>M(6)</sup>, the latter being used by some offices in combination with the H<sup>M</sup> pure premiums, in order to eliminate as far as possible the effects of selection. Mr King (*Ass. Mag.*, xix. 381 and xx. 233) and Mr Sprague (*Ass. Mag.*, xxi. 229 and xxii. 391) have shown the construction of tables which would give in a more direct and scientific way the result that is aimed at by using the combined H<sup>M</sup> and H<sup>M(6)</sup> tables. Mr King, to illustrate the results of his method, constructs a "model office," assuming a uniform annual influx of new business and a rate of discontinuance of policies based on the experience

Data employed by offices.



of the twenty offices which contributed their statistics to the formation of the Institute of Actuaries Tables, and he shows the comparative reserve required by such an office at the end of successive quinquennial periods, according to various mortality tables and at different rates of interest. As these illustrative tables afford an admirable means of comparing the results of valuing by different mortality tables, we give the following extracts. It must be borne in mind, however, in seeking to apply the figures in these tables to estimate the strength of the reserves maintained by particular offices, that the soundness of the estimate may be a good deal affected by circumstances. In particular the rates at which new business has come in and policies have been discontinued must be taken into account, and, as before stated, the amount of "margin" contained in the premiums must not be lost sight of. Moreover, the supposed liabilities do not include bonus additions, and the presence of these will of course modify any conclusions drawn from the tables.

Table of Mortality and Rate of Interest.	Comparative Reserve, 1000 being assumed for the Reserve by the combined H <sup>M</sup> and H <sup>M(2)</sup> Tables at 3½ per cent. Interest.					
	Age of Office.					
	Ten years.	Twenty years.	Thirty years.	Forty years.	Fifty years.	
Per cent.						
Analysed mortality (Mr King).....	3	1124	1070	1050	1039	1035
Do. do. ....	3½	1061	1014	999	993	991
Do. do. ....	4	1002	961	952	950	951
Combined H <sup>M</sup> and H <sup>M(2)</sup> .....	3	1067	1059	1052	1047	1044
Do. do. ....	3½	1000	1000	1000	1000	1000
Do. do. ....	4	938	945	951	955	958
H <sup>M</sup> .....	3	1068	1016	1023	1024	1024
Do. ....	3½	941	958	971	977	980
Do. ....	4	881	904	922	933	938
Seventeen Offices ...	3	994	1009	1017	1019	1018
Do. do. ....	3½	929	951	965	972	974
Do. do. ....	4	870	898	917	928	933
Davies's Equitable..	3	909	917	923	927	931
Do. do. ....	3½	845	862	874	882	888
Do. do. ....	4	793	811	827	839	847
Carlisle .....	3	924	938	952	959	962
Do. ....	3½	861	881	901	912	918
Do. ....	4	803	829	853	868	876
English, No. 3.....	3	978	988	995	997	997
Do. do. ....	3½	916	933	945	952	954
Do. do. ....	4	858	881	898	909	914
Northampton .....	3	866	877	887	895	901
American .....	4	837	872	898	914	923

**Division of Surplus.**—There are various sources from which a surplus of funds may arise in an assurance company:—(1) from the rate of interest actually earned being higher than that anticipated in the calculations; (2) from the death-rate among the assured being lower than that provided for by the mortality tables; (3) from the expenses and contingent outlay being less than the "loading" provided to meet them; and (4) from miscellaneous sources, such as profitable investments, the cancelment of policies, &c.

Supposing a valuation to have been made on sound data and by a proper method, and to have resulted in showing that the funds in hand exceed the liabilities, the surplus thus ascertained may be regarded as *profit*, and either its amount may be withdrawn from the assets of the office or the liabilities may be increased in a corresponding degree.

**Reasons.** Various methods are employed by assurance companies in distributing their surplus funds among the assured. In some offices the share or "bonus" falling to each policyholder is paid to him in cash; in others it is applied in providing a reversionary sum which is added to the amount assured by the policy; in others it goes to reduce

the annual contributions payable by the policyholder. A method of more recent introduction is to apply the earlier bonuses on a policy to limit the term for which premiums may be payable, thus relieving the policyholder of his annual payments after a certain period. Another method is to apply the bonuses towards making the sum assured payable in the lifetime of the policyholder. The plan of reversionary bonus additions is most common, and when it is followed the option is usually given of exchanging the bonuses for their value in cash or of having them applied in the reduction of premiums.

Not only are there different modes of applying surplus, but the basis on which it is divided among the assured also varies in different offices. In some the reversionary bonus is calculated as an equal percentage per annum of the sum assured, reckoning back either to the commencement of the policy in every case, or (more commonly) to the preceding division of profits. In others the rate is calculated, not only on the original sums assured, but also on previous bonus additions. In others the ratio of distribution is applied to the cash surplus, and the share allotted to each policy is dealt with in one or other of the ways above indicated. The following are some of the ratios employed by different offices in the allocation of profits:—(1) in proportion to the amount of premiums paid (with or without accumulated interest) since the last preceding valuation; (2) in proportion to the accumulated "loading" of the premiums so paid; (3) in proportion to the reserve values of the policies; (4) in proportion to the difference between the accumulated premiums and the reserve value of the policy in each case.

Some offices have a special system of dealing with surplus, reserving it for those policyholders who survive the ordinary "expectation of life," or whose premiums paid, with accumulated interest, amount to the sums assured by their policies. This system is usually connected with specially low rates of premium.

The various bonus systems which have been mentioned yield different results to policyholders of different ages, and whose assurances have been in force for longer or shorter periods. A person seeking to effect an assurance may exercise a wise discretion in selecting that office whose bonus system appears most advantageous, considering his own age and circumstances.

From a paper by Mr A. Hewat in the *Assurance Magazine* (xxii. 286) it appears that the average amount of surplus annually divided among the assured by seventy-seven offices which have rendered valuation accounts to the Board of Trade since the passing of the "Life Assurance Companies Act, 1870" has been £2,285,000, or 23 per cent. of the annual premium income of the offices. The following average specimens of reversionary bonuses are taken from the returns of forty-one of those offices, whose average rate of annual premium is shown in the second column.

Age at Entry.	Average Premium.	Average Specimens of Reversionary Bonuses, per cent. per annum.				
		Years in Force.				
		5	10	15	20	25
20	£ s. d.	£ s. d.	£ s. d.	£ s. d.	£ s. d.	£ s. d.
30	1 18 11	1 2 7	1 3 0	1 3 4	1 3 11	1 4 5
40	2 9 2	1 3 7	1 4 1	1 4 6	1 5 3	1 6 3
50	3 4 8	1 5 1	1 5 8	1 6 7	1 8 2	1 10 10
	4 9 9	1 7 8	1 9 3	1 11 10	1 15 1	2 0 5

**Surrender Values.**—In those branches of insurance where the contract is one of indemnity against loss, the risk remaining the same from year to year—and where the consent of both parties, insurer and insured, is required at each periodical renewal—no question of allowance in respect

of past payments can arise when one party or the other determines to drop the contract. It is quite recognized that the premiums are simply an equivalent for the risk undertaken during the period to which they apply, with a certain margin for expenses and for profit to the insurer, and that therefore a favorable issue of the particular contract supplies no argument for a return of any part of the sums paid. In life assurance, however, we have shown that the premiums contain a third element, namely, the portion that is set aside and accumulated to meet the risk of the assurance when the premium payable is no longer sufficient of itself for that purpose.

When a policyholder withdraws from his contract with a life assurance office, the provision made for the future in respect of his particular assurance is no longer required, and out of it a surrender value may be allowed him for giving up his right to the policy. If there were no reasons to the contrary, the office might hand over the whole of this provision, which, as we have seen, is in fact the reserve value of the policy. No more could be given without encroaching upon the provision necessary for the remaining policies. But the policyholder in withdrawing is exercising a power which circumstances give to him only and not to the other party in the contract. The office is bound by the policy so long as the premiums are duly paid and the other conditions of assurance are not infringed. It has no opportunity of reviewing its position and withdrawing from the bargain should that appear likely to be a losing one. The policyholder, on the other hand, is free to continue or to drop the assurance as he pleases, and it may fairly be presumed that he will take whichever course will best serve his own interest. If he is in failing health he is the more likely to make an effort to keep the assurance on foot; if he has also fallen into adverse circumstances, his friends may aid him to maintain his policy for the benefit of those dependent on him, or he may dispose of it to some one who, knowing the circumstances, may be willing to give a high price for it, speculating on the chance of its becoming an early claim. All these things do happen, and the tendency obviously is that policies on deteriorated and unhealthy lives are kept in force, while those on lives having good prospects of longevity are more readily given up. Again, the retiring policyholder, by withdrawing his annual contribution, not only diminishes the fund from which expenses are met, but lessens the area over which these are spread, and so increases the burden for those who remain. Considerations like these point to the conclusion that, in fairness to the remaining constituents of the office, the surrender value to be allowed for a policy which is to be given up should be less than the reserve value. The common practice is to allow a proportion only of the reserve value. Some offices have adopted the plan of allowing a specified proportion of the amount of premiums paid. This plan is not defended on any ground of principle, but is followed for its simplicity and as a concession to a popular demand for fixed surrender values.

Another mode of securing to retiring policyholders the benefit of the reserve values of their assurances is that known as the *non-forfeiture system*. This system was first introduced in America, whence it found its way to the United Kingdom, where it was gradually adopted by a large proportion of the assurance companies. In its original form it was known as the "ten years non-forfeiture plan." The policies were effected by premiums payable during ten years only, the rates being of course correspondingly high. If during those ten years the policyholder wished to discontinue his payments, he was entitled to a free "paid-up policy" for as many tenths parts of the original sum assured as he had paid premiums. The system, once introduced was gradually extended first

to assurances effected by premiums payable during longer fixed periods, and ultimately, by some offices, to assurances bearing annual premiums during the whole of life. The methods of fixing the amount of paid-up policy in the last-mentioned class of cases vary in different offices, but the principle underlying them all is that of applying the reserve value to the purchase of a new assurance of reduced amount.

*Conditions of Assurance.*—An office, in entering on a Dis-closure of facts. contract of life assurance, does so in the faith that all circumstances material to be known in order to a proper estimate of the risk have been disclosed. These circumstances are beyond its own knowledge, and as the office for the most part (except as regards the result of the medical examination, which may reveal features of the case unknown to the proposer himself) is dependent on the information furnished by the party seeking to effect the assurance, it is proper that the latter be made responsible for the correctness of such information. Accordingly it is made a stipulation, preliminary to the issue of every policy, that all the required information bearing upon the risk shall have been truly and fairly stated, and that in case of any misrepresentation, or any concealment of material facts, the assurance shall be forfeited. In practice, however, this forfeiture is rarely insisted on unless there has been an evident intention to deceive. The other usual conditions of life assurance policies may be shortly noticed.

1. *As to Payment of Premiums.*—A certain period of grace is allowed, most commonly thirty days, after each premium falls due. If payment is not made within that time, the presumption is that the policyholder intends to drop the contract, and the risk of the office comes to an end. It may, however, be revived on certain conditions, usually the production of evidence of health and payment of a fine in addition to the premium. An impression used to prevail among the public that the offices were interested in encouraging the forfeiture of policies. If any such impression was ever shared by the offices themselves it must have long since passed away, as it will be found that every reasonable effort is now made on their part, not only to secure assurances but to retain them, and to afford all the facilities that can be extended to policyholders with that object.

2. *As to Foreign Travel and Residence, and as to Hazardous Occupations.*—When Mr Babbage wrote his *Comparative View of Assurance Limits* in 1826, voyaging abroad was scarcely permitted under a life policy. The Elbe and the Garonne, Texel and Havre, Texel and Brest, the Elbe and Brest, were the limits prescribed by most of the English offices. Even at a much later period the extra premiums charged for leave to travel or reside abroad were very heavy. But improved means of conveyance—in some places better sanitary appliances, and habits of living more suited to the climatic conditions—and, more than all perhaps, the knowledge that has been gained by experience as to the extent of the extra risks involved and the relative salubrity of foreign climates—have enabled the offices to modify their terms very considerably. The limits of free residence and travel have been greatly widened, and where extra premiums are still required these are, as a rule, much lower than formerly. The assured are now commonly permitted to reside anywhere within such limits as north of 35° N. lat. (except in Asia) or south of 30° S. lat., and to travel to and from any places within those limits, without extra premium.

Military men (when on active service) and seafaring men are of course charged extra rates, as are also persons following specially dangerous or unhealthy occupations at home.

3. *As to Suicide.*—The policies of most companies contain a proviso that the assurance shall be void in case the person whose life is assured dies by his own hand. This proviso is analogous to that which renders void a fire policy if the insured becomes guilty of arson, or a policy of marine insurance if the vessel is wrecked intentionally by the owner. The event contemplated in the policy being brought about by the voluntary act of the assured, and not in the natural course of events, is a contingency not included in the scheme of insurance. In the case of life policies the general rule of law appears to be (see *The Law of Life Assurance*, by C. J. Bunyon) that the contract will be avoided unless the suicide takes place when the assured is insane and not accountable for his acts. Sometimes the proviso "whether insane or not" is inserted in policies. In the case of policies *bona fide* assigned, or otherwise held by a third party for an onerous cause, it is usual to exempt the assurance from forfeiture to the extent of the interest of such third party. The practice of assurance offices, however, in regard to



suicides, is more liberal than a strict application of legal principle, or of the conditions attached to life policies, would require. A few offices have abolished the suicide clause from their policies. A number of others, acting, we think, on a sounder principle, now limit its operation to a fixed period, the extent of which varies in different offices from six months to seven years from the date of issue of the policy. In cases happening within these periods, or when there is no express exemption from forfeiture, offices are usually ready to grant any relief which circumstances may seem to warrant, such as an allowance of the surrender value or a return of the premiums paid under the policy.

Indisputable policies.

The practice of rendering policies *indisputable* and free from restriction as to foreign travel or residence, after a certain period, has tended greatly to simplify the contract between the office and the assured, by setting at rest many points on which difficulty might arise. A declaration of indisputability covers any inaccuracies in the original documents on which a policy was granted, unless these inaccuracies amount to fraud, which the law will not condone under any circumstances.

Beginnings of life assurance.

*History.*—It does not appear that the principles of insurance were applied in any definite form to transactions depending on human life until about the 16th century. At that time, and for long afterwards in England, the private underwriters who carried on the business of insurance sometimes undertook risks upon lives for short periods, to cover contingencies of a temporary character. The premiums were very high, but this was in part necessary for two reasons—first, the insurers had no sufficient data upon which to estimate the risk they incurred; and secondly, the transactions were probably not numerous enough to secure anything like a regular average in the occurrence of claims. About the end of the 17th century several “annuity” schemes were formed, notably that of the Mercers Company of London, for the benefit of the widows and orphans of subscribers. These schemes, however, and numerous others of similar character promoted in the succeeding century, failed for lack of correct data and sufficient knowledge of the principles which should have guided their operations. But the idea of uniting the contributions of a number of persons in order to make a provision available on the death of each had taken some hold on the public mind. Its first practical embodiment in the direction of life assurance, but still far short of that system as it is now understood, was the foundation in 1706 by royal charter of “The Amicable Society for a perpetual Assurance Office.” The scheme was simply to raise a fixed contribution from each member, and from the proceeds to distribute a certain sum each year among the representatives of those who died during the year. No one was to be admitted under the age of twelve nor above fifty-five (afterwards altered to forty-five), but all were to pay the same rate of contribution. In 1731 the society made arrangements for guaranteeing that the dividend for each deceased member should not be less than £100. This was the first approach to an “assurance” of a definite sum at death, *whenever that might occur*. The minimum dividend was afterwards increased, but still the society adhered to the plan of rating all members alike, irrespective of age. It was not until 1807 that the Amicable, under a fresh charter, began the practice of rating new members “according to the age and other circumstances.” But that essential step in the development of assurance had been taken long before in another quarter. The theory of life contingencies had made considerable progress, chiefly through the labours of Halley, De Moivre, Simpson, De Parcieux, and Dodson, when in 1756 was projected “The Society for Equitable Assurances on Lives and Survivorships.” Mr Dodson, wishing to have his life assured, found himself excluded from the Amicable on account of his being more than forty-five years old. This led him to the determination “to form a new society upon a plan of assurance on more equitable terms than those of the Amicable, which takes the same premium for all ages,”

The Amicable Society.

The Equitable Society.

and he secured the support of various persons who were willing to join him if the intended society could be established by charter. He did not live to see his purpose accomplished. The petition for a charter of incorporation was presented in 1757, and after a delay of four years it was finally refused, whereupon a remnant of the original subscribers set about constituting the society under a deed of settlement, and business was commenced in 1762. The Equitable possessed from the outset all the essential features of a life assurance office. It was to issue policies for the assurance of fixed sums on single or joint lives, or on survivorships, and for any term. Premiums were to be regulated according to age. Lives were to be admitted with due regard to their state of health and other circumstances. Provision was made for the investment and accumulation of the funds, and also (although imperfectly) for the disposal of any surplus that might arise. As may be supposed, the original scheme was defective in many points of detail, but under the teachings of experience there was soon initiated that course of improvement in the system of assurance which has continued to the present day.

More than forty years before the foundation of the Equitable, charters of incorporation had been granted to two companies which have ever since held an honourable position among assurance institutions, the Royal Exchange and the London Assurance. These included life assurance in their schemes, but appear to have at first transacted it only to a limited extent and in the form of temporary risks such as were taken by the private underwriters.

Other early offices.

Before the close of last century the labours of Price and Morgan had developed in an important degree the theory of life contingencies; the Northampton Table had supplied what was then esteemed a sound basis for such calculations; and the career of the Equitable Society had demonstrated the practicability of conducting life assurance business on a large scale. Within the period mentioned other four life offices were established, one of which, the Pelican, founded in 1797, is now in existence. The present century thus commenced with eight offices transacting in a more or less complete form, the business of life assurance in Great Britain and Ireland. But the success which attended those older societies, particularly the Equitable, soon led to the formation of other offices, and as these increased in number and activity public attention became more and more attracted to assurance, both as a means of employing capital and as an advantageous form of co-operation for mutual benefit.

Up to the year 1844 over one hundred and forty Joint-Stock Companies had been established on a more or less solid footing for the purpose of transacting life business, either alone or in connexion with other forms of insurance, and of these offices upwards of one hundred remained in existence. But abuses had taken place in connexion with all kinds of joint-stock enterprises, and this led to a parliamentary inquiry which resulted in the Joint-Stock Companies Act of 1844. This Act provided specially for the regulation of insurance companies, and among other things imposed upon them the duty of giving in annual statements of their affairs to be placed upon public record. Not many years passed, however, before the attention of parliament was again called to life assurance in consequence of the exposure of certain unwise and fraudulent schemes. A select committee was appointed to make inquiries and they reported to the House in 1853, having examined several public officials and many leading actuaries of the day. They found that the law as it then stood was very defective, that it did not afford the security which was contemplated by the Act of 1844, and that the provisions of that Act had been very imperfectly carried

Joint-Stock Companies Act, 1844

Select committee, 1853.

out. In particular the financial returns had not been satisfactorily made. No special form of accounts had been prescribed by the Act, nor was there even any authority provided by it to compel the returns to be made. As a matter of fact, the Act had been followed by the promotion of a large number of bubble insurance schemes of various kinds.

The committee had very fully before them the whole question as to the policy of Government interference in matters relating to life assurance. Their conclusion was that assurance differed so much from ordinary business as to call for separate and special legislation; and in that view they made certain recommendations—(1) as to precautions to be taken in regard to the formation of new associations, and (2) as to requiring the publication of valuation returns and accounts giving information on specified particulars. Assurance companies were excepted from the next Government bill relating to joint-stock companies, but nothing was done in the shape of legislation, such as that proposed by the committee, until the passing of the Life Assurance Companies Act, 1870, in the framing of which the assurance companies took a considerable share.

This Act requires a deposit of £20,000 to be made in the Court of Chancery by every new company proposing to transact life assurance business; requires (in the case of companies transacting other kinds of business) the receipts under assurance and annuity contracts to be kept separate from other receipts, in order to form a security for the policyholders and annuitants; prescribes forms for annual accounts and for periodical valuation reports and statements, to be rendered to the Board of Trade and to be annually laid before parliament; forbids the transfer or amalgamation of companies without judicial authority, which is not to be given until the policyholders concerned have been fully informed as to the nature and terms of the arrangement, nor if policyholders representing one-tenth or more of the total sums assured dissent; and provides for the winding-up of any company (1) in case of default in complying with the requirements of the Act, or (2) on its being proved to the satisfaction of the court, in view of the contingent or prospective liabilities, that the company is insolvent. In the latter case the court may, if it thinks fit, reduce the amount of the contracts of the company in place of making a winding-up order.

It will be seen that the principle upon which the Act proceeds, in so far as it regulates the management of existing offices, is to require full particulars to be furnished as to their financial condition, and to leave all concerned to form their own judgment upon these. The Government attempts no supervision of the companies further than to see that they comply with the requirements of the Act. But the very publicity now given to their affairs exercises a most wholesome influence, wherever that is needed, on institutions which are peculiarly dependent for their success on the estimation in which they are held by the public. It cannot be pretended that the material furnished by the returns under the Act for forming an estimate of the condition of offices is such as to be wholly intelligible to the mass of those interested in it. Nor was this to be expected. The principles of life assurance, which we have endeavoured in some measure to explain in the present article, are such as to require considerable study, and even special training, for their full appreciation. But the material required by the Act is there, to be interpreted by those who have made themselves familiar with its import and bearing, and the public have themselves to blame in great measure if they remain in ignorance as to the real condition of any offices in which they may be interested. The provisions of the Act in regard to amalgamations and to the formation of new companies have also had their

effect. It is now no longer practicable to commence a life assurance company without a substantial guarantee for the good faith of those engaged in it; and the possibility of ruinous amalgamations, such as those which aided so materially in bringing about the collapse of the famous Albert and Enropean offices, may be regarded as a thing of the past. Unfortunately the provisions of the Act in regard to winding-up have more than once been brought into requisition, but it is safe to say that since it came into effect no one who had sought competent advice need have been involved in loss by joining any of the offices which have thus passed under its operation.

On the whole, the Life Assurance Companies Act of 1870, although not without its defects, may be regarded as in many respects a satisfactory measure. In some unimportant particulars it has been amended by two subsequent Acts in 1871 and 1872.

The year 1870 witnessed the passing of another Act which has an important bearing on life assurance. Under clause 10 of the Married Women's Property Act, 1870, assurances may be effected by married women on their own lives or the lives of their husbands, for their separate use, and by married men on their own lives for the benefit of wife, or wife and children, free from the claims of creditors. In 1880 the Scottish life offices prepared a short bill containing similar provisions in regard to assurances, but with certain improvements on the English Act, and it was passed into law as the Married Women's Policies of Assurance (Scotland) Act, 1880.

The Blue-Books containing the returns made under the Life Assurance Companies Act afford a vast amount of information as to the financial condition of British life offices. From an abstract in Mr White's *Insurance Register* for 1881 we gather the following particulars in regard to one hundred and seven companies which furnished returns during the year 1880. The premiums received in one year by those companies amounted to £13,174,848, and the interest and dividends on investments to £5,342,988. The sums paid in claims during the same period were £11,149,730; for surrenders of policies £720,406; and as cash bonus or in reduction of premiums £763,704. The total amount of funds held by the companies (including, however, £6,151,479 of fire insurance funds) was £143,813,793. Of this sum £120,131,541 represented the life assurance and annuity funds. The amount of paid-up share capital embarked in these enterprises was £10,961,744, in addition to which (but also included in the above sum of £143,813,793) there were reserve and other funds amounting to £6,569,029. These statistics include the business of "industrial assurance," transacted by a few offices—a system by which small sums are secured on the lives of persons in the humbler ranks of life by the payment of weekly or monthly contributions. The premium income from this source was upwards of £1,600,000; the claims reached fully £600,000; and the funds in hand in connexion with this description of business amounted to upwards of £1,100,000.

The Act does not require an annual statement of the existing business of assurance companies, nor does it render compulsory the publication of the amount of new assurances annually effected with them; and, as the companies do not all give those details in their published reports, it is impossible to state with accuracy the amount of assurance business transacted by the British offices. Of the 107 companies whose accounts are summarized above, 63 reported in the year 1880 new assurances amounting to £22,551,626, including however, in many cases, sums reassured with other offices. It is roughly estimated that the total assurances in force with all the companies amounted in 1880 to £420,000,000.



Government life insurance

Besides the business transacted by British assurance companies there is a scheme of Government life insurance authorized by the Act 27 & 28 Vict. cap. 43, and worked in connexion with the Post-Office. By a recent parliamentary return it appears that from the commencement of the scheme in 1864 to 31st December 1878 there had been issued 5844 policies insuring in all £460,000, and there had been paid on the death of nominees about £25,000.

American assurance.

In the United States of America, life assurance has attained a greater relative importance among financial institutions than in any other country. Its history there extends back to an early period, but the system has received its main development in comparatively recent times. During the years which immediately followed the close of the civil war it grew with unparalleled rapidity. The social disorders of the period excited anxiety for the future, and directed earnest attention to institutions which promised exceptional security. The general Government, by its financial administration, and especially by its issues of paper money, furnished a powerful stimulus to the speculative tendency in this as in every branch of business. New companies were established in great numbers; new plans and features of assurance contracts were devised; thousands of energetic agents canvassed the community with their solicitations; and the published reports of the assurance companies reflected, in a high degree, the fictitious prosperity of the period of inflation. The financial crisis of 1873 applied to the companies a test of great severity. The mushroom institutions of recent growth fell rapidly; and, while the standard societies, which were administered with wise conservatism, and which had always held the greater part of the business, were unshaken, their growth was seriously checked.

The following figures (for which we are indebted to the *Insurance Year Book*, Chicago, 1880) give in outline the history of this period. They represent the aggregate business of the companies reporting to the New York insurance department. The figures for 1879 include "industrial assurance," a branch of business but recently developed in America.

Number of Companies.	Year ending Dec. 31.	Policies issued during Year.		Policies in force at end of Year.	
		Number.	Amount of Assurance.	Number.	Amount of Assurance.
27	1864	59,198	\$155,803,597	146,729	\$395,703,058
43	1867	158,605	\$471,611,744	401,140	\$1,161,729,776
71	1870	237,180	\$587,863,236	747,807	\$2,023,884,955
56	1873	199,050	\$465,614,001	817,081	\$2,086,027,178
33	1876	99,036	\$232,665,489	706,179	\$1,735,995,190
34	1879	112,025	\$168,633,035	653,905	\$1,457,255,513

From 1873 to 1879 the number of companies and the aggregate amount at risk steadily decreased. Since then, although no new companies have been organized, there have been no failures, and a healthy and natural increase has been observed in the business of the existing offices. The following table shows the aggregates of the principal items in the business of the forty-two most important companies in the United States for the years 1879 and 1880, as compiled by the *New York Spectator*:-

	1879.	1880.
Total assets, December 31	\$414,271,442	\$442,055,862
liabilities (including reserve)	359,684,927	361,432,788
Premiums received during the year	59,753,970	54,939,987
Total income	79,437,280	79,216,202
Death claims paid	20,665,045	22,227,107
Endowment claims	9,646,598	8,462,768
Paid for purchased and surrendered assurance	18,815,491	19,247,024
dividends to policy holders	12,476,639	13,993,592
Total disbursements during the year	71,433,351	62,028,066
Assurances written	177,891,719	184,166,890
Total assurances in force, December 31	1,515,375,042	1,554,093,611

A subject of special interest in connexion with life insurance in America is the legislation by which it is regulated. While the national Government, under the constitution of the United States, has supreme control over all commerce between the States, the courts hold that insurance in its various forms is not commerce, and that corporations created by a State have no corporate powers beyond the limits of that State, and can transact no business beyond those limits, except on sufferance of the local Government. Hence the life assurance companies are the creatures of State law, and are controlled by the legislatures of the States in which they operate. The first systematic attempt to regulate the business by Government supervision was made by the State of Massachusetts under a statute passed in 1858 establishing an "insurance department." New York adopted a similar law in 1859, and the example has since been followed in nearly all the States, even in those which have no important assurance companies of their own. Each State has its own peculiar laws, and these undergo frequent changes in detail as successive legislatures attempt to improve or to reform the business, but the general character of the supervision exercised is the same in the different States, and is as follows. A company may be organized at any time for the business of assuring lives and granting annuities, by obtaining from the proper officers of the State the approval of its name and fundamental law or charter, and by depositing with the insurance department a stated sum, usually \$100,000, in prescribed securities, as a guaranty of good faith. Since no charters are now granted except under this general law, it is no longer possible to establish a company except by the deposit of a considerable sum in advance,—so that purely mutual companies cannot now be founded; but it is customary to limit the amount of profit upon the capital to a reasonable rate of interest, and all surplus beyond goes to the policy-holders. In some instances, the capital stock of these "mixed companies" has been redeemed, after their successful establishment, leaving them purely mutual.

In New York and some other States the insurance department may receive further deposits, representing the reserve or present value of policies, and hold them accumulating in trust, for the security of those particular policies, which are "registered" in the State treasury. This scheme was pressed with vigour a few years ago, as offering peculiar protection, but several companies which adopted it have failed, and the settlement of the claims of creditors upon the funds held by the State has been the cause of much delay and costly litigation.

In each State there is a superintendent or commissioner of insurance whose powers and duties towards the companies are varied and important. The companies must return to him under oath every year full statistics of their business in all departments, showing the precise investments of their funds, the amount and sources of their income, the expenditure for every purpose, and a schedule of policies with the elements for valuing them. It is the superintendent's duty to see that the investments are made in accordance with the laws, which limit the companies to securities popularly regarded as the safest; to make every inquiry which he deems it "desirable for the public interest" to have answered; to make a valuation of the policies of each company by the legal standard; and to report to the legislature every year in full the results of his inquiries and calculations. It is his duty, "whenever he shall deem it expedient so to do," and in particular whenever he shall suspect any statement

<sup>1</sup> Each State has its own official standard of valuation. In New York, for example, the American Experience Table of Mortality, combined with 4½ per cent. interest, is the standard. In Massachusetts it is the Seventeen Offices' Experience (British) Table, and 4 per cent.

made by the officers, to "investigate" the affairs of each life assurance company,—that is, to overhaul its books and accounts, examine its muniments of title, and test and scrutinize every part of its administration. No company chartered by any other State or government can do any business within the State, except under his licence and certificate that it has complied with all the laws; and exclusion from the State is the penalty for neglect to answer any question concerning its business which he may ask. In several States he is required to exclude any company which shall take an appeal from the courts of the State to a court of the United States, in a case arising between it and a citizen.

The most important duty imposed on the superintendent is the administration of the legal test of solvency. In New York and most of the other States, his valuation, according to the legal standard, must be made by the net-premium method, and if any company is unable to meet this test by actual possession of the requisite amount of funds, he must commence legal proceedings for its dissolution, and the distribution of its assets as in bankruptcy. The Act making this course imperative in New York was passed in 1879, but many years earlier the practice had become fixed of requiring a company to meet a net valuation of its obligations, or be deemed insolvent. The fairness of this unbending application of the net-premium mode of valuation as a test of mere solvency, and the efficiency of the check supplied by a too exclusive reliance on such a test, have often been called in question.

When an insolvent assurance company is wound up, the rule commonly followed by the courts of equity in distributing the proceeds is to recognize each policyholder as a creditor for the amount of reserve corresponding to his assurance at the time of the declared insolvency. The representatives of a policyholder who dies before the actual distribution may claim for the amount of the policy, discounted back to the date of insolvency. The whole process of winding up would be much less unsatisfactory than it has proved, if the courts and the departments could make a prompt and inexpensive distribution. But in practice there is too much danger of the distribution being delayed until the available assets have been largely dissipated in receivership and legal expenses.

In New York, and several other States, the legislature has interfered to prevent the forfeiture of assurances by the failure to pay a premium, and has undertaken to regulate the payment of surrender values and the grant of paid-up policies in such cases. There is not, however, any general agreement among the different States as to the basis on which such allowances are to be computed. It is too soon to judge finally of the effect of these non-forfeiture laws upon the business; but the impression is believed to be growing among thoughtful policyholders that they are too favourable to withdrawing members, and tend to weaken the companies, by encouraging the retirement of the most healthy and profitable lives. Laws of this kind usually proceed upon the theory (which we venture to think an erroneous one) that the reserve for each particular assurance is to be looked upon as in some sense the property of the individual policyholder.

The American Experience Table adopted by New York State as the official standard of valuation was constructed by Mr Sheppard Homans from the statistics of the Mutual Life Insurance Company of New York City. Other valuable tables of American experience have been published, such as that given by Mr W. S. Nichols (*Ass. Mag.*, xix. 28) from the experience of the Mutual Benefit Insurance Company of New Jersey, and a later collection of the experience of the Mutual Life, more extensive than the first, to which Professor Bartlett has devoted great

attention. Some years ago the Chamber of Life Insurance in America (an association formed among the American assurance offices) undertook the collection and arrangement of the experience of a number of the companies in the States. Their labours when completed will no doubt throw much additional light on the value of assured life in America. Meantime Professor Bartlett brings out in his tables a longer duration of life than that indicated by experience in England, and Mr Nichols points out a higher relative mortality among young lives in America. If the latter peculiarity be well established, it will follow that the reserves required by American offices may be smaller than those required by English offices, even if the same rate of interest be employed in the calculations.

An interesting feature in the practice of many American Bonus offices is their dividing profits on the "contribution system method," so called because it aims at returning to each class of policyholders a share of the surplus proportionate to the amount contributed to its formation. An explanation of this method by Mr Homans, by whom it was originated, will be found in the *Assurance Magazine*, vol. xi. p. 121. Bonuses, or "dividends," as they are called in America, are largely taken in cash, but they may be applied in augmentation of the sums assured.

The "Tontine" system of assurance has come into prominence of late years. The policyholders under this plan agree that no dividend, return-premium or surrender value shall be received for a term of years called the "tontine period"; but that the entire surplus from all sources, including lapses, shall be accumulated to the end of that period, and then divided among all who have maintained their assurances in force. The tontine companies usually offer this plan as an alternative with the ordinary mode of assurance, and large numbers of applicants select it.

In Canada the course of legislation with regard to assurance has brought about a state of the law very much resembling that in the United States. After the passing of the latest Act in 1877,—which, among other things, requires all companies to keep separate assets in Canada against their liabilities there,—several British and American offices withdrew from transacting new business in the Dominion. From the report of the superintendent of insurance for the year 1879 it appears that the number of companies licensed for the transaction of life assurance business in Canada for that year was thirty-six. Of these thirteen did not transact new business. The following are the Canadian statistics for the year referred to.

	Assurances effected during the Year.		Assurances in force at end of Year.	
	Companies.	Amount Assured.	Companies.	Amount Assured.
Canadian Companies.	7	\$ 6,112,706	7	\$ 33,246,543
British Companies,....	11	1,877,918	18	19,410,829
American Companies.	5	3,363,600	11	23,616,330
Total.....	23	11,354,224	36	86,273,702

In Australia and New Zealand there were in 1879 (including the New Zealand Government Insurance Department) ten institutions for life assurance business. The total amount of new assurances granted by them was between £3,000,000 and £4,000,000, upwards of £2,000,000 of which was transacted by one office, the Australian Mutual. The ten offices had in force at the close of the year nearly 70,000 policies, assuring upwards of £23,000,000.

In India, at the Cape of Good Hope, and in the West Indies there are native assurance offices, but the business in those places is largely transacted by companies whose headquarters are in Great Britain.

Winding up.

Non-forfeiture laws.

American mortality tables.

Bonus system.

Tontine system.

Canada.

Australia.



On the continent of Europe the practice of life assurance has not as yet become so widespread as in English-speaking countries. There are assurance companies in various Continental countries, but it is chiefly in France and Germany that any extensive development of the system has taken place.

France. In France life assurance was later in taking root than in Great Britain, and its development has been much slower. There are, however, several large and solid life offices in that country dating back for a considerable period, besides a number of more recent growth, and the business is now making remarkable progress. The oldest French company, La Campagnie d'Assurances Générales, founded in 1819, issued in the year 1880 policies to the amount of 81,000,000 francs,—a year's business unequalled in magnitude in the experience of any British office. The following figures, taken from the *Moniteur des Assurances*, shows the rapid increase of business among the French life offices in recent years. They represent the total amount of new assurances effected in each year:—

	Francs.		Francs.
1875.....	254,000,000	1878.....	315,000,000
1876.....	284,000,000	1879.....	337,000,000
1877.....	278,000,000	1880.....	435,000,000

There are now twenty companies in France, the aggregate of whose existing assurances must considerably exceed 2,000,000,000 francs.

Germany. In Germany (including German Austria and German Switzerland) there are fifty companies transacting life assurance business, whose aggregate new assurances in the year 1879 amounted to 275,787,828 marks. At the end of that year the number of lives assured was 797,343, for sums amounting to 2,534,764,076 marks. There is now in progress an extensive investigation as to the mortality of assured lives in Germany, to which upwards of twenty German offices have contributed their experience. (G. M. L.)

III. MARINE INSURANCE.

Definition. Marine insurance is a contract by which one party, the "insurer" or "underwriter," engages for a stipulated premium to protect another party, the "assured," against loss arising from certain perils, or sea risks, to which his ship, goods, or other interest may be exposed during a specified voyage or period of time.

The Policy. The policy of insurance, or instrument which contains the contract, is a printed form, with spaces left blank for the insertion in writing of the particulars of the agreement. The form in general use appears to have been introduced with the earliest practice of British marine insurance. Although worded in a confused and ambiguous manner, its meaning has been clearly defined by a series of legal decisions on the debatable points; and in all cases the written conditions overrule any of the printed clauses that might seem inconsistent with them.

Stamp Act. The stamping of policies is at present regulated chiefly by the Customs and Inland Revenue Act, 1867, 30 Vict. c. 23. This Act provides that no contract or agreement for sea insurance shall be valid unless expressed in a policy; that all policies must be stamped before signature; that no policy shall be pleaded or admitted as evidence in any court, unless duly stamped; and that no policy can be made for any time exceeding twelve months. The stamp duties are—

On Voyage Policies.—For every £100 insured and for any fractional part of £100, 3d.

On Time Policies.—For every £100 insured, and for any fractional part of £100, where the time does not exceed six months, 3d.; where the time exceeds six months, and does not exceed twelve months. 6d.

If the separate interests of two or more persons be insured in one policy the stamp must cover each fractional part of £100, in the amounts of such separate interests, as if it were a full sum of £100. Where insurance is made for a voyage, and also for time, or to cover any time beyond twenty-four hours after the ship's arrival at her destination, the policy is chargeable with duty as a voyage policy, and also with duty as a time policy. The penalty exigible from any person engaged in effecting or subscribing policies which have not been duly stamped is £100.

By the Act 33 & 34 Vict. c. 97, § 117, it is provided that policies made abroad, but in any manner enforceable within the United Kingdom, are liable to the duty, and may be stamped at any time within two months after they have first been received in the United Kingdom. Further, by the Act 39 Vict. c. 6, § 2, it is now provided that, for the purpose of being given in evidence, any policy may be stamped after execution, on payment of the penalty of £100.

In practice it is usually desirable to conclude an agreement for insurance at once, lest some subsequent intelligence should induce either party to recede; and it is customary for the underwriter to sign a "slip," or short memorandum of the insurance, until the stamped policy can be completed. But such memorandums, however obligatory in good faith, are not legally binding. The assured, however, is under no obligation to communicate to the underwriter a material fact coming to his knowledge between the date of the slip and that of the policy. And, when a valid policy exists, the slip is admissible in evidence to throw light on the circumstances under which the risk was offered and accepted.

In order to give validity to the contract, it is necessary that the assured have a right of property, or "interest," in the thing assured. A policy without interest is held to be a wager; and it is declared by the 19th Geo. II. c. 37 that policies bearing the words "interest or no interest," or "without further proof of interest than the policy," or "without benefit of salvage to the insurer," or any policies made by way of gambling or wagering, shall be null and void. The expected profits of a sea adventure may be included in the value of the property for insurance; but an unwarrantable or fraudulent over-valuation might render the policy void even in respect of the value actually proved.

By the Act 31 & 32 Vict. c. 86 it is provided that, whenever a policy of insurance on any ship, or on any goods in a ship, or on any freight, has been assigned so as to pass the beneficial interest in such policy to any person entitled to the property thereby insured, the assignee of such policy shall be entitled to sue thereon in his own name, and the defendant in any action shall be entitled to make any defence which he would have been entitled to make if the said action had been brought in the name of the person by whom, or on whose account, the policy had been effected.

A valued policy is one which contains a specific valuation of the interest insured. This valuation forms an essential element in the adjustment of all claims under the policy, and cannot be set aside except on the ground of fraud. The burden of proof, in any averment of fraudulent over-valuation, lies on the underwriter.

An open policy is one in which the value of the interest insured is not specified. In claims under such policies the assured must prove the value of the thing insured. The value of a ship for insurance is what she is actually worth at the commencement of the voyage, including all her stores, provisions, and outfit, money advanced for seamen's wages, and costs of insurance. The difficulty of proving a

precise value in the case of ships is sufficiently obvious; and, to avoid disputes, policies on them ought always to be valued, as is the usual practice. The value to be proved under an open policy on goods is their first cost, including the expenses of shipment, with any portion of the freight that may have been prepaid, and the costs of insurance. The value to be proved in open policies on freight is the amount of the manifest or freight list, excluding such freight as may have been paid in advance.

When the value proved under an open policy falls short of the sum originally insured, the difference, which is technically termed an over-insurance, is treated as a deduction to be made from the amount of the policy. On this footing a proportionate part of the premium is returnable to the assured, who, on his part, can make no claim on the underwriter for loss or damage beyond the value of his interest as actually proved. If, on the other hand, the value proved exceed the amount of the policy, the assured is regarded as "his own underwriter" to the extent of such excess; and the amount of loss or damage, if such has arisen, is apportioned on this footing between the parties relatively to their several proportions of the total value.

A "short interest" arises when only a part of the interest insured has been exposed to risk, as when some portion of the goods specified in the policy have not been loaded on board of the ship. This case is treated in the same manner as that of over-insurance, from which indeed it does not essentially differ.

Double insurance takes place when the same interest has been insured twice or oftener. This frequently occurs, either through mere inadvertence, or from the want of definite information on the part of the respective persons concerned in the transaction. In such cases, the usual practice is that all the underwriters make a return of premium, in proportion to the amounts of their respective subscriptions, for the excess of the sum insured above the actual value of the interest,—the liabilities of the several underwriters under the different policies being of course proportionally diminished. To this rule, however, there are two important exceptions. One of these occurs when two or more persons insure the same thing, in order to protect the distinct interests which they may individually have in it; the other, when the circumstances are such that a claim for loss might have been brought against one set of underwriters before the other set had become liable at all.

Reinsurance was formerly illegal in England except in the event of the death, insolvency, or bankruptcy of the original insurer. This law subsisted for about one hundred and sixty years, but it was repealed by the 27 & 28 Vict. c. 65, and the subject of reinsurance was further regulated by the 30 & 31 Vict. c. 23. Reinsurance is now recognized by these statutes as a perfectly legal contract.

The risk on the ship, in voyage policies, commences "at and from" the place specified in the policy, and continues till she arrive at the destination specified, and have been there moored twenty-four hours in good safety. On goods the risk begins with their loading and ends with their discharge at the specified ports. On freight the risk usually commences with the shipment, and terminates with the landing of the goods; but if there be a contract of affreightment, under which the goods have been provided for shipment, the risk is held to commence as soon as the ship is in readiness to take them on board. After the risk has once commenced, the whole premium is earned, even although the voyage should not be prosecuted, and the actual risk of the insurers be thereby confined to the mere lying of the ship at the port where the insurance was to commence. But if the risk should not commence at all, or, in technical phrase, if the "policy should not attach," the premium must be returned to the assured.

If the ship should deviate from the regular and usual course of the specific voyage insured without necessity or reasonable cause, the underwriter is thenceforth discharged from all liability under the policy. The insurance becomes void as soon as such deviation begins; and consequently it is quite immaterial whether a subsequent loss of the ship should happen during the actual deviation or after the ship had returned to her course, the insurer being no longer concerned. It is also immaterial whether the assured was or was not cognizant of the deviation. A mere intention to deviate will not vitiate the policy; but if the ship have sailed on a different voyage from that specified, the insurer is discharged, although the loss should happen before reaching the point of divergence in the two voyages. An unjustifiable delay in the prosecution of the voyage operates as a deviation. The causes which justify deviation are such as to refit the ship after she has been disabled, to avoid an enemy or an impending storm, or to save the lives of seamen in distress.

In all voyage policies it is an implied condition of the contract that the ship shall be seaworthy at the commencement of the risk. By this is meant that the ship shall be in a fit state, as to repairs, equipments, crew, and all other respects, for encountering the ordinary perils of the voyage insured, at the time of sailing on it. Seaworthiness is a condition precedent to the contract; and, therefore, where the ship is originally unseaworthy, the underwriter is discharged even although the loss should result from causes independent of the particular deficiencies constituting the unseaworthiness. It is not material whether the assured is or is not cognizant of the defects rendering the ship unseaworthy; and this rule applies indiscriminately to the owners of the ship and the proprietors of the goods on board. There is no engagement that the vessel shall continue to be seaworthy after the voyage has been commenced; but it is the owner's duty to take all reasonable means to keep her so. The burden of proof in any avowment of unseaworthiness lies on the underwriter, unless where the ship, without adequate cause, becomes leaky soon after sailing. It is now settled law that in time policies there is no implied warranty of seaworthiness at any period of the risk. This was decided in the cases of *Gibson v. Small* (June 1853), and *Fawcus v. Sarsfield* (March 1856), and more recently by the House of Lords in *Dudgeon v. Pembroke* (March 1877).

The contract of insurance being pre-eminently one based on the assumption of perfect good faith between the parties, it is the duty of the party wishing to effect the policy to make a true disclosure of every circumstance likely to affect the underwriter's estimate of the risk. The concealment or misrepresentation of material facts, or the representation of anything not consistent with the facts, will render the policy void. This rule holds good even where the concealment or misrepresentation may have resulted from a mistake, without the intention to deceive. If the underwriter has actually been deceived, whether wilfully or by mistake, the risk is different from that understood and intended to be run; and on this ground he is discharged. The materiality of a concealment or misrepresentation depends, not on its eventual influence on the result of the risk, but on its immediate influence on the judgment of the underwriter at the time of effecting the insurance. The loss may arise from causes totally unconnected with the facts concealed or misrepresented, but the policy may nevertheless be void, because a true disclosure of the facts at the time of effecting it might have led the underwriter to decline the insurance altogether, or to accept it only at a higher premium. If an agent be employed to effect the insurance, he is bound to communicate to the underwriter, not only all the material facts disclosed to



himself by his principal, but also any other material facts which may have come to his knowledge from other sources. If either the principal or the agent fail to communicate such facts, the policy will be void. Should any material fact come to the knowledge of the parties wishing to effect the insurance after they have sent away an order to have it effected, they are bound to intimate such fact without delay, so that the underwriter may be informed of it (if there should still be time) before he has accepted the risk. The suppression of information tending to show that the ship was overdue, or that there were rumours current as to her having met with some accident (even though it afterwards appeared that these rumours were unfounded), is concealment fatal to the validity of the contract. It has also been held that a policy was void because the agents employed to effect it failed to inform the underwriters that their principal had instructed them to wait the arrival of the ship for a certain number of days before acting on the order to insure. Misrepresentations of the terms on which other underwriters have agreed to accept the insurance will be fatal to the validity of the contract, as well as misrepresentation of the risk itself. It may be observed generally that every circumstance represented to the underwriter ought to be at least substantially true. A mere expression of opinion or expectation does not of course amount to a positive representation of facts; but the opinion or expectation expressed must itself be genuine, since, if it appeared that it had been only a pretence, or inconsistent with anything within the actual knowledge of the assured at the time, the policy might be vitiated. When an express "warranty" is given, its terms must be literally complied with, otherwise the policy will be void. The chief distinction between a warranty and a representation is that the former is always inserted in the policy, while the latter is never so inserted; and the effect of this is that, while a representation affects the contract only in so far as it may be found to have been material to the risk, a warranty precludes all questions as to materiality, its express terms superseding any such inquiry.

Perils  
insured  
against.

The perils insured against are described in the printed form as the "adventures and perils of the seas, men-of-war, fire, enemies, pirates, rovers, thieves, jettisons, letters of mart and counter-mart, surprisals, takings at sea, arrests, restraints, and detentions of all kings, princes, and people, of what nation, condition, or quality soever, barratry of the master and mariners, and all other perils, losses, and misfortunes that have or shall come to the hurt, detriment, or damage of the said goods, merchandises, and ship, &c., or any part thereof." It may be observed that, as a general rule, the underwriters are liable only for such losses as are proximately caused by the perils insured against. For the remote consequences of these perils, such, for instance, as the loss of markets through delay, they are not responsible. But, on the other hand, if a loss has been proximately caused by a peril insured against, the underwriters are not relieved from liability, although such loss may have been remotely occasioned by the acts or negligence of the assured or his agents. The reason for this rule, as given by Lord Bacon, is that "it were infinite for the law to consider the causes of causes, and their impulsions one on another; therefore it contenteth itself with the immediate cause."

Losses resulting from breaches of the revenue laws or of the law of nations, or from illegal voyages generally, are not covered by the policy. The risk of "thieves" applies only to plunder committed by open violence, and does not cover losses by secret theft. The illegal acts of the master and crew, if committed without the privity of the owners, will amount to barratry, so as to render the underwriters

responsible for them, but if the master be also owner of the ship, none of his acts will be held as barratrous. A shipmaster, however, who is only part owner may commit barratry as against his co-owners and their underwriters. If the assured be the subject of a foreign state, British underwriters will not be liable for the acts of that state, unless it appear from the form of the policy or from the circumstances of the case that the intention was to insure against such risk. Losses by the ordinary wear and tear of the ship, or by the natural deterioration or decay of perishable goods, are not chargeable to the underwriters.

The printed form of the policy declares that "in case of any loss or misfortune it shall be lawful to the assured, their factors, servants, and assigns, to sue, labour, and travel for, in, or about the defence, safeguard, and recovery of the said goods and merchandises, or ship, or any part thereof, without prejudice to this insurance: to the charges whereof, we, the assurers, will contribute, each one according to the rate and quantity of his sum herein insured." The object of this clause is to permit the assured to take measures for the recovery of the property without losing any right of abandonment he might have in the circumstances. Although the language of the clause is only permissive, it is a settled rule that the assured is bound so to labour for the recovery of the property. The best practical rule for the assured to follow in cases of partial loss or damage is to act in the circumstances as a prudent man would do if uninsured.

Duty of  
assured  
in case of  
damage.

An important clause in the printed policy is what is called the "memorandum," which is as follows:—"Corn, fish, salt, fruit, flower, and seed are warranted free from average, unless general, or the ship be stranded. Sugar, tobacco, hemp, flax, hides, and skins are warranted free from average under 5 per cent. And all other goods, also the ship and freight, are warranted free of average under 3 per cent., unless general, or the ship be stranded." The effect of this clause, as interpreted by legal decisions, is to free the underwriter from claims for particular average (or partial damage), or from such claims if under the rates specified, unless the ship be stranded. But if the ship be stranded, he is liable for such claims, whether caused by the stranding or not. For losses of the nature of general average the underwriter is liable whether the ship be stranded or not, and whether the amount be over or under the rates mentioned in the memorandum.

The memo-  
randum.

It is frequently a matter of some difficulty to determine whether a ship has been stranded within the meaning of the memorandum. A mere touching or striking, whether on a rock, bank, reef, or other object, will not constitute a stranding, unless the ship settles down and remains fixed for some definite time. The amount of damage sustained is not material to the question either way. Where a vessel takes the ground in the ordinary and usual course of the navigation in a tidal river or harbour, on the ebbing of the tide, or from natural deficiency of water, this is no stranding. It is essential to a stranding that the ship should take the ground by reason of some unusual or accidental occurrence. A voluntary stranding to save the ship from sinking is within the meaning of the memorandum, although the ship should be run into a tidal harbour for the purpose.

When an absolute total loss occurs, the assured is entitled to recover the amount of the policy, without giving notice of abandonment. When the subject insured, without being wholly destroyed, is so seriously injured, through the perils insured against, that its recovery might involve greater expenses than its eventual value would cover, it forms a "constructive total loss," and the assured is entitled to give notice of abandonment to the insurers, and to claim the amount of the policy. (See *ABANDON-*

Total  
loss and  
abandon-  
ment.

MENT.) It is only, however, when the circumstances seem to involve a virtual loss, as distinguished from a deterioration of the property, that notice of abandonment can be competently given; and, unless the abandonment be accepted, the ultimate state of the facts will alone determine the question whether it can be insisted on. The principle upon which losses are settled, when abandonment is validly made, is that the underwriter becomes the proprietor of the subjects abandoned on payment of the sum insured. The effect of an abandonment of the ship is to transfer the ownership to the underwriters, so that whatever freight she may thereafter earn belongs to them; and, although such freight is thereby lost to the original owners, the insurers of the freight are not liable to them for loss in respect of it, because it is lost only by their own act of abandonment, and not by the perils insured against. When goods are so damaged by the perils insured against that they are necessarily sold at any place other than the original destination, they are constructively lost, and the underwriter is liable for their insured value, under deduction of the net proceeds of the sale. But this rule is not applied to goods warranted "free from average unless stranded," if there has been no stranding of the ship,—it being only in that event that the underwriter is responsible for damage to such goods. A constructive loss of freight occurs when the ship is prevented by any peril insured against from completing her voyage, or when the goods on which the freight is to be earned have received such damage that they cannot be conveyed to their destination; but if the ship can proceed with other goods, the freight earned for these must be deducted from the claim for loss.

Partial loss or damage, arising from the perils insured against, is usually, though somewhat loosely, designated by the term "particular average." Under this head are included the damages suffered from the accidental or voluntary stranding of the ship, or by her getting into collision with another vessel, by lightning, fire, hostile attacks, or the violence of the sea under any extraordinary circumstances. Damages to the ship's upper works, sails, spars, and rigging are included under particular average if occasioned by the direct force of the sea; but if caused merely by the force of the wind they are treated as wear and tear, and are not chargeable to the insurers. The loss of anchors and cables parted from by the vessel riding hard, or by the anchor hooking to any object at the bottom, is regarded as wear and tear; and the same rule applies to the repairs of the ship consequent on her becoming leaky through working and straining in a heavy sea. The general principle upon which damages of the nature of particular average are distinguished from those falling under the class of wear and tear is that the former must be caused by the immediate operation of some extraordinary accident, while the latter are only the ordinary incidents of navigation, and as such are not within the scope of the underwriter's contract. But the practical application of this principle is a matter of much nicety, and must usually be left to the judgment of a professional average stater.

In adjusting claims for particular average on ships, certain deductions are made for the difference between "new and old," unless the ship be on her first voyage, either outward or homeward, or the repairs be only temporary. On this footing one-third is deducted from the costs of the materials and labour required for the ship's repairs, excluding, however, the charges for dock dues, surveyor's fees, or similar accessories, which are allowed in full. No deduction is made for anchors (unless in so far as they may be fitted with wood), and the deduction for chain cables is only one-sixth. When a ship has to be recovered at the expense of the underwriters, the practice

is to allow in full the difference of price between old and new metal, to the extent of the weight of the old copper stripped off; and if any sheets have been lost by being rubbed off, the cost of replacing these is further allowed, under deduction of one-third. If the ship has not been stranded, the underwriters are not liable for claims for particular average amounting to less than 3 per cent. on her insured value, independently of the accessory expenses, such as survey fees, &c., which are not taken into account in making up the 3 per cent. Two or more averages occurring in the course of a voyage may, however, be taken together to make up 3 per cent. on the value of the ship, so as to render the insurers liable.

Particular average on goods occurs when they arrive at their port of destination damaged by sea-water, or by its effects in heating or otherwise deteriorating them, although in actual contact only with other portions of the cargo. The amount of compensation recoverable from the insurers for such damage is regulated by comparing the "gross" market price, which the goods would have produced if landed in sound condition, with the actual gross price obtained for them in their damaged state, and by charging to the insurers the same rate of deterioration on the value insured, with the addition of the extra charges specially occasioned by the damage, such as surveys, &c. By this mode of adjustment the assured recovers either more or less than the actual depreciation of the goods, according as the insured value may exceed or fall below the sound market value at the port of destination; but as the latter value generally includes freights, duties, and other charges, besides profits, it is in most cases in excess of the insured value, and to the extent of such excess the indemnity of the assured is incomplete. The equity, however, of this mode of adjustment is obvious, when it is considered that the insurer receives his premium only on the value insured, and ought therefore to be liable only in respect of that value, while at the same time the gross market values of the goods in their sound and damaged condition furnish the only true criterion of the actual depreciation, because these are the only values with reference to which, ultimately at least, purchasers could be influenced. It is, however, customary to adjust particular average on a comparison of bonded instead of duty-paid prices in claims for damage to tea, tobacco, coffee, wine, and spirits imported into the United Kingdom.

As already indicated, claims for particular average on goods must amount to 3 per cent. or upwards, or in the case of the goods specified in the second clause of the memorandum to 5 per cent. or upwards, otherwise the underwriters will not be liable unless the ship has been stranded; and it is only when there has been a stranding of the ship that the insurers are liable for any such claims on the goods specified in the first clause of the memorandum, or on other goods specially warranted "free of particular average."

The subject of general average has been treated under the heading AVERAGE (*q.v.*). But it may here be remarked that, in the very recent case of *Attwood v. Sellar* (March 1880), it has been decided, contrary to the usage of seventy or eighty years, that the expenses of warehousing and reshipping the cargo at a port of refuge, and of the ship in quitting that port, are the subject of general average contribution.

On the general subject of marine insurance the best book of reference is Arnould's *Treatise* (5th edition), which embraces the leading cases decided in the law courts down to a very recent period. Amongst the minor works bearing on the subject may be mentioned Mr M. Hopkins's *Manual of Marine Insurance*, and Mr Charles M'Arthur's *Policy of Marine Insurance Popularly Explained*, and especially Mr R. Lowndes's *Practical Treatise on the Law of Marine Insurance* (1881). (J. W.A.)



**INTERDICT** (*interdictum* sc. *officiorum divinatorum*), in its full technical sense as an ecclesiastical term, means a sentence by a competent ecclesiastical authority (popes, councils, bishops with chapters) forbidding all administration of the sacraments, celebration of public worship, and use of the burial service. An interdict may be either local, personal, or mixed, according as it applies to a locality, to a particular person or class of persons, or to a particular locality as long as it shall be the residence of a particular person or class of persons. Local interdicts again may be either general or particular; in the latter instance they refer only to particular buildings set apart for religious services. In the writings of Augustine (*Epp.*, 250) there is an indication that something of the nature of an interdict had been attempted in his diocese by a certain bishop Auxilius; the attempt is strongly condemned by Augustine, who disapproved of the plan, as making the innocent suffer along with the guilty. In 869 Hincmar of Laon laid his entire diocese under an interdict, a proceeding for which he was severely censured by Hincmar of Rheims. In the *Chronicle* of Ademar of Limoges (*ad ann.* 994) it is stated that Bishop Alduin introduced there "a new plan for punishing the wickedness of his people; he ordered the churches and monasteries to cease from divine worship and the people to abstain from divine praise, and this he called excommunication" (see Gieseler, *Kirchengesch.* iii. 342,

where also the text is given of a proposal to a similar effect made by Odelric, abbot of St Martial, at the council of Limoges in 1031). It was not until the 11th century that the use of the interdict obtained a recognized place among the means of discipline at the disposal of the Roman hierarchy. Important historical instances of the use of the interdict occur, in the cases of Scotland under Pope Alexander III. in 1181, of France under Innocent III. in 1200, and of England under the same pope in 1209. So far as the interdict is "personal," that is to say, applied to a particular individual, it may be regarded as synonymous with EXCOMMUNICATION (*q.v.*), an ecclesiastical punishment known in one form or another in all churches; the local interdict is quite peculiar to the Church of Rome. It is removed by what is termed "reconciliation."

**INTERDICT**, in Scotch law, is an order of court pronounced on cause shown for stopping any proceedings complained of as illegal or wrongful. It may be resorted to as a remedy against all encroachments either on property or possession. For the analogous English practice see **INJUNCTION**.

**INTERDICTION**, in Scotch law, is a process of restraint applied to prodigals and others who, "from weakness, facility, or profusion, are liable to imposition." It is either voluntary or judicial. Voluntary interdiction is effected by the act of the prodigal himself, who executes a bond oblig-

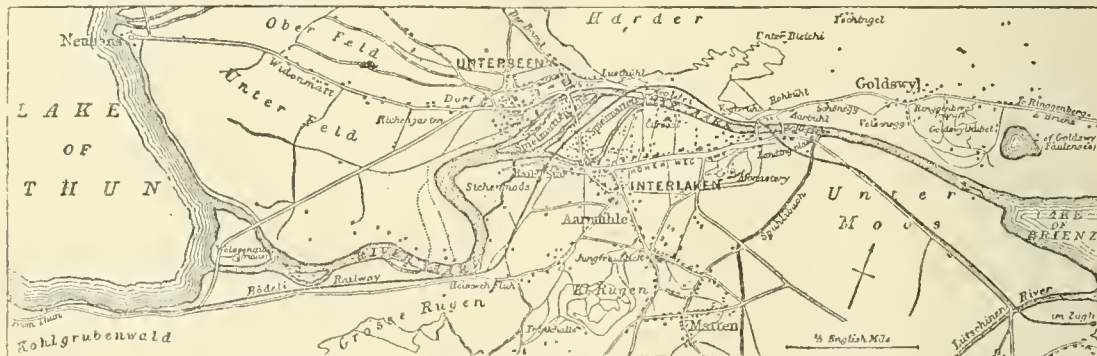

Environns of Interlaken.

ing himself to do no deed which may affect his estate without the assent of certain persons called the "interdictors." This may be removed by the court of session, by the joint act of the interdictors and the interdicted, and by the number of interdictors being reduced below the number constituting a quorum. Judicial interdiction is imposed by order of the court itself, either moved by an interested party or acting in the exercise of its *nobile officium*, and can only be removed by a similar order. After interdiction duly completed according to law, all deeds done by the interdicted person, so far as they affect or purport to affect his heritable estate, are reducible, unless they have been done with the consent of the interdictors. Interdiction has no effect, however, on movable property.

**INTEREST.** At English common law an agreement to pay interest is not implied unless in the case of negotiable instruments, when it is supported by mercantile usage. As a general rule therefore debts certain, payable at a specified time, do not carry interest from that time unless there has been an express agreement that they should do so. But when it has been the constant practice of a trade or business to charge interest, or where as between the parties interest has been always charged and paid, a contract to pay interest is implied. It is now provided by 3 & 4 Will. IV. c. 42 that, "upon all debts or sums certain payable at a certain time or otherwise, the jury on the trial of any issue or in any inquisition of damages may if

they shall think fit allow interest to the creditor at a rate not exceeding the current rate of interest, from the time when such debts or sums certain were payable, if such debts or sums be payable by virtue of some written instrument at a certain time; or if payable otherwise, then from the time when demand of payment shall have been made in writing, so as such demand shall give notice to the debtor that interest will be claimed from the date of such demand until the term of payment: provided that interest shall be payable in all cases in which it is now payable by law." Since the abolition of the usury laws by the 17 & 18 Vict. c. 90, a contract stipulating for higher interest than the legal rate of 5 per cent. is no longer illegal. This Act, however, does not affect contracts with pawnbrokers. Compound interest requires to be supported by positive proof that it was agreed to by the parties; an established practice to account in this manner will be evidence of such an agreement. In short, under the present law, any contract that the parties choose to make as to the amount of interest, or the time or manner of payment, will be enforced like any other agreement. When interest is awarded by a court it is generally at the rate of 4 per cent.; under special circumstances 5 per cent. has been allowed.

**INTERLAKEN**, or **INTERLACHEN**, a Swiss village in the canton and 26 miles south-east of the town of Bern, is situated on the left bank of the Aare in the low-lying district named the Bädli, between the lakes of Thun and

Brienz. The name is strictly applied to the few buildings which occupy the site of the religious houses founded in 1130 and abolished in 1528, but is generally used as including also the Hüheweg, a handsome avenue shaded with walnut trees and flanked by hotels and shops, and the village of Aarmühle at its western extremity. The houses are mostly of timber, but the village is lighted with gas, and has an excellent water-supply. The east wing of the Augustinian monastery has been used since 1836 as a hospital for the poor; and the rest of the building together with the castle, added in 1750, is now occupied by Government offices. The nunnery, which was suppressed in 1484, has been converted into a prison. The Kursaal, on the Hüheweg, was opened by the hotelkeepers in 1869. Between 150,000 and 200,000 strangers visit Interlaken annually, being attracted by its beautiful situation and fine climate, as well as by its goat's-whey cure. Interlaken is a convenient centre from which to visit the Bernese Oberland, with the Grindelwald and Lauterbrunnen valleys and the Giessbach and Staubbach falls. Population of Interlaken, Aarmühle, and the adjacent Unterseen, in 1880, 4080.

**INTERNATIONAL.** The International Working Men's Association, commonly called the "International," was formed at London in 1864. It was a society of working men of all nations, somewhat like a cosmopolitan trades union, but bearing a still closer resemblance to an international social science association for discussing and furthering the rights of labour. At first moderate in its tone, it soon began to endorse advanced views respecting property and industrial organization. Shortly after it had attained to the height of its power about 1869, it became more and more allied with the most destructive socialism of western Europe. Weakened by internal disunion, and discredited by its approval of the commune at Paris and its alliance with the communal risings in southern Spain, the International died a natural death before it was quite ten years old.

The occasion of the formation of the International was the visit of some French workmen to the London Exhibition of 1862. This visit had the approval and even the pecuniary support of the emperor, and was warmly commended by some of the leading Parisian organs as a means, not only of acquainting them with the industrial treasures of the exhibition, but of removing from the relations of the two countries the old leaven of international discord and jealousy. In the course of their visit the French delegates were cordially welcomed at an entertainment at the Freemasons' Tavern, where the labour question was discussed, and a desire for the further interchange of ideas expressed. Nothing decisive, however, was done till 1864, when a great public meeting of working men of all nations was held at St Martin's Hall, at which Professor Beesly presided. Here a provisional committee was appointed to draft the constitution of the new association. In this constitution, which was approved at the first congress held at Geneva in 1866, and in a remarkable address issued by the committee the aim of the International is defined in clear and able terms. It was set forth that, notwithstanding the vast development of industry and the enormous accumulation of national wealth, the lot of the working class was as hard as ever. All the recent revolutions and political reforms had been achieved only in the interest of the middle classes, leaving the position of the working man unimproved. The emancipation of the working men must be the task of the working men themselves. With this view the International was founded, which, while recognizing truth, justice, and morality as the basis of its action, without distinction of creed, nationality, and colour, would serve as a common centre for the efforts of working men towards their complete deliverance from the tyranny of

capital. A general council having its seat at London was appointed, which was to hold annual congresses and exercise a general control over the affairs of the association, while local societies were allowed free play in all local questions. The working men of a district or trade were to form a section, several sections formed a federation, and all the societies of each nation were if possible to form a national association; but all were to be in communication with the International headquarters.

The first four congresses of the International, held at Geneva (September 1866), Lausanne (1867), Brussels (1868), and Basel (1869), marked the rapid development of the association. It gained its first triumph in the effectual support of the bronze-workers at Paris during their lock-out in 1867; and it repeatedly gave real help to the English unionists by preventing the importation of cheap labour from the Continent. In the beginning of 1868 one hundred and twenty-two societies of South Germany assembled at Nuremberg declared their adhesion to the International. In 1870 Cameron announced himself as the representative of 800,000 American workmen who had adopted its principles. It soon spread as far east as Poland and Hungary, and it had affiliated societies with journals devoted to its cause in every country of western Europe. The leading organs of the European press became more than interested in its movements; the *Times* published four leaders on the Brussels congress. It was supposed to be concerned in all the revolutionary movements and agitations of Europe, gaining a world historic notoriety as the rallying point of social overthrow and ruin. Its prestige, however, was always based more on the vast possibilities of the cause it represented than on its actual power. Its organization was loose, its financial resources insignificant; the Continental unionists joined it more in the hope of borrowing than of contributing support. At the successive congresses its socialistic tendencies became more and more pronounced; it declared its opposition to private property not only in railways but in mines and the soil, holding that these should revert to the community. Even the principle of inheritance was saved only by a narrow majority. In 1869 Bakunin the Russian socialist or nihilist with his party joined the association, and at once asserted his character as the "apostle of universal destruction."

In 1870 the International resolved to establish itself at the very hearth of the revolutionary movement by holding its annual congress at Paris. This plan was rendered abortive by the Franco-German conflict. That war, however, helped to bring the principles of the association more decidedly before the world. On general grounds, and during the Austro-Prussian struggle of 1866, it had declared its emphatic condemnation of war; and now the societies of France and Germany as well as the general council at London uttered a solemn protest against this renewal of the scourge. Some of its German adherents likewise incurred the wrath of the authorities by venturing to protest against the annexation of Alsace and Lorraine. In this way the International appeared as the champion of a wider principle against the abuse of the principle of nationality.

The relation of the association to the communal rising at Paris in the spring of 1871 has been the subject of much dispute. It is now agreed that the International as such had no part either in originating or conducting it; some of its French members joined it, but only on their individual responsibility. Its complicity after the event is equally clear. After the fall of the commune the general council of London, Karl Marx included, issued a long and trenchant manifesto, approving its action and extolling it as "glorious vanquished." From this point the decline and



fall of the association is to be dated. The English unionists, intent on more practical concerns at home, never took a deep interest in its proceedings; the German socialists were hindered by law from corporate action; America was too remote. But it found its worst enemies amongst its own friends; the views of Marx and his school were too moderate for the universally subversive principles of Bakunin, and the radical Swiss federation of the Jura led by Guillaume. It came to a rupture at the congress of 1872, held at the Hague, when Bakunin, being outvoted and "excommunicated" by the Marx party, formed a rival International, which found its chief support in Spain and Italy. Wearied of its European contentions and desirous to form a basis of operation in America, the Marx International now transferred the seat of its general council to New York; but it survived just long enough to hold another congress at Geneva in 1874, and then quietly expired. The party of destruction styling themselves "autonomists" had a bloodier history. The programme of this party was to overturn all existing institutions, with the view to reconstructing them on some vague communal basis such as had been tried at Paris in 1871. It endeavoured to realize this in the great communal risings in southern Spain in 1873, when its adherents set up their peculiar form of government at Barcelona, Seville, Cadiz, and Cartagena,—at the last-mentioned place also seizing on part of the iron-clad fleet of Spain. As at Paris, they failed in leadership and organization, and were suppressed, though not without difficulty, by the national troops. The "autonomists" lingered on till 1879. At present there is no society that has any claim to the name and prestige of the International. The collapse has thus been complete of an association which once extended from Hungary to San Francisco, and alarmed the minds of men with visions of universal ruin.

See Villetard, *Histoire de l'Internationale*, Paris, 1871; Testut, *L'Internationale*, Paris, 1871; Onslow Yorke, *Secret History of the International*, London, 1871; Emile de Laveleye, *Revue des Deux Mondes*, April 1880; Professor Beesly, *Fortnightly Review*, 1870.

INTERNATIONAL LAW is the name now generally given to the rules of conduct accepted as binding *inter se* by the nations—or at all events the civilized nations—of the world. International law as a whole is capable of being very differently interpreted according to the point of view from which it is regarded, and its rules vary infinitely in point of certainty and acceptance. According to the ideas of the leading English school of jurists it is an impropriety to speak of these rules as being laws; they are merely moral principles,—positive, it is true, in the sense that they are recognized in fact, but destitute of the sanctioning force which is the distinguishing quality of law. There is not a word to be said against this criticism considered merely as a verbal criticism, but it may be so used as unduly to depreciate the actual force and effect of the system as a whole. On the other hand, the vast majority of writers on international law have preferred to derive its principles from some transcendental source, such as nature, reason, the Divine will, &c.; and these accordingly have no hesitation in attributing to its rules an intrinsic authority over all the nations of the world. The usage of nations according to this theory is evidence of, but not the origin of, the law. It merely expresses, as Sir R. Phillimore puts it, "the consent of nations to things which are *naturally*, that is, by the law of God, binding upon them." The true position is this—that we find as a fact a number of rules accepted by civilized nations as obligatory in their mutual dealings. These rules no doubt in many cases owe their existence to the prevalence of theories of natural and divine law, but their authority no longer depends on the truth of such theories. The rules are in themselves just and reasonable. Some of them are so precise, so certain, and

so universally accepted that they cannot be distinguished from positive law except by the absence of a determinate legislative source. Many of them are taken up by the municipal laws of different countries, and in so far as they are thus incorporated with positive systems they are in every sense positive laws. But many of the rules of international law are vague, uncertain, and of disputed authority. Some of the rules, for example, relating to capture in war, the law of blockade, and the privileges of ambassadors are so well ascertained and settled that it is hardly conceivable that they should be broken by any civilized state. On other points—*e.g.*, as to what articles should be contraband of war, when a state should interfere with the domestic policy of another—no universally admitted principles can be said to have been established. The substance of international law has been for this reason divided into various sections, according to the degree of certainty which the rules have obtained. Thus one of the most recent writers on this subject, Dr Woolsey, distinguishes the rights and duties known to the science as (1) those which are deducible from natural *jus*, which no action of a state can begin or terminate, (2) those deducible from the idea of a state, and (3) those which can be created or destroyed by compact, express or tacit. This and similar divisions do not really explain why some of the rules composing what is known as international law are as fixed and certain as rules of conduct can well be, while others are pure matter of controversy. It is simpler to state the fact and to take note that the area of certainty in international law is constantly increasing. For example, the rights of embassies were disputed by England till a recent period; and the rules prohibiting the slave-trade and making privateering illegal are comparatively recent additions to the certainties of international law. To say that such rules as the last, being founded on contract, are therefore of inferior authority to the imperishable principles which pronounce all sovereigns to be equal and independent, and distinguish between just and unjust wars, is absurd.<sup>1</sup>

The theory of international law contemplates the world as divided into independent states. That states are sovereign within their own territories, independent of other states, and equal as between themselves is a fundamental axiom of the science. Not that all states are regarded as lying within the domain of this law. In modern times at least it has included all the states of the Christian world; but at one time it excluded non-Christian states, and at this moment it would be difficult to say to what extent it covers the relations of such states *inter se* and with the Christian states of Europe and America. There is little doubt, however, that in course of time all the civilized communities of the world will observe substantially the same system of international law.

In the next place international law regards the states of the world as being either in a state of war or in a state of peace. It prescribes rules of conduct to be observed in the mutual dealings of nations which are at peace with each other, and of nations that are at war with each other; and it fixes the rights and duties of belligerent and neutral nations. If peace is the normal state of nations, as jurists sometimes assert, war is the state which has made the largest demands on the science. The rules of international law with regard to war are more voluminous and more certain than those which govern nations in time of peace.

International law, as we now know it, is substantially the creation of civilized Europe in the last three hundred years, but rules of some kind, however meagre,

<sup>1</sup> The name "international law" has generally taken the place of the "law of nations," the "law of war and peace," *Jus inter gentes*, &c., used by earlier writers. Bentham suggested international law as the most suitable title.

must accompany any state of society in which intercourse, hostile or peaceful, between different communities is common. The great nations of antiquity which have contributed most to the civilization of modern Europe have given least to this branch of that civilization. The history of the Jews furnishes nothing but examples of the total absence of a sense of duty in relation to other nations. The division of the Greek world into a large number of independent communities favored the existence of an Hellenic law of nations, presenting in many points—such as the recognition of common Hellenic customs, religious and political, and of the principle of a balance of power—a parallel to modern international law. The coherence of the Greek communities, however, only intensified the difference between them and all other peoples, and left their relations with them unregulated by any general principles. The *jus fecciale* of the earlier Roman law—regulating the formal intercourse between Rome and other nations—is indeed the germ of what might have been a system of pure international law. But the rise of the Roman commonwealth to the mastery of the world rendered a *jus inter gentes* unnecessary and impossible. The feccial law with its college of interpreting priests dwindled into an obsolete collection of formalities no longer supported by the religious feelings of the people. The *jus gentium* of the Romans does indeed play an important part in the history of international law, but as conceived of by the Roman lawyers it was not international, but a body of positive law composed of the elements common to the nations known to them, including Rome itself. Positive international law does not in fact come into existence until the era of Grotius, although usages of international intercourse must at all times have existed. The sanctity attributed to ambassadors, the importance of formal declarations of war, and the good faith to be observed in promises or treaties would probably be found to be the points of most general recognition.

The connexion between Roman and modern international law, through the conceptions of *jus gentium* and *jus naturee*, has been lucidly traced by Sir Henry Maine in his treatise on *Ancient Law*, and may be briefly noticed here. The postulates of the law of nations—that there is a determinate law of nature, that it is binding on states *inter se*, and that such states are equal—are founded on well-known general principles of the Roman jurists. The ambiguity of the phrase *jus gentium* enabled the early founders of international law to apply the principles of the *jus naturee* to the conduct of states *inter se* in a way of which there is no example in the Roman law-books. Further, in the Middle Ages the state systems of Europe had arranged themselves on a territorial basis, so that sovereigns were regarded as being the absolute masters of the territory occupied by their people, instead of the chiefs of the people irrespective of territory. They could thus be conceived as “members of a group of Roman proprietors,” and the Roman law of property supplied the fundamental principles on which their occupation was in international law understood to be based. The appearance of jurists, dominated by the conceptions of the Roman law, at a time when European arrangements made their application possible, is the true beginning of modern international law. The greatest name is that of Grotius, whose work *De jure Belli et Pacis* was published in 1624. In the first sentence of the prolegomena he defines his subject as the law which obtains between nations or their rulers, whether founded on native or divine ordinance, or custom and tacit consent, which he adds *universim ac certo ordine tractavit hactenus nemo*. There had been earlier workers in the same field. Among these were Francis de Victoria of Salamanca, Suarez, Ayala, and Albericus Gentilis, all of whom

flourished in the 16th century. The work of Grotius definitely laid the foundation of the science, which he shaped in imitation of the institutional treatises of Roman law. Among the jurists who followed Grotius, the classical names are those of Puffendorf, Wolff, Vattel, and Bynkershoek. In England Sir Leoline Jenkins and Lord Stowell are the most illustrious of these who have made important contributions to international law. In America Wheaton stands at the head of a school of distinguished jurists, and his *Elements of International Law* is the standard modern treatise on the subject.

Several of the more important heads of international law will have to be noticed separately, and it is only proposed in the present article to state shortly and in outline its leading principles so far as they can be gathered from the most authoritative modern writers. It will be convenient to discuss first the general rules obtaining between nation and nation, and, secondly, the modifications and special rules which are brought into existence by a state of war.

It may be necessary to distinguish here between public international law and what is known as private international law. The latter phrase is applied to those principles which in the ordinary tribunals of a country are used to harmonize the conflict of laws. Where the subject of a foreign state has a claim against the queen or any of the queen's subjects, for which he seeks redress in our courts of law, it may become necessary to recognize and enforce the law of the foreign state and not the law of England. The best illustration of this class of questions is the case of domicile. For many purposes the place in which a man is domiciled as distinguished both from that in which he lives and the country of which he is a subject, supplies the law applicable to his case. A French subject, domiciled in Scotland, dies in England leaving personal property in England; in such a case the property would be distributed according to the law of Scotland, and not of England or of France. All nations have to provide for such cases, in which the principles of a foreign jurisprudence must be enforced, and have to determine under what conditions and to what extent the tribunal will be required to enforce them. As it happens there is a general agreement among nations on these points; the rule, for example, which makes real property administrable according to the law of the land, and personal property according to the law of the owner's domicile, is universally recognized. So far as this agreement extends, there may be said to be a private international law corresponding to the international system of public law. But in the former we have to deal with true positive law, deriving its authority from the legislature, having no reference to the opinions and practice of nations, and dealing with the rights of individuals. Public international law is of a totally different character, recognizing nations as the only parties, and depending on the agreement of nations as evinced by their opinions and practice. It is with the latter only that we have now to deal.

Independent sovereign states are then the units of international law, and whether a given community is such a state is a question of fact. A community having definite territorial limits within which its own government exercises absolute authority, free from all external control, is the proper type of a state in international law. But the world is not parcelled out among states thus accurately defined. Where a number of states have been united in a permanent confederation, it may be a question whether the group alone is in international law an independent state, or whether each individual member has retained its international independence. The United States of America are an example of the former case; the German confederation until the recent changes was an example of the other. Again, when one state has placed itself under the protection



of another, it may be a question whether it has lost or retained its independent status in international law. The proper test, according to Phillimore, is its capacity *de facto* to deal with other states in peace or war, without reference to the protecting state. States which have lost this capacity have been called semi-sovereign states. They have the organization of an independent nation, but are in practice subject to the rule of another state. The Ionian Islands under the English protectorate were in that position, and in the treaty of 1815 they are described as a single free and independent state, under the exclusive protection of Great Britain. A similar character attaches to some of the dependencies of Turkey. On the other hand, a large portion of the surface of the earth is occupied by communities having neither the permanent territorial occupation nor the social coherence of civilized states, yet entering into such relations with them as require the recognition of some system of rules. A further question of the highest importance may arise when a portion of an existing state rises in rebellion and sets up a claim to independence. Here again the question is one of fact. If the rebels have succeeded in establishing a government, it is the right and duty of the nations to recognize the fact, and each nation must judge for itself whether the time for recognition has come. Premature recognition would be regarded as an aid to rebellion inconsistent with the rules of international law. The criterion suggested by practice and authority is whether the old government had ceased to contend in fact against the revolutionary state. But other nations are not bound to wait until the old government has itself recognized the independence of the new. Similar questions arise when the form of government in any country is changed by revolution, or when portions of one state are transferred by conquest to the dominion of another. When the new state of things is established in fact, no matter whether justly or unjustly, it must be recognized by other nations.

With the question of recognition is intimately connected that of non-interference. Premature recognition of a struggling rebellion would be regarded as a breach of the principle of non-intervention, but to recognize the independence of an independent state is part of the same duty as to abstain from interfering with it when it has been established. Writers on international law lay it down as one of the fundamental principles of the science that one state has no right to interfere with the domestic affairs of another. In the formal arrangement of topics it generally appears as one of the necessary consequences flowing from the independence of nations, and Phillimore considers it a self-evident proposition for which it is unnecessary to cite authorities. Nevertheless the practice of nations forbids the doctrine to be stated without limitation. Interference has been sanctioned, according to Phillimore, either in the purely domestic concerns of a nation, or with respect to its foreign relations and territorial acquisitions. The first kind of interference has been justified on the plea of self-defence, as when the decree of the French Convention of 1792, promising aid to all peoples who wished to recover their liberty, was treated as a declaration of war on all existing constitutions. Interference to prevent effusion of blood, or put an end to a state of anarchy from which the interests of other nations necessarily suffer, has also been justified, as when England, France, and Russia interfered between Turkey and its rebellious subjects in 1827. On the whole, the right of intervention has been discredited in international law, and the anomalous condition of the Turkish empire has almost alone in recent times given occasion for its exercise. The ground that reversionary rights of a particular family to the throne of a country justify foreign interference with legislative changes of the succession can no longer be maintained. Nor is it necessary

to discuss any such pretended right as that of putting down new Governments which have established themselves by revolution. The same kind of interference is illustrated by the principle of the balance of power which is thus enunciated by Dr Woolsey—that any European state may be restrained from pursuing plans of acquisitions or making preparations looking toward future acquisitions which are judged to be hazardous to the independence and national existence of its neighbours. According to the same authority, it applies only to European states and their acquisitions in Europe, and does not extend to predominant power on the sea. It is not so much a rule of international law as a maxim of policy which has from time to time united European nations against the dangerous ambitions of one of their number. The “Monroe doctrine” of the United States is of a similar character, being directed against the interference of European states in the affairs of the American continent. The declaration that no European power can be permitted to acquire territory on the American continent is, according to Woolsey, not a principle of the national policy of the United States.

Independent states are said to be equal in international law, because, says Phillimore, it is contrary to the nature of an independent state to be in servitude to another. The proposition negatives any claim of precedence on the part of one or more states in international rank, and asserts that all states equally are entitled to the benefit of international rules. No difference in constitution affects this equality, a republic being the equal of a kingdom, and a kingdom of an empire. Beyond this it can hardly be stretched. It is consistent with conventional inequalities in the reciprocal treatment of nations, and with the habitual recognition in Europe at least of the predominance of the Great Powers. Phillimore deduces from the principle of equality the following rights—(1) the right to protect subjects resident in other countries, (2) the right to recognition, (3) the right to external marks of honour, and (4) the right to enter into treaties. As to the first of these, it may be laid down that a state has cause of complaint if its subjects in foreign countries are denied ordinary justice.

States in relation to the territories occupied by them are treated on the footing of proprietors in law. As between nations each is the absolute owner of its dominions, and the principles applicable to their ownership are taken, as already said, from the Roman law of things. For example, the modes of acquiring territory in international law are said to be four. (1) The first is occupation of land not already occupied (*res nullius*). Mere discovery unaccompanied by beneficial use and occupation will not give a title. (2) The second is prescription or mere possession for a considerable length of time. Jurists on the whole are agreed in admitting this title, although they refrain from attempting to fix a period of prescription. These have been called original modes of acquisition, while secondary or derivative modes are (3) gift, purchase, or treaty, and (4) conquest in war. With reference to these distinctions it may be observed that the overruling consideration is actual possession as a matter of fact. Sovereignty exercised *de facto* over any territory makes it the territory of the sovereign state. This is a deduction of what has already been said on the subject of recognition, and the modes of acquisition here described would only be appealed to in default of such unequivocal possession. In former times a bull of the pope has been set up as a title, *e.g.*, the famous bull of Alexander VI. granting to Spain all lands west of a north and south line drawn a hundred leagues west of the Azores. No such mode of acquisition would now be recognized even by Catholic states. In modern times the acquisition of territory is to some extent governed by the wishes of the inhabitants. As an abstract principle of international

justice, the transfer of territory from one sovereignty to another should be with the consent of the people. But this is not yet a recognized rule of international law, although in many recent cases of acquisition of new territory a certain amount of deference has been paid to it. In the treaty of Prague (1866), in the union of the Neapolitan provinces to the kingdom of Italy, and in the union of Savoy and Nice to France, the rights of the inhabitants to decide on the proposed transfers are expressly reserved. A recent and more painful instance is the annexation of the Transvaal by England under an order in council which authorized the measure if it should appear to be agreeable to the legislature or a sufficient portion of the inhabitants. It is now clear that no such assent was given by the people, while the acting Government of the republic firmly protested against the annexation.

The territory of a state includes all the lands and inland waters within its boundaries, the mouths of rivers, bays, and estuaries, and the sea to the distance of a marine league along the coast. By a fiction vessels on the high seas, and public vessels everywhere, are treated as part of the territory of the state to which they belong. The high seas are no nation's property,—although in the earlier stages of international law exclusive pretensions have been set up to particular seas, as by Spain to the Pacific, England to the seas around Great Britain, and Russia to the North Pacific.

Formal intercourse between nations is carried on under well-ascertained rules. Omitting mere ceremonial regulations, we may notice specially the position assigned by the law of nations to ambassadors. These are the highest class of diplomatic agents, and according to the universal modern practice they are permanently attached to the foreign court to which they are accredited. The earlier practice (*e.g.*, before the Reformation) favoured the appointment of special ambassadors for particular business. The office of ambassador, whether permanent or temporary, has at all times been clothed with a character of peculiar sanctity. His privileges during residence at a foreign court may be summed up in the statement that himself, his house, his property, and his household are exempt from the foreign jurisdiction. Like a ship of war in foreign waters, the embassy is extraterritorial—supposed by fiction of law to be part of the sovereign's dominions. The ambassador therefore is not liable to prosecution in the criminal nor to suit in the civil courts. His official residence is free from the local jurisdiction; but it is no longer an asylum, and a criminal taking refuge there may be seized by the local authority if not delivered up by the ambassador. Ambassadors are further relieved from taxation on goods imported for their own use, a privilege which has not infrequently been abused. An ambassador is entitled to freedom of worship, whether his religion be tolerated by the local government or not. The suite of an ambassador down to his domestic servants are also exempt from the local jurisdiction. The household may in some respects be likened to a separate community under the sovereignty of the ambassador. But it is only in minor affairs that his power to actually execute criminal justice on his own servants would now be recognized. The proper course for him to adopt in a serious charge would be to send the accused home to be tried. The privileges of an ambassador and his suite, it should be added, apply only so far as they do not act beyond the limits of their legatorial character,—*e.g.*, as merchants, trustees, and so on. Exceptional crimes committed by an ambassador do not destroy his character or rights,—at least according to the general consensus of modern authorities, although English lawyers have argued that a crime *contra jus gentium* destroyed the ambassadorial character. Besides ambassadors, two inferior

grades of foreign ministers are recognized, viz., (1) envoys, ministers, or others accredited to sovereigns, and (2) *chargés d'affaires* accredited to ministers charged with foreign affairs. These three grades of diplomatic rank were settled by the congress of Vienna (1815) to avoid the embarrassment arising from claims of precedence. Consuls are merely local agents of a foreign Government, for certain limited purposes, such as facilitating and recording legal transactions affecting the subjects of the state they represent, and assisting them in obtaining their legal rights. They are appointed with the permission (*exequatur*) of the country in which they are to act. They have no immunity from local jurisdiction except under special arrangements. In non-Christian countries the consuls representing Christian states have more extensive functions. In Turkey and the Mahometan countries of the Levant they exercise generally an exclusive criminal and civil jurisdiction over their countrymen.

The contracts made by states with each other are in international law treated according to the general principles of the law of contracts (see TREATIES). Under the modern practice rules of private law affecting foreigners are in many cases settled by treaty on the basis of reciprocity, *e.g.*, extradition, copyright, &c.

Hitherto we have considered nations as in a state of peace. War introduces an entirely new order of rules, applying either between the belligerents themselves or between the belligerents and neutral states. To the question whether a given war be just or unjust international law has no answer to give, or only a formal one. Any war undertaken in defence of the rights which have been already described might be called a just, and any war undertaken in violation of them might be called an unjust war. The justice or injustice of any war is really a question of morality, and in proportion as international law has escaped from the merely ethical region it has abandoned the attempt to decide this question. It figures largely in Grotius, as compared with later writers, and more largely in the speculative than in the positive jurists. One condition of the legality of a war, that of a formal declaration, borrowed from Roman practice by Grotius and some of his followers has ceased to be of any importance, although some publication of the fact of war is considered necessary in fairness to neutrals. But all wars are legal in international law—that is, they are governed by the rules of the law of war—except wars levied by pirates or piratical communities. The part played by international law has been not to prevent but to regulate warfare. Nations have arrived at a tolerable degree of unanimity as to how wars ought to be conducted, and the result is a certain and progressive law of war. They are far from having arrived at any understanding as to the conditions under which war ought to be allowed; when they are within sight of any such understanding, it will be time enough to talk about a war being just or unjust in international law.

The absence of any legal standard of the justice of a war only adds to the importance of the moral question. There being no law of nations to restrain the warlike ambition of nations, as there is to restrain their passions when war has begun, the purely moral restraints become all-important. Among these it might not be worth while to reckon the kind of selfishness which counts the cost of a campaign against a powerful enemy. But a generous horror of war for its own sake may safely be pronounced to be, in spite of recent events, a growing public sentiment, particularly in the English-speaking people of both worlds. There is no English or American statesman who would not at least do lip-service to the principle that an avoidable war is a public crime. Some of them have done more. The great experiment in international arbitration between England



and America in 1871 was more glorious to its promoters, and will be more fruitful of benefit to mankind, than fifty victorious campaigns. It is through the establishment of the principle of arbitration that we may ultimately hope to see the question of justice or injustice in war take its place among the topics of international law.

Short of war, certain preliminary measures of hostility are recognized. These are—"embargo," or the seizure in port of vessels belonging to a foreign nation with which we have a difference, in order to bring it to justice; "retorsion," or retaliating on the foreign nation or its subjects, by similar injuries to those inflicted on us; and "reprisals," or the seizure of foreign property in retaliation for wrongs done to us. These are now of little importance. The right of "pacific blockade," *i.e.*, the blockade of ports belonging to a nation with which we profess not to be at war, has been asserted in a few doubtful instances, but such interference ought to be treated as an act of war.

A state of war transforms the nations engaged into two hostile camps, every man in either being the enemy of all in the other, and entitled to slay and capture as best he can. Such at least is the "natural" theory of war, which international law has reduced to much smaller proportions. First, hostile acts are strictly reserved for the soldiers or others acting under direct public authority; non-combatants are to be regarded as neutrals so far as actual warfare is concerned; they must abstain from hostile acts, and they must be left unharmed by the enemy. Property taken in war belongs to the state, not to the individual captor; and, on the other hand, subject to modifications to be pointed out hereafter, only the property of the state and not private property should be liable to capture. War is thus reduced to an open armed strife between two states carried on by means of a definite and unmistakable set of agents, *viz.*, the fleets and armies. That the non-combatant portions of the two communities should remain as though they were in a state of peace is the principle towards which international law appears to be tending. The movement against privateering is an illustration of this tendency. In wars carried on by land, non-combatants are as far as possible kept out of the sphere of operations,—persons only under public military command being regarded as combatants. In naval warfare it has long been recognized as a valid mode of conducting hostilities to grant "letters of marque" to private vessels, owned, manned, and officered by private persons. Its analogy on land would be a roving commission to private gangs of freebooters. These letters commission the privateers to prey upon the commerce of the hostile nation, the reward for their services being the plunder they may chance to gain. The privateer may belong to a neutral nation or to the nation granting the commission. The practice is defended on the ground that it enables a power having weak naval resources to cope with a great naval power on sudden emergencies. On the other hand the loose discipline of privateer crews, and the fact that their object is simply plunder, are serious evils. The treaty of Paris of 1856 contains the famous declaration that "privateering is and remains abolished," and the adhesion of the United States to this principle would go far to make the practice illegal by the law of nations. Hitherto they have declined, preferring the more comprehensive policy of prohibiting the seizure of private property of all kinds by ships of war. This point conceded, the United States would assent to the abolition of privateering.

Contracts entered into between the subjects of hostile states are void. Rights already created by contracts entered into before the war are not destroyed, but the remedy is suspended, an alien enemy having no redress in courts of law. All commercial intercourse between the two peoples is interdicted, according to the maxim that

there cannot be at the same time "a war for arms and a peace for commerce." Partnerships between a citizen and an alien enemy existing before the war are *ipso facto* extinguished by the war. All nations, in fact, are agreed in pronouncing illegal during a time of war the ordinary commercial intercourse which prevails between them in time of peace. The principle extends to giving one of two allies a right to prohibit intercourse carried on with or without licence by the subjects, of the other with the common enemy. Contracts for the ransom of captured property are valid by the law of nations, but may be and sometimes are restricted by the provisions of a municipal law. And a state may of course grant special licences to its own subjects to trade with the enemy.

The effect of war on the persons and property of alien enemies within the dominions of the state, and on debts due to them by the state or its subjects before the war, has been greatly softened in modern practice. In strict theory the debts and property would be liable to confiscation, and the persons themselves to detention as prisoners of war. Such is the rule laid down by Bynkershoek, but later writers have held that the guarantees to a contrary effect contained in commercial treaties and even in voluntary declarations by belligerent powers have altered the law of nations on this point. This question was expressly decided in an important American case (*Brown v. the United States*), in which the supreme court held that the ancient rule still remained unimpaired as a right recognized by the law of nations, however much it might have been mitigated in practice. In that case, however, its exercise was held to require a special Act of Congress. The confiscation of debts and the confiscation of property seem to stand on the same footing, and in both cases it may be said that the law of nations has not yet formally recognized the rule established by universal practice. The Act of the Confederate Congress in 1861, confiscating all property and debts (except public debts) due to an alien enemy, may be taken as the exception which proves the rule. It has been unequivocally condemned, and was vigorously protested against at the time by Earl Russell as a violation of the spirit of modern law. Even the Confederate Act did not profess to confiscate public debts, and it may be taken as the settled rule of law that no state is justified in repudiating its own public obligations to the subjects of a state with which it may be at war.

The laws and usages of actual war exhibit the same tendency to substitute a milder and more humane code for the unrestrained licence of earlier times. The inspiring idea of Grotius was in fact to introduce the spirit of law into the conduct of hostilities, to enforce the principle that there was a lawful as well as an unlawful way of waging war. Between the time of Grotius and our own the sphere of law in war has greatly widened. No nation claiming to be civilized would now venture to conduct a campaign otherwise than according to the rules of civilized warfare, unless against savages from whom no reciprocal treatment is to be expected, or rebels to whom they refuse the status of belligerents. Besides the influence of international law systematically studied as a science, and the general growth of humaner modes of life and action, a specific cause of this improvement in the law of war is the fact that battle is now for the most part the business of professional soldiers scientifically equipped, and accustomed to stringent discipline. For the best historical view of this interesting subject we may refer to Mr Mountague Bernard's paper "On the Growth of Laws and Usages of War," in the volume of *Oxford Essays* for 1856.

The actual laws and usages of civilized warfare can scarcely be brought within the scope of the present article, but we may refer to a summary of them contained in the

project of an international declaration submitted to the Brussels conference of 1874. The conference did not result in any international convention, and England firmly repudiated portions of the declaration which appeared to be calculated to "facilitate aggressive wars, and to paralyse the patriotic efforts of an invaded people." But on the whole this document, although not accepted into the legislation of nations, expresses their general sense on most of the points with which it deals. It lays down rules with regard to (1) the occupation of a hostile country by military force, (2) the distinction between combatants and non-combatants, (3) the means of injuring an enemy, (4) sieges and bombardments, (5) spies, (6) prisoners of war, (7) sick and wounded, (8) private individuals and private property, (9) contributions and requisitions, (10) flags of truce, (11) capitulations, (12) armistices, (13) belligerents interned or wounded treated in neutral territory. Under the first, second, eighth, and ninth heads the effects of war are restricted to the property of the state and its recognized army, although the necessity of military organization in order to entitle combatants to the rights of war is laid down too stringently. Private property must be respected, and pillage is expressly forbidden, but on the other hand an army of occupation has a right to seize all the personal property of the state which is likely to be of use in war, including any kind of munitions of war although belonging to private individuals or companies. The occupying state is to consider itself in the light of an administrator and usufructuary of the public buildings, &c., of the hostile state. Contributions and requisitions may be imposed on the inhabitants, for which receipts must be given. Under the third head there are forbidden the use of poison or poisoned weapons, murder by treachery or murder of a disarmed enemy, declaration of "no quarter," projectiles causing unnecessary suffering or prohibited by the declaration of St Petersburg 1868, abuse of the flag of truce, and unnecessary destruction of enemy's property; but *ruses de guerre* are permitted. Spies (who collect information on false pretences or secretly in territory occupied by the enemy) shall when captured be tried and treated according to the law of the army which captures them. The bearer of a flag of truce is inviolable unless he abuse his position, but a commander is not bound to receive a flag of truce. Treatment of the wounded is regulated by the Geneva Convention of 1864, and such modifications thereof as may from time to time be made. The English reader will find a copy of the Brussels project in Boyd's edition of Wheaton's *International Law*. The Geneva Convention, to which reference is here made, was an international compact between the European states, establishing the neutrality of ambulances and military hospitals, and of all persons engaged in the service thereof, as well as of inhabitants of the country bringing help to the wounded. The hospitals, &c., shall bear a distinctive flag (red cross on white ground), and badges similarly distinguished shall be allowed for individuals entitled to the benefits of neutrality. The St Petersburg declaration renounces for the contracting parties in case of war among themselves the use of "any projectile of a weight below 400 grammes, which is either explosive or charged with fulminating or inflammable substances."

War by land is necessarily carried on within the territory of one or other of the belligerents, and generally in the midst of surroundings devoted to the permanent works of civilization and peace. Naval warfare is a duel between two sets of "floating fortresses," on an element which is no nation's exclusive property, and in no nation's continuous possession. This is the principal reason for the superior humanity characterizing the rule of war on land, where the licence of primitive warfare would be infinitely more disastrous than it would be at sea. Another reason why

the law of the sea retains so much of its original severity is that its rules have been developed under the influence of a regular court and a professional bar, and have acquired the fixed and inelastic character peculiar to positive law. The toleration of privateering already noticed is an example of the difference between the two systems, and the practice of bombarding seaports to enforce contributions is another. The liability of private property to capture is, however, the most important point of difference. The public vessels of the enemy are of course the natural prey of our own. The private property of the enemy may be contained either in private vessels of his own or in the ships of neutral powers, and we may add for the sake of convenience a third case, where the private vessels of the enemy carry goods belonging to neutral owners. In the last case, when the hostile vessel has been captured, the neutral property is not affected thereby—*enemy ship* does not make *enemy goods*. In the second case the treaty of Paris has promulgated the rule that *free ship* makes *free goods*, which may now be regarded as the established modern rule. In the first case ship and cargo alike are the prey of our vessels of war. In the result, therefore, we may capture the enemy's ships and the enemy's property on board his own ships, but we must spare neutral vessels and all the goods therein, whether belonging to enemies or neutrals, and neutral goods when found on board the enemy's vessels. There is, however, a manifest tendency in international opinion to withdraw private vessels and private property lawfully used altogether from the sphere of warlike operations. The law of capture by sea is further considered under the heading PRIZE.

It remains to speak of the right of neutrals, and their obligations to the belligerents. The neutral nation is to be regarded as the friend of both belligerents, and is bound to treat both of them alike. Jurists distinguish between "strict" or "ordinary" neutrality, and "imperfect" neutrality, in which certain advantages are allowed to both belligerents, or in which advantages are granted to one of the belligerents only under a prior treaty, which the other belligerent does not choose to consider a *casus belli*. The "perpetual" neutrality of Belgium and Switzerland secured by treaties binds those states to abstain from taking part in any war arising between their neighbours. The combination of several northern powers to enforce by arms certain alleged rights of neutrals against the claims of belligerents in 1780 and 1800 has been termed an "armed neutrality."

Neutral states are entitled to prohibit all belligerent operations within their territory,—using that phrase in the enlarged sense it bears in international law. They may prevent the passage of fleets or armies through those portions of the sea or land over which their jurisdiction extends. Hostilities carried on within neutral territory are unlawful, and captures effected thereby are void. The rule is indisputable, but its application to warfare by sea has not been free from controversy. A capture made outside the neutral territory by the boats of a ship lying within the neutral territory has been held to imply an illegal use of that territory for purposes of war. On the other hand, a capture begun outside but consummated within the neutral territory, is also, notwithstanding the theory set up by Byunkershoek, entirely illegal. It is in fact as much the duty as the right of the neutral state to insist on these prohibitions, as the omission to do so in any case might give an advantage to one belligerent over the other inconsistent with true neutrality. The exemption of neutral property everywhere from the operation of war has been already noticed. The impartiality which it is the duty of the neutral to observe towards the belligerents has been summed up by Vattel in two propositions cited with approval by Wheaton:—(1) that no assistance should be given to either party in matters relating to war unless under some pre-existing



stipulation; (2) that in matters not relating to war the neutral should not refuse to one belligerent "merely because he is at war with the other what she grants to that other." The obligation of impartiality extends to prohibiting the use of the neutral territory for the purpose of fitting out warlike expeditions, equipping vessels, and enlisting men. The right and duty of neutral nations in this respect were first recognized and enforced by the United States, long the chief representative and champion of neutral rights. An Act of Congress passed in 1794, reenacted 1818, makes it a misdemeanour for "any person within the jurisdiction of the United States to augment the force of any armed vessel belonging to one foreign power at war with another power with whom they are at peace, or to prepare any military expedition against the territories of any foreign nations with whom they are at peace, or to hire or enlist troops or seamen for foreign military or naval service, or to be concerned in fitting out any vessel to cruise or commit hostilities in foreign service, &c." The same principles inspire the English Foreign Enlistment Acts which have been pronounced by the well-known writer "Historicus"<sup>2</sup> to be a transcript of the American law. The 59 Geo. III. c. 69 was the first Act known by this title; the statute now in force is the Foreign Enlistment Act, 1870 (33 & 34 Vict. c. 90). These Acts are correctly described as municipal statutes, based indeed on international law, but intended for the protection of the neutral state rather than the belligerents.<sup>3</sup> The purely international obligations of the belligerent have been recently the subject of protracted discussions between England and America, arising out of the depredations committed by Confederate cruisers on American commerce. The treaty of Washington, 1871, by which all these questions were referred to arbitration, directed the arbitrator to apply to them not only the rules of the law of nations but three new rules, which England at least could not admit as being in force when the claims arose, but which she acceded to as an evidence of her desire to strengthen friendly relations with the United States. Both parties agreed to abide by these principles in future, and to invite other nations to accede to them. The rules were that a neutral government is bound—(1) to use due diligence to prevent the fitting out, arming, or equipping within its jurisdiction of any vessel which it has reasonable ground to believe is intended to cruise or to carry on war against a power with which it is at peace, and also to use like diligence to prevent the departure from its jurisdiction of any vessel intended to cruise or carry on war as above, such vessel having been adapted in whole or in part within such jurisdiction to warlike use; (2) not to permit or suffer either belligerent to make use of its ports or waters as the base of naval operations against the other, or for the purpose of renewal or augmentation of military supplies or arms or the recruitment of men; and (3) to exercise due diligence in its own ports and waters and as to all persons within its jurisdiction, to prevent any violation of the foregoing obligations and duties.

These rules, which we believe to be substantially just, have been unduly discredited in England, partly by the result of the arbitration, which was in favour of the United States, partly by the fact that they were from the point of view of English opinion *ex post facto* rules, and that the words defining liability ("due diligence") were vague and open to unforeseen constructions,—for

<sup>1</sup> Phillimore considers that such stipulations made in time of peace are wrongful and incompatible with sound neutrality. The fulfilment of them would be an attempt to do the act of a belligerent and yet claim the immunity of a neutral.

<sup>2</sup> Sir William Vernon Harcourt.

<sup>3</sup> *Letters on some Questions of International Law*, by Historicus, "On belligerent violations of neutral rights."

example, the construction actually adopted by the Geneva tribunal that due diligence ought to be exercised in proportion to the belligerent's risk of suffering from any failure of the neutral to fulfil his obligations.<sup>4</sup> One important principle, to some extent challenged in these controversies, is established beyond dispute. Whatever the obligations of a neutral in any given case may be, failure to fulfil them is not excused either by defects of the municipal law or by successful evasions of that law. The neutral state ought to make its laws conformable to its international duties, and to compel its subjects to obey them. If it fails in either respect, and injury to belligerents is the consequence, it is answerable under the law of nations.

So far we have been dealing with the rights and duties of neutral states. Neutral commerce in times of war is subject to restrictions which affect individuals rather than states, such as the rules relating to blockade and contraband of war.

Pirates and savages or uncivilized tribes have been mentioned as excluded from the benefits of international law. The municipal law of most countries assumes jurisdiction over the former wherever they may be found (see PIRACY). With regard to the latter, it cannot be said that civilized nations have observed any rule of law or morality whatsoever in their dealings with them. The overflowing population of European nations has been compelled to seek an outlet in regions occupied by men in a low state of civilization, neither capable nor desirous of making a beneficial use of them. It is not to be pretended for a moment that the Europeans were bound to leave the continent of America to its original Indians, for even civilized communities are not permitted to claim dominion over territory which they do not really occupy. But the early European settlers founded their claims on some authority, generally that of their own sovereigns, which recognized no right whatever in the original occupants. They were described in patent deeds as "heathens and infidels," and a colour of religious duty was thus imparted to the most barefaced schemes of spoliation. Wheaton cites the authority given by Henry VII. to Cabot and by Queen Elizabeth to Sir Humphrey Gilbert to seek out foreign and barbarous lands "not actually possessed of any Christian prince or people," and to hold, occupy, and enjoy the same. Vattel, who strongly insists upon the right of civilized people to reduce the ineffective occupation of savages to the narrowest possible limits, warmly commends the conduct of William Penn and the English Quakers in purchasing from its savage occupants the country they wished to inhabit. The colonizing nations, says Wheaton, were agreed in one thing, viz., in "almost entirely disregarding the right of the native inhabitants." Settlements of this kind are not now made from European countries, and public opinion would no longer sanction the pretensions on which they were based. But between the European settlements already established and the native tribes by which they are surrounded the same disregard of the rights of the weaker party is only too common. So far as England is concerned, the temptations of her colonists to commit injustice in their dealings with inferior races are counterbalanced by an active public opinion at home. In the conduct of hostilities against savages, civilized troops would not be regarded as bound by the international law of war; and it is difficult to conceive of any restraint other than that of their own sense of decency and humanity. In conflicts between civilized communities the employment of savages on either side is condemned for this very reason. In self-defence the troops opposed to them must resort to practices condemned by the opinion of the civilized world.

<sup>4</sup> See Mountague Bernard's *British Neutrality*.

The main object of this article has been to exhibit the law of nations as much as possible in the form of a positive system of rules binding on states *inter se*, to assimilate the treatment of the subject to a statement of the ordinary rules of positive law. Many topics have therefore been omitted which are discussed at length in treatises on international law. It is not always possible to say where international law begins and international morality ends, but it is of the highest importance to mark the distinction. The former, taken broadly, means the rules of conduct that the nations of the civilized world admit and insist upon as a matter of course, and the fact that there are such rules is the central fact of the whole subject. Every addition to them is a positive good to the whole world, and such additions are for the most part to be traced to the reasonings of private thinkers. But to treat principles supported only by the authority of jurists, however distinguished, as of equal validity with those which have been adopted by the universal practice of nations is to weaken the one without strengthening the other. It should be said, moreover, that the systematic study of international law with a view to its improvement by jurists of all countries organized in societies like the *Institut de Droit International* at once tends to mature opinion and to give it an immediate hold on the practice of nations.

Among the purely speculative questions connected with international law two deserve special notice on account of the extent to which they have engaged the sympathies at least of the best minds in every age. One is the project for a perpetual peace, the other is the more immediately practical proposal to reduce the law of nations to a written code. With the former the names of Bentham and of Kant are associated. Bentham's plan is a congress of deputies, two from each state, which should determine international disputes, and the decrees of which should be enforced against any state that might resist them by the combined power of the rest. As a preliminary condition he requires the reduction of military establishments and the abandonment by European nations of their colonies. Kant proposes a confederation of states, all under a republican constitution, and acting in international affairs through congresses to be held from time to time. An account of these and other projects of the same kind will be found in Wheaton's *History of the Law of Nations*. Codification would effect for the law of nations, as a whole, what has already been done for portions of it by the St Petersburg and Geneva conventions, and even by the treaties of Paris and Washington. All states are alike interested in ascertaining the rules to which they have assented in general terms. The work has already been to a great extent performed by private associations, and what is wanted is the formal ratification of their labours by the Governments of the world.

The following are the most authoritative modern works on International Law:—Henry Wheaton's *Elements of International Law* (8th American edition published in 1866 with notes by R. H. Dana, jun.; an English edition appeared in 1880); Sir Robert Phillimore's *Commentaries on International Law*, in 4 vols. (a very complete and elaborate work); Sir Travers Twiss's *Law of Nations*, 2 vols.; and Heffter's *Das Europäische Völkerrecht der Gegenwart*. To these may be added the less important treatises of Richard Willman, William Oke Manning, and H. W. Halleck (American). Useful elementary works are Chancellor Kent's *Commentary*, which has been edited in England by Dr J. T. Abdy; T. D. Woolsey's *Introduction to the Study of International Law*; and W. E. Hall's *International Law*. The history of the law of nations has been treated by Wheaton, Ward, K. von Mohl, and F. Laurent.

(E. R.)

INTERPLEADER, in English law, is the form of action used when a person is sued at law for the recovery of money or goods wherein he has no interest, and which are also claimed of him by some third party. Originally the only

relief available to the possessor against such adverse claims was by means of a bill of interpleader in equity. The Interpleader Act, 1 & 2 Will. IV. c. 58, enabled the defendant in such cases, on application to the court, to have the original action stayed and converted into a trial between the two claimants. The Common Law Procedure Act of 1860 further extended the power of the common law courts in interpleader; and the Judicature Act, 1875, enacts that the practice and procedure under these two statutes shall apply to all divisions of the high court of justice. The Judicature Act also extends the remedy of interpleader to a debtor or other person liable in respect of a debt alleged to be assigned, when the assignment is disputed. Interpleader is the equivalent of multiplepoinding in Scotch law.

INTESTACY. In dealing with the property of a person who dies without making a will, the law of England distinguishes sharply between his real and his personal estate. The devolution of the former is regulated by the rules of INHERITANCE (*q.v.*). The destination of the latter is marked out by the Statute of Distributions. The proper conditions of a testamentary disposition of property will be found under the heading WILL.

The distribution of an intestate's personal estate is carried out under the authority of administrators, whose duties are generally the same as those of executors under a will. Administration was until quite recently a matter cognizable by the ecclesiastical courts, and the ordinary was in fact the administrator until the passing of the 31 Edw. III. st. i. c. 11. An earlier statute (Westminster 2) directed against the abuses of the system required the ordinary, instead of applying the residue of the estate to "pious uses," to pay the debts of the intestate. The Act of Edward III. went further in providing that "in case where a man dieth intestate, the ordinaries shall depute of the next and most lawful friends of the dead person intestate to administer his goods," with power to sue for debts due to the deceased, and under obligation to pay debts due by him, and to answer to the ordinary like executors in the case of testament. Administrators remained on this footing of deputies appointed by the ordinary until the Probate Act transferred the jurisdiction in administration of the ecclesiastical courts to the new court of probate.

The courts of law having held that by the grant of administration the authority of the ecclesiastical courts was exhausted, the administrator became entitled to the privilege, similar to that formerly enjoyed by the ordinary, of dealing as he pleased with residue of the estate. The next of kin of the same degree of relationship with the deceased were thus aggrieved by the preference of the administrator, and it was to remedy this grievance that the Statute of Distributions (22 and 23 Charles II. c. 10) was passed. It empowered the ordinary to take a bond from the administrator binding him to make a fair and complete distribution of the estates among the next of kin. Such distribution is to be in the following manner:—one-third to the wife of the intestate, and all the residue by equal portions to and amongst the children, and their representatives if any of such children be dead, exclusive of children who shall have any estate by the settlement of the intestate, or shall be advanced by the intestate in his lifetime by portions equal to the shares allotted to the other children under the distribution. If such advancement should be less than the share of the other children in distribution, then it shall be made equal thereto. But the "heir-at-law, notwithstanding any land that he shall have by descent or otherwise from the intestate, is to have an equal part in distribution with the rest of the children" (§ 5). By § 6, if there be no children nor any legal representatives of children, one moiety of the estate



is to be allotted to the wife of the intestate, the residue "to be distributed equally to any of the next of kindred of the intestate who are equal in degree and those who legally represent them." By § 7 there shall "be no representation admitted among collaterals after brothers' and sisters' children; and in case there be no wife, then all the said estate to be distributed equally to and among the children; and in case there be no child, then to the next of kindred in equal degree of or unto the intestate and their legal representatives as aforesaid, and in no other manner whatsoever." For the protection of creditors it is enacted that there shall be no distribution till a full year after the intestate's death, and if any debts should be discovered after distribution, the persons sharing the estate shall refund the amount of the same ratably. Finally, by § 4 it is provided that nothing in the Act shall prejudice the customs of London, York, and other places having customary rules of succession; but these have been since abolished.

With reference to the above rules the following points may be observed:—(1) The husband's absolute right to administer his wife's estate is not affected by the Act. This was made clear by a later Act of the same reign (29 Charles II. c. 3). Administration is now granted to the representatives of the husband, where he has died without taking out administration to his wife, unless it can be shown that the wife's next of kin are beneficially interested. (2) The widow, in the event of there being no children or next of kin, takes only her half. The other half goes to the crown. (3) The child or children take equally two-thirds if the widow be alive, and the whole if she be dead. If the children of the intestate be all dead, the grandchildren will take equally amongst themselves as next of kin; if there be neither child nor grandchild alive the great-grandchildren would likewise take equally as a class (*per capita*). But if some of the children be alive, some dead leaving issue, the children of a deceased child take their father's share (*per stirpes*). Thus, for example, the ten children of a deceased son would only take between them their father's share if any brother or sister of their father were alive; if not, they would share equally with the other grandchildren. (4) The next of kin must be ascertained according to the rules of consanguinity, which are the same in English as in the civil law. Degree is calculated from the intestate, through the common ancestor if any, to the kindred. Thus from son to father is one degree, to grandfather two degrees, to brother two degrees, to uncle three degrees, and so on. The statute ordains distribution to be made "to the next of kindred in equal degrees *pro suo cuique jure*, according to the laws in such cases and the rules and limitations hereafter set down." Equality in degree is limitation not in all cases accompanied by equality in rights of succession. Neglecting the cases of wife and children already noticed, the father excludes all other next of kin. So would a mother, in default of a father surviving, but the Act 1 James II. c. 17 enacted that in such a case the brothers and sisters of the intestate should share equally with the mother. The language both of this and of the principal statute is very inapt, and has given rise to complicated questions of interpretation. In the absence of brothers or sisters and their representatives, the mother in the case supposed would take the whole. Mothers-in-law and stepmothers are not within the rules of consanguinity. As between a brother and a grandfather who are both in the second degree, preference is given to the brother; but a grandfather, being in the second degree, will exclude an uncle, who is in the third. An uncle and a nephew, both being in the third degree, take together. Brothers or sisters of the half blood take equally with brothers and sisters of the whole blood. The rule which prohibits

representations after brothers' and sisters' children would, in a case where the next of kin were uncles or nephews, wholly exclude the children of a deceased uncle or nephew. Also, as between the son of a brother and the grandson of a brother, the latter would not be admitted by representation. Where a brother and the children of a deceased brother are the next of kin, they will take *per stirpes*, i. e., the brother will take one half, and the children of the other brother will take the other half between them. When the next of kin are all children of the deceased brothers or sisters, they will take equally *per capita*. Subject to these modifications, the personal estate will be divided equally among the next of kin of equal degree, e. g., great-grandfathers would share with uncles or aunts, as being in the third degree. Failing next of kin, under these rules, the estate goes to the crown as *ultimus hæres*, a result which is more likely to happen in the case of illegitimate persons than in any other.

Personal or movable property takes its legal character from the domicile of the owner, and the distribution of an intestate's goods is therefore regulated by the law of the country in which the intestate was domiciled. A domiciled Scotchman, for example, dies intestate in England, leaving personal property in England; the administrator appointed by the court of probate will be bound to distribute the estate according to the Scotch rules of succession.

In the law of Scotland the free movable estate of the intestate is divided amongst the nearest of kin, the full blood excluding the half blood, and neither mother nor maternal relations being originally admitted. The heir of the heritable property if one of the next of kin must collate with the next of kin if he wishes to share in the movables. Proximity of kin is reckoned in the same order as in the case of inheritance. The Intestate Movable Succession Act, 1855, among other changes, allows the issue of a predeceasing next of kin to come in the place of their parent in succession to an intestate, gives the father of an intestate dying without issue one-half of the movable estate in preference to brothers and sisters, and to the mother if the father be dead a similar preference to the extent of one-third, and admits brothers and sisters uterine in the absence of brothers and sisters german or consanguinean.

In the United States the English Statute of Distribution has been taken as the basis of the law for the distribution of personal property in intestacy, and its principles have been applied to real property also. "In a majority of the States the descent of real and personal property is to the same persons and in the same proportions, and the regulation is the same in substance as the English Statute of Distribution. In Georgia the real and personal estate of the intestate is considered as altogether of the same nature and upon the same footing. . . . The English Statute of Distribution, being founded on justice and on the wisdom of ages, was well selected as the most suitable and judicious basis on which to establish our American law of descent and distribution." See INHERITANCE. (E. R.)

INVERARAY, a royal, parliamentary, and municipal burgh of Scotland, the county town of Argyllshire, is situated at the lower end of a small bay, where the river Aray falls into the north-western waters of Loch Fyne, 40 miles north-west of Glasgow. The town is small, consisting of one street running east and west, and a row of houses facing the bay. The county buildings and courthouse are handsome edifices. Near the church stands a small obelisk in memory of certain members of the clan Campbell who were executed on the spot in 1685 for preaching against Popery. The ancient market-cross, supposed to have been brought from Iona, is a fine specimen of the Scottish sculptured stones. The chief industry of Inveraray is the herring-fishery, the herring of Loch Fyne being celebrated for their excellence. To the fishing "district" of Inveraray there belonged in 1879 690 boats, 1647 fishermen and boys, and fishing-gear to the value of £31,592. In the district, or in boats fishing off its coast, 33,837 barrels of herring and 86 cwt. of cod and ling were cured in 1879. The town originally stood on the north side of the bay, clustering round the ancient baronial hold, attributed to Colin the Singular, who flourished

at the end of the 14th century, but it was removed to its present site in the middle of the 18th century. Inveraray was erected into a burgh of barony in 1472; and Charles I., while a prisoner in Carisbrook Castle, raised it to a royal burgh in 1648. It is governed by a provost and council. Much has been done for Inveraray by the ducal house of Argyll, whose seat, Inveraray Castle, is a quarter of a mile to the north. This handsome square edifice, built between 1744 and 1761 and restored 1879-80, consists of two stories and a sunk floor, with round overtopping towers at the four corners. Many interesting and valuable relics were destroyed by a fire in 1877. The population of the royal burgh in 1871 was 984, and in 1881 it was 939.

INVERNESS, a maritime county of Scotland, is situated as to its mainland portion between 56° 38' and 57° 36' N. lat. and 3° 27' and 5° 54' W. long., and is bounded on the N. by Ross, N.E. by Nairn and Elgin, E. by Banff and Aberdeen, S.E. by Perthshire, S. by Argyll, and W. by the Atlantic. It measures 85 miles from north-west to south-east and 55 miles from north-east to south-west. The total area is 2,723,840 acres or 4256 square miles. The mainland portion has an area of 1,947,520 imperial acres or 3043 square miles, of which 86,400 acres or 135 square miles are under water. The area of the islands is 776,320 acres or 1213 square miles, of which the area under water is 39,040 acres or 61 square miles.

The surface of the county is very varied, consisting of ranges of lofty mountains alternating with deep narrow valleys, the beds of numerous lakes and rivers. Its exterior outline is very irregular. On the north-east a narrow tract runs out between Nairnshire and the Moray Firth. Further to the south-east a portion of it was detached till 1870, when by Act 33 & 34 Vict. c. 16 this and a similarly detached portion of Elgin were interchanged. Argyllshire penetrates it from the south-west, and Ross-shire from the north-west, while the western coast is indented by Lochs Moidart, Aylort, Nevis, Hourn, and other arms of the sea. Both the mainland and island portions abound in grand and picturesque scenery. The islands in the county are those of the Outer Hebrides (excluding Lewis, which belongs to Ross-shire, but including Harris), and Skye, Raasay, Rona, Scalpa, Eigg, &c. (see *HEBRIDES*). The mainland portion is divided into two nearly equal parts by the valley of Glenmore, or the Great Glen, which crosses it from the south-west to the north-east. This glen is now traversed by the Caledonian Canal, which, begun in 1803 and finally completed in 1847, at a total cost of £1,300,000, forms a line of inland navigation between the east and west seas, from the Moray Firth on the north-east to Loch Linnhe on the south-west. It has a length of 60½ miles, including about 37 miles of lakes, namely, Loch Ness with a length of 23 miles, Loch Oich of 4, and Loch Lochy of 10. On each side of this valley there are numerous glens and straths, separated by mountain ridges, and displaying, with their lakes and rivers, a great variety of beautiful scenery. The western half of the county is the more wild and mountainous. Its principal divisions are Moidart, Arisaig, Morar, Knoidart, and Glenelg, with the glens or valleys of Glengarry, Glenmoriston, Glenurquhart, and Strathglass. Among the numerous lakes in this portion of the county are Loch Shiel bordering on Argyll, Loch Arkaig, Loch Morar, Loch Quoich, and Loch Garry. The eastern half of the county comprises the extensive district of Badenoch, south-west of which lies Lochaber, and to the north the Aird. The principal valleys are Glenroy, Glen Spean, Strathspey, Stratherrick, Strathdearn, and Strathmairn; and Loch Erich on the borders of Perthshire, Loch

Treig, Loch Laggan, Loch Inch, and Loch Ouchan are among the largest lakes. The greater part of the county is occupied by mountains, many of which are over 3000 feet in height, the highest summits being Ben Nevis, 4406 feet, and Cairngorm, which is partly in Banffshire, 4095 feet. The principal rivers are the Spey, the Findhorn, and the Nairn, which flow in a north-easterly direction into the Moray Firth; the Ness, which issuing from Loch Ness flows north-eastwards, passing through the town of Inverness, and falls into the Moray Firth after a course of 6 miles; the Lochy, which flows south-westwards from Loch Lochy, and after a course of 10 miles falls into Loch Eil near Fort William; and the Beauly in the north of the county, which, after being joined by the Glass and two smaller streams, falls into the Beauly Firth. The small river Foyers, which flows northwards into Loch Ness, forms near the loch two beautiful falls, the one 30 and the other 90 feet in height.

Like the greater part of the Highlands of Scotland, Inverness-shire rests on the Old Laurentian gneiss. The Old Red conglomerate is found in Glenmore and along the sea-coast. Granite, gneiss, limestone, slate, marble, and brick-clay abound in many parts. The general direction of the rocks is from south-west to north-east. The upper part of Ben Nevis is composed of beautiful porphyry. Lead has been found on Ben Nevis and in Glengarry, but is not worked. Silver and iron ore have also been met with in small quantities. The want of coal renders the limestone of little value. On account of the irregular surface the climate of Inverness-shire is very diversified, and in many parts it is very unfavourable for the prosecution of agriculture.

According to the agricultural returns for 1880, the total area of arable land was 126,306 acres, or 4·6 per cent. (4·2 in 1870), of which 39,584, or 1·5 per cent. (1·4 in 1870), were under corn crops, 19,513, or 0·7 per cent. (0·7 also in 1870), under green crops, 27,155, or 1·0 per cent. (0·9 in 1870), under rotation grasses, 39,140, or 1·4 per cent. (1·2 in 1870), under permanent pasture, and 914 fallow. There were 160,656 acres under wood. Within the last twenty-five years great progress has been made in the reclamation of waste land, the arable land in 1855 extending only to 42,030 acres. There are nearly 300,000 acres of deer forests, and about 1,700,000 of heath land, one half of which affords pasturage for sheep, the other half being of no value except for grouse shooting. From the trees found in great numbers in the peat-bogs of the county it would appear to have been at an early period thickly covered with wood. Strathspey is still celebrated for its great forests; and the natural woods on Loch Arkaig, in Glengarry, Glenmoriston, Strathglass, Strathfarrar, and at the head of Loch Shiel are also very extensive. The forests consist chiefly of oak, fir, birch, ash, mountain ash, holly, elm, hazel, and Scotch poplar. There are also extensive plantations of larch, spruce, silver fir, beech, and plane. Part of the great Caledonian forest extends for several miles near the Perthshire boundary. The most unproductive portion of the county is that to the north-west of the Caledonian Canal, although it includes several patches of highly cultivated land. In the low districts surrounding the county town the soil and climate are both excellent, and good crops of all kinds are raised, which are not much later in reaching maturity than in the earlier districts of Scotland. The soil of the Badenoch and Laggan districts is generally good, but the climate is very uncertain, and much injury is often caused by early frosts. In many districts the grain in late seasons never reaches full maturity. In the whole of the Western Isles the soil is generally poor and the moist climate renders it very difficult to secure the crops in good condition.



The number of holdings in June 1880 was 6142. Of these there were 5616 of 50 acres and under, with a total extent of 47,772 acres; 248 were between 50 and 100 acres, total 17,407 acres; 237 between 100 and 300 acres, total 39,746 acres; 30 between 300 and 500 acres, total 11,498 acres; 9 between 500 and 1000 acres, total 6029 acres; and 2 above 1000 acres, total extent 4057 acres. Considerable enterprise has been shown in many districts in the improvement of land, and on the larger farms the best modern implements of husbandry are in use. The crofter system has very much decreased on the mainland, and some of the crofters now have leases of five, ten, or fourteen years, and have largely increased their cultivated holdings by reclamation. On the larger farms a nineteen years' lease is almost universal, and a five-shift course of cropping is the most common. Large numbers of admirable farm steadings have been erected within late years, and considerable progress has been made in the construction of suitable cottages for married servants. The acreage under wheat has been decreasing very much within late years: the area sown in 1878 was 352 acres, in 1879 only 82, and in 1880 146, while in 1855 it was 1539 acres. The best quality raised has always been that of the Aird and Beaully districts. Barley and bere were grown on 7855 acres in 1880 instead of 2220 in 1855. Much good barley is produced in the middle districts, such as Strathspye, Strathairn, Strathglass, and Glenurquhart. Bere is grown mostly in the late districts and in the Western Isles. Most of the barley is manufactured into whisky in the county. Oats occupy more than three-fourths of the area under grain,—30,714 acres in 1880, instead of 13,704 in 1855. A considerable portion of this crop is of a light and inferior quality, the best being that produced on heavy clay land. There is a considerable area under rye, 814 acres in 1880 as compared with 125 in 1855. It is grown chiefly on the sandy hills south and east of Inverness. Under beans and pease there were in 1880 only 13 and 35 acres respectively. The extent under turnips and Swedes in 1880 was 11,084 acres, the proportion under Swedes being about one-sixth. Artificial manure is extensively used for the turnip crop, and on many soils the yield is very heavy. Potatoes were grown on 8252 acres in 1880. The dry soil in many parts of the country is well adapted for this crop, and on the more extensive farms they often constitute a large item in the farmer's profits.

The number of cattle in 1880 was 51,287 (24,061 in 1855), or an average of 40·5 to every hundred acres under cultivation, the average for Scotland being 23·2, and that for the United Kingdom 20·7. Of these the number of cows and heifers in milk or in calf was 22,208, and the number under two years of age 21,673. The principal breed is the Highland, the largest and best herds of which are in the Western Isles. There are a few of the polled and shorthorn breeds, and Ayrshire cows have in many places been introduced for dairy purposes. Crosses of an indefinite description are numerous in the lowlands, but in many places their quality has been improved by the use of polled or shorthorn bulls. The number of horses in 1880 was 8935 (3485 in 1855), or 7·0 to every hundred acres under cultivation, the proportion for Scotland and also for the United Kingdom being 4·1. Large numbers of Highland ponies are raised on the hill farms. The breed of agricultural horses, which in 1880 numbered 6758, has been much improved by the introduction of Clydesdale stallions. The sheep numbered 711,910 in 1880 (567,694 in 1855), or 563·7 to every hundred acres under cultivation, the proportion for Scotland being 149·3 and for the United Kingdom 63·5. The majority are either Cheviots or blackfaced, of which the numbers are about equal, Cheviots having been for some time on the increase. Leicesters and half-breeds are kept in several of the lower districts of the country. The number of pigs in 1880 was 2897 (1667 in 1855), an average of 2·3 to every hundred acres under cultivation, the average for Scotland being 2·6 and that for the United Kingdom 6·0. Not much attention is paid to the character of the breed, especially by the crofters, who rear this stock chiefly for domestic consumption.

According to the *Returns of Owners of Lands and Heritages*, 1872-73, the land was divided among 1867 proprietors; its gross annual value was £361,848, 5s, and the average value of the whole 2s. 9½d. per acre. Of the owners 83½ per cent. possessed less than 1 acre. There were no fewer than thirty proprietors owning more than 20,000 acres, while nineteen possessed upwards of 50,000 acres each, and an aggregate of nearly 1,900,000 acres—viz., Lord Lovat, 161,574; Earl of Seafield, 160,224; Macleod of Macleod, 141,679; Evan Baillie, 141,148; Lord Macdonald, 129,919; The Mackintosh, 124,181; Donald Cameron of Lochiel, 109,574; Sir G. Macpherson Grant, 103,372; Edward Ellice, 99,545; The Chisholm, 94,328; John Gordon of Cluny, 84,404; Sir John P. Orde, 81,099; Trustees of J. M. Grant, 74,646; Mrs Campbell, 74,000; Colonel George G. Walker, 70,940; Sir John W. Ramsden, 60,400; Earl of Dunmore, 60,000; James Baird, 60,000; Edward H. Scott, 59,123.

Salmon yield a considerable rent on the rivers Lochy, Beaully, and Ness, and are found also in other streams and in several of the lochs. Red and roe deer, the alpine and common hare, black game and ptarmigan, grouse, partridges,

and pheasants tenant the moors and woodlands. Foxes and wild cats are found, and otters are to be met with in the lakes and rivers. There are also eagles, hawks, and owls, and great numbers of waterfowl, particularly swans, resort to Loch Inch and the other lakes of Badenoch.

The manufactures of the county are unimportant. At Inverness there are two woollen manufactories, two breweries, and a distillery. The principal distilleries are Ben Nevis distillery near Fort William, Ord distillery near Beaully, Carbost distillery in Skye, and two in the neighbourhood of Kingussie. There are flour mills in various parts of the county, and artificial manure is manufactured at Kirkton near Inverness.

The Highland Railway traverses the eastern corner of the county, and enters it again near Campbeltown, skirting its northern shore by Inverness and Beaully.

The only royal burgh is Inverness, the county town. The principal villages are Beaully (population 995), with some shipping trade; Campbeltown (831), frequented as a bathing-place, and possessing a chalybeate spring; Fort William (1562), near Ben Nevis, with herring and salmon fisheries; Kingussie (645); and Portree (893), in the Isle of Skye, having considerable export trade in cattle, sheep, and fish. The population of the county, which was 88,261 in 1861, and 87,531 in 1871, was found in 1881 to be 90,114 (43,785 males and 46,629 females). The maximum population was reached in 1841, when it was 97,799. In 1801 it was 72,672. The county returns one member of parliament; and the burgh of Inverness unites with three others in returning a second.

At an early period Inverness was included in the kingdom of the Northern Picts, its mainland portion forming part of the provinces of Moravia and Arguthecla. The latter province with the islands subsequently became the possession of the Norwegians, but was afterwards known as Ergadia, and was divided into three portions, Ergadia Borealis, Ergadia que ad Moraviam pertinet, and Ergadia que ad Scotiam pertinet. For some time the capital of the Pictish kings was at Inverness in Moravia. The province was for a considerable period ruled by theormaers of Moray, one of whom was the well-known Macbeth. The last of theseormaers was defeated by David I. Early in the 13th century the province, which up to that time had been included under one sheriffdom, was divided into the sheriffdoms of Inverness, Elgin, and Nairn.

Among the antiquarian remains of Inverness-shire are a large number of the so-called Druidical circles, especially in the northern part of the county. At Inshes, 2 miles from Inverness, there are remarkable cromlechs; and at Clava near Culloden there are large remains of old chambered sepulchres. Numerous traces exist of ancient pit dwellings similar to those of the Picts but of inferior masonry, and there are remains of crannogs or old lake dwellings at the Loch of the Clans and Loch Beaully. Two examples of the old Pictish towers still exist at Glenelg in a state of almost perfect preservation, and there are others in Glenmore and elsewhere. Among the vitrified forts the principal are those on the hill of Craig Phadraig, with ten others stretching into the interior; Dundbhardghall on Ben Nevis; and Dun Fhion or Fingal's fort on the top of a conical hill near the river Beaully. The principal examples of other ancient fortresses are Castle Spynie, an extensive ruin on a hill about 700 feet above the plain and 2 miles east from the church of Beaully, and the remains of massive fortifications on the summit of a steep hill in the parish of Laggan. Among the old castles may be mentioned Urquhart castle, besieged and taken by the officers of Edward I. in 1303, and Inverlochy castle near Fort William. The county formerly contained three military forts. Of these Fort George, on the Moray Firth, 12 miles east of Inverness, built in 1747-67, at a cost of £160,000 is now used only as barracks; Fort Augustus, at the west end of Loch Ness, originally erected in 1730, and rebuilt after having been demolished by the rebels in 1745, is now almost obliterated, a palatial Benedictine monastery having been erected on its site; Fort William, on Loch Eil, built in the reign of William III., remains in good preservation, but is inhabited by civilians. On Culloden Moor to the eastward of Inverness was fought the battle (April 10, 1746) which closed the rebellion of 1745-46.

INVERNESS, a royal, parliamentary, and municipal burgh of Scotland, the capital of the above county, is finely situated at the northern end of Glenmore, on both sides of the river Ness, about half a mile from its mouth, and

on the Highland Railway, 144 miles north-north-west of Perth, and 109 west-north-west from Aberdeen. It is built principally on the right bank of the river, which is crossed by a suspension bridge, a wooden bridge, and a railway bridge of stone. Though very ancient, the town presents quite a modern appearance, and possesses wide and handsome streets, and beautiful suburbs with numerous fine villas. Lately great improvements have taken place, several new streets having been laid out within a recent period. On an eminence to the south-west of the town stood an ancient castle in which Macbeth is said to have murdered Duncan. This was razed to the ground by Malcolm Canmore, who erected another on an eminence overhanging the town on the south. The original castle was a royal fortress, and that erected by Malcolm continued to be so till its destruction in 1746. Its site is now occupied by a castellated structure erected in 1835, and comprising the court-house, county buildings, and jail. At the northern extremity of the town Cromwell erected a fort capable of accommodating a thousand men; this was demolished at the Restoration, but a considerable part of the ramparts still remains. In the centre of the town is the town-hall, completed in 1880, in front of which is a fountain so constructed as to contain the lozenge-shaped stone called *Clach-na-Cudain*, or "Stone of the Tub," from its having served as a resting-place for women in carrying water from the river. It was regarded as the palladium of the town, and is said to have been carefully preserved after the town was burned by Donald of the Isles. The spire of the old jail, which is of fine proportions, now serves as a belfry for the town clock. In the tower there is a slight twist caused by a shock of earthquake in 1816. The other principal buildings are the episcopal cathedral of St Andrew in the Decorated Gothic style, erected in 1866, and comprising nave, side aisles, transepts, and apsidal chancel; the academy, incorporated by royal charter in 1792, endowed originally with £20,000, to which in 1803 was added £25,000 left by Captain W. Mackintosh for the education of boys of certain families of that name; the collegiate school, the high school, the school of science and art, the new market buildings, erected in 1871 at a cost of £3100, the northern infirmary, and (outside the burgh) the new dépôt for soldiers at Millburn. The cemetery is finely situated on a hill south-west of the town, and about a mile and a half west of the town is the Lunatic asylum, erected in 1864. On Craig Phadraig hill, about a mile west of the town, there is a vitrified fort supposed to have been the residence of the Pictish kings. The manufacturing industries are not extensive; but there are iron-works, breweries, tanneries, woollen factories, and saw-mills. The harbour affords good accommodation for vessels, and there is considerable trade with Aberdeen, Leith, and London on the east coast, and by means of the Caledonian Canal with Liverpool, Glasgow, and Ireland. Shipbuilding is also carried on. The exports are chiefly sheep, wool, and agricultural produce, and the imports coal and provisions. In 1879 the number of vessels that entered the harbour was 2859, with a total burthen of 309,121 tons, while 2788 cleared, of 304,302 tons burthen. The population of the parliamentary burgh in the ten years 1861-71 increased from 12,509 to 14,466, and in 1881 it numbered 17,366. Inverness unites with the burghs of Forres, Fortrose, and Nairn in returning a member to Parliament.

Inverness is of great antiquity, but the exact date of its origin is unknown. At an early period it was incorporated as a town, and it was one of the Pictish capitals. In 1233 an abbey of the Dominicans was founded there by Alexander III. From William the Lion the town received four charters, one of which created it a royal burgh. In 1411 it was burned by Donald of the Isles on his way to the battle of Harlaw. The town was visited in 1427 by James

I., who held a parliament within its walls, and in 1562 it was visited by Queen Mary, who, being refused admission into the castle, caused it to be taken and the governor hanged. During the civil wars the castle was repeatedly taken and occupied by the rival forces; and in 1746 it was blown up by the troops of Prince Charles Stuart. See *Invernessiana*, by Charles Fraser Mackintosh, 1875.

INVESTITURE, in feudal phraseology, means the act of giving corporal possession of a manor or office,—an act which was usually conjoined with some significant ceremonial, such as the delivery of a branch, a banner, or some other appropriate symbol of the thing conveyed. Investiture with staff and ring was during and after the 11th century the name given to the ceremony by which ecclesiastical dignitaries were admitted by the civil power to possession of the temporalities of their office. The word investiture (from "vestire," to put in possession; see Ducange) is later than the 9th century; the thing itself is an outcome of the feudal system. Under the Frankish monarchy the idea came very early into vogue that the right of nominating bishops lay with the sovereign,—an idea that gained currency all the more widely, especially in Germany, as the territorial and temporal character of the bishoprics and abbeys, with their various immunities and privileges of coinage, toll, market, and the like, gradually came into prominence, and their spiritual nature and functions were proportionally obscured. It was indeed but logical that ecclesiastics, so far as they were the holders of lands, should not be exempted from the ordinary obligations of feudatories to their suzerain; nor was this view seriously disputed until after the middle of the 11th century, when the views of Hildebrand (afterwards Pope Gregory VII.), who aimed at asserting the absolute freedom of the church from all secular control, began to prevail at Rome. Thus a Roman synod in 1063 forbade all clergymen from accepting churches at the hands of laymen; and in 1068 a direct collision took place at Milan between the German court, which had invested a bishop in the usual way, and the populace, who under papal influence insisted on the appointment of one who had been canonically elected in accordance with the views of the reforming church party. In 1075 (the second year of his pontificate) Gregory VII. in a council held at Rome (*Labbe, Conc.*, vol. xii., ed. 1730) in the most stringent terms deposed every bishop, abbot, or inferior ecclesiastic who should receive investiture from any lay person, interdicted any one who should be guilty of rebellion from all communion in the favour of St Peter and from all fellowship with the church, and imposed a similar sentence on any emperor, duke, marquis, count, or other secular person who should presume to grant such investiture of bishopric or inferior dignity. The conflict between the empire and the Roman See, which began with this decree, was carried on with varying success throughout the whole of that pontificate, and was continued by Gregory's successors, with more than one unsuccessful effort at an adjustment, until in the concordat of Worms (1122) it was agreed between Henry V. and Calixtus II., on the one hand, that the emperor should surrender to the church the right of investiture by the ring and the pastoral staff, grant to the clergy throughout the empire the right of free election, and restore the possessions and feudal sovereignties which had been seized during the wars in his father's time and his own; while, on the other hand, it was conceded by the pope that all elections of bishops and abbots should take place in the presence of the emperor or his commissioners, and that every bishop elect in Germany should receive, by the touch of the sceptre, all the temporal rights, principalities, and possessions of the see, excepting those which were held immediately of Rome. It was also stipulated that in all other parts of the empire (Italy and Burgundy) the royalties should be granted to the freely elected bishop within six months after consecration. Later,



the imperial control over the election of bishops in Germany came to be in practice much curtailed, partly by the tacitly changed relations between the empire and its feudatories, partly by explicit concessions wrung at various times from individual emperors (Otto IV. in 1209, Frederick II. in 1213); but the principles of the concordat of Worms continued theoretically to regulate the tenure of bishoprics and abbeys until the dissolution of the empire in 1806.

The question of investitures never assumed an aspect of first rate importance in France, partly because the bishoprics there partook less than in Germany of the nature of secular principalities, partly because at an early period in the dispute the sovereigns voluntarily yielded the leading claims of the church party. In England an arrangement was come to as early as 1105 between Pascal II. and Henry I., in virtue of which the king gave up the right to invest with staff and ring, but retained the right to nominate his bishops and to exact from them the oath of allegiance. A certain freedom of election, somewhat similar to that which still exists (but see BISHOP), was first conceded under Stephen, and confirmed by John in 1215.

IO is the heroine of a legend associated with the cultus of Hera, both in Argos and in Eubœa. In Argos the great temple of Hera was situated on a hill called Eubœa, on the road from Mycenæ to the city of Argos; while in Eubœa the legend was associated with the town of Argoura. The identity of names shows that the legend dates from a very ancient period of the worship; and as, in accordance with the universal rule in such legends, Io is only a form of the goddess, it is highly probable that she represents an older stage of the cultus than the better known Hera. Her transformation into a cow is clearly a relic of the primitive time when the goddess was actually worshipped under the symbol of a cow, the fertile mother, united with the male deity in the *ἱερός γάμος* which was annually celebrated at Argos (see HERA).

Even in the simplest form in which we know it, the legend has been much transformed by poetic fancy. As a heroine united with the country from immemorial time, Io is called daughter of Inachus, the river of Argos and its older king, or of Iasus, from whom comes the epithet "Ἰασον Ἄργος." As associated with the oldest worship of Hera, she is called the daughter of Peiras, who made the first image of the goddess out of a pear tree at Tiryns; and Io Calithyia is, by a common device in such legends, the first priestess of the goddess. Zeus fell in love with her, and she was transformed into a white cow either by Zeus, to hide her from the rage of Hera, or by the jealous goddess herself. When Io and Hera had once been made into distinct personalities, such tales easily arose to explain the relation between them. Hera then insisted on getting this cow from Zeus, and set Argus Panoptes with his thousand eyes to watch her. Io is almost universally understood to be the moon, and Argus the star-studded nightly heaven. Argus tied the cow to the olive tree shown in the sacred grove on Mount Eubœa, or according to the poets pastured her in the fertile meadows of Lerna or Nemea. Zeus now sends his messenger Hermes, who lulls Argos to sleep with his magic wand, and slays him with the same curved sword, *κέρπερ*, with which afterwards Perseus, the light-hero, slew the Gorgon, the power of darkness. According to another account Argus, the darkness, is slain by a stone thrown by Hermes, *i.e.*, by the rising sun, whose sudden appearance is frequently spoken of as the throwing of a stone (Kuhn, *Entwickl. d. Mythol.*). Maddened by a gadfly, Io wanders over many lands till at last she comes to Egypt, where she regains human form and becomes the mother of Epaphus. Opinions differ much as to the interpretation of this part of the tale. It is not probable that both Zeus and Hermes figured in the original legend; and the end has certainly been adapted so as to bring Greece and Egypt into connexion, and dates therefore from the time when intercourse

between them became frequent and much influence was exerted by Egyptian religion on Greek thought, *i.e.*, the 7th century B.C. How far Oriental influence had affected the cultus at the period to which the origin of the legend belongs is doubtful; Preller compares the Phœnician conception of Astarte as a wandering cow. In later time Isis, who was conceived as borned (Herod. ii. 41), was connected with Io. The legend of Io was a favourite subject among Greek painters, and many representations are preserved on vases and in wall paintings (see Overbeck, *Kunstmyth. d. Zeus*, 465).

See the works quoted under HERMES; and against the explanation of Io as the moon see Plew in *N. Jahrb.*, 1870 and 1873.

IODINE, thus named on account of the violet colour of its vapour (*ἰοειδής*, violet-coloured), one of the so-called halogen elements, has already been partially described (see CHEMISTRY, vol. v. pp. 490-498).

Iodides occur in minute quantity in most mineral waters and in sea water. The ashes of many marine algae are rich in them; and formerly iodine was chiefly extracted from kelp or varec, the ashes of sea-weed, by distilling the mother liquor remaining after the separation of the less soluble salts by crystallization with manganese dioxide and sulphuric acid. Of late years, however, large quantities of iodine have been obtained from crude Chili saltpetre by a similar process.

The chief use of iodine is in the preparation of methyl-iodide, a substance employed in the manufacture of certain of the so-called aniline dyes. In medicine it is frequently applied externally as an irritant. Potassium iodide is also an important medicinal agent; and iodoform,  $\text{CHI}_3$ , a substance prepared by acting on alcohol with iodine in presence of alkali, has latterly been introduced as an agent for external application in certain diseases. Several iodides, especially ammonium, cadmium, and potassium iodide, are largely employed in photography.

Recent investigations have disclosed a number of most remarkable facts regarding the behaviour of iodine, and the allied elements bromine and chlorine, which merit a brief description here. Free chlorine, bromine, and iodine are respectively represented by the formulæ  $\text{Cl}_2$ ,  $\text{Br}_2$ , and  $\text{I}_2$ ; that is to say, their molecules are "*diatomic*," each consisting of two atoms (comp. vol. v. pp. 467-472). On the other hand, the molecules of which sulphur vapour at a temperature of about  $500^\circ \text{C}$ . consists are hexatomic, as expressed by the formula  $\text{S}_6$ ; but on raising the temperature these molecules undergo simplification, so that at temperatures above  $800^\circ$  the vapour appears to consist entirely of diatomic molecules such as are indicated by the formula  $\text{S}_2$ . It would seem that the halogens undergo a similar molecular simplification when heated.

Having devised a method of extreme simplicity for the determination of vapour density, V. Meyer was led in the summer of 1879 to determine the density of a number of elementary bodies at much higher temperatures than had previously been employed, and among others chlorine was examined. He was then led (in conjunction with C. Meyer) to the discovery that at high temperatures this gas has a very much lower density than corresponds to the formula  $\text{Cl}_2$  (*Berichte der deutschen chemischen Gesellschaft zu Berlin*, 1879, p. 1430; comp. *ibid.*, 1880, p. 1172). Subsequently he extended his observations to bromine and iodine (*ibid.*, 1880, p. 394), and with similar results. Meier and Crafts took up the subject with the object of verifying V. Meyer's statements (*ibid.*, 1880, p. 851); they introduced several refinements in the method of operating, and determined the temperatures at which the experiments were made more accurately; in the main, however, their observations with iodine were confirmatory of V. Meyer's. V. Meyer's original results, and those of Meier and Crafts,

are arranged in the following table, where the numbers in the column headed  $\frac{D'}{D}$  indicate the ratio between the observed density and the theoretical density on the air scale corresponding to the formula  $I_2$  (879).

<i>V. Meyer.</i>			<i>Meier and Crafts.</i>		
Temperature.	Density.	$\frac{D'}{D}$	Temperature.	Density.	$\frac{D'}{D}$
252° -450° 386°	889, 883, 884, 885 887, 871, 871	.99	445°	870, 878, 875	
			677°, 682° 737°, 770°, 765° 831°, 878°	806, 858 809, 828 804, 811	.94 .93 .92
84° 102°	608, 680, 68 575, 574	.77 .63	1039°, 1059°, 1030 1270°, 1280°	718, 702, 688 607, 595	.83 .68
1570°	567, 560, 571, 581	.65	1390°	523, 531	.60

Meier and Crafts were of opinion that the highest temperature they employed was probably as high as that estimated by V. Meyer at 1570°, and the latter chemist subsequently acknowledged the justice of their criticism of his determinations of temperature, which were conducted by a calorimetric method, whereas Meier and Crafts employed an air thermometer. V. Meyer has since extended his observations to a still higher temperature, and has obtained the values 4.53, 4.55, 4.57, which are not far removed from the theoretical value 4.39, corresponding to the formula I for the iodine molecule (*op. cit.*, 1880, p. 1010).

An important series of observations by Meier and Crafts (*Comptes Rendus*, xcii. 39) on the density of iodine at various temperatures under various pressures show that at temperature below 700° and pressures below atmospheric pressure the density is constant, and corresponds to the formula  $I_2$ , and that the density diminishes more rapidly with rise of temperature.

From the earlier results obtained by Meier and Crafts, A. Naumann has calculated the rate of dissociation of iodine, on the assumption that the decomposition is expressed by the equation  $I_2 = I + I$ , and has shown that it is in accordance with the general law of dissociation deduced from the dynamical theory of gases. He points out as especially remarkable that dissociation probably extends over 1200°, since it is only half completed at a temperature of about 1270°, and commences at least 600° lower.

The observations of Meier and Crafts indicate that the density of iodine begins to be abnormal at a temperature between 600° and 700°. The dissociation of bromine apparently does not commence at so low a temperature, and at a temperature at which the ratio of the observed to the theoretical density is .66 for iodine, it is .8 for bromine. Chlorine is much less readily dissociated than bromine. These results are in accordance with the general chemical behaviour of the halogens. It has yet to be proved, however, that the dissociation is of the character indicated above, and that the molecules of the halogens do not undergo a less simple decomposition such as is contemplated in Sir Benjamin Brodie's calculus of chemical operations. (H. E. A.)

ION, of Chios, one of the five Greek tragic poets of the canon, was born in Chios, probably in the 74th Olympiad, —485-480 B.C. Although he seems to have lived much in his native island, where he met Sophocles in 441 B.C., he paid frequent visits to Athens, making the acquaintance of Æschylus, and becoming a warm admirer of Cimon and a severe critic of the rival statesman Pericles. His first tragedy dates from the 82d Ol., between 452 and 449 B.C.; and he is mentioned as third to Euripides and Iophon in the tragic contest of 429 B.C. In a subsequent year he gained both the tragic and dithyrambic prizes, and in honour of his victory gave a jar of Chian wine to every Athenian citizen,—a gift which would imply an ample fortune. From a passage in the *Peace* of Aristophanes

(830 *seq.*), which was produced in 421 B.C., it is generally concluded that Ion died before that year. The names and a few fragments of eleven of Ion's plays remain; the latter give him a place only inferior to the three great tragic masters of Greece. He is credited by the scholiast on Aristophanes (*loc. cit.*) with having composed comedies, dithyrambs, epigrams, pæans, hymns, scholia, encomia, and elegies; and he is the reputed author of a philosophical treatise on the mystic number three. His historical or biographical works were five in number, and included an account of the antiquities of Chios.

See Mure's *Language and Literature of Ancient Greece*, iv.; Mahaffy's *History of Classical Greek Literature*, i., 1880; Welcker's *Griechischen Tragödien*, iii.; and Kayser's *Historia Tragicorum Græcorum*.

IONA, or ICOLMKILL, a small island of the Hebrides, on the west coast of Scotland, in the county of Argyll, is situated about 8 miles south of Staffa and  $1\frac{1}{2}$  miles west of the south-western promontory of Mull, from which it is separated by the shallow Sound of Iona. Its length is about  $3\frac{1}{2}$  and its breadth  $1\frac{1}{2}$  miles. The total area is about 2000 imperial acres, of which about 600 are under cultivation. Along the north-western shore patches of green pasture alternate with small irregular rocky elevations, culminating in the north of the island in Dunii, which has an elevation of about 330 feet. From the base of Dunii to the shore there is a stretch of low land consisting of shelly sand covered partly with grass, but towards the east exhibiting a surface of unbroken and dazzling whiteness. The southern part of the island consists of a combination of rocky elevations and grassy ravines, the rocks in the south-west corner presenting a bold and precipitous front to the sea. Geologically Iona is composed of Laurentian gneiss of great variety of character and very contorted stratification. Its deficiency in natural features of special interest is compensated for by the striking and various views obtained of the surrounding archipelago of islands, including the neighbouring Mull and Jura, and the distant mountains of Skye. Fronting the sound is the small village of Iona or Buile Mor, consisting of about fifty cottages. There are two churches (Established and Free) and a school. Oats, barley, and potatoes are grown on the island, and it affords sustenance for about 300 cattle, 600 sheep, 20 horses, and 60 pigs; but the inhabitants are dependent for support as much on fishing as on agriculture. Population in 1861, 264; in 1871, 236; in 1881, 243.

The relics of antiquity still remaining consist of part of the cathedral church of St Mary, the nunnery, some small chapels, a building called the bishop's house, and a number of ancient tombs or crosses. The cathedral, dating from the 13th century, is built in the usual form of a cross, and consists of nave, transept, and choir, with a sacristy on the north side and chapels on the south. A great portion of the walls and the central tower, about 75 feet in height, are still standing. It contains a number of old tombs. To the north are the remains of the conventual buildings which from a Norman arcade still standing appear to have been of an older date than the cathedral. The chapel of St Oran or Odhrain situated in the cemetery, on the south side of the monastery, dates probably from the 11th century, and its western doorway presents a Norman arch with the beak-head ornament. The cemetery, called in Gaelic *Reilig Oiran*, the burial-place of kings, and said to contain the remains of forty-eight Scottish, four Irish, and eight Danish or Norwegian monarchs, possesses a large number of monumental stones. The remains of the nunnery exhibit traces of Norman architecture. Of the numerous crosses erected in the island the finest are Maclean's cross and St Martin's cross, which are still almost entire. Both



are richly carved with Runic knots and various emblematic devices and fanciful scrolls.

The original form of the name Iona was Hy, Hii, or I, the Irish for island. By Adamnan in his *Life of St Columba* it is called *Iona insula*, and the present name Iona originated in some transcriber mistaking the *u* in *Ioua* for an *n*. It also received the name of Hu-colum-kill (Icolmkill), that is, the island of Columba of the Cell, while by the Highlanders it has been known as *Iunis nan Druidhneah*, the island of the Druids. It was in the year 563 that Columba, after leaving the shores of Ireland, entered the creek of Iona now known as *Port-a-churraich*, the port of the coracle, and, having satisfied himself of the suitability of the island for his purpose, founded there his famous monastery. The island was then inhabited by a Pictish population, but it has been disputed whether Columba obtained the grant of it from Conall, king of Dalriada, or from Brude, king of the Picts. Columba was buried in Iona, but between 802 and 807 his remains were transferred from it to the church of St Patrick in the county Down, Ireland. For a long time the monastery of Iona held the supremacy among all the monasteries and churches founded by Columba and his disciples. It was several times plundered and burned by the Norsemen, and its inmates on more than one occasion put to death. The Western Isles having come into the possession of Scotland in 1072, the monastery of Iona was rebuilt and endowed by Queen Margaret. In 1092 they were, however, ceded to Magnus Barefoot of Norway, who after the renewal of the cession by Edgar in 1097 visited Iona and allowed the people to retain their possessions. The diocese of the Isles, founded about 838, of which Iona was the seat, was united by Magnus to the bishopric of Man, and made subject to the archbishopric of Drontheim in Norway. A new monastery as well as a nunnery was founded by the Benedictines in 1203, and the Benedictine order either absorbed or expelled the Celtic community. About 1507 the island again became the seat of the bishopric of the Isles. The monastery was demolished in accordance with the Act passed by the Convention of Estates in 1561. For many centuries it was much frequented on account of its facilities for learning, and, as may be supposed, became after the death of Columba a great resort of pilgrims, many of whom came in order to die on the island that their remains might be interred in its sacred soil; while the remains of persons illustrious in rank or in piety were brought to it for burial from all parts of northern Europe. The site of the old monastery was about a quarter of a mile north from the present ruins.

See, in addition to the article *COLUMBA*, and the old authorities therein cited, Montalembert's *Monks of the West*, vol. iii.; *The Cathedral or Abbey Church of Iona*, by Bishop Ewing, 1866; *Iona*, by the Duke of Argyll, 1870; *Scene's Celtic Scotland*, vol. ii., 1877; and *Sculptured Monuments in Iona and the West Highlands*, by James Drummond, 1881.

IONIA, in ancient geography, was the name given to a portion of the west coast of Asia Minor, adjoining the Ægean Sea, and bounded by Lydia towards the east. Like the adjoining districts of Æolis on the north and Doris on the south, it was not a country or region marked out by any natural boundaries, but merely consisted of a strip of land near the coast, of comparatively small breadth, which, together with the adjacent islands, was occupied by Greeks of the Ionic race, and was thus permanently distinguished from the interior district, which was inhabited by the Lydians.

According to the tradition universally received among the Greeks, the cities of Ionia were founded by emigrants from Greece on the other side of the Ægean, and their settlement was connected with the legendary history of the Ionic race in Attica and other parts of European Greece, by the statement that the colonists were led by Neleus and Androchus, the two sons of Codrus, the last king of Athens. In accordance with this view a definite date was assigned to the Ionic migration, as it was called by later chronologers, who placed it one hundred and forty years after the Trojan war, or sixty years after the return of the Hæraclidæ into the Peloponnese. It is hardly necessary to remark that no reliance can be placed upon this chronological statement; and it is altogether improbable that the colonization of the whole of this important district took place at the same period. All analogy would lead us to suppose that the foundation of the different cities which ultimately constituted the Ionic League took place at different times, and was perhaps spread over a long period of time. It is, however, not improbable that the great Dorian invasion of the Peloponnese, which gave rise to such extensive

changes in the population of European Greece, may have given the first impulse to the migration of a large part of the Ionian inhabitants to the opposite shores of the Ægean. Nor is there anything unlikely in the fact that a body so composed should have put themselves under the command of a leader or ægist from Athens, which was generally looked upon as the special representative of the Ionian race.<sup>1</sup> But Herodotus himself tells us (i. 146) that they were very far from being of unmixed Ionic descent, and comprised settlers from many different tribes and cities of Greece (a fact indicated also by the local traditions of the different cities), as well as by intermarriage with the native races whom they found in possession of the country. A striking proof of this was to be found in the fact that so late as the time of the historian several distinct dialects were spoken by the inhabitants of different cities within the limits of so restricted an area.

Some modern critics have supposed that the population of this part of Asia was originally of Ionic race, and that the settlers from Greece found the country in the possession of a kindred people. But no trace is found in any ancient writers of such a fact, or of the distinction established by these modern scholars between the so-called Old Ionians and New Ionians. All that we know upon anything like historical evidence is that at the earliest period when we hear of any Greek population as existing on the east coasts of the Ægean we find there a large group of cities, distinct in dialect and institutions from those to the north and south of them, and generally regarded both by themselves and their neighbours as derived by direct immigration from the people who bore the name of Ionians in European Greece. Of the period of their settlement in Asia we have no trustworthy evidence; but it appears to have been anterior to the rise of the Lydian monarchy, which gradually became their most formidable neighbour.

The cities comprised under this name in historical times were twelve in number,—an arrangement copied as it was supposed from the constitution of the Ionian cities in Greece, which had originally occupied the territory in the north of the Peloponnese subsequently held by the Achæians. These were (proceeding from south to north)—Miletus, Myns, Priene, Ephesus, Colophon, Lebedus, Teos, Erythræ, Clazomenæ, and Phocæa, together with the two important islands of Samos and Chios. Smyrna, which subsequently assumed so prominent a position among the cities of this part of Asia, was originally an Æolic colony, but was afterwards occupied by a band of Ionians from Colophon, and became thenceforth an Ionian city,—an event which had taken place before the time of Herodotus. But at what period it was admitted as a member of the Ionic League we have no information.

The cities above enumerated unquestionably formed a kind of league or confederacy among themselves, of which their participation in the Pan-Ionic festival was the distinguishing characteristic. But, like the Amphictyonic League in Greece itself, this was rather of a sacred than a political character; every city, as usual among the Greeks, enjoyed absolute autonomy, and, though common interests often united them for a common political object, they never formed a real confederacy like that of the Achæians or Bœotians; and the advice of Thales of Miletus to combine in a more intimate political union found no approval among them.

The territory thus occupied was of small extent, not exceeding 90 geographical miles in direct length from north to south, with a breadth varying from 20 to 30 miles, but to this must be added the remarkable peninsular promontory of Mimas, together with the two large islands. So

<sup>1</sup> Concerning the Ionian race in Greece, the reader is referred to the article *GREECE*, vol. xi. p. 20.

intricate indeed is the coast-line that the *periplus* or voyage along its shores was estimated at 340 geographical miles, or nearly four times the direct distance. A great part of this area was, moreover, occupied by mountains, none of them attaining to any great elevation, but filling up a considerable space. Of these the most lofty and striking were—Mount Mimas and Corycus, in the peninsula which stands out to the west, facing the island of Chios; Mount Sipylos, to the north of Smyrna; Mount Corax, extending to the south-west from the Gulf of Smyrna, and descending to the sea between Lebedus and Teos; and the strongly marked range of Mount Mycale, which is in fact a kind of continuation of the chain known as Mount Messogis in the interior, and forms the bold headland of Troglitium or Mycale, opposite to the island of Samos. None of these mountains attain a height of more than from 3000 to 4000 feet; but they for the most part form abrupt and detached ranges, intersecting the country in different directions. Confined as it thus was, the narrow district in question had the advantage of comprising three broad valleys, formed by the outflow of three rivers, among the most considerable in Asia Minor:—the Hermus in the north, flowing into the Gulf of Smyrna, though at a considerable distance from the city of that name; the Cayster, which flowed under the walls of Ephesus; and the Mæander, which in ancient times discharged its waters into the deep gulf that bathed the walls of Miletus, which has been gradually filled up by its continued action. These valleys were all of them extremely fertile, and besides them many smaller tracts were to be found between the mountains and the sea, of great fertility, and enjoying the advantage of a peculiarly fine climate, for which this part of Asia Minor has been famous in all ages. The consequence is that Ionia enjoyed the reputation in ancient times of being the most fertile of all the rich provinces of Asia Minor; and even in modern times, though very imperfectly cultivated, it produces abundance of fruit of all kinds, and the raisins and figs of Smyrna supply almost all the markets of Europe.

The colonies founded in such a favoured land speedily rose to opulence and prosperity. Miletus especially was at an early period one of the most important commercial cities of Greece, and in its turn became the parent of numerous other colonies, which extended all around the shores of the Euxine and the Propontis, from Abydus and Cyzicus to Trapezus and Panticapæum. Phœcea also was one of the first Greek cities whose mariners explored the distant shores of the western Mediterranean, where they founded on the coast of Gaul the important colony of Massilia. Ephesus also, though it did not send out any colonies of importance, from an early period became a flourishing and opulent city, and gradually attained to a position in this part of Asia corresponding in some measure to that of Smyrna at the present day.

The first event in the history of these Ionian cities of which we have any trustworthy account is the invasion, or rather inroad, of the Cimærians, a nomad people from beyond the Euxine, who ravaged a great part of Asia Minor, including the neighbouring Lydia, and even sacked Magnæsia on the Mæander, but were foiled in their attack upon Ephesus. This event may be referred to the middle of the 7th century B.C. A more formidable danger soon threatened the Ionian Greeks from the rising power of the Lydian monarchy. Gyges, the first king of the Mermnad dynasty (about 700 B.C.), already invaded the territories of Smyrna and Miletus, and is even said to have taken Colophon, as his son Ardys did Priene. But neither conquest was durable, and it was not till the reign of Croesus (560–545 B.C.) that the cities of Ionia successively fell under the dominion of the Lydian monarch. The defeat of Croesus by Cyrus was followed by the conquest of all the Ionian cities by the Persian general Harpagus, and they henceforth became subject to the Persian monarchy, in common with all the other Greek cities of Asia. In this position they enjoyed a considerable amount of autonomy, but were for the most part subject to the rule of local despots. It was at the instigation of one of these, Histieus of Miletus, that in about 500 B.C. the principal cities broke out into insurrection

against Persia, in which they were at first assisted by the Athenians, with whose aid they even penetrated into the interior, and burnt the important city of Sardis, an event which ultimately led to the Persian invasion of Greece. But this first success was of little avail; the fleet of the Ionians was defeated in a great battle off the little island of Lade, and the capture and destruction of Miletus, after a long protracted siege, was followed by the reconquest of all the Asiatic Greeks, insular as well as continental (494 B.C.).

The victories of the Greeks during the great Persian war had the effect of enfranchising their kinsmen on the other side of the Ægean; and the battle of Mycale (479 B.C.), in which the defeat of the Persians was in great measure owing to the revolt of the Ionians, secured their emancipation from the Persian yoke. They henceforth became, like most of the inhabitants of the islands, the dependent allies of Athens, though still retaining their autonomy, which they preserved until the peace of Antalcidas in 388 B.C. once more placed them, as well as the other Greek cities in Asia, under the nominal dominion of Persia. They appear, however, to have retained a considerable amount of freedom until the invasion of Asia Minor by Alexander the Great brought about a fresh change. After the battle of the Granicus most of the Ionian cities submitted at once to the conqueror; Miletus alone held out, and was not reduced till after a long siege, 334 B.C. From this time they passed successively under the dominion of the Macedonian rulers of Asia, but continued to enjoy a state of great prosperity, both under these Greek dynasties and after they had been united as a part of the province of Asia with the all-absorbing empire of Rome.

There was indeed one striking exception to this prosperity. Miletus, so long one of the chief cities of Ionia, gradually sank into complete decay, a circumstance owing not so much to political as to physical causes, the mass of alluvial matter brought down by the river Mæander having gradually filled up the Latinian Gulf, on which it was situated, so that the island of Lade was ultimately joined to the mainland, and Miletus itself altogether ceased to be a seaport. The same cause has at a later period produced the same effect, though in a less degree, with the city of Ephesus; while the continually advancing deposits of the Hermus threaten, at no distant period, unless prevented by the skill of modern engineers, to close up the still more extensive Gulf of Smyrna.

It has been mentioned that the Ionian cities were accustomed to celebrate in common a festival called the Pan-Ionia; the sanctuary at which this was celebrated, and which was also called the Pan-Ionion, was situated on the northern slope of Mount Mycale, in the territory of Priene. But, besides this common religious centre, Ionia contained also two of the most celebrated shrines in all Asia, the temple of Artemis at Ephesus, and that of Apollo at Branchidæ near Miletus. It is probable that both sites were connected with local centres of more ancient religious worship, and were adopted by the Ionian Greeks when they first settled in Asia. (E. H. B.)

IONIAN ISLANDS, the ordinary collective name of Corfu (Κέρκυρα), Cephalonia (Κεφαλληνία), Zante (Ζάκυνθος), Santa Maura (Λευκάς), Ithaca, Cerigo (Κίθηρα), and Paxo, with their minor dependencies. As the islands are seven in number they are often called the Heptanesus (Ἑπτάνησος) in Greek, and Heptanesian or Septinsular is the corresponding adjective. The history of the use of Ionian as the distinctive epithet of the islands is sufficiently obscure; but it is probable that, like the application of the name Ionian Sea to this part of the Mediterranean, it is due to the settling of Ionian colonists on the coasts and islands. The islands have no real geographical unity beyond that involved in the fact that, with the exception of Cerigo, situated off the south coast, they are all within a little distance of the west coast of Greece or Albania. Corfu is separated from the mainland by not more than 2 miles, while the passage from it to Santa Maura, the nearest of the larger islands, is no less than 46. Since 1863 the whole Heptanesian territory has been incorporated with the kingdom of Greece, and the several islands have been assigned to different administrative divisions. Corfu, Cephalonia, and Zante each gives its name to one of the thirteen nomarchies of the kingdom; Cerigo is part of the nomarchy of Argolis and Corinth. The area of the seven islands is computed at 1041 square miles. The population shows a steady increase: in 1836 it was 204,242 (110,496 males, 93,746 females); in 1854, 228,981 (123,254 males, 105,727 females); in 1870, 229,516; and in 1879, 244,433. The following table shows the details of the last census:—



Nonarchy.		Males	Females.	Total, 1879.	Total, 1876.
Corfu (Kerkyra).	Corfu.....	13,402	13,292	26,694	25,729
	Messe.....	12,697	11,631	24,328	21,754
	Oros.....	14,191	12,311	27,002	24,983
	Leucas.....	12,185	10,898	23,083	20,892
	Paxo.....	2,651	2,351	5,002	3,582
		55,126	50,983	106,109	96,940
Cephalonia	Craneaia ...	15,698	16,505	32,203	33,358
	Palle.....	9,651	9,352	19,003	17,377
	Same.....	7,925	9,190	17,115	16,774
	Ithaca.....	6,805	5,917	12,722	9,873
		39,579	40,964	80,543	77,382
Zante (Zakynthos). Part of Argolis and Corinth.	Zante.....	23,935	20,587	44,522	44,557
	Cerigo (Kythera).	6,750	6,509	13,259	10,637
	Total ...	125,390	119,043	244,433	229,516

Corfu has a denser population than any other part of Greece, more than 350 inhabitants to the square mile; and Zante ranks next with about 300. The city of Corfu, with its 25,000 inhabitants, is the third in size of the Greek towns, being exceeded only by Patras (Patrai) and Athens.

As the Ionian Islands have no geographical unity, their political unity is of comparatively modern date. A Septinsular or Heptanesian history, as distinguished from the individual histories of the seven islands, is consequently in its earlier chapters a mere conventional composition produced by gathering together a variety of scarcely connected facts. To a certain extent indeed the various islands have passed under the same succession of influences; they have been subjected to the same invasions, and have received accessions to their populations from the same currents of migration or conquest; but in the degree in which even what may be considered as common experiences have affected the individual islands there has been no small diversity. In the matter of population, for instance, the island of Corfu has undergone much more important modifications than the island of Ithaca. For such facts as the establishment of Ulysses in Ithaca, the settlement of a Corinthian colony in Corfu, and the origin of the Peloponnesian War in a dispute between the colony and the "metropolis," the reader will consult the separate articles **CORFU**, **ITHACA**, &c.

The beginning of Heptanesian history may be said to date from the 15th century. Though it is true that Leo the Philosopher (about 890 A.D.) formed all or most of the islands into a distinct province under the title of the Tema of Cephalonia, and that in this condition they belonged to the Eastern empire after Italy had been divided into various states, this political or administrative unity could not last long in the case of islands situated, as they were, in the very meeting place of opposite currents of conquest. Robert Guiscard, having captured Corfu (1081) and Cephalonia, might have become the founder of a Norman dynasty in the islands but for his early death at Cassopo. Amid the struggles between Greek emperors and Western crusaders that continued to fill the 12th century, Corfu, Cephalonia, Zante, &c., emerge from time to time; but it was not till the Latin empire was established at Constantinople that the Venetians, who were destined to give the Ionian Islands their place in history, obtained possession of Corfu. They were afterwards robbed of the island by Leon Vetrano, a famous Genoese corsair: but he was soon defeated and put to death, and the senate, to secure their position, granted fiefs in Corfu to ten noble families in order that they might colonize it (1206). The conquest of Cephalonia and Zante followed, and we find five counts of the family of Tocco holding certainly the former island, and probably the latter as well as Santa Maura, as tributary to the republic. But the footing thus gained by the Venetians was afterwards lost, and through the closing part of the 13th and most of the 14th century the islands were a prey by turns to corsairs and to Greek and Neapolitan claimants. In 1386, however, the people of Corfu made voluntary submission to the republic which had now risen to be the first maritime power in the Mediterranean, and in 1401 (August 16th)

the senate, with mercantile caution, secured their possession of the island from any claim which might be asserted by the kings of Naples through the duchy of Taranto by obtaining a ratification of their title from Ladislaus for the sum of 30,000 ducats. In 1485 Zante was purchased from the Turks in a very depopulated condition; and in 1499 Cephalonia was captured from the same masters; but Santa Maura, though frequently occupied for a time, was not finally attached to Venice till 1684, and Cerigo was taken only in 1717.

On the fall of the Venetian republic in 1797, the treaty of Campo Formio, which gave Venice to Austria, annexed the Ionian Islands to France; and in 1798 the French Government ratified the arrangement, and their division into three departments. But a Russo-Turkish force came to drive out the French at the close of that year; and in the spring of 1799 Corfu capitulated. By treaty with the Porte in 1800, the emperor Paul erected the Republic of the Seven United Islands, which, with various modifications, was but another name for anarchy and confusion, till a secret article in the treaty of Tilsit, in 1807, declared the Ionian Islands an integral part of the French empire. They were incorporated with the province of Illyria, and in this condition they remained till the decline of the French power. The British forces, under General Oswald, took Zante, Cephalonia, and Cerigo in 1809, and Santa Maura in 1810; Colonel Church reduced Paxo in 1814; and after the abdication of Napoleon, Corfu, which had been well defended by General Donzelot, was, by order of Louis XVIII., ceded to Sir James Campbell. By the treaty of Paris (9th November 1815) the contracting powers—Great Britain, Russia, Austria, and Prussia—agreed to place the "United States of the Ionian Islands" under the exclusive protection of Great Britain, and to give Austria the right of equal commercial advantage with the protecting country, a plan strongly approved by Count Capodistrias, the famous Corfiot noble who afterwards became president of the new republic of Greece.

The terms of the treaty were unfortunately not only of indefinite import, but, if not actually self-contradictory, at least susceptible of contradictory interpretation. And, still more unfortunately, instead of interpreting the other articles in harmony with the first, which declared the islands one "sole free and independent state," the protecting power availed itself of all that they contained in support of the extension of its authority. The first lord high commissioner, Sir Thomas Maitland, who as governor of Malta had acquired the sobriquet of "King Tom," was not the man to foster the constitutional liberty of an infant state. The treaty required, with questionable wisdom, that a constitution should be established, and this was accordingly done; but its practical value may be judged of from the fact that the budget presented to the assembly of representatives in 1840, without risk of discovery, consisted of so much blank paper,—duly bound, it is true, in purple velvet. The constitution, which came into force in January 1818, placed the administration in the hands of a senate of six members and a legislative assembly of forty members; but the real authority was vested in the commissioner, who was able directly to prevent anything, and indirectly to effect almost anything. Sir Thomas Maitland was not slow to exercise the control thus permitted him, though on the whole he did so for the benefit of the islands. The construction of roads, the abolition of direct taxes and of the system of farming the church lands, the securing of impartial administration of justice, and the establishment of educational institutions are among the services ascribed to his efforts. These, however, made less impression on the Heptanesians than his despotic character and the measures which he took to prevent them giving assistance in the Greek war of independence in 1821. He was succeeded in 1823 by General Sir Frederick Adams, who in the main carried out the same policy, though he showed more favour to the aristocracy. It was under his government that the new fortifications of Corfu began to be constructed, and that some of the most important public works which still do honour to the English protectorate were undertaken. In Cephalonia the credit belongs, however, to Colonel Napier, one of the most able and arbitrary Englishmen who had to do with the islands. Lord Nugent, who became commissioner in 1832, began by allowing the parliament greater freedom, but was afterwards compelled to revert to the previous method of management. Sir Howard Douglas, his successor (1835–1841), had a stormy reign. He ruled with a firm, too often with a high hand; and he was met by continual intrigues, contentions, and calumnies. The parliament was prorogued in 1831, 1841, and 1842, the principal exponent of the opposition being the famous Mustoxidi (who died in 1861). A complete change of policy was inaugurated by Mr Mackenzie (1841–43), but his relations to the home Government, rendered more embarrassing by a bold act of his own, led to his speedy resignation. Lord Seaton (1843–49) was induced by the European disturbances of 1848 to propose and urge on a number of important reforms in the constitution; and in 1843 liberty of the press was granted by statute. Freedom of election, both parliamentary and municipal, a large extension of the franchise, and the restoration of voting by ballot were among the concessions of 1849. The assembly (the ninth) first elected under the extended franchise had

to be twice prorogued by Sir Henry Ward (1849-1855), and was finally dissolved in 1851; and the growing hostility to the Government was vainly met by banishment of members of assembly and editors of papers. The party which wished for union with Greece was rapidly growing in vigour and voice. Serious insurrections of the peasantry, especially in Cephalonia, had to be put down by military force both by Lord Seaton and Sir Henry Ward. Sir John Young (1855-1859) found the tenth parliament of the same temper as the ninth: in its first session it passed a resolution in favour of immediate union with Greece. The hostility of the unionist party to the commissioner himself was increased by the publication (1858) of one of his despatches (stolen from the colonial office), in which he recommended that "Corfu and Paxo should, with the consent of their inhabitants, be converted into English colonies, and that only the southern islands should be handed over to Greece." About the same time, however, the hopes of the unionists were roused by the appointment of Mr Gladstone as high commissioner extraordinary to investigate into the condition of the islands. From his eminence in Greek scholarship, and his known sympathy with Greek independence, it was their expectation that he would support if he did not satisfy their pretensions. But after a tour through the principal islands Mr Gladstone came to the conclusion that the abolition of the protectorate was not the wish of the mass of the people, and the cordial reception which he owed to his own reputation and character was too much ascribed by him to the general goodwill of the Ionians to the English Government. For a few days in 1859 he held office as lord high commissioner, and in that capacity he proposed for the consideration of the assembly a series of reforms. These reforms were, however, declared inadmissible by the assembly; and Sir Henry Storks (February 16, 1859), who succeeded to the difficult post which Mr Gladstone resigned, began his rule by a prorogation. The contest continued in the same style between the assembly and the protectorate. The English Government was slow to realize the true position of affairs: as late as May 1861 Mr Gladstone spoke of the cession of the islands as "a crime against the safety of Europe," and Sir Henry Storks continued to report of tranquillity and contentment. The assembly of 1862 accused the commissioner of violation of the constitution and of the treaty of Paris, and complained that England remained in ignorance of what took place in the islands. During this time there had been considerable agitation in Greece owing to the disfavour in which King Otto (of Bavaria) was held. On the abdication of that prince in 1862 the Greek people by universal suffrage voted Prince Alfred of England to the throne, and when he declined to accept the crown England was asked to name a successor. The prince proposed was William, brother of the Princess of Wales; and the English Government declared to the provisional Government of Greece that if they accepted him (which they did) his power would be strengthened by the long-refused cession of the Ionian Islands. In 1863 the commissioner laid before the parliament (the thirteenth) the conditions on which the cession would be carried out. The rejection of one of those conditions—the demolition of the fortifications of Corfu—led to a new prorogation; but none the less (on November 14, 1863) the plenipotentiaries of the five great powers signed the protocol by which the protectorate was brought to a close. The neutrality which they attributed to the whole of the islands was afterwards (January 1864) confined to Corfu and Paxo. On May 30 of that year the lord high commissioner handed over the archives of the state to General Zaimis, the Greek plenipotentiary; and on the following day he left Corfu with the English troops and men-of-war. King George (Prince William of Schleswig-Holstein) made his entry into the capital on June 6th. The eighty representatives of the Ionian Islands took their places in the national parliament on July.

*Bibliography.*—Bondelmonte, *Liber insularum Archipelagi* (written about 1560; published by Sinner, 1824); Benedetto Burdonò, *Isolaria*, Venice, 1828-34-62; P. Porcacchi da Castiglione, *L'isola più famosa del mondo*, Venice, 1590; Rubincos, *Essai sur les îles de Zante, de Cerigo, &c.*, Paris, 1799; Castellan, *Lettres sur la Morée et les îles de Cerigo, Idra, et Zante*, Paris, 1808; Holland, *Travels in the I. I.*, London, 1815; Vaudoucourt, *Mémoires sur les îles Ioniennes*, English translation, London, 1820; De Bosset, *Parage and the I. I.*, London, 1822; C. J. Napier, *The Colonies*, London, 1833; Gifford, *Visit to the I. I.*, London, 1837; Sir George Bowen, *The I. I. under British Protection*, London, 1850; Dr Davy, *I. I.*, London, 1842, containing many physical observations; H. Cook, *The I. I.*, London, 1841; Liebetritt, *Reise nach den Ionischen Inseln*, Hamburg, 1859; Lunzi, *Della repubblica settentrionale*, and various other works on the history of the islands by the same author; Anstet, *The I. I.*, London, 1863; Viscount Kirkwall, *Four Years in the I. I.*, London, 1864, vol. 1, containing a chronological history of the British protectorate; F. Lenormant, *La Grèce et les îles Ioniennes*, Paris, 1865; P. Hottel (Xavier), *Hist. des îles Ioniennes*, Zurich, 1815-64. Mardo's *Saggio di una descrizione geografica e storica delle Isole*, Corfu, 1865, is mainly geographical. Du Rossier's *Description des monnaies d'Ithaque et de Cephalonia*, London, 1815, is an early contribution to the subject, fully treated by Postolakas, *Karàlogos ton archaiou numismaton ton islandes Kerkiras, Leukados, &c.*, Athens, 1848. For the linguistic peculiarities of the islands reference may be made to Tsilicis, *Γλωσσάριον Κεφαλληνίας*, Athens, 1876.

IOWA, one of the north-western States of the American Union. Its boundary lines are—on the S. and N. the parallels 40° 36' and 43° 30' of N. lat., on the E. the Mississippi river, and on the W. the Missouri and Big

Sioux rivers. The south-eastern corner projects slightly below the parallel of 40° 36', the boundary following the Des Moines river down to its mouth. The neighbouring States are—Minnesota on the north, Wisconsin and Illinois on the east, Missouri on the south, and Nebraska and Dakota on the west. The length of the State from north to south is about 200 miles, and its greatest breadth from east to west 300 miles. Its area is 35,228,800 acres, or 55,045 square miles.

The State lies entirely within the prairie region of the Mississippi valley, and has a level or undulating surface. Its mean height above the sea is 925 feet,—ranging from 500 in the south-east to 1700 in the north-west. About 24,600 square miles of the area rise less than 1000 feet above sea-level.

The surface presents very little relief. A broad elevation (1700 feet at the north boundary, and decreasing gradually southwards) separates the waters of the Mississippi from those of the Missouri. The position of this "divide" is, for the most part, near the western border of the State, giving to the branches of the Mississippi long courses and an easy fall, while those of the Missouri have comparatively short courses and a rapid fall. Near their sources, these branches, both of the Mississippi and Missouri, flow in broad, shallow valleys. Farther down their courses, however, bluffs develop, and increase gradually in height, while the valleys in general become narrower. The bluffs bordering the valley of the Mississippi range in height from 200 to 400 feet, the valley between them being usually from 4 to 8 miles in width, although in a few places, as at Dubuque, they close in upon the river on both sides. On the Missouri, the bluff range from 200 to 300 feet in height, enclosing a bottom land 5 to 12 miles in width.

*Rivers and Lakes.*—The Mississippi and Missouri are the only navigable rivers. They have ample depth of water for all purposes of inland navigation. At two points upon the former river, indeed (at Rock Island and near Keokuk), there are rapids which at low water form partial obstructions to navigation; but at high water steamers can run them in either direction. A canal is now being made to facilitate the passage of the lower or Des Moines rapids, and works are projected for the improvement of the upper or Rock Island rapids. The other rivers are the Upper Iowa, Turkey, Maquoketa, Wapsipinicon, Iowa, Cedar, Skunk, or Checaqua, and Des Moines, flowing into the Mississippi, and the Chariton, Nodaway, Grand, Nishnabotany, and Little and Big Sioux, flowing into the Missouri. None of these streams are navigable. A few small lakes are found in the north-west, on or near the divide between the two great rivers. The area of swamp and marsh surface is proportionally small, and is rapidly diminishing.

*Forests.*—As in most of the prairie region of the Mississippi valley, there is in this State but little forest, the timber being confined to the bottom lands of the streams and the faces of the bluffs. The commonest trees are the oak, elm, cottonwood, black walnut, hickory, maple, and linden. Upon the bluffs is found a sparse growth of pines and red cedar.

*Geology.*—The geology of the State is remarkably simple; excepting in the north-western quarter, where the formations are so covered with Quaternary drift as to be unrecognizable, there is from north-east to south-west a succession of belts, from the Lower Silurian to the top of the Carboniferous, varying in breadth and extending north-west and south-east. The Silurian occupies but a comparatively small area in the north-eastern corner. A strip of Devonian follows, 40 to 50 miles in width, extending from Davenport on the Mississippi north-westward to the northern boundary. The south-western



half of the State is overlaid by the different members of the Carboniferous formation, with here and there fragments of Cretaceous beds, which have survived the enormous erosion to which the surface has everywhere been subjected.

*Minerals.*—It is estimated that about 7000 square miles are underlain by the Coal-measures. Within this area coal beds of workable thickness and quality have been found at Fort Dodge, Moingona, Des Moines, and Oskaloosa, where they are being extensively worked. The coal is bituminous, no anthracite having been found in the State. The north-eastern part of Iowa is included within the great lead region of the Upper Mississippi; and, although the palmy days of the mines of that region are over, the product is yet very important. The ore, which is galena, is found in pocket deposits in the limestones of the Silurian formation. These deposits vary immensely in size, and in general extend to no great depth, and therefore cannot be relied upon for permanence.

*Climate.*—The climate resembles in its essential features that of the rest of the prairie States, excepting that towards the west the aridity of the atmosphere and the decreased rainfall characteristic of the great plains begin to be perceptible. The annual rainfall ranges from 24 to 44 inches, with an average of about 36 inches, the south-eastern portion receiving the greatest amount, and the western part the least. The mean annual temperature ranges from 42° to 52° Fahr., the summer mean from 66° to 79° and the winter mean from 14° to 27° showing a difference between the summer and winter temperatures of 52°. The highest single observed temperatures have been 95° to 105°, and the lowest 18° to 33° below zero, an extreme range of about 125°. The south-eastern portion has the mildest and most equable temperature, as well as the greatest rainfall. Northward and westward the temperature becomes lower and extremes greater.

*Soil.*—The soil is extremely fertile, whether drift, bluff, or alluvial. The drift, whose name explains its origin, covers the greater part of the State. It is a dark loam, 1 to 2 feet in depth, and of almost inexhaustible fertility. The bluff soil or loess occupies the country bordering upon the valley of the Missouri. It is supposed to be a subaerial deposit, brought by the prevalent westerly winds from the

plains of Nebraska and Dakota, and deposited here near the borders of the humid region. It has a great depth, reaching 200 feet in some instances, and is everywhere extremely rich. The alluvial soil, found in the valleys and bottom-lands, is the deposit of the streams, and varies in composition with the country which the streams have traversed above. Much of it on the Missouri and its branches is composed of loess, while that on the Mississippi is mainly altered drift deposits.

*Agriculture.*—The agricultural interest is by far the largest and most important of the State. In the production of Indian corn it ranks second, and of wheat fifth, among the States of the Union. The following table, taken from the report of the department of agriculture, shows the amount of the agricultural products for 1879:—

	Number of acres under each Crop.	Product.	Value.	Average yield per acre.
Indian Corn .....	4,873,400	Bushels.	\$	Bushels.
Wheat .....	3,214,400	185,189,200	44,445,468	38 0
Rye .....	23,400	32,786,880	30,163,930	10 2
Oats .....	1,034,900	365,040	197,122	15 6
Barley .....	195,000	37,256,400	8,568,972	36
Buckwheat .....	8,000	4,290,000	1,936,500	22
Potatoes .....	105,700	144,000	99,360	18
Hay .....	2,314,286	9,090,200	2,908,864	86
		Tons.		Tons.
		3,564,000	16,180,560	1 54

The numbers of different classes of live stock were—horses, 778,400; mules, 44,700; milch cows, 724,500; other cattle, 1,370,400; sheep, 454,400; hogs, 2,778,400. In number of horses Iowa ranks as the fifth, of milch cows and other cattle third, and of hogs second, among the States. The average value of cleared farming land in the State in 1879 was \$27 30 per acre; of timber land, \$39 36. The increased value of the latter is due to the scarcity of forests. The average monthly wages paid to agricultural labourers during the same year was \$23 26; average daily wages, on transient employment, \$2 01.

*Manufactures.*—The manufacturing industries have not yet reached a high degree of development. Those branches connected with agriculture have naturally made most advance. The following statistics, from the results of the tenth census (1880), show the condition of these industries.

Industries, 1880.	Number of Establishments.	Capital.	Greatest number of Hands employed at any one time during the Year.	Average day's wages for a Skilled Mechanic.	Average day's wages for an Ordinary Labourer.	Total amount paid in wages during the Year.	Materials.	Products.
Agricultural implements.....	58	\$1,085,530	1075	2 06	1 26	\$235,335	\$559,861	\$1,148,872
Boots and shoes .....	543	477,077	1025	1 76	1 23	253,681	445,443	1,179,811
Bricks and tiles.....	276	474,614	2760	2 08	1 17	370,929	227,637	935,507
Carpentering and building....	374	531,660	2664	2 06	1 34	536,924	1,197,845	2,175,346
Cheese and butter.....	237	742,633	897	1 50	95	127,430	1,087,645	1,555,188
Flouring and grist mill products..	701	7,950,560	3025	2 09	1 14	845,714	16,567,552	21,062,744
Lumber, sawn and planed .....	332	5,035,440	5886	1 88	1 23	1,399,779	3,805,696	6,401,940
Printing and publishing.....	151	1,150,786	1384	2 00	1 17	509,529	523,536	1,431,589

*Communication.*—For means of communication and transportation Iowa is dependent almost entirely upon its railroads and its two bounding rivers. It has no canals, if we except the short one around the Des Moines rapids.

In 1880 there were forty-five railroads, working 4779 miles of track, with a total capital stock of \$60,000,000, and a funded debt of \$44,400,000. The total amount invested in railroads exceeded \$100,000,000. The total gross earnings of the companies from passengers, freight, and mails was \$5,218,000, of which \$1,415,000 or 27 per cent. were net earnings. This is but 2 <sup>3</sup>/<sub>10</sub> per cent. on the capital stock.

*Banks.*—According to the report for 1880 of the controller of the currency, there were in operation in Iowa

75 national banks, having a capital of \$5,837,000, and an outstanding circulation of \$4,697,314; 60 State banks and trust companies, with a capital of \$2,521,985, holding \$6,100,367 of deposits; 245 private bankers, representing a capital of \$2,583,754, with deposits amounting to \$7,017,806; and 4 savings banks, with a capital of \$18,167, having deposits amounting to \$208,018.

*Administration.*—As in the other States, the governmental power is divided among three departments, known as the executive, legislative, and judicial.

The officers of the executive department are the governor, lieutenant-governor, secretary of state, auditor, treasurer, superintendent of public instruction, and register of the State land office. All these officers are elected by the





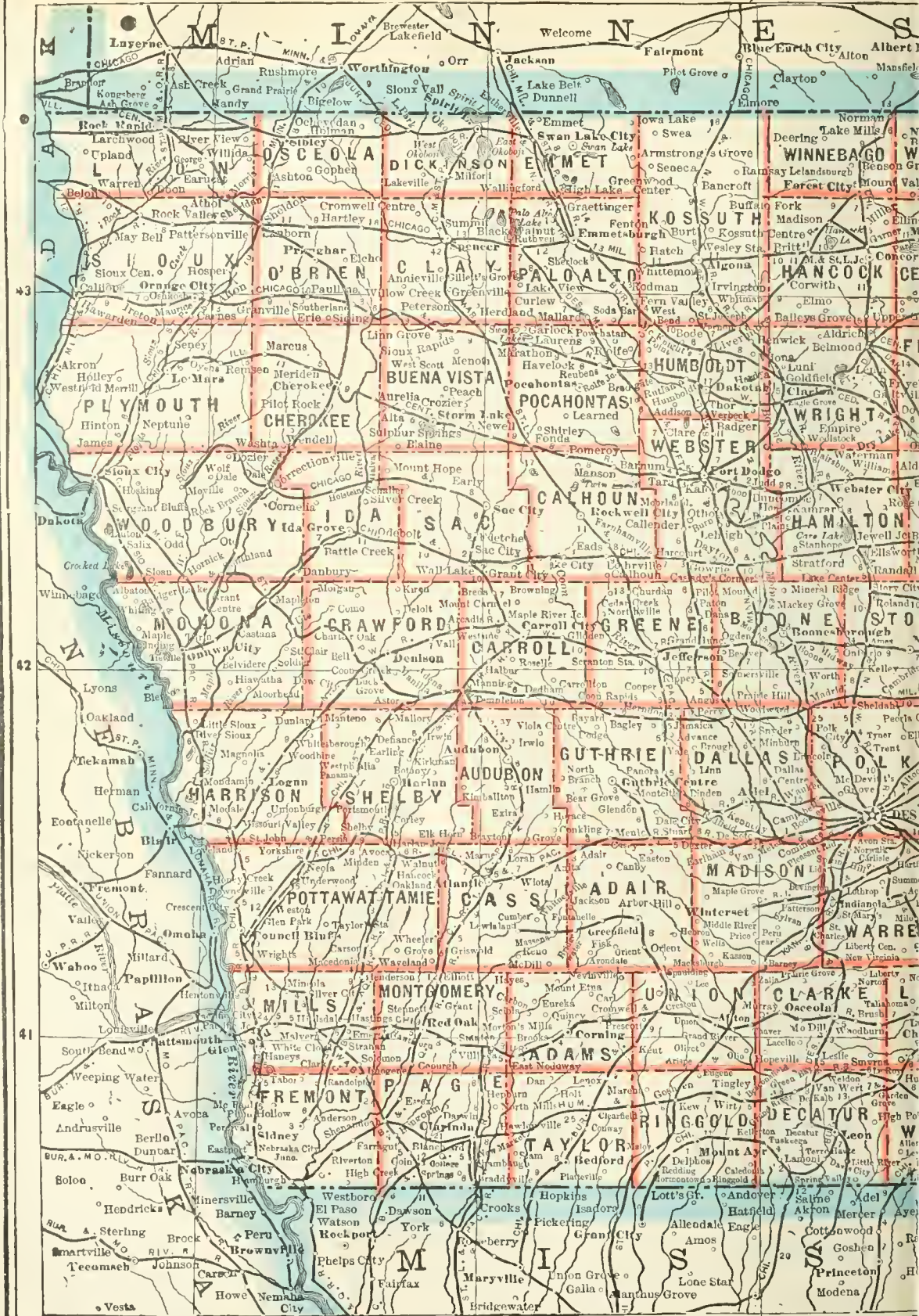



# IOWA

SCALE OF MILES

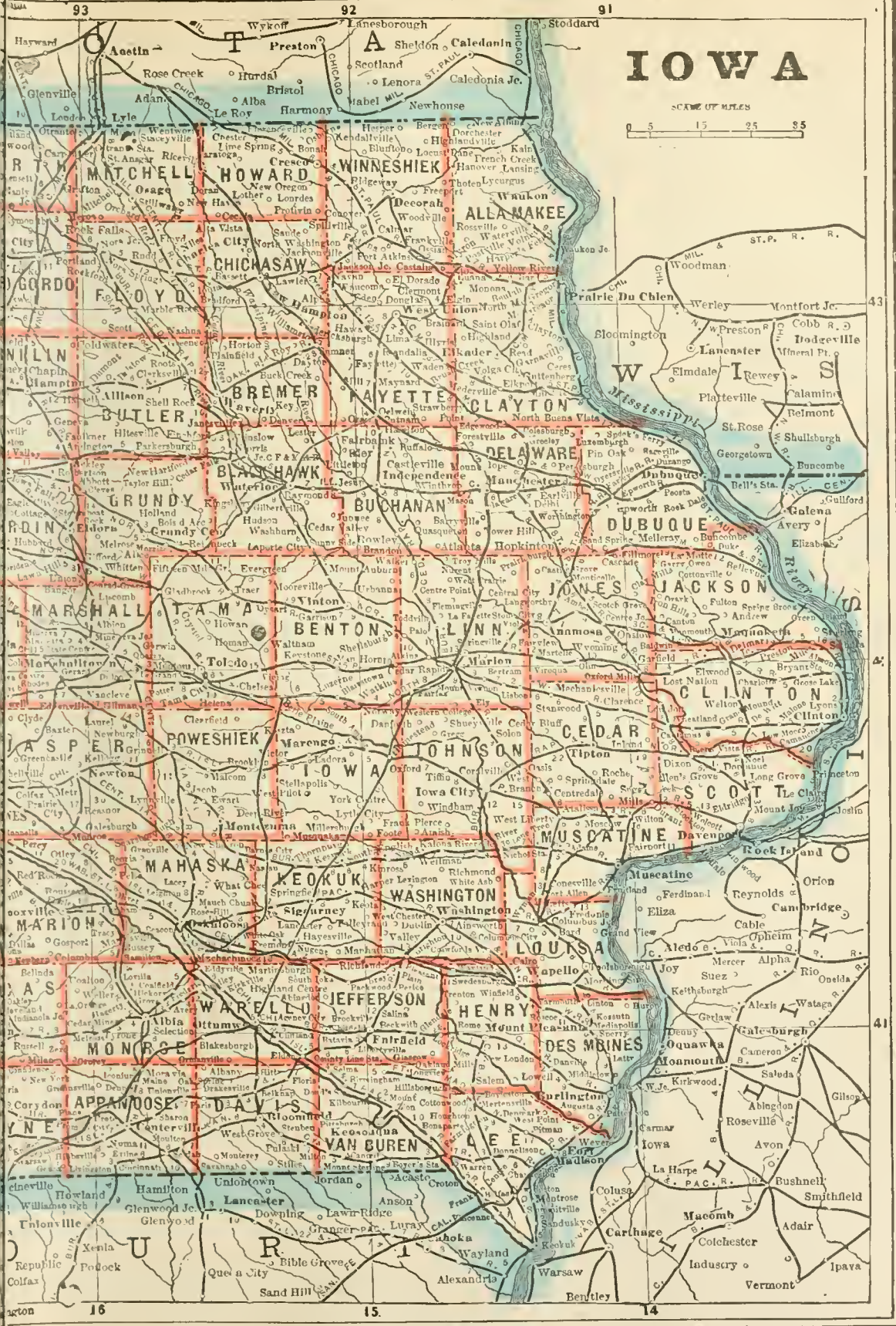
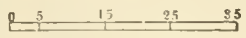

93

92

91

16

15

14









**IPECACUANHA.** The root used in medicine under this name is obtained from *Cephaelis Ipecacuanha*, A. Rich., a small shrubby plant of the natural order *Cinchonaceae*. It is a native of Brazil, growing in clumps or patches in moist shady forests from 8° to 22° S. lat., and is believed to extend to the Bolivian province of Chiquitos, and the valley of Cauca in New Granada. The drug of commerce is procured chiefly from the region lying between the towns of Cuyaba, Villa Bella, Villa Maria, and Diamantina in the province of Matto Grosso, and near the German colony of Philadelphia, north of Rio Janeiro. Ipecacuanha, although in common use in Brazil, was not

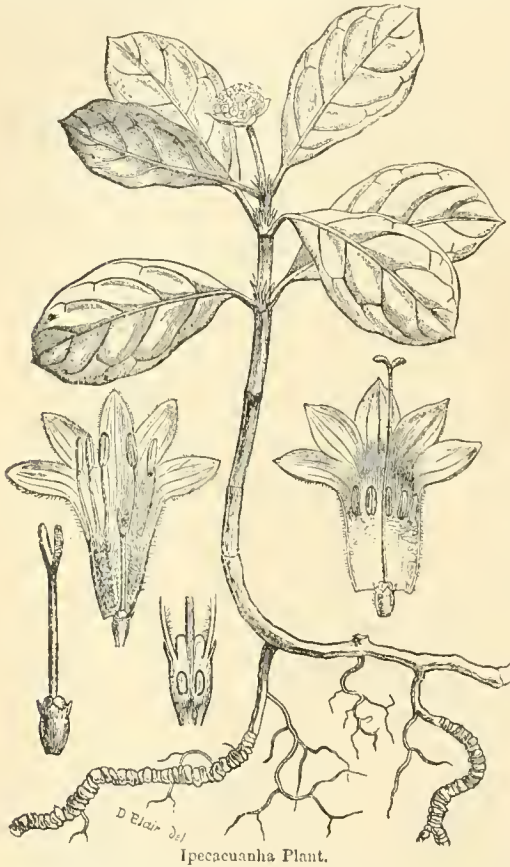

Ipecacuanha Plant.

employed in Europe previous to 1672. In France within a few years after that date it formed the chief ingredient in a remedy for dysentery, the secret of the composition of which was purchased by the French Government for 1000 louis d'or, and made public in 1688. The botanical source of ipecacuanha was not accurately known until 1800.

The mode of obtaining the root is thus described by Weddell. The collector or *poayero* grasps the whole of the stems of the *poaya* or ipecacuanha plant in one hand, and loosens the roots by inserting a stick obliquely under them, to which is given a see-saw motion; the adhering soil is then shaken off, and the root placed in a bag. A *poayero* collects on the average about 10 to 12 lb of the root in a day, but sometimes as much as 30 lb, or as little as 6 lb or 8 lb. The root requires to be dried rapidly; it is therefore spread out in the sunshine as much as possible, and at night is covered over to shield it from the dew. In about three days, under favourable circumstances, it becomes dry, and is then broken up, sifted to remove sand or dirt, and packed in "serons," or bales made of cowhide.

The root is gathered during the whole of the year, but in less quantity during the rainy season on account of the difficulty of drying the root. As imported, about three packages out of four are damaged by sea-water or damp. The root appears to be possessed of very great vitality, for in 1869 M'Nab, the late curator of the Botanical Gardens of Edinburgh, discovered that so small a portion as  $\frac{1}{8}$  of an inch of the annulated root, placed in suitable soil, would throw out a leaf-bud and develop into a fresh plant, while Lindsay, a gardener in the same establishment, proved that even the leaf-stalk is capable of producing roots and buds; hence there is but little probability of the plant being destroyed in its native habitat. The great value of the drug in dysentery, and its rapid increase in price from an average of 2s. 9 $\frac{1}{2}$ d. per lb in 1850 to about 8s. 9d. per lb in 1870, led to attempts to acclimatize the plant in India, which, however, have not hitherto proved to be a commercial success, owing to the difficulty of finding suitable spots for its cultivation, and to its slowness of growth. Like other dimorphic plants, ipecacuanha ripens seeds best when cross-fertilized, and presents various forms. Two of these have been described by Professor Balfour of Edinburgh, one distinguished by having a woody stem, firm elliptic or oval leaves, with wavy margins and few hairs, and the other by an herbaceous stem, and leaves less coriaceous in texture, more hairy, and not wavy at the margins. This diversity of form is most apparent in young plants, and tends to disappear with age.

Ipecacuanha root occurs in pieces about 2 or 3 lines in thickness, of a greyish-brown or reddish-brown tint externally, having a ringed or annulated surface, and exhibiting a white or greyish interior and a hard wiry centre. It has a faint rather musty odour, and a bitterish taste. It is usually mixed with more or less of the slender subterranean stem, which has a very thin bark, and is thus easily distinguished from the root. The activity of the drug resides chiefly in the cortical portion, and hence the presence of the stem diminishes its value. The variety imported from New Granada and known as Cartagena ipecacuanha differs only in its larger size and in being less conspicuously annulated. Ipecacuanha owes its properties to the presence of rather less than 1 per cent. of the alkaloid emetine, which, with the exception of traces, occurs only in the cortical portion of the root. The formula assigned to emetine has been variously stated by different chemists, that published by Lefort and Wurtz in 1877 is  $C_{25}H_{40}N_2O_5$ . Emetine is a white powder, turning brown on exposure to light, and softening at 70° C. (158° Fahr.). It is precipitated from its solution by tannin and nitrate of potassium, and is soluble in chloroform, but only slightly so in ether. A solution containing only  $\frac{1}{1000}$  part of emetine has been shown by Power to become of an intense and permanent yellow colour when treated with a solution of chlorinated lime and a little acetic acid. Emetine exists in the root in combination with ipecacuanhic acid, which according to Reich is a glucoside. It is amorphous, bitter, and very hygroscopic. The root contains also about 37 per cent. of starch, a large quantity of pectin, and small proportions of resin, fat, albumen, and fermentable and crystallizable sugar.

Ipecacuanha is one of the safest and most valuable emetics, being more suitable for administering to children than any other. The amount required to produce its effect varies considerably, children as a rule being more tolerant than adults: according to Ringer, thirty grains is the average dose for an adult, twenty grains for young children. Its action is rather slow, taking place in from 20 minutes to half an hour after ingestion. Minute quantities of the drug, on the contrary, such as drop doses of ipecacuanha wine every hour or three times a day,

according to the urgency of the case, have the effect of checking vomiting arising from natural causes. The nauseating and emetic properties of ipecacuanha are believed to be due to its influencing the peripheral terminations of the pneumogastric nerve, since it produces vomiting even if injected into the blood. In nauseating doses it acts both as a diaphoretic and antispasmodic. It is also a stimulant or irritant of the mucous membranes, and is hence classed as an expectorant, and used successfully in cough, bronchitis, gastric catarrh, and diarrhoea. Some individuals are so sensitive to the action of ipecacuanha as to suffer, even on smelling the drug on entering a room where it is kept, all the symptoms of coryza, hay fever, or bronchitis. In large doses of from 60 to 90 grains, repeated if required in 10 or 12 hours,—the patient lying on his back to prevent sickness or nausea,—it is found to be one of the most valuable remedies in dysentery, especially in the epidemic and sporadic forms met with in tropical and malarious countries. Externally applied in the form of ointment, ipecacuanha causes considerable irritation, followed by the appearance of pustules and ulceration. In doses of one-eighth to one-sixth of a grain it acts as a stomachic, and probably increases the gastric secretions.

Other plants to which the name of ipecacuanha has been popularly applied are American ipecacuanha (*Gilenea stipularia*, Spreng.), Wild ipecacuanha (*Euphorbia ipecacuanha*, L.), Bastard ipecacuanha (*Asclepias curassavica*, L.), Guiana ipecacuanha (*Dochmania decumbens*, Vahl), Venezuela ipecacuanha (*Sarcostemma glaucum*, H. B.), and ipecacuanha des Allemands (*Vincetoxicum officinale*, Moench.). All these possess emetic properties to a greater or less degree.

The term *poayu* is applied in Brazil to emetic roots of several genera belonging to the natural orders *Cinchonaceæ*, *Violaceæ*, and *Polygalaceæ*, and hence several different roots have from time to time been sent over to England as ipecacuanha; but none of them possesses the ringed or annulated appearance of the true drug. Of these the roots of *Touitidium ipecacuanha*, Vent., *Richardsonia scabra*, St. Hil., and *Psychotria emetica*, Mutis, are those which have most frequently been exported from Brazil or New Granada.

See *Pharmacographia*, 2d ed., pp. 370-376; Bentley and Trimen, *Medicinal Plants*, 20; Martius, *Systema Materiae Medicæ Brasiliensis*, p. 91-94; Riiger, *Handbook of Therapeutics*, 8th ed., p. 406; Bartholow, *Materia Medica and Therapeutics*, pp. 423-428. (E. M. H.)

IPEK (112,000) (Slavonic, *Pelcha*; Albanian, *Peja*; Latin, *Pescium*), a town of Upper Albania, in the Turkish eyalet of Uskub, situated in the upper valley of the Drin between the mountains Peklen and Kopronik. A small stream, bearing like several others in the Balkan peninsula the name of Bistritza (the bright or clear), flows through the town. On one of the neighbouring heights is situated the monastery of Ipek, founded by Archbishop Arsenius in the 13th century, and famous as the ancient seat of the patriarch of the Servian Church. The buildings are surrounded by thick walls, and comprise a large central church (Our Lady's), and two side chapels (the Martyrs and St Demetrius), each surmounted by a leaden cupola. The church dates from the 16th and 17th centuries. Among its numerous objects of interest are the body of Archbishop Nicodemus, the white marble tombs of Arsenius and other chiefs of the Servian Church, and the white marble throne on which the patriarchs were crowned. The side chapels have stained glass windows. According to some authorities, Ipek occupies the site of Dioclea, destroyed by the Bulgarians in the 11th century. In the Turkish administration it is the seat of a pasha with two tails, and at one time the pashalik had become almost a hereditary government. The population of the town was calculated by Bonó (1823, 1845) at 8000 and by Dr Müller (1844) at 12,000. Jourisbitch, the Servian author, states the number of houses at 4000. In the recent troubles of Turkey Ipek has suffered, and in 1876 the Turkish officials closed the monastery.

See Boué, *Minéraire de la Turquie*; Irby, *The Slavonic Provinces of Turkey*, 1867; Barth, *Reise durch das Innere der Europäischen Türkei*, Berlin, 1864.

IPHICRATES, an Athenian general who flourished in the earlier half of the 4th century B.C., owes his fame as much to the improvements which he made in the accoutrements of the peltasts or light-armed troops as to his numerous victories gained by their aid. Increasing the length of their javelins and swords, substituting linen corselets for their heavy coats-of-mail, and introducing the use of light shoes, called after him *Iphicratides*, he increased greatly the rapidity with which these troops could make the sudden forays that were so common in the military tactics of the time. With his peltasts Iphicrates seriously injured the allies of the Lacedæmonians in the Corinthian war, and in 392 succeeded in dealing a heavy blow at once to the vanity and the prestige of the Spartans, by almost annihilating a body of their famous hoplites. Following up his success, he took city after city for the Athenians but his arrogance procured his transfer from Corinth to the Hellespont, whither, however, his success followed him. About 378 he accepted a command under the Persians in Egypt, and on his return thence to Athens commanded an expedition in 373 for the relief of Corcyra, which was menaced by the Lacedæmonians. On the peace of 371 Iphicrates seems to have returned to Thrace, and some what tarnished his fame by siding with his father-in-law King Cotys, in a war against Athens for the possession of the entire Chersonese. The Athenians, however, soon pardoned him and gave him a joint command in the social war. For his conduct in this position he was impeached after his acquittal he lived quietly at Athens. The date of his death is unknown.

See Rehdantz, *Vita Iphicratis, Chabrix, et Timothei*.

IPHIGENEA is the heroine of several famous Greek legends. She is generally said to be the daughter of Agamemnon, and is also called Iphianassa, though the two are distinguished by Sophocles and by the writer of the *Cyprica*. Agamemnon had offended Artemis, who therefore prevented the Greek fleet from sailing for Troy, and could be appeased only by the sacrifice of his daughter. According to some accounts the sacrifice was completed according to others Artemis carried away the maiden to be her priestess in the Tauric Chersonese, and substituted for her a hind. In this new country it was her duty to sacrifice to the goddess all strangers; and as Orestes came in search of her she was about to sacrifice him, when a happy recognition took place. These legends show how closely the heroine is associated with the cultus of Artemis and with the human sacrifices which accompanied it in older times before the Hellenic spirit had modified the barbarism of this borrowed religion. They bring into connexion the different places in which this goddess was worshipped; and, as Attica was one of her chief seats Iphigeneia is sometimes called a daughter of Theseus. A Comana in Cappadocia, one of the chief homes of the goddess in her more barbaric form, there was a priestly family Orestiadæ; and Iphigeneia and Orestes are named as the founders of Artemis worship in Sparta and Attica as well as in many parts of Asia Minor and Italy (see Preller, *Griech. Mythol.*, 3d ed., i. 250). At Hermione Artemis was worshipped with the epithet Iphigeneia—this showing the heroine to be in the last resort a form of that goddess. Iphigeneia is a favourite subject in Greek literature and art. She is the heroine of two plays of Euripides; but none of the many other tragedies founded on her story have been preserved. In vase paintings she frequently occurs; and the picture by Timanthes representing Agamemnon hiding his face at her sacrifice was one of the famous works of antiquity.



IPSWICH (50,000), Old Eng. *Gippeswic*, the county town of Suffolk, 68 miles north-east of London by rail, stands on a gentle ascent above the left bank of the Gipping, which widens here into the Orwell estuary. Its lower and older portion, irregularly built, retains some curious specimens of ancient domestic architecture, as Sparrow's House (1567), with quaint emblematic mouldings of Charles II.'s reign, Archdeacon's Place (1471), and Wolsey's Gateway (1528), sole relic this of one of those "twins of learning," the colleges of Christ Church and Ipswich. The public buildings, however, are one and all of them modern. The town-hall (1868) is an imposing edifice in the Venetian style, surmounted by a clock-tower 120 feet high, and beautified with statues and medallions. Close by, and



Plan of Ipswich.

similar in style, are the post-office (1880) and the new corn-exchange (1880-81), and a second good group is formed by the new museum and fine art gallery (1880-81), the former of which, founded in 1847, has a splendid collection of red crag fossils. Other buildings are the East Suffolk Hospital (1836-69), militia artillery barracks (1855), custom-house (1845), mechanics' institute (1824; greatly enlarged 1877), working men's college (1862), public hall (1868), and a little theatre; where Garrick made his debut in 1740. The grammar school, dating from at least 1477, was last refounded by Queen Elizabeth in 1565, and was rebuilt in 1851 on the northern outskirts of the town, the Prince Consort laying the foundation stone. It is a red brick Tudor pile, with a

pretty chapel, has 6 masters and 85 boys, and is endowed with 11 scholarships of an aggregate yearly value of £302. Fourteen board schools had an average attendance of 2426 in May 1880, when there were twenty-two other elementary schools, attended by 3130 children. The older of the sixteen churches are all of them towered flint-work structures, wholly or mainly Perpendicular in style, with the exception of St Peter's (restored and enlarged in 1877), which is Decorated. They include St Margaret's (restored 1846-74), with a beautiful oak Tudor roof, elaborately painted *temp.* William and Mary; St Matthews (restored 1860), St Lawrence (1431; restored 1858); and St Clement's (restored 1860-80), containing the tomb of Eldred, an early circumnavigator. St Michael's (1880) is a wholly new erection in Early English style, and three other churches have practically been rebuilt—St Mary-le-Tower (1863-66), rich in oak carving and painted glass, with a tower and spire 176 feet high, and a peal of twelve bells; St Helen's (1877-78), also with a spire; and St Mary (1871) at Stoke, a suburb south of the Gipping. Of non-established places of worship the Roman Catholic church of St Pancras (1863) is the most noticeable, a late First Pointed edifice with a richly carved reredos and a lofty flèche. Ipswich has two finely planted arboretums, the upper one of which is public; alongside stretches Christ Church park, with its picturesque Tudor mansion (1549). There are shady walks too, between the river and a wet dock, which, formed in 1842 at a cost of £130,000, covers 32 acres, and admitted vessels drawing 14 feet. Under an Act obtained in 1877 the commissioners have expended £80,000 more in making a new entrance lock, to admit vessels drawing 18 feet, in erecting public warehouses, and in deepening and improving the river.

In 1879, 264 vessels of 54,353 tons entered from, and 89 of 11,406 tons cleared to, foreign countries and British possessions; coastwise there entered 2405 of 152,161, and cleared 1792 of 118,624 tons. There were 125 vessels of 9779 tons, besides 23 fishing boats, registered as belonging to the port on 31st December of that year, in which the customs revenue amounted to £20,828, the chief imports being coal (51,720 tons), linseed, cotton seed, maize, barley, iron, and iron pyrites; the exports, wheat, malt, flour, artificial manures, and agricultural implements. The last are manufactured at the Orwell Works (1785) of Ransomes, Sims, & Head, the greatest in the world, covering 13 acres, and employing over 1400 hands. Shipbuilding (27 vessels of 1965 tons during 1875-79), brewing, tanning, and the manufacture of manure from coprolites, and of silk, flax, ropes, and artificial stone, are the leading industries. Ipswich returns two members to parliament. The borough has an area of 8192 acres. The population, which in 1871 was 42,947, had increased in 1881 to 50,213.

A pavement found in Castle Field in 1854 establishes the presence of the Romans, but Ipswich is first mentioned in history as having been plundered by Northmen in 991 and 1000. Lying out of the course of events, it has played no conspicuous part, and the chief incidents in its history are the granting of its earliest charter by John (1199); the visits of Edward I. (1297), Edward III. (1350), Elizabeth (1561, 1565, and 1578), and George II. (1737); the meeting of the British Association (1851) and of the British Archaeological Association (1864). Thomas Wolsey (1471-1530), William Butler (1535-1618), Bishop Ralph Brownrigg (1592-1659), Clara Reeve (1738-1803), and Mrs Trimmer (1741-1810) were natives; and Gainsborough, a resident from 1747 to 1759, has given his name to a beautiful lane above the "pincely" Orwell. See G. R. Clarke's *History of Ipswich*, Ipswich, 1830.

IPSWICH (7734), the second most important town of Queensland, Australia, is built on the south side of the river Bremer at the head of navigation, about 24 miles in a westerly direction from Brisbane, in 27° 35' S. lat. and 152° 50' E. long. It is the centre of a rich pastoral and agricultural district, the principal product being maize. Coal is worked on the banks of the Bremer and the Brisbane, and there is a woollen factory in the town. A courthouse, a hospital, a lunatic asylum, a grammar school, opened in 1863, and a school of arts are among the public buildings. The first sale of crownlands took place on October 11, 1843: and the first steamer between Brisbane

and Ipswich was run June 29, 1846. It was in 1860 that the town was incorporated as a municipality, and in the same year was held the first session of the supreme court. The railway to Brisbane was opened in 1875. The value of ratable property is estimated at about £350,000. In 1871 the population of Ipswich was 4820; in 1876, including the suburbs, it was 7734.

**IQUIQUE**, a seaport town of Peru, in the department of Tarapaca, in 20° 12' S. lat. In the twenty-five years from 1850 to 1875 it rose from a mere fishing village to be a place of from 18,000 to 20,000 inhabitants. This rapid growth was solely the result of the trade in the nitrate of soda which is found in exhaustless abundance in the neighbouring country, and of which during the five years 1874 to 1878 there was annually exported from the province, by way of Iquique, Mejillones, Junin, and Pisagua, an average of 276,811 tons. About 60 or 70 tons of iodine are also manufactured in the nitrate of soda factories, varying in proof from 95 to 98 per cent. There entered and cleared in 1877 253 vessels, of which 142 were English, the total burden being 138,054 tons. As there is no cultivable land in the vicinity, all provisions have to be imported. In 1875 the town was laid waste by a conflagration; and it had hardly begun to recover from this disaster when it was visited in 1877 by a series of earthquakes. The wooden houses which fell at the first shock took fire, and while the firemen were endeavouring to extinguish the flames a huge wave rushed in and carried off their engines. The people suffered severely both from hunger and thirst, as the principal store and the water condensers were both destroyed. The total damage was estimated at £800,000. In 1878 there were only 7000 or 8000 people in the town, which, however, has been rebuilt with greater attention to solidity of architecture and regularity of plan.

**IRAK ADJEMI** (*i.e.*, Persian Irak), also called **JEBAL** (Arabic, mountains) and **KOHISTAN** (Hindustani, mountain-land), is the most important of the eleven provinces of Persia, comprising the larger part of the western half of the country, or upwards of 138,280 square miles. To the north lie Azerbaijan, Ghilan, and Mazanderan, to the east Khorasan, to the south Farsistan and Kluzistan, and to the west Ardilan and Luristan. The mountains for the most part run west and east, or north-west and south-east. Among the important valleys are those of Hamadan, Ispahan, and Yezdikhast. The principal river—though it only belongs to Irak Adjemi in the middle part of its course—is the Kizil Uezen or Sefid Rud, which drains about 25,000 square miles of country, rising between Hamadan and Tabriz, in that part of the Kurdistan highlands which bears the name of Besch Parmak or Pentchangusht (Five-Finger Mountain), flowing north-north-east and then east to its junction with the Hasht Rud, and finally breaking through the Elburz range and finding its way to the Caspian. The rest of the rivers for the most part flow towards the Great Salt Desert, which forms part of the wide eastern plain that stretches eastward into Khorasan. The following are points whose position has been fixed. Teheran, the capital, 35° 40' 33" N. lat., 51° 24' 54" E. long.; Kum, 34° 39' N. lat., 53° 53' 54" E. long.; Kushan, 34° N. lat., 51° 26' 39" E. long.; Ispahan, 32° 37' 30" N. lat., and 51° 39' E. long. The name Irak Adjemi is a modern one, and Reynaud confesses that he knows no other origin of its use than the fact that the Seljukids who reigned over Irak and bore the title of Sultan el Irak were also rulers of the Jebal. The country corresponds in large part to the ancient Media.

**IRAK ARABI**, or **IRAK EL ARABI**, to which the name Irak is more properly applied, is the district between the Tigris and Euphrates, and from the Euphrates west to the desert, its northern limit being from Anah on the Euphrates

to Tekrit on the Tigris. It corresponds to the land of Chaldæa or Lower Mesopotamia. There is a town Irak in the district, about 20 miles east of the Euphrates.

**IRAWADI**, or **IRRAWADDY**, the principal river in the province of British Burmah, traversing the Pegu division from north to south. The Irawadi is formed by the junction of two streams whose source is as yet unknown, in about 26° N. lat. The chief tributaries are the Mogoung, from the westward, which throws its water into the main stream (here 600 yards wide), in 24° 50' N. lat., and the Shwe li and Kyeng-dweng. Shortly after leaving the mouth of the Mogoung it enters the first or upper defile. Here the current is very rapid, and the return waters occasion violent eddies and whirlpools. When the river is at its lowest, no bottom is found even at 40 fathoms. After receiving the Ta-peng from the east, it enters the second defile, which is exceedingly picturesque, the stream winding in perfect stillness under high bare rocks rising sheer out of the water. Farther down the Irawadi, and not far from Mandalay, is the third or lowest defile. The banks are covered at this point with dense vegetation, and slope down to the water's edge; at places appear almost perpendicular but wooded heights. The course of the Irawadi after receiving the waters of the Myit-uge and Tsagaing, as far as 17° N. lat., is exceedingly tortuous; the British frontier is crossed in 19° 29' 3" N. lat., 95° 15' E. long., the breadth of the river here being  $\frac{3}{4}$  mile; about 11 miles lower down it is nearly 3 miles broad. At Akouk-toung, where a spur of the Arakan hills ends in a precipice 300 feet high, the river enters the delta, the hills giving place to low alluvial plains, now protected on the west by embankments. From 17° N. lat. the Irawadi divides and subdivides, converting the lower portion of its valley into a network of intercommunicating tidal creeks. It reaches the sea in 15° 50' N. lat. and 95° 8' E. long., by nine principal mouths. The only ones used by sea-going ships are the Bassein and Rangoon mouths. The area of the catchment basin of the Irawadi is 158,000 square miles; its total length from its known source to the sea is about 900 miles, the last 240 of which are in British territory. As far down as Akouk-toung in Henzada district its bed is rocky, but below this sandy and muddy. It is full of islands and sandbanks; its waters are extremely muddy, and the mud is carried far out to sea. The river commences to rise in March; about June it rises rapidly, and attains its maximum height about September. The total flood discharge for 1877 was 466,120,288,940 metre tons of 37 cubic feet. The river is navigable at all seasons by steamers of light draught as high as the first defile, and during the dry season for steamers drawing 6 feet as far as the frontier. The chief tributaries of the Irawadi in British territory are the Tha-hün (or Theug-dün), the Tha-de, and Thai-lai-dan from the west; and the Kye-ni, Bhwtlay, and Na-weng from the east. Below Akouk-toung on the west and Prome on the east the Irawadi receives no tributaries of any importance.

The broad channel of the Irawadi has always been the sole means of communication between the interior and the seaboard. From time immemorial the precious stones, minerals, &c., of Upper Burmah, Siam, and the Chinese frontier provinces have been brought down by this route. At the present day the great bulk of the trade is in the hands of the "Irrawaddy Flotilla Company," an important English carrying firm; but native boats still maintain a strenuous competition. The flotilla of the company consists of about sixty vessels, including both steamers and flats. They employ about 1770 hands, European and native, and distribute in wages upwards of £50,000 a year. Their headquarters are at Rangoon, whence steamers run twice a week to Bassein, and also to Mandalay.



The latter service is continued twice a month to Bhamo, about 1000 miles from the sea. The principal articles carried up stream are Manchester piece goods, rice, salt, hardware, and silk. The articles carried down stream are raw cotton, cutch, india-rubber, jade, spices, precious stones, timber, earth-oil, and dry crops, such as wheat and pease. The value of the trade either way is roughly estimated at about  $1\frac{1}{2}$  millions sterling. The total number of native boats on the Irawadi is returned at about 8000. They carry a large proportion of the heavy articles of commerce, especially cutch and earth-oil.

IRBIT, a town of European Russia in the government of Perm, 70 miles north-east of Ekaterinburg, at the confluence of the Irbit with the Nitza, a sub-tributary of the Obi. Though the St Petersburg Calendar for 1878 gives the permanent population as only 4212 (in 1860 the number was 3408), it is one of the most important trade centres of northern Russia, and during its great fair (February 1-13 to March 1-13) it is visited by upwards of 20,000 people. Among its public buildings are a theatre, an exchange, a bank (established in 1849, with a capital of 30,000 roubles), and a district school. Irbit was originally founded by Tartars in 1633, but the discovery of iron ore in the neighbourhood soon attracted Russian settlers. The

assistance which the inhabitants rendered in the suppression of the Pugatcheff rebellion was rewarded by Catherine granting Irbit the rank of a town in 1775. In 1781 it was made a district town of Perm. The right of holding the fair was bestowed by Michael Theodorovitch as early as 1643, and from 1695 the customs which had previously been collected at Verkhoturaya were taken at Irbit itself.

In 1829 the value of the wares brought to market amounted to 10,838,155 roubles (£1,723,916), and these were sold to the value of 7,537,489. In 1861 the corresponding figures were 51,204,000 roubles and 39,397,500. In 1859 the principal items were (a) of Russian goods: leather and skins, 6,780,000 roubles; furs, 4,750,000; copper and iron, 1,252,000; grain, salt, meat, and fish, 1,207,000; fruit and groceries, 1,115,000; wooden wares, 1,040,000; (b) of European wares: cotton, woollen, and silk, 12,087,000; sugar, 2,650,000; groceries 860,000; (c) of Asiatic goods: tea, 29,500,000. In 1880 the fur trade was especially active, no fewer than 3,550,000 Siberian furs and 110,100 Russian furs being brought to market. The tea, on the other hand, did not go beyond the value of  $5\frac{1}{2}$  million roubles. There is a horse fair at Irbit, October 25th (September 10th), when old horses are disposed of by Tobolsk and Tyumen Tartars. The Irbit iron-works are situated 40 miles from the town, on the banks of the river Irbit, below the confluence of the Shaitanka, which flows out of Irbit lake, a sheet of water nearly 4 miles long and  $2\frac{1}{2}$  miles broad. The inhabitants of the spot numbered 1822 in 1869 (861 men and 961 women). In 1873 the output of pig iron was about 2000 tons. The Irbit post-road leaves the great Siberian road at Kamnischoff, 73 miles from the town.

## I R E L A N D

### PART I.—GEOGRAPHY AND STATISTICS.

IRELAND, a large island to the west of Great Britain, and along with it forming the United Kingdom, extends from  $51^{\circ} 26'$  to  $55^{\circ} 21' N.$  lat., and from  $5^{\circ} 25'$  to  $10^{\circ} 30' W.$  long. It is encircled by the Atlantic Ocean, and on the east is separated from Great Britain towards the north by the North Channel, whose width at the narrowest part, between the Mull of Cantyre and Torr Head, is only  $13\frac{1}{2}$  miles; in the centre by the Irish Sea, whose width is 130 miles; and in the south by St George's Channel, which has a width of 69 miles between Dublin and Holyhead, and of 47 miles at its southern extremity. The island has the form of an irregular rhomboid, the largest diagonal of which, from Torr Head in the north-east to Mizen Head in the south-west, measures 302 miles. The greatest breadth of the island is 174 miles, and the average breadth about 110 miles. The total area comprises 32,535 square miles, or 20,822,494 acres. Territorially it is divided into 4 provinces—Leinster, Munster, Ulster, and Connaught—and 32 counties, the number of counties included in the different provinces being 12, 6, 9, and 5 respectively. These 32 counties are divided into 316 baronies, comprising 2532 parishes, which are further divided into townlands or ploughlands numbering about 60,760, with an average size of over 300 acres each. Table I. shows the area and distribution of land by provinces and counties in 1880.

*Geology.*—The central part of Ireland is occupied by a great undulating plain, whose highest elevation is 300 and average elevation about 200 feet. In the centre of the country, from Dublin Bay on the east to Galway Bay on the west, this plain stretches from shore to shore, but towards the south and north it is enclosed by an irregular semicircular belt of mountainous country. The surface of the plain is broken occasionally by isolated hills. Throughout nearly the whole of its extent it rests on the Carboniferous Limestone, and in several places there are remains of the Upper Carboniferous strata or Coal-measures, by which the Carboniferous Limestone was at one time overlaid, and which have been carried away during a vast period of denudation chiefly by the action of subaerial agents. The strata of limestone are nearly horizontal, except where they

are contorted by local disturbances. In the central plain it is only occasionally that the limestone crops to the surface, as it is generally overlaid by boulder clay, the result of glacial action, by the middle sands and gravels formed on the bed of the shallow sea by which the plain was at one time occupied, or by the peat bogs resting on the beds of previous lakes. At one period the Carboniferous beds must have extended widely beyond their present limits, and have formed the surface strata of the uplands to the north-west and south-east. In the north-western highlands of Sligo, Leitrim, and Fermanagh they still form a lofty table-land, which occasionally rises into peaks about 2600 feet in height.

The mountain masses of Ireland are generally traversed by deep and narrow valleys running both north and south and east and west, and frequently giving rise to high and isolated peaks. The districts of Donegal and Derry in the north-west, and those of Galway and Mayo in the west, consist chiefly of metamorphosed Lower Silurian rocks, and are believed to form part of the same geological system as that of the Highlands of Scotland. Those of Donegal and Derry, lying between Donegal Bay and Lough Foyle, consist of granite, gneiss, and hornblende and other schists, with crystalline limestones and quartzites. Their principal peaks are the isolated summit of Errigal (2466 feet) and Blue Stack (2219 feet). In West Galway and Mayo the rocks consist chiefly of quartzite, or of alternating beds of quartzite and granite or gneiss schist. They include the Twelve Pins of Connemara (2395 feet), Croagh Patrick on the shores of Clew Bay (2510 feet), the Nephin Beg mountains, and the Ox mountains. The range of hills between Killary Harbour and Lough Mask—the highest summit of which, Muilrea, has an elevation of 2688 feet—belongs to the Upper Silurian formation. The fact that these rocks do not share in the metamorphism of the Lower Silurian beds shows that the alteration must have taken place at some time between the Lower Silurian and Upper Silurian periods. Rocks of Cambrian age occur in Wexford, Wicklow, and Dublin. The principal elevations of these districts are formed of granite, and belong to an earlier epoch than

that of the Old Red Sandstone. The highest summit is Lugnaquilla (3039 feet), composed of altered Silurian rocks lying on the granite. In the south-western districts of Kerry, Cork, and Waterford, the mountains are composed of broad bands of Old Red Sandstone, the valleys being formed of narrow bands of Carboniferous rocks. The lie of the strata is nearly east and west, since they have been plicated by forces acting in a transverse direction, the time of disturbance being some unknown date between the Carboniferous and the Permian periods. This district includes the rugged range of Magillicuddy's Reeks, which rise abruptly from the Carboniferous Limestone surrounding the Killarney lakes, and, occupying the greater part of the peninsula between Dingle Bay and Kenmare River, attain at Carnnal a height of 3414 feet above sea-level. Many of the most conspicuous mountain groups in the southern half of the island consist of central cores of Silurian strata wrapped round with thick folds of Old Red Sandstone. Such are Slieve Aughty, Slieve Bernagh, the Silver Mine mountains, and Slievenaman in Clare and Tipperary, Galtymore in Limerick, which has an elevation of 3015 feet, and the Slieve Bloom mountains in Queen's county. The principal mountain groups in the north-east

are the Carlingford mountains, composed of felspathic and pyroxenic rocks, and attaining in Slieve Foy a height of nearly 2000 feet; the Mourne mountains to the north of Carlingford Lough, composed of granite, with veins of basalt, felsstone, mica trap, and porphyry, the highest summit being Slieve Donard (2796 feet); and the Slieve Croob mountains, to the north of the Mourne range, composed of granite of a much earlier origin. Both the Mourne and Carlingford mountains are of intrusive origin, and probably belong to the Permian period. A considerable extent of low country in Down, Armagh, and Cavan is occupied by Silurian rocks in the form of grits and slates. The estuary of Belfast Lough lies in Triassic rocks, containing beds of rock salt. Rocks of similar age extend west of Lough Neagh, and thence north to Lough Foyle. They are overlaid by Jurassic and Cretaceous strata, which, however, are almost wholly concealed under the great basalt flood of the north-eastern counties. The greater part of Antrim and the eastern portion of Derry are occupied by basalt rock forming an elevated plateau, for the most part bounded towards the sea by precipitous escarpments, consisting of Upper Greensand and Chalk, surmounted by the black basalt which, often crowning their summits, stands in striking contrast

TABLE I.—Area and Distribution of Land in 1880, and Population in 1881.

	Area in Statute Acres			Distribution of Land in Acres.				Population 1881.
	Land.	Large Lakes, Rivers, and Tideways.	Total.	Under Tillage.	Pasture.	Plantations.	Towns, Bogs, Mountains, and Roads.	
Ireland .....	20,327,764	494,730	20,822,494	5,096,490	10,259,108	339,858	4,682,308*	5,159,839
<i>Leinster.</i>								
Carlow .....	221,293	50	221,343	77,916	116,383	3,400	23,594	46,508
Dublin .....	226,895	...	226,895	88,308	104,300	4,192	29,595	418,152
Kildare .....	418,497	...	418,497	117,832	239,406	7,332	53,927	76,102
Kilkenny .....	507,254	2,478	509,732	157,231	293,252	10,799	45,922	99,064
King's County .....	493,019	966	493,985	114,648	238,677	8,551	131,143	72,668
Longford .....	257,221	12,188	269,409	72,876	131,321	3,823	49,201	60,790
Louth .....	201,618	506	202,124	97,954	74,944	4,585	24,135	78,228
Meath .....	578,247	1,614	579,861	138,916	395,159	10,839	33,333	86,301
Queen's County .....	424,854	...	424,854	136,523	216,851	11,634	59,846	72,598
Westmeath .....	433,769	19,700	453,469	93,695	271,891	8,688	59,495	71,513
Wexford .....	575,700	3,388	579,088	207,074	304,706	10,886	53,034	123,587
Wicklow .....	499,894	284	500,178	105,307	261,393	20,826	112,368	73,679
Total for Leinster .....	4,838,261	41,174	4,879,435	1,408,820	2,648,283	105,555	675,593	1,279,190
<i>Mu'ner.</i>								
Clare .....	768,265	59,729	827,994	141,362	481,536	8,500	136,867	141,210
Cork .....	1,838,921	10,764	1,849,685	412,029	1,001,322	32,957	392,613	492,810
Kerry .....	1,159,358	26,562	1,185,920	160,326	586,600	18,348	394,084	200,448
Limerick .....	662,973	17,869	680,842	176,994	415,107	8,407	62,465	177,203
Tipperary .....	1,048,969	12,762	1,061,731	266,550	598,326	28,412	155,681	199,604
Waterford .....	456,198	5,354	461,552	85,169	239,515	19,771	111,743	113,235
Total for Munster .....	5,934,684	133,040	6,067,724	1,242,430	3,322,406	116,395	1,253,453	1,323,910
<i>Ulster.</i>								
Antrim .....	711,276	50,804	762,080	244,685	349,172	7,420	109,999	423,171
Armagh .....	313,036	15,051	328,087	163,473	115,871	4,665	29,027	162,823
Cavan .....	466,261	11,134	477,395	145,326	254,347	5,443	61,145	129,008
Donegal .....	1,190,269	6,885	1,197,154	230,152	356,809	7,275	596,033	205,443
Down .....	611,936	473	612,409	298,441	225,349	14,086	74,060	269,927
Fermanagh .....	417,665	39,705	457,370	104,717	243,066	6,286	63,596	84,638
Londonderry .....	513,388	8,927	522,315	181,538	206,044	5,305	120,451	164,714
Monaghan .....	318,806	935	319,741	131,506	152,474	4,688	30,138	102,590
Tyrone .....	778,943	27,714	806,657	249,334	307,026	9,736	212,847	197,233
Total for Ulster .....	5,321,580	161,628	5,483,208	1,749,222	2,210,158	64,904	1,297,296	1,739,542
<i>Connaught.</i>								
Galway .....	1,502,362	67,142	1,569,504	211,938	752,737	24,282	513,407	241,562
Leitrim .....	376,212	16,151	392,363	82,011	212,374	3,497	78,330	89,795
Mayo .....	1,318,129	42,601	1,360,730	181,528	542,853	11,123	582,625	243,030
Rosecommon .....	585,407	22,284	607,691	133,090	339,922	7,163	105,232	131,755
Sligo .....	451,129	10,710	461,839	87,443	230,375	6,939	126,372	110,955
Total for Connaught .....	4,233,239	158,888	4,392,127	696,008	2,073,261	53,004	1,405,966	817,197

\* Including 133,035 acres under the smaller streams and lakes.



with the light-coloured strata below. In some places, however, as at the Giant's Causeway, the Cretaceous rocks disappear, and the basalt slopes gradually to the sea, displaying a series of terraces formed of hexagonal pillars, and occasionally separated by bands of volcanic ash.

*Coast-Line.*—Along the present coast-line there are to be seen in several places traces of ancient sea margins, the most continuous being those on the northern and eastern coasts, especially in county Antrim. Of still more ancient sea margins there are evidences in the terraces at the base or on the flanks of the mountains. The present coast-line, especially on the west and south, is very much indented by bays and inlets, which Hull, in his *Geology of Ireland*, attributes in many cases to the chemical action of the sea-water on the limestone rocks. On the south coast they most commonly run in a northerly direction with a westerly inclination at the upper end, and on the west coast the direction of the larger inlets is easterly, although several of the smaller ones run north, south, and north-east. Their troughs have mostly been excavated in the synclinal folds of the rocks, which therefore frequently project far into the sea in the form of high and bold headlands. On the northern coast the inlets generally run in a southerly or south-westerly direction. Most of those on the east coast have by the accumulation of sand been either wholly or partly formed into lagoons; and on the south-east coast the sea has made considerable encroachments on the land.

The principal inlets are—on the east coast Belfast Lough, Strangford Lough, Carlingford Lough, Dundalk Bay, Dublin Bay, and Wexford Harbour; on the south coast Waterford Harbour, Dungarvan Harbour, Youghal Bay, and Cork Harbour; on the south-west coast Rosaring Water Bay, Dunmans Bay, Bantry Bay, Kenmare River, and Dingle Bay; on the west coast Tralee Bay, the mouth of the Shannon, Galway Bay, Clew Bay, Blacksod Bay, Killala Bay, Sligo Bay, and Donegal Bay; and on the north coast Sheep Haven, Lough Swilly, and Lough Foyle. In all, Ireland possesses fourteen harbours suitable for the largest ships, seventeen for frigates, and over thirty for coasters, besides an immense number suitable for fishing boats.

The islands of Ireland are small in size, and are situated near the mainland, most of them being formed of rocks from which, according to Hull, the adjoining Carboniferous strata had been denuded by the action of the sea-water. They are most numerous on the west coast, especially opposite Galway, Mayo, and Donegal. Off the Donegal coast the largest is Neish Aran. Separated from the mainland of Mayo by a narrow isthmus is Achill, the largest island of Ireland, and in Clew Bay there are an immense number of islets all formed of drift. An archipelago of granite rocks off the coast of Galway is formed of continuations of the mountains, and at the mouth of Galway Bay are the three islands of Aran, composed of Carboniferous Limestone. Among the picturesque stacks of rocks off the coast of Kerry the most notable are the Skellings. The largest islands opposite Cork are Dursy Island, Bear Island, and Clew Island, south of which is a picturesque rock called the Fastnet, on which there is a lighthouse. On the east coast the principal are Lambay Island, Innispatrick, and Ireland's Eye off county Dublin, and Copeland Island at the mouth of Belfast Lough. On the northern coast the principal are Rathlin Island off Antrim, and Tory Island off Donegal.

*Rivers and Canals.*—Several of the rivers of Ireland, including the largest of them, have had their channels determined by a previous physical condition of the land surface, and must have been formed during a long period of denudation. Many of the valleys are dried-up river beds, and along various of the present river valleys traces of old river terraces may still be seen. In some cases the

alterations of the courses by breaks and dislocations of the strata are of very recent occurrence. In the districts of Sligo and Fermanagh, as well as of Galway, Clare, Kerry, and Cork, the rivers and streams have frequently cut out subterranean passages through the limestone, in some cases altogether disappearing; and along their courses *turloughs* or blind lakes, and abrupt deep holes called *sluggas* are frequently formed.

Owing to the moistness of the climate and the lie of the surface of the country, Ireland is more intersected by large rivers than England or Scotland, and it is a remarkable circumstance that in several cases there are groups of rivers with closely contiguous sources, which, however, flow in widely different directions. The largest river is the Shannon, which has its source in the Carboniferous mountains of Fermanagh and Leitrim, and flows southward through Lough Allen, Lough Ree, and Lough Dearg to Limerick, where it opens out into a wide estuary and takes a westerly course to the ocean. Up to Limerick, where it becomes tidal, it is navigable for large vessels, and for vessels of small tonnage it is navigable within 5 miles of Lough Allen. Its course above Lough Dearg is very sluggish, but from that lake to Limerick its descent is very rapid. Its total length is 240 miles, and it drains an area of 4544 square miles. The Suir, the Nore, and the Barrow, which have their sources not far from each other in the Slieve Bloom mountains, and unite at Waterford, drain together an area of 3400 square miles. The Suir is navigable for boats as far as to Clonmel, and the Nore to Innistioge. The Barrow, by means of a branch of the Grand Canal, forms a line of 120 miles of inland navigation between Dublin and Waterford. The other principal rivers, all of which are to some extent navigable, are—debouching on the west coast the Erne, the Moy, and the Corrib; on the south coast the Blackwater and the Lee; on the east coast the Lagan, the Boyne, the Liffey, and the Slaney; and on the north coast the Bann and the Foyle.

The Grand Canal, which with its various branches has a length of 165 miles, connects Dublin with the Shannon at Shannon Harbour; and the Royal Canal, with a length of 76 miles, connects Dublin with the Shannon at Cloondora. Lines of inland navigation, partly natural and partly artificial, connect Lough Neagh with Belfast, Newry, and Lough Erne. From the sea at Galway there is communication by Lough Mask and Lough Corrib to Lough Carra. Since the introduction of railways the passenger traffic on the canals has wholly ceased, but the goods traffic is still considerable.

*Lakes.*—Many lakes of considerable extent exist both in the mountainous and lowland districts of Ireland, and the number of small lakes is very great. Altogether the area covered by lakes amounts to 711 square miles, of which 287 are in Ulster, 305 in Connaught, 69 in Munster, and 50 in Leinster. Lough Neagh in Ulster is the largest inland lake in the United Kingdom, and has an area of 153 square miles, with a general depth of from 20 to 40 feet. Lough Erne in Fermanagh has a length of upwards of 40 miles, but a breadth of only 8 miles. Properly speaking, it consists of two lakes 5 miles apart and connected by a river, the upper lake being 13 miles in length with an area of 9278 acres, and the lower 24 miles in length with an area of 28,000 acres. Both lakes are dotted with numerous islets, and the lower one is famed for its picturesque beauty. Lough Corrib and Lough Mask have respectively an area of 43,484 and 22,219 acres. The country to the west of Lough Corrib contains about 130 lakes, 25 of which are more than a mile in length. The lakes of Killarney in Kerry, which are three in number and closely adjoin each other, are situated in the midst of wild and picturesque mountain scenery. The area of the lower lake is 5001 acres, of the middle one 680.













and of the upper one 430. Lough Dearg, a small lake in the south of Donegal, has been resorted to from time immemorial as a place of penance by Roman Catholics. The other lake of the same name in the course of the Shannon has an area of 29,570 acres. The other principal lake districts are Sligo, Cavan, Westmeath, and Longford. Hull, in his *Geology of Ireland*, makes a classification of the lakes, according to their modes of formation, under the three heads of—(1) lakes of mechanical origin, (2) lakes of glacial origin, and (3) lakes of chemical solution. Of the first group, which are those whose formation is due chiefly to faults or dislocation of the strata, he mentions as special examples Lough Neagh and Lough Allen, both of which originated before the Glacial period, and probably between the Miocene and Pliocene periods. Those of glacial origin occur in the mountainous districts, and are due either to the scooping out of the rocks by the passage of ice over their surface, or to the accumulation of embankments at the end of the valleys or hollows. Those due to chemical solution are situated either on the limestone plain or in districts where the limestone formation has penetrated, and have been produced by the solution of the limestone through the action of water containing carbonic acid gas.

*Coal.*—Of the Upper Carboniferous beds which at one time overspread the central plain of Ireland, only small patches remain in isolated spots, serving chiefly as an indication of the immense loss that has been sustained in an important element of material prosperity. The principal coal-fields are the Leinster, the Munster, the Connaught, and the Tyrone.

The Leinster or Castlecomer field, situated between the Nore and Barrow, consists of a range of hills varying from 800 to 1000 feet high, and extending over portions of Kilkenny, Queen's county, and Carlow. It lies in the form of a basin, its most productive beds occupying the centre. These are the Middle Measures, but in the field both the Middle and Lower are represented. The coal is anthracite. The most common fossils are either terrestrial or freshwater, marine fossils being found chiefly in some of the upper beds. Above the Barrow coal in county Kilkenny several remarkable reptilian remains have been found. The Lower Measures consist of gannister beds resting upon Carlow flags, and contain some beds of shale and a few thin seams of coal, with several beds of marine fossils. This field is the most important in Ireland, and yields a larger weight of coal than all the others together.

The West Munster coal-field occupies portions of Clare, Limerick, Kerry, and Cork, and consists of a series of low hills extending from near Galway Bay in the north to Killarney in the south. All the three measures are represented, but there are only a very few workable seams, as most of the coal is very thin, and the strata very much inverted. The principal collieries are at Dunhallow in Cork, and the coal, which is anthracite, is used chiefly for lime-burning. Many of the Lower Measures are very rich both in terrestrial and in marine fossils.

The East Munster coal-field consists of a low range of hills in Tipperary, closely adjoining the Carboniferous hills in Leinster, from which they are separated by the river Nore. Thence it extends to near Cashel, a distance of about 20 miles, and its average breadth is about 5 miles. All the measures are represented. The productive portion of the field is at Killenaule, and consists of two thin seams in the Upper Measure. In the Lower Measures the principal fossils are marine; and plant impressions, especially those of ferns, are very numerous.

The Connaught coal-field embraces the mountainous district round Lough Allen, and includes portions of Sligo, Roscommon, and Leitrim in Connaught, and of Fermanagh and Cavan in Ulster. Both the Middle and Lower Measures

are represented. They are composed chiefly of yellow sandstone and shale, and are overlaid by beds of grit. The coal is bituminous, and a large portion of it is workable.

The Tyrone coal-field includes the district between Dungannon and Lough Neagh, having a length of 6 and a breadth of 1 to 2 miles, and the small basin of Annaghone a little to the north. All the measures are represented. The coals have been worked only near the surface, but it is believed that very extensive and valuable seams of workable coal exist at lower depths.

The average quantity of coal raised in Ireland annually is about 130,000 tons, of which about 80,000 are raised in Leinster, 30,000 in Munster, 16,000 in Antrim and Tyrone, and 6000 in Leitrim and Roscommon. As the annual importation of coal exceeds 2,000,000 tons, it is evident that the coal supply obtained from Ireland's own mines is quite a minor element in its prosperity; but the industry might be much more largely developed, the total available amount of coal being estimated at 180,000,000 tons.

*Peat.*—For the absence of coal the country is to some extent compensated by the supply of peat fuel obtained from the red bogs situated in the central plain, and occupying a large tract included within two lines drawn across the island, the one from the Hill of Howth to Sligo, and the other from Wicklow to Galway. Originally this district was occupied by a forest, principally of oak trees, which after being gradually killed by the growth of mosses and other peat-producing plants, were succeeded by a forest of firs, these also in turn perishing. The average depth of the bog is 25 feet, but in some cases it is over 40 feet. According to its depth it varies in colour, from whitish brown to a brown-black closely resembling coal. The brown or red turf in the centre forms the best fuel. The lower strata sometimes pass into lignite. Lignite of an immense thickness is found around the southern shores of Lough Neagh. In the mountain districts the bogs usually consist of brown turf of only about 12 inches thickness. Preglacial or interglacial peat has been found in Queen's county, county Galway, and county Tipperary, and submarine bogs with remains of an ancient pine forest have been discovered off the south-west coast. The bogs of the central plain contain in a state of good preservation animal and human skeletons, tree canoes, gold and silver coins and ornaments, crannogs or lake dwellings, log houses, and wooden roadways. The total area occupied by bog is 2,830,000 acres, or about one-seventh of the surface of the island, mountain bog occupying 1,254,000 acres, and flat red bog 1,576,000 acres.

*Iron.*—The deficiency in coal supply is the more to be regretted in the case of Ireland on account of its immense stores of iron, which for want of proper fuel remain unutilized. Red hematitic iron of a very rich kind is found associated with the coal-fields in the districts of Tyrone, and in Cork and Waterford. Valuable pisolitic ore occurs between the sheets of basalt in Antrim. Iron is met with in great quantities in the bogs, and is easily fusible, but the quality is not nearly so good as that of the clay iron which occurs in great abundance in the coal districts of Connaught. Some centuries ago the manufacture of iron was one of the most important industries of Ireland, the surface of the country being dotted over with small iron-works, in which the ore was smelted by wood charcoal; but as the supply of wood became exhausted the industry was wholly discontinued, the last of the old furnaces having been put out more than a hundred years ago. On the discovery of coal at the Arigna river near Lough Allen, iron-works were established there in 1788 which were carried on until 1808, and again revived in 1825, when the undertaking failed on account of the insufficiency of capital with which the company started. Of late years



iron-mining has been prosecuted with some briskness in Antrim, as well as in Down and Londonderry. The quantity produced in the country has risen from 106 tons in 1860 to 77,600 in 1870 and 155,833 in 1879; but for the proper development of the industry the available supply of coke is wholly insufficient, and until other methods or materials of smelting have been discovered, the valuable iron ores of the country will contribute a very small modicum to its prosperity.

*Gold.*—From the gold ornaments and crucible ladles and other implements used in the purifying of gold that have been discovered in a bog on the borders of Limerick and Tipperary, it would appear that that metal was manufactured there at a very early period; and there is a tradition that gold was smelted for King Tighearnmas about 1620 (or 915) B.C. in one of the valleys of the Liffey. About the end of last century a nugget of gold 22 oz. in weight was found in a tributary of the Oyoca, and, the Government having shortly afterwards taken up the enterprise, placer mining was carried on for some years. The gold was from 21½ to 21¼ carats fine, the alloy being silver. The total value of the gold obtained at the Government works was £3675, while gold to the value of over £10,000 was obtained by private enterprise. All the gold has been found in shallow places. Very little gold is found in the iron or quartz veins, although pieces of iron are always found with the gold, and quartz is sometimes attached to the nuggets. The gold usually occurs in small grains, but nuggets of considerable weight are sometimes found.

*Silver and Lead.*—In very ancient times there were silver mines at Argetros, county Kilkenny, and near Toomavara, county Tipperary. The metal occurs both as native silver and in the lead ore, which sometimes yields as much as 80 oz. of silver to the ton. Lead is found in a greater number of localities than any other metal. Its most usual form is galenite, which occurs sometimes alone, but generally with sulphide of zinc, sometimes with the sulphides of iron and copper, and occasionally with sulphate of baryta and sulphate of strontium. In 1854 the lead mines of Ireland were wrought by ten companies, and the amount of ore raised was 3069 tons 15 cwt., yielding 2210 tons 15 cwt. lead and 18,096 oz. silver. Since that period the industry has gradually declined, until in 1875 it was prosecuted by only one company, that of Luganure in Wicklow; but since 1877 two mines have also been wrought at Carahan in Clare. Table II. gives returns from 1876 to 1879.

*Copper.*—The principal copper-mines are at Knockmahon in Waterford, at Cronebane and Connary in Wicklow, and at Bearhaven, Ballycommisk, and Cosheen

TABLE II.—*Produce of Lead and Silver, 1876–79.*

	Companies.	Lead Ore.		Lead.	Silver.	Value of Ore.			
		Tons.	Cwts.	Tons.	Cwts.	Oz.	£	s.	d.
1876	Luganure (1)	1825	4	1368	18	6840	20,077	0	0
1877	Luganure (1)	1655	18	1241	0	6205	18,214	0	0
1878	Luganure (1)	1526	1	1130	0	5650	12,208	10	0
1879	Carahan (2)	173	0	133	10	...	1,882	7	0
	Luganure (1)	1124	9	800	0	4060	7,309	0	0
	Carahan (2)	148	0	111	0	...	1,524	0	0

TABLE III.—*Produce of Copper, 1874–79.*

	Number of Mines.	Copper Ore.	Value	Copper.	Value.
		Tons.	£	Tons.	£
1874	8	9773	54,339	802	72,090
1875	8	7019	42,020	600	54,000
1876	6	6186	32,342	452	37,645
1877	6	4949	19,664	281	21,300
1878	6	1821	9,662	140	9,600
1879	5	2096	13,062	179	11,700

in Cork. Chalcopyrite or yellow copper is the most common, but melacouite or black copper is found at Cronebane and Connary, and tetraedrite or grey ore in the small beds to the south of Bearhaven. Native copper is common in most of the districts where the ore is found, and in many places large quantities of copper are collected from the streams by precipitation on iron. In 1854 the quantity of copper raised in Ireland was 12,171 tons, value £104,882. Since 1874 the industry has been on the decline, as may be seen from Table III.

*Other Minerals.*—There is a large lode of pyrites associated with the iron ore at Oyoca, county Wicklow, and native sulphur is found in the limestone in various districts as well as in some of the copper-mines. The produce of the sulphur mines of Wicklow amounted in 1860 to 99,259 tons, in 1870 to 38,634 tons, and in 1879 to only 8262 tons. Tin stone has been found in a leaden lode at Dalkey, county Dublin, and also in the auriferous soil of Wicklow, but no lodes or workable deposits have been discovered. Salt is found at Carrickfergus and Larne in Antrim, and gypsum suitable for manure in the same districts. Molybdenite is found in a vein of granite near Roundstone in county Galway. Antimony, arsenic, sulphate of barytes, cobalt, magnesia, alum, and steatite, all occur in several districts. Clays suitable for porcelain, as well as those used for coarse pottery, are not uncommon, and there are a great many quarries for building stone, flags, and slate, and also some for granite and marble. Lime is of course plentiful almost everywhere. Mineral springs, chiefly chalybeate, exist in the Upper Limestone in many parts of the country, the principal being Mallow in Cork, Ballynahinch in Down, Swanlinbar in Cavan, Castleconnel near Limerick, and Lucan near Dublin.

*Climate.*—The climate of Ireland is more equable than that of Great Britain, both as regards temperature and rainfall. No district in Ireland has a rainfall rising so high as that of large portions of the Highlands of Scotland, or falling so low as that of several large districts in the east of Great Britain. In January the mean temperature rises but little above 37° over the larger portion of the eastern slope of Great Britain, whereas in the same month it scarcely falls below 40° in any part of Ireland; and in July, whilst in Great Britain the extremes in the mean temperature are 64° in the London district and 51° in Shetland, the extremes in Ireland are 59° in the north and 62° in Kilkenny. Latitude accounts only for a part of these differences, which are mainly occasioned by the physical configuration of the surface in its relations to the prevailing moist W.S.W. winds. Ireland presents to these winds no unbroken mountain ridge running north and south, which would result in two climates as distinct as those of the east and the west of Ross-shire; but it presents instead only a series of isolated groups, with the result that it is only a few limited districts which enjoy climates approaching in dryness the climates of the whole of the eastern side of Great Britain.

*Agriculture.*—In wet years the excessive moisture is very prejudicial to cereal crops, especially in the southern and western parts of the island. Probably the returns either of corn or of green crop would in exceptional cases be very deficient under any mode of culture, and they might on the average, in the south-western district, be less remunerative than those of grass; but undoubtedly, if tillage were more practised on pasturage farms, the rearing and feeding of cattle would be more satisfactorily performed. Moreover, the soil in many cases is such that most kinds of crops thrive in the moist climate, and much might be done by drainage to procure a drier atmosphere and to mitigate the prejudicial influences of

rainfall at the period of ripening. In regard to the natural fertility of the soil, and the ease with which it can be cultivated, Ireland as a whole has great advantages over Great Britain. Strong retentive clay soils, sandy soils, chalky and gravelly soils, are almost wholly absent, and the mixture of soils resulting from the great variety of stratification, as well as from the detritus carried down to the plains, has created many extensive districts of remarkable richness. The most fertile part of the country is the tract in Munster known as the "Golden Vein," stretching from Cashel in Tipperary to near Limerick. Along the banks of the Shannon there are long stretches of flat lands formed by deposits chiefly of calcareous and peaty matter carried down by floods, and at the estuary of the river this matter has been largely mixed with blue silt deposited by the sea. Extensive districts of similar formation are connected with the Suir, Nore, and Barrow, and with the Bann. In other parts of the limestone plain a rich soil has been formed by the decomposition of drift accumulated by the Esker Sea, mingled in some cases with the remains of granite; and a mixture of a variety of rocks has also greatly benefited many of the other limestone soils. The red bogs contain underneath them abundant marl admirably adapted for use in reclaiming the land. In many of the mountain districts the soil above the hard rocks consists of a thin stratum of vegetable matter. On the clay slate formations in Louth, Down, Wicklow, Wexford, Waterford, Cork, and Kerry, the soil is generally poor, except in the hollows, where rich patches have frequently been formed by rocky deposits. Similar remarks apply to the soils above mica slate. In the districts of the Old and New Red Sandstone, including the greater part of Cork, and portions of Kerry, Waterford, Tyrone, Fermanagh, Monaghan, Mayo, and Tipperary, the soil in the hollows is generally of remarkable fertility. Where gneiss and schist rocks prevail a finely productive soil frequently occurs, resting on inclines of limestone and other calcareous rocks. Indeed, Ireland contains comparatively little irreclaimable land, and even in the mountainous districts which are unsuitable for tillage there is often soil sufficient, with the aid of the moist climate, to yield pasturage of superior quality in great abundance; and more than two-thirds of the surface of the country, being less than 500 feet above sea-level, possesses a temperature well adapted to all the usual kinds of crop.

But, although enjoying such favourable natural conditions, Ireland as a whole lags far behind most other portions of the United Kingdom in agricultural progress, both as regards the circumstances of the peasantry and the development of the capabilities of the soil for producing food. The causes of this state of things are somewhat complex; and, having their chief connexion either directly or indirectly with the procedure of the legislature, they have been in operation for several centuries, during which, instead of diminishing in influence, they have apparently gained strength by intermixing and entangling with each other. Until a comparatively recent period the system of landholding in Ireland was the tanistry or communal, governed by the ancient Brehon code. According to this code the land belonged primarily to the tribe or commune, and was vested in the chief or tanist, who, from his rank as a noble, held a portion of it as his own property, had a life interest in a second portion from the office to which he had been elected, and possessed jurisdiction over a third portion, the communal land, which was divided annually. The nobles from among whom the tanist was chosen had the right of ownership of land, and another class had the right of ownership of chattels, which went to their sons by gavelkind. Only certain classes of the tribe—the Saer Cúid or "free tenants," and Daer

Cúid or "base tenants"—could obtain security of tenure for life, the others being either yearly tenants, free labourers, or slaves. The interests even of the yearly tenant were preserved by stringent regulations, and in the course of generations it was possible to rise from the lowest social grade to the rank of a "free tenant." The lands of the tenants went to their male descendants by gavelkind. Even the free labourers and the slaves, with the exception of those who were convicts or prisoners, had the right of sustenance and shelter on the estate of their lord. Unlike those of Great Britain, the ancient laws of Ireland remained uninfluenced by Roman legislation; and, although the Danish invasions caused some disturbance of the old order of things, the regulations so far as the possession and tenure of land were concerned remained practically unmodified until the invasion of Henry II. The natural consequence was that the pastoral mode of life associated from the beginning with the Brehon code should also remain unchanged, the more especially as soil and climate alike were favourable to the growth of luxuriant pasturage; but, as pastoral employment is that which is least able to support a dense population, a large proportion of the servant class gradually sank into a condition of idleness and wretched poverty. Unhappily the result of the Anglo-Norman invasion was not to improve this state of things by the gradual influence of other laws and customs, but to introduce into the social system disturbing and irritating elements, which kept alive all the old evils in a more aggravated form. Henry II. nominally bestowed the entire land of Ireland upon ten of his followers, but practically, with the exception of the small district of the Pale, it remained in the possession of its ancient lords. Confiscations became more frequent as the power of the English increased, and within that portion of the territory over which English rule did not extend the tenants and labourers, in the unsettled condition of society, suffered severely from the irresponsible authority of the nobles. Henry VIII., the first English sovereign who really held sway over the whole island, induced the nobles to acknowledge him on condition that their ancient rights and privileges were left intact; but this arrangement was set aside by Elizabeth, whose reign was signalized by the great wars, resulting in the composition of Connaught and the planting of Munster. By the former of these, while possession was secured to the nobles in their estates, the lands in the province were alienated from the clan to the chief, and the free tenants became virtually proprietors of their farms; and by the latter 574,628 acres, the estate of the earl of Desmond, were parcelled out to be peopled according to a plan founded wholly on English customs. Soon after the accession of James I. in 1603, tanistry and gavelkind were abolished by decision of Queen's Bench, and the estates of the Ulster nobles—511,465 acres in extent—were forfeited to the crown, to make way for the great plantation of Ulster. The custom of gavelkind was, however, revived by the Act of Queen Anne against the Catholics, and the statute was not repealed till the reign of George III. The confiscations were repeated on a larger scale during the Stuart and Cromwellian periods, from which time may be dated the complete practical overthrow of the Brehon system except in Ulster and a few isolated districts where the shadow of it still lingers in the custom known as tenant-right. Even, however, after the subjugation of Ireland by Cromwell, Sir William Petty, in his *Political Anatomy*, written in 1672, estimated the value of the tenant's claims for improvements and benefit of leases at one-third of his annual rental. The same writer calculated that, whereas in 1641 about two-thirds of the good land belonged to the Irish or Catholics, at the time he was writing the proportion was as nearly as possible reversed, the figures



being as follows:—Purchased by the Protestants of Connaught of the transplanters 80,000 acres, possessed by the English and Protestants and Church 5,140,000, possessed by the Irish 2,280,000. Of the 1,100,000 inhabitants, the proportion of Irish to English was 9 to 3; and 6 out of every 8 of the Irish lived in a “brutish nasty condition.” After the confiscations which followed the wars of William III., the Catholics did not possess more than one-seventh of the soil. The penal laws by which the Catholics were disabled from holding freehold property tended to effect a still further transference of proprietorship to the Protestants. The functions of the proprietor were generally performed by the large Protestant tenant, to whom a long lease of the property was granted, and who sublet to the Irish farmer. Frequently the farms were subdivided and sublet to the third, fourth, or fifth degree, and, as the Catholics were disabled from holding leases for more than thirty-one years, and at less than two-thirds of a rack-rent, they necessarily occupied the lowest step in this peculiar social scale. Instead of an industrious and thriving class of peasant proprietors, which the Brehon system left to itself would in all probability have gradually developed, a race of wretched cottiers sprang up, whose only inheritance now guaranteed to them by the remains of the old Brehon system was their deep-seated conviction as to their inalienable rights to the soil; the custom which, without now recognizing these rights, threw upon them the expense not only of fencing, draining, and other improvements, but of the erection of all the dwellings on the farm; and their dependence on the proprietor, one, however, who was now generally an alien, and from whom they held their small patches of soil on payment in labour according to conditions strung to the utmost degree of severity by the process of subletting and an unlimited competition. Support by any other form of industry than agriculture was rendered impossible by laws which practically paralysed the commerce and manufactures of the country, and agriculture itself was additionally hampered by the enactments passed in the reign of Charles II. against the exportation to England of cattle, sheep, and pigs, of salt beef and bacon, and even of butter and cheese. These enactments, combined with that final one by which the prohibition formerly passed against the exportation of woollen manufactures to England or the colonies was extended also to foreign countries, caused the “middle men” to turn their attention to woollen smuggling; and, finding it a more lucrative means of livelihood than that of squeezing money from impoverished tenants, they in many instances drove the cottiers from their farms, which they changed into sheep walks.

The Acts of 1771, 1778, and 1782, which removed the Roman Catholic disabilities in regard to the holding of leases and property, and the Act of 1793, which extended to the Catholics the forty shillings franchise, had, on account of the peculiar social condition created by former legislation, practically as disastrous effects as even the penal laws which they superseded. The landlords for election purposes created an immense number of the lowest kind of freeholds, which they let at exorbitant rents owing

to the high price of provisions during the great war. These prices indeed gave a temporary stimulus to agriculture, and led to the conversion of a considerable amount of pasturage into tillage, but practically the position of the freeholder was more servile than that of the previous tenant-at-will, and when prices sank to their normal rate at the close of the war he found himself in a condition of absolute ruin. At the same time, by this minute subdivision of leaseholds, an immense increase had taken place in the agricultural population, whose numbers could perhaps scarcely have found support under any system of agriculture, although undoubtedly under a system of peasant proprietorship support would have been possible to a much larger number, inasmuch as the principal profits of tillage would have fallen into the hands of the tillers of the soil instead of those of absentee proprietors. To aid the landlords in freeing themselves from the incubus of impoverished tenants an eviction Act was passed in 1816, and further protection was afforded them by the Subletting Act of 1826, but it was not until after the abolition of the forty shilling leasehold suffrage in 1829 that any important diminution took place in the leaseholds. Under tenancy-at-will, which was then generally substituted, the subdivision of holdings was not materially diminished, although for some years previous to the occurrence of the potato blight and the repeal of the Corn Laws more than one-fourth of the population stood in need generally of relief, and the landlord, in order to escape the burdensome taxation consequent upon the Poor Law Act of 1838, had begun the transformation of small holdings into large farms. Table IV., compiled from special parliamentary returns giving the number of freeholds by counties, will illustrate the influence of various acts of legislation on the growth of freeholds, and especially their rapid increase after 1793 and their rapid decline after 1829.

The potato blight and the repeal of the Corn Laws, occurring nearly simultaneously, caused an immediate and almost complete sweep to be made of the smaller class of holdings. The consequence was an enormously rapid diminution of the population, which made whole districts of the country almost tenantless, but which, great as it was, only removed the abnormal strain of hardship under which the peasant was suffering, and brought him no permanent relief from his burdens by an increase of wages or more favourable terms of occupancy. Indeed, tenancy-at-will was still further increased by the Parliamentary Votes Act of 1850, which granted the suffrage to those who for twelve months were rated as occupiers of land valued at £12 a year.

The change which has taken place in the size of the holdings since 1841 is sufficiently indicated in Tables V., VI. and VII.

TABLE IV.—Freeholds, 1795-1830.

	40s.	£20.	£50.	Total.
1795	4,768	408	344	5,520
1796	64,752	5,109	3,195	73,056
1803	157,159	10,096	7,009	174,264
1821	184,229	15,139	11,063	210,431
1828	191,732	6,806	18,369	216,907
1830	14,246	7,639	17,819	39,704

TABLE V.—Holdings of various sizes in 1841, 1851, 1861, 1871, 1876, and 1880.

	Not exceeding 1 Acre.		Above 1 and not exceeding 5 Acres.		Above 5 and not exceeding 15 Acres.		Above 15 and not exceeding 50 Acres.		Above 50 Acres.		Total.
	Number.	Per cent.	Number.	Per cent.	Number.	Per cent.	Number.	Per cent.	Number.	Per cent.	
1841	135,314	16.3	310,436	37.4	252,799	30.7	79,342	9.7	48,625	5.9	826,516
1851	37,728	6.2	88,083	14.5	191,854	31.6	141,311	23.2	149,090	24.5	608,066
1861	40,080	6.5	85,469	14.1	183,931	30.2	141,251	23.2	157,833	26.0	608,564
1871	48,448	8.2	74,809	12.6	171,383	28.9	188,647	23.3	159,303	27.0	592,590
1876	52,433	9.0	67,524	11.6	164,810	28.3	137,114	23.6	159,872	27.5	581,753
1880	50,613	8.8	64,292	11.2	161,335	28.1	136,518	23.8	161,464	23.1	574,222

TABLE VI.—Showing the amount of Increase (+) or Decrease (-) between 1841 and 1880 in the various classes of Holdings above 1 acre in extent in the different Provinces and for all Ireland, with the proportion per cent. of that amount.

Classes of Holdings.		Leinster.	Munster.	Ulster.	Connaught.	Ireland
Above 1 and not exceeding 5 acres.....	Number.....	-31,277	-47,037	-81,829	-86,001	-246,144
	Per cent.....	62.4	81.3	80.1	85.8	79.3
Above 5 and not exceeding 15 acres.....	Number.....	-20,223	-42,767	-31,334	+2,860	-91,464
	Per cent.....	43.9	69.3	31.5	6.3	36.2
Above 15 and not exceeding 30 acres.....	Number.....	+1,393	-3,018	+30,485	+27,816	+57,176
	Per cent.....	9.2	10.9	120.9	477.6	72.1
Above 30 acres.....	Number.....	+21,724	+40,122	+33,156	+17,837	+112,839
	Per cent.....	121.1	240.8	343.4	408.9	232.1
Total Decrease.....	Number.....	-27,883	-52,700	-49,522	-37,488	-167,593
	Per cent.....	20.7	32.2	20.9	24.1	24.2

TABLE VII.—Classification of Farms above 30 acres in extent in 1851, 1861, 1871, 1876, and 1880.

Classes of Holdings.	1851.	1861.	1871.	1876.	1880.	Increase.
Above 30 and not exceeding 50 acres.....	70,093	72,449	72,787	72,761	72,923	2,830
Above 50 and not exceeding 100 acres.....	49,940	53,933	55,062	55,365	49,249	6,289
Above 100 and not exceeding 200 acres.....	19,753	21,531	21,696	22,060	22,413	2,660
Above 200 and not exceeding 500 acres.....	7,847	8,329	8,190	8,176	8,340	493
Above 500 acres.....	1,457	1,591	1,568	1,510	1,559	102

TABLE VIII.—Percentages of Acreage of different sizes of Holdings, with percentages of Crops.

		Up to 1 Acre.		Up to 5 Acres.		Up to 15 Acres.		Up to 30 Acres.		Up to 50 Acres.		Up to 100 Acres.		Up to 200 Acres.		Up to 500 Acres.		Above 500 Acres.		Total.										
		ac.	ro. po.	ac.	ro. po.	ac.	ro. po.	ac.	ro. po.	ac.	ro. po.	ac.	ro. po.	ac.	ro. po.	ac.	ro. po.	ac.	ro. po.											
Percentage of acreage in each class of holding.....	1854	6.5	13.8	30.3	23.3	12.0	8.9	3.6	1.3	0.3	100																			
	1861	6.8	14.0	30.1	23.1	11.9	8.9	3.5	1.4	0.3	100																			
	1871	8.2	12.6	28.9	23.4	12.3	9.3	3.6	1.4	0.3	100																			
Under crops.....	1854	86.8	65.0	48.3	40.6	34.7	28.9	21.2	12.6	3.8	27.6																			
	1861	85.8	64.8	49.0	41.8	36.7	30.1	22.0	13.1	3.3	29.0																			
	1871	85.1	63.5	47.4	40.6	35.3	28.9	21.3	12.7	3.2	27.7																			
Grass.....	1854	6.7	28.0	43.8	48.1	50.4	51.6	52.5	47.3	29.5	47.1																			
	1861	5.8	26.1	41.1	45.6	48.3	50.8	52.9	50.1	34.0	46.9																			
	1871	5.5	27.5	42.9	48.1	51.2	54.8	52.5	52.5	33.2	49.6																			
Fallow.....	1854	0.7	0.5	0.4	0.4	0.6	0.6	0.5	0.4	0.0	0.4																			
	1861	0.3	0.2	0.2	0.2	0.3	0.3	0.2	0.2	0.1	0.2																			
	1871	0.2	0.1	0.1	0.1	0.1	0.1	0.1	0.1	0.0	0.1																			
Woods and plantations.....	1854	0.8	0.7	0.5	0.5	0.7	1.0	2.0	8.1	3.1	1.5																			
	1861	1.0	0.9	0.5	0.5	0.7	1.2	2.1	3.2	8.1	1.6																			
	1871	0.8	1.0	0.6	0.5	0.7	1.1	2.0	3.3	3.3	1.6																			
Bogs and waste.....	1854	5.0	5.8	7.0	10.4	13.6	17.9	23.8	36.6	63.6	23.4																			
	1861	7.1	8.0	9.2	11.9	14.0	17.6	22.3	33.4	59.0	22.3																			
	1871	8.4	7.9	9.0	10.7	12.8	15.1	19.4	31.4	60.3	21.0																			
Average extent.....	1854	0	2	3	1	36	10	1	0	22	0	32	4	1	32	74	6	2	153	0	5	355	0	25	1241	1	32	33	1	6
	1861	0	2	3	1	38	10	1	21	22	1	24	1	13	13	149	3	4	340	1	0	144	2	32	33	1	0			
	1871	0	2	4	3	2	10	1	39	22	1	6	40	1	19	73	2	6	150	0	39	341	3	33	1320	0	39	34	1	0

TABLE IX.—Areas (in Acres) of Land under different Crops in 1847, 1851, 1861, 1871, 1879, and 1880. (The figures for 1880 are taken from the Agricultural Abstract, and differ slightly from those in the complete return.)

	Wheat.	Oats.	Barley.	Bere.	Rye.	Beans.	Pease.	Total Cereals.	Potatoes.	Turnips.	Mang. Wurz.	Other Green Crops.	Total Green Crops.	Flax.	Meadow and Clover.	Total.	
Leinster.....	1847	277,147	564,711	98,555	23,999	3,411	7,860	975,583	68,141	109,857	5,698	22,035	205,731	1,644	451,339	1,634,297	
	1851	292,578	614,535	97,759	27,642	3,340	5,281	8,567	860,883	191,299	104,069	13,344	30,365	393,077	4,883	481,564	1,786,413
	1861	133,167	482,546	120,323	1,988	1,439	6,602	598	746,665	214,538	102,886	11,914	21,997	350,855	1,134	547,122	1,645,774
	1871	68,897	380,551	156,140	1,182	1,241	5,244	487	623,742	209,540	125,531	14,444	26,417	355,932	3,219	621,765	1,604,658
	1879	43,770	278,299	174,146	232	1,354	4,579	138	502,509	158,632	99,660	17,936	21,787	298,074	1,030	606,924	1,408,537
	1880	44,883	307,359	152,156	1,124	1,224	5,656	117	511,244	153,410	102,051	15,646	21,239	292,397	2,157	597,568	1,403,364
	1847	317,567	384,159	106,116	11,315	2,086	1,779	823,022	39,372	114,833	5,906	11,363	230,874	1,156	315,848	1,370,900	
	1851	180,269	399,334	131,991	5,577	2,838	8,927	3,158	732,294	243,137	125,493	7,470	21,892	337,352	6,891	372,072	1,508,239
	1861	159,239	381,545	64,660	293	1,885	731	122	537,455	291,000	110,293	5,916	22,451	439,660	1,529	448,171	1,476,795
	1871	91,067	298,246	46,611	320	2,206	593	48	439,991	260,140	89,434	12,841	29,291	390,756	2,935	525,266	1,358,978
1879	63,507	222,390	60,616	140	1,831	419	24	343,927	189,270	81,113	20,178	25,822	316,383	1,046	568,790	1,235,146	
1880	57,852	249,811	49,756	1,289	1,318	318	38	358,946	191,807	77,865	16,625	24,394	310,190	1,142	669,714	1,233,992	
1847	83,206	957,307	41,718	11,940	4,436	13,795	1,116,511	87,188	107,261	1,994	20,260	216,601	53,701	263,149	1,649,962		
1851	90,188	888,419	27,483	15,441	6,942	13,498	4,446	1,048,417	282,089	108,218	3,761	25,960	420,026	12,407	260,145	1,851,995	
1861	60,740	838,492	14,211	672	2,872	5,090	697	942,804	388,417	81,373	6,278	19,895	494,172	143,206	372,801	1,952,933	
1871	54,134	720,437	9,066	293	2,107	3,616	694	800,337	375,506	90,479	2,653	22,682	491,336	147,065	465,687	1,904,485	
1879	42,203	649,875	9,639	133	1,752	4,262	615	703,363	316,539	102,297	8,053	24,068	450,937	134,639	493,436	1,733,447	
1880	38,828	641,361	7,698	1,377	1,106	3,780	301,687	693,780	301,687	93,158	6,831	22,259	422,366	152,996	474,483	1,745,245	
1847	60,951	294,633	37,198	2,805	2,482	324	398,463	29,417	38,393	3,283	6,584	74,532	1,811	108,610	583,418		
1851	31,213	287,287	25,393	4,687	5,977	179	5,071	359,807	151,756	45,770	1,272	16,503	215,521	4,249	132,627	712,204	
1861	28,937	296,577	10,331	99	2,834	28	149	338,055	239,529	35,452	1,116	16,632	298,729	2,088	178,112	814,964	
1871	19,333	226,902	9,162	60	4,146	68	173	269,304	213,248	41,591	1,806	16,990	273,635	3,451	216,326	753,316	
1879	8,031	179,906	8,931	48	4,132	37	77	202,062	176,230	31,627	4,889	14,499	228,236	1,315	262,095	694,706	
1880	7,067	183,382	8,569	3,358	78	202,454	174,324	296,606	3,347	3,449	14,499	221,786	1,239	268,144	693,623		
1847	743,871	2,200,879	283,587	49,068	12,415	23,768	3,313,573	284,116	370,344	13,766	59,612	727,738	58,312	1,138,946	5,236,575		
1851	504,243	1,193,775	282,817	53,347	19,637	28,535	21,182	2,029,401	868,501	385,548	25,847	94,710	1,372,606	140,536	1,246,468	5,858,951	
1861	401,243	1,093,160	198,955	3,052	8,530	12,451	1,566	2,624,357	1,133,564	334,104	22,833	80,975	1,571,416	147,357	1,546,206	5,830,526	
1871	244,541	1,636,126	220,279	1,855	9,700	9,221	1,392	2,124,034	1,058,434	327,033	31,810	94,410	1,511,689	156,670	1,829,044	5,621,437	
1879	157,511	1,330,261	254,292	533	9,089	9,297	854	1,761,867	842,671	314,697	51,155	86,167	1,294,630	128,021	1,937,255	5,121,833	
1880	148,636	1,381,943	215,019	7,668	10,153	1,766,424	820,728	302,768	411,510	82,353							



The number of holdings of less than one acre is not given in the census returns of 1841, but the number of persons occupying the holdings is given in Kennedy's *Digest of the Evidence of the Devon Commission*. Reckoning that no one possessed more than one holding, the total diminution in the number of holdings between 1841 and 1880 would thus be 252,294, or, not including holdings under 1 acre, 167,593. The number of occupiers in 1880 was 527,444, or 46,778 fewer than the number of holdings. The diminution in holdings took place chiefly between 1841 and 1851, that is, practically between 1846 and 1851, this decline being 218,450. It was confined to farms not exceeding 15 acres in extent, which between these years declined as much as 380,884, and between 1851 and 1880 have declined by only 41,425. Those not exceeding 1 acre, principally the potato gardens of the cottiers, between 1841 and 1851 declined by 97,586, or nearly three-fourths; since 1851 they have increased by more than one-fourth. Farms above 1 and not exceeding 5 acres declined between 1841 and 1851 by 222,353, or nearly three-fourths; and those above 5 and not exceeding 15 acres by 60,945, or nearly one-fourth. Between 1851 and 1880 the decline in farms of the former class has been 23,791 and of the latter class 30,519, there having been a slight increase in this class in the province of Connaught. The largest increase in the number of holdings took place in those exceeding 30 acres, the additions between 1841 and 1851 being 100,465, and between 1851 and 1880 only amounting to 12,374, the greatest proportional increase between 1841 and 1880 being in the provinces of Connaught and Ulster. The increase between 1841 and 1851 in farms above 15 and not exceeding 30 acres was 61,969, and between 1851 and 1880 there has been a decrease of 4793, there having been a slight increase in Connaught. In farms above 30 acres in extent, the increase between 1851 and 1880 has been greatest, both in numbers and in proportion, in those above 50 and not exceeding 100 acres. Since 1861 the decrease in the total number of holdings has been gradual but continuous; and the slight increase between 1851 and 1861 is more than accounted for by an increase in the gardens of the cottiers. The largest proportional decrease in the number of holdings, 8 per cent. above that for Ireland, has been in Munster, where, as will be seen from subsequent statistics, the increase of the acreage under pasture has also been greatest.

The relation which the decrease in the number of holdings has had to the decrease in tillage may be to some extent understood from Table VIII., which gives the percentages of acreage in the various classes of holdings for 1854, 1861, and 1871, with the percentage of land in each class under crops, grass, fallow, woods, and bog or waste respectively. The registrar-general's returns do not supply materials for such a table for 1851. It will be seen that there is an uninterrupted decline in the proportion of land under crops according to the increase in the size of the holdings, it being over 80 per cent. in those less than 1 acre, over 60 per cent. in those above 1 and not exceeding 5 acres,

and only a little over 3 per cent. in those above 500 acres. On the other hand, the acreage under grass is in farms between 1 and 5 acres only about 28 per cent., and reaches its maximum, nearly 60 per cent., in farms above 200 and under 500 acres; and, while the extent of bog and waste is scarcely 8 per cent. in farms between 1 and 5 acres, it gradually increases with the increase in the size of the farm until it is over 60 per cent. in those above 500 acres. The acreage under crops remained nearly stationary between 1854 and 1871 in all the classes of farms, but the acreage under grass increased 2.5 per cent., the increase being wholly in farms of above 30 acres, while there was a decrease of about 1 per cent. in the case of all classes of farms below 15 acres in extent. The increase may almost be accounted for by reclamations, the decline in the acreage under bog and waste being between the same periods about 2.4 per cent., which occurs principally in farms above 50 acres in extent, there being a considerable increase in the case of some of the other classes of farms. The nature of the change in regard to cropping and tillage which has taken place since 1847 is shown more distinctly in Table IX., which gives the acreage under the different kinds of crop in 1847, 1851, 1861, 1871, 1879, and 1880. Table X. gives the acreage under crops, grass, fallow, woods, and waste for 1851 and 1880, and Table XI. shows in detail the proportions per cent.

The general result of Table IX. is to show a total decline between 1847 and 1880 in the area under crops amounting to 157,351 acres, the decrease having taken place after 1861, up to which year there was from 1847 an increase of 651,961, the decline between 1861 and 1880 being 809,312, or more than one-seventh. The stated area under crop in 1847 conveys, however, a misleading impression, as the area under potatoes was only 284,116 acres, whereas in 1846 it was estimated at 1,237,441, the difference being undoubtedly due to the fact that in 1847 a great portion of this area was left out of cultivation. Thus, if 1846 had been substituted for 1847 it would have been found that in the area under crops there was a decrease between 1846 and 1851 probably as great as that which occurred between 1851 and 1880. This latter decrease amounted to 777,727 acres or 3.8 per cent. of the area of the country, the decrease in Leinster being 383,143 or 7.6 per cent., in Munster 268,351 or 4.5 per cent., in Ulster 107,750 or 2 per cent., and in Connaught 18,623 or .4 per cent. Unfortunately the

TABLE X.—*Areas (in Acres) under Crops, &c., in 1851 and 1880.*

	Crops.	Grass.	Fallow.	Woods.	Waste.	Total.
Leinster.....	(1851) 1,756,413	2,177,441	73,863	101,776	698,212	4,837,705
	(1880) 1,403,270	2,648,283	5,560	105,555	675,593	4,838,261
Munster.....	(1851) 1,508,329	2,749,660	52,453	103,665	1,520,671	5,934,788
	(1880) 1,239,988	3,322,406	2,442	116,395	1,523,453	5,934,684
Ulster.....	(1851) 1,851,995	2,111,736	30,528	58,611	1,258,422	5,311,292
	(1880) 1,744,245	2,210,158	4,977	84,904	1,297,296	5,321,580
Connaught.....	(1851) 512,204	1,709,740	38,209	40,854	1,732,187	4,233,194
	(1880) 695,581	2,078,261	2,427	53,004	1,405,968	4,233,239
Ireland.....	(1851) 5,855,951	8,748,577	195,053	304,906	5,209,492	20,516,932
	(1880) 5,061,222	10,259,108	15,406	339,558	4,532,308	20,297,762

1 Including more than 130,000 acres under water.

2 Exclusive of nearly 500,000 acres under the larger rivers, lakes, and tideways.

TABLE XI.—*Percentage of Area under the principal Crops, and under Grass, Fallow, Woods, and Waste, in 1851 and 1880.*

	Wheat.	Oats.	Barley.	Total Cereals.	Potatoes.	Turnips.	Total Green Crop.	Meadow.	Total under Crop.	Grass.	Fallow.	Woods.	Waste.
Leinster.....	1851 4.2	12.7	2.0	19.8	3.9	2.2	7.0	9.9	36.9	45.0	1.5	2.1	14.5
	1880 0.9	6.3	3.2	10.6	2.1	2.1	6.0	12.3	29.3	54.7	0.0	2.1	13.9
Munster.....	1851 3.0	6.7	2.2	12.3	4.1	2.1	6.6	6.3	25.4	46.4	0.9	1.7	25.6
	1880 0.9	4.2	0.8	6.1	3.4	1.3	5.4	9.6	20.9	56.0	0.0	2.0	21.1
Ulster.....	1851 1.7	16.7	0.5	19.7	5.3	2.0	7.9	4.9	34.8	39.8	0.6	1.1	23.7
	1880 0.7	12.0	0.1	13.0	5.7	1.7	8.9	8.9	32.8	41.5	0.1	1.2	24.4
Connaught.....	1851 0.7	6.8	0.6	8.5	3.6	1.8	4.9	3.1	16.8	40.3	0.9	1.0	41.0
	1880 0.1	4.3	0.2	4.8	4.1	0.5	5.2	5.1	16.4	49.1	0.1	1.2	33.2
Total, Ireland.....	1851 2.4	10.7	1.4	15.2	4.2	1.8	6.7	6.1	28.8	43.0	1.0	1.5	25.7
	1880 0.7	6.3	1.2	8.1	4.0	1.5	5.5	8.1	25.0	50.5	0.0	1.7	22.8

commissioners' reports do not give the acreage in 1847 under grass, and the census returns of 1841, though they give the acreage of arable land, do not distinguish between that under grass and that under crop. If, however, we deduct the amount under crop in 1847 from the total arable area in 1841, which is stated at 13,464,000 acres, we have only 8,225,425 acres under grass, the increase of grass land between 1841 and 1851 being, according to this calculation, 523,152 acres, while if we add the acreage left out of crop in 1847 it is probably 1,000,000 acres more. Since 1851 the acreage under grass has been gradually but uninterruptedly increasing, the increase between that year and 1880 being 1,510,531 acres or 7.5 per cent. of the whole country, there being thus in all probability about 2,500,000 more acres under grass in 1880 than in 1841. In Leinster the increase has been 470,842 acres or 9.7 per cent., in Munster 572,746 or 9.6 per cent., in Ulster 98,422 or 1.7 per cent., and in Connaught 368,521 or 8.8 per cent. The largest percentage under grass is in Munster, and the smallest in Ulster, the proportionate difference between the two being 14.5 per cent. But in addition to this stated increase of acreage under grass, it is to be remembered that a large proportion of the acreage under meadow and clover comes properly under this category, being really untilled land, and that this has increased between 1847 and 1880 by 770,961 acres, the increase in Leinster being 146,227, in Munster 253,866, in Ulster 211,334, and in Connaught 159,534. Thus if we deduct the area under meadow, the decrease in the area under crops between 1847 and 1880 would, even according to this table, be 928,312 acres, there being a decrease in cereals of 1,547,145, and an apparent increase in the area of green crops of 519,611 acres, and in flax of 99,222. As, however, about 1,000,000 acres formerly under potatoes were in 1847 left out of cultivation, it is probable that between 1846 and 1880 there was a decrease in the acreage under green crops as large as the apparent increase between 1847 and 1851. If, on the other hand, the acreage under meadow and clover be added to that under grass, the increase between 1851 and 1880 of the two combined is 2,175,552 acres, and between 1841 and 1880 it is probably nearly 3,500,000.

Sir William Petty estimated the area of Ireland in 1641 at 10,500,000 Irish acres, or 17,008,264 English acres, of which he classed 1,500,000 Irish acres, or 2,429,752 English acres, as rivers, highways, bogs; an area of similar extent as very coarse land; and 7,500,000 Irish acres, or 12,148,760 English acres, as good meadow, arable, and pasture. According to the returns of the Census Commissioners of 1841, the area of arable land comprehended 13,464,000 acres, plantations 374,482, water 630,825, and uncultivated land 6,295,735. Between 1841 and 1851, owing to works undertaken both by Government and private proprietors in order to give relief at the period of famine, the area of arable land showed the large increase of 1,338,581 acres, there being a decrease in the extent of waste land amounting to 1,086,493 acres, and in the area under woods amounting to 69,476, while the area under waste includes a large acreage under water. The returns of 1841 are, however, much less accurate than those from 1847. Between 1851 and 1880 the arable lands increased

from 14,802,581 to 15,355,598 acres, or by 553,017, there being a decrease in the waste land of 577,184 acres, and an increase of the area under woods of 34,952 acres, while the total acreage of the country is stated in somewhat larger figures. The percentage of decline in waste land for the whole acreage of the country was 2.9, there being a decline of .6 in Leinster, and of 4.5 in Munster, an increase, strange to say, of .7 in Ulster, and a decline of 7.8 in Connaught, where there is still the large percentage of 33.2. Of the 4,632,308 acres returned for Ireland under the head of waste land in 1880, 1,718,356 acres were returned as bog and marsh, viz., 325,864 in Leinster, 324,826 in Munster, 372,387 in Ulster, and 695,309 in Connaught; and 2,064,361 acres as barren mountain land, 157,618 being in Leinster, 699,732 in Munster, 679,285 in Ulster, and 527,726 in Connaught. According to the report of Sir Richard Griffith, the total number of acres improvable in 1844 was 3,755,000, of which 1,425,000 were improvable for cultivation and 2,330,000 for pasturage. The reclamations of waste between 1841 and 1851 nearly all took place after 1844, and the total acreage of reclamations between 1841 and 1880 is 1,663,427, leaving therefore an acreage in 1880 of waste but reclaimable land amounting to 2,091,573. The term waste land is, however, used in a rather vague sense, and might without much exaggeration be made to include a considerable portion of the area now classed as arable. The significance of the change which has taken place in the acreage of the principal crops will be better understood if the tables already given are compared with Tables XII. and XIII.

The area under cereals has declined between 1847 and 1880 by 1,547,145 acres, or nearly one-half; while in 1847 the produce of cereals reached 2,548,723 tons, in 1878 it amounted to only 1,226,655 tons, and in 1880 to 1,275,678 tons, the difference between 1847 and 1878 amounting to 1,322,068, and between 1847 and 1880 to 1,273,045. Allowance must, however, be made for the fact that since 1855 the estimates of produce, having been corrected by the Poor Law Guardians, have generally been lowered; and of course the weather introduces a very variable element. In any case it would appear that generally there has been a decline in productive power from 1856 until 1871. For the five years up to and including 1860 there is a much lower average than for the five previous years, and the decline still continues for the ten years up to and including 1870; but, except in the case of potatoes and cabbage, there is an increase for the ten years following, due to the high averages of 1874 and the two subsequent years. The decline in the productive power may doubtless in a considerable degree be accounted for by the fact that the increase in the acreage under pasturage took place chiefly in the richer districts of the country, but it is also attributable, as is the low average still attained, to inadequate manuring, insufficient draining, inattention to the destruction of weeds, over-cropping, or in a word, to general ignorance in regard to the proper methods of culture. In some isolated instances the system of agriculture practised is quite on a par with that on the best farms of England and Scotland, and within recent years considerable progress has been made; but as a whole an approach to a satisfactory state of things exists only in Ulster, where

TABLE XII.—*Estimated Produce in Tons of the principal Crops for all Ireland in 1847, 1851, 1861, 1871, 1878, and 1880.*

	Wheat.	Oats.	Barley.	Bere.	Rye.	Beans.	Pense.	Potatoes.	Turnips.	Mangel.	Cabbage.	Flax.	Hay.
1847	614,575	1,612,921	248,933	42,398	12,784	17,112		2,048,195	5,760,616	247,269	...	17,499	2,190,317
1851	313,620	1,507,876	248,299	44,275	19,692	31,123		4,441,022	6,081,326	466,235	401,622	33,861	2,518,977
1861	178,881	1,126,324	119,470	2,441	4,582	8,093	736	1,858,433	3,392,884	546,545		22,568	2,810,352
1871	143,121	1,035,529	167,927	1,345	5,253	8,958	879	2,793,641	4,246,332	761,863		12,919	3,315,525
1878	115,384	907,232	195,885	495	7,659	7,335	560	2,526,504	4,686,226	1,090,200		22,175	4,417,344
1880	111,385	977,923	172,222	411	3,648	9,694	399	2,985,859	4,339,688	604,421	360,036	25,532	3,795,003



agriculture has the stimulus both of tenant-right and of manufactures. In Ulster the average produce per acre is now equal to the average of Ireland, although in 1642 it was rated to the "adventurers" as worth only 4s. an acre, while land in Leinster was rated at 12s., in Munster at 9s., and in Connaught at 6s. The southern and western districts of the country lag farthest behind, and generally proximity to Great Britain seems to exercise an advantageous influence. Griffith's valuation, apart from other objections, of course supplies no test as to the agricultural value of the land at the present time, and has the disadvantage that the southern and western districts were valued immediately after the famine. By it the total annual value of Ireland was given as £11,439,575, that of Ulster being £2,533,265, of Munster £3,247,177, of Leinster £4,305,413, and Connaught £1,353,720.

An increase in the average produce of wheat per acre might naturally be expected from the fact that its area is now restricted to those districts where soil and climate are specially suitable. The decline in the area under wheat between 1847 and 1880 has been 595,235 acres, or more than four-fifths. It has been specially large in Leinster and Munster, but the fact that it has also been considerable in Ulster and Connaught shows that it must be attributed to other causes besides a real or supposed unsuitability of climate. In 1878 the amount of wheat produce was less by 499,191 tons than in 1847, and in 1880 it was less by 503,190 tons. The decrease in the acreage under oats has not been proportionally so great; but, inasmuch as oats are the staple crop of the country, it is perhaps even more significant. Between 1847 and 1880 the decrease in area was 818,927 acres; and the decline in amount of produce in 1878 as compared with 1847 was 705,689 tons, and in 1880 it was 634,998 tons. The decrease in

the acreage under cereals has by some been accounted for by an increase in that under potatoes, but although between 1851 and 1861 this increased by 265,003 acres, it has since gradually diminished, being 47,773 less in 1880 than in 1851. The increased productiveness of the potato in 1880 is attributed both to the favourable season and the importation of new varieties, especially the "Champion." The report of the special potato inquiry of 1880 shows that "Champions" were grown on 220,934 acres, "White Rocks" on 194,778, "Skerry Blues" on 116,959, and "Scotch Downs" on 98,342. Between 1851 and 1880 there has been a diminution in the total area under green crops of 125,247 acres. It is certainly remarkable that, while the number of cattle has so largely increased, not only the area but until recent years the average produce per acre of turnips and mangolds, the staple winter food of cattle, has been diminishing. The aggregate produce of turnips was less by 1,395,100 tons in 1878 than in 1851, in 1879 by 4,023,522 tons, and in 1880 by 1,741,638.

The nature of the increase which has taken place in live stock since 1841 is brought out in Tables XIV.-XVII.

The returns for 1851 give no information as to the number of horses used for agricultural purposes, but Table XV. supplies this information for 1861, 1871, 1879, and 1880. Table XVI. gives the total value of each kind of live stock for 1841, 1851, and 1871 on holdings above one acre, and the average value of the same on each holding, the valuation given agreeing with the rate originally fixed by the commissioners, according to which horses were estimated at £8 each, asses at £1, cattle £6, 10s., sheep £1, 2s., pigs £1, 5s., goats 7s., and poultry 6d. The value of all classes of live stock has of course greatly increased within recent years, but although

TABLE XIII.—Estimated Average Produce per Statute Acre in 1847, 1851, 1861, 1871, 1878, and 1880, and also for certain periods of years.

	Year	Wheat.	Oats.	Barley.	Bere	Rye.	Beans.	Pease.	Potatoes	Turnips	Mangl.	Cabbage	Flax.	Hay.
		cwts.	cwts.	cwts.	cwts.	cwts.	cwts.	cwts.	tons.	tons.	tons.	tons.	stones.	tons.
Leinster.....	1847	17.3	15.2	18.2	17.8	22.0	14.4	11.9	7.4	15.1	19.0	...	48.0	1.9
	1851	12.0	15.1	17.6	17.4	20.5	12.9	11.9	5.3	16.5	17.9	14.0	38.5	2.1
	1861	8.8	11.4	13.2	13.2	12.8	11.7	11.8	1.9	11.9	10.5	10.1	24.9	1.7
	1871	11.8	13.7	15.3	15.5	12.1	18.3	17.0	2.8	14.1	13.6	10.4	27.4	1.7
	1878	16.0	14.1	16.2	18.2	16.1	19.0	9.4	3.1	15.2	15.8	10.3	31.5	2.2
	1880	15.3	15.1	15.4	15.4	13.5	20.3	17.5	4.0	15.7	14.9	10.0	28.1	1.9
Munster.....	1847	15.0	14.7	17.0	16.6	18.5	13.8	11.2	6.9	15.4	17.3	...	48.0	2.0
	1851	11.8	13.7	17.4	14.6	21.0	13.9	11.2	5.1	15.5	17.6	13.7	35.5	2.0
	1861	8.0	10.0	10.8	11.4	8.5	8.0	9.1	1.4	8.2	8.8	8.5	19.3	1.8
	1871	12.3	13.8	15.4	13.0	10.0	15.9	13.7	3.1	12.0	13.4	9.3	24.8	1.9
	1878	13.7	12.2	15.2	16.9	12.3	11.1	10.7	1.9	12.8	14.7	8.9	27.3	2.3
	1880	15.1	15.6	17.3	15.3	10.6	17.4	13.5	4.2	13.7	14.7	8.9	31.8	2.0
Ulster.....	1847	17.0	14.5	16.8	17.0	20.5	14.2	11.8	7.4	16.5	17.7	...	48.0	1.9
	1851	14.5	13.0	17.6	15.8	19.5	14.4	11.8	4.6	15.6	19.6	14.1	38.6	1.9
	1861	12.0	11.9	13.0	12.4	11.8	15.5	8.3	1.9	11.1	11.9	11.5	24.5	2.0
	1871	12.7	11.7	13.1	12.3	11.0	20.2	13.0	2.2	13.1	13.9	9.3	12.5	1.9
	1878	15.9	13.5	17.3	16.5	15.0	16.3	9.5	3.6	14.6	15.2	9.8	31.8	2.2
	1880	15.0	13.4	16.1	13.9	10.3	20.5	12.9	3.8	14.0	14.2	9.6	25.9	1.9
Connaught.....	1847	16.0	14.2	18.4	17.2	20.5	13.6	11.2	7.5	14.5	16.3	...	48.0	1.9
	1851	12.0	13.7	18.2	16.8	19.8	13.0	11.2	5.5	16.0	17.7	15.6	40.7	2.0
	1861	6.8	11.0	12.2	10.6	9.8	11.2	5.1	1.3	9.1	11.2	12.7	24.1	1.8
	1871	10.6	12.6	14.6	13.3	10.8	13.4	9.9	2.8	12.0	13.5	11.6	18.7	1.9
	1878	15.9	14.0	18.0	14.9	13.7	12.4	15.5	3.0	13.6	14.6	13.4	27.2	2.3
	1880	12.1	13.1	14.2	12.5	9.3	13.8	10.2	2.4	12.3	13.0	12.2	23.1	2.1
Ireland .....	1847	16.5	14.7	17.4	17.2	20.5	14.2	11.6	7.2	15.5	18.0	...	48.0	1.9
	1851	12.5	13.8	17.6	16.6	20.0	13.9	11.6	5.1	15.9	18.0	13.9	38.6	2.0
	1861	9.0	11.2	12.4	12.8	10.5	13.0	9.4	1.6	10.2	10.3	10.4	24.4	1.8
	1871	12.1	12.7	15.2	14.5	10.8	18.8	14.1	2.6	13.0	13.5	10.0	13.2	1.8
	1878	15.0	13.5	16.1	16.9	14.1	17.4	9.8	3.0	14.2	15.2	10.2	31.7	2.3
	1880	15.0	14.2	15.8	14.7	10.3	20.3	12.5	3.6	14.3	14.6	9.9	25.6	2.0
Ireland, average for five years 1851-55	14.0	14.2	18.1	16.5	20.0	14.2	12.5	5.5	16.1	17.8	13.7	39.3	2.0	
" " " " " 1856-60	12.3	12.4	14.7	14.9	12.6	14.6	11.6	3.8	11.5	12.2	10.6	27.5	1.9	
" " " " " ten years 1861-70	11.8	12.0	15.1	15.0	10.3	15.9	11.1	3.2	11.1	11.2	10.7	25.4	1.8	
" " " " " 1871-80	13.9	13.1	16.0	15.6	11.5	17.8	11.3	3.0	12.5	13.5	9.9	26.5	2.0	

a table representing the actual increase of value in live stock would throw an important light on certain aspects of Irish agriculture, these considerations cannot be entered into here, and as the increase is due almost entirely to other causes than increased merits in the live stock, a table at a fixed rate more exactly represents the change in value so far as it depends upon the agriculturist.

As horses and mules are classed together in the returns of 1841, no comparison can be made as to the difference in the number of horses between that year and 1880; besides, the returns of 1841 are much more inaccurate than those since 1847. Between 1851 and 1880 horses increased by 35,447, but between 1861 and 1880 they decreased by 57,079, agricultural horses diminishing by 66,853, undoubtedly an indication of a diminution in tillage, but not a criterion as to its amount, both because the horses are not fully occupied, especially on small farms,

and because a considerable amount of farm work is done by bullocks, which are much better suited for this work than the small and weak horses kept on most farms. Asses have more than doubled in numbers since 1841, and have increased between 1851 and 1880 by 49,264, a sign both of poverty and of lazy and inefficient work.

Cattle have increased between 1841 and 1880 by 2,080,471, or have more than doubled in numbers, and between 1851 and 1880 by 953,565, or scarcely so much as between 1841 and 1851. The only pure native breed of cattle now in Ireland is the "Kerry," a light handsome animal, black or red in colour, with upturned horns. It is easily kept, and in quality both its flesh and its milk resemble those of the finer West Highlands. The variety known as the "Dexter," a cross between the "Kerry" and some unknown breed, is shorter and plumper than the pure "Kerry," and has none of its finer points; and

TABLE XIV.—Number of the various kinds of Live Stock in Ireland and its four Provinces for 1841, 1851, 1861, 1871, and 1880. (The figures for 1880 in Tables XIV. and XV. are taken from the Agricultural Abstract, and differ slightly from those in the complete return.)

	Leinster.					Munster.					
	1841.	1851.	1861.	1871.	1880.	1841.	1851.	1861.	1871.	1880.	
Horses.....	{ Two years and upwards.....	...	143,636	150,293	133,932	130,904	...	115,278	127,413	112,469	105,410
	{ One and under two.....	...	12,139	24,437	18,681	25,170	...	6,366	16,494	14,169	19,441
	{ Under one.....	...	14,739	16,600	14,712	17,214	...	9,035	12,023	14,164	15,506
Total.....		168,753	170,514	191,390	167,325	173,988	160,378	131,279	155,930	159,802	140,357
Mules.....		...	7,327	7,795	7,102	8,170	...	7,856	6,723	6,477	8,798
Asses.....		23,399	39,983	49,124	48,719	49,873	23,970	34,081	46,316	48,731	55,838
Cattle.....	{ Two years and upwards.....	...	435,975	594,448	593,951	597,444	...	553,655	748,891	759,423	740,929
	{ Under two years.....	...	140,599	148,926	190,466	231,870	...	142,890	151,114	202,846	234,173
	{ Under one.....	...	125,555	123,192	162,039	168,569	...	155,001	151,209	268,830	315,208
Total.....		488,855	702,129	866,566	948,456	997,883	530,273	851,546	1,051,274	1,231,099	1,290,312
Sheep.....	{ One year and upwards.....	...	542,750	818,083	895,960	834,059	...	380,954	580,202	609,137	514,600
	{ Under one year.....	...	207,039	414,800	470,995	436,900	...	160,214	313,646	382,040	321,730
Total.....		657,118	749,789	1,232,883	1,366,955	1,270,959	695,622	541,168	893,848	1,021,177	836,335
Pigs.....	{ One year and upwards.....	...	99,460	49,633	51,037	26,344	...	171,198	109,399	92,389	47,158
	{ Under one year.....	...	215,498	230,937	344,715	190,581	...	235,501	322,860	478,395	286,377
Total.....		366,772	314,958	280,590	395,812	222,925	522,895	408,419	432,259	570,784	333,895
Goats.....		...	64,471	52,186	58,508	67,474	...	85,545	74,597	81,165	88,102
Poultry.....		2,206,941	2,101,438	2,756,237	3,087,375	3,367,677	2,834,752	1,826,350	2,808,639	2,942,952	3,396,544

	Ulster.					Connaught.					Ireland.					
	1841.	1851.	1861.	1871.	1880.	1841.	1851.	1861.	1871.	1880.	1841.	1851.	1861.	1871.	1880.	
Horses.....	{ Two & upwards.....	...	147,663	166,205	150,815	152,472	...	45,212	58,066	47,784	46,844	...	451,759	501,977	444,980	425,694
	{ Under two years.....	...	6,815	11,598	7,324	12,368	...	4,402	10,035	6,570	10,464	...	30,322	62,584	46,344	67,463
	{ Under one.....	...	9,500	12,659	10,427	11,617	...	6,321	8,399	7,868	9,723	...	39,936	49,691	46,171	54,066
Total.....		155,425	163,378	180,472	168,766	176,477	68,013	55,935	76,500	62,202	67,031	532,569	521,706	614,232	538,065	557,153
Mules.....		...	2,024	2,098	1,865	2,239	...	4,299	3,330	4,373	5,693	...	21,606	20,146	19,817	24,900
Asses.....		13,337	23,486	26,001	24,706	22,518	29,400	39,431	53,070	58,217	58,016	90,315	138,981	173,711	180,373	186,245
Cattle.....	{ Two & upwards.....	...	580,701	675,486	647,145	576,902	...	277,386	372,935	386,280	346,027	...	1,847,717	2,391,780	2,988,789	2,261,302
	{ Under two years.....	...	191,435	171,353	224,534	225,960	...	113,429	87,108	128,450	126,699	...	588,344	558,503	746,598	818,704
	{ Under one.....	...	168,857	176,198	289,109	249,632	...	81,987	70,786	121,799	107,611	...	531,400	521,423	841,777	841,029
Total.....		525,584	940,993	1,023,039	1,161,088	1,052,494	235,840	472,793	530,809	636,529	589,337	1,840,555	2,967,461	3,471,688	3,977,172	3,921,026
Sheep.....	{ One & upw rds.....	...	182,996	243,872	334,310	241,941	...	437,520	745,773	888,046	714,493	...	1,544,220	2,387,930	2,757,453	2,305,098
	{ Under one year.....	...	70,137	143,609	158,214	...	...	140,518	296,053	415,156	339,418	...	577,908	1,168,120	1,475,982	1,256,263
Total.....		212,671	253,133	387,481	542,101	400,155	525,788	578,038	1,041,838	1,303,202	1,053,912	2,091,199	2,122,128	3,556,050	4,233,435	3,561,361
Pigs.....	{ One & upw rds.....	...	75,733	38,771	56,150	26,348	...	44,587	34,246	32,650	15,459	...	391,698	230,049	232,226	115,309
	{ Under one year.....	...	171,098	208,638	365,314	147,911	...	70,062	111,538	200,713	102,508	...	893,139	871,993	1,389,197	733,737
Total.....		292,512	246,851	243,409	421,464	174,259	170,922	114,649	145,784	233,363	117,967	1,353,101	1,064,857	1,102,042	1,621,423	849,046
Goats.....		...	51,716	38,679	57,586	73,010	...	33,581	24,380	34,114	37,102	...	235,313	189,842	231,373	265,688
Poultry.....		1,895,678	2,386,637	2,947,873	3,596,294	4,240,861	1,897,056	1,188,269	1,538,426	2,090,561	2,421,647	8,334,427	7,470,694	10,371,175	11,717,182	13,426,728

TABLE XV.—Number of Horses used in Agriculture, of Milch Cows, and of Ewes in 1861, 1871, 1879 and 1880.

	Leinster.			Munster.			Ulster.			Connaught.			Ireland.			
	1861.	1871.	1880.	1861.	1871.	1880.	1861.	1871.	1880.	1861.	1871.	1880.	1861.	1871.	1879.	1880.
Horses used for agricultural purposes.....	123,167	105,596	103,896	113,649	98,732	92,755	155,735	138,881	130,608	52,063	42,322	41,502	444,614	385,471	378,757	377,761
Milch cows.....	267,136	251,265	231,440	562,028	584,967	549,384	504,186	492,992	429,018	211,823	216,438	186,991	1,545,168	1,545,662	1,464,816	1,396,833
Ewes.....	489,056	535,740	505,093	420,806	464,786	361,531	186,132	245,400	177,611	492,257	506,032	405,211	1,528,251	1,761,958	1,624,846	1,449,446



in Connaught there is another breed of cattle which is also a coarse variety of the "Kerry." In some parts of the country the Scotch West Highland breed has been introduced. The "old Irish" breed which existed in the central parts of the country has now been all but eradicated by crossing. The English Longhorn was at first the animal principally used to improve the breed of the Irish cattle, but it was ultimately supplanted by the Shorthorn, and the greater number of Irish cattle are now crosses with that breed. Polled Scotch cattle have also been largely introduced into the mountain districts, and in Ulster and Cork the Ayrshire or a cross between it and the Shorthorn is the breed chiefly used for dairy purposes. Milch cows in 1880 exceeded a third of the total number of cattle,—the numbers of the three classes of other cattle (those under one year, those above one and under two years, and those above two years) being pretty nearly equal. The proportion of milch cows to the total number of cattle in Leinster was less than one-fourth, in Munster nearly one-half, in Ulster above nine-twentieths, and in Connaught about three-eighths. Since 1861 the number of milch cows has decreased by 148,335, the decrease having nearly all taken place since 1871. Dairy farming is carried on chiefly in the south, more especially in Cork, where the methods practised are generally greatly superior to those of the other districts. In Cork the cows are generally wintered partly on turnips or cabbage, and to some extent also on artificial feeding stuffs, but in other districts they are often not housed even in winter, and what they gather from the winter pastures is supplemented only by an allowance of hay. The milk is used chiefly in the manufacture of butter, the buttermilk being employed for feeding pigs, and forming also along with potatoes or straw an important element of family diet. On account of the bad household arrangements of the small farms, the butter manufactured is often dirty and unwholesome; and it is also frequently oversalted. Cheese is not manufactured except by some of the Scotch or English farmers for their own use. The proportion of calves kept may be gathered from the number of cattle under one year old, which in 1880 was less than the number of cows by 555,813. On the best farms the cow calves are generally kept. Only a very small number of calves are fattened for the butcher, but many are killed

when only a few days old. Those that are kept scarcely ever receive warm milk after the first week, but are fed chiefly on buttermilk, hay-tea, and similar substitutes. This early process of half starvation, joined to imperfect winter housing and feeding, leaves effects on the constitution of the animals which greatly lessen their value for the butcher; and, although the breed of cattle in Ireland is one which fattens quickly on good pasturage, the animals, besides being smaller than they would otherwise have been, are always deficient in "tallow," and generally weigh about 2 stones less than those of apparently similar dimensions reared in England or Scotland. Scientific cattle-feeding is only practised in exceptional cases.

Sheep have increased between 1851 and 1880 by 1,439,233, there having been very little increase between 1841 and 1851. The number is smallest in Ulster, which possesses only about one-eighth of the whole. The old native breed has been greatly improved by the introduction of Leicesters, and within recent years Border Leicesters have been largely introduced, as well as Shropshire Downs. In the mountain western districts there are large flocks of Cheviots and Scotch Blackfaced. The sheep possessed by the small farmer are generally of a very mongrel character.

Pigs between 1841 and 1851 decreased by 268,244, but between 1851 and 1861 increased by 17,185, and between 1861 and 1871 by 519,381, while between 1871 and 1880 they declined by 772,377. They constitute a very important item in the economy of the small farmer, and their carcases are largely sold to supply the English market. The old Irish "grey-hound" pigs, which were very nearly allied in race to the wild boar, are now almost extinct, their place having been taken chiefly by Berkshires, although Yorkshire and Cumberland breeds are not uncommon.

Table XVIII. shows the progress of the cattle export trade to the United Kingdom since 1790.

Between 1841 and 1851 poultry diminished by 863,733, much less than might have been expected from the decrease in small farms; and between 1851 and 1880 their numbers have nearly doubled, the larger portion of the small farmers' returns being now often obtained from the rearing of geese and turkeys and the produce of eggs. The breed of domestic fowls is somewhat mixed, but Dorking and Spanish fowls are becoming more common.

TABLE XVI.—Value of Live Stock on Holdings above 1 acre, and Average Value per Holding, in 1841, 1851, and 1871.

	Horses.	Asses.	Cattle.	Sheep.	Pigs.	Goats.	Poultry.	Total.
	£	£	£	£	£	£	£	£
Total value on holdings above 1 acre . . . . .	1841 4,215,768	66,512	11,446,916	2,181,365	1,329,989	No return.	159,270	19,399,850
	1851 4,167,080	123,317	19,153,023	2,325,703	1,289,965	83,919	178,143	27,326,150
	1871 4,245,056	171,101	25,793,605	4,646,423	1,929,379	82,488	279,416	37,147,468
	£ s. d.	£ s. d.	£ s. d.	£ s. d.	£ s. d.	£ s. d.	£ s. d.	£ s. d.
Average value on each holding above 1 acre . . . . .	1841 6 2 0	0 1 11	16 11 3	3 3 1	1 18 6	0 0 0	0 4 7	28 1 4
	1851 7 6 1	0 4 6	33 11 7	4 1 7	2 5 3	0 2 11	0 6 3	47 18 2
	1871 7 16 0	0 6 4	47 8 1	8 10 9	3 10 11	0 3 0	0 10 3	68 5 4

TABLE XVII.—Value of Live Stock on each class of Holding, and Average Value per Holding, in 1851 and 1871.

Farms.	Not exceeding 1 Acre.	Not exceeding 5 Acres.	Not exceeding 15 Acres.	Not exceeding 30 Acres.	Not exceeding 50 Acres.	Not exceeding 100 Acres.	Not exceeding 200 Acres.	Not exceeding 500 Acres.	Above 500 Acres.	Total.
	£	£	£	£	£	£	£	£	£	£
Value of live stock, 1851..	411,243	590,913	3,526,521	5,415,643	4,586,514	5,438,774	4,041,285	2,863,461	857,039	27,737,398
	£ s. d.	£ s. d.	£ s. d.	£ s. d.	£ s. d.	£ s. d.	£ s. d.	£ s. d.	£ s. d.	£ s. d.
Average value per holding	5 17 7	6 14 2	18 7 3	38 6 6	65 8 8	108 18 1	204 11 10	365 13 6	588 4 5	47 18 2
	£	£	£	£	£	£	£	£	£	£
Value of live stock, 1871..	405,869	668,583	4,410,081	7,201,947	6,346,285	7,903,005	5,687,549	3,786,540	1,143,478	37,553,337
	£ s. d.	£ s. d.	£ s. d.	£ s. d.	£ s. d.	£ s. d.	£ s. d.	£ s. d.	£ s. d.	£ s. d.
Average value per holding	5 5 8	8 18 8	25 14 7	51 18 10	87 3 9	143 10 7	262 2 11	462 6 8	729 5 2	60 9 6

An approximation to a proper estimate of the deficiencies of the chief branch of Irish agriculture, the rearing of cattle, may be obtained by a computation founded on a comparison of its statistics with those of Great Britain. In 1889 the average number of cattle to every 100 acres under cultivation was 25.5, the average of England being 16.9, of Wales 23.7, of Scotland 23.2, and of Great Britain 18.4. Horses in the same year had an average in Ireland of 3.3, that of England being 4.4, of Wales 4.9, of Scotland 4.1, and of Great Britain 4.4. The average of sheep was for Ireland only 23.2, while for England it was 68.4, for Wales 98.2, for Scotland 149.3, and for Great Britain 82.9. Of pigs the average in Ireland was 5.5, in England 6.9, in Wales 6.6, in Scotland 2.6, and in Great Britain 6.2. While in Great Britain, with a permanent pasturage of 14,426,959 acres, the number of cattle amounted to 5,912,046, in Ireland, with a permanent pasturage of 10,259,108 acres, they amounted to 3,921,026, the number of cattle in England to every 100 acres under grass being 41.0, while in Ireland it was 38.2. But in addition to this the pasturage of Great Britain supported 26,619,050 sheep, while that of Ireland supported only 3,561,361, or rather fewer sheep than cattle, and less than one-seventh of the number of sheep supported in Great Britain; and if we regard six sheep as equal to one of the cattle; which is less than the estimated value, the number of cattle supported on every 100 acres in Great Britain would be 71.7, the number in Ireland being only 44.6. It would certainly not be exaggeration to estimate the cattle of Great Britain as on an average one-fourth better than those of Ireland, and if this be so it follows that compared with Ireland at least double the value of cattle and sheep are supported on the same amount of pasturage in Great Britain. (Thom's *Almanac* gives the value of cattle, sheep, and pigs of Ireland in 1880 as £60,994,429, and those of Great Britain as £138,559,045, reckoning those of each country as individually of equal value.) In Great Britain, however, the combined area under rotation grasses and under green crops, excluding potatoes, is 7,360,060 acres, as against only 2,326,538 in Ireland, the area devoted chiefly to the rearing of cattle and sheep being in Great Britain 21,787,019 acres, while in Ireland it is only 12,585,646, the average, reckoning six sheep as equal to one of the cattle, being thus 47.5 animals to every 100 acres devoted to rearing them in Great Britain as against 35.9 in Ireland; or, reckoning the animals in England as one-fourth better, the proportions are 59.3 to 35.9.

If, moreover, it be remembered that in Ireland pasturage occupies nearly all the richer districts of the country, and that where tillage is carried on the first principles of scientific agriculture are generally unknown, we cannot be underestimating the food produce of Ireland in stating it as about two-fifths less for the acreage than that of Great Britain; and since 1847 there has, owing to the increase of pasturage, been a great decline in the production of

food. From the inadequacy of the information given by the Board of Trade it cannot be determined with accuracy to what extent Ireland is dependent on other countries for supplies of corn and meal. From special parliamentary returns we learn that the total foreign imports of grain in 1850 were 1,683,687 qrs., and of meal and flour 220,107 cwt., and that the exports to Great Britain from Ireland exceeded the imports from it in the case of grain by 242,287 qrs., and of flour by 708,008 cwt. In 1855 the exports of corn and meal to Great Britain exceeded the imports from Great Britain and foreign countries together by 451,627 qrs. In the yearly returns of imports of foreign corn and meal into the United Kingdom no separate column is given for Ireland; and, in addition to this, since 1867 no return has been given of the trade in corn and meal between Ireland and Great Britain. Weekly returns of the imports of foreign grain into Ireland are, however, published in the *London Gazette*, and Table XIX., founded on a special parliamentary return and on the *Gazette* returns, gives the total amount of foreign imports of grain and meal in 1865, and in each year from 1870.

Notwithstanding that much of the land now under pasturage is well adapted for turnips or mangolds, the amount of green crop grown is generally quite insufficient for scientific cattle-rearing. In many cases also the grass is laid down after the soil has been exhausted by over-cropping, and little pains generally are taken to improve the soil by draining or manures. The increase in pastoral farming has indeed been largely due to the desire to save trouble, one of the principal difficulties of the large farmer being to obtain, notwithstanding a low general average of wages, the worth of his expenditure in hired labour. The indolent habits of the peasantry, due to long ill fortune, constitute also a principal obstacle to the introduction of spade culture, which has been advocated as well suited for the climate and soil of Ireland, and as affording employment to the largest possible agricultural population. As it is, the small farmer, living in a wretched hovel which he shares with a considerable proportion of his live stock, is able, on account of the fewness and simplicity of his wants, to succeed, though making use of very primitive methods of culture, where the larger farmer wholly dependent on hired labour would fail if he attempted a system of tillage even according to the most approved methods.

For the promotion of the agricultural progress of the country grants of various kinds are bestowed by Government. Since 1847 an Act for granting land improvement loans has been in operation, and since the passing of the Act up to the 31st March 1881 the total number of loans issued has been 7328, amounting to £3,278,762,—the applications for the year 1880-81 being 638, amounting to £161,575. The quantity of land drained since the commencement in 1847 until the 31st March 1881, has been 274,827 acres, at an average cost of £7 per acre. The number of loans for farm buildings sanctioned since the passing of the Act 13 & 14 Vict., c. 31, until the 31st March 1881, has been 1528, amounting to £771,360,—the number of loans sanctioned during the year ending 31st March 1881 being 133, amounting to £53,670. Under 23 Vict., c. 19, the number of loans sanctioned for dwellings for agricultural labourers has been 462, amounting to £263,465,—the cases for the year up to 31st March 1881 being 16, amounting to £11,155. The whole expenditure charged against the different undertakings commenced under the Arterial Drainage Acts (prior to 1863), including £70,201 for rent chargeable to counties, amounted at the close of the operations to £2,390,612, 12s. 4d., of which £2,249,540 was advanced on loan, and £141,073 by way of free grant, and the repayments in respect thereof, including interest, amounted on 31st of March 1881 to

TABLE XVIII.—Number of Cattle, Sheep, and Pigs Exported from Ireland to the United Kingdom.

	1790.	1800.	1810.	1826.	1847.	1857.	1874.	Average 1876-1880.	1880.
Oxen...	19,309	14,013	19,576	57,595	190,952	186,234	551,209	681,083	717,171
Sheep...	...	871	10,293	62,819	524,179	151,807	744,234	673,290	711,491
Pigs....	5,636	4,083	9,330	73,912	167,807	136,162	344,356	493,178	567,126

TABLE XIX.—Imports of Foreign Grain and Meal into Ireland.

	Cwts.		Cwts.		Cwts.
1865	9,363,516	1873	15,787,171	1877	18,562,107
1870	13,761,931	1874	14,437,013	1878	23,592,383
1871	14,356,996	1875	17,521,860	1879	23,913,907
1872	18,803,251	1876	24,123,560	1880	17,876,338



£1,413,944. The loans sanctioned since the passing of the Acts in 1863 amount to £553,295. The advances on account thereof, including interest charged during the operations of the works, amount to £411,116, and repayments, including interest, to £103,448. The total area of land drained and improved is 55,311 acres, at a cost of £325,705. In view of the prevalent agricultural distress, the Government on 29th November 1879 offered to landlords within the radius of distressed districts certain facilities of obtaining loans under the Lands Improvement Acts, and on 12th January 1880 offered additional inducements. Of the sum of £1,500,000 borrowed from the Church Temporalities Commissioners for relief works, £1,166,385 had up to March 1881 been sanctioned as loans to landlords, and of this sum £702,857 had been issued. The amount issued as Seeds Loans, under the Seed Supply Act of 1880, was for year ending 31st March 1881 £494,317, making a total of £647,490 since the passing of the Act.

One of the chief obstacles to agricultural improvement in Ireland has been the unsatisfactory relations between landlord and tenant. The legislation bearing on the subject has been of a very various and contradictory character. An immense number of holdings was created by the Freehold Votes Act of 1793; but in 1816 an Act was passed to facilitate the working of the Ejectment Act first passed in the reign of Queen Anne. In 1851 an Act was passed to facilitate ejectments in cases of implied tenancies from year to year under £50 rental, and in 1860 these facilities were increased and extended to all tenancies. There are no records of evictions earlier than 1849. A special return presented to the House of Commons in April 1881 gives by provinces and counties the number of evictions for each year from 1849 to 1880, as ascertained by the police. The numbers are of course only approximately correct, but err by defect, not by excess. The total number of families evicted during that period was 90,107, comprising 460,570 persons; but of these, 21,340 families, comprising 115,859 persons, were readmitted. Deducting readmissions, the numbers in 1849 were 13,384 families, 72,065 persons; in 1850 they were 14,546 families, 74,171 persons; in 1851 they declined to 8815 families, 43,449 persons; and they gradually diminished until 1856, from which year until 1862 the numbers though fluctuating fell short in each year of 1000 families. There was a considerable diminution from 1865 till 1878, when they rose to 834 families, or 3916 persons, while in 1879 the numbers were 1098 families, or 5576 persons, and in 1880 they were 1893, or 9036 persons. During the half year ending 30th June 1881 the numbers evicted were 1433 families or 6557 persons. In 1865 it was enacted that no evictions should take place without the intervention of the sheriff; but, although a means was thus supplied of obtaining records absolutely correct, the sheriffs in some instances neglect to send in returns. In Table XX. the figures for 1870-79 are taken from the judicial statistics, and those for 1880 from a special return. These ejectments do not include those of cottiers and weekly tenants in towns whose cases are decided by petty sessions. The large increase of ejectments since 1870 shows that the Landlord and Tenant Act of that year has failed in ordinary circumstances to improve the relations between landlord and tenant; and, while some of its provisions have had in certain respects a beneficial effect, it

has also exercised a variety of prejudicial influences, and not only broke completely down under the strain of the famine of 1879, but in many cases led to the almost unavoidable infliction of great hardship on the tenant. The salient principle of the Act was the abandonment of the position assumed in the Act of 1860, which endeavoured to place the relation of landlord and tenant on the simple basis of contract. Stated positively, its leading features were the legal confirmation of the Ulster tenant-right and other ancient customs, the provision made for compensation for loss on quitting and for improvements, and the sanctioning of grants on loan and other facilities to tenants to aid in the purchase of their holdings. Since the passing of the Act the average sum adjudged annually in cases between landlord and tenant has been over £18,000, of which more than a third has been for Ulster tenant-right. The amount adjudged annually has varied considerably but irregularly, and of late years there has been a diminution in the number of cases. The judicial statistics give information, in reference to the several counties and provinces, as to the number of cases, the amount charged where decrees were made, the amount reduced or added on appeal, and the amount adjudged, distinguishing also between compensation for loss on quitting holdings and improvements together, for loss on quitting holdings alone, and for improvements alone. In 1877 and 1878 an additional column was added, giving also the total sum claimed. The sum claimed in 1877 was £225,225 for the 598 cases, an average of £425, the gross sum adjudged being only £15,401, or an average of £25, 10s.; in 1878 the sum claimed was £176,954, an average of £344 for the 514 cases, the gross sum adjudged being £17,063, or an average of £33; in 1879 the gross sum adjudged was £12,654. The total number of loans made to aid tenants in purchasing their holdings up to 31st March 1881 was only 849, and the gross sum granted £492,370. Table XXI. gives various details. According to a special return made to the House of Commons in April 1881, the number of holdings sold by the Church Temporalities Commission up to 30th December 1880 was 2444 to the public, and 6195 to tenants. Of the 411 purchasers who had fallen in arrears, 332 were purchasing tenants, arrears £4619, and 79 other purchasers, arrears £3813.

To remedy the defects of the Act of 1870, a new Act was passed in 1881. Practically it secures to the tenant a near approximation to the "three F's"—"free sale," "fair rent," and "fixity of tenure." "Free sale" is granted so far as is compatible with a due regard to the rights of the proprietor. The "fairness" of a rent may be decided by the "intervention of court," and, while on certain conditions a "fixed tenancy" may be agreed upon between landlord and tenant, an approximation to this is obtained in other cases by provisions in regard to rent and "compensation." Additional facilities have also been given to tenants to purchase their holdings, and provision has been made for grants of money to aid in the reclamation of land and in emigration. A feature of the Act is the creation of a land commission as a supreme court of appeal, except in special cases, in questions between landlord and tenant, and with the power of sanctioning loans.

Leases are not held by so many as one-tenth of the total number of farmers, tenancy-at-will being preferred, partly for the freedom it allows, and partly because it is thought to involve a tacit consent to permanent occupancy.

TABLE XX.—*Ejectment Decrees executed from 1870-80*

	1870.	1871.	1872.	1873.	1874.	1875.	1876.	1877.	1878.	1879.	1880.
Total ejectments .....	1301	1288	1173	1777	2170	2119	1839	1957	2517	3526	2888
Ejectments for non-payment of rent .....	813	861	800	1256	1567	1467	1521	1032	1749	2677	2447

One of the chief hindrances to agricultural progress in Ireland has been absenteeism. According to Sir William Petty, who wrote in 1672, one-fourth of the real and personal property of Ireland was possessed by absentees. Prior, in his *List of Absentees*, published in 1729, divides them into three classes—those who are seldom or never seen in Ireland, those who visit Ireland for a month or two, and those who are occasionally absent. The money spent out of Ireland by the first class he estimated at £204,200, by the second at £91,800, and by the third at £54,000. According to another account, published in 1769, the income of the first class is placed at £371,900, of the second at £117,800, and of the third at £92,000. Arthur Young gives the rental of absentees in his time as £732,200, about one-seventh of the whole estimated rental, and Swift declared that one-third of the rental of Ireland was spent in England. Absenteeism continued to increase until the close of the great war in 1816, and although it diminished from that time, a substitute for many of its evils was supplied by the rapid impoverishment of a large number of idle and extravagant squireens. To help in freeing the country from this incubus, an Act was passed in 1818 to facilitate the sale of encumbered estates in Ireland, which however proved wholly ineffectual, and was superseded by another in the following year appointing a commission of three persons to constitute a court for the purpose. This court commenced its sittings in October 1849, and, from that period until it closed its sittings in August 1859, 3547 sales were effected, the gross amount of which was £25,190,839. In 1859 the court was reconstituted on a permanent footing under the title of the "Landed Estates Court," power being conferred on it to deal with unencumbered as well as encumbered estates. Up to January 1880 the sales in this court amounted to £27,277,140, so that probably about one-sixth of the whole area has changed hands through the action of the two courts. The average price for the five years ending 1867 was 17½ years' purchase; in 1870, the year of the passing of the Land Act, it fell to 16½ years' purchase, but in 1873 it had risen to 20 years' purchase, and for the six years ending 1877 it was 19·4, while for 1878 it was 18·9,

and for 1879 only 17·7. The action of the Encumbered Estates Court was of a somewhat arbitrary kind, and in the beginning of its operations it forced the sale of estates at a time when their market value was much below the average. In addition to this it introduced a large number of proprietors who looked at their purchase entirely from a business point of view, and who, though quite alive to the importance of agricultural progress, had little regard for the feelings of their tenants; having bought the improvements which the tenant had effected, they naturally had no scruples in raising the rents so as to make them represent the value of these. It is not probable that the land sales have increased very much the number of proprietors; for, although they caused a subdivision of many large estates, a number of small estates have been consolidated, and in many cases more than one estate has been purchased by the same person. On the whole, however, the result has been to increase the estates of a medium size, and also probably to lessen the number of absentees. From a return presented to the House of Commons in 1872, it would appear that the number of proprietors resident on their estates in 1870 was 5589, possessing 8,880,549 acres, with an annual value of £4,718,497, while there were 4812 proprietors resident either usually or constantly elsewhere in Ireland, who possessed 5,215,264 acres, with an annual value of £2,499,343; 2973 rarely or not usually or never resident in Ireland, who possessed 5,129,169 acres, with an annual value of £2,470,816; and 5982 unclassified, who possessed each less than 100 acres, and together 236,872 acres, with an annual value of £257,100. 25·5 per cent. of the soil is thus owned by absentee proprietors, and 26 per cent. by proprietors who though resident in Ireland are not resident on their properties.

According to the classified summary return of owners of land in Ireland laid before the House of Commons in 1876, the land in 1873 was divided among 68,716 proprietors, who together possessed 20,157,557 acres, with a rateable annual value of £13,418,357, or, according to the corrected statement of 1878, 68,755 proprietors, possessing 20,162,050 acres, with a rateable value of £13,420,022. Table XXII. gives a classification of proprietors according to the area of their estates, and their numbers in the several provinces and in all Ireland, with the acreage possessed by each class collectively, and its rateable valuation,—the result of the corrected statement of 1878 being also added.

According to the returns presented to the House of Commons in 1872, which have the advantage of omitting cities and towns, the total number of rural proprietors in 1870 was only 19,547, possessing a total area of 20,046,182 acres, with a rateable value of £10,180,434. A return obtained

TABLE XXI.—Purchase Loans to Tenants up to March 31, 1880.

	No. of Loans	Amount of Purchase Money.			Amount Advanced.			Number of Acres.			Annual Rent.			Value of Tenement.		
		£	s.	d.	£	s.	d.	£	s.	d.	£	s.	d.	£	s.	d.
Leinster.....	125	223,095	16	5	129,487	10,122	3	19	9,645	7	5	8,551	0	2		
Munster.....	149	292,064	8	5	113,604	14,769	0	3	9,261	6	5	9,640	9	6		
Connaught.....	27	47,327	0	2	30,173	3,652	0	6	2,369	5	9	1,791	16	5		
Ulster.....	528	350,635	1	9	219,106	23,151	3	2	13,913	11	10	13,708	4	8		
Ireland.....	810	823,122	6	9	492,370	50,695	2	30	35,189	11	5	30,971	11	0		

TABLE XXII.—Classification of Landowners, with Extent and Valuation of their Estates.

Classes of Owners.	Province of Leinster.			Province of Munster.			Province of Ulster.			Province of Connaught.			Total of Ireland.		
	No. of Owners	Extent.	Valuation.	No. of Owners	Extent.	Valuation.	No. of Owners	Extent.	Valuation.	No. of Owners	Extent.	Valuation.	No. of Owners	Extent.	Valuation.
Of less than 1 acre.....	15,684	3,119	607,816	8,101	2,511	266,212	16,056	8,010	468,616	2,323	425	29,904	36,144	9,065	1,366,448
Of 1 acre and under 10	2,604	10,362	213,661	1,250	4,697	46,763	2,706	12,504	220,671	332	1,405	17,821	6,892	28,963	498,916
10 "	50	1,591	47,248	200,785	1,118	29,357	18,278	4,426	110,362	207,251	309	7,958	13,868	7,746	195,525
50 "	100	982	71,356	116,810	819	59,907	61,467	1,487	104,563	123,960	191	14,321	11,137	3,479	250,147
100 "	500	2,665	666,844	740,571	2,394	601,603	453,007	2,003	447,955	453,520	927	239,135	125,473	7,989	1,965,537
500 "	1,000	876	615,530	517,030	901	638,950	494,288	520	361,568	281,275	419	299,480	129,502	2,716	1,915,528
1,000 "	2,000	559	777,594	540,887	578	807,874	432,282	327	454,218	294,521	339	475,057	184,994	1,803	2,514,743
2,000 "	5,000	316	973,403	663,937	373	1,132,575	598,715	253	783,715	484,517	254	785,073	252,883	1,198	3,675,269
5,000 "	10,000	89	623,927	403,851	131	911,161	405,062	129	894,931	565,805	103	724,609	208,766	452	3,154,528
10,000 "	20,000	36	484,816	278,402	51	688,433	273,138	56	742,185	390,200	42	563,559	171,878	185	2,478,493
20,000 "	50,000	14	379,288	184,351	23	670,728	253,283	33	931,629	428,127	20	577,205	205,845	90	2,558,850
50,000 "	100,000	2	157,118	93,016	4	349,194	166,433	5	292,056	191,582	3	255,209	46,797	14	1,023,677
100,000 and upwards.....	...	...	...	...	...	...	...	1	122,300	15,187	2	274,780	22,478	3	397,060
No valuation.....	4	42	...	1	5	...	...	...	...	...	...	...	...	5	47
Total.....	25,724	4,810,147	4,560,277	15,746	5,896,998	3,311,272	21,962	5,261,596	4,125,472	5,264	4,186,816	1,421,336	68,716	20,157,557	13,418,357
Corrected statement, 1878...	25,727	4,812,412	4,560,342	15,780	5,898,370	3,311,085	21,982	5,260,269	4,125,946	5,266	4,190,999	1,422,650	68,755	20,162,050	13,420,022



by the Irish Government in 1870, and ordered by the House of Commons to be printed in 1876, gives the number of rural proprietors as 19,288. It also shows that only 2377 possessed less than 25 acres, so that nearly all the proprietors of less than 1 acre must be in towns. The classified returns of 1876 show that nearly one half of the whole acreage of the country is possessed by 749 proprietors holding each upwards of 5000 acres, and that more than four-fifths of the land is possessed by 3750 proprietors holding upwards of 1000 acres. Compared with Great Britain, the number of proprietors is strikingly small, Scotland having twice as many, and England nearly fourteen times as many. The proportion of landowners possessing less than 1 acre is very much smaller, and that of those possessing less than 500 acres is also smaller. Further details of comparison with England and Scotland will be found in the article ENGLAND, vol. viii. p. 223-225.

*Woolen Manufacture.*—Though Ireland is without the stimulus to industry produced by an abundant supply of coal, yet with its great command of water power it might have widely developed its manufactures before the introduction of steam, had not special causes been in operation to check their progress. The unsatisfactory political and social relations of the country, and the unhappy legislation which had blighted its agriculture, would necessarily in any case have indirectly stunted its manufactures also; but, in addition to this, they were specially discouraged by various restrictive and repressive Acts. For a considerable period after the Anglo-Norman invasion Ireland was, however, in this respect placed on an entire equality with England, and in Acts passed in the reigns of Edward I., Edward III., and Edward IV. is specially exempted from the duties or prohibitions imposed on foreign manufactures.

At an early period the woollen manufactures of Ireland were exported in considerable quantities to foreign countries. In a posthumous poem, *Dita Mundi* (two copies of which are in the British Museum, of dates 1474 and 1501), by Bonifazio Uberti, who died about 1367, mention is made of "the noble serge" which Ireland sent to Italy; and Irish frieze is specially excepted by name in an English statute of 1376. Five mantles made of Irish frieze are mentioned in a list of goods exported duty free from England to Pope Urban VI. Considerable impulse was given to the manufacture in the reign of James I. by the establishment of a colony from the Palatinate, in Germany, at Carrick-on-Suir, but in the reign of Charles I. the clothing trade was discouraged by the earl of Strafford, lord-deputy, who, to prevent it interfering with that of England endeavoured to foster the linen manufacture instead. The Act of the 12th of Charles II., which prohibited the export of raw wool both from Ireland and England to foreign countries, was in the case of Ireland not only harmless but ineffectual; but, in addition to this, Ireland was virtually debarred from the English market by the heavy duties imposed on her woollen manufactures, and, being left out in the Navigation Act of 1663, she was also debarred from the colonial market. The foreign market was, however, left open to her; and after the prohibition of the export of Irish cattle to England the Irish farmer was led to turn his attention to the breeding of sheep, when not only did the woollen manufacture increase with great rapidity, but, owing to the superiority of the wool, the materials manufactured were of such a quality as to awaken the alarm of the English manufacturer, at whose instance both Houses of Parliament petitioned William III. to come to the rescue. In accordance with his wishes, the Irish parliament in 1698 imposed additional heavy duties on all woollen clothing with the exception of friezes exported out of Ireland, and in the following year an Act was passed by the British Government prohibiting the export from Ireland of all woollen goods to

any country save England, to any port in England save six, and from any town in Ireland save six. Sir William Petty in 1641 estimated the number of woollen workers and their wives at 30,000, but the result of these Acts was so disastrous as practically to annihilate the manufacture, to reduce large districts and towns to the last verge of poverty, and seriously to cripple the revenues of the kingdom. Notwithstanding, however, that Ireland ceased to make even for her home supply any but the coarser articles, and was forced to import her finer goods from England, the Acts were almost as injurious to the English as to the Irish manufacturer; for not only did many of the skilled Irish workmen settle in France, Spain, and the Netherlands, but by means of smuggled Irish wool, to the extent of four-fifths of the Irish fleeces annually, the foreign manufacturer was able at a much smaller cost to fabricate materials quite equal to those of England, and for a time almost to swallow up her Turkey wool trade. According to the tables given by Newenham, the annual average of new drapery exported from Ireland for three years ending 25th March 1702 was only twenty pieces, and that of old drapery 4 yards, while the export of woollen yarn, worsted yarn, and wool, which to England was free, amounted to 349,410 stones. The annual average export for the three years ending 1722 had risen to 5494 yards for new drapery and 364 yards for old drapery, while that of yarn, worsted, and wool, owing doubtless to smuggling, had fallen to 188,450 stones, and for the three years ending in March 1732 fell as low as 96,953 stones, but for the three years ending in 1772 had risen to 129,191 stones, of which wool amounted only to 2247 stones. The returns as to the exports of new and old draperies from 1722 to 1777 are incomplete. Arthur Dobbs, in his *Essay on the Trade of Ireland*, published in 1729, estimated the medium exports of wool, worsted, and woollen yarn at 227,049 stones, which he valued at £117,554, 15s. 10d.,—the other exports of manufactures made from sheep, such as friezes, flannel, gloves, &c., being estimated at £2353, 5s. On the other hand, the annual average of new drapery imported for three years ending in 1702 was 29,329 yards, and of old drapery 15,787 yards; and the averages gradually rose till they were 84,631 yards and 18,726 respectively for the three years ending in 1722; 379,766 and 206,875 for the three years ending in 1772; and, according to Arthur Young, 485,609 and 259,466 for the seven years ending in 1777. Between 1779 and 1782 the various Acts which had hampered the woollen trade of Ireland were repealed or greatly modified; but, although a temporary impulse was thus given to the manufacture, the imprudent manner in which it was prosecuted and the influence of the remaining statutes led in the majority of cases to disappointment, and after a short period of deceptive prosperity, followed by failure and distress, the expansion of the trade was limited to the supply of the home market. Thus, while the annual average of new drapery exported for the three years ending in 1792 had risen to 352,309 yards and of old drapery to 10,688 yards, the averages fell for the three years ending in January 1802 to 18,028 and 2007 respectively; while the average imports of new drapery for three years rose from 379,989 in 1782 to 1,077,471 in 1802, and of old drapery from 251,251 to 1,474,000. In 1823 the imports of new draperies into Ireland had risen since 1801 from 967,225 yards, valued at £120,903 in Irish currency, to 1,437,652 yards, valued at £179,706; while the import of old draperies had risen from 911,082 yards, valued in Irish currency at £637,757. to 1,188,366 yards, valued at £831,856. Since 1825, owing to the cessation of duties, returns of the exports and imports of Ireland to and from Great Britain have ceased to be issued. According to the evidence laid before the House of Commons





statistics supplied by Arthur Young and M. Moreau, shows the increase of the linen manufacture so far as this can be judged from a comparison of the exports of linen cloth and yarn to all parts of the world at various periods from 1710 to 1823. Arthur Dobbs estimated that in 1727 the value of the whole linen manufacture, including both that exported and that used for home consumption, was about £1,000,000 sterling.

The Linen Board ceased to act in 1830, the trade having since 1825 been in a very depressed condition owing to the importation of English and Scotch yarns made by machinery, which undersold the home-made article. A flax-spinning factory had indeed been erected at Cork in 1805, but appears to have been unsuccessful, and no further attempt to introduce machinery seems to have been made until after the discontinuance of the Linen Board, when an experiment on a large scale was made on the Bann near Belfast, from which period may be dated the rise of the great linen trade of Ulster, where, with the gradual disappearance of the hand spinning in the other provinces, nearly the whole linen manufacture of Ireland became concentrated. Statistics as to the acreage and produce of flax will be found under "Agriculture," *supra*. It is in the province of Ulster that flax is chiefly grown, but the soil has in many instances been much deteriorated by a too frequent rotation of the crop. The flax of Irish production in 1880 was estimated at 24,508 tons, of British production at 1398, while the foreign imports of flax into the United Kingdom amounted to 94,812 tons. The cessation of the duties on exports from Ireland to Great Britain deprives us of the means of tracing the progress of the modern development of the linen industry. It was calculated that in 1855 the total exports of linen from Ireland to Great Britain and foreign countries was 106,000,000 yards, valued at £4,400,000, and undoubtedly since that period it has more than doubled. According to the report of the Flax Supply Association of Belfast for 1876, it was estimated that in 1875 the consumption of fibre in all the mills of Ireland was about 45,897 tons, or about one-seventh of that consumed by all the flax mills in existence. It was also estimated that the total quantity of yarns produced per annum was 21,373,700 bundles, of which 10,479,040 were supposed to be manufactured into cloth by power-looms, and 5,850,000 by hand-looms, in addition to which about 2,000,000 bundles were supposed to be imported from Great Britain and the Continent, leaving for export 7,044,660 bundles,—fully two-thirds of the production and imports into Ireland of yarn being converted into linen fabrics in Ireland. According to the report made to parliament in 1837, the number of workers employed in the flax factories of Ireland was 7810, and according to the returns relating to factories for 1839 the number of mills engaged in the manufacture was 40, employing 32 steam engines with a horse-power of 928, and 37 water-wheels with a horse-power of 1052, the total number of persons employed being 9017. Table XXV. gives returns at various periods from 1850. In the report of the Flax Supply Association for 1881 the number of spindles is estimated in 1881 at 927,295 and of power-looms at 21,177.

In 1880 there were 1182 scutching mills, a decrease of 317 as compared with 1871. The number of persons employed in the jute and hemp factories is over 1000.

*Cotton Manufacture.*—The cotton manufacture was

introduced into Ireland in 1777, and a mill for spinning twist with water-power was erected in 1784. Under the protection of high import duties and bounties the manufacture increased with such rapidity that in 1800 it gave employment to 13,500 workers, chiefly in the neighbourhood of Belfast. At the Union it was arranged that the duties, which then stood at 68 per cent. *ad valorem*, should remain unchanged for eight years, when they were gradually lowered by eight annual reductions, until in 1816 they stood at 8 per cent., and were shortly afterwards abolished. According to the statistics given by M. César Moreau, the manufacture between 1804 and 1820 had more than doubled, the cotton, cotton yarn, and twist imported into Ireland for the three years ending in 1804 amounting to 2,244,582 lb, whereas for the three years ending in 1820 it was 4,787,071 lb. The value of cotton goods exported from Ireland to Great Britain rose from £708 in 1814 to £347,606 in 1823, and between 1814 and 1826 the value of those exported to other parts of the world rose from £37,569 to £201,196. According to a statement made to the House of Commons in 1817, the number of hands employed in the manufacture was 12,091; and in 1822 they had increased to 17,756. It is evident that the introduction of machinery had prejudicial effects on this industry as well as on the linen trade, for, according to the returns relating to factories for 1839, the number of cotton mills is given as 24, employing 19 steam engines with a horse-power of 517, and 22 water-wheels with a horse-power of 572, the number of persons engaged being only 4622. The manufacture of course suffered greatly during the famine of 1846, and in 1850 the number of factories was only 11, employing 2937 persons. In 1861 the number had declined to 9, employing 2734 persons, and, although in 1870 it had risen to 14, employing 4157 persons, the check experienced during the American war has never been surmounted, the number of factories in 1874 being only 8, employing 3075 persons, and in 1879 declining to 6, employing 1620 persons.

For some time a large manufacture of lace and sewed muslin has been carried on in Ulster and some parts of Munster and Connaught—the sewed muslin trade being much the more extensive of the two. More than 300,000 persons, chiefly females, are employed in it, many of them being girls in the convent schools. Of late the trade has, however, been declining.

*Silk Manufacture.*—This was introduced into Ireland about the end of the 17th century by French Huguenots, who after the revocation of the edict of Nantes settled in Dublin, where great perfection was attained in the fabrication of a mixture of silk and wool called tabinet or Irish poplin. According to Lord Sheffield, who wrote in 1785, 1500 persons were employed in the manufacture. M. Moreau gives the quantity of raw silk imported into Ireland in 1803 as 27,384 lb, and that of thrown silk as 59,441 lb, while in 1823 the quantities were 27,869 and 21,195 respectively. He also inferred that in 1823 between 3000 and 4000 persons were employed in the manufacture. In 1825 a company was formed in the south of Ireland for the purpose of obtaining a supply of the raw material by rearing the silk-worm, but after considerable expense had been incurred the scheme was abandoned as impracticable. With the abolition of the protective duties in 1826 the manufacture gradually declined. In 1874 the

TABLE XXV.—Linen Factories in Ireland, 1850-79.

Factories.				Spindles.				Power Looms.				Persons Employed.			
1850.	1861.	1870.	1879.	1850.	1861.	1870.	1879.	1850.	1861.	1870.	1879.	1850.	1861.	1870.	1879.
69	100	154	144	396,338	592,981	916,660	826,743	68	4,666	14,834	19,611	21,121	33,525	55,039	56,342

number of factories was only 2, employing 400 persons, and in 1879 it was represented by 1 factory, which employed 152 persons.

*Miscellaneous Manufactures.*—There is 1 hosiery factory employing 119 persons, and 2 hair factories employing 38 persons. There is a considerable paper manufacture, which since the repeal of the paper duties in 1860 has been increasing. For most other articles in common use, such as glass, hardware, soap, candles, and many clothing materials, Ireland is nearly altogether dependent on England.

*Distillation.*—For several centuries Ireland has rivalled Scotland in the manufacture of whisky, the spirit of each country having its own special excellences. Camden states that in Ireland usquebagh was much used to stop the fluxes and catarrhs caused by the excessive moisture of the climate, and that the Irish spirit was much “less heating and more drying” than that of England. An excise duty was first imposed on the manufacture in 1661, the rate charged being 4d. per gallon. This was raised in 1715 to 7d., and in 1717 to 8d. In 1719, when a new method of reckoning by the size and number of stills was introduced, the revenue realized was £5785, 9s. 4d. In 1791 the amount produced by a rate of 1s. 2d. was £204,648. Various alterations were subsequently made in the methods of reckoning, and a system of survey was also combined with the old method, but the few capitalists who judged it advantageous to engage in the trade succeeded in baffling all the efforts of the Government to stop the issue of spirits which had not paid duty. The amount of spirits produced by distillation avowedly illicit vastly exceeded that produced by the licensed distilleries. According to Wakefield, stills were erected even in the kitchens of baronets and in the stables of clergymen. More commonly they were placed in retired districts on loose stones, so as to be easily removable on the approach of the revenue officers. In 1685 the number of stills seized was 2974, of heads 2656, and of worms 2378. The duty was gradually raised till it stood at 4s., and, after being reduced in 1811 to 2s. 6d., it was raised in 1814 to 5s. 6d. This addition to the duties added very little to the revenue, while of course it greatly increased the temptations to illicit manufacture. According to M. Moreau, it was the opinion of competent judges that in 1822 the amount produced by the licensed and unlicensed stills was not less than 10,000,000 gallons, while the amount brought to charge in the same year was only 2,950,647. For the six years ending 1818 the number of stills seized was 7233, of heads 5291, and of worms 5109, and for the six years ending 1826 the numbers were 13,017, 9475, and 8014 respectively, the number of prosecutions being nearly 18,000. Since that period illicit distillation has been largely practised up till the present time, the number of cases in 1880 being 685. Table XXVI. gives the amount of Irish spirits brought to charge in various years from 1821.

*Breweries.*—There are breweries in most of the large towns of Ireland, and Dublin is celebrated for its porter. In 1880 the number of common breweries was 53, and of licensed victuallers 16,686, the malt consumed by the former being 3,965,887 and by the latter 1864 bushels.

*Fisheries.*—An account of the fisheries of Ireland will be found under the headings FISHERIES, vol. ix. p. 262 sq., and SALMON FISHERIES. The salmon fisheries employ

between 11,000 and 12,000 persons. The deep sea and coast fisheries now employ only about 6000 boats and 20,000 persons, whereas the numbers in 1860 were 13,483 and 55,630 respectively. A reproductive loan fund for fishery purposes was constituted by the 12th section of the Act 37 & 38 Vict. c. 86, and the loans advanced up to 31st December 1880 amounted to £31,079, of which £20,675 has been repaid. The average annual produce of the oyster fisheries is about £50,000.

*Commerce and Shipping.*—So far as natural advantages for commerce and shipping are concerned, Ireland is scarcely rivalled by any other country. Her coast is not only surrounded by safe anchorages, but the land is so deeply indented by bays and inlets, and so intersected by a network of internal navigation, that no part is more than 24 miles from water communication with the sea. In regard also to situation, it is difficult if not impossible to fix on a country whose circumstances are more favourable. Lying contiguous to the coast of Great Britain, and at some points almost touching it, she is nearer than that country to the West Indies, the continent of America, the west coasts of France, the coasts of Spain and Portugal, and the ports of the Mediterranean. There is abundant evidence to show that Ireland was prepared to make use of these advantages, and that only impolitic trade restrictions have prevented her from developing a commerce which would undoubtedly have vied with that of Great Britain, but from which Great Britain would have gained more than she was in dread of losing. These restrictions, however, imposed when the great manufacturing industries of modern times were in their early infancy, not only snatched from her the possibility of commercial greatness, but, operating along with other legislation, doomed her to agricultural stagnation and centuries of poverty and distress; so that in fact contiguity to Great Britain has proved to be to her a bane rather than a blessing, and America instead of affording her the means of enrichment, has only supplied her with an asylum for her poverty-stricken sons.

From allusions in Strabo, Ptolemy, the northern sagas, Richard of Cirencester, and other old writings, it would appear that Ireland early in the present era had considerable commercial intercourse with various parts of Europe. At the time of the Anglo-Norman invasion, the merchants of Dublin having fled from the city, it was given by Henry II. to merchants from Bristol, to whom free trade with other portions of the kingdom was granted, as well as other commercial advantages. During the reigns of the Edwards, Irish ships were frequently employed in supplying the English armies with provisions, and in the Staple Act of Edward III. Dublin, Waterford, Cork, and Drogheda are mentioned as among the towns where staple goods could be purchased by foreign merchants. The trade of these and other towns had increased in the 15th century with considerable rapidity, and Sir John Davies, writing in 1612, speaks in commendation of the encouragement then given by the Government to the commerce of the maritime towns and cities. The first restriction on the trade of Ireland was an Act passed in 1637 imposing duties on the chief commodities to foreign nations not in league with England. Though included in the Navigation Act of 1660, she was, however, left out in that of 1663, and in the same year was prohibited from exporting her cattle to England in any month previous to July. Gerard

TABLE XXVI.—*Irish Spirits charged with Excise Duty, 1821–80.*

	1821.	1830.	1840.	1850.	1860.	1875.	1880
Gallons, imperial measure .....	3,311,462	9,004,539	10,815,709	6,973,333	6,538,448	6,094,628	6,927,871
Net amount of revenue.....	912,288	1,409,128	1,261,833	929,778	2,615,379	3,047,019	3,326,732



Boate, writing in 1652, gives a description of the various havens of Ireland. Sir William Petty estimated that between 1657 and 1672 her foreign trade had doubled, and that before the statute of 1663 "three-fourths of the Ireland foreign trade was with England, but now not one-fourth part of the same." The value of exports he computes at £500,000 per annum. About the time he was writing, the inhibition against exports to Great Britain was extended to include both dead meat and also butter and cheese. A trade was, however, carried on at this time with France, Spain, and Italy, not only in cattle and agricultural produce, but in salmon and herrings as well as various kinds of manufacture; but Arthur Dobbs was of opinion that from the Restoration until 1688 the exports of Ireland never exceeded £600,000 per annum. In 1681 the exports amounted to £582,814, and the imports to £433,040. On account of previous wars the exports in 1695 amounted to only £295,592, the imports exceeding them by £95,932; but owing chiefly to the prosperity of the woollen trade they had risen in 1698 to £996,305, the imports amounting to £576,863. Upon the prohibition of the exports of woollen manufactures to foreign countries, a rapid fall took place in the exports, which, although the value of those to Great Britain remained much the same, did not reach to the amount of 1698 until 1714, the recovery being due in part to the gradual increase of the linen manufacture, the value of whose exports rose between 1700 and 1714 from £14,112 to £313,329. Table XXVII., compiled from statistics given by Newenham, Arthur Young, and M. César Moreau, gives the annual value for 1698, and the average annual value for various periods from 1701 to 1823 of Irish exports and imports from and to all parts of the world, and from and to Great Britain.

A better idea of the commercial progress of the country would have been obtained if space had been available for tables of the different articles of export and import, for, besides giving more detailed information, it would have afforded a more accurate basis for an estimate, since Table XXVII. is so far vitiated by being given in Irish currency, which was altered at various periods, and by the fact that the method of rating at the custom

TABLE XXVII.—Average Annual Value (in Irish Currency) of Exports and Imports, 1698-1823.

	Average Annual Exports.		Average Annual Imports.	
	All parts of the World.	Great Britain.	All parts of the World.	Great Britain.
	£	£	£	£
1698	996,305	293,813	576,863	33,968
1701-1710	553,023	242,811	513,657	242,811
1711-1720	1,126,670	348,352	852,905	361,921
1721-1730	1,019,809	489,546	856,936	329,078
1731-1740	1,190,253	667,505	885,044	378,588
1741-1750	1,485,110	872,259	1,123,373	611,999
1751-1760	2,002,354	1,068,983	1,594,164	734,548
1761-1770	2,365,080	1,818,594	1,877,468	1,032,431
1771-1773	3,020,062	1,955,469	2,136,173	1,291,616
1774-1783	3,035,500	2,380,899	2,702,978	1,984,811
1784-1793	4,373,094	3,358,962	3,723,295	2,508,250
1794-1803	4,310,610	3,667,474	4,572,443	3,404,798
1804-1813	5,380,876	4,689,922	6,618,613	4,646,873
1814-1823	6,963,451	5,675,673	6,626,409	4,921,879

house was also varied. On the latter account it was reported to the House of Commons in 1811 that the augmentation of trade during the 18th century appeared from such valuations to be greater than it really was. The increase has, however, been considerable, for we find that between 1710 and 1777 the quantity of linen exported had risen from 1,688,574 to 19,714,638 yards, while the export of oats, wheat, and barley had been nearly quadrupled, and there was also a large increase in the exports of live cattle, and of beef, butter, and pork. The table shows a large increase, especially in the value of exports, after the peace in 1748, and, while there is a diminution shortly before the passing of the Acts granting free trade, there is a rapid revival after that period; and there are also very evident signs of the prosperity Ireland was experiencing during the wars with France. Since the cessation of the shipping duties on the cross channel trade in 1825, there are no data for obtaining accurate details regarding the trade with Great Britain; and, in addition to this, the Board of Trade has ceased since 1870 to give returns of the foreign and colonial trade for each of the separate kingdoms of England, Scotland, and Ireland. Returns are given, however, for the principal ports of each kingdom. Table XXVIII. gives the value of the foreign and colonial trade of Ireland at various periods down to 1870, and of its principal ports for 1875 and 1879.

Another means of estimating the commercial progress of Ireland during this period is supplied by the returns of shipping. Prior in his *Observations on the Trade of Ireland* gives an estimate of the tonnage of the shipping engaged in the trade of Ireland from 1721 to 1727, according to which the number of ships in the former year was 3499 with a burthen of 158,122 tons, while Arthur Dobbs gives their number for the same year as 3334 with a tonnage of 158,414, and their number in 1714 as 3081 with a tonnage of 161,115. The tonnage of the ships belonging to the ports of Ireland in 1727 is given by Prior as 40,469, the total number of ships trading with Ireland being 3494, with a tonnage of 173,193. According to the statistics of M. Moreau the number of Irish ships in 1788 was 1016, the tonnage being 60,776, or a third more than in 1727; and in 1826 they had increased to 1391, with a tonnage of 90,768. Table XXIX. gives the number and tonnage of vessels registered in the ports of Ireland in 1840, 1850, 1860, 1870, and 1880.

According to the statistics of M. Moreau, the number of ships that entered the ports of Ireland in 1795 was 7086, with a tonnage of 630,506, and in 1801 they had increased to 7690, with a tonnage of 711,242. Returns of the trade and navigation of Ireland have since the Union been annually presented to parliament. Table XXX. gives the number of British and Irish and foreign vessels engaged in the foreign and colonial trade that entered and cleared at the ports of Ireland at various periods from 1802; Table XXXI. the number of ships that entered and cleared coastways in various years during the same period; and Table XXXII. the number of ships engaged in intercourse between Great Britain and Ireland that entered and cleared British and Irish ports at various periods from 1835, the figures in this table of course representing about double the number of ships actually engaged in the trade.

TABLE XXVIII.—Foreign and Colonial Trade of Ireland, 1828-79.

Annual average for 1828-50.		1840.		1850.		1860.		1870.		1875.		1879.	
Imports.	Exports.	Imports.	Exports.	Imports.	Exports.	Imports.	Exports.	Imports.	Exports.	Imports.	Exports.	Imports.	Exports.
£	£	£	£	£	£	£	£	£	£	£	£	£	£
1,573,545	839,014	1,659,934	472,537	6,031,569	268,611	7,122,237	284,362	8,725,211	238,452	11,823,511	320,095	10,994,359	830,878

Details as to the several articles of foreign trade will be found in the Board of Trade returns of the principal ports; but without information as to the trade with Great Britain it is impossible to estimate their significance. The returns of the foreign trade are unsatisfactory, inasmuch as they show a great excess of imports over exports. The principal export trade to foreign countries is in linen, spirits, and malt liquors; while the imports embrace large quantities of wheat, wheaten flour, Indian corn, and oatmeal. On the other hand the country is dependent chiefly on Great Britain and foreign countries for its manufactured goods. Much of its trade is, however, an indication rather of poverty than prosperity, for it is the absence of manufactures that causes such large imports of textile fabrics, and the large exports of cattle, dead meat, and butter, which would otherwise be consumed by her town population, while at the same time the large imports of corn and wheat into a country chiefly rural are undoubtedly due to wrong or insufficiently advanced methods of agriculture.

**Shipbuilding.**—About nine-tenths of the total shipping of Irish construction is built in Belfast, and the whole amount is very small. Next to Belfast come Dundalk, Dublin, Cork, Drogheda, and Galway,—much in the order named. The number of vessels built in Ireland in 1850 was 25 of 1929 tons burthen; in 1860, 42 of 11,582 tons; in 1875, 16 sailing vessels of 18,655 tons, and 5 steam vessels of 3613 tons. In 1880 they numbered respectively 3 of 1873 tons, and 10 with 7131 tons burthen.

**Revenue and Expenditure.**—Until the time of Henry VIII. the English rule in Ireland was only nominal, except within a very small district; and, while statistics as to the revenue would thus

be of little advantage for comparison with later times, they are not obtainable except in a very fragmentary manner. Henry VIII. levied a subsidy of 13s. 4d. on every ploughland; and, besides reviving the tax upon absentees first enacted by Richard II., he also obtained a considerable sum from the suppression of several of the monasteries. During the first fifteen years of the reign of Elizabeth the expenses of Ireland, on account chiefly of the wars, amounted, according to Sir James Ware, to £490,779, 1s. 6d., while the revenue is estimated by some writers at £8000 per annum and by others at only £6000. In the reign of James I. the customs gradually increased from £50 to £9700; but, although he obtained from wardships and other feudal rights about £10,000 per annum, and a considerable sum also accrued from the plantation of Ulster, the revenue is supposed to have fallen short of the expenditure by about £16,000 per annum, the cost of maintaining the troops in Ireland amounting alone to about £50,000. During the reign of Charles I. the proceeds of the customs were nearly quadrupled, but it was found necessary to raise £120,000 by yearly subsidies of £40,000. According to the report of the committee appointed by Cromwell to inquire into the financial condition of Ireland, the revenue in 1654 was £197,304 and the expenditure £630,814, 9s. 8d. At the Restoration the Irish parliament granted an hereditary revenue to the king, an excise for the maintenance of the army, a subsidy of tonnage and poundage for the navy, and a tax on hearths in lieu of feudal burdens. "Additional duties" were granted shortly after the Revolution. "Appropriate duties" were imposed at different periods; stamp duties were first granted in 1773, and the post-office first became a source of revenue in 1783. In 1706 the hereditary revenue with additional duties produced £394,324, 11s. 3d., and for the two years ending in 1729 the amount was £889,351, 4s. 11½d. Returns of the ordinary revenue were first presented to the Irish parliament in 1730. Table XXXIII., compiled from the statistics of M. Moreau, gives the annual average amount in Irish currency of net and gross produce of the revenue during every ten years up to 1789, the amount for 1790, and the annual average for the ten years 1792-1801. Table XXXIV., compiled from special and other returns presented to the House of Commons, gives the net produce of the excise and customs at intervals from 1720, and of the other branches of ordinary revenue at intervals from the time when they were first imposed. A special return in *Accounts and Papers*, 1868-69, gives in British currency the annual net public income and expenditure of Ireland from the Revolution to the Union, and Table XXXV., compiled from this return, gives its amount at various intervals between these periods. Table XXXVI., compiled from certain special returns presented to the House of Commons at different periods, gives the net annual income and expenditure at certain intervals from the Union up to 1868.

Returns of the produce of the revenue were annually presented to parliament up to 1870, and, although they have been discontinued since that period, a special return from 1871 to 1875 was presented in 1876, and special returns were also presented in 1878 and 1879, the latter returns, however, not including the produce of the

TABLE XXI.—Vessels Registered in the Ports of Ireland, 1840-80.

	Sailing Vessels.				Steam Vessels.			
	Under 50 Tons.		50 Tons and upwards.		Under 50 Tons.		50 Tons and upwards.	
	No.	Ton.	No.	Ton.	No.	Ton.	No.	Ton.
1840	976	27,711	961	148,591	3	127	76	17,378
1850	1,037	29,570	1,098	204,183	12	396	102	27,281
1860	1,017	30,150	1,086	181,435	35	958	133	40,796
1870	706	21,633	945	148,967	55	1,389	138	45,192
1880	615	19,173	788	153,266	81	1,953	174	53,245

TABLE XXX.—Vessels in the Foreign and Colonial Trade Entering and Clearing at the Ports of Ireland, 1802-80.

	Entered.						Cleared.					
	British and Irish.		Foreign.		Total.		British and Irish.		Foreign.		Total.	
	Number.	Tonnage.	Number.	Tonnage.	Number.	Tonnage.	Number.	Tonnage.	Number.	Tonnage.	Number.	Tonnage.
1802	648	87,869	363	57,964	1,011	145,833	503	71,420	328	58,423	831	129,843
1816	565	70,106	318	67,538	883	137,644	522	74,255	321	69,703	843	143,958
1826	860	154,380	290	50,194	1,150	204,574	569	117,032	281	57,334	850	174,366
1841	851	176,977	197	26,441	1,078	203,418	604	146,859	153	20,953	757	167,812
1850	1,334	245,012	886	166,417	2,220	411,429	681	165,123	761	146,670	1,442	311,793
1860	1,039	289,603	1,233	277,240	2,322	566,843	349	139,625	255	70,152	604	209,777
1870	1,112	389,526	927	323,095	2,039	712,621	394	147,822	209	67,687	603	215,509
1880	958	572,647	779	388,173	1,737	960,820	547	313,190	539	271,862	1,086	585,052

TABLE XXXI.—Vessels Entering and Clearing Coastways.

	Entered.				Cleared.			
	Sailing Vessels.		Steam Vessels.		Sailing Vessels.		Steam Vessels.	
	No.	Tonnage.	No.	Tonnage.	No.	Tonnage.	No.	Tonnage.
1802	6,589	546,647	...	...	6,032	521,151	...	...
1817	10,142	845,260	...	...	9,200	773,783	...	...
1826	11,514	1,057,299	...	...	6,388	632,972	...	...
1840	16,634	1,211,842	10,203	637,891	2,427	571,654	2,969	655,928
1850	16,403	1,191,242	7,360	438,572	4,740	1,301,489	4,534	1,338,732
1860	19,214	1,488,635	7,036	1,983,165	7,476	454,482	7,039	1,998,738
1870	18,972	1,600,942	5,658	425,632	8,132	2,227,845	7,851	2,571,656
1880	15,835	1,411,132	15,408	4,768,322	14,611	1,199,311	15,416	4,850,858

TABLE XXXII.—Vessels engaged in Trade between Great Britain and Ireland.

	Entered.		Cleared.	
	No.	Tonnage.	No.	Tonnage.
1835	10,026	1,100,380	14,560	4,440,617
1846	9,133	1,411,130	19,124	2,211,496
1850	8,569	1,585,057	18,268	2,355,166
1860	34,693	5,578,436	34,387	5,512,116
1870	36,167	6,568,545	5,523	6,684,547
1880	54,742	11,145,116	52,803	1,588,074



income tax from the income of officials. According to these returns the net produce of the revenue was in 1870 £7,287,127, in 1871 (not including that of the post-office) £7,291,393, 15s. 4d., in 1875 £7,970,050, 13s. 7d., and in 1879 £6,616,455. The revenue of England in 1879 amounted to £54,456,718, and of Scotland to £7,713,500.

No separate post-office returns have been published since 1870. In 1860 the gross produce of the sale of crown lands amounted to £15,537, and the annual income of land revenue to £48,358; in 1870 they were respectively £1283 and £45,000, and in 1880 £3506 and £41,589. The items of the expenditure of the exchequer of Ireland for 1868 (the last year for which returns are given) are—interest of public funded debt payable in Ireland, £1,188,654; other payments in connexion with the consolidated fund services, £278,015; army, £3,560,000; miscellaneous civil services, £1,594,525. Since 1817 the public debt of Ireland on account of the consolidation of the British and Irish exchequer has ceased to form a separate item in the national account. Table XXXVII. shows its progress from 1716 till that period.

**Banking.**—A notice of the banks of Ireland will be found in the article BANKING, vol. iii. p. 336. The deposits in joint-stock banks amounted in 1840 to £5,567,851, in 1850 to £8,268,838, in 1860 to £15,609,237, in 1870 to £24,366,478, and in 1880 to £29,350,000. The deposits in trustees' savings banks in 1846 amounted to £2,855,827, but in 1850 had declined to £1,291,798; in 1860 the amount was £2,143,282, in 1870 £2,054,907, and in 1880 £2,100,165. The deposits in post-office savings banks in 1862, the year in which they were founded, were £78,696, in 1870 £583,165, and in 1880 £1,229,000. The amount of Government and India stock held in Ireland amounted in 1870 to £36,549,000, and in 1880 to £33,113,000.

**National Wealth.**—From a variety of circumstances it is difficult to arrive at an approximate estimate of the wealth of Ireland; and there is no proper basis for a comparison with the other portions of the United Kingdom—among other reasons from the fact that by far the largest part of the wealth of Ireland is derived from agriculture. The Tenement Valuation Act, passed in 1846 and amended in 1852,

according to which the property of Ireland is rated for purposes of local and imperial taxation, has the disadvantage of having been applied in different parts of the country at different periods, and in the southern and western counties at a time when the value of property on account of the famine had very much deteriorated. No provision except of an optional kind has been made for a revaluation of property other than buildings and similar external additions to the value of the soil. It is probable therefore that the present valuation, which is a little short of £14,000,000, is deficient by about £5,000,000. The case of Ireland is also exceptional from the large amount of wealth that immediately after it is produced is removed to be spent elsewhere, and of capital invested in Irish undertakings which is held by persons who do not reside in Ireland. The value of the agricultural produce and stock, the chief item of the wealth, is of course variable, and the rise in value is due solely to increase of price and to increase in the number of live stock, which of course represents the produce of more than one year. It is also a fallacious method of calculating its value to add that of produce and live stock together, as a great part of the produce is employed in feeding the live stock. In Ireland a considerable amount of money is probably hoarded privately, and the increase of deposits in banks can scarcely be regarded as altogether a symptom of prosperity, as the money thus deposited might in most cases be more advantageously employed by the farmer in improving his land. On the other hand, since the passing of the Land Act of 1870, indebtedness has largely increased among the farmers. A method of estimating the capital of Ireland has been employed by Dr Hancock from the amount of capital passing annually under probate of wills and letters of administration, calculating this capital as 2·66 per cent. of the whole. Table XXXVIII., formed according to this method, shows the annual average amount of capital from 1826 at various periods of five years, and the amount of capital possessed by each head of the population, this being reckoned according to the year most nearly corresponding with those for which the average is given.

**Railways.**—The railway from Dublin to Kingston, which was opened in the end of 1834, was the first and for several years the only railway in Ireland. The progress of the railway system from that period is shown in Table XXXIX. For a comparison with England and Scotland see ENGLAND, vol. viii. p. 237; it will be observed that the proportion of traffic in relation to population is very much smaller in Ireland.

**Vital Statistics.**—In the *Transactions of the Royal Irish Academy* for 1865, part iii., will be found an account by W. H. Hardinge of a copy which he accidentally discovered of a manuscript census survey of Ireland arranged in counties, baronies, parishes, and townlands, and in cities, parishes, and streets, and belonging in

TABLE XXXIII.—Average Annual Produce of Revenue, 1730-1801.

	Gross Produce.	Net Produce.		Gross Produce.	Net Produce.
	£	£		£	£
1730-39	551,751	472,303	1770-79	971,041	749,507
1740-49	569,920	497,389	1780-89	1,335,097	950,511
1750-59	729,482	632,757	1790	1,693,398	1,147,967
1760-69	892,071	747,194	1792-1801	2,161,939	1,901,901

TABLE XXXIV.—Revenue from Excise, Customs, &c., 1720-1880.

	1720.	1760.	1790.	1820.	1810.	1820.	1827.	1830.	1840.	1850.	1860.	1870.	1880.
	£	£	£	£	£	£	£	£	£	£	£	£	£
Excise	440,336	646,024	1,238,721	2,422,746	1,650,104	1,907,335	1,754,215	1,956,445	1,385,238	1,494,747	2,700,970	3,597,519	4,068,335
Customs	...	...	54,812	165,121	1,788,380	1,730,837	1,976,498	1,555,600	2,132,731	2,064,908	2,268,962	2,049,374	...
Stamps	...	...	...	634,706	449,846	470,757	478,638	453,209	...	...	...	...	618,067
Post-office	...	...	44,156	76,260	178,965	168,105	197,907	229,094	97,156	170,061	261,550	351,116	...
Income-tax	...	...	...	...	...	...	...	...	...	...	728,887	613,113	470,808

TABLE XXXV.—Annual Income and Expenditure, 1689-1800.

	Net Income.			Net Expenditure.		
	£	s.	d.	£	s.	d.
1689	159,809	17	11	190,715	11	3
1701	411,819	3	9	415,033	5	1
1711	298,194	16	11	300,182	19	0
1721	408,065	16	4	422,917	16	8
1731	405,178	1	7	407,758	18	1
1741	441,236	9	11	441,736	2	10
1751	600,236	12	1	620,738	10	3
1761	571,942	7	3	773,540	2	10
1771	707,996	3	6	808,546	7	5
1781	739,850	4	8	1,015,266	12	6
1791	1,313,476	12	3	1,384,087	13	2
1800	3,017,757	18	10	6,615,959	2	5

TABLE XXXVI.—Annual Income and Expenditure, 1801-68.

	Net Income.			Net Expenditure.		
	£	s.	d.	£	s.	d.
1801	2,643,736	0	0	4,922,524	0	0
1817	1,561,353	0	0	17,677,649	0	0
1831	3,614,401	3	8½	3,439,895	5	1½
1850	4,332,459	16	0	4,120,841	11	0
1860	7,851,612	12	11	6,331,223	12	7
1868	6,176,390	7	8	6,621,193	17	11

TABLE XXXVII.—Public Debt of Ireland, 1716-1817.

	1716.	1720.	1730.	1740.	1750.	1762.	1770.	1780.	1790.	1800.	1810.	1817.
	£	£	£	£	£	£	£	£	£	£	£	£
Debt	16,106	87,511	220,730	296,988	205,117	223,438	628,883	1,067,565	1,586,067	22,345,190	75,240,790	134,602,769

TABLE XXXVIII.—Estimated Capital of Ireland.

	Capital passing under Probates.	Estimated Capital.	Rate per Head.	According to Population in
	£	£	£	£
1626-30	8,448,443	129,641,000	17	1831
1836-40	3,755,758	141,194,000	17	1841
1846-50	2,534,611	95,286,000	15	1851
1856-60	4,220,395	158,661,000	26	1861
1871-75	6,815,866	256,336,000	49	1871
1876-79	7,390,612	277,843,000	54	1881

TABLE XXXIX.—Railway Statistics.

	Miles.	Passengers.	Receipts.	Miles.	Passengers.	Receipts.
		£	£			£
1836	6	1,237,800	55,421	1860	1364	9,901,118
1840	13½	1,338,761	36,500	1865	1838	13,186,055
1845	65	3,481,797	119,398	1870	1975	14,330,444
1850	515	5,495,796	514,035	1875	2148	16,894,338
1855	987	7,212,286	599,832	1880	2378	17,186,338

all probability to the year 1659. The population of Leinster is here given as 155,534, of Ulster as 103,923, of Munster as 153,282, of Connaught as 87,352, making a total for Ireland of 500,091. This is the only census return made by Government previous to 1821. Table XL gives the different parliamentary returns and also various estimates or returns for previous years, to some extent reliable, but either inferential or made in such a manner as to render a very near approach to accuracy impossible. The Government returns are also deficient in accuracy until 1841, but from the table a fairly correct idea may be formed of the growth of the population up to 1841, while it affords a very accurate representation of its decline from that period. Table XLI exhibits the population of each province for the years in which Government returns have been made; and Table XLII shows the number of each sex from 1841.

The great increase of population which began towards the close of last century, and continued during the first forty years of the present one, was due in various degrees to improvements in the political condition of the country, to the creation of leaseholds after the abolition of the forty shillings franchise, and to the prosperity caused by the productiveness of the potato and the high prices of produce during the war with France. The decrease from that period began at first with great rapidity owing to the pressure of famine, and has been continuous up to the present time, chiefly owing to the creation of large pasturage farms. Table XLIII gives the rate of increase or decrease per cent. in the various decades from 1821 to 1881. Table XLIV gives the proportion of population to the square mile for each county from 1841.

The figures for 1841 indicate a density of population which is unparalleled, considering that it is so largely rural. Table XLV gives the numbers of the rural and urban population, including the military, for 1841, 1851, 1861, and 1871. The collective population to the parliamentary boroughs was 804,705 in 1841, 873,430 in 1851, 788,866 in 1861, 856,783 in 1871, and 892,505 in 1881. The increase of the urban population between 1841 and 1851, while there was a large decrease in the population generally, was apparently owing to a temporary influx of the rural population into the towns, as in 1861 a large diminution had taken place, the increase of manufactures, however, causing the loss to be nearly recovered in 1871. Excluding the Dublin suburban townships of Rathmines (24,245) and Pembroke (23,184), there were only six

towns whose population in 1881 was over 20,000; Table XLVI gives their population in the census years from 1841 to 1881. The most noticeable features of the table are the rapid rise of Belfast owing to its prosperous linen trade; the steady progress of Londonderry, also situated in the thriving province of Ulster; the almost stagnant position of Dublin; and the decline of Cork and Limerick, both situated in Munster, the province in which both trade and agriculture are in the most backward condition. Table XLVII gives a classification of the population according to occupation.

The population of Ireland has at various periods been considerably diminished by outbreaks of pestilence and by famine, but its decrease is chiefly attributable to emigration. Since 1847 this has been annually so great as to cause a continuous diminution of the population. The census commissioners estimated the emigration between 1821 and 1831 at 70,000. The total number who emigrated between 1831 and 1841, according to information collected at the various ports, and corrected by comparison with other statistics, was 403,459 (with an addition of 10 per cent. on account of imperfect returns), the number who emigrated from Irish ports being 214,047, and from Liverpool 152,738. Information as to the destination of the emigrants for these years is available only in regard to those emigrating from Irish ports, the numbers who left for British America being 189,225, for the United States 19,775, for the Australian colonies 4553, and for other destinations 494. The census commissioners of 1851 obtained information from the different ports of the United Kingdom regarding the numbers and destination of Irish emigrants from 1841 to 1855. The

TABLE XL.—Population of Ireland, 1659-1881.

Year	Population	According to	Population	According to
1659	500,091	Census return.	1792	4,088,226
1672	1,320,000	Sir William Petty.	1805	3,395,456
1695	1,634,102	Captain South.	1814	3,937,856
1725	1,663,644	Arthur Dobbs.	1821	6,601,827
1731	2,010,321	Established clergy.	1831	7,767,401
1754	2,372,634	Tax collectors.	1841	8,196,597
1760	2,317,384	Do Burgo.	1851	6,574,278
1767	2,644,276	Tax collectors.	1861	5,798,964
1777	2,690,556	Do.	1871	5,412,377
1785	2,845,932	Do.	1881	5,159,839
1788	4,040,000	Geirvase P. Bushc.		
1791	4,206,812	Tax collectors.		

TABLE XLI.—Population of the Different Provinces, 1821-81.

	1821.	1831.	1841.	1851.	1861.	1871.	1881.
Leinster	1,757,492	1,909,713	1,982,169	1,882,320	1,457,635	1,379,451	1,274,196
Munster	1,235,612	1,227,152	1,404,460	1,865,600	1,513,558	1,393,485	1,233,910
Ulster	1,098,494	1,286,822	1,389,263	2,013,879	1,914,236	1,833,328	1,739,542
Connaught	1,110,229	1,343,914	1,420,705	1,012,479	913,135	816,213	817,197

TABLE XLII.—Distribution of the Sexes, 1851-81.

1851.		1861.		1871.		1881.	
Males.	Females.	Males.	Females.	Males.	Females.	Males.	Females.
3,212,525	3,361,753	2,896,967	2,961,697	2,643,741	2,788,696	2,622,804	2,637,035

TABLE XLIII.—Increase and Decrease per cent. of Population.

	1821-31.	1831-41.	1841-51.	1851-61.	1861-71.	1871-81.
Leinster	Increase. 8.66	Increase. 8.35	Decrease. 15.25	Decrease. 12.85	Decrease. 8.31	Decrease. 4.49
Munster	15.06	7.59	22.47	18.59	7.93	4.36
Ulster	14.42	4.36	15.69	4.65	4.23	5.11
Connaught	21.05	5.58	28.81	9.59	7.33	3.43
Ireland	14.19	5.25	19.85	11.50	6.67	4.69

TABLE XLIV.—Persons per Square Mile.

	1841.	1851.	1861.	1871.	1881.
<b>Leinster—</b>					
Carlow	249	197	165	147	135
Dublin	1654	1145	1159	1147	1185
Kildare	175	146	139	128	117
Kilkenny	254	199	156	136	123
King's	190	145	117	96	92
Longford	274	196	170	154	144
Louth	393	328	274	266	248
Meath	298	169	126	106	96
Queen's	233	168	137	121	109
West Meath	199	157	128	110	101
Wexford	224	260	169	147	137
Wicklow	161	127	111	101	94
<b>Total</b>	<b>259</b>	<b>220</b>	<b>191</b>	<b>175</b>	<b>163</b>
<b>Munster—</b>					
Clare	221	164	129	113	109
Cork	296	235	189	179	170
Kerry	159	129	109	106	108
Limerick	310	216	204	189	166
Tipperary	263	200	150	131	114
Waterford	272	227	186	171	157
<b>Total</b>	<b>253</b>	<b>196</b>	<b>160</b>	<b>147</b>	<b>140</b>
<b>Ulster—</b>					
Antrim	303	296	210	339	335
Armagh	453	383	371	352	317
Cavan	326	233	206	188	174
Down	359	327	127	116	110
Fermanagh	378	344	323	307	282
Fermanagh	219	162	148	129	118
Londonderry	274	237	225	213	202
Monaghan	401	284	263	230	205
Tyrone	248	208	189	171	162
<b>Total</b>	<b>273</b>	<b>235</b>	<b>224</b>	<b>214</b>	<b>203</b>
<b>Connaught—</b>					
Galway	180	131	111	102	89
Leitrim	263	183	171	156	150
Mayo	182	129	119	115	114
Roscommon	267	183	167	148	139
Sligo	251	178	173	160	154
<b>Total</b>	<b>207</b>	<b>147</b>	<b>153</b>	<b>128</b>	<b>119</b>
<b>General Total</b>	<b>251</b>	<b>202</b>	<b>178</b>	<b>166</b>	<b>159</b>

TABLE XLV.—Rural and Urban Population.

1841.		1851.		1861.		1871.	
Rural.	Urban.	Rural.	Urban.	Rural.	Urban.	Rural.	Urban.
7,052,923	1,143,674	5,847,611	1,226,661	4,658,106	1,140,368	4,211,033	1,201,844

TABLE XLVI.—Population of Principal Towns, 1841-81.

Years.	Dublin.	Belfast.	Cork.	Limerick.	Waterford.	Londonderry.
1841	235,864	76,441	82,748	49,205	23,506	15,106
1851	291,700	100,945	87,758	53,782	25,643	20,187
1861	254,808	121,602	80,121	44,476	23,293	20,875
1871	246,326	174,412	78,842	30,353	23,349	25,242
1881	249,486	207,671	78,361	38,600	22,401	28,947



returns of emigration and immigration from and into the United Kingdom give full information regarding the destination of emigrants of Irish birth from 1853. Table XLVIII., compiled from the statistics of the census commissioners, and from the emigration returns, will show the character of the emigration movement, both as to the number of persons of Irish birth emigrating from the United Kingdom at different periods and as to their destination.

The influence of the great famine is very evident in the numbers emigrating between 1846 and 1852, the average being three times that of the preceding period, and more than double that of the period from 1853 to 1860. Although also the impulse towards emigration had begun even before 1846, and must be regarded as part of a general tendency towards emigration then prevalent in Europe, and especially in the United Kingdom, it was doubtless strengthened in Ireland by special circumstances which are still operating so as to cause an annual diminution of the population. The number who emigrated in 1841 was only 16,376, and in 1847 it rose to 215,444, more than double that of 1846. The highest number in any year was 249,721 in 1852, and the smallest since 1852 was 22,831 in 1877, the numbers increasing in 1879 to 41,206, and in 1880 to 93,641. This table, however, gives the number of emigrants not from Ireland but from the United Kingdom, and of course includes many of Irish birth who had been for some time living in Great Britain.

The Irish emigration returns, which commence from the 1st May 1851, give the numbers of natives of Ireland who emigrated direct from the country—whether by Irish or British ports—but include those also who emigrated to settle in Britain, and until 1876 gave no information as to the several destinations of the emigrants. Table XLIX. shows the amount of general emigration from Ireland and from its various provinces from 1st May 1851 to 31st December 1879. The number of emigrants in 1852 was 190,322, the annual average for the three years 1852-1854 being over 170,000, from 1855 to 1862 the average was about 80,000, but it rose to 110,000 for 1863-65. From 1865 to 1874 it was about 70,000, in 1876 it was only 37,587, in 1879 it was 47,065, and in 1880 it increased to 93,517. There are no direct means of obtaining information as to the numbers who emigrated to settle in Britain before 1876, but a comparison between the numbers who emigrated from Ireland both to Britain and to foreign countries with those who emigrated from the United Kingdom to foreign countries shows that the number who settled in Great Britain between 1852 and 1880 was about 300,000. The percentage of those who have settled in Britain between 1876 and 1880 was 38. Apparently, however, for several years, the deaths of Irish-born persons and their emigration from Great Britain have more than counterbalanced the influx into it of Irish intending to settle, for, while the number

of Irish resident in Great Britain, which in 1841 was 419,256, had increased by 1851 to 733,866, and by 1861 to 811,251, it had diminished by 1871 to 778,638. On the other hand, there has been a gradual increase in the number of British-born immigrants to Ireland, as is seen from Table L.

More than two-thirds of those leaving Ireland for foreign countries emigrate direct to the United States, but to these must be added the large numbers who sail to Canadian ports, and journey thence by rail. From May 5th 1847 to June 1880, according to records of the city, the arrivals of natives of Ireland direct to New York were 2,042,046, the arrivals from all countries being 5,857,925. The total number of Irish-born persons registered, whether in Ireland or foreign countries, about 1871 was 8,506,511,—that is, a larger number than the population of Ireland in 1841, and exceeding the population of 1871 by more than 3,000,000. The proportion of emigrants from Ireland who were labourers was 52.6 per cent. in 1877, 60.4 per cent. in 1878, 66.1 per cent. in 1879, and 72.1 per cent. in 1880. Until 1864, when the Act for the registration of births and deaths came into operation, no reliable information was obtainable as to the excess of the one over the other, and of course the large amount of emigration to some extent renders comparison with other countries impossible, as to the inferences to be drawn from the proportion of births and deaths to the population. Table LI. gives the yearly average of marriages, births, deaths, and emigrants for the ten years 1870-79, the numbers for 1880, and the rate per 1000 of estimated population.

The usual theory that the poverty of the Irish is due to early marriages, or to the fact that a larger number marry than in Scotland or England, can be proved by statistics to be wholly unfounded. The average annual number for the ten years ending in 1879 of male minors married was only 2.65 per cent. of the total males married, and in the case of females the percentage was only 12.26, a much smaller proportion than in Great Britain; and in 1871 the proportion per cent. of the unmarried population above fifteen years was in Ireland—males 47.85, females 42.38, the proportion in England and Wales being 38.40 and 36.14 respectively, and in Scotland 44.41 and 42.23. In proportion to the number of married women between seventeen and fifty-five years of age, the number of births is very similar to that in Great Britain. The number of illegitimate births is very small, the yearly average for the last ten years being about 2.5 per cent. The proportion of the sexes born is about 106 males to 100 females.

Table LII. gives the average annual number of deaths from each of the principal zymotic diseases and from all causes for 1870-79, and also the number for 1880. Table LIII. gives the number of deaths from all causes for four decades, and the number from zymotic diseases, with the percentage from these diseases to the

TABLE XLVII.—Classification of the Population according to Occupation.

	Food.	Clothing.	Lodging, Furniture, and Machines.	Health.	Charity.	Justice.	Education.	Religion.	Trade and Travelling.	Arts.	Miscellaneous.	Amusement.	Banking.
1841	1,904,071	901,324	164,366	6,871	253	19,541	16,814	7,192	78,524	3,495	409,409	...	..
1851	1,531,911	606,532	146,469	7,148	1,898	23,862	17,407	8,398	98,213	2,674	394,208	...	..
1861	1,053,045	490,492	143,562	6,735	983	55,085	40,853	10,627	68,791	757	507,327	2,840	4,563
1871	1,051,430	413,213	487,918	6,948	2,532	66,638	28,406	12,806	56,764	818	381,454	3,347	18,938

\* Including commercial clerks, who in 1861 were reckoned under Literature and Education.

TABLE XLVIII.—Emigrants from the United Kingdom of Irish Birth, 1841-80.

Destination	1841-52.		1841-46.		1847-52.		1853-60.		1861-70.		1871-80.		Total, 1853-80.	Total, 1841-80.
	Number.	Average.	Number.	Average.	Number.	Average.	Number.	Average.	Number.	Average.	Number.	Average.		
United States .....	1,265,841	165,462	239,769	29,961	1,025,772	170,962	574,848	71,856	690,840	69,084	449,553	44,955	1,715,241	2,980,782
British North America .....	370,105	30,842	133,850	22,310	230,245	29,373	64,680	8,085	40,080	4,008	25,782	2,578	130,542	500,647
Australia .....	30,254	2,521	5,083	845	25,171	4,196	92,184	11,523	82,920	8,292	61,947	6,195	237,051	217,305
All other places .....	126	10	99	16	27	4	5,016	627	4,740	474	5,426	542	15,182	15,308
Total .....	1,666,026	138,835	378,811	63,132	1,287,215	214,535	736,728	92,091	818,580	81,858	542,708	54,270	2,098,016	3,764,042

TABLE XLIX.—Total Native Emigrants from Ireland from May 1, 1851, to December 31, 1880.

	Leinster.	Munster.	Ulster.	Con-naught.	Not specified.	Ireland.
Males .....	257,968	476,366	441,510	163,926	61,766	1,400,456
Females .....	236,203	441,034	317,038	167,534	48,992	1,230,711
Total .....	494,171	917,399	758,548	336,460	110,668	2,637,187
Emigrants to every 100 of population in 1861 .....	37.9	60.6	40.7	36.8	...	45.5

TABLE L.—Persons not of Irish Birth in Ireland at Census Periods.

Where Born.	1841.	1851.	1861.	1871.	1841.	1851.	1861.	1871.
England and Wales .....	21,532	34,454	50,761	67,881	26	53	88	125
Scotland .....	8,565	12,312	16,861	20,518	11	19	29	38
Abroad .....	4,471	9,961	10,379	17,010	55	115	118	232

TABLE LI.—Yearly Average of Marriages, Births, Deaths, and Emigrants.

	Marriages.	Births.	Deaths.	Emigrants.	Marriages.	Births.	Deaths.	Emigrants.
1870-79	25,847	142,404	95,430	60,427	4.83	26.6	17.8	11.7
1880	29,390	128,010	102,355	95,517	3.83	24.0	19.3	17.9

total number of deaths; and Table LIV. shows the number suffering from the various kinds of serious bodily or mental infirmities in 1851, 1861, and 1871. The total number of deaths in the decade ending in 1881 was 969,110.

The mortality of Ireland is considerably under that of Great Britain, and at the time of the census of 1871 a larger percentage of the population were over sixty years of age. The rate of mortality is no doubt affected by emigration, but its smallness in Ireland is perhaps due to the large proportion of the rural population. At various periods the mortality has been largely increased by famine, and it is also influenced by the insufficient diet and clothing of many of the inhabitants.

**Government.**—The executive government is vested in a lord-lieutenant, assisted by a privy council, and by a chief secretary, who is a member of the House of Commons and frequently also a member of the cabinet. In the absence of the lord-lieutenant his functions are discharged by lord-justices, those generally appointed being the lord-chancellor and the commander of the forces. Each county is in charge of a lieutenant, a number of unpaid deputy-lieutenants and magistrates, and one or more resident paid magistrates, all appointed by the crown. The counties of cities and towns and the boroughs are governed by their own magistrates. The judicial establishment consists of the high court of chancery, the courts of Queen's bench, common pleas, and exchequer, the landed estates court, and the probate and matrimonial court, which since 1877 constitute the high court of justice; the court of appeal; the high court of admiralty, which is to be abolished after the death of the present judge; and the court of bankruptcy and insolvency. The decisions of the court of appeal are subject to an appeal to the House of Lords. Assize courts are held in each county by two judges, for which purpose the county is divided into six circuits.

Ireland is represented in the imperial parliament by 28 temporal peers elected for life and 103 commoners,—the counties being represented by 64 members, the small boroughs by 25, Dublin, Cork, Limerick, Waterford, Belfast, and Galway by 2 each, and the university of Dublin by 2. In 1850 the franchise in county elections was extended to occupiers of any tenement assessed for poor rates at a net annual value of £12 and upwards, and also to owners of certain estates of the rated net annual value of £5. In 1868 the franchise in boroughs was extended to occupiers rated at and above £4, and a lodger franchise was also introduced, granting votes to occupiers of lodgings of a clear yearly value, if let unfurnished, of £10 and upwards.

In Ireland there are four military districts, the headquarters of these being Dublin, Cork, Curragh, and Belfast respectively, and eight military subdistricts, with depots at Downpatrick, Onagh, Armagh, Naas, Birr, Galway, Clonmel, and Tralee. The Irish militia consists of 12 regiments of artillery, 21 regiments of

infantry, and 14 rifle corps, numbering when embodied over 31,000 men and officers

The parish constables of Ireland were in 1814 superseded in proclaimed districts by a peace preservation force, and in 1822 an Act was passed authorizing the formation of a constabulary force of 5000 men, under an inspector-general for each province. In 1836 the entire force was amalgamated under one inspector-general. In all, it numbers between 10,000 and 12,000 men. In addition to the usual duties of policemen, the police are entrusted with the collection of statistics, the preservation of fish and game, and a variety of services connected with the local government. The average annual expense is a little over £1,000,000. In addition to this force there is the Dublin metropolitan police, consisting of about 1100 officers and men, who are maintained at an annual cost of over £130,000, the expense borne by the Consolidated Fund being over £80,000.

**Crime.**—Table LV. gives the number of persons in Ireland sent for trial by jury, and the numbers convicted and acquitted, for every fifth year from 1845 to 1875, and also for 1878 and 1880.

These figures show a very rapid decrease of crime between 1850 and 1855, and a gradual and considerable decrease since that period, partly but not altogether attributable to the decrease in the number of the population. The large number of committals in 1850 and previous years was chiefly owing to the distress then prevailing in the country. A very noticeable feature of the statistics is the large proportion of acquittals.

In regard to the more serious crimes, the proportion of offences against the person as compared with that in England is very large, and of offences against property and against the currency very small, the latter fact being doubtless owing to the small proportion of the town population. The proportion for all Ireland of indictable offences not disposed of summarily was 15 in 10,000 of the population in 1879, while in Dublin it was 110 in 10,000.

Table LVI. gives the number of offences in Ireland for 1879 according to three classes, and the corresponding numbers for 1878 in England and Scotland for an equal population.

Of the minor offences in Ireland over 99,000 were cases of drunkenness, considerably more than double the number of cases in England or Scotland, which were pretty nearly equal. Table LVII. gives the number of agrarian offences from 1870.

**Poor Law Authorities.**—The legislation connected with making provision for the poor of Ireland dates from 1771, when an Act was passed by the Irish parliament under which 11 houses of industry were erected, 8 in Munster, and 3 in Leinster. The amount of expenditure sanctioned by the Act was £14,400 a year, and probably it always came short of this by at least £10,000. Additional powers were conferred on county authorities in 1806 and 1818, but according to the select report of the House of Commons in 1830 no addition had been made to the houses of industry up to that period. An Act was, however, passed in 1838, which contained

TABLE LII.—Annual Average of Deaths from the eight principal Zymotic Diseases and from all causes.

	Smallpox.	Measles.	Scarlet Fever.	D. Thieria.	Hooping-Cough.	Fever.	Diarrhoea.	Cholera.	Total.	All causes.	Percentage of eight Zymotics.
Annual average for 1870-79 . . .	719	1,104	2,362	328	1,738	3,000	1,798	76	11,125	95,430	11.7
Number for 1880 . . . . .	369	979	2,350	289	2,199	2,986	2,518	60	11,750	102,955	11.4

TABLE LIII.—Total Deaths, with Numbers and Proportions from Zymotic Diseases, in decades ending 1841, 1851, 1861, and 1871.

Total Deaths.	Decade ending 1841.		Decade ending 1851.		Decade ending 1861.		Decade ending 1871.				
	Zymotic Diseases.		Zymotic Diseases.		Zymotic Diseases.		Zymotic Diseases.				
	Number.	Per Cent.	Number.	Per Cent.	Number.	Per Cent.	Number.	Per Cent.			
1,181,374	351,249	32.1	1,361,051	553,801	40.7	819,768	189,660	23.1	767,909	140,289	18.2

TABLE LIV.—Sufferers from various Infirmities, 1851-71.

	Deaf and Dumb.	Blind.	Lunatic and Idiotic.	Lame and Decepit.	Sick in Work-houses.	Sick in Hospitals.	Sick in Prison.	Inmates of Asylums.	Ordinary Sick.
1851	5,180	5,767	9,980	4,375	42,474	4,545	1,072	2,271	45,291
1861	5,653	6,879	14,098	4,120	16,761	2,993	461	2,087	46,141
1871	5,554	6,317	16,505	2,931	16,203	3,625	85	3,129	39,754

TABLE LVI.—Offences in Ireland for 1879, with Equivalent Numbers for Great Britain for 1878.

Ireland.	More Serious Offences.			Less Serious Offences.			Minor Offences.		
	England	Scotland	Ireland.	England	Scotland	Ireland.	England	Scotland	Ireland.
3,842	4,767	6,437	55,398	45,657	119,742	203,199	107,354	84,598	

TABLE LV.—Prisoners sent for Trial by Jury, 1845-1879.

	1845.	1850.	1855.	1860.	1865.	1870.	1875.	1879.	1880.
For Trial . . . . .	16,686	31,326	9,012	5,386	4,657	4,956	4,248	4,133	4,716
Convicted . . . . .	7,101	17,108	5,220	2,979	2,661	3,048	2,494	2,293	2,383
Acquitted . . . . .	9,585	14,218	3,792	2,407	1,996	1,908	1,754	1,890	2,333

TABLE LVII.—Agrarian Offences in Ireland, 1870-80.

Years.	Number.	Years.	Number.	Years.	Number.
1870	1323	1874	212	1878	289
1871	268	1875	136.	1879	810
1872	252	1876	201	1880	2679
1873	253	1877	236		



the important provision that if the local authority failed to carry the law into effect they might be superseded by paid vice-guardians. The Act came into operation in 1840, and an Outdoor Relief Act was passed in 1847. Full details regarding subsequent additions to the Act, as well as in reference to the whole subject of Irish local government, will be found in the paper by Dr Hancock contributed to *Cobden Club Essays*, 1875. Table LVIII. gives the number of unions for every ten years from 1840 to 1870, and for 1878 and 1879, with the number of outdoor and indoor paupers, and the total expenditure. The figures show a much smaller proportion of paupers compared with population than the corresponding statistics of England and Scotland,—Scotland notwithstanding its smaller population having nearly one-third more paupers, while England has actually about twelve times as many. The difference is to be accounted for by the smaller town population of Ireland, the simpler habits of the Irish, and the prevalence of mendicancy. It is only indeed in years of exceptional famine that there is any great demand on the public purse for the support of the poor: the duchess of Marlborough's relief fund, 1879-80, amounted to £135,000, and the Mansion House fund to £180,000, probably over £400,000 being spent directly on relief, in addition to the sums advanced on loan for relief works. By the Medical Charities Act, passed in 1851, boards of guardians were empowered to form the poor law unions into dispensary districts subject to the control of the poor law commissioners. The number of dispensary districts is 720, with nearly 1100 dispensaries and about 800 medical officers. Each district is placed under a committee of management, consisting of the guardians of the unions, the *ex officio* guardians who reside and have property in the district, and a number of ratepayers elected by the board of guardians, the number of each committee being fixed by the commissioners. The average annual expenditure under this Act during the five years ending 1880 was over £140,000, and the average number of cases very nearly 700,000. The average number of insane in Ireland during the same five years was over 19,000, of which number the average in asylums was over 8000, and in workhouses over 3000. For further information regarding the whole subject of Irish pauperism and lunacy the reader is referred to the Report of the Poor Law Union and Lunacy Commissioners in vol. xxii. of *Accounts and Papers*, 1878-79.

**County Authorities.**—For purposes of local taxation Ireland is placed under the authority of baronial presentment sessions and juries. The former are for baronies or half-baronies, baronies corresponding to the ancient territories inhabited by distinct tribes or families. The number of these sessions is 326, and they are composed partly of justices of the peace and partly of ratepayers, the number of whom is fixed by the grand jury of each county. Since 1836 they have had the primary decision of all questions as to roads and bridges. The power of imposing county rates is, except in the case of the county of Dublin, exercised by the grand juries either at the assizes in the several counties at large, or at the assizes in the several counties of cities and towns. In the county of Dublin this authority is vested in the Easter term grand jury in the court of Queen's bench, and in the case of the cities of Dublin, Cork, and Limerick it has since 1850 been vested in the town councils. The tax levied under the vote of the grand juries is called grand jury cess, and is employed for the maintenance of roads, and the defrayment of the expenses incurred by the

maintenance of laws and the administration of justice. Infirmaries and hospitals are supported by grand jury presentments, aided by treasury grants, and by subscriptions, donations, and bequests. The origin of the grand jury cess dates from the time of Charles I., when the justices were directed to tax the inhabitants for the maintenance of bridges, with the assent of the grand juries. At the beginning of the reign of George III. power was granted to the grand juries to make presentments also for roads. At first the rate was applied only to the maintenance of cross roads, but in 1857 the turnpike system applicable to main roads was abolished. This early accidental legislation in reference to roads has given Ireland at least one solitary advantage over Great Britain which it still retains.

**Authorities for Groups of Counties.**—These consist of governors of district lunatic asylums and the trustees of inland navigation and arterial drainage. The asylums number 22 in all, and the governors are nominated by the lord-lieutenant. The navigation works in Ireland were executed at the time of the famine of 1846, and their management is placed under a board of trustees originally named by Act of Parliament, the vacancies being filled up by the grand juries.

**Town Authorities.**—The towns of Ireland were under the government of close corporations until 1829, when they were allowed to adopt popular constitutions. By the Municipal Act of 3d & 4th Vict., the towns containing upwards of 12,000 inhabitants are divided into wards, and are governed by a council consisting of a chief magistrate called mayor, that of Dublin being styled lord mayor, and a certain number of aldermen and councillors for each ward. Eighteen towns are governed according to the Act of 9th George IV., and more than 80 have adopted the Towns Improvement Act of 1854. Additional powers were conferred on town authorities by the Local Improvement (Ireland) Act of 1871.

**Harbour Authorities** are distinct from the town authorities, and consist of a board chosen in accordance with certain special acts.

The town authorities, or in counties the poor law guardians, have the power to constitute themselves a burial board for the purpose of levying rates, to be used in the maintenance of old burial grounds or the purchase of new ones.

By an Act passed in 1872 the functions previously performed by the lord-lieutenant, the privy council, and the chief secretary in reference to local government were transferred to a local government board, formed out of the poor law board which it superseded.

**Taxation.**—The local taxation of Ireland amounted in 1866, the first year for which returns are available, to £2,538,280, in 1870 to £2,728,327, and in 1879 £3,368,113. The following are the separate items for 1879:—grand jury cess, £1,128,192; fees of the clerks of the peace (exclusive of salary), £11,585; fees of the clerks of the crown, £2834; petty session stamps and crown fines, £65,086; dog licence duty, £35,945; Dublin metropolitan police taxes, £44,965; court leet presentments, £293; harbour taxation, £380,350; inland navigation, £5679; town taxation under town authorities, £622,871; burial board taxes, £3185; poor rate and local receipts, £1,031,992; light dues and fees, under Merchant Shipping Act, and bridge and ferry tolls, £35,086. The amount of rates on real property was £2,619,183, or 77·8 per cent. of the whole; tolls, fees, stamps, &c., £539,174, or 16·0 per cent.; and other receipts, £209,756 or 6·2 per cent. The amount granted from the imperial revenue in aid of local taxation in 1880-81 was £1,856,743, in addition to which an annual sum, £1,189,461 in 1880, is advanced on loan by the Commissioners of Public Works from the Consolidated Fund, while £883,116 was advanced in 1880 from the Irish Church fund.

**Religion.**—According to the census returns of the commissioners of public instruction in 1834, out of a total population of 7,943,940 inhabitants 852,064 belonged to the Established Church, the number of Roman Catholics being 6,427,712, of Presbyterians 642,356, and of persons of other denominations 21,808. Table LIX. gives returns for 1861 and 1881.

The annual average number of marriages according to the forms of the Episcopalian Church for the ten years 1869-78 was 4208,

TABLE LVIII.—*Poor Law Unions and Paupers, 1840-80.*

	Unions.	Indoor Paupers.	Outdoor Paupers.	Expenditure.
1840	4	10,910	...	£37,057
1850	163	805,702	368,565	1,430,108
1860	163	170,549	8,965	454,531
1870	163	230,971	53,885	668,202
1878	163	248,810	75,290	845,608
1880	163	367,354	181,778	929,967

TABLE LIX.—*Classification of Population according to Religious Profession, 1861 and 1881.*

		Roman Catholics.		Protestant Episcopalians.		Presbyterians.		Methodists.		All other Denominations.		Total.
		Number.	Per Cent.	Number.	Per Cent.	Number.	Per Cent.	Number.	Per Cent.	Number.	Per Cent.	
Leinster.....	1861	1,252,553	85·9	180,587	12·4	12,355	0·9	6,290	0·4	5,850	0·4	1,457,655
	1881	1,095,459	85·6	157,622	12·3	12,633	1·0	6,712	0·5	6,764	0·6	1,279,190
Munster.....	1861	1,420,076	93·8	80,860	5·3	4,013	0·3	4,436	0·3	4,173	0·3	1,513,558
	1881	1,244,876	93·0	68,352	5·2	3,794	0·3	4,421	0·3	2,467	0·2	1,323,910
Ulster.....	1861	966,613	50·5	291,315	20·4	503,835	26·3	32,030	1·7	20,443	1·1	1,914,236
	1881	831,784	47·8	377,936	21·7	466,107	26·8	34,494	1·9	29,221	1·6	1,739,542
Connanght.....	1861	866,023	94·8	40,595	4·5	3,088	0·3	2,643	0·3	786	0·1	913,135
	1881	779,769	95·4	31,760	3·9	2,969	0·4	2,042	0·2	657	0·1	817,197
Ireland.....	1861	4,505,265	77·7	693,357	11·9	523,291	9·0	45,399	0·8	31,655 <sup>1</sup>	0·6	5,798,967
	1881	3,951,888	76·6	635,670	12·3	485,503	9·4	47,669	0·9	39,109 <sup>2</sup>	0·8	5,159,839

<sup>1</sup> Including seamen at sea on census night.

<sup>2</sup> Including 453 Jews and 1144 who refused information.

and for 1879 it was 3646,—the numbers according to the Presbyterian form being 2556 and 2214 respectively, in other registered buildings 308 and 338, and according to the rites of the Roman Catholic Church 18,567 and 16,578.

The Anglican Episcopal Church of Ireland constituted until 1871 an integral part of one church, known as the Church of England and Ireland, and established by law in the two countries; but the Irish branch was disestablished and disendowed by an Act which received the royal assent on July 26, 1869. According to this Act, which came into execution on January 1, 1871, all church property became vested in a body of commissioners. All the state grants were to be resumed by the state, provision being made for vested interests, but the church was to receive possession of all endowments obtained from private sources since 1660. To all incumbents the income they formerly possessed was secured for life, minus the amount they might have paid for curates; and compensation was also granted to curates, parish clerks, and sextons, to Maynooth Roman Catholic College in lieu of the continuance of the annual parliamentary grant, and to the Presbyterians in lieu of the continuance of the grant called "Regium Donum."

According to the report of the commission appointed to inquire into the revenues of the Established Church, *Accounts and Papers*, 1867-68, the net annual produce and value of the entire property was found to be £616,840, of which the value of the houses of residence and the lands in possession of the clergy was £32,152. The total sum paid or payable by the commissioners of church temporalities as compensation in connexion with the operation of the Irish Church Act is estimated at £11,666,518. To meet the demands upon them the commissioners borrowed £9,000,000 from the National Debt Commissioners. The total sum obtainable by sales of church property is £9,794,790, of which £3,362,648 has been received in cash, the balance, except £797,766, which is secured by mortgage, being payable in terminable annuities. In addition to this there is a permanent income consisting of title rent-charges and perpetual rents estimated at £293,455. The work of the commissioners has now been practically completed, and according to their report for 1869-80 the estimated value of the estate is now £12,189,728, exclusive of £200,000, the value of uncommuted glebes and uncollected arrears. The annual income at present is £574,219, but by the termination of annuities it will gradually diminish until 1932, when there will still be the permanent income of £293,455. But for additional burdens laid upon the estate its entire debt would at the end of 1880 have been £5,900,000, leaving a surplus of £6,500,000. These burdens are a sum of £1,000,000 for intermediate education, £1,300,000 to form a pension fund for national school teachers, and the interest at 3½ per cent. of £1,500,000 advanced on loan for the purposes of the Relief of Distress (Ireland) Acts, 1880, and involving a loss to the estate of £543,345.

Before its disestablishment the Church of Ireland consisted of 2 archbishoprics, 10 bishoprics, 30 corporations of deans and chapters, 12 minor corporations, 32 deaneries, 33 archdeaconries, 1509 incumbencies, with 500 stipendiary curates. A general convention of the clergy to reorganize the church and to choose a representative body to manage its secular affairs met in February 1870, and the church is now constituted as the Church of Ireland. The amount received from the commissioners for commutation of life interests up to 31st December 1879 was £7,577,477, 6s. 8d., chargeable with annuities amounting to £592,075, 5s. 8d., and of this sum there remained at the end of 1879 £2,783,871, 11s. 8d., chargeable with annuities amounting to £201,824, 8s. 9d., the annuities extinguished by composition and advances amounting to £294,054, 9s. 4d. The sums invested by the church in securities amounted to £6,362,433, 17s. 5d., yielding an income of £281,577, 11s. 8d., in addition to which £109,162, 10s. has been advanced to the clergy on policies of insurance. The balance of the general

sustentation fund amounted to £194,125, 12s. 8d., yielding an interest of £7753, 7s. 9d., the unappropriated balance of which was £963,7s. 9d. The sum expended on the purchase of glebes has been £499,589, 16s. 10d., of which £214,900, 10s. 8d. has been subscribed; and the net amount received from the sale of glebes was £45,588, 10s. 3d. The contributions to the stipend fund, and the total contributions from all sources from 1876 to 1879, are shown in Table LX. For fuller financial details the reader is referred to the annual report of the representative body and to the *Irish Church Directory*.

The Roman Catholic Church is governed by 4 archbishops and 27 bishops, the number of parish priests being nearly 1000, and of administrative curates about 1750. The ecclesiastical parishes amount to 1084, and the churches and chapels number nearly 2500. The Maynooth Roman Catholic College, which was founded in 1795, originally received an annual vote from Government of £8000, but latterly a grant from the consolidated fund of £26,360, which was commuted by the payment of £372,331.

The Presbyterian Church, which has its principal adherents in Ulster, was originally formed in 1642, and in 1840 a union took place of two divisions of the church which had formerly separated. Previous to the disestablishment of the Church of Ireland, the Presbyterians received for the support of their ministers an annual sum, first granted in 1672, of about £40,000, known as "Regium Donum," which was commuted by the Church Disestablishment Act. The church embraces 36 presbyteries and nearly 600 congregations, the number of families connected with the church in 1880 being 79,214, and of communicants 104,769. The total sum at the disposal of the church in 1880 was £139,840, the sum paid to ministers being £44,922. Candidates for the ministry are trained at Magee College, Londonderry, and at the Presbyterian College, Belfast.

The Methodist Church of Ireland was formed in 1878 by the union of the Wesleyan Methodists with the Primitive Wesleyan Methodists. The number of ministers connected with the Conference in June 1880 was 240, of whom 40 were supernumeraries. The number of principal stations under the charge of ministers was 135, embracing 373 chapels. The number of attendants on public worship was stated to be 60,541, and the membership 24,463. The home mission fund, with an augmentation from the English Conference, amounted to £13,241, and the sum raised for foreign missions to £5533. There is a Methodist college at Belfast for the training of students who have been accepted as candidates for the ministry.

The number of persons connected with the other denominations of Ireland is inconsiderable, amounting in 1881 to only 0·8 per cent.

*Education.*—Table LXI. shows the proportion per cent. of persons in Ireland who could read and write, who could read only, and who could neither read nor write at the various census periods. The number of persons in 1871 who could speak Irish only was 103,562, the number in 1841 being 319,602, and the number who could speak both Irish and English was 714,313 in 1871 and 1,204,684 in 1841.

According to the census of 1871 the number of schools for primary instruction was 9495 with 615,785 pupils, of superior schools 574 with 21,225 pupils, of universities and colleges 13 with 2945 students. The oldest university is that of Dublin, established in 1591 by a charter of Queen Elizabeth. The course of study includes mathematics, classics, modern languages, English, logic, ethics, astronomy, experimental science, and natural science. The Catholic University, founded in 1854, has in operation faculties of medicine, philosophy and letters, and science. Queen's University, established in 1850, with colleges at Belfast, Cork, and Galway, has faculties of law, arts, medicine, and engineering. Queen's University will be shortly superseded by the Royal University, for which a charter was granted in 1880. A royal college of science was established in 1867, with departments of mining, agriculture, engineering, and manufactures. The higher education of women is represented by Alexandra College, Dublin, founded in 1866, the Governors' Association, the Ladies' Institution of Belfast, and the Queen's Institute for the instruction of women. A list of colleges and intermediate schools will be found in the *Intermediate Education Year Book and Directory*. By the provisions of the Intermediate Education (Ireland) Act, 1878, a sum of £1,000,000 of the Irish Church surplus was set apart for the encouragement of intermediate education in Ireland, the money being expended partly in

TABLE LX.—Contributions to Stipend Fund, &c., 1876-79.

1876.		1877.		1878.		1879.	
Stipend Fund.	All Sources.	Stipend Fund.	All Sources.	Stipend Fund.	All Sources.	Stipend Fund.	All Sources.
£124,424	£212,095	£118,478	£197,539	£115,558	£139,403	£108,272	£165,007

TABLE LXI.—Classification of Population according to Education—Percentages for 1841, 1851, 1861, and 1871.

	Could Read and Write.				Could Read only.				Could neither Read nor Write.			
	1841	1851	1861	1871	1841	1851	1861	1871	1841	1851	1861	1871
Leinster....	34	39	49	57	22	22	20	16	44	39	31	27
Munster...	26	31	40	49	13	14	14	12	61	55	46	39
Ulster.....	30	35	42	50	30	30	28	23	40	35	30	27
Connaught.....	16	21	28	36	12	13	15	15	72	60	57	49
Ireland.....	23	33	41	49	19	20	20	17	53	47	39	33



exhibitions and prizes to students, and partly in the payment of results fees. The total number of pupils examined in 1880 was 5561—4114 boys and 1447 girls, the number who passed being 2899 boys and 1111 girls. Exhibitions of the value of £20 a year for three years were awarded to 96 boys and 40 girls in the junior grade; in the middle grade 32 boys and 13 girls received exhibitions of £30 annually for two years; and in the senior grade 16 boys and 4 girls received exhibitions of £50 for one year. In addition to this 558 boys and 726 girls received prizes in books.

In 1811 a society was formed in Ireland for the education of the poor, which from 1819 received the assistance of a grant of public money. This, however, was withdrawn in 1830 on account of the Roman Catholics refusing from religious objections to allow their pupils to enter the schools of the society. In 1833 the money formerly given to the society was vested in commissioners of public education, who in 1845 were incorporated under the name of the "Commissioners of National Education of Ireland."

Table LXII. will show the progress of national education in Ireland from 1833 to 1880; and Table LXIII. gives particulars as to school attendance for 1880.

Table LXIV. shows the Protestant and Roman Catholic attendance at the 4175 mixed schools from which returns were received.

The unmix'd schools numbered 3331, of which those taught by Roman Catholic teachers numbered 2779, the number of pupils being 411,612, while those taught by Protestant teachers numbered 552, the total number of pupils being 63,983, of whom 26,253 belonged to the Church of Ireland, 34,348 to the Presbyterian Church, and 3352 to other denominations. Table LXV. shows the attendance at the various classes in the national schools in 1880.

The number of district and minor model schools in 1880—exclusive of those of the metropolitan district—was 26, the number of pupils on the roll 16,997, and the average attendance 8971. Table LXVI. shows the relative proportion of attendance at the various classes.

The workhouse schools under the superintendence of the National Board in 1880 numbered 158, the pupils on the roll being 16,945, and the average attendance 8880. There were 52 industrial schools in 1879, the number of inmates being 4979, and the expenditure

£117,888. The number of school farms connected with the national schools in 1880 was 94, and of school gardens 19, in addition to which there are a large number of agricultural schools under local management, and a large number of pupils were also taught agriculture in the national schools, the total number of pupils who presented themselves for examination in agriculture in 1880 being 33,648, of whom 15,652 passed. The number of pupils who presented themselves at the results examination in the national schools in 1880 was 461,574, of whom 340,871, or 73·8 per cent., passed. Table LXVII. shows the various classes of teachers under the National Board in 1880.

In addition there were 85 junior assistants, 227 work mistresses and industrial teachers, 90 temporary assistants, and 8 temporary work mistresses. The payment to the teaching staff for the year ending 31st March 1881 was £737,631, 4s. 3d. The amount of money raised by school fees was £91,300, 5s. 8d., by subscription £40,516, 6s. 10d., by local rates £8,324, 6s. 7d. The whole amount received from the Board was £597,490, 5s. 2d. The amount of subscriptions other than local for the four years ending 1880 was £151,698, 16s. 6d., which was devoted to building purposes. The total amount of the parliamentary grant for the promotion of education, science, and art in Ireland for the year ending 31st March 1880 was £793,351.

For particulars regarding the endowments, funds, and actual condition of the endowed schools of Ireland, including the royal free schools, diocesan free schools, grammar schools, Erasmus Smith schools, and schools connected with the Church of Ireland, the Roman Catholic Church, and the various other denominations, the reader is referred to the *Report of the Endowed Schools (Ireland) Commission*, vols. i. and ii., 1881.

*Antiquities.*—The principal objects in Ireland of antiquarian and architectural interest are noticed under the various counties.

BIBLIOGRAPHY.

*Geology.*—The Government geological survey of Ireland, begun in 1832, was completed in 1881, and maps of separate portions have been published, accompanied with explanatory memoirs. Among the geological maps of the whole country may be mentioned that by E. Hull, London, 1878. The chief works on the geology of the country as a whole are Sir Richard Griffith's *Physical Geology of Ireland*, 2d edition, 1838; Hull's *Physical Geology and Geography of Ireland*, London, 1878; and Kinnahan's *Manual of the Geology of Ireland*, London, 1878. An interesting notice of the principal features of Irish geology will be found in *Ans Ireland*, by Dr Arnold von Lasaulx, Bonn, 1877. A list of the more important papers on the special points of Irish geology is given in the work of Hull.

*Agriculture.*—For information regarding the character of the land systems of Ireland the reader may consult Godkin's *Land War in Ireland*, 1876; Sigerson's *History of Land Tenure in Ireland*, 1871; O'Curry's *Ancient Manners and Customs of Ireland*, 3 vols., 1873; the paper on "The Tenure of Land in Ireland," by Judge Longfield, in *Systems of Land Tenure*, published by the Cobden Club, 1876, and with additions in a new edition, 1881; Fisher's *History of Land Holding in Ireland*, 1877; O'Brien's *History of the Irish Land Question*, 1880; Richey's *Irish Land Laws*, 1880. The political-economy relations of the subject have been treated, among other writers, by John Stuart Mill, T. E. Cliffe Leslie, and Professor Cairnes. For general information a first place must be

TABLE LXII.—National Schools in Ireland, 1833-80.

	1833			1840			1850			1860		
	Schools.	Pupils.	Parliamentary Grant.	Schools.	Pupils.	Parliamentary Grant.	Schools.	Pupils.	Parliamentary Grant.	Schools.	Pupils.	Parliamentary Grant.
	780	107,042	25,000	806	950,990	391,209	1,878	1,036,742	659,837	7,522	1,011,993	681,829
	5,632	804,000	270,722	7,590	1,083,020	722,366						

TABLE LXIII.—Attendance in National Schools, 1880.

	Total Schools.	Schools sending in Returns.	Pupils on Roll who made at least one attendance.			Religious Denominations.			
			Males.	Females.	Total.	Roman Catholics.	Episcopalian Church.	Presbyterians.	Other.
Ulster.....	2,867	2,846	200,293	183,528	383,821	185,462	76,684	113,028	8,647
Munster.....	1,913	1,885	140,492	147,941	288,438	279,774	7,481	595	583
Leinster.....	1,595	1,576	107,123	112,189	219,312	204,786	12,576	1,397	553
Connaught.....	1,215	1,202	98,393	93,061	191,454	185,035	5,477	609	333
Ireland.....	7,590	7,509	546,301	536,719	1,083,020	855,057	102,218	115,629	10,116
Per cent.....	...	...	50·4	49·6	...	79·0	9·4	10·7	0·9

TABLE LXIV.—Attendance in Mixed Schools, 1880.

Teachers.	Schools.	Roman Catholic Pupils.	Protestant Pupils.	Per cent.	
				Roman Catholics.	Protestants.
Roman Catholic.....	2,804	877,677	24,011	94·0	6·0
Protestant.....	1,273	26,183	127,868	16·4	83·6
Roman Catholic and Protestant.....	98	10,580	11,923	47·0	53·0
Total.....	4,175	413,440	163,802	71·6	29·4

TABLE LXV.—Percentages in National Schools, 1880.

	In-fants.	Class.					
		I.	II.	III.	IV.	V.	VI.
Ireland.....	26·5	21·8	15·1	12·9	10·0	6·5	3·4
	26·5	40·8					
		23·7					

TABLE LXVI.—Percentages in Model Schools, 1880.

Infants.	Class.							
	I.	II.	III.	IV.	V.	VI.	VI <sup>a</sup> .	VI <sup>b</sup> .
12·9	10·0	11·7	14·0	14·9	13·3	9·1	14·1	
12·9	35·7						51·4	

TABLE LXVII.—Teachers in Service of the National Board, 1880.

Class.	Principals.		Assistants.		
	Males.	Females.	Males.	Females.	
1.—1st Division.....	129	102	13	23	1,055
1.—2d ".....	399	302	23	64	
2.—1st ".....	1,418	857	76	318	3,614
2.—2d ".....	348	266	47	187	
3.—1st ".....	1,710	991	408	1,390	6,105
3.—2d ".....	533	376	197	502	
	4,585	2,894	761	2,484	10,674
	7,429		3,245		

assigned to the evidence given before the Devon Commission, a *Digest* of which by J. P. Kennedy was published at Dublin in two parts, 1847-48, and the Report of the Bessborough Commission, 1881, and of the Commission on the Agriculture of the United Kingdom, 1881. Among other works are—Thornton, *Plan for Peasant Proprietors*, 1848; Duval, *Histoire de l'Émigration*, Paris, 1862; Dufrenoy, *Irish Emigration and the Tenure of Land in Ireland*, 1867; P. Laville, *Irish Landlords since the Revolution*, 1870; H. S. Thompson, *Ireland in 1839 and 1860*, 1870. The agricultural condition of the country has been described by such competent observers as M'Combie, MacLagan, and James Caird; and for minute details regarding it see the "Review of Irish Agriculture," by R. O. Pringle, in vol. viii., second series, of the *Journal of the Royal Agricultural Society of England*, 1872, and "Illustrations of Irish Farming," by the same writer, in vol. ix., 1873. *Manufactures and Commerce*.—Lawrence, *The Interest of Ireland in her Trade and Woollen Manufacture*, 1682; *Discourse on the Woollen Manufacture of Ireland*, 1698; *An Inquiry into the State and Progress of the Linen Manufacture in Ireland*, Dublin, 1757; G. E. Howland, *Treatise on the Revenue of Ireland*, 1776; Hely Hutchinson, *Commercial Restraints of Ireland*, 1779; Lord Sheffield, *Observations on the Manufactures, Trade, and Present State of Ireland*, 1785; R. H. Clarendon, *A Sketch of the Revenue and Finances of Ireland*, 1791; Wallace, *Essay on the Trade and Manufactures of England*, Dublin, 1798.

*Antiquities*.—O'Donovan's edition of the *Annals of the Four Masters*; Weever, *Ancient Funeral Monuments*, 1767; Bush, *Hibernia Curiosa*, 1769; Grose, *Antiquities of Ireland*, 2 vols., 1791-92; Ed. Ledwich, *Antiquities of Ireland*, 1804; O'Brien, *Round Towers of Ireland*, 1824; G. S. Petrie, *Antiquities of Ireland*, 1845; Goulkin, *Suzons in Ireland*, 1851; Id., *Ireland and her Churches*, &c., 1857; Keane, *Towers and Temples of Ancient Ireland*, 1867; Smiddy, *Essay on the Druids, Ancient Churches, and Round Towers*, 1873; Bvash, *Ecclesiastical Architecture of Ireland*, 1874; Joyce, *Irish Names of Places*, 2d ed., 1870, 2d series, 1873; Lotii Dunnevan, *Notes on Irish Architecture*, 1877; H. Goidoz, *Notice sur les Inscriptions Latines de l'Irlande*, Paris, 1878.

*Miscellaneous*.—An account of the condition of the country in the time of Henry II. is given by Giraldus Cambrensis in *Topographia Hibernica* and *Expugnatio Hibernica*, 1181; and in the time of Elizabeth, by Robert Payne, in "A Brief

Description of Ireland," 1590, published in vol. i. of the *Tracts of the Archaeological Association of Ireland*, 1841, and by Ed. Hogan in *Description of Ireland and the State thereof in 1590*, first published in 1878. The following works, which are included in *A Collection of Tracts and Treatises on Ireland*, published at Dublin, 1861, are invaluable for the information they afford in regard to the social and industrial history of the country.—*A View of the State of Ireland*, by Edmund Spenser, 1633; *A Discoverie of the State of Ireland*, by Sir John Davies, 1633; *The Political Anatomy of Ireland*, by Sir William Petty, 1691; *The Quaker*, by Bishop Berkeley, 1745-57; *A Word to the Wise*, by the same, 1752; *Prior's List of Absentees*, 2d edition, with Appendix, 1729; *An Essay on the Trade of Ireland*, by Arthur Dobbs, Esq., 1729; *An Abstract of the Number of Protestant and Popish Families in Ireland*, 1728. The writings of Swift, especially his *short View*, cast a variety of cross lights on different aspects of the subject. Among later works a first place must of course be given to the *Tour in Ireland*, by Arthur Young, London, 1780. *The Statistical and Political Account of Ireland*, by Edward Wakefield, London, 1812, is painstaking and accurate; and of similar value are Thomas Newenham's *View of the Circumstances of Ireland*, 1809; the same author's *Inquiry into the Population of Ireland*, 1805; and Mason's *Statistical Account*, 1814-19. The laborious work of M. César Moreau, *Post and Present State of Ireland examined in a Series of Tables*, published in lithograph, London, 1827, gives a comprehensive statistical history of the country for twenty years before and twenty years after the Union. Among more modern works are—*On Local Disturbances in Ireland*, by Sir G. C. Lewis, 1636; Sir Robert Kane, *The Industrial Resources of Ireland*, 2d edition, Dublin, 1845; George Lewis Smith, *Ireland, Historical and Statistical*, London, 1844-49; Jonathan Pini, *Condition and Prospects of Ireland*, 1845; Gustave de Beaumont, *L'Irlande, Sociale, Politique, et Religieuse*, 1839 (English translation in the same year, and a 7th French edition in 1863); Hancock, *Report on the Supposed Progressive Decline of Irish Prosperity*, Dublin, 1863; J. M. Murphy, *Tracts: Industrial, Political, and Social*, 1870; Burke's *Letters, Speeches, and Treatises on Ireland*, edited by Matthew Arnold, 1881. Thom's *Irish Almanac* contains admirable digests of the parliamentary returns of the current years as well as other statistical tables compiled from original sources. (T. F. H.)

## PART II.—HISTORY.]

*Legendary History of Early Races*.—Circumstances were favourable in Ireland to the growth and preservation of ethnic legends. Among these favourable circumstances were the long continuance of tribal government, and the existence of a special class whose duty it was to preserve the genealogies of the ruling families, and keep in memory the deeds of their ancestors. Long pedigrees and stories of forays and battles were preserved, but under the necessary condition of undergoing gradual phonetic change according as the popular language altered. During many centuries there had been no conquest by foreign races to destroy these traditions; internal conquests and displacements of tribes confuse but do not eradicate traditions and pedigrees. When the Irish were converted to Christianity and became acquainted with the story of the deluge, the confusion of tongues, and the unity of the human race, the *súide* (sages) naturally endeavoured to fill up the gap between their eponyms and Noah. The pedigrees now began to be committed to writing, and, as they could for the first time be compared with one another, a wide field was opened to the inventive faculties of the scribes. The result has been the construction of a most extraordinary legendary history, which under the constant care of official *súide* acquired a completeness, fulness, and a certain degree of consistency which is wonderful. In the 11th and 12th centuries this legendary history was fitted with a chronology, and synchronized with the annals of historical nations. We may assume with confidence that a history of a group of tribes admittedly of diverse origins, consisting mainly of names of persons and battles transmitted by memory, must necessarily lack all proportion, not alone as regards absolute, but even as regards relative time; that personages and events may appear in the background that should be in the foreground, and the converse; nay, even that the same personages and events may figure at times and places far apart. Keeping these things in view, the *Lebar Gabhata*, or "Book of Invasions," a curious compilation, or rather compilations, for there are several editions of it, of the ethnic legends of Ireland, will help us to give the main facts of the early peopling of Ireland. Our guide records the coming of five principal peoples, namely, the followers of Partholan or Bartholomew, those of Nemed, the Firbolgs, the Tuatha Dé Danann, and the Scots or Milesians.

Partholan and his people came from Middle Greece, and landed at Inber Sceine, believed to have been the estuary

of Kenmare. After occupying Ireland for three hundred years, they died of a plague, and were buried at Tamelecht Muinteich Partholain, the plague Lecht or grave of Partholan's people, now Tallaght near Dublin. This race divided the coast into four parts, their leader having had four sons. Thirty years after the destruction of Partholan's people, a race arrived from Scythia under a leader called Nemed, in thirty ships, each containing thirty warriors. We are not told where he landed, but like Partholan's people Nemed died of a plague at the hill upon which Queenstown in Cork Harbour is situated, and which has on that account been called Ard Nemeid. At this time another people appear on the scene, the Fomorians. It is probable, however, that Fomorian was merely a name for all sea-coming enemies, and that they were not always the same race. The descendants of Nemed's people suffered much hardship from them, we are told, but at length succeeded in destroying the fortress of their leader Conan at Tor Inis, now Tory Island, off the coast of Donegal, and killing himself and his children; but Morc, another leader, having arrived soon after from Africa with sixty ships, a second battle was fought, in which both parties were nearly exterminated. Morc, however, escaped, and took possession of the country, while of the Nemedians only the crew of one ship, having the usual number of thirty warriors—among whom were three descendants of Nemed himself—escaped. Each of the three descendants of Nemed went to a different country, and became the eponym of an important race. The five chiefs of the Firbolgs, the next colonizing race, appear to have landed at different places; one party, that of the Fir Galeons, landed at Inber Slangi, so called from their leader Slangi, whose name is still preserved in the river Slaney; another tribe, the Firbolgs, who gave their name to the collective tribes, arrived at what is now Erris in Mayo; and a third section, the Fir Domnaid, landed at Tracht Rudraide in Ulster, so called from their leader Rudraide, or rather Rud. All these tribes seem to have been British, a view which is confirmed by their chief fort being Dind Rig, the duu or fort of the kings on the Barrow in Carlow, afterwards the seat of the kings of Leinster, a province which appears to have always had a close relationship with Britain. The Firbolgs had only effected settlements in the country, but had not brought the whole of it into subjection before the arrival of a new tribe called the Tuatha Dé Danann. According to the Nemedian legend, this new



tribe was the race of Iboth, grandson of Iarboneil the prophet, son of Nemed. The new-comers under a king called Nádú demand the sovereignty of the country from the Fírbolg-king Eochaid Mac Erea, who refuses, and thereupon they fight a battle at Mag Tuired Conga, now Moytura near Cong in the county Mayo, the site of which is still traditionally remembered, and many graves belonging to the period of cremation have been found there. The Fírbolgs were worsted in this battle, and, as in all ethnic legends, almost annihilated, and the remainder driven out of the country.<sup>1</sup> Thirty years after the conquest of the Fírbolgs, the Tuatha Dé Danann fought a great battle with the Fomorians at another Mag Tuired, which is distinguished from that of Cong by being called the Northern. Its site is placed by tradition near Lough Arrow on the borders of Sligo and Rosecommon, at a place where many graves and pillar-stones still exist.

The last of the prehistoric races of Ireland are the so-called Milesians or Scots. The immediate eponym of the new race was Galam from *Gal*, "valour," a name which might be expressed by the Latin *miles*, a "knight," whence came the names Milesius and Milesians. Among the names which appear in the pedigree, which is of course carried back without a break to Noah, are several worthy of the attention of archaeologists,—namely, Breogan or Bregán, Eber Scot, Góedal Glas, Fenius Farsaid, Allait, Nádú, Sru, and Esru. Breogan, according to the legend, was the grandfather of Galam or Milesius, who founded Brigantia in Spain.

With all their drawbacks, the Irish ethnic legends, when stripped of their elaborate details and Biblical and classical loans, express the broad facts of the peopling of Ireland, and are in accordance with the results of archaeological investigation. At the earliest period the country was well wooded, and the interior full of marshes and lakes; it was occupied by a sparse population, who appear in later times as "forest tribes" (Tuatha Feda), and were doubtless of the aboriginal (Iberic) race of western and southern Europe. The story of Partholan represents the incoming of the first bronze-armed Celts, who were a Goidelic tribe akin to the later Scots that settled on the sea-coast, and built the fortresses occupying the principal headlands. They formed with the forest tribes the basis of the population in the Early Bronze age. Afterwards came the various tribes known by the general name of Fírbolgs. It is not necessary to suppose that all the tribes included under this name came at the same time, or even that they were closely akin. The legend names several tribes, and tells us that they came into Ireland at different places from Britain. The effect of their immigrations now appears to have been that in the north the people were Cruithni, or Picts of the Goidelic branch of the Celts; in the east and centre, British and Belgic tribes; and in Munster, when not distinctly Iberic, of a southern or Gaulish type.

The fertile plain lying between the Wicklow and Carlingford mountains, and especially the part of it south of the Boyne (Mag Ereg), was open to tribes coming from the opposite coast, and has accordingly been at all times a landing place of invading tribes. This region was occupied by the tribe of Nemed before the arrival of the Fírbolgs, if we believe the legend; but the event certainly belongs to a later period, though still to the time of the movements and displacement of peoples which led to the immigration of those tribes. The Fomorians, with whom, the Nemedians fought, may have been merely some of those incoming

tribes. The Irish legend brings the Nemedians from the east of Europe, which of course only means that they came from a distance, perhaps from Armorica or some other part of Gaul. Nemed's tribes were probably the builders of the tumuli of Meath, and the introducers of the worship of Dia and Ana, in other words, they were the mysterious Tuatha Dé Danann ("tribes of Dia and Ana"). Nemed was probably only another name for Dia, and his wife was Macha, an appellation of Ana. The name Nemed itself is of great interest, for it is evidently connected with *nem*, heaven, used also in the secondary sense of a sacred object upon which oaths were sworn.

The Milesian legend seems to consist of two or perhaps of three events. Eber and Erimon, two sons of Galam, or Milesius, the leaders of the invading forces, fight a battle at Slíab Mis in western Kerry with Eriu, the queen of Ceitheoir or Mac Gréne, "the son of the Sun," one of the three joint kings of the Tuatha Dé Danann, whom they defeat. Eber or Heber then marches to Taiti in Meath; while his brother Erimón or Heremon sails round to the mouth of the Boyne, where he lands and marches to meet his brother advancing from the south. This skilful strategic movement betrays the late invention of the legend. The first fact that underlies the story is the incoming of some powerful and well-armed tribe who seized upon the plain between the Liffey and the Boyne, and made it the centre of an encroaching power. The eponym of this tribe was Erimon, a name foreign to the pantheon of the tribes of Dia and Ana.<sup>2</sup> The new tribes arrived in Ireland towards the close of the prehistoric period, and not long before the beginning of the Christian era, or possibly as late as the first century of it. They were Goidelic, and were related to the dominant clans of Munster, and the Clanna Rudraide or Ulster clans, though perhaps not so closely to the latter as to the former. When the sons of Galam had defeated the kings of the tribes of Dia and Ana, they partitioned Ireland between themselves and their kinsmen. Erimon got Leinster and Connaught; Eber Find, his brother, North Munster; Lugaid, son of Ith, brother of Galam, South Munster; and Eber, son of Ir, son of Galam, the progenitor of Rud or the Rudraide, the immediate eponym of the Ultonians, Ulster. Eber Find, the leader of the north Munster tribes, and Lugaid of the South Munster ones, were grandsons of Breogan, the stem-father of all the new tribes. A long struggle took place between their descendants, in which those of Eber Find ultimately gained the upper hand, and the descendants of Lugaid were gradually pressed into a corner of the county of Cork. This struggle and the position of the tribes of Eber in the plain of Munster seem to show that the latter were, what the legend pretends, a part of the incoming tribes which we shall henceforward call Scots, and which landed, not in Kerry, but in Meath. The places supposed to have derived their names from the forty captains of the invading Scots, such as the plain of Brega, Slíab Cualand, &c., are all in that part of Ireland already spoken of as the landing place of invading tribes, or in the great central plain stretching west and south-west from it. There seems little doubt that these clans of Breogan or Scots were closely related to the Brigantes, perhaps they were even tribes of that great clan. The Brigantes who occupied the basin of the Barrow and Nore, and ultimately the county Waterford, according to Ptolemy,

<sup>1</sup> They were, however, only subdued, for long after there were Fírbolg-kings, of Olbegmacht (the ancient name of Connaught), and the people were very numerous in Ireland in St Patrick's time; indeed, it is probable that they then formed the largest element of the population.

<sup>2</sup> Herr Mannhardt connects Erimon with Irinc or Irmin, a god or divine hero of the Germans, and both with Aryamo (Aryamán), the deified ancestral king of the Hindus, who ruled Elysium, and whose path was the Milky Way. He also thinks that these words as well as Eriu contain the same stem as Aryan, and that consequently Aryamo may have been at one time the national god of all Aryans. Some curious particulars might be added here respecting Donn, the brother of Eber and Erimon, which appear to give great interest to this hypothesis.

support this view. The clan of Lugaid, grandson of Brocán, is almost certainly that which used the Ogam inscribed stones, the last that came into the country, and with which originated the story of the migration from Spain.

*The Scoti.*—The opening of the historic period was marked by a great struggle of tribes, which took place about the beginning of the Christian era, and of which Irish annalists have left us but very scanty information, and that confused and misleading. This struggle was brought about by the arrival from abroad of a new tribe, or the rise of an old one. The former view seems the more probable, for at that time great displacements of the Celts were taking place everywhere consequent on the conquests of the Romans, and some of the displaced tribes may have migrated to Ireland. The victors in the struggle appear afterwards as Scots; the conquered tribes are called *Aithech Tuatha*, that is, vassal tribes, because they paid *daer* or base rent. The names of the free and servile clans have been preserved, and were first published by the present writer.<sup>1</sup> The former consisted of forty-six tribes, among them being the Scotraige or Scotraide. This tribe probably took a foremost place in the subsequent invasions of Britain; and, it having thus acquired the leadership of the free clans, the latter became all known to foreigners as the Scoti, a name which was subsequently extended to the whole people. That this was the way in which the name was first given is shown by its not having been used in Irish, but only in Latin documents. The ending *-raige* or *-raide* is a patronymic.

In the struggle between the free and servile tribes the latter appear to have succeeded in throwing off the yoke of the free clans or Scots, but after some time the latter, under the leadership of Tuathal, called *Techtnar* or "the Legitimate" (*ob. cir.* 160 A.D.), recovered their power and took effective measures to preserve it by making some kind of redistribution of the servile tribes, or more probably making a plantation of Scots among them, and building fortresses capable of affording mutual aid. The duns and raths on the great central plain of Ireland to which Tuathal's measure was probably confined appear to have been erected on some strategic plan of this kind, intended to keep up a chain of communication, and prevent the combination of the servile classes. Tuathal in fact founded a kind of feudal system which ruled Ireland while the Scotie power endured.<sup>2</sup>

Another measure of Tuathal was the formation of the kingdom of Meath to serve as mensal land of the Ard Ri or over-king. Before his time there was, according to legend, a district about the sacred hill of Usnech called *Mide*, that is, "the middle," the religious centre of the Irish; this Tuathal enlarged by taking from each of the four provinces—the two Munsters being reckoned as one—a tract of land. In the Munster portion he built his Dun of Tlachtga, a sacred place of the Druids, now called the Hill of Ward, near Athboy. Usnech was considered to be in *Ólnegmacht* (Connaught). *Tailti* (*gen.* *Tailtenn*, now *Teltown*) was his Ulster residence, and *Temair* or *Tara* the Leinster one. Tuathal made each of those places

a religious centre for the province from which it had been taken.<sup>3</sup> He was thus not only the founder of the central monarchy, but also it would seem the organizer of the religious system of the people, which he used as a means of securing the allegiance of their princes by holding their chief shrines in his power, while leaving them the rents derived from them. An act of Tuathal, which marks his power, and the firm grasp which he had secured over the country, was the infliction of a heavy fine on the province of Leinster, a legend tells us, for an insult offered to him by one of its kings. This fine, called the *Boróim Laigen* or Cow-tribute of Leinster, was levied until the 6th century, when at the instance of St Moling it was remitted by the monarch *Finachta*. It was a constant source of oppression and war while it lasted, and helped to cripple the power of Leinster. Several attempts were made to reimpose it, among others by the celebrated *Brián*, who, according to some, derived his surname of *Borúma* from this circumstance. To carry out his measures of conquest and subjugation, Tuathal is credited with having established a kind of permanent military force which afterwards became so celebrated in legendary story as the *Fiann* or *Fenians*. He may have seen Roman troops, and attempted as far as his circumstances would permit to form a military tribe organized somewhat after the manner of a legion. Among the other measures attributed to Tuathal was the regulation of the various professions and handicrafts. The former he must necessarily have done as part of his religious organization, for the various professions were exactly the grades of the Druidical hierarchy.

*The Rival Kingdom of Munster.*—If we accept the story of the plantation of the broken *Aithech Tuatha*, Tuathal's power must have extended over the whole country; but it was practically confined to Meath and Leinster, and perhaps *Ólnegmacht*. *Ulaid* was independent. In Munster the clan of *Degaid* had conquered a large tract of country in the middle of the province, and forced the clan of *Dergtind* or descendants of *Eber* into the south-west of *Cork* and *Kerry*. The origin of the clan of *Degaid* is obscure; one story makes it *Ultonian*, and the other *Erimonian*. The latter is probably the true one, for among the free clans associated with the Scotraige in the war of the *Aithech Tuatha* was a tribe called *Coro Dega*, which seems to be the one we are now discussing. The clan of *Degaid*, having dispossessed a non-Scotic tribe called the *Ernaans*, were themselves afterwards known by that name. From their peculiar position in the south they must have acknowledged the supremacy of Tuathal and his successors. In the reign of *Cund*, surnamed "of the Hundred Battles," grandson of Tuathal, the clan of *Degaid* had succeeded in getting the upper hand of the clans both of *Eber* and *Lugaid*; and *Munster*, now divided into three

<sup>3</sup> Thus the great Druidical festival of *Samuin* (now *Allhallowtide*), on which occasion all the hearths in *Munster* should be rekindled from the sacred fire, and for which a tax was due to the king, was celebrated at *Tlachtga*. At *Usnech*, now the hill of *Usnagh* in *Westmeath*, the festival of *Beltaine* was celebrated in the month of *May*. The horse and garments of every chief who came to the festival formed part of the toll of the king of *Ólnegmacht*. At *Tailti* a great *Oenach* or fair was held at certain intervals: on the first of *August*, at which was celebrated the *Lugnasad*, the games supposed to have been established by *Lugaid* of the *Long Arm*, one of the gods of *Dia* and *Ana*, in honour of his foster mother *Tailti*. Here for the first time Tuathal erected a dun, thus securing possession of the shrine of the *Ulaid*, to the king of which the rents of the fair belonged. These consisted chiefly in a fine due for each marriage celebrated there. At *Tara*, the principal residence, he established the *Feis Temrach* or *Feast of Tara*, which was a general assembly of the provincial and other subreguli of *Ireland* who came to do homage to the ard ri or over-king. This feast continued to be held from Tuathal's time to 554 A.D., when the last was held by *Diarmait*, son of *Cerball*. The establishment of this feast is also attributed to the prehistoric king *Eochaid Ollam Fota*, which implies that Tuathal merely re-established it.

<sup>1</sup> In *O'Curry's Manners and Customs of the Ancient Irish*, Introduction, vol. i. p. xxvii.

<sup>2</sup> The *Aithech Tuatha*, or servile tribes, have been identified by some antiquarians with the British tribes known as *Attacotti*. The ground of this surmise is the resemblance of the names. Although the explanation we have given of the name is satisfactory, it is right to state that among the servile tribes there was one called the *Tuath Aithechta*, which might have given its name to the whole of the servile tribes, as the Scotraige gave theirs to the "free clans." This tribe was seated on the sea-coast near the *Liffey*, and there is nothing improbable in the notion that when beaten they may have crossed over to *Britain*, where they became known as *Attacotti*, and were associated with the Scots in their devastations of the Roman provinces.



petty kingdoms, was ruled over by three princes of that family. A chief of the Eberians named Eogan, better known as Mug Nádát,<sup>1</sup> by the aid of his foster-father the king of Leinster, succeeded in defeating the Degaidian princes and driving them out of Munster. The latter asked the aid of Cond the over-king, who took up their cause, and a fierce war arose, in which Cond was beaten and compelled to divide Ireland with his rival. The boundary line ran from the Bay of Galway to Dublin along the great ridge of gravel which stretches across Ireland. The northern part was Leth Cuind or Cond's Half, and the southern part Leth Moga or Mug's Half. By this arrangement the present county of Clare, which had hitherto belonged to Olnegmacht, was transferred to Munster, to which it has ever since belonged. It was about this time too that the former province received the name Connacht, now Connaught, from the name of King Cond. In the wars between Mug Nádát and Cond a considerable number of foreigners are said to have been in the army of the former, among whom are specially named Spaniards. Perhaps these foreigners represent the tribe of Lugaid, and this was really the period of the arrival of that tribe in Ireland out of which grew the Milesian story. The earliest of the Ogam inscriptions are perhaps of this date, and support the view just stated.

Mug Nádát must have been an able man, for he established his race so firmly that his descendants ruled Munster for a thousand years. He seems to have been as politic as warlike, for we are told he stored corn to save his people from famine. He was also enabled to give some to many chieftains who in a tribal community had no such forethought, and thus made them his vassals. His success, however, created a rivalry which lasted down to the final overthrow of the native government, and led to constant war and devastation, and mainly contributed to the final overthrow of the central monarchy. Although Munster remained nominally in subjection to that power, it was thenceforward in reality an independent kingdom, or rather federation of clans under the king of Cashel.

*Scotic Conquest of Ulster.*—If the Scots failed to subdue the south thoroughly, they succeeded in crushing the Ultonians, and driving them ultimately into the south-eastern corner of the province. One of Cond's successors, Fiacha Srabtime, was slain by his nephews, known as the three Collas, one of whom, called Colla Úas, "the noble," became king about 327; but after a reign of four years he and his brothers were driven out of Ireland. They took military service with their maternal grandfather, a certain Ugari, called king of Alba. After three years in this position they returned to Ireland, and succeeded in making peace with their cousin Muiredach Tirech, who became king after the banishment of Colla Úas. The Ard Rí, in order to give them employment, recommended them to carve out territories for themselves among the Ulaid. Finding an excuse in an insult offered to their grandfather, King Cormac, son of Art, they invaded Ulster, plundered and burned Emain Macha, the ancient seat of the kings of the Ultonians, and made "sword-land" of a large part of the kingdom, which was afterwards known as Airgéill or Oriel. Afterwards the sons of the celebrated Niall of the Nine Hostages, the most powerful monarch of the Scotic dynasty after Tuathal, also carved out principalities for themselves in Ulster which bore their names for centuries:—Tir Conaill, or as it was called in English Tyrconnel, the land of Conall, and Tir Eogain, the land of Eogan, from which has come the name of one of the Ulster counties, Tyrone.

<sup>1</sup> That is, the slave or servant of Nádú, one of the chief gods of the Góedel.

*Invasions of Britain by the Irish.*—Constant allusions are made in the legends of the prehistoric kings to warlike expeditions to Alba. In the legends of the heroic period an expedition to the Isle of Man forms the subject of one of the tales, in which Cúruí Mac Dáiri, of the clan of Degaid, king of West Munster, accompanied by Cnechulaind, carries off Blathnath, daughter of the king of Man. Crimthand, surnamed Nar's Hero, a prehistoric king just preceding the Aithech Tuatha war, brought back many trophies from abroad which are celebrated in legend. The Annals of the Four Masters, quoting the Annals of Tigernach, tell us at the year 240 that Cormac, son of Art, and grandson of Cond, sailed across the sea and obtained the sovereignty of Alba. This Cormac was a noteworthy king, who ruled with much state at Tara from about 254 to 277 A.D. He is said to have introduced water-mills into Ireland, and to have established schools for the study of law, military matters, and the annals of the country. Laws attributed to him continued in force all through the Middle Ages. A book of moral precepts for the guidance of princes, called *Tecose na Rígh*, is attributed to him, a copy of which occurs in the Book of Leinster, a MS. of the 12th century. Another work compiled under his direction, and containing what may be called the history and geography of Ireland, has unfortunately not survived. He was the enemy of the Filid, owing it is said to his having learned something of Christianity in his expeditions. It was, however, during the reign of Crimthand son of Fidach (366-379) and of his successor Niall of the Nine Hostages (379-405) that the Irish invasions of Britain acquired for the first time historic importance. The former was a Munster prince, the most powerful of his race, and the only Eberian prince who was king of Ireland until Brian Boruma (1002). His successor Niall was also the most powerful of the rival race of the Erimonian Scots.

There appear to have been three distinct settlements of Irish tribes in Britain:—(1) of Munster tribes in South Wales, Devonshire, and Cornwall; (2) of Erimonian Scots in the Isle of Man, Anglesey, and other parts of Gwynedd or North Wales; and (3) of the Erimonian Scots, called the Dal-Riada. The Cruithin or Picts of Galloway seem to have been a fourth settlement, but definite evidence on this point is wanting. The first invasion and the extent of the settlement of the Irish in south-west Britain are established by the Ogam inscriptions, and there is other proof besides. The most important piece of Irish evidence is the article "Mug-Éime" in Cormac's *Glossary*, which gives a legend of the introduction of the first lap-dog into Ireland. "Mug-Éime, that is the name of the first lap-dog that was in Ireland. Cairpre Músc, son of Cenane, brought it from the east from Britain; . . . for when great was the power of the Gael on Britain, they divided Alba between them into districts, and each knew the residence of his friend, and not less did the Gael dwell on the east side of the sea quam in Scotia, and their habitations and royal forts were built there. Inde dicitur Din Tradni, i.e., triple-fossed fort of Crimthand the Great, son of Fidach, king of Ireland and Alba to the Ictian Sea, i.e., west of Glastonbury of the Gael, i.e., a church on the border of the Ictian Sea (the English Channel) . . . . And it is in that part is Innra map Lethain in the lands of the Cornish Britains, i.e., the fort of Mac Liathain, for *Mac* is the same as *Map* in the British. Thus every tribe divided on that side for its property to the east was equal [to that on the west], and they continued in this power till long after the coming of Patrick." The Cairpre Músc here mentioned was son of Coaire, soo of Mug Láma, of the Degaidian race of Munster, and his visit to Britain took place during the reign of Cormac, son of Art, and when Aillil Flaith Béag was king of Munster. As the latter began his reign about 260 A.D., and the former died about 277, the visit lies between those dates. It appears therefore that the occupation of south-west Britain by the Munster Góedel began at least a century earlier than Crimthand's time. The reference to the occupation of Cornwall is curiously corroborated by the story of Tristan and Ysente, in which Moraut is sent by the king of Ireland to collect tribute from the king of Cornwall. British and Welsh records are equally explicit about this occupation. The earliest edition of the *Historia Brittonum* (represented by the Paris MS.) dates from 675, according to the Rev. D. Heigh, who attributes its authorship to Gildas, and gives the date of its composition as 471. If we were certain that we had Gildas's work we should have almost contemporaneous evidence, but, whoever wrote the work in question, the actual MSS. are of such antiquity that their authority on the point we are discussing is of great value. The passage referring to South Wales is as follows:—"But the sons of Liethan possessed the country of the Demetians (Dyfed), and other provinces Gnoher (Gower) and Cetguchi (Kidweli), until they were expelled by Cunedda and his sons from all British territories." This statement bears out that taken from Cormac respecting the name of the leaders of the Góedel in South Wales. The name Liethan is of great interest, because it is the eponym of an important Munster clan, the Húi Liathain, whose territory Cricil Liathain included the barony of Barrymore in the county Cork. The *Historia Brittonum* further tells us that Cunedda and his eight sons came from a region in the north called Manau Gnotodin, probably about the end of the 5th century. The Welsh traditions referring to the

Goidelic occupation of Britain, though contradictory and irreconcilable in their chronology, confirm all that we have said.

Camden, Edward Lhuyd, and others pointed out a Goidelic element in the topographical nomenclature of west Britain, and concluded that the country was once occupied by the Góedel, whence they were driven into Ireland by the advancing Cymri. This was a natural and reasonable conclusion at the time. But our present knowledge compels us to adopt a different view, namely, that, without prejudice to the existence at an anterior period of Goidelic tribes in west Britain, the numerous traces of Goidelic names found there are derived from an Irish occupation in historic times. The Rev. W. Basil Jones (now bishop of St Davids), who by his valuable book, *Vestiges of the Gael in Gwynedd* (North Wales), has so largely contributed to our knowledge of this subject, came to the conclusion that the Irish occupied the whole of Anglesey, Camarvon, Merioneth, and Cardiganshire, with a portion at least of Denbighshire, Montgomeryshire, and Radnorshire. The same tribes who occupied Anglesey and Gwynedd also occupied the Isle of Man, which, as is well known, was an Irish possession before the Norse invasion. Its colonization is attributed to Manuand, son of Lér, a sea-god of the tribes of Dia and Ana, and who is associated in the *Mabinogion*<sup>1</sup> with Gwydion ap Donn and other deities. It would appear that the first occupation of Man, Mona, and Gwynedd took place before the dominance of the Scots, or was the work of Ultonians. But the subsequent importance of Gwydion ap Donn and Arianrod shows that the Erinouian Scots were afterwards the dominant element. South Wales was undoubtedly occupied by South Munster tribes, so that we have the curious historical phenomenon presented in Wales as in Ireland of Mug's Half and Cood's Half. The explanation of this as well as of the occupation itself is no doubt the pressure of the clan of Degaid and other Scotie tribes upon the tribes of Lugaid,<sup>2</sup> causing the greater part to emigrate. By the aid of these emigrants, who had become better armed, Mug Nádat and his successors on the Munster throne were enabled to recover their possessions in Munster again. It was no doubt by their help that Lugaid Mac Cuiud of the South Munster clan succeeded in defeating Art, the son of Coad of the Hundred Battles, and becoming king of Ireland. The occupation of North Wales was probably due to a similar pressure of the Scots upon the Ultonians.

We have said that there was probably a fourth settlement of Irish in Britain, but that we had no definite information on the subject. The position of the Goidelic population in Galloway is, however, so peculiar that we have no hesitation in saying that it is derived from an emigration of Irish Cruithni or Piets in the first half of the 4th century, consequent on the Scotie invasion of Ulster. Before that period small settlements of Scots had already taken place, one of which is of very great historical importance. Couaire, son of Mug Láma, the successor of Coad of the Hundred Battles as king of Ireland (from about 212 to 220 A.D.), had three sons, who, like the later Collas, carved out principalities for themselves in different parts of Ireland. These were—Cairpre Musc, from whom six territories in Munster were called Muscraige, which has been Anglicized Muskerry; Cairpre Baiscinn, who is said to have been the stem of the tribe of Corco Baiscinn in the west of the county Clare; and Cairpre Riata, who acquired a territory in the north-east of the county Antrim, called Dal Riata or Dal Riada (which is to be distinguished from Dal Araide, the country of the Cruithni or Ultonians), a name which still survives in the local name "the Route." It is probable that Cairpre Riata or some of his immediate successors passed over into Alba, and acquired territory also there. Bede is the earliest authority for such a migration. Speaking of the inhabitants of Britain, he says:—"In process of time Britain, besides the Britons and the Piets, received a third nation, the Scots, who migrating from Ireland under their leader Reula, either by fair means or by force of arms secured to themselves those settlements among the Piets which they still possess. From the name of their commander, they are to this day called Dalreudins; for in their language *dal* signifies a part." Bede derived his information from some of the Columban clergy, and knew nothing of Wales, and therefore of any previous settlements of the Irish. About three hundred years after the first settlement a body of the Irish Dalriads of Antrim went to Alba, under the leadership of Fergus Mór, son of Ere, and his brothers, and founded on the basis of the previous colony a new Dal Riata, which became known as Aier Góedel or region of the Gael, a name now pronounced Argyle. This petty kingdom ultimately developed into the kingdom of Scotland, and appropriated to itself the name of the mother country, or at least that which was its Latin name.

The Roman historians are usually assumed to represent that the Scots taking part in the attacks on Roman Britain all came like

the Piets from the north. But Ammianus expressly states that the Piets, Atticotti, and Scots arrived by different ways (per diversa vagantes). The basis of the Scotie attacks was their settlements in Wales and south-west Britain, which afforded protection to the invading forces arriving from Ireland in their hide-covered wicker boats. Argyle may also have served as a point from which to send out piratical expeditions. The Irish Piets or Ultonians who had settled in Galloway, and who with their kinsmen in Ireland were the Gwyddel fichti of the Welsh, must have also joined in the fray,—their position near the Solway giving them unusual facilities.

*Conversion of the Scots to Christianity.*—In the beginning of the 4th century there was an organized Christian church in Britain, for there were British bishops at the council of Arles in 314 A.D., one of whom was probably from Wales. At that time the Irish had possession of many places in west and south Britain, and must have come in contact with Christians. These were more numerous and the church better organized in South Wales and south-west Britain, where the Munster or southern Irish were, than in North Wales, held by the Scots proper. Christianity may have therefore found its way into Munster some time in the 4th century. This would account for the existence of several Christian Scots before St Patrick, such as Pelagius the heresiarch and his disciple Coelestius, one of whom was certainly a Scot, and Cælius Sedulius (in Irish Siadal or Siudal) the Christian poet, who flourished in Italy about the end of the 4th and beginning of the 5th century. There is a story of four bishops who, with several priests and anchorites, lived in Munster before the mission of St Patrick, which was credited by such high authorities as Colgan and Ussher, but later inquiries have shown that most if not all these either were contemporaries of St Patrick or belonged to a later time. But, although it is almost certain that no organized church existed in Ireland before the mission of St Patrick, there may have been several scattered communities in the south of Ireland. This might explain the words of St Prosper of Aquitaine in recording the mission of St Palladius in his chronicle for the year 431:—"Palladius was ordained by Pope Celestine and sent as first bishop to the Scots believing in Christ." His mission arose out of the visit of St Germanus of Auxerre to Britain. According to Constantius of Lyons, the contemporary and biographer of Germanus, the British bishops, alarmed at the rapid progress of Pelagianism in Britain, sought the aid of the Gaulish Church; a numerous synod summoned for the occasion commissioned Germanus and Lupus to go to Britain, which they accordingly did in 429, according to the usual reckoning. Prosper of Aquitaine on the other hand attributes the mission of Germanus to the pope, and makes no mention of the action of the Gaulish bishops; but he adds that it was done through the action of the deacon Palladius. There is nothing inconsistent in the two accounts, for the acts of the council were probably sent to the pope by a special messenger, who was Palladius. The latter was probably a Briton, but of the Gaulish family of the Palladii. Ammianus Marcellinus mentions a Palladius holding high office in Britain in the middle of the 4th century. Palladius was probably the envoy of the British bishops both to Gaul and to the pope. If he was a Briton, he would naturally have been anxious for the conversion of the Irish as the most effectual way of stopping the Scotie incursions, and was therefore a fitting person to be selected for such a mission. Our information about Palladius is derived from the various lives of St Patrick, of which seven have been printed by Colgan. The earliest of these are the two in the Book of Armagh, a MS. of about the year 800 A.D.; one is by Murchú Macenmachtein, the latter part of the name being the equivalent of the "son of Cogitosus," and was compiled at the suggestion of Aed, bishop of Sletty, who died about the year 698; and the other is known as the Annotations of Tirechan. According

<sup>1</sup> On the Goidelic character of the *Mabinogion* see CELTIC LITERATURE, vol. v. pp. 321, 322.

<sup>2</sup> Lugaid, the eponym of the South Munster tribes, which occupied South Wales and Cornwall, appears to be the Loucetio, a war god, who is associated with a local goddess Nemetona on an inscription found in Cornwall (*c.f.*, Nemon, the Irish goddess of war, wife of Néit).



to Murchú's account, Palladius failed in his mission, and on his way back died in the country of the Britons. Tirechan says that Palladius, who was also known by the name Patricius, suffered martyrdom among the Scots. The second life in Colgan's collection and the fifth of the same series, which is by Probus, agree with Murchú's except that they make him die in the country of the Picts. The other lives give more details, as is usual in all the later acts of saints. The general statement that he died in Pictland is changed into the special one that he went to Mearnes and died, or, as some say, was martyred in Mug Gerginn at a place called Fordua in the east of Scotland. This of course is a late invention, and may have arisen from a confusion of the names of places in Ireland with similar ones in Britain. There was a Pictland in Ireland, namely, Dal-Araide, and, as we learn from the story of a prince Cano, a place named from a certain Gergiud (genitive form) somewhere in it. This may be the place referred to. There was also the Pictland of Galloway, which would be on his way from the north of Ireland to the Roman Britons.

The death of Palladius is assumed to have taken place in 431 and the mission of St Patrick to have begun in the following year. Our knowledge of the Irish apostle is, however, so contradictory and unsatisfactory that no reliance can be placed on any dates connected with him. In any case, when we remember the time and the state of Europe, it is not at all likely that the place of Palladius could be so rapidly supplied as the above dates make out. While there are many lives of the saint, these are rather legendary than historical biographies (see PATRICK). But although there is much obscurity and confusion in the Acts of St Patrick, there cannot be the slightest doubt of his real existence. He was thoroughly acquainted with the people of Ireland, and consequently knew that he should secure the chief in order to succeed with the clan, and this is what he did. At first the conversion was only apparent, but, although the mass of the people still continued practically pagans, the apostle was enabled to found churches and schools, and educate a priesthood, and thus provide the most effective and certain means of converting the whole people. He was undoubtedly a great missionary, full of zeal but withal prudent, and guided by much good sense. The learned Tillemont, judging Patrick by the writings attributed to him, truly says that he had much of the character of St Paul, and was well read in Scripture. It would be a mistake to suppose that his success was as rapid or as complete as is generally assumed. On the contrary, it is fully apparent that he had much hard work, and ran much danger, that many chiefs refused to hear him, and that much paganism still existed at his death. That this should be so was no doubt an inherent defect of his system; but on the other hand by no other system could so much real work have been done in so short a time, and that too, so far as we can make out, almost by his own unaided efforts.

*The Early Irish Church.*—The church founded by St Patrick was identical in doctrine with the churches of Britain and Gaul, and other branches of the Western Church. There is no evidence that the Pelagian heresy found an entrance there, and least of all is there the slightest foundation for the supposition that it had any connexion with the Eastern Church. Its organization was, however, peculiar; and, as countries in the tribal state of society are very tenacious of their customs, the Irish Church preserved these peculiarities for a long time, and carried them into other countries, by which the Irish were brought into direct collision with a different and more advanced church organization. Wherever the Roman law and municipal institutions had been in force, the church society was modelled on the civil one. The bishops

governed ecclesiastical districts coordinate with the civil divisions. In Ireland there were no cities and no municipal institutions; the nation consisted of groups of tribes connected by kinship and loosely held together under a graduated system of tribal government. The church which grew up under such a system was organized exactly like the lay society. When a chief became a Christian and bestowed his *don* and his lands upon the church, he at the same time transferred all his rights as a chief. But though by his gift the chief divested himself of his rights, these still remained with his sept or clan, though subordinate to the uses of the church; at first all church offices were exclusively confined to members of the sept or of the clan according as the gift emanated from the head of the one or the other. In this new sept or clan there was consequently a twofold succession. The religious sept or family consisted, in the first instance, not only of the ecclesiastical persons to whom the gift was made, but of all the *Céli*, or vassals, tenants, and slaves, connected with the land bestowed. The head was the *comarba*, that is, the co-heir, or inheritor both of the spiritual and temporal rights and privileges of the founder; he in his temporal capacity exacted rent and tribute like other chiefs, and made war not on temporal chiefs only,—the spectacle of two *comarpi* making war on each other being not unusual. The ecclesiastical colonies that went forth from a parent family generally remained in subordination to it in the same way that the spreading branches of a secular clan remained in general subordinate to it. The heads of the secondary families were also called the *comarpi* of the original founder of the religious clan. Thus there were *comarpi* of Columcille at Hi, Kells, Durrow, Derry, and other places. The *comarba* of the chief family of a great spiritual clan was called the *ard-comarba* or high *comarba*. The *comarba* might be a bishop or only an abbot, but in either case all the ecclesiastics of the family were subject to him; in this way it frequently happened that bishops, though their superior functions were recognized, were in subjection to abbots, who were only priests, nay, even to a woman, as in the instance of St Brigit. This singular association of lay and spiritual powers was liable to the abuse of having the whole succession fall into lay hands, as happened to a large extent in later times. This has led to many misconceptions of the true character and discipline of the Irish mediæval church. The temporal chief had his steward who superintended the collection of his rents and tributes; in like manner the *comarba* of a religious sept had his *airchinnech* (usually written in Anglo-Irish documents *Erenach* and *Herenach*), an office which has given rise to many erroneous views. The name was supposed to be a corruption of *Archidiaconus*, but this is not so. The office of *airchinnech* or steward of church lands was generally but not necessarily hereditary; it embodied in a certain sense the lay succession in the family.

From the beginning the church of St Patrick was monastic, as is proved by a passage in his *Confessio*, where, speaking of the success of his mission, he says: "The sons of Scots and daughters of chiefs appear now as monks and virgins of Christ, especially one blessed Scottish lady of noble birth and of great beauty who was adult, and whom I baptized." But the early Irish monasticism was unlike that known at a later period. An Irish *coenobium* of the earliest type was simply an ordinary sept or family whose chief had become Christian, and making a gift of his land either retired leaving it in the hands of a *comarba*, or remained as the religious head himself. The family went on with their usual avocations, but some of the men and women, and in some cases all, practised celibacy, and all joined in fasting and prayer. These communities offer many striking analogies with the Shaker communities of the

United States of America. A severer and more exclusive system of monasticism succeeded this primitive one, but its general character never entirely changed.

As all notions of diocesan jurisdiction as understood in countries under Roman law were unknown, there was not that limitation of the number of bishops which territorial jurisdiction renders necessary, and consequently bishops were very numerous. If we were to believe some of the legends of the early church, the bishops were nearly as numerous as the priests. St Mochta, abbot of Lugmad, or Louth, and said to have been a disciple of St Patrick, had one hundred bishops in his monastic family. All the bishops in a *cœnobium* were, as we have said above, subject to the abbot. Besides the bishops in the monastic families, every tuath or tribe had its own bishop. The church in Ireland having been evolved out of the monastic nuclei above described, the tribe-bishop was an episcopal development of a somewhat later period. He was an important personage, having a right to the same retinue as the *ri* or chief, and though we cannot define exactly the character of his jurisdiction, which extended over the tuath, his power was considerable, as we can judge by the conflicts which took place between them and the kings on that fertile source of dissension, the right of sanctuary. The tuath bishop corresponded to the diocesan bishop as closely as it was possible in two systems so different as tribal and municipal government. When diocesan jurisdiction grew up in Ireland in the 12th and subsequent centuries, the tuath became a diocese. Many of the old dioceses represent ancient tuatha, and even enlarged modern dioceses coincide with the territories of ancient clans. Thus the diocese of Kilmacduagh (Cell-Mac-n-Duach) was the territory of the Húi Fiachrach Aidline; that of Kilfenora (Cell Find abrach) was the tribe-land of Corco Modruaidh or Corcomroc. Many deaneries also represent tribe territories; thus the deanery of Musgrylin in the county Cork was the ancient Museraige Mitaine, and no doubt had its tribe-bishop in ancient times. It should be added that bishops without dioceses and monastic bishops were not unknown elsewhere in the church in early times, but had disappeared with very rare exceptions in the 6th century, when the Irish reintroduced the monastic bishops and the monastic church into Britain and the Continent.

In the 8th and 9th centuries, when the great emigration of Irish scholars and ecclesiastics took place, the number of wandering bishops without dioceses became a reproach to the Irish Church; and there can be no doubt that it led to much inconvenience and abuse, and was subversive of the stricter discipline that the popes had succeeded in establishing in the Western Church. They were also accused of ordaining serfs without the consent of their lord, consecrating bishops *per saltum*, that is, making persons bishops who had not previously received the orders of priests, and of permitting bishops to be consecrated by a single bishop. The latter could hardly be a reproach to the Irish Church, as the practice was never held to be invalid; and, besides, the Nicene canons of discipline were perhaps not known in Ireland until comparatively late times. The isolated position of Ireland, and the existence of tribal organization in full vigour, explain fully the anomalies of Irish discipline, many of which were also survivals of the early Christian practices before the complete organization of the church.

From the nature of the organization of the Irish Church as established by Saint Patrick, it was to be expected that on his death the bond between the numerous church families which his great authority supplied would be greatly relaxed. The Druidic orders too, which there is reason to believe remained still to a large extent pagan, and undoubtedly practised many of their arts even in the 7th century,

must have regained much of their old power. A tradition exists that at the instance of St Patrick the laws were purified by a commission of which he himself was a member, and collected into a body called the *Senchas Mór*. Nevertheless the pagan marriage customs were practised long after St Patrick's time. Sir Henry S. Maine has well observed that the Christian church did not succeed in substituting its ideas of morality and the canon law for the old natural customs of the Celts, Germans, and Slavs so easily or at so early a period as is usually assumed. It is known, for instance, that traces of sister-marriage still lingered among the south Germans of Bavaria in the 7th century. The transition period which follows the loosening of the faith of a people in its old religion, and before the authority of the new is universally accepted, is always a time of confusion and relaxation of morals. Such a period appears to have followed in the first half of the 6th century the fervour of St Patrick's time. Another cause, too, powerfully helped to produce and foster disorder. We have seen that from the 2d century, if not earlier, to the middle of the 5th century, the Irish youth betook themselves to piracy, and, like the later Scandinavian vikings, ravaged the coasts of Britain, and perhaps North Gaul, and made permanent settlements in the former. Christianity weakened the warlike and adventurous spirit of the Scots, and led to their expulsion from Wales about the end of the 5th century. The energy which the fierce Scotie youth expended in plundering expeditions when not engaged in intertribal feuds, having no outlet, helped, with the causes just stated, to produce internal disorders and relaxation of morals. This period of reaction after warlike and religious excitement has been magnified into an entire corruption of faith and morals, for which, however, there is no real evidence, and which is incompatible with subsequent events. That the survival of the Druids under the name of the grades or orders of Eena and Filidecht, which we may describe conventionally as bards, had much to do with the state of disorder we are discussing, is proved by the proposal of the king Aed, son of Ainmire, to get rid of them on account of their numbers and unreasonable and exorbitant demands. St Columcille, however, advocated a reform of the body, a diminution of their number, and the curtailment of their privileges; these proposals were adopted at the convention of Druimeeta in the north of Ireland, called together for this among other purposes.

The encroachments of the Saxons which forced the Cymri of the north into Wales, and the consequent driving out of the Irish from their possessions in Wales and south-west Britain, and the desolation and anarchy of the whole country, appear to have caused many British ecclesiastics to seek a refuge in Ireland, among whom was Gildas, who is said to have been invited over by King Ainmire. But, whether as an invited guest or as a refugee, Gildas certainly helped to reform the Irish Church, at least of Leth Cuind, or Cond's Half. The chief reform due to the influence of Gildas and the British Church seems to have been that effected in the monastic life, or rather we should say the introduction of monastic life in the strict sense of the word, that is, of communities entirely separated from the laity, with complete separation of the sexes. To this reformed church of the second half of the 6th century and early part of the 7th belong Columcille, Côm gall, and many other saints of renown, who established the schools from which went forth the missionaries and scholars who made the name of Scot and of Ireland so well known throughout Europe. During this period the energy of the youth of Ireland seems to have concentrated itself on religious asceticism and missionary work. St Columcille converted the Picts, and from his monastery of Hí went forth the illustrious Aedán to plant another Iona at



Lindsfarne, which, as Mr Hill Burton, the historian of Scotland, says, "long after the poor parent brotherhood had fallen to decay, expanded itself into the bishopric of Durham, or as some will have it the archbishopric of York itself; for of all the Christian missions to England that of Aidan seems to have taken the firmest root."<sup>1</sup> This was also the period of the great missionaries of the Continent, Columbanus, Gall, Killian, and many others. Nor had the old daring on the sea, which distinguished the Scotie adventurers who had ravaged the coasts of Britain, and which still characterizes the Celtic fishermen of the west of Scotland, the Isle of Man, Cornwall, and Brittany, and the colony of Newfoundland, died out among the Gael of South Munster, for besides St Brendán, whose voyages have given rise to a widespread myth, there was another navigator, Cormac, a disciple of St Columcille, who visited the Orkneys, and discovered the Faroe Islands and Iceland, long before the Northmen set foot on them. Other Irishmen seeking remote places to lead there the lives of anchorites followed in their tracks, and when the Northmen first discovered Iceland they found there books and other traces of the Irish of the early church.

The peculiarities which, owing to Ireland's isolation, had survived were, as we have said, brought into prominence when the Irish missionaries came into contact with Roman ecclesiastics. Those peculiarities, though only survivals of customs once general in the Christian church, shocked the ecclesiastics of the Roman school accustomed to the order and discipline which were everywhere being introduced into the Western Church. On the Easter question especially a contest arose which waxed hottest in England, and as the Irish monks stubbornly adhered to their traditions they were vehemently attacked by their opponents. This controversy occupies much space in the history of the Western Church, and led to an unequal struggle between the Roman and Scotie clergy in Scotland, England, the east of France, Switzerland, and a considerable part of Germany, which naturally ended in the Irish system giving way before the Roman. The monasteries following the Irish rule were supplanted by or converted into Benedictine ones. Owing to this struggle the real work of the early Irish missionaries in converting the pagans of Britain and central Europe, and sowing the seeds of culture there, has been overlooked when not wilfully misrepresented. Thus, while the real work of the conversion of the pagan Germans was the work of Irishmen, Winifred or, as he is better known, St Boniface, a man of great political ability, reaped the field they had sown, and is called the apostle of Germany, though it is very doubtful if he ever preached to the heathen. The southern Irish, who had been more in contact with the South British and Gauls, were the first to accept the Roman method of reckoning Easter, which they did in 633 A.D. In the north of Ireland, which was in connexion with the Columban church, it was adopted fully only on the community of Iona yielding in 716, one hundred and fifty years after the commencement of the controversy, while Wales only conformed, according to the Welsh annals, in 768.

*The Dynasty of the Húi Néill.*—Níall of the Nine Hostages had many sons, of whom eight became stem-fathers of important clans. Four—Loegaire, Conall Crimthand, Fiacc, and Maine—settled in Meath and adjoining territories, and their posterity were called the southern Húi or Hy Néill. The other four—Eogan, Enna Find, Cairpre, and Conall Gulban—like the three Collas before mentioned, went into Ulster and made sword-land of a large part of it. Their descendants were the northern Húi Néill. The territory of Eogan was known as Tir Eogain, which has survived in the county of Tyrone; that of Conall Gulban was called Tir Conaill (Tyr Connell) corresponding nearly to the present county of Donegal. The posterity of Eogan were the O'Neills and their numerous kindred sept; the posterity of Conall Gulban were the O'Donnells and their

kindred sept. Loegaire the son of Níall was succeeded by Aihill Molt, the son of Níall's predecessor Dathi. After a reign of twenty years (463-483) he was slain in the battle of Ocha by Lugaid, son of Loegaire. This battle marks an epoch in Irish history, for it made the posterity of Níall the dominant race in Ireland for five hundred years, during which the Húi Néill held the kingship without a break. The power of the Húi Néill over Munster, or indeed over any part of Mug's Half, which included Leinster, was, however, often only nominal. At this period the king of the southern half of Ireland was Oengus son of Natfraech, who is said to have been baptized by St Patrick. Whatever may have been the character of Oengus's religious belief, his wife Fíne "the Terrible" was a pagan. She was the daughter of a Druid, and used Druidical incantations in the battle in which she was slain with her husband. Yet this was the age of St Brigit, St Ailbe, and other saints, who were then laying the foundation of that monasticism which in the following centuries absorbed the intellect and the energy of the nation.

The first king of the southern Húi Néill was Diarmait, son of Fergus Mac Cerbaill (538-558). He undoubtedly professed Christianity, but still clung to many pagan practices, such as a plurality of wives and the use of Druidical incantations in battle. He quarrelled with the church about the right of sanctuary, with disastrous results for the country. The king held an assembly (*feis* or *fess*) of the kings and princes of Ireland at Tara in 554, at which Curmáin, son of the king of Connaught, slew a nobleman. By ancient usage homicide and certain other offences committed at such assemblies were punishable with death without the privilege of compounding for the crime. Curmáin, knowing his fate, fled for sanctuary to Columcille; but Diarmait pursued him, and, disregarding the opposition of the saint, seized Curmáin and hanged him. The kinsmen of Columcille, the northern Húi Néill, took up his quarrel, and attacked and defeated the king in a battle in 555. It is probable that the part taken by Columcille in this affair had much to do with his leaving Ireland for his great mission to the Piets two years after. So ardent, energetic, and imperious a spirit must have chafed at any impediment in the way of his work, and, as many of his establishments were under the king's hand, he must have decided to seek another field. This was not the only quarrel about the right of sanctuary which Diarmait had with the church. The chief of Húi Maine, having slain the herald of the king, took sanctuary with St Ruadan of Lothra in Lower Ormond. Diarmait, despite the remonstrances of St Ruadan, seized him by force. The saint, accompanied by St Brendán of Birr, followed the king to Tara, and solemnly cursed it. After the death of Diarmait, who was slain in 558, Tara was deserted, and no assembly was again held there. Subsequent kings resided at their hereditary duns—the northern Húi Néill at Ailech, near Derry, those of the southern branch in Westmeath. The desertion of Tara was one of the chief causes which disintegrated the Irish nation, in which the idea of a central government had taken firm root, and might under favourable circumstances have acquired sufficient force to evolve a higher political state out of the tribal system.

The reign of Aed, son of Airmire, of the race of Conall Gulban of the northern Húi Néill (572-599), marks another important epoch in Irish history. The *féis*, whom we shall conventionally call bards, and who were part of the transformed Druidic order, had increased in number to such an extent that they are said to have included one-third of the freemen. An ollam fili, the highest grade of the order, was entitled to a large retinue of pupils, with their horses and dogs, with free quarters wherever he went. There was thus quite an army of impudent swaggering idlers roaming about the country and quartering themselves on the chiefs and nobles during the winter and spring, story-telling, and lampooning those who dared to refuse, or even to hesitate, to comply with their demands. Aed determined to banish them from Ireland; and, as this could only be done with the consent and cooperation of all the kings and chiefs, he summoned a convention (*feis* or *fess*), such as formerly met at Tara, to assemble at Drumeata, in the north of Ireland. The political geography of the country at the time may be understood from the princes who attended. Besides Aed himself, the "Ard Rí" or over-king, there came there the over-king of Munster, the king of West Munster or Desmond, the king of Leinster, the king of Ossory, the chiefs of which had then begun to acquire that power and independence which gave them prominence in the Dano-Irish wars, the kings of the three principalities into which Connaught was then divided, the chief of the Cinel Eogain branch of the northern Húi Néill (Aed, the over-king, represented the Tir Conaill branch), two kings of the Airgíall, the king of Dal-Araide, the representative of the once powerful kings of the Ulaid, before the conquests of the Scots, and Aedán, son of Galbrán king of the Dárlata of Alba. Two other causes were also to be discussed at the assembly, one of which is of considerable historic interest, namely, Aed's proposal to impose a tribute payable to the over-king upon the Dalriadic kingdom in Alba, which had hitherto paid no rent, though bound to assist the Irish king in his

<sup>1</sup> *History of Scotland*, i. 333.

wars both by sea and land, and to pay him *Grícs* or blood fines. In other words, Aed proposed to make the Dalriadic colony an integral part of the Irish kingdom. St Columaile came thither from his island home attended by a large retinue of monks, many of whom were bishops, to plead the cause of the bards and of his kinsman Aedín. His influence seems to have been decisive; the bards were not banished, but were reformed, and the Dalriadic colony was made independent. The decision about the bards was no doubt a reasonable compromise at the time. The schools which the reformed order were obliged to keep mainly contributed to make Ireland a refuge of learning in the 7th and 8th centuries, and created a native literature, such as it was, several centuries before those of the other barbarian nations of Europe. But, on the other hand, professional poets, whose duty it was to sound the praises of chiefs and clans in rhymes of the most complex and artificial metres and inflated language could not produce a really healthy vigorous literature. Some notion of what that literature might have been if produced in the favourable atmosphere of a growing political and social life may perhaps be formed from works, written it is true in Latin, but yet the genuine outcome of Irish culture, such as those of St Columba; the poems of Hibernicus exul, as the unknown exile is called who wrote in the second half of the 8th century the earliest epic of the Middle Ages<sup>1</sup>; the poems of Sedulius Scotus, now brought to light more fully; Adamnan's life of St Columba, or Columaile, which Pinkerton considered to be "the most complete piece of such biography that all Europe can boast of, not only at so early a period, but even through the whole Middle Ages"; and above all the writings of John Scotus Erigena, undoubtedly the greatest philosopher of the Middle Ages. We are, however, now in a better position to judge of the injurious action of the bardic institution as a whole. Several causes—among others, geographical position—helped to arrest the political and social growth of the Irish people, and crystallize their culture in the tribal stage, but the most powerful of those causes was the existence of the organized professions of the *sáide*, who kept up elaborate systems of pedigrees, and of the *filid* or bards, whose business it was to flatter the vanity of their patrons and ponder to their vices. These kept the clan spirit alive, shut out the influx of new opinions, and stopped the growth of national political ideas. The ephemeral lustre of the Irish mediæval schools could never compensate for such losses.

The intensity of the tribal spirit even among churchmen is illustrated by an event which took place in the reign of Domnall, son of Aed (628-642). St Carthach, or as he was also called St Mochuda, a West Munster man, wandered into what is now the King's county, and built a monastery at Rathin, now Rahin, near Tillamore. The clergy of Leth Cuind—that is, of the Húi Néill—were jealous of the intrusion of the Munster monk into their territory, and accordingly insisted on Mochuda's expulsion, who sought a refuge among the *Dési* in Munster, and there founded the monastery of Less Mór, now Lismore, in Waterford, which became a famous school. Another event of this reign, of great importance, was the battle of Mag Rath, now Moira, in the county Down. Congal Clain, the king of Dal-Araide, who had been in exile, invaded Ireland with an army of foreign adventurers, and aided by Domnall Bree, king of the Albanian Scots, endeavoured to recover the ancient supremacy of the Rudrician race, or Ulaid, but was signally defeated. This wanton attack of Domnall Bree weakened the power of the Scots in Alba for a long time, and thus influenced largely the course of events in North Britain.

Joint kingship was one of the most curious features of the Irish system; it frequently occurred in the course of the Húi Néill rule. The reign of the joint kings Diarmait and Blathmac of the northern Húi Néill (658-665) is interesting on account of the glimpse which Bede gives us of Irish society in the 7th century. After mentioning the sudden appearance of a great pestilence which depopulated the southern coasts of Britain, and afterwards extended into the province of the Northumbrians, Bede adds (*Eccle. Hist.*, iii, 26), "This pestilence did no less harm in the island of Ireland. Many of the nobility and of the lower ranks of the English nation were there at that time, who in the days of the bishops Finan and Colman, forsaking their native island, retired thither, either for the sake of divine studies or of a more continent life; and some of them presently devoted themselves to a monastical life, others chose rather to apply themselves to study, going about from one master's cell to another. The Scots willingly received them all, and took care to supply them with food, as also to furnish them with books to read and their teaching gratis." Later on in the same century (681) the cow-tribute or *borroim* of Leinster was abolished at the instance of St Moling by the over-king Finnaughta; and at the end of it (697) St Adamnan, abbot of Iona, who had come to Ireland in connexion with the still unsettled question of the time of keeping Easter, succeeded in exempting women from military service. The necessity for such a law, which has been called from its author the *Cáin Adamnain*, shows how little affected the tribal system of Ireland was by Roman civilization, even at this period. In the

reign of the over-king Aed Alaind (733-742), an attempt seems to have been made for the first time to create a national church organization. King Aed and his rival, the king of Munster, Cathal, entered into an agreement regulating the tribute due to the church according to the rules and customs of the see of Armagh. Some time elapsed, however, before the regulation was generally accepted over the whole of Ireland. In the year 803 the over-king Aed Ordnigthe mustered an army composed of "both laity and clergy," but the latter complained of the hardship of being forced to take part in warlike expeditions. King Aed agreed to abide by the advice of a learned priest called Fothad of the Canons, who recommended the exemption of the clergy from the obligation of fighting. This law was called the *Cáin Pátraice* or law of Patrick, probably from having been obtained by the comarba or successor of St Patrick, that is, the archbishop of Armagh at the time. The exemption may have, however, formed part of the regulations, called also *Cáin Pátraice*, which formed the subject of the agreement between Aed Alaind and Cathal above referred to.

*Invasions of the Northmen.*—The first incursion of the Northmen took place in 795 A.D., when they plundered and burnt the church of Rechrann, now Lamhey, an island north of Dublin Bay. When this event occurred, the power of the over-king had become a shadow; the provincial kingdoms had split up into more or less independent principalities, almost constantly at war with each other. Even Mag Breg, which was only part of Meath, was able to rebel against the chief of the latter. The oscillation of the centre of power between Meath and Derry, according as the over-king was of the southern or northern Húi Néill, which followed the desertion of Tara, produced corresponding perturbations in the balance of parties among the minor kings. The army consisted of a number of clans, each commanded by its own chief, and acting as so many independent units without cohesion. The clansmen owed fealty only to their chiefs, who in turn owed a kind of conditional allegiance to the over-king, depending a good deal upon the ability of the latter to enforce it. A chief might through pique, or from other causes, withdraw his clan even on the eve of a battle, without such defection being deemed dishonourable. What the clan was to the nation or the province, the fine or sept was to the clan itself. The chieftains or heads of septs had a voice, not only in the question of war or peace, for that was determined by the whole clan, but in all subsequent operations. However brave the individual soldiers of such an army might be, the army itself was unreliable against a well organized and disciplined enemy. Again, such clan armies were only levies gathered together for a few weeks at most, unprovided with military stores or the means of transport, and consequently generally unprepared to attack fortifications of any kind, and liable to melt away as quickly as they were gathered together. Admirably adapted for a sudden attack, such an army was wholly unfit to carry on a regular campaign or take advantage of a victory. These defects of the Irish military system were abundantly shown throughout the Dano-Irish wars, and also in Anglo-Norman times.

The first invaders were Norwegians, who sought only plunder and captives. They confined their attacks to the sea-coast, or places at easy distances from it. After some time they erected rude castles or stockaded forts, which served as magazines and places of retreat. Some served a temporary purpose, while others became in time trading stations, or grew into towns. During the first half of the 9th century the attacks were incessant upon almost every part of the coast. The small bodies who came at first having met with considerable resistance, large fleets commanded by powerful vikings followed. Their well-armed crews—the principal men at least being mail-clad—were able to penetrate into the country, and even to put fleets of boats upon the lakes. An Irish work on the invasions of the Northmen gives an account of one of those vikings named Turges or Turgisius, of whose cruelties many stories are told. Giraldus Cambrensis and the monk Jocelin repeated these stories,—the Irish book being, however, the original source from which the stories came. But Cambrensis goes beyond his source, and makes Turgisius king of Ireland. The Norse saga and chronicles make no mention of Turges, and much speculation has been indulged in as to the Norse equivalent of the name. It has been suggested that he was Thorgils, son of Harold Fair Hair, but this is an anachronism. According to another view, he was the shadowy king Ragnar Lodbrok or "Hairy Breeches," but this, besides being also an anachronism, is mere groundless guesswork. Dr Todd has suggested that the Celtic form Turges represents the Norse Trygve, but is more likely Thorgeir. The actual story of Turges is a fable, which has grown up by the fusion of the stories of several vikings of the name, helped out by some invention. That there were at least two of the name is proved by an elegy on the death of Eignechin, prince of Tir Conaill, who died about 902, written by Fland Mac Léoinn, a poet who lived within fifty years of the supposed historical chief. The poet tells a curious story of three vikings, one of whom was Turgeis and another Tor, who were married to three daughters of the prince. The Turges of history is supposed to have come to Ireland in 815, and to have been made prisoner and drowned by Maelsechann, or Maiaehy, the first king of the name

<sup>1</sup> "Hibernicus exulis versus ad Karolum imperatorem," in *Mal. Classicorum Auctorum et Vaticanis Codicibus*, v. 405 sq.



in 845, Garinmundus, another king of Ireland<sup>1</sup> spoken of by Cambrerensis and Jocelin, is most probably the mythical Garin or Carian of prehistoric times, a view which bears out a sagacious remark of Worsaae, that the Irish accounts of the Northmen frequently bear the stamp of being derived from early poetical legends.

But, even admitting that the story of Turges is a fable, the viking inroads in the first half of the 9th century inflicted untold woes on the country, one of the greatest being the breaking up of the Irish schools, just when they were at their best. Those who escaped fled to other countries; among these we may assume were Sedulius Scotus and John Scotus Engena. But, whatever may have been the cruelty of the vikings, the work of disorder and ruin was not all theirs. The condition of the country afforded full scope for the jealousy, hatred, cupidity, and vanity which characterize the tribal stage of political society. Fedlimid, king of Munster and archbishop of Cashel, took the opportunity of the misfortunes of the country to revive the claims of the Munster dynasty to be kings of Ireland. To enforce this claim he ravaged and plundered a large part of the country, took hostages from Niall Caille, the over-king (833-845), drove out the comarba of St Patrick, or archbishop of Armagh, and for a whole year occupied his place as bishop. On his return he plundered the termon lands of Clonmacnois "up to the church door,"—an exploit he repeated the following year. There is no mention of his having helped to drive out the foreigners. It is indeed possible that much of the devastation attributed to Turges may have been the work of Fedlimid, yet he is praised by the bards and annalists.

About 852 the Dub-gaill or black foreigners, that is, the Danes as distinguished from the Find-gaill or fair foreigners or Norwegians, arrived. They quarrelled with each other at first, but ultimately made common cause. The Scandinavians at this time had effected permanent settlements, and trade had brought the natives and foreigners into friendly contact and intermarriage. Much intermingling of blood had already taken place in consequence of the number of captive women who had been carried away by the invaders. A mixed race grew up, recruited by many Irish of pure blood, whom a love of adventure and a lawless spirit led away. This heterogeneous population were called Gallgöedel or foreign Irish, and like their northern kinsmen betook themselves to the sea and practised piracy, and so were known to the Northmen as Vikingr Scotar. The Christian element in this mixed society soon lapsed to a large extent, if not entirely, into paganism. The Scandinavian settlements were almost wholly confined to the seaport towns, and, except Dublin, included none of the surrounding territory. Owing to its position, and the character of the country about it, especially the coast land to the north of the Liffey, which formed a kind of border land between the territories of the kings of Meath and Leinster, a considerable tract passed into the possession of so powerful a city as Dublin. We have evidence of this occupation in the topographical nomenclature of the district, while there are very few traces to be found elsewhere. The social and political condition of Ireland, and the pastoral occupation of the inhabitants, were unfavourable to the development of foreign commerce, and the absence of coined money among them shows that it did not exist. The foreign articles of dress or ornament they required appear to have been brought to the great oenachs or fairs held periodically in various parts of the country. A flourishing commerce soon grew up in the Scandinavian towns—Dublin, Waterford, Limerick, &c.; mints were established there, and many foreign traders—Flemings, Italians, and others—settled there. It was through these Scandinavian trading communities that Ireland came into contact with the rest of Europe in the 11th and 12th centuries, of which the present forms of the names of three of the Irish provinces afford evidence. They are formed from the Irish names by the addition of the ending staðr, ster. The settlers in the Scandinavian towns soon came to be looked upon by the native Irish as so many septa of a clan added to the system of petty states forming the Irish political system. They soon mixed themselves up in the domestic quarrels of neighbouring tribes, at first selling their protection, a method largely followed afterwards by the Anglo-Normans, but afterwards as vassals, sometimes as allies, like the septa and clans of the Göedel among themselves. The latter in turn acted in similar capacities with the powerful Dano-Irish chiefs, Irish clans often forming part of the Scandinavian armies in Britain. This intercourse led to frequent intermarriage between the chiefs and nobility of the two peoples. One of the earliest and most interesting examples of this is the case of Cerball, king of Ossraige or Ossory, from about 858 to 887 or 888. Eyvindr, surnamed Aust-maðr, "the east-man,"<sup>1</sup> son of Bjorn, agreed to defend Cerball's territory, which from its position stood much in need of it, on condition of getting his daughter Ráfora in marriage. Among the children of this marriage were Helgi Magri, or "the Lean," one of the early settlers in Iceland, and Thurrída, wife of Thorstein "the Red," son of the celebrated Olaf, "the White," king of Dublin. Three other

daughters of Cerball married foreigners: Gormflaith, called in Norse Kornlöð, married Grimolf, who also settled in Iceland; Fridgerda, married Thoris Hyrna; and Ethne or Edna, married Hloóver, whose son was Earl Sigurd Digri ("the Fat"). Cerball's son Donnall, in Norse Dufnialr, was the founder of an Icelandic family; while the names Randi and Baugr, the son and grandson of another son of Cerball, Cellach, in Norse Kjallakr, show how completely Norse they had become. Many others of the Icelandic settlers were Irish of pure or mixed blood, such as Thormóðr, Ketil Bufa, &c. Among the descendants of Rognvald (Rognvald) of Waterford we find such distinctly Irish names as Gillepauice, and Donddubhan or Donavan. This intimate connexion of the two peoples explains the occurrence among the Icelanders and Norwegians of Konall, Kjaran, Njall, Kormakr, Brigit, Kaðlin, and many other Celtic names.

After the arrival of the Dubgaill or Danes about 851, there was a severe struggle between them and the Norwegians, but all ultimately acknowledged Olaf "the White" (the Olafr hinn Hvite of the Norse saga and the Amblaebh of the Irish) as king. The over-king of Ireland at this time was Maelsechlainn, or Malachy, the first of the name, a brave soldier who had reduced the Scandinavian possessions in Ireland previous to the coming of Olaf to a few strongholds on the sea; but owing to the character of the Irish arms, which has been dwelt upon above, he was unable to retain the forts he took (among them Dublin). After Olaf came Ivar "Beinlauss," "the Boneless," who was afterwards king of the Northumbrians, a circumstance which accounts for the close connexion which afterwards subsisted between the Northumbrian dynasty and the Danish kings of Dublin. On the death of Ivar, Cerball, king of Ossory—the Cerball above mentioned—an Irishman of Goidele blood, succeeded him, and was acknowledged as Danish king of Dublin until his death in 888. Cerball in alliance with another Ivar made his neighbours feel his power, and practically made Ossory independent. It is curious that, while the Irish annals do not recognize Cerball as king of Dublin, Kjarvalr of Dyfjin is enumerated among the principal sovereigns of Europe in the Icelandic *Landnámabók*. From about the beginning of the reign of Cerball to about 915, corresponding to the reigns of the over-kings Aed Find Liath and Flann Sinna (nephew of Cerball), there were no fresh invasions of the Danes or Northmen. During this period Ireland enjoyed comparative rest, and was regarded elsewhere as a place of comparative safety, notwithstanding the many feuds between the Irish clans in which the Dano-Irish shared, including the campaigns of Cormac, son of Cuileannan, king-bishop of Cashel. After this forty years' rest the invasions recommenced. Niall Glundub ("Blackknee"), who became over-king in 910, gallantly opposed the invaders, and attempted to get possession of Dublin, but was defeated with great slaughter in the battle of Kilmashoge (Cell-Mosanhog) near Dublin in 919, and himself and twelve chiefs slain. From this time until Maelsechlainn, son of Donnall, or Malachy II. became over-king of Ireland in 980, the country was plundered and desolated by natives and foreigners alike. The most prominent figures of this period were Muircertach, son of Niall "Blackknee," commonly known as Muircertach "of the Leather Cloaks," Cellachan or Callaghan of Cashel, and Olaf Cuarán. Muircertach Mac Neill was the most formidable opponent the Scandinavians had yet met. In his famous circuit of Ireland he took all the provincial kings, as well as the Danish king of Dublin, as hostages, and, after keeping them for some time at Ailch, he handed them over to the titular king of Ireland, the weak and inefficient Donnall, showing that his loyalty was greater than his ambition. Callaghan of Cashel, though the hero of a late romance, had in reality no claim to fame. Olaf Cuarán, or Olaf "of the Saddle," was the son of Sigtrygg, or Sitric, who was king of Dublin about 917. Sigtrygg was expelled from Dublin (about 920), and went to England, where he took advantage of the death of Rognvald (about 924) to make himself king of the Scandinavian kingdom of Northumbria. On the accession of Athelstan he went to Tamworth (926) and made homage to him, and married Athelstan's sister, but died the following year. Athelstan then expelled his sons Olaf and Guðröðr or Guðred. This Olaf appears to have been the one who married the daughter of Constantine, king of Scotland, and with another Olaf, son of the cruel Guðred, king of Dublin, who went away from that city in 834, took part in Constantine's wars with Athelstan, ending in the bloody battle of Brunanburgh (938 A.D.). Olaf, son of Guðred, returned to Ireland, but on the death of Athelstan became king of the Northumbrian kingdom, and on becoming a Christian was acknowledged by Edmund, Olaf Cuarán, who appears to have been also baptized (844), succeeded to the Northumbrian kingdom for a short time in the reign of Eadred, on the expulsion of Eric Bloody Axe, but on being in turn expelled he appears to have gone to Ireland, where he became king of Dublin, and apparently of Man and the Isles. The Isle of Man belonged to the Goidele kingdom of Ireland in early times, and was conquered in 588 by Aidan, son of Gabrán, king of the Scotie kingdom of Alba, and passed away from the Irish connexion after the convention of Drumceta. During the independence of the Dano-Irish kingdom of Dublin it seems to have formed part of it.

<sup>1</sup> In Anglo-Norman times the Dano-Irish of Dublin and other cities are always called Ostun-n Aust-meun) or East Men; hence the name Ostmaustown, now Oxtaustown, a part of the city of Dublin.

Olaf Cuaran slew Congalach, king of Ireland, in 956. In 975 Donnall, the son of this Congalach, in alliance with Olaf, defeated Donnall O'Neill, king of Ireland, at Cell Mona (Kilmoon near Dunshinglin, county Meath). Donnall O'Neill was the son of "Leather Cloaks," son of King Niall, from whom he took the surname G'Neill, that is, grandson of Niall, and was the first who used it. The tanists or heirs of the northern and southern Húi Néill having divid. the throne fell to Maelsechlainn or Malachy II. of the Clann Colmain, the last of the Húi Néill who was undisputed king of Ireland. Malachy, who became king in 980, had already distinguished himself as king of Meath in war with the Dano-Irish. In the first year of his reign as over-king, he defeated them in a bloody battle at Tara, in which fell Rögnvald, son of Olaf Cuaran. This victory, won over the combined forces of the Scandinavians of Dublin, Man, and the Isles, compelled Olaf to deliver up all his captives and hostages, among whom were Donnall Clain, king of Leinster, and several notables, to forego the tribute which he had imposed upon the southern Húi Néill, and to pay a large contribution of cattle and money. Olaf's spirit was so broken by this defeat that he went on a pilgrimage to Hí, where he died the same year.

*The Dal-Cais Dynasty.*—Like the Húi Néill, the rival family of Ailill Olum of Munster had split into two branches. The descendants of Ailill's son Eogan were called the Eoganacht or Eugeniens, and those of his son Cornac Cas the Dal-Cais. Ailill is said to have ordained that the succession to the throne of Munster should be alternately in the races of Eogan and Cornac Cas. This rule was observed with tolerable regularity for some generations, like the corresponding alternation between the northern and southern Húi Néill. The Eugeniens claim, however, being the more powerful, succeeded in excluding to a great extent the rival race from the throne. The Dal-Cais, who were seated in North Munster, had necessarily to bear the brunt of the attacks upon Munster, which impoverished and weakened them. A few of them succeeded, however, in asserting their claims to the throne, among whom were Cennedíg or Kennedy (in 954), and his sons Mathgamain or Mahón (slain 976), and Brian, surnamed Boruma, who reigned from 976 to 1002, when he became over-king. Properly speaking, the Dal-Cais derived their name not directly from Cornac Cas but from Cas MacTail, king of Thomond, one of his descendants. The grandson of this Cas, Carthann Find, was the first Christian chieftain of the race. The family was seated near Bel na Boruma or the Pass of the Cow-Tribute, and Ath na Boruma or Ford of the Tribute, which suggests that the Dal-Cais were in the habit of "lifting" preys of cattle. It was most probably from this place that Brian was called Boruma, and not, as is usually assumed, from having reimposed the ancient cow-tribute upon Leinster. Kennedy and his sons offered a stubborn resistance to the Dano-Northern. While king of Thomond, Mahón after a harassing warfare made a truce with the latter, but Brian roused the whole people to war. Mahón crossed the Shannon, and got possession of Cashel on the death of the Eugeniens king of Munster, Dunchad. Ivar, Dano-Norse king of Limerick, in conjunction with Maelmuad, or Molloy, king of Desmond, and Donnaban, king of the Húi Fúiginte and Húi Cairpri, who were in alliance with Ivar, perhaps even his vassals, determined to carry the war into Thomond, but were met by Mahón at Sulcoit, near the site of the present town of Tipperary, and totally defeated. This decisive victory gave the Dal-Cais Limerick, which they sacked and burnt. Mahón then took hostages of all the chiefs of Munster. Ivar escaped to Britain, but returned after a year with a Lord of the Isles whose name is unknown, but who was called Maccus, son of Harold, probably a misunderstanding of the Irish Mac Aitair, that is, son of Harold. This chieftain had conquered Anglesey, which, however, he was only able to hold for a short time. He was one of the eight kings of Britain who paid homage to Edgar at Chester in 973, and rowed his boat to and from church. Ivar and MacHarold entrenched themselves at Inis Cathaig, now Scatterry Island in the lower Shannon, which they held for three years. In the meantime a conspiracy was formed between Ivar and his son Dubcenn and the two Eoganacht chieftains, Donoban and Maelmuad, before mentioned. Donoban was married to the daughter of a Danish king of Waterford, and his own daughter was married to Ivar of Waterford. The son of the latter was called Donaban, after his maternal grandfather. The descendants of the Irish prince in the male line were the O'Donovans, those of the Danish prince the O'Donovans. Inis Cathaig, where the Dano-Northern had entrenched themselves, was attacked in 976 by the Dal-Cais and plundered, and the garrison, including Ivar and his son Dubcenn, slain. According to the Norse, MacHarold and his two sons perished there, while Ivar was defeated and put to flight elsewhere. Irish accounts tell us that Ivar's surviving son Harold was recognized as king of the foreigners of Munster, and that he took refuge with Donoban. This Harold was probably not the son of Ivar, but the above mentioned MacHarold, Lord of the Isles. Brian, now the head of the Dal-Cais, invaded the territories of Donoban, took his fort, Cathir Cuain, and slew himself and Harold. He next attacked the other conspirator, Maelmuad, who by the death of Mahón had become king of Munster, and defeated and slew him. By this event

Brian became undisputed king of Munster. He reduced the Déisi, who were in alliance with the Dano-Northern of Waterford and Limerick, and banished their king. In 984 Brian subdued Ossory, and took hostages from the kings of East and West Leinster, for that province, like the others, had now become divided into two principalities, and thus made himself king of Leth Moga, or "Mug's Half" of Ireland. Brian then appears to have allied himself with the Dano-Northern of Waterford, or made them his vassals, for they seem to have joined him in his invasion of Westmeath in 989.

This last exploit of Brian brought him into contact with Malachy, who after his great victory at Tara had gained other successes. In 983, in alliance with his half brother Gluniarind or "Iron-Knee," son of his former foe Olaf Cuaran, he defeated Donnall Clain, king of Leinster, whom he had released from hostageship by his victory at Tara, and who was now in league with Ivar of Waterford. In 985 he slew the chieftains of Connaught, and plundered the country. In 989 he took Dublin, and imposed an annual tribute upon the city. Malachy thought it high time to check Brian, so he invaded Thomond, and defeated the latter. In 992 Brian, who evidently aimed at the over-kingship, invaded Meath, and advanced as far as Loch Ainind (Lough Ennel), at which was one of the residences of the southern Húi Néill, whereupon Malachy invaded Connaught and then compelled Brian to retire. In 996 Malachy advanced into Munster, plundered Nenagh, and defeated Brian. He next attacked Dublin, and carried off the ring or chain of Tomar and the sword of "Carlus," two heirlooms much prized by the Danes of Dublin.

In 998 Brian ascended the Shannon with a large force, intending to attack Connaught. Malachy, who received no support from the northern Húi Néill, came to terms with Brian. All hostages held by the over-king from the Danes and Irish of Leth Moga were to be given up to Brian, which was a virtual surrender of all his rights over the southern half of Ireland. Brian on his part recognized Malachy as sole king of Leth Cuind, or Cond's half, "without war or trespass from Brian." This treaty was thus the exact counterpart of that made centuries before by their ancestors Cond and Mag Níadat. In 1000 Leinster revolted against Brian, and entered into alliance with the Danes of Dublin. Brian advanced towards the latter place with the intention of blockading it, but halted on the way at a place called Glenn-Mama or Glen of the Gap, near Dunlavin, the ancient fortress of the kings of Leinster, in the county of Wicklow. It is said, though there is not sufficient ground for the opinion, that Malachy joined him here. The Dano-Irish allies attacked him, but were defeated with a loss of 4000 slain, including Aralt or Harold, son of Olaf Cuarán. Brian entered Dublin with his victorious army, where he found immense booty, and made captives and slaves of a great number of women and boys and girls. Making Dublin his headquarters, he then easily reduced the greater part of Leinster.

After his defeat at Glen Mama, Sigtrygg or Silric fled for protection to the northern Húi Néill at Ailech, but, feeling to inure them or the kings of the Ulaid to enter into an alliance with him, he submitted to Brian three months after his defeat. The latter, seeing the advantage the Dane would be to himself, not only restored him to power in Dublin, but gave him his daughter in marriage, and took the mother of Sigtrygg as his wife or concubine. Gormflaith or Gormlaith was the sister of Maelmorda, the king of Leinster, whom Brian had defeated at Glen Mama. She was married first to Olaf Cuarán, by whom she had Sigtrygg, and then to Malachy, by whom she was divorced or repudiated, after she had borne him a son Conchohar. It is probable that her connexion with Brian dates before this, for her son Donnchad by Brian was grown up at the time of the battle of Clontarf.<sup>2</sup>

Sigtrygg's confederate Maelmorda, brother of Gormflaith, was also taken into favour by Brian and restored to the kingship of Leinster. Brian then returned to his residence, Cean Coradh, and there matured his plan for deposing Malachy, and making himself over-king. When everything was ready he entered Bregia (Mag Breg) with an army consisting of his own troops, those of Ossory, his South Connaught vassals, and the Dano-Irish of Munster. His allies the Dublin Danes appear to have advanced into Meath before him, but their cavalry was defeated by Malachy. The latter, feeling himself unequal to the contest with Brian, endeavoured to gain time for the purpose of seeking allies, for he had evidently been taken by

<sup>1</sup> It is to this ring that Moore alludes in the line

"When Malachy wore the collar of gold."

<sup>2</sup> In the *Njala* Gormflaith is described as "the fairest of all women, and the best gifted in everything that was not in her own power;" but, it is said, "she did all things ill over which she had any power;" that is, though a beautiful she was a bad woman. The close relations which her story shows to have subsisted between the Scandinavians and Góedel at this period may be illustrated by other similar stories. Donnflaith was the daughter or granddaughter of "Leather Cloaks," and was in the first instance the wife of the king of Ireland, Donnall, son of Donnall, and after his death of Olaf Cuarán, king of Dublin, by whom she had Gluniarind. "Iron-Knee," afterwards Dano-Irish king of Dublin, by whom she had Gluniarind, and after his death of Olaf Cuarán, she was married to Malachy, who repudiated her after some time. Malachy then married Maelmorda, sister of Sigtrygg or Silric, Olaf Cuarán's son by Gormflaith. From her name Maelmorda, "Sergeant of Mary," this daughter of Olaf Cuarán was probably a Christian.



surprise. With this view he concluded an armistice, during which he was to decide whether he would give Brian hostages (that is, abdicate) or not. He applied to the northern Húi Néill to come to his assistance, and even offered to abdicate in favour of Aed O'Neill, chief of the Cinel Eogain; but the latter clan refused unless Malachy undertook to cede half the territory of his own clan—the Clann Cúannain—to them. The attempt to unite the whole of the Heremonian race against the Eberian race, and preserve a dynasty that had ruled Ireland for six hundred years, having failed, Malachy submitted to Brian, and without any formal act of cession the latter became over-king, for the annalist Tigernach, who was himself of the Húi Néill, records at the end of the year 1001, "Brian regnat." The Four Masters, also of the northern Húi Néill, begin his reign in 1002. During a reign of twelve years (1002-1014) he is said to have effected much improvement in the country by the erection and repair of churches, the construction of bridges, causeways, and roads, and the strengthening of the royal forts and "crannogs" or island fortresses. We are also told that he administered rigid and impartial justice, and dispensed royal hospitality, and, as he was liberal to the bards, they have not forgotten his merits.

Towards the end of Brian's reign a conspiracy was entered into between Maelmorda, king of Leinster, and his nephew, Sitric of Dublin, who was married to Brian's daughter. This conspiracy was instigated by Gormflaith, Maelmorda's sister, and Brian's wife or concubine, who seems to have used all her arts to secure allies. In the spring of 1014 they had collected a considerable army in Dublin, composed of Maelmorda's own Leinster troops and Welsh allies, the Danes of Dublin, and considerable contingents from Man, the Isles, Orkney, and in fact from all the Scandinavians of the west. Some Saxons and Flemings interested in the trade of Dublin seem to have also joined the expedition. Its leader was Sigurd, earl of Orkney and Caithness, son of Earl Hlöðver or Levis, by an Irish princess (Ethne or Edna, daughter of Cerball, king of Ossory), whom he succeeded in 980. Sigurd, who aimed at the supreme command of all the Scandinavian settlements of the west, succeeded in the course of a few years in conquering the Sudreys, and even Sutherland, Ross, Moray, and Argyll. He had accidentally fallen into the power of Olaf Tryggvason, when the latter was on his way from Dublin to be king of Norway, who only set him free on condition of his becoming a Christian and swearing fealty to him. Another leader of the Dano-Hibernian army was an apostate deacon called Brodir, who, according to Maurer's conjecture, was the Danish viking Guthring. To meet this formidable force, Brian, who was then an old man, unable to lead his troops in person, mustered all the forces of Munster and Connaught, and was joined by the forces of Meath under Malachy the deposed king. The northern Húi Néill and the Ulaid took no part in the struggle. Brian advanced into the plain of the Fine-gaill, north of Dublin, where a council of war was held. It is said that Malachy differed with Brian on the plan of battle, and did not join his troops with Brian's. He is further accused of treachery and of being in league with the enemy. This is, however, a calumny of the Munster bards. The probability is that his troops had not yet come up when the battle began, and that he held them in reserve. There is no doubt, however, that he mainly contributed to the victory by keeping the strong garrison under Sitric, which held Dublin, in check, and at a critical moment falling upon the Leinster wing of the enemy, which he crushed, and preventing the Danes from rallying, by which numbers were forced back to the shore and drowned by the advancing tide. The battle, which in the Norse saga is called Brian's Battle, and in Irish history the battle of Clontarf, though the chief fighting took place close to Dublin, about the small river Tolka, was fought on Good Friday 1014. It fell most of the leaders on both sides, and also Brian himself, who was slain in his tent by Brodir when a fugitive from the field of battle.

The Irish as usual did not follow up their victory by taking Dublin, which remained a Danish city until the advent of the Normans. This probably arose from the dissensions which immediately broke out among the Munster men about the kingship of Munster, each party hastening home as quickly as possible in order to get possession of the prize. On the way the Dal-Cais were opposed by the men of Ossory, but no battle took place owing to the heroic conduct of the wounded. This unpatriotic conduct of the king of Ossory has been made much of; but nationality in the modern sense had nothing whatever to do with the affair. In the following year, 1015, Malachy, who was again recognized as king of Ireland, with the aid this time of the northern Húi Néill, burned Dublin and harried the Leinster clan the Húi Cennselgaig. But the effects of Brian's revolution were permanent; the prescriptive rights of the Húi Néill were dispersed, and after Clontarf, until the coming of the Normans, the history of Ireland consisted of a struggle for ascendancy between the O'Brians of Munster, the O'Neills of Ulster, and the O'Connors of Connaught. The power of the western Scandinavians was broken at Clontarf: no new invasion took place, chiefly no doubt because of their conversion to Christianity. They continued to hold their strongholds on the coasts, and occasional combats took place between them and their neighbours. Gradually,

however, they assumed the position of native tribes; but, owing to the distinction of language, they did not readily fuse with the Goedel, though intermarriages were frequent. They fused much more readily with the Normans and English, not so much from any affinity of language, as from their civic life and commercial spirit being alike. The next generation saw Christianity the recognized faith of the Dano-Irish, who founded bishoprics, at first in connexion with the church in Norway, but wholly unconnected with the Irish clan-bishops until a short time before the Anglo-Norman invasion.

*From the Battle of Clontarf to the Anglo-Norman Invasion.*—The death of Malachy, the last over-king acknowledged by the whole country, afforded an opportunity for an able and ambitious man to subdue Ireland, establish a strong central government, break up the tribal system, and assist the gradual fusion of factions into a homogeneous nation. Such a man did not, however, arise; those who afterwards claimed to be ar dr lacked the qualities of founders of strong dynasties, and, though sometimes acknowledged by the greater part of the country, were never accepted as the legitimate rulers of the whole of Ireland. Even the Scandinavian towns of Ireland ceased to cooperate as one people. Their native chiefs were sometimes expelled and replaced by Irish ones, and the fusion of the two races went rapidly on. In 1052, Diarmait (called Mac Mael na mBo), king of Leinster, defeated the Dano-Irish king of Dublin, Echmargach (Margaðr in the Sagas), son of Rögnvaldr (Reginald), and became king of Dublin, and was succeeded by his son Murchad, who defeated Sigtryggr, son of Rögnvaldr, king of Man, and made that island tributary to Dublin, a relation it generally stood in under Scandinavian rulers. After an ineffectual attempt of Donnchad, son of Brian, king of Munster, to become ar ri, Diarmait, king of Leinster, gained the upper hand. At the commencement of Donnchad's reign great lawlessness prevailed in Munster, which was further intensified by a dearth. The king held an assembly of the chiefs and clergy at Killaloe in 1050, to devise measures for its repression, and appears to have succeeded, for Munster was peaceable for a long time, and many Saxon and Welsh nobles found refuge there. Much intercourse appears to have existed between the southern Irish and the Anglo-Saxons, and many Irish nobles were mixed up with English feuds. Intermarriages were also frequent, the king himself being married to Drilla, sister of Editha, queen of Edward the Confessor. In the rebellion of Earl Godwine, Harold took refuge with his brother-in-law, who gave him nine ships on his return to England. Tordelbach (Torlough), in revenge for the death of his father Tadg, whom his uncle Donnchad had slain, attacked the latter and defeated him in 1063.

On the death of Diarmait Mac Mael na mBo, who was killed in a battle with the king of Meath in 1072, the Tordelbach just mentioned was generally recognized as ar dr, but he did not succeed in gaining the allegiance of the northern Húi Néill. He appears to have appointed his son Muircertach (Murtough) lord of Dublin; but the latter must have only had precarious possession of it from about 1075 or 1076 to 1079; for, immediately after the death of Diarmait, Godred, son of Sigtryggr (Sitric), was king. This Godred requested Lanfranc, archbishop of Canterbury, to consecrate a certain Gillepatrick bishop of Dublin, in succession to Duncan, a fact which shows that at this period the Danish cities acknowledged the supremacy of the see of Canterbury. Lanfranc in his answer calls Godred "Rex Hibernie," a title which he also gave to Tordelbach. On the death of the latter, Muircertach succeeded him as king of Munster, and while he was establishing himself on the throne, Godred Mansnach (*i.e.*, of Man) got possession of Dublin, which he ruled till 1094, when he was defeated by Muircertach. This is the Godred usually called Crovan, a name which, however, properly belongs to an earlier king of Man. A fierce war broke out between Muircertach and Donnall O'Loughlin, king of Ailech (of the northern Húi Néill). Godred took the side of Donnall with ninety ships, and Muircertach was defeated; but in the end he succeeded, and in 1094 he drove Godred out of Dublin. It is probable that Muircertach had received assistance to do this from Magnus "Bare-leg," who made his first expedition to the west about this time. As the Isle of Man was always an apanage to the Scandinavian kingdom of Dublin, the Mauxmen on the defeat of Godred Crovan naturally applied to Muircertach for a governor; he sent them his kinsman Donnall, who was, however, expelled some time after his tyranny. The struggle for the sovereignty between the rivals Muircertach and Donnall O'Loughlin continued, with intervals of truce negotiated by the clergy, without any decisive advantage on either side. In 1102 Magnus "Bare-leg" made his third and last expedition to the west, with the express design of conquering Ireland. His former ally Muircertach had meanwhile joined in a league against the king of England. The Norman lords, Robert of Belesme and Arnulph, brothers of Earl Hugh Montgomery, who had been killed by Magnus in his attack on Anglesey, on the occasion of his first expedition to the west, having espoused the cause of Robert, duke of Normandy, against his brother Henry Beaulieu, leagued with some Welsh princes against the king, and Arnulph entered into alliance with Muircertach, who gave him his daughter

in marriage, and even, it is said, promised to make him his successor. The league was unsuccessful, and Arnulph betook himself to the court of Muircertach, who so far from being able to give his son-in-law assistance, expected help from him against Magnus, who appears to have threatened Muircertach with war, probably on account of his relations with Dublin. There is a story of Magnus sending his shoes to Muircertach, and of the latter submitting unconditionally, which is, however, a mere fable; but the latter in his desire to crush his rival Donnall may have done homage to Magnus as suzerain of the kingdom of Dublin. Magnus and Muircertach came, however, to terms; they exchanged hostages, and Sigurd the son of the king of Norway was betrothed to Biadhmuin, the daughter of the Irish king. Magnus then became the guest of the latter at Cenncoradh in the winter of 1102; and in the following spring they invaded Ulster, but were signally defeated by Donnall O'Loughlin, and Magnus was killed shortly after in a foraging expedition in the present county of Down. Muircertach then courted the friendship of Henry, king of England, took back his daughter from Arnulph, and gave her to another man; and, faithful, like most of the princes and nobles of that time, he even plotted against the life of Arnulph. St Anselm nevertheless compliments him upon his good government, and passes a high eulogium on some of the Munster bishops. Ideas of a higher political life and church organization appear at this time to have made considerable progress in Ireland, and to have had an appreciable influence on the policy of Muircertach himself.

After the death of Muircertach the power of the O'Briens was for a time broken by Tordelbach (Turlough) O'Connor, king of Connaught, and a pretender to the over-kingship,—a man whom no tie or obligation bound. Conchobar (Connor) O'Brien, grandson of Muircertach, succeeded however in defeating O'Connor; and his brother Tordelbach, who succeeded him, carried on the war until the whole country was reduced to that state so graphically described by the Four Masters as "a trembling soil." In the midst of this almost continuous war and devastation morals became relaxed, and the practice of religion almost ceased. The church property had passed into the hands of the lay successors, and no provision was made for the service of the churches, most of which were in ruins. A true reformer, however, appeared in Maclmaedog Ua Morgair, or St Malachy, who was appointed legate by Innocent II. Through his exertions a great synod was held at Kells under Cardinal Paparo (Malachy having died at Clairvaux in 1148) in 1152, at which true diocesan jurisdiction was established, Dublin being brought into connexion with the Irish Church, and raised to the rank of an archiepiscopal city; another archbishopric was founded at Tuam, to the great discontent of the northern and southern parties representing "Cond's Half" and "Mug's Half" in the church,—the cardinal, as papal legate, having brought the palliums for the four archbishops. Tithes were also ordained to be levied for the support of the clergy, and many reforms decreed. Many churches and monasteries were built, and great advance took place in architecture and artistic metal work, which were not mere imitations of foreign art, but the true outcome of the earlier period of Celtic art.

Between 1148 and 1150 Muircertach (Maurice or Murtough) O'Loughlin was acknowledged as over-king in three out of the four provinces. Tordelbach O'Brien, however, renewed the struggle between the north and south, but after he had received the homage of the Danco-Irish of Dublin, a truce was arranged between the rivals. In 1151 the Munster king was deposed by his brother Tadg, who was supported by Tordelbach O'Connor, king of Connaught, with the assistance of Diarmait MacMurchada (Dermot MacMurrough). O'Loughlin took up the cause of his former rival, but was defeated by O'Connor. The latter died in 1156 after a long reign, and O'Loughlin remained undisputed over-king. Ruadri (Roderick) O'Connor succeeded his father Tordelbach, and signalized the beginning of his reign by blinding one brother and imprisoning two others. Muircertach O'Loughlin, having blinded the chief of Dal-Araide, a savage mode of mutilation very much in fashion at the time, a league was formed against him, and he was defeated and slain, whereupon Ruadri claimed to be over-king, and, there being no serious opposition, he was inaugurated with great pomp at Dublin, which already began to have considerable weight in Irish affairs, and had now for the first time assumed somewhat of the character of a metropolis.

The Diarmait MacMurchada above mentioned was the great-grandson of Diarmait Mac Mael na mBo, and was consequently both by descent and position much mixed up with foreigners, and generally in a state of latent if not of open hostility with the over-kings of the Ulú Néill and Dal-Cais dynasties. He was a tyrant, and a man of bad character. In 1152 Tigernan O'Rourke, prince of Brehni, had been dispossessed of his territory by Tordelbach O'Connor aided by Diarmait, and the latter is accused of also carrying off Derbforgaill (Derborigilla), O'Rourke's wife. It is probable, however, that the latter event has been entirely misrepresented, and that the lady had merely thrown herself, in accordance with Irish law, upon the protection of the Leinster king. However this may have been, the accession of Ruadri to the chief kingship

warned Diarmait of his danger; and accordingly, on learning that O'Rourke was leading an army against him with the support of the over-king, he burnt his castle of Feros, and went to Henry II. to ask his assistance. The results which followed belong to the next section, but here we may point out that many Irish princes before Diarmait had sought the aid of foreigners, and that at that time, and especially in a tribal society, this was not regarded in the same light as in modern times.

*Political and Social State of Ireland in the early Middle Ages.*—To complete our account of pre-Norman Ireland, we shall give here a brief account of the social life of the Irish at the end of the 8th and beginning of the 9th century, which indeed substantially represents the state of things during the whole period from the 7th to the 12th century.

In the Middle Ages there were considerable forests in Ireland encompassing broad expanses of upland pastures and marshy meadows, unbroken up to the 7th century by ditch or dyke. There were no cities or large towns at the mouths of the rivers; no stone bridges spanned the latter; stepping stones or hurdle bridges at the fords or shallows offered the only mode of crossing the broadest rivers and connecting the unpaved roads or bridle paths which crossed the country over hill and dale from the principal kingly *duine* (sing. *duin*). The forests abounded in game—the red deer and wild boar were common; and wolves ravaged the flocks, for the most part unprotected by fences even in comparatively later times. Scattered over the country were numerous small hamlets, composed mainly of wicker cabins, among which were some which might be called houses; other hamlets were composed of huts of the rudest kind. Here and there were some large hamlets or villages that had grown up about groups of houses surrounded by an earthen mound or rampart; similar groups of houses enclosed in this manner were also to be found without any annexed hamlet. Sometimes the rampart was double, with a deep ditch between. The simple rampart and ditch enclosed a *les* or cattleyard and the groups of houses of the owners, for every room was a separate house. The enclosed houses (*ratha*, sing. *rath*) belonged to the free men called *airig* (sing. *aire*). The sizes of the houses and of the enclosing mound and ditch marked the rank (that is, the wealth) of the *aire*. If his wealth consisted of chattels only, he was a *bó-aire*, or cow-*aire*. When he possessed ancestral land, which was no doubt one of the consequences of the Scotie conquest, he was a *faith* or lord, and was entitled to let his lands for grazing, to have a hamlet in which lived labourers, and to keep slaves. The larger fort with two or more ditches and ramparts was a *duin*, where the chieftain or *rí* lived, and kept his hostages if he had subreguli. The houses of all classes were of wood, chiefly wattles and wicker-work enclosing clay, and cylindrical in shape, with conical roofs thatched with rushes. The oratories were of the same form and material, but the larger churches and kingly banqueting halls were made of sawn boards. Bede, speaking of a church built by Finan at Lindesfarne, says, "nevertheless, after the manner of the Scots, he made it not of stone but of hewn oak and covered it with reeds." When St Malachy, who lived in the first half of the 12th century, thought of building a stone oratory at Bangor, it was deemed a novelty by the people, saying, "we are Scoti, not Galli." Long before this, however, stone churches had been built in other parts of Ireland, and many round towers. In some of the *cathraig* (sing. *cathir*), or stone forts, of the south-west of Ireland, the houses within the ramparts were made of stone in the form of a beehive, and similar "cloghans," as they are called, are found in the western islands of Scotland.

Here and there in the neighbourhood of the hamlets were patches of corn grown upon allotments that were annually exchangeable among the inhabitants. Around the *duine* and *ratha* the cultivation was better, for the corn land was the fixed property of the lord, and began to be enclosed by fences in the 7th and succeeding centuries. Oats was the chief corn crop, but wheat and barley were also grown,—chiefly, however, by the higher classes. The onion and the parsnip also were cultivated, and mark the first stage in kitchen gardening, which, as well as bee-keeping, was introduced by the church. Flax and the dye-plants (wood for blue and *ru*, a kind of madder, for red) were the chief industrial plants. Portions of the pasture lands were reserved as meadows. Tillage was rude, the spade and fork being of wood, though sometimes shod with iron. There are native names for the different parts of the plough, so we may assume that some form of that implement worked by oxen yoked together by a simple straight yoke was in use in the very early times. Wheeled carts were also known; the wheels were often probably only solid disks, though wheels formed of a hub, spokes, and felloes were used for chariots. The tilled land was manured. Droves of swine under the charge of swineherds wandered through the forests; some belonged to the chiefs, others to *latha* or lords, and others again to village communities. The house-fed pig was also an important object of domestic economy; its flesh—fresh, pickled, or in bacon—was much prized. Indeed, fresh pork was one of the inducements held out to visitors to *Tír Tairngire* or Elysium. Horned cattle constituted the chief wealth of the country, and were the standard



for estimating the worth of anything; for the Irish had no coined money, and carried on all commerce by barter. The unit of value was called a *seil* (pl. *seilte*), which appears to mean literally a jewel or precious object of any kind. There were several kinds of *seilte*, differing somewhat in value. The king's *seil* was a full-grown cow after her third calf; the normal *seil* was an average milch cow. Gold, silver, bronze, tin, clothes, and all other kinds of property were estimated in *seilte*, referred to the milch-cow as the standard. Three *seilte*, that is, three cows, were equal to a *cuimial*, a word signifying a female slave, which reveals an important feature of Irish society to which we shall revert. Sheep formed an important element of wealth in some parts of the country, and goats were numerous. The old laws draw a distinction between the working horse and the riding horse; both kinds appear to have been numerous and of good breed. Bee-cultivation was carefully attended to, the honey being used both for a kind of confectionery and for making mead-gin or mead. So important a place did bee-culture hold in the rural economy of the ancient Irish that the laws regarding bees still extant would fill a goodly volume.

The ancient Irish were a pastoral people, and therefore had certain nomadic habits. When they had sown their corn, they drove their herds and flocks to the mountains, where such existed, and spent the summer there, returning in autumn to reap their corn, and take up their residence in their sheltered winter residences. Where the tribe had land on the sea-coast they also appear to have migrated thither in summer. These habits explain the presence of diune, cathraig, and other forts on mountains and headlands. The chase in the summer occupied the freemen, not only as a source of enjoyment, but also as a matter of necessity, for wolves were very numerous. For this purpose they bred dogs of great swiftness, strength, and sagacity, which seem to have been much admired by the Romans.<sup>1</sup>

We have said that the residences within enclosing ramparts did not consist of one house with several apartments, but every room was a separate house. Thus, to take the residence of an air, he had the living house, in which he slept as well as took his meals, the women's house, in which spinning and other domestic work was carried on, the kitchen, the barn, the calf-house, the pigsty, and the sheep-house. In the residence of chiefs and *flatha* a sun-chamber or *gríanaan* was also provided for the mistress of the house, which in the large diune appears to have been put on the rampart, so as to escape the shadow of the latter. The round houses were made by making two basket-like cylinders, one within the other, and separated by an annular space of about a foot, by inserting upright posts in the ground and interweaving hazel wattles between, the annular space being filled with clay. Upon this cylinder was placed a conical cap, thatched with reeds or straw. The keel houses of many Highland gentlemen in the last century were made in this way, except that they were not round. The early Irish houses had no chimney; the fire was made in the centre of the house, and the smoke made its exit through the door or through a hole in the roof, as in the corresponding Gaulish and German houses. The introduction of chimneys probably led to the change in the form of the houses from round to oblong. Near the fire, fixed in a kind of candlestick, was a candle of tallow or raw bees-wax, which gave a lurid smoky flame; this marked a notable advance upon the use of a piece of bog-deal. Around the wall in the houses of the wealthy and higher classes were arranged the bedsteads, or rather compartments, with testers and fronts, which were sometimes of carved yew. The beds were made of skin stuffed with feathers. Wooden platters, drinking horns, and vessels of yew and bronze were displayed on dressers. Of pottery there was none. Large chests and cupboards for holding clothes, meal, and other things were placed in convenient places. In the halls of the kings, of whom there were several grades, the position of each person's bed and seat, and the joint of meat which he was entitled to receive from the *raunire*, or distributor, were regulated according to a rigid rule of precedence. The arms and horse trappings of the master of the house were also displayed on the walls; and in the king's house each person who had a seat in it had his shield suspended over him. Every king had hostages for the fealty of his vassals, who sat unarmed in the hall, and those who had become forfeited by a breach of treaty or allegiance were placed along the wall in fetters. The position of a hostage in ancient times was at best unpleasant, but when those who gave him in hostageship broke their engagements his lot was truly a hard one; he was fettered and his life was forfeited. There were places in the king's hall for the judge, the *filí* or poet, the harper, the various craftsmen, the juggler, and fool. The king had his bodyguard of four men always around him; these were freed men whom the king had delivered from slavery inherited from birth, or to which they had been condemned for crime or debt, for an insolvent debtor became in Ireland, as in Rome and indeed in most ancient societies, the property of his creditor. In an age of perpetual warfare and violence, the gratitude of a slave was esteemed a greater safeguard

than even the ties of blood,—a fact which suggests some curious reflexions concerning the origin of offices at the courts of kings.

There were also numerous attendants about a king's house and a *flatha's* house; these were a very miscellaneous body; among them were many Saxon slaves and the descendants of former slaves, for after the cessation of the Irish incursions a regular slave trade grew up, which was only abolished by the action of the church not long before the Norman invasion. These attendants slept on the ground, in the kitchen, or in cabins outside the fort. It was only the higher classes who were provided with beds, and in early times not even these. In the *Pfalz MS.* of Chünrat's Song of Kaiser Karl there is a picture of the emperor sleeping on the floor, so that the habit of the whole family sleeping in the hall in which they ate and drank was rather the rule than the exception among all the northern nations. The living room or hall we have been describing also served in part as a kitchen, for joints were roasted at the fire in winter, the soup boiler was suspended over it, the brewing vat was in it. The house we have called the kitchen was rather a room for grinding meal in hand-mills, a work done by females (who were slaves in the houses of *flatha* and kings), the making of bread, cheese, &c.

The children of the upper classes in Ireland were not reared at home, but were sent to some one else to be fostered. The children of the greater kings were generally fostered by minor kings, and even by kings of their own rank. The *ulann filí*, or chief poet, ranked in some respects with a tribe king, sent his sons to be fostered by the king of his own territory. The fosterage might be done for friendship or for some special advantage, but it was generally a matter of profit, and there are numerous laws extant fixing the cost, and regulating the food and dress of the foster child according to his rank. It was customary to educate together a number of youths of very different ranks, and the laws laid down regulations for the clothing, food, and other expenses of each grade. In like manner a number of maidens were fostered together, those of inferior rank serving as companions for the daughter of a king. The cost of the fosterage of boys seems to have been borne by the mother's property, that of the daughters by the father's. The ties created by fosterage were nearly as close and as binding on the children as those of blood. Fosterage was apparently the consequence of the marriage customs.

It has been stated above that pagan marriage customs survived the introduction of Christianity. Of this there is ample evidence. As among all tribal communities, the wealth of the contracting parties constituted the primary element of a legitimate marriage. The bride and bridegroom should be provided with a joint fortune proportionate to their rank. When the bride and bridegroom were of equal rank, and the sept of each contributed an equal share to the marriage portion, the marriage was legal in the full sense, and the wife was a wife of equal rank. If the bride were noble and the bridegroom not, the former had to contribute one-third of the marriage portion to fulfil the condition of equality. If the bridegroom was the son of a *flatha*, and the bride the daughter of a cow-ner, the former contributed one-third and the latter two-thirds. In this kind of marriage the husband and wife had equal rights over the joint property. The wife of equal rank was the chief wife in pagan times, and where the conditions were not fulfilled the woman occupied an inferior position, and might have another woman placed over her as principal wife. The church endeavoured to make the wife of a first marriage, that is, the wife according to canon law, the only true wife according to Irish law, but in this it is clear it did not at once succeed. The struggle between the marriage laws of the church and the ancient customs is curiously illustrated by the continuance of what according to canon and feudal law was concubinage, as a recognized condition of things according to Irish law. These marriages may be called contract marriages, and were of various kinds, depending mainly on questions of property, and were entered into with the cognizance of the man's chief wife and of his sept. When a woman had sons her position was greatly altered, and her position did not materially differ in some respects from that of a chief wife. As the tie of the sept was blood, all the acknowledged children of a man, whether legitimate or illegitimate according to canon and feudal law, belonged equally to his sept. Even adulterine bastardy was no bar to a man becoming chief or *ví* of his *tuath*, or tribe, as was shown in the case of Hugh O'Neill, earl of Tyrone. As all the children of a chief of household, of whatever rank, had equal rights in the sept, notwithstanding the efforts of the church to restrict those rights to the children of marriages according to canon law, it was necessary to commit their rearing and education to some one outside their own sept; hence the system of fosterage, which at one time prevailed in all Aryan communities, as did also no doubt the whole of the Irish marriage customs, which are a survival in a singularly complete and archaic form of customs which had died out elsewhere under the influence of Roman and canon law.

The food of the ancient Irish was very simple, and their table service equally so. The former consisted mainly of cakes of oaten meal, cheese, curds, milk, butter, and the flesh of all the domestic

<sup>1</sup> Symmachus, *Epist.* II. 77.

animals fresh and salted. In the 8th century at all events wheat and barley meal were also used by the better classes. The legendary food of the Land of Promise consisted of fresh pork, new milk, and ale. Of course fish, especially the salmon, and game are also to be added to the list. The opsonia were very limited—onions and watercresses. The food of the monks was chiefly oaten bread, milk, and curd-cheese. The chief drink was ale, the right to brew it being apparently confined to flatha, as was the case in many parts of Germany down to the end of the Middle Ages. It seems to have been expected that a flath should be generous to his vassals, retainers, and all those about him; the word for open-handedness in Irish, *flaitheamhuil*, is derived from his name; an aphorism fixes the time at which he was expected to be bountiful, "for he is not a lawful flath who does not distribute ale on a Sunday." All the business of the sept and triba was conducted in the ale-house or *cuirmteach*, as the chief men of the tribe were called its props,—*aabaid cuirmteigi*. The bards chanted poems, and songs were sung to the music of a kind of harp, called a *crúot*, or of a bowed instrument called a *timpan*; stories were also told, and the guests of the ale-house were content to hear the same story over and over again. The ollam fili, who only told his story to kings, was, however, expected to know more than seven times fifty great and small stories. The amusements were also varied by the jokes of the fool and the tricks of the juggler, as in the baronial halls of the Normans at a later period.

The dress of the upper classes was similar to that of a Scottish Highlander before it degenerated into the present conventional garb of a Highland regiment. It consisted first of the *lenn*, a kind of loose shirt generally of woollen cloth (but linen ones are mentioned), reaching a little below the knees of men, and forming what is now called the kilt. This garment was of different colours, some being spotted, checkered, and variegated, each tribe or clan having apparently special colours. It would also seem that the number of colours in the dress indicated the rank of the wearer. The *lenna* of kings and the wealthy flatha were embroidered, furnished with borders, and even fringe of gold is mentioned. Over the *lenn* came the *inar*, a kind of closely fitting tunic reaching to the hips, and bound around the waist by the *criss*, a girdle or scarf often of some rich colour, especially purple, and frequently, in the case of the men's, the gift of a woman. The *inar* or jacket appears to have been open at the breast so as to show off the embroidery of the *lenn*. Over the left shoulder, and fastened with a brooch, hung the *brat*, a shawl or plaid like the modern Scottish one. This garment replaced the skin or fur of a wild beast of earlier times, and the brooch the thorn with which it was fastened. The brooches were often of beautiful workmanship, as is shown by the numerous examples exhibiting endless variety of design which are now preserved in museums. The legs were bare or covered with a kind of leggings or hose fastened by thongs; the feet were entirely naked or encased in shoes of raw-hide also fastened with thongs. The only difference between the dress of men and women was that the *lenn* of the latter reached nearly to the ankles and formed a petticoat instead of a kilt. The freemen wore their hair long and prided themselves on its curling into ringlets. They sometimes confined it at the back of the head in a conical spiral of bronze, silver, or gold. The women also wore their hair long, and braided it into tresses, which they confined with a pin. The beard was worn long, and was carefully cultivated, being often plaited into tresses. This men as well as women, like all ancient and semi-barbarous people, were fond of ornaments. They tattooed figures with wood on their bodies like the Britons and Picts, as we learn from a glass in a MS. of St Gall,<sup>1</sup> and also from Isidore.<sup>2</sup> They covered their fingers with rings, their arms with bracelets; they wore torques or twisted rings of gold about the neck, such as we see on the celebrated antique sculpture of the Gaul, known as the "Dying Gladiator." The richer and more powerful kings wore a similar torque about the waist, and a golden *mind* or diadem on state occasions. Every woman of rank wore finger rings, bracelets, earrings, and a *lann* or crescent-shaped blade of gold on the front of the head, from which hung behind a veil. The queens also wore a golden *mind* or diadem on state occasions. The *mind* was so attached to a veil or some kind of headdress that it seems to have formed a complete covering for the head. Ladies also had carved combs, and ornamental work boxes; they used oil for the hair, and dyed their eyelashes black with the juice of a berry, and their nails crimson with a dye like archil. The *lenn* or kilt seems to have been the garb of freemen only; the men of the servile classes wore *bracæe* or tight-fitting breeches reaching to near the ankles, the upper part of the body being either left altogether naked, or covered by a short cloak without sleeves. In winter all classes appear to have worn a long coat or cloak with a *cochull* or hood. The Gauls used a similar kind of hooded cloak, which became fashionable in Rome. Coats or cloaks

of this kind made of a brown frieze were regarded in the 7th and 8th centuries as peculiarly Irish, owing no doubt to the great number of missionaries and scholars from Ireland who wandered over Europe clothed in such long cloaks, with a book wallet and a kind of leather bottle slung on their shoulders, and a thick knotted staff in the hand. It is from them the Benedictine monks borrowed the dress which has since become the characteristic habit of religious orders. The name cowl in English, and all the cognate forms in other languages, are no doubt from the Gaulish word corresponding to the Irish *cochull*. The two Irishmen who accompanied the Icelandic, Thorfinn Karlsefussion, in his voyage from Greenland when he discovered America in the 9th century, wore coats which are called by the same name which the Northmen gave the monk's cowl.

The principal weapon of the Irish soldiers was a pike or lance with a very long handle; some were also armed with a short sword suspended by a belt across the shoulder, and a shield. It is probable that bronze lance-heads and swords were used down to early Christian times, and even later, though the use of iron weapons must have been known from the period of the Scotie invasions of Britain. The shields were of two kinds:—one a light round or slightly oval wooden target covered with hide, and in earlier times in the case of rich warriors a bronze disk with numerous bosses, backed with wood; and the other the *sciath* or oblong bulged shield of wicker work covered with hide. Some carried stone hammers or war axes, and in the 9th and succeeding centuries an iron one, the use of which was learned from the Northmen. War-hats, cuirasses, and other defensive armour were very little if at all used before the Danish wars. In Irish legendary tales some of the heroes are equipped in leather cuirasses, and wear crested helmets and war-hats, but these are no doubt interpolations in the narrative of later times.

The *tuath* or territory of a *ri* or king was divided among the septs. The lands of a sept (*fine*) consisted of the estates in severalty of the lords (*flatha*), and of the *ferand duthaig* or common lands of the sept. The dwellers on each of these kinds of land differed materially from each other. On the former lived a motley population of slaves, horse boys, and mercenaries composed of broken men of other clans, many of whom were fugitives from justice (*macca baís*, literally "sons of death"), &c., possessing no rights either in the sept or tribe, and entirely dependent on the bounty of the lord, and consequently living about his fortified residence. The poorer servile classes, or cottiers, wood cutters, swine herds, &c., who had right of domicile (acquired after three generations), lived here and there in small hamlets on the mountains and poorer lands of the estate. The good lands were let to a class of tenants called *fuidirs*, of whom there were several kinds, some grazing the land with their own cattle, others receiving both land and cattle from the lord. *Fuidirs* had no rights in the clan or sept; some were true serfs, others tenants-at-will; they lived in scattered homesteads like the farmers of the present time. The lord was responsible before the law for the acts of all the servile classes on his estates, both new comers and *scuehleithe*, i. e., descendants of *fuidirs*, slaves, &c., whose families had lived on the estate during the time of three lords. He paid their blood-fines, &c., and received compensation for their slaughter, maiming, or plunder. The *fuidirs* were the chief source of a lord's wealth, and he was consequently always anxious to increase them.

As every man in a fine or sept had a right to build a house on the *ferand duthaig* or common land, the size of the house and extent of land which might be permanently enclosed as a yard or lawn depending upon the rank of the man, that is, upon his wealth, the clansmen occupied chiefly isolated homesteads and cabins; some of the latter being occasionally grouped in hamlets. Clansmen who possessed twenty-one cows and upwards were *airig* (sing. *aire*), or as we should say had the franchise, and might fulfil the functions of bail, witness, &c. When an *aire* died his family did not always divide the inheritance, but formed "a joint and undivided family" the head of which was an *aire*, and thus kept up the rank of the family. Three or four poor clansmen might combine their property and agree to form a "joint family," one of whom as the head would be an *aire*. In consequence of this organization the homesteads of *airig* included several families—those of his brothers, sons, &c. A rich *bo-aire* (cow-*aire*, i. e., an *aire* whose wealth consisted in cattle) was allotted a certain portion of the common land in consideration of affording hospitality to travellers entitled to free quarters from the clan; he was called a *bríugad* (q. n. *bríugad*) or *bríugfer*, that is, man of the *bróg* or *lurg*. He acted as a kind of rural magistrate, and the meetings of a clan for the election of the *ri* took place at his house or *bróg*. The stock of a *bo-aire* was partly his own and partly the gift of the chief. Every man was bound to accept stock from the chief proportionate to his rank; in return he was obliged to pay a certain customary tribute (*bés tigi*, house tribute). A man might also agree to take more stock

<sup>1</sup> Schemate: pictura in corpore[] equales Scotti pingunt.—Gloss in a St Gall MS. in Hattner's *Denkmale*, i. 227, 233.

<sup>2</sup> Scotti propriis lingua nomen habent a picto corpore, eo quod aculeis ferreis cum atramento variarum figurarum stigmati[]s anctentur.—Isidore of Seville, *Orig.*, lib. ix. c. 2.

<sup>3</sup> "Ascopam, i. e., flavonem similem utri de oculis factam, sicut solent Scotones habere."—Gloss of a St Gall MS. of the 9th century in Hattner's *Denkmale*, i. 237.



and pay rent in kind. Such men, whose position was, however, thereby much altered, were called *biathachs* (from *biad*, food). A man might with the consent of his sept enter into a similar contract with the chieftain of another sept, so that the *biathachs* or *virtualiers* included also some of those called *fuidirs*. A lord might receive his *biad* or food at his own residence, or go to the house of his *biathach* accompanied by a retinue and eat it there, or send his mercenaries, horses, dogs, &c., there, to be supported, which was the usual way. The *biathachs* were consequently liable to suffer great oppression.

The professions accounted noble, such as those of *conna* (wisdom), which included law and medicine, and *filidecht* or divination, which in Christian times was that of the bards or rhymesters, formed a number of schools each under an *ollam* or doctor, who was provided with mensal land for the support of himself and his scholars. He was also entitled to free quarters for himself and a retinue, including dogs and horses, so that when he travelled he had a kind of ambulatory school with him. The *ollam bretheman* or chief of a law school was the chief *brithem* (brehon or judge) of his tuath. The *tiag* or leech had also his apprentices, and treated his surgical patients in his own house. The harper, the *cord* or artist in metals, and the smith were also provided with mensal land, and gave their skill and the product of their labour as their *bés tigi* or customary tribute in return for the gifts bestowed by their chief.

Popular assemblies, which were held in the open air, were of various kinds; thus the *mechel fatha* was a gathering of the vassals of a lord to reap his corn, clear his roads, &c. The fine or sept had its special meeting, summoned by the air fine or chief of the sept for many purposes, such as the assessment of blood-fines due from the sept, and the distribution of those due to it. The clan had also its gathering to deliberate on important questions, such as peace and war, in which every air or fully qualified clansman had a voice. The most important of all popular assemblies was, however, the *oeneach* or fair, summoned by a king, those summoned by the kings of provinces having the character of national assemblies. The *oeneach* had a fourfold object:—(1) the promulgation of laws, and the rehearsal of pedigrees upon which depended the succession of the princes; (2) the recitation of poetry and tales, musical contests, exhibition of works of artists in metals, &c., and the award of prizes to the professional classes; (3) popular sports, such as horse-racing, wrestling, &c.; and (4) the barter of all kinds of wares. The *oeneach* in pagan times was an essentially religious festival celebrated in the great cemeteries, each clan, and in the minor fairs each sept, holding its assembly on the grave mound of their ancestors. Nor did it entirely lose its religious character in Christian times, for the *oeneach* opened and closed with religious ceremonies. The women and men assembled in separate *airechts* or gatherings, and no man durst enter the women's *airecht* under pain of death. The *brithem* (brehon) or judge seated on a stone chair raised above the heads of the people delivered his judgment, the *aidid* recounted the pedigrees of the chiefs, the *filid* sounded their praises and told the deeds of the clans in verse, the *corda* or artists in metal exhibited their work. Foreign traders came thither with their wares, which they exchanged for native produce, especially for the coarse woollen fabrics which even in the 8th century were celebrated on the continent. Every one was expected to appear at the *oeneach* or fair in his or her best clothes and ornaments, and careful provision was made by the law to prevent creditors from unjustly withholding ornaments pledged with them on the occasion of a fair. Crimes committed at an *oeneach* or other solemn assembly could not be commuted by payment of fines. The inauguration of a king to take place at some sacred place where there was an ancient tree or grove, the *noemel* of the clan, the cutting down of which was the greatest insult a conqueror could offer to the conquered. (W. K. S.)

#### History from the Anglo-Norman Invasion.

Hadrian's bull. Nicholas Breakspeare, known in history as Hadrian IV., was the only Englishman who ever filled the papal chair. Urged by the ambition proper to his office, and perhaps by an Englishman's natural pride in being able to confer favours on a king of England, he granted a bull to Henry II. in 1155 which contains this passage:—"There is no doubt, and your nobility acknowledges, that Ireland and all islands upon which Christ the Sun of righteousness has shone, and which have received the teachings of the Christian faith, rightfully belong to the blessed Peter and the most holy Roman Church." Believing that Henry was likely to use his power for the good of religion and of the church, he granted Ireland to him, reserving all ecclesiastical rights, and making one penny from each house payable yearly to St Peter.

In 1156 Dermot MacMurrough, deposed for his tyranny

from the kingdom of Leinster, repaired to Henry in Aquitaine. The king was busy with the French, but gladly seized the opportunity of asserting his claim, and gave Dermot a letter authorizing him to raise forces in England. Thus armed, and provided with gold extorted from his former subjects in Leinster, Dermot went to Bristol and sought the acquaintance of Richard de Clare, a Norman noble of great ability but broken fortunes. Earl Strongbow, whom later usage has named Strongbow, agreed to reconquer Dermot's kingdom for him. The stipulated consideration was the hand of Eva his only child, and according to feudal law his sole heiress, to whose issue lands and kingdoms would naturally pass. But Irish customs admitted no estates of inheritance, and Eva had no more right to the reversion of Leinster than she had to that of Japan. It is likely that Strongbow had no conception of this, and that his first collision with the tribal system was an unpleasant surprise. Passing through Wales, Dermot agreed with Robert Fitzstephen and Maurice Fitzgerald to invade Ireland in the ensuing spring.

About the 1st of May 1169 Fitzstephen landed on the Wexford shore with a small force carefully chosen from among the Welsh youth, and next day Maurice de Prendergast brought another band nearly to the same spot. Dermot joined them, and the Danes of Wexford soon submitted. According to agreement Dermot granted the territory of Wexford, which had never belonged to him, to Robert and Maurice and their heirs for ever. And here begins the conflict between feudal and tribal law, which was destined to deluge Ireland in blood. Maurice Fitzgerald soon followed with a fresh detachment. About a year after the first landing Raymond Le Gros was sent over by Earl Richard with his advanced guard, and Strongbow himself landed near Waterford on the 23d August 1170 with 200 knights and about 1000 other troops.

The natives did not understand that this invasion was quite different from those of the Danes. They made alliances with the strangers to aid them in their intestine wars, and the annalist writing in later years (*Annals of Lough Cé*) describes with pathetic brevity the change wrought in Ireland:—"Earl Strongbow came into Erin with Dermot MacMurrough to avenge his expulsion by Roderick, son of Turlough O'Connor; and Dermot gave him his own daughter and a part of his patrimony, and Saxon foreigners have been in Erin since then."

Most of the Norman leaders were near relations, many being descended from Nesta, daughter of Rhys Ap Tudor, prince of South Wales, the most beautiful woman of her time, and mistress of Henry I. Her children by that king were called Fitzhenry. She afterwards married Gerald de Windsor, by whom she had three sons:—Maurice, ancestor of all the Geraldines; William, from whom sprang the families of Fitzmaurice, Carew, Grace, and Gerard; and David, who became bishop of St David's. Nesta's daughter Angareth, married to William de Barri, bore Geraldus Cambrensis, and was ancestress of the Irish Barries. Raymond Le Gros, Hervey de Montmorency, and the Cogans were also descendants of Nesta, who, by her second husband Stephen the Castellan, was mother of Robert Fitzstephen. Further details must be sought in Geraldus. His prejudices and credulity make him an unsafe guide about Irish customs, but there is no valid reason to reject his statements as to his own kinsmen.

While waiting for Strongbow's arrival, Raymond and Hervey were attacked by the Waterford Danes, whom they overthrew. Seventy prisoners were thrown over a cliff into the sea. Strongbow himself took Waterford and Dublin, and the Danish inhabitants of both readily combined with their French-speaking kinsfolk, and became firm supporters of the Anglo-Normans against the native Irish.

Landing of Anglo-Normans

Henry II. Alarmed at the principality forming near him, Henry invaded Ireland in person, having first had Hadrian's grant confirmed by Alexander III., so as to gain the support of the Irish clergy. He landed near Waterford 18th October 1172. Giraldus says he had 500 knights and many other soldiers; Regan, the metrical chronicler, says he had 4000 men, of whom 400 were knights; the *Annals of Lough Cé* that he had 240 ships. The Irish writers tell little about these great events, except that the king of the Saxons took the hostages of Munster at Waterford, and of Leinster, Ulster, Thomond, and Meath at Dublin. They did not take in the grave significance of doing homage to a Norman king, and becoming his "man."

Henry's farthest point westward was Cashel, where he received the homage of Donald O'Brien, king of Thomond, but does not appear to have been present at the famous synod. Christian O'Conarchy, bishop of Lismore and papal legate, presided, and the archbishops of Dublin, Cashel, and Tuam attended with their suffragans, as did many abbots and other dignitaries. The primate of Armagh, the saintly Gelasius, was absent, and presumably his suffragans also, but Giraldus says he afterwards came to the king at Dublin, and favoured him in all things. Henry's sovereignty was acknowledged, and constitutions made which drew Ireland closer to Rome. In spite of the "enormities and filthinesses," which Giraldus says defiled the Irish Church, nothing worse could be found to condemn than marriages within the prohibited degrees, and trifling irregularities about baptism. Most of the details rest on the authority of Giraldus only, but the main facts are clear. The synod is not mentioned by the Irish annalists, nor by Regan, but it is by Hoveden and Ralph de Diceto. The latter says it was held at Lismore, an error arising from the president having been bishop of Lismore. Tradition says the members met in Cormac's chapel.

Roderick Henry at first tried to be suzerain without displacing the natives, and received the homage of Roderick O'Connor, hitherto considered head king. But the adventurers were uncontrollable, and he had to let them conquer what they could, exercising a precarious authority over the Normans only through a viceroy. Fitzadelm and other early governors seemingly had orders to deal as fairly as possible with the natives, and this involved them in quarrels with the "conquerors," whose object was to carve out principalities for themselves, and who only nominally respected the sovereign's wishes. One is forcibly reminded of the squabbles of the crusaders. The mail-clad knights were not uniformly successful against the natives, but they generally managed to occupy the open plains and fertile valleys. Geographical configuration preserved centres of resistance,—the O'Neills in Tyrone and Armagh, the O'Donaells in Donegal, and the Macarthies in Cork being the largest tribes that remained practically unbroken. On the coast from Bray to Duudalk, and by the navigable rivers of the east and south coasts, the Norman put his iron foot firmly down.

John, Prince John landed at Waterford in 1185, and the neighbouring chiefs hastened to pay their respects to the king's son. Prince and followers alike soon earned hatred, the former showing the incurable vices of his character, the latter pulling the beards of the chieftains. After eight disgraceful months he left the government to De Courcy, but retained the title "Dominus Hiberniæ." It was even intended to crown him; and Urban III. sent a licence and a crown of peacock's feathers, which was never placed on his head. Had Richard I. had children Ireland might have become a separate kingdom.

Henry granted Meath, about 800,000 acres, to Hugo de Lacy, reserving scarcely any prerogative to the crown, and

making his vassal almost independent. De Lacy sublet the land among kinsmen and retainers, and to his grants the families of Nugent, Tyrell, Nangle, Tuyst, Fleming, and others owe their importance in Irish history. It is not surprising that the Irish bordering on Meath should have thought De Lacy the real king of Ireland; the following passage from the *Annals of Lough Cé* is worth quoting:—"The son of the king of the Saxons went across afterwards to complain of Hugo de Lacy to his father; for it was Hugo de Lacy that was king of Erin when the son of the king of the Saxons came, and he permitted not the men of Erin to give tribute or hostages to him."

During his brother's reign John's viceroy was William Marshal, earl of Pembroke, who married Strongbow's daughter by Eva, and thus succeeded to his claims in Leinster. John's reputation was no better in Ireland than in England. He thwarted or encouraged the Anglo-Normans as best suited him, but on the whole they increased their possessions. In 1210 the excommunicated king visited Ireland again, and being joined by Cathal Crovderg O'Connor, king of Connaught, marched almost unchallenged by De Lacy from Waterford by Dublin to Carrickfergus. Thus, with the aid of Irish allies, did Henry II.'s son chastise the sons of those who had given Ireland to the crown. John did not venture farther west than Trim, but most of the Anglo-Norman lords swore fealty to him, and he divided the partially obedient districts into twelve counties—Dublin (with Wicklow), Meath (with Westmeath), Louth, Carlow, Kilkenny, Wexford, Waterford, Cork, Limerick, Kerry, and Tipperary. John's resignation of his kingdom to the pope in 1213 included Ireland, and thus for the second time was the papal claim to Ireland formally recorded.

During Henry III.'s long reign the Anglo-Norman power increased, but underwent great modifications. Richard, earl marshal, grandson of Strongbow, and to a great extent heir of his power, was foully murdered by his own feudatories—men of his own race; and the colony never quite recovered this blow. On the other hand the De Burghs, partly by alliance with the Irish, partly by sheer hard fighting, made good their claims to the lordship of Connaught, and the western O'Connors henceforth play a very subordinate part in Irish history. Tallage was first imposed on the colony in the first year of this reign, but yielded little, and tithes were not much better paid.

On the 14th January 1217 the king wrote from Oxford to his justiciary, Geoffrey de Marisco, directing that no Irishman should be elected or preferred in any cathedral in Ireland, "since by that means our land might be disturbed, which is to be deprecated." This order was annulled in 1224 by Honorius III., who declared it "destitute of all colour of right and honesty." The pope's efforts failed, for in the 14th century several Cistercian abbeys excluded mere Irishmen, and as late as 1436 the monks of Abingdon complained bitterly that an Irish abbot had been imposed on them by lay violence. Parliament was not more liberal, for the statute of Kilkenny, passed in 1366, ordained that "no Irishman be admitted into any cathedral or collegiate church, nor to any benefice among the English of the land," and also "that no religious house situated among the English shall henceforth receive an Irishman to their profession." This was solemnly confirmed by the English parliament in 1416, and an Irish Act of Richard III. enabled the archbishop of Dublin to collate Irish clerks for two years, an exception proving the rule. Many Irish monasteries admitted no Englishmen, and at least one attempt was made, in 1250, to apply the same rule to cathedrals. The races remained nearly separate, the Irish simply staying outside the feudal system. If an Englishman slew an Irishman (except one

Richard I. (1189-99).

King John in Ireland.

Henry III. (1216-72).

Objections to Irish clergy.

Separation of the two races.

Henry II. in Ireland.

Irish Church submits.

Roderick submits.

John, lord of Ireland.



of the five regal and privileged bloods) he was not to be tried for murder, for Irish law admitted composition (erick) for murder. In Magna Charta there is a proviso that foreign merchants shall be treated as English merchants are treated in the country whence the travellers came. When Henry III. sent the letter against Irish clerks, Quilo the papal legate was chief minister, and the king a child of eleven years. Yet some enlightened men strove to fuse the two nations together, and the native Irish, or that section which bordered on the settlements and suffered great oppression, offered 8000 marks to Edward I. for the privilege of living under English law. The justiciary supported their petition, but the prelates and nobles refused to consent.

Edward I. (1272-1307). There is a vague tradition that Edward I. visited Ireland about 1256, when his father ordained that the prince's seal should have regal authority in that country. A vast number of documents remain to prove that he did not neglect Irish business. Yet this great king cannot be credited with any specially enlightened views as to Ireland. Hearing with anger of enormities committed in his name, he summoned the viceroy D'Ufford to explain, who coolly said that he thought it expedient to wink at one knave cutting off another, "whereat the king smiled and bade him return into Ireland." The colonists were strong enough to send large forces to the king in his Scotch wars, but as there was no corresponding immigration this really weakened the English, whose best hopes lay in agriculture and the arts of peace, while the Celtic race waxed proportionally numerous. Outwardly all seemed fair. The De Burghs were supreme in Connaught, and English families occupied eastern Ulster. The fertile southern and central lands were dominated by strong castles. But Tyrone and Tyrconnel, and the mountains everywhere, sheltered the Celtic race, which, having reached its lowest point under Edward I., began to recover under his son.

Edward II. (1307-27). In 1315, the year after Bannockburn, Edward Bruce landed near Larne with 6000 men, including some of the best knights in Scotland. Supported by O'Neill and other chiefs, and for a time assisted by his famous brother, Bruce gained many victories. The Scots ranged at will over great part of Ireland, but the brothers never took Dublin, though they came as near it as Castleknock. There was no general effort of the natives in their favour; perhaps the Irish thought one Norman no better than another, and their total incapacity for national organization forbade the idea of a native sovereign. The family quarrels of the O'Connors at this time, and their alliances with the Burkes, or De Burghs, and the Birminghams, may be traced in great detail in the annalists,—the general result being fatal to the royal tribe of Connaught, which is said to have lost 10,000 warriors in the battle of Templetogether. In other places the English were less successful, the Butlers being beaten by the O'Carrolls in 1318, and Richard de Clare falling about the same time in the decisive battle of Dysert O'Dea. The O'Briens re-established their sway in Thomond and the illustrious name of De Clare disappears from Irish history. Edward Bruce fell in battle near Dundalk, most of his army recrossing the channel, and leaving behind a reputation for cruelty and rapacity. Indeed the invaders were generally hated, and have had little thanks either from Irish or colonial chroniclers. The colonists were victorious, but their organization was undermined, and the authority of the crown, which had never been able to keep the peace, grew rapidly weaker. Within twenty years after the great victory of Dundalk, the quarrels of the barons allowed the Irish to recover much of the land they had lost.

Edward III. (1327-77). John de Birmingham, earl of Louth, the conqueror of Bruce, was murdered in 1329 by the Gernons, Cusacks, Everards, and other English of that county, who disliked

his firm government. They were never brought to justice. Talbot of Malahide and two hundred of Birmingham's relations and adherents were massacred at the same time. In 1333 the young earl of Ulster was murdered by the Mandevilles and others; in this case signal vengeance was taken, but the feudal dominion never recovered the blow, and on the north-east coast the English laws and language were soon confined to Drogheda and Dundalk. The earl left one daughter, Elizabeth, who was of course a royal ward. She married Lionel, duke of Clarence, and from her springs the royal line of England from Edward IV., as well as James V. of Scotland and his descendants.

The two chief men among the De Burghs were loth to hold their lands of a little absentee girl. Having no grounds for opposing the royal title to the wardship of the heiress, they abjured English law and became Irish chieftains. As such they were obeyed, for the king's arm was short in Ireland. Sir William appropriated Mayo as the Lower (Oughter) M'William, and the earldom of Mayo perpetuates the memory of the event. Sir Edmund as the Upper (Eighter) M'William took Galway, and from him the earls of Clanricarde afterwards sprung.

Edward III. being busy with foreign wars had little time to spare for Ireland, and the native chiefs everywhere seized their opportunity. Dublin was forced to pay blackmail to M'Murrough, and the northern settlements fared no better. In 1348 O'Kennedy drove the Cogans and Cantwells from their lands in North Tipperary, and burned Nenagh to the castle walls under the eyes of Ormonde's governor. In 1318 Brian O'Brien left Clare, and established himself in Tipperary, founding the family of M'Brien Arra. Perhaps the most remarkable of these aggressive chiefs was Lysaght O'More, who reconquered Leix. Clyn the Franciscan annalist, whose Latinity is so far above the mediæval level as almost to recall Tacitus, sums up Lysaght's career epigrammatically:—"He was a slave, he became a master; he was a subject, he became a prince (de servo dominus, de subjecto princeps effectus)."

The two great earldoms whose contests form a large part of the history of the south of Ireland were created by Edward III. James Butler, eldest son of Edmund, earl of Carrick, became earl of Ormonde and palatine of Tipperary in 1328. Next year Maurice Fitzthomas Fitzgerald was made earl of Desmond, and from his three brethren descended the historic houses of the White Knight, the knight of Glyn, and the knight of Kerry. The earldom of Kildare dates from 1316. In this reign too was passed the statute of Kilkenny, a confession by the crown that obedient subjects were the minority. The enactments against Irish dress and customs, and against marriage and fostering proved a dead letter.

In two expeditions to Ireland Richard II. at first overcame all opposition, but neither had any permanent effect. Richard II. (1377-99). Art M'Murrough, the great hero of the Leinster Celts, practically had the best of the contest. The king in his despatches divided the population into Irish enemies, Irish rebels, and English subjects. As he found them so he left them, lingering in Dublin long enough to lose his own crown. But for M'Murrough and his allies the house of Lancaster might never have reigned. No English king again visited Ireland until James II., declared by his English subjects to have abdicated, and by the more outspoken Scots to have forfeited the crown, appealed to the loyalty or piety of the Catholic Irish.

Henry IV. (1399-1413). Henry IV. had a bad title, and his necessities were conducive to the growth of the English constitution, but fatal to the Anglo-Irish. His son Thomas was viceroy in 1401, but did very little. "Your son," wrote the Irish council to Henry, "is so destitute of money that he has not a penny in the world, nor can borrow a single penny,

because all his jewels and his plate that he can spare, and those which he must of necessity keep, are pledged to lie in pawn." The nobles waged private war unrestrained, and the game of playing off one chieftain against another was carried on with varying success. The provisions of the statute of Kilkenny against trading with the Irish failed, for markets cannot exist without buyers.

Henry V. (1413-22) The brilliant reign of Henry V. was a time of extreme misery to the colony in Ireland. Half the English-speaking people fled to England, where they were not welcome. The Act of 1 Henry V. c. 8 ordered all "Irishmen and Irish clerks, beggars, called chamber deacons, to depart before the feast of All Souls, for quietness and peace in this realm of England." Soldiers were drawn by high pay to Henry's French wars, and a contemporary writer, Robert Redman, recounts how they "with very sharp and missile balls (catapultariis pilis) wounded their enemies severely, easily avoiding their onset by their own swiftness of foot. Their valour in that siege (of Rouen) was remarkable. . . . They showed very great animosity to the French, whom they plundered of their goods, and whose children they seized by force as slaves to the English, after the price had been fixed by bargaining." The Irish wars had not been a good school of humanity.

Henry VI (1422-61) The disastrous reign of the third Lancastrian completed the discomfiture of the original colony in Ireland. Quarrels between the Ormonde and Talbot parties paralysed the Government, and a "Pale" of 30 miles by 20 was all that remained. Even the walled towns, Kilkenny, Ross, Wexford, Kinsale, Youghal, Clonmel, Kilmallock, Thomastown, Fethard, and Cashel, were almost starved out; Waterford itself was half ruined and half deserted. Only one parliament was held for thirty years, but taxation was not remitted on that account. No viceroy even pretended to reside continuously. The north and west were still worse off than the south. Some thoughtful men saw clearly the danger of leaving Ireland to be seized by the first chance comer and the *Libel of English Policy*, written about 1436, contains a long and interesting passage declaring England's interests in protecting Ireland as "a botersasse and a poste" of her own power. Sir John Talbot, immortalized by Shakespeare, was several times viceroy; he was almost uniformly successful in the field, but feeble in council. He held a parliament at Trim which made one law against men of English race wearing moustaches, lest they should be mistaken for Irishmen, and another obliging the sons of agricultural labourers to follow their father's vocation under pain of fine and imprisonment. The earls of Shrewsbury are still earls of Waterford, and retain the right to carry the white staff as hereditary stewards, but the palatinate jurisdiction over Wexford was taken away by Henry VIII. The Ulster annalists estimate the great Talbot very differently from Shakespeare:—"A sou of curses for his venom and a devil for his evils; and the learned say of him that there came not from the time of Herod, by whom Christ was crucified, any one so wicked in evil deeds" (*O Donovan's Four Masters*).

In 1419 Richard, duke of York, right heir by blood to the throne of Edward III., was forced to yield the regency of France to his rival Somerset, and to accept the Irish viceroyalty. He landed at Howth with his wife Cicely Neville, the beautiful Rose of Raly, and Margaret of Anjou hoped thus to get rid of one who was too great for a subject. The Irish government was given to him for ten years on unusually liberal terms. He ingratiated himself with both races, taking care to avoid identification with any particular family. At the baptism of his son—"false, fleeing, perjured Clarence"—who was born in Dublin Castle, Desmond and Ormonde stood sponsors together. In legislation Richard fared no better than

others. The rebellion of Jack Cade, claiming to be a Mortimer and cousin to the duke of York, took place at this time. This adventurer, at once ludicrous and formidable, was a native of Ireland, and was thought to be put forward by Richard to test the popularity of the Yorkist cause. Returning suddenly to England in 1450, Richard left the government to James, earl of Ormonde and Wiltshire, who had married Lady Eleanor Beaufort, and was deeply engaged on the Lancastrian side. This earl began the deadly feud with the house of Kildare which lasted for generations. After Blore Heath Richard was attainted by the Lancastrian parliament, and returned to Dublin, where the colonial parliament acknowledged him and assumed virtual independence. A separate coinage was established, and the authority of the English parliament was repudiated. William Overy, a bold squire of Ormonde's, offered to arrest Richard as an attainted traitor, but was seized, tried before the man whom he had come to take, and hanged, drawn, and quartered. The duke only maintained his separate kingdom about a year. His party triumphed in England, but he himself fell at Wakefield.

Among the few prisoners taken on the bloody field of Towton was Ormonde, whose head long adorned London Bridge. He and his brothers were attainted in England and by the Yorkist parliament in Ireland, but the importance of the family was hardly diminished by this. For the first six years of Edward's reign the two Geraldine earls engrossed official power. The influence of Queen Elizabeth Woodville, whom Desmond had offended, then made itself felt. Tiptoft, earl of Worcester, became deputy. He was an accomplished Oxonian, who made a speech at Rome in such good Latin as to draw tears from the eyes of that great patron of letters Pope Pius II. (*Aeneas Sylvius*). But his Latinity did not soften his manners, and he was thought cruel even in that age. Desmond was beheaded, ostensibly for using Irish exactions, really, as the partisans of his family hold, to please Queen Elizabeth. The remarkable lawlessness of this reign was increased by the practice of coining. Several mints had been established since Richard of York's time; the standards varied, and imitation was easy.

During Richard III's short reign the earl of Kildare, Richard head of the Irish Yorkists, was the strongest man in Ireland. He espoused the cause of Lambert Simnel (1487), whom the Irish in general seem always to have thought a true Plantagenet. The Italian primate, Octavian de Palatio, knew better, and incurred the wrath of Kildare by refusing to officiate at the impostor's coronation. The local magnates and several distinguished visitors attended, and Lambert was shown to the people borne aloft on "great D'Arcy of Platten's" shoulders. His enterprise ended in the battle of Stoke, where the flower of the Anglo-Irish soldiery fell. "The Irish," says Bacon, "did not fail in courage or fierceness, but, being almost naked men, only armed with darts and spears, it was rather an execution than a fight upon them." Conspicuous among Henry's adherents in Ireland were the citizens of Waterford, and who, with the men of Clonmel, Callan, Fethard, and the Butler connexion generally, were prepared to take the field in his favour. Waterford was equally conspicuous some years later in resisting Perkin Warbeck, who besieged it unsuccessfully, and was chased by the citizens, who fitted out a fleet at their own charge. The king conferred honour and rewards on the loyal city, to which he gave the proud title of *urbis intacta*. Many doubtless believed that Perkin was really the duke of York; but it is now certain that he was an impostor, Mr Gairdner's researches having quite dispelled the "historic doubts" with which Horace Walpole and many smaller mystery-moogers amused their excessive leisure. Other events of this reign were the parliament of Drogheda, held



by Sir Edward Poyning, which gave the control of Irish legislation to the English council (the great bone of contention in the later days of Flood and Grattan), and the battle of Knocktew, in which the earl of Kildare used the viceregal authority to avenge a private quarrel.

Henry VIII.  
(1509-47).

Occupied in pleasure or foreign enterprise, Henry VIII. at first paid little attention to Ireland. The royal power was practically confined to what in the previous century had become known as the "Pale," that is Dublin, Louth, Kildare, and a part of Meath, and within this narrow limit the earls of Kildare were really more powerful than the crown. Waterford, Drogheda, Dundalk, Cork, Limerick, and Galway were not Irish, but rather free cities than an integral part of the kingdom; and many inland towns were in the same position. The house of Ormonde had created a sort of small Pale about Kilkenny, and part of Wexford had been colonized by men of English race. The Desmonds were Irish in all but pride of blood. The Barretts, Condons, Courcies, Savages, Arundels, Carews, and others had disappeared or merged in the Celtic mass. Anglo-Norman nobles became chiefs of pseudo-tribes, which acknowledged only the Brehon law, and paid dues and services in kind. These pseudo-tribes were often called "nations," and a vast number of exactions were practised by the chiefs. "Coyne and livery"—the right of free-quarters for man and beast—arose among the Anglo-Normans, and became more oppressive than any native custom. When Henry took to business, he laid the foundation of reconquest. The house of Kildare, which had actually besieged Dublin (1534), was overthrown, and the Pale saved from a standing danger. But the Pale scarcely extended 20 miles from Dublin, a march of uncertain width intervening between it and the Irish districts. Elsewhere, says an elaborate report, all the English folk were of "Irish language and Irish condition," except in the cities and walled towns. Down and Louth paid black rent to O'Neill, Meath and Kildare to O'Connor, Wexford to the Kavanaghs, Kilkenny and Tipperary to O'Carroll, Limerick to the O'Briens, and Cork to the M'Carthy's. M'Murrough Kavanagh, in Irish eyes the representative of king Dermot, received an annual pension from the exchequer. Henry set steadily to work to reassert the royal title. He assumed the style of king of Ireland, so as to get rid of the notion that he held the island of the pope. The Irish chiefs acknowledged, his authority and his ecclesiastical supremacy, abjuring at the same time that of the Holy See. The lands of the earl of Shrewsbury and other absentees, who had performed no duties, were resumed; and both Celtic and feudal nobles were encouraged to come to court. Here begins the long line of official deputies, often men of moderate birth and fortune. Butler and Geraldine, O'Neill and O'Donnell, continued to spill each other's blood, but the feudal and tribal systems were alike doomed. In the names of these Tudor deputies and other officers we see the origin of many great Irish families—Skeffington, Brabazon, St Leger, Fitzwilliam, Wingfield, Bellingham, Carew, Bingham, Loftus, and others. Nor were the Celts overlooked. O'Neill and O'Brien went to London to be invested as earls of Tyrone and Thomond respectively. O'Donnell, whose descendants became earls of Tyrconnel, went to court and was well received. The pseudo-chief M'William became earl of Clanricarde, and others reached lower steps in the peerage, or were knighted by the king's own hand. All were encouraged to look to the crown for redress of grievances, and thus the old order slowly gave place to the new.

The Irish Church.

The moment when Protestantism and Ultramontaniam are about to begin their still unfinished struggle is a fit time to notice the chief points in Irish church history. Less than two years before Strongbow's arrival Pope Eugenius had established an ecclesiastical constitution in

Ireland depending on Rome, but the annexation was very imperfectly carried out, and the hope of fully asserting the Petrine claims was a main cause of Hadrian's gift to Henry II. Hitherto the Scandinavian section of the church in Ireland had been most decidedly inclined to receive the hierarchical and diocesan as distinguished from the monastic and quasi-tribal system. The bishops or abbots of Dublin derived their succession from Canterbury from 1038 to 1162, and the bishops of Waterford and Limerick also sought consecration there. But both Celt and Northman acknowledged the polity of Eugenius, and it was chiefly in the matters of tithe, Peter's pence, canonical degrees, and the observance of festivals that Rome had still victories to gain. Between churchmen of Irish and English race there was bitter rivalry; but the theory that the ancient Patrician Church remained independent, and as it were Protestant, while the English colony submitted to the Vatican, is a mere controversial figment. The crown was weak and papal aggression made rapid progress. It was in the Irish Church, about the middle of the 13th century, that the system of giving jurisdiction to the bishops "in temporalibus" was adopted by Innocent IV. The vigour of Edward I. obtained a renunciation in particular cases, but the practice continued unabated. The system of provisions was soon introduced at the expense of free election, and was acknowledged by the Statute of Kilkenny. In the more remote districts it must have been almost a matter of necessity. Many Irish parishes grew out of primitive monasteries, but other early settlements remained monastic, and were compelled by the popes to adopt the rule of authorized orders, generally that of the Augustinian canons. That order became much the most numerous in Ireland, having not less than three hundred houses. Allemand, who wrote in the 17th century for the benefit of the Stuart family, remarks with French flippancy that an Irishman who wished to be a bishop first became a canon regular. Of other sedentary orders the Cistercians were the most important, and the mendicants were very numerous. Both Celtic chiefs and Norman nobles founded convents after Henry II.'s time, but the latter being wealthier were most distinguished in this way. Religious houses were useful as abodes of peace in a turbulent country, and the lands attached were better cultivated than those of lay proprietors. It is a reproach to England that after four centuries Ireland was still without a university. Attempts to found one at Dublin (1311) or Drogheda (1465) failed for want of funds. The work was partially done by the great abbeys, boys of good family being brought up by the Cistercians of Dublin and Jerpoint, and by the Augustinians of Dublin, Kells, and Conall, and girls by the canonesses of Gracedieu. A strong effort was made to save these six houses, but Henry VIII. would not hear of it, and there was no Irish Wolsey partially to supply the king's omissions.

Ample evidence exists that the Irish Church was full of abuses before the movement under Henry VIII. We have detailed accounts of three sees—Clonmacnoise, Enaghdune, and Ardagh. Ross, also in a wild district, was in rather better case. But even in Dublin strange things happened; thus the archiepiscopal crozier was in pawn for eighty years from 1449. The morals of the clergy were no better than in other countries, and we have evidence of many scandalous irregularities. But perhaps the most severe condemnation is that of the report to Henry VIII. in 1515. "There is," says the document, "no archbishop, no bishop, abbot, no prior, parson, no vicar, no any other person of the church, high or low, great or small, English or Irish, that useth to preach the word of God, saving the poor friars beggars . . . the church of this land use not to learn any other science but the

law of canon, for covetise of lucre transitory." Where his hand reached Henry had little difficulty in suppressing the monasteries or taking their lands, which Irish chiefs swallowed as greedily as men of English blood. But the friars, though pretty generally turned out of doors, were themselves beyond Henry's power, and continued to preach everywhere among the people. Their devotion and energy may be freely admitted; but the mendicant orders, especially the Carmelites, were not uniformly distinguished for morality. Monasticism was momentarily suppressed under Oliver Cromwell, but the Restoration brought them back to their old haunts. The Jesuits, placed by Paul III. under the protection of Con O'Neill, "prince of the Irish of Ulster," came to Ireland towards the end of Henry's reign, and helped to keep alive the Roman tradition. It is not surprising that Anglicanism—the gospel light that dawned from Boleyn's eyes—recommended by such prelates as Browne and Bale, should have been regarded as a symbol of conquest and intrusion. The Four Masters thus describe the Reformation:—"A heresy and new error arising in England, through pride, vain glory, avarice, and lust, and through many strange sciences, so that the men of Eogland went into opposition to the pope and to Rome." The destruction of relics and images and the establishment of a schismatic hierarchy is thus recorded:—"Though great was the persecution of the Roman emperors against the church, scarcely had there ever come so great a persecution from Rome as this." Such was Roman Catholic opinion in Ireland in the 16th century, and such it is still. In vulgar Irish the word "Sassenagh" denotes a Protestant as well as an Englishman.

The able opportunist St Leger, who was accused by one party of opposing the Reformation and by the other of lampooning the Real Preseuce, continued to rule during the early days of the protectorate. To him succeeded Sir Edward Bellingham, a puritan soldier whose hand was heavy on all who disobeyed his dear young master, as he affectionately called the king. He bridled Connaught by a castle at Athlone, and Munster by a garrison at Leighlin Bridge. The O'Mores and O'Connors were brought low, and forts erected where Maryborough and Philipstown now stand. Both chiefs and nobles were forced to respect the king's representative, but Bellingham was not wont to flatter those in power, and his administration found little favour in England. Sir F. Bryan, Henry VIII.'s favourite, succeeded him, and on his death St Leger was again appointed. Neither St Leger nor his successor Crofts could do anything with Ulster, where the papal primate Wanchop, a Scot by birth, stirred up rebellion among the natives and among the Hebridean invaders. But little was done under Edward VI. to advance the power of the crown, and that little was done by Bellingham.

The English Government long hesitated about the official establishment of Protestantism, and the royal order to that effect was withheld until 1551. Copies of the new liturgy were sent over, and St Leger had the communion service translated into Latin, for the use of priests and others who could read, but not in English. The popular feeling was strong against innovation, as Staples, bishop of Meath, found to his cost. The opinions of Staples, like those of Cranmer, advanced gradually until at last he went to Dublin and preached boldly against the mass. He saw men shrink from him on all sides. "My lord," said a beneficed priest, whom he had himself promoted, and who wept as he spoke, "before ye went last to Dublin ye were the best beloved man in your diocese that ever came in it, now ye are the worst beloved. . . . Ye have preached against the sacrament of the altar and the saints, and will make us worse than Jews. . . . The country folk would eat you. . . . Ye have more curses than ye

have hairs of your head and I advise you for Christ's sake not to preach at the Navan." Staples answered that preaching was his duty, and that he would not fail; but he feared for his life. On the same prelate fell the task of conducting a public controversy with Primate Dowdall, which of course ended in the conversion of neither. Dowdall fled; his see was treated as vacant, and Cranmer came about for a Protestant to fill St Patrick's chair. His first nominee, Dr Turroer, resolutely declined the honour, declaring that he would be unintelligible to the people; and Cranmer could only answer that English was spoken in Ireland, though he did indeed doubt whether it was spoken in the diocese of Armagh. John Bale, a man of great learning and ability, became bishop of Ossory. There is no reason to doubt his sincerity, but he was coarse and intemperate,—Mr Froude roundly calls him a foul-mouthed ruffian,—without the wisdom of the serpent or the harmlessness of the dove. His choice rhetoric stigmatized the dean of St Patrick's as ass-headed, a blockhead who cared only for his kitchen and his belly. Archbishop Browne was gluttonous and a great epicure. If Staples was generally hated, what feelings must Bale have excited!

The Reformation having made no real progress, Mary <sup>Mary</sup> found it easy to recover the old ways. Dowdall was re- <sup>(1553-</sup> stored; Browne, Staples, and others were deprived. Bale <sup>53).</sup> fled for bare life, and his see was treated as vacant. Yet the queen found it impossible to restore the monastic lands, though she showed some disposition to scrutinize the titles of grantees. She was Tudor enough to declare her intention of maintaining the old prerogatives of the crown against the Holy See, and assumed the royal title without papal sanction. Paul IV. was fain to curb his fiery temper, and to confer graciously what he could not withhold. English Protestants fled to Ireland to escape the Marian persecution; but respectable evidence exists to show that, had the reign continued a little longer, Dublin would have been no safe place of refuge.

Mary scarcely varied the civil policy of her brother's ministers. Gerald of Kildare was restored to his earldom. The plan of settling Leix and Offaly by dividing the country between colonists and natives holding by English tenure failed, owing to the unconquerable love of the people for their own customs. But resistance gradually grew fainter, and we hear little of the O'Connors after this. The O'Mores, reduced almost to brigandage, gave trouble till the end of Elizabeth's reign, and a member of the clan was chief contriver of the rebellion of 1641. Maryborough and Philipstown King's county and Queen's county, commemorate Mary's ill-starred marriage.

Anne Boleyn's daughter succeeded quietly, and Sir Elizabeth <sup>(1558-</sup> Henry Sidney was sworn lord-justice with the full Catholic <sup>1603).</sup> ritual. When Sussex superseded him as lord-lieutenant, the litany was chanted in English, both cathedrals having been painted, and Scripture texts substituted for "pictures and popish farcies." At the beginning of 1560 a parliament was held which restored the ecclesiastical legislation of Henry and Edward. In two important points the Irish Church was made more dependent on the state than in England: *congregations d'elire* were abolished, and heretics made amenable to royal commissioners or to parliament without reference to any synod or convocation. According to a contemporary list, this parliament consisted of 3 archbishops, 17 bishops, 23 temporal peers, and members returned by 10 counties and 28 cities and boroughs. We know not whether all were present, and therefore the list throws no light on the dispute as to the conformity of Irish bishops in possession at Elizabeth's accession. A careful scrutiny shows that Curwen of Dublin and O'Fihilly of Leighlin actually conformed. Bodkin of Tuam, De Burgh of Cloufert, and perhaps some others took the oath

Edward VI. (1547-53).

The Reformation.



of supremacy; but the English convocation under Henry VIII. had done no less, and it involved no doctrinal changes. Walsh of Meath, Leverons of Kildare, and probably Thonory of Ossory were deprived. In other cases Elizabeth connived at what she could not prevent, and hardly pretended to enforce uniformity except in the Pale and in the large towns.

Ulster demanded the immediate attention of Elizabeth. Her father had conferred the earldom of Tyrone on Con Baragh O'Neill, with remainder to his supposed son Matthew, the offspring of a smith's wife at Dundalk, who in her husband's lifetime brought the child to Con as his own. When the chief's legitimate son Shane grew up he declined to be bound by this arrangement, which the king may have made in partial ignorance of the facts. "Being a gentleman," he said, "my father never refused no child that any woman namyd to be his." When Tyrone died, Matthew, already created baron of Dungannon, claimed his earldom under the patent. Shane being chosen O'Neill by his tribe claimed to be chief by election and earl as Con's lawful son. Thus the English Government was committed to the cause of one who was at best an adulterine bastard, while Shane appeared as champion of hereditary right. To secure his position he murdered the baron of Duagannon, whose prowess in the field he had reason to dread, and the eldest of two surviving sons became official candidate for the earldom. Shane maintained a contest which had begun under Mary until 1567, with great ability and a total absence of morality, in which Sussex had no advantage over him. The lord-lieutenant twice tried to have Shane murdered; once he proposed to break his safe-conduct; and he held out hopes of his sister's hand as a snare. Shane was induced to visit London, where his strange appearance and followers caused much amusement, and where he spent his time intriguing with the Spanish ambassador and making himself agreeable to Lord Robert Dudley. The Government detained him rather unfairly, and the young baron of Dungannon suffered his father's fate, leaving a brother who at last gained the coveted earldom, and became a more dangerous enemy to England than even Shane had been. Sussex was outmatched both in war and diplomacy; the loyal chiefs were crushed one by one; and the English suffered checks of which the moral effect was ruinous. Shane always fully acknowledged Elizabeth as his sovereign, and sometimes played the part of a loyal subject, wreaking his private vengeance under colour of expelling the Scots from Ulster. At last, in 1566, the queen placed the sword of state in Sidney's strong grasp. Shane was driven helplessly from point to point, and perished miserably at the hands of the M'Donnells, whom he had so often oppressed and insulted.

Peace was soon broken by disturbances in the south. The earl of Desmond having shown rebellious tendencies was detained for six years in London. Treated leniently, but grievously pressed for money, he tried to escape, and the attempt being judged treasonable, he was persuaded to surrender his estates,—to receive them back or not at the queen's discretion. Seizing the opportunity, English adventurers proposed to plant a military colony in the western half of Munster, holding the coast from the Shannon to Cork harbour. Some who held obsolete title deeds were encouraged to go to work at once by the example of Sir Peter Carew, who had established his claims in Carlow. Carew's title had been in abeyance for a century and a half, yet most of the Kavanaghs attorned to him. Falling foul of Ormonde's brothers, seizing their property and using great cruelty and violence, Sir Peter drove the Butlers, the only one among the great families really loyal, into rebellion. Ormonde, who was in London, could alone restore peace; all his disputes with Desmond

were at once settled in his favour, and he was even allowed to resume the exaction of coyne and livery, the abolition of which had been the darling wish of statesmen. The Butlers returned to their allegiance, but continued to oppose Carew, and great atrocities were committed on both sides. Sir Peter had great but undefined claims in Munster also, and the people there took warning. His imitators in Cork were swept away. Sidney first, and after him Humphrey Gilbert, could only circumscribe the rebellion. The presidency of Munster, an office the creation of which had long been contemplated, was then conferred on Sir John Perrott, who drove Fitzmaurice into the mountains, reduced castles everywhere, and destroyed a Scottish contingent which had come from Ulster to help the rebels. Fitzmaurice came in and knelt in the mud at the president's feet, confessing his sins; but he remained the real victor. The colonizing scheme was dropped, and the first presidency of Munster left the Desmonds and their allies in possession. Similar plans were tried unsuccessfully in Ulster, first by a son of Sir Thomas Smith, afterwards by Walter, earl of Essex, a knight-errant rather than a statesman, who was unfortunately guilty of many bloody deeds. He treacherously captured Sir Brian O'Neill and massacred his followers. The Scots in Rathlin were slaughtered wholesale. Essex struggled on for more than three years, seeing his friends gradually drop away, and dying ruined and unsuccessful. Towards the end of 1575 Sidney was again persuaded to become viceroy. The Irish recognized his great qualities, and he went everywhere without interruption. Henceforth presidencies became permanent institutions. Drury in Munster hanged four hundred persons in one year, Malby in reducing the Connaught Burkes spared neither young nor old, and burned all corn and houses. The Desmonds determined on a great effort. A holy war was declared. Fitzmaurice landed in Kerry with a few followers, and accompanied by the famous Nicholas Sanders, who was armed with a legate's commission and a banner blessed by the pope. Fitzmaurice fell soon after in an encounter with Malby, but Sanders and Desmond's brothers still kept the field. When it was too late to act with effect, Desmond himself, a vain man, neither frankly loyal nor a bold rebel, took the field. He surprised Youghal, then an English town, by night, sacked it, and murdered the people. Roused at last, Elizabeth sent over Ormonde as general of Munster, and after long delay gave him the means of conducting a campaign. "I will merely," wrote Burghley, "say Butler Aboo against all that cry in a new language Papa Aboo." It was in fact as much a war of Butlers against Geraldines as of loyal subjects against rebels, and Ormonde did his work only too well. Lord Baltinglass raised a hopeless subsidiary revolt in Wicklow (1580), which was signalized by a crushing defeat of Lord-Deputy Grey (Arthegal) in Glenmalur. A force of Italians and Spaniards landing at Smerwick in Kerry, Grey hurried thither, and the foreigners, who had no commission, surrendered at discretion, and were put to the sword. Neither Grey nor the Spanish ambassador seem to have seen anything extraordinary in thus disposing of inconvenient prisoners. Spenser and Raleigh were present. Sanders perished obscurely in 1581, and in 1583 Desmond himself was hunted down and killed in the Kerry mountains. More than 500,000 Irish acres were forfeited to the crown. The horrors of this war it is impossible to exaggerate. The Four Masters say that the lowing of a cow or the voice of a ploughman could scarcely be heard from Cashel to the furthest point of Kerry; Ormonde, who, with all his severity, was honourably distinguished by good faith, claimed to have killed 5000 men in a few months. Spenser, an eye-witness, says famine slew far more than the sword. The survivors were unable to walk, but crawled

Rebellion  
of Shane  
O'Neill.

First  
Desmond  
rebellion,  
1574.

out of the woods and glens. "They looked like anatomies of death; they did eat the dead carrion and one another soon after, inasmuch as the very carcases they spared not to scrape out of their graves; . . . to a plot of water-cresses or shamrocks they flocked as to a feast."

In 1584 Sir John Perrott, the ablest man available after Sidney's retirement, became lord-deputy. Sir John Norris, famed in the Netherland wars, was president of Munster, and so impressed the Irish that they averred him to be in league with the devil. Perrott held a parliament in 1585 in which the number of members was considerably increased. He made a strenuous effort to found a university in Dublin, and proposed to endow it with the revenues of St Patrick's, reasonably arguing that one cathedral was enough for any city. Here he was opposed by Loftus, archbishop of Dublin and chancellor, who had expressed his anxiety for a college, but had no idea of endowing it at his own expense. The colonization of the Munster forfeitures was undertaken at this time. It failed chiefly from the grants to individuals who neglected to plant English farmers, and were often absentees themselves. Raleigh obtained 42,000 acres. The quit rents reserved to the crown were less than one penny per acre. Racked with the stone, hated by the official clique, thwarted on all sides, poor Perrott was goaded into using words capable of a reasonable interpretation. Archbishop Loftus pursued him to the end. He died in the Tower under sentence for treason, and we may charitably hope that Elizabeth would have pardoned him. In his will, written after sentence, he emphatically repudiates any treasonable intention—"I deny my Lord God if ever I proposed the same."

In 1584 Hugh O'Neill, if O'Neill he was, became chief of part of Tyrone; in 1587 he obtained the coveted earldom, and in 1593 was the admitted head of the whole tribe. A quarrel with the Government was inevitable, and, Hugh Roe O'Donnell having joined him, Ulster was united against the crown. In 1598 James Fitzthomas Fitzgerald assumed the title of Desmond, to which he had some claims by blood, and which he pretended to hold as Tyrone's gift. Tyrone had received a crown of porcupine's feathers from the pope, who was regarded by many as king of Ireland. The title of *Sugan* or straw-rope earl has been generally given to the Desmond pretender. Both ends of the island were soon in a blaze, and the Four Masters say that in seventeen days there was not one son of a Saxon left alive in the Desmond territories. Edmund Spenser lost his all, escaping only to die of misery in a London garret. Tyrone more than held his own in the north, completely defeated Sir H. Baginbald in the battle of the Yellow Ford (1598), invaded Munster, and ravaged the lands of Lord Barrymore, who had remained true to his allegiance. Tyrone's ally, Hugh Roe O'Donnell, overthrew the president of Connaught. "The Irish of Connaught," say the Four Masters, "were not pleased at Clifford's death; . . . he had never told them a falsehood." Essex came over in 1599 with a great army, but did nothing of moment, was outgeneralled and outwitted by Tyrone, and threw up his command to enter on the mad and criminal career which led to the scaffold. In 1600 Sir George Carew became president of Munster, and, as always happened when the crown was well served, the rebellion was quickly put down. Mountjoy, who succeeded Essex, joined Carew, and a Spanish force which landed at Kinsale surrendered. The destruction of their crops starved the people into submission, and the contest was only less terrible than the first Desmond war because it was much shorter. In Ulster Mountjoy was assisted by Sir Henry Docwra, who founded the second settlement at Derry, the first under Randolph having been abandoned. Hugh O'Donnell sought help in Spain, where he died. Tyrone submitted at last, craving

pardon on his knees, renouncing his Celtic chieftry, and abjuring all foreign powers, but still retaining his earldom and power almost too great for a subject. Scarcely was the ink dry when he was told of the great queen's death! He burst into tears, not of grief, but of vexation at not having held out for still better terms.

In reviewing the Irish government of Elizabeth we shall find much to blame, a want of truth in her dealings and of steadiness in her policy. Violent efforts of coercion were succeeded by fits of clemency, of parsimony, or of apathy. Yet it is fair to remember that she was surrounded by enemies, that her best energies were expended in the death struggle with Spain, and that she was rarely able to give undivided attention to the Irish problem. After all she conquered Ireland, which her predecessors had failed to do, though many of them were as crooked in action and less upright in intention. Considering the times, Elizabeth cannot be called a persecutor. "Do not," she said to the elder Essex, "seek too hastily to bring people that have been trained in another religion from that in which they have been brought up." Such things as the torture of Archbishop O'Hurley cannot and need not be defended, but the statesmen of that day regarded the royal supremacy as a political doctrine, and its active opponents as traitors. And Catholics should not be too ready to remember the tyranny which their forefathers felt, and to forget the plots against Elizabeth's life, the night of St Bartholomew, and the Spanish Inquisition. Elizabeth saw that the Irish could only be reached through their own language. But for that harvest the labourers were necessarily few. The fate of Bishop Daly of Kildare, who preached in Irish, and who thrice had his house burned over his head, was not likely to encourage missionaries. Neither the best nor the worst of the episcopal body, Adam Loftus must be regarded as a representative man. To preach what he thought true when he could do it safely, to testify against toleration, and in the meantime to make a fortune, was too often the sum and substance of an Anglican prelate's work in Ireland. In all wild parts divine service was neglected, and wandering friars or subtle Jesuits, supported by every patriotic or religious feeling of the people, kept Ireland faithful to Rome. Against her many shortcomings we must set the queen's foundation of that university which has been the one successful English institution in Ireland, and which has continually borne the fairest fruit.

Great things were expected of James I. He was Mary Stuart's son, and there was a curious antiquarian notion afloat that, because the Irish were the original "Scoti," a Scottish king would sympathize with Ireland. Corporate towns set up the mass, and Mountjoy, who could argue as well as fight, had to teach them a sharp lesson. Finding Ireland conquered and in no condition to rise again, James established circuits and a complete system of shires. Sir John Davies was sent over as solicitor-general. The famous book in which he glorifies his own and the king's exploits gives far too much credit to the latter, and far too little to his great predecessor. When she was still alive to confer favours, Davies in very creditable verse had lavished praises upon Elizabeth which must have seemed exaggerated even to her.

Two legal decisions swept away the customs of tautistry and of Irish gavelkind, and the English land system was violently substituted. Tyrone was harassed by sheriffs and other officers, and the Government, learning that he was engaged in an insurrectionary design, prepared to seize him. The information was probably false, but Tyrone was growing old and nervous, and perhaps despaired of making good his defence. By leaving Ireland he played into his enemies' hands. Rory O'Donnell, created earl of Tyrconnel, accompanied him. Cuconnaught Maguire had already gone

Elizabethan conquest of Ireland.

Religious Policy

James I. (1603-24)

Last Desmond rebellion.



Plan-  
tation of  
Ulster.

The "flight of the earls," as it is called, completed the ruin of the Celtic cause. Reasons or pretexts for declaring forfeitures against O'Cahan and O'Reilly were easily found. O'Dogherty, chief of Innishowen, and foreman of the grand jury which found a bill for treason against the earls, received a blow from Paulet the governor of Derry. O'Dogherty rose, Derry was sacked, and Paulet murdered. O'Dogherty having been killed and O'Hanlon and others being implicated, the whole of northern Ulster was at the disposal of the Government. Tyrone, Donegal, Armagh, Cavan, Fermanagh, and Derry were parcelled out among English and Scotch colonists, portions being reserved to the natives. The site of Derry was granted to the citizens of London, who fortified and armed it, and Londonderry became the chief bulwark of the colonists in two great wars. If we look at its morality we shall find little to praise, but in a political point of view the plantation of Ulster was successful. The northern province, which so severely taxed the energies of Elizabeth, has since been the most prosperous and loyal part of Ireland. But the conquered people remained side by side with the settlers; and Sir George Carew, who reported on the plantation in 1611, clearly foresaw that they would rebel again "under the veil of religion and liberty, than which nothing is esteemed so precious in the hearts of men." Those natives who retained land were often oppressed by their stronger neighbours, and sometimes actually swindled out of their property. It is probable that in the neglect of the grantees to give proper leases to their tenants arose the Ulster tenant-right custom which has attracted so much notice of late years.

The Irish  
parliament.

It may be convenient to notice here the parliamentary history of the English colony in Ireland, which corresponds pretty closely to that of the mother country. First there are informal meetings of eminent persons; then, in 1295, there is a parliament of which some acts remain, and to which only knights of the shire were summoned to represent the Commons. Burgesses were added as early as 1310. The famous parliament of Kilkenny in 1367 was largely attended, but the details of its composition are not known. That there was substantial identity in the character of original and copy may be inferred from the fact that the well-known tract called *Modus Tenendi Parliamentum* was exemplified under the Great Seal of Ireland in 6 Hen. V. The most ancient Irish parliament remaining on record was held in 1374, twenty members in all being summoned to the House of Commons, from the counties of Dublin, Louth, Kildare, and Carlow, the liberties and crosses of Meath, the city of Dublin, and the towns of Drogheda and Dundalk. The liberties were those districts in which the great vassals of the crown exercised palatinate jurisdiction, and the crosses were the church lands, where alone the royal writ usually ran. Writs for another parliament in the same year were addressed in addition to the counties of Waterford, Cork, and Limerick; the liberties and crosses of Ulster, Wexford, Tipperary, and Kerry; the cities of Waterford, Cork, and Limerick; and the towns of Youghal, Kinsale, Ross, Wexford, and Kilkenny. The counties of Clare and Longford, and the towns of Galway and Athenry, were afterwards added, and the number of popular representatives does not appear to have much exceeded sixty during the later Middle Ages. In the House of Lords the temporal peers were largely outnumbered by the bishops and mitred abbots. In the parliament which conferred the royal title on Henry VIII it was finally decided that the proctors of the clergy had no voice or votes. Elizabeth's first parliament, held in 1559, was attended by 76 members of the Lower House, which increased to 122 in 1585. In 1613 James I. by a wholesale creation of new boroughs, generally of the last insignificance, increased the House of Commons to 232 and thus secured an Anglican majority

to carry out his policy. He told those who remonstrated to mind their own business. "What is it to you if I had created 40 noblemen and 400 boroughs? The more the merrier, the fewer the better cheer." In 1639 the House of Commons had 274 members, a number which was further increased to 300 at the Revolution, and so it remained until the Union.

Steeped in absolutist ideas, James was not likely to tolerate religious dissent. He thought he could "mak what liked him law and gospel." A proclamation for banishing Romish priests issued in 1605, and was followed by an active and general persecution, which was so far from succeeding that they continued to flock in from abroad, Lord-Deputy Chichester admitting that every house and hamlet was to them a sanctuary. The most severe English statutes against the Catholic laity had never been re-enacted in Ireland, and, in the absence of law, illegal means were taken to enforce uniformity. Privy seals addressed to men of wealth and position commanded their attendance at church before the deputy or the provincial president, on pain of unlimited fine and imprisonment by the Irish Star Chamber. The Catholic gentry and lawyers, headed by Sir Patrick Barnewall, succeeded in proving the flagrant illegality of these mandates, and the Government had to yield. On the whole Protestantism made little progress, though the number of Protestant settlers increased. As late as 1622, when Lord Falkland was installed as deputy, the illustrious Ussher, then bishop of Meath, preached from the text "he beareth not the sword in vain," and descanted on the over-indulgence shown to recusants. Primate Hampton, in a letter which is a model of Christian eloquence, mildly rebuked his eminent suffragan.

The necessities of Charles I. induced his ministers to propose that a great part of Connaught should be declared forfeited owing to mere technical flaws in title, and planted like Ulster. Such was the general outcry that the scheme had to be given up; and, on receiving a large grant from the Irish parliament, the king promised certain graces, of which the chief were security for titles, a free trade, and the substitution of an oath of allegiance for that of supremacy. Having got the money, Charles as usual broke his word; and in 1635 Lord-Deputy Strafford began a general system of extortion. The Connaught and Munster landowners were shamelessly forced to pay large fines for the confirmation of even recent titles. The Irish woollen manufacture was discouraged as hurtful to England; and, if linen was encouraged, it was only because no linen was made in the greater kingdom. The money obtained by oppressing the Irish nation was employed to create an army for the oppression of the Scotch and English nations. The Roman Catholics were neither awed nor conciliated. Twelve bishops, headed by Primate Ussher, solemnly protested that "to tolerate popery is a grievous sin." The Ulster Presbyterians were rigorously treated. Of the prelates employed by Strafford in this insane persecution the ablest was Bramhall of Derry, who not only oppressed the ministers but insulted them by coarse language. The "black oath," which bound those who took it never to oppose Charles in anything, was enforced on all ministers, and those who refused it were driven from their manse and often stripped of their goods.

Strafford was recalled to expiate his career on the scaffold; the army was disbanded; and the helm of the state remained in the hands of a landjobber and of a superannuated soldier. Disbanded troops are the ready weapons of conspiracy, and the opportunity was not lost. The Catholic insurgents of 1641 just failed to seize Dublin, but quickly became masters of nearly the whole country. That there was no definite design of massacring the Protestants is likely, but it was intended to turn them out.

Religious  
policy of  
James I.

Charles I.  
(1625-  
49).

Adminis-  
tration of  
Strafford.

Rebellion  
of 1641.

Great numbers were killed, often in cold blood and with circumstances of great barbarity. The English under Coote and others retaliated. In 1642 a Scottish army under Monro landed in Ulster, and formed a rallying point for the colonists. Londonderry, Enniskillen, Coleraine, Carrickfergus, and some other places defied Sir Phelim O'Neill's tumultuary host. Trained in foreign wars, Owen Roe O'Neill gradually formed a powerful army among the Ulster Irish, and it is impossible to overestimate his skill and patience. But like other O'Neills, he did little out of Ulster, and his great victory over Monro (1645) had no lasting results. The old English of the Pale were forced into rebellion, but could never get on with the native Irish, who hated them only less than the new colonists. Ormonde throughout maintained the position of a loyal subject, and, as the king's representative, played a great but hopeless part. The Celts cared nothing for the king except as a weapon against the Protestants; the old Anglo-Irish Catholics cared much, but the nearer Charles approached them the more completely he alienated the Protestants. In 1645 Rinuccini reached Ireland as papal legate. He could never cooperate with the Catholic confederacy at Kilkenny, which was under old English influence, and by throwing in his lot with the Celts only widened the gulf between the two sections. The Royalist confederates were not willing to decide the question of investitures in favour of the pope, still less to restore the abbey lands of which they were the chief holders. Whatever may be thought of Mr Carlyle's judgments on Ireland generally, he has thoroughly mastered the state of parties during the turmoil which followed 1641:—"There are," he says, "Catholics of the Pale, demanding freedom of religion, under my lord this and my lord that. There are Old-Irish Catholics, under pope's nuncios, under Abba O'Teague of the excommunications, and Owen Roe O'Neill, demanding not religious freedom only, but what we now call 'repeal of the union,' and unable to agree with Catholics of the English Pale. Then there are Ormonde Royalists, of the Episcopalian and mixed creeds, strong for king without covenant; Ulster and other Presbyterians strong for king and covenant; lastly, Michael Jones and the Commonwealth of England, who want neither king nor covenant."

In all their negotiations with Ormonde and Glamorgan, Henrietta Maria and Digby, the pope and Rinuccini stood out for an arrangement which would have destroyed the royal supremacy and established Romanism in Ireland, leaving to the Anglicans bare toleration, and to the Presbyterians not even that. Charles behaved after his kind, showing, not only his falseness, but also his total want of real dignity. Ormonde was forced to surrender Dublin to the Parliamentarians (1646), and the inextricable knot awaited Cromwell's sword. The total inability of the Irish Catholics to form anything like a working government during their nine years of power proves that her history, and the discordant ingredients of her population, must ever prevent Ireland from achieving a separate political existence.

Cromwell. Cromwell's campaign (1649-50) showed how easily a good general with an efficient army might conquer Ireland. Resistance in the field was soon at an end: the starving-out policy of Carew and Mountjoy was employed against the guerrillas, and the soldiers were furnished with scythes to cut down the green corn. Bibles were also regularly served out to them. Oliver's severe conduct at Drogheda and elsewhere is not morally defensible, but much may be urged in his favour. Strict discipline was maintained—he hanged soldiers for stealing chickens; faith was always kept; and short, sharp action was more merciful in the long run than a milder but less effective policy. The character and designs of this great man offer a most difficult problem.

For a time Lord Clarendon had it all his own way; in due course came a reaction so violent that the Protector has been almost deified in some quarters. Ireton was in many respects a copy of his father-in-law. Cromwell's civil policy, to use Macaulay's words, was "able, straightforward, and cruel." He thinned the disaffected population by allowing foreign enlistment, and 40,000 are said to have been thus got rid of. Already Irish Catholics of good family had learned to offer their swords to foreign princes. In Spain, France, and the empire they often rose to the distinction which they were denied at home. About 9000 persons were sent to the West Indies, practically into slavery. Thus, and by the long war, the population was reduced to some 850,000, of whom 150,000 were English and Scots; the marvel is that so many were left. Then came the transplantation beyond the Shannon. The Irish Catholic gentry were removed bodily with their servants and such tenants as consented to follow them, and with what remained of their cattle. They suffered dreadful hardships. To exclude foreign influences, a belt of one mile was reserved to soldiers on the coast from Sligo to the Shannon, but the idea was not fully carried out. The derelict property in the other provinces was divided between adventurers who had advanced money and soldiers who had fought in Ireland. Many of the latter sold their claims to officers or speculators, who were thus enabled to form estates. The majority of Irish labourers stayed to work under the settlers, and the country became peaceful and prosperous. Some fighting Catholics haunted woods and hills under the name of Tories, afterwards given in derision to a great party, and were hunted down with as little compunction as the wolves to which they were compared. Measures of great severity were taken against Catholic priests; but it is said that Cromwell had great numbers in his pay, and that they kept him well informed. All classes of Protestants were tolerated, and Jeremy Taylor preached unmolested. Commercial equality being given to Ireland, the woollen trade at once revived, and a shipping interest sprang up. Were it worth while to prove Cromwell a greater statesman than Strafford, his religious and commercial policy in Ireland would supply ample evidence. A legislative union was also effected, and Irish members attended at Westminster. The following brief record of a debate is worth quoting:—"Mr Bamfield and Mr Robinson—all that serve for Ireland should be on this committee. Sir Gilbert Pickering, Mr Hyland—against any such distinction of members; it is an ill precedent and looks not like an union; . . . name as many as you will, but let them not be exclusively added. Mr Ashe—as they sit in Parliament, they are not Irishmen, but mere Englishmen. Resolved—that all who serve for Ireland be of the committee." For further particulars Mr Prendergast's *Cromwellian Settlement and Toru War of Ulster* should be consulted.

Charles II. was bound in honour to do something for Charles II. such Irish Catholics as were innocent of the massacres of 1641, and the claims were not scrutinized too severely. It was found impossible to displace the Cromwellians, but they were shorn of about one-third of their lands. When the Caroline settlement was complete it was found that the great rebellion had resulted in reducing the Catholic share of the fertile parts of Ireland from two-thirds to one-third. Ormonde, whose wife had been allowed by Cromwell's clemency to make him some remittances from the wreck of his estate, was largely and deservedly rewarded. A revenue of £30,000 was settled on the king, in consideration of which Ireland was in 1663 excluded from the benefit of the Navigation Act, and her nascent shipping interest ruined. In 1666 the importation of Irish cattle and horses into England was forbidden, the value of the former at once falling five fold, of the latter twenty-fold.



Among other arguments in favour of this atrocious law was that used by Ashley, who said that if the bill did not pass the duke of Ormonde would have a greater estate than the earl of Northumberland. "Achitophel" must have laughed in his sleeve. Buckingham said every opponent of the bill must have "an Irish estate or an Irish understanding," which nearly cost him a duel with Ossory, and much damaged his reputation for courage. That such a man as Ormonde is characteristic of the most shameless reign in our history. Dead meat, butter, and cheese were also excluded, yet peace brought a certain prosperity. The woollen manufacture grew and flourished, and Macaulay is probably warranted in saying that under Charles II. Ireland was a pleasanter place of residence than it has been before or since. But it was pleasant only for those who conformed to the state religion. Catholicism was tolerated, or rather connived at; but its professors were subject to frequent alarms, and to great severities during the reign of Titus Oates. Bramhall became primate, and his hand was heavy against the Ulster Presbyterians. It is humiliating to record that Jeremy Taylor began a persecution which stopped the influx of Scots into Ireland. Deprived of the means of teaching, the Independents and other sectaries soon disappeared. In a military colony women were scarce, and the "Ironsides" had married natives. To use their own language, they saw the daughters of Moab that they were fair. Women are more religious than men, travelling missionaries more zealous than endowed clerks; and Catholicism held its own. The Quakers became numerous during this reign, and their peaceful industry was most useful. They venerate as their founder Thomas Edmundson, a Westmoreland man who had borne arms for the Parliament, and who settled in Antrim in 1652.

James II.  
(1685-89). The duke of Ormonde was lord-lieutenant at the death of Charles II. At seventy-five his brain was as clear as ever, and James saw that he was no fit tool for his purpose. "See, gentlemen," said the old chief, lifting his glass at a military dinner party, "they say at court I am old and doting. But my hand is steady, nor doth my heart fail. . . . To the king's health." Calculating on his loyal subservience, James appointed his brother-in-law, Lord Clarendon, to succeed Ormonde. Monmouth's enterprise made no stir, but gave an excuse for disarming the Protestant militia. The Tories at once emerged from their hiding-places, and Clarendon found Ireland in a ferment. It was now the turn of the Protestants to feel what persecution means. Richard Talbot, one of the few survivors of Drogheda, governed the king's Irish policy, while the lord-lieutenant was kept in the dark. Finally Talbot, created earl of Tyrconnel, himself received the sword of state. Protestants were weeded out of the army, Protestant officers in particular being superseded by idle Catholics of gentle blood, where they could be found, and in any case by Catholics. Bigotry rather than religion was Tyrconnel's ruling passion, and he filled up offices with Catholics independently of character. Fitton, a man convicted of forgery, became chancellor, and but three Protestant judges were left on the bench. The outlawries growing out of the affairs of 1641 were reversed as quickly as possible. Protestant corporations were dissolved by "quo warrantos"; but James was still Englishman enough to refuse an Irish parliament, which might repeal Poyning's Act and the Act of Settlement. In 1687 the Church of England discovered that there were limits to passive obedience, and at the close of the following year James was a fugitive in France. By this time Londonderry and Enniskillen had closed their gates, and the final struggle had begun. In March 1689 James reached Ireland with some French troops, and

summoned a parliament which repealed the Act of Settlement. The estates of absentees were vested in the crown, and, as only two months law was given, this was nearly equivalent to confiscating the property of all Protestants. Between 2000 and 3000 Protestants were attainted by name, and moreover the Act was not published. The appalling list may be read in the *State of the Protestants* by Archbishop King, one of many divines converted by the logic of events to believe in the lawfulness of resistance. Interesting details may be gleaned in Thomas Edmundson's *Diary*. The dispossessed Protestants escaped by sea or flocked into Ulster, where a gallant stand was made. The glories of Londonderry and Enniskillen will live as long as the English language. The Irish cause produced one great achievement—the defence of Limerick, and one great leader—Patrick Sarsfield. The Catholic Celts aided by France were entirely beaten, the Protestant colonists aided by England were entirely victorious (battle of the Boyne, William 1st July 1690; battle of Anghrim, 12th July 1691). III. Even the siege of Limerick showed the irreconcilable divisions which had nullified the efforts of 1641. Hugh Baldearg O'Donnell, last of Irish chiefs, sold his services to William for £500 a year. But it was their king that condemned the Irish to hopeless failure. He called them cowards, whereas the cowardice was really his own, and he deserted them in their utmost need. They repaid him with the opprobrious nickname of "Sheemas-a-Cacagh," or Dirty James.

Irish rhetoric commonly styles Limerick "the city of the violated treaty." The articles of capitulation (3d October 1691) may be read in Leland or Plowden; from the first their interpretation was disputed. Hopes of religious liberty were held out, but were not fulfilled. Lords Justices Porter and Coningsby promised to do their utmost to obtain a parliamentary ratification, but the Irish parliament would not be persuaded. There was a paragraph in the original draft which would have protected the property of the great majority of Catholics, but this was left out in the articles actually signed. William thought the omission accidental, but this is hardly possible. At all events he ratified the treaty in the sense most favourable to the Catholics, while the Irish parliament adhered to the letter of the document. Perhaps no breach of faith was intended, but the sorrowful fact remains that the modern settlement of Ireland has the appearance of resting on a broken promise. More than 1,000,000 Irish acres were forfeited, and, though some part returned to Catholic owners, the Catholic interest in the land was further diminished. William III. was the most liberally minded man in his dominions; but the necessities of his position, such is the awful penalty of greatness, forced him into intolerance against his will, and he promised to discourage the Irish woollen trade. His manner of disposing of the Irish forfeitures was inexcusable. Grants to Bentinck, Ruvigny, and Ginckell may be defended, but not that to Elizabeth Villiers, countess of Orkney, the king's former mistress. The lands were resumed by the English parliament, less perhaps from a sense of justice than from a desire to humiliate the deliverer of England, and were resold to the highest bidder. Nevertheless it became the fashion to reward nameless English services at the expense of Ireland. Pensions and sinecures which would not bear the light in England were charged on the Irish establishment, and even bishoprics were given away on the same principle. The tremendous uproar raised by Swift about Wood's halfpence was heightened by the fact that Wood shared his profits with the duchess of Kendal.

From the first the victorious colonists determined to make another 1641 impossible, and the English Government failed to moderate their severity (principal Penal Act, 2 Anne, c. 3). In 1708 Swift declared that the Papists were politi-

easy as inconsiderable as the women and children. In despair of effecting anything at home, the young and strong enlisted in foreign armies, and the almost incredible number of 450,000 are said to have emigrated for this purpose between 1691 and 1745. This and the hatred felt towards James II. prevented any rising in 1715 or 1745. The panic-stricken severity of minorities is proverbial, but it is not to be forgotten that the Irish Protestants had been turned out of house and home twice within fifty years. The restrictions on Irish commerce provoked Locke's friend Molyneux to write his famous plea for legislative independence (1698). Much of the learning contained in it now seems obsolete, but the question is less an antiquarian one than he supposed. Later events have shown that the mother country must have supreme authority, or must relax the tie with self-governing colonies merely into a close alliance. In the case of Ireland the latter plan has always been impossible. In 1703 the Irish parliament begged hard for a legislative union, but as that would have involved at least partial free trade the English monopolists prevented it. By Poyning's law England had a vote on all Irish legislation, and was therefore an accomplice in the penal laws. For details on this disagreeable subject the reader is referred to Denys Scully's *Statement of the Penal Laws*. No Papist might teach a school or any child but his own, or send children abroad,—the burden of proof lying on the accused, and the decision being left to magistrates without a jury. Mixed marriages were forbidden between persons of property, and the children might be forcibly brought up Protestants. A Papist could not be a guardian, and all wards in chancery were brought up Protestants. The Protestant eldest son of a landed proprietor might make his father tenant for life and secure his own inheritance. Among Papist children land went in compulsory gavelkind. Papists could not take longer leases than thirty-one years at two-thirds of a rack rent; they were even required to conform within six months of an inheritance accruing, on pain of being ousted by the next Protestant heir. Priests from abroad were banished, and their return declared treason. All priests were required to register and to remain in their own parishes, and informers were to be rewarded at the expense of the Popish inhabitants. No Papist was allowed arms, two justices being empowered to search; and if he had a good horse any Protestant might claim it on tendering £5. These laws were of course systematically evaded. The property of Roman Catholics was often preserved through Protestant trustees, and it is understood that faith was generally kept. Yet the attrition if slow was sure, and by the end of the century the proportion of land belonging to Roman Catholics was probably not more than one-tenth of the whole. We can see now that if the remaining Roman Catholic landlords had been encouraged they would have done much to reconcile the masses to the settlement. Individuals are seldom as bad as corporations, and the very men who made the laws against priests practically shielded them. Nothing was so odious as a priest-hunter, even among Protestants, and this form of delation has doubtless done much to create the Irish horror of informing, or indeed of giving any evidence. The penal laws put a premium on hypocrisy, and many conformed only to preserve their property or to enable them to take office. Proselytizing schools, though supported by public grants, entirely failed.

The restraints placed by English commercial jealousy on Irish trade destroyed manufacturing industry in the south and west. Driven by the Caroline legislation against cattle into breeding sheep, Irish graziers produced the best wool in Europe. Forbidden to export it, or to work it up profitably at home, they took to smuggling, for which the indented coast gave great facilities. The enormous profits of the contraband trade with France enabled Ireland to

purchase English goods to an extent greater than her whole lawful traffic. The moral effect was disastrous. The religious penal code it was thought meritorious to evade; the commercial penal code was ostentatiously defied; and both tended to make Ireland the least law-abiding country in Europe. The account of the smugglers is the most interesting and perhaps the most valuable part of Mr Froude's work on Ireland, and should be compared with Mr Lecky's Irish and Scotch chapters.

When William III. promised to depress the Irish woollen trade, he promised to do all he could for Irish linen. England did not fulfil the second promise; still the Ulster weavers were not crushed, and their industry flourished. Some Huguenot refugees, headed by Louis Crommelin, were established by William III. at Lisburn, and founded the manufacturing prosperity of Ulster. Other Huguenots attempted other industries, but commercial restraints brought them to nought. The peculiar character of the flax business has prevented it from crossing the mountains which bound the northern province. Wool was the natural staple of the south.

The Scottish Presbyterians who defended Londonderry were treated little better than the Irish Catholics who besieged it,—the sacramental test of 1704 being the work of the English council rather than of the Irish parliament. In 1715 the Irish House of Commons resolved that any one who should prosecute a Presbyterian for accepting a commission in the army without taking the test was an enemy to the king and to the Protestant interest. Acts of indemnity were regularly passed throughout the reign of George II., and until 1780, when the Test Act was repealed. A bare toleration had been granted in 1720. Various abuses, especially forced labour on roads which were often private jobs, caused the Oakboy insurrection in 1764. Eight years later the Steelboys rose against the exactions of absentee landlords, who often turned out Protestant yeomen to get a higher rent from Roman Catholic cottiers. The dispossessed men carried to America an undying hatred of England which had much to say to the American revolution, and that again reacted on Ireland. Lawless Protestant associations, called Peep o' Day Boys, terrorized the north and were the progenitors of the Orangemen (1789). Out of the rival "defenders" Ribbonism in part sprung. The United Irishmen drew from both sources (1791).

But the Ulster peasants were never as badly off as those of the south and west. Writers the most unlike each other—Swift and Boulter, Berkeley and Stone, Arthur Young and Dr Thomas Campbell—all tell the same tale. Towards the end of the 17th century Raleigh's fatal gift had already become the food of the people. When Chief Baron Rice went to London in 1688 to urge the Catholic claims on James II., the hostile populace escorted him in mock state with potatoes stuck on poles. Had manufactures been given fair play in Ireland, population might have preserved some relation to capital. As it was, land became almost the only property, and the necessity of producing wool for smuggling kept the country in grass. The poor squatted where they could, receiving starvation wages, and paying exorbitant rents for their cabins, partly with their own labour. Unable to rise, the wretched people multiplied on their potato plots with perfect recklessness. During the famine which began in the winter of 1739 one-fifth of the population is supposed to have perished; yet it is hardly noticed in literature, and seems not to have touched the conscience of that English public which in 1755 subscribed £100,000 for the sufferers by the Lisbon earthquake. As might be expected where men were allowed to smuggle and forbidden to work, redress was sought in illegal combinations and secret societies. The



dreaded name of Whitebey was first heard in 1761, and agrarian crime has never since been long absent. Since the Union we have had the Threshers, the Terry Alts, the Molly Maguires, the Rockites, and many others. Poverty has been the real cause of all these disturbances, which were often aggravated by the existence of factions profoundly indicative of barbarism. Communism, cupidity, scoundrelism of all kinds have contributed to every disturbance. The tendency shown to screen the worst criminals is sometimes the result of sympathy, but more often of fear. The cruelties which have generally accompanied Whiteboyism is common to servile insurrections all over the world. No wonder if Irish landlords were formerly tyrannical, for they were in the position of slave-owners. The steady application of modern principles, by extending legal protection to all, has altered the slavish character of the oppressed Irish. The cruelty has not quite died out, but it is much rarer than formerly; and, generally speaking, the worst agrarianism has of late years been seen in the districts which retain most of the old features.

The mediæval colony in Ireland was profoundly modified by the pressure of the surrounding tribes. While partially adopting their laws and customs, the descendants of the conquerors often spoke the language of the natives, and in so doing nearly lost their own. The *Book of Howth* and many documents composed in the Pale during the 16th century show this clearly. Those who settled in Ireland after 1641 were in a very different mood. They hated, feared, and despised the Irish, and took pride in preserving their pure English speech. Molyneux and Petty, who founded the Royal Society of Dublin in 1683, were equally Englishmen, though the former was born in Ireland. Swift and Berkeley did not consider themselves Irishmen at all. Burke and Goldsmith, coming later, though they might not call themselves Englishmen, were not less free from provincialism. It would be hard to name other four men, who, within the same period, used Shakespeare's language with equal grace and force. They were all educated at Trinity College, Dublin. The Sheridans were men of Irish race, but with the religion they adopted the literary tone of the dominant caste, which was small and exclusive, with the virtues and the vices of an aristocracy. Systematic infringement of English copyright was discreditable in itself, but sure evidence of an appetite for reading. "The bookseller's property," says Gibbon of his first volume, "was twice invaded by the pirates of Dublin." The oratory of the day was of a high order, and incursions into the wide field of pamphlet literature often repay the student. Handel was appreciated in Dublin at a time when it was still the fashion to decry him in London. The public buildings of the Irish capital have always been allowed great architectural merit, and private houses still preserve much evidence of a refined taste. Angelica Kauffmann worked long in Ireland; Barry and Shee were of Irish birth; and on the whole, considering the small number of educated inhabitants, it must be admitted that the Ireland of Flood and Grattan was intellectually fertile.

The volunteers extorted partial free trade (1779), but manufacturing traditions had perished, and common experience shows how hard these are to recover. The demand for union was succeeded by a craving for independence. Poyning's law was repealed, and in 1782, in Mr Grattan's opinion, Ireland was at last a nation. The ensuing period of eighteen years is the best known in Irish history. The quarrel and reconciliation of Flood and Grattan, the kindly patriotism of Charlemont, the eloquence, the devotion, the corruption, are household words. In 1784 out of 300 members 82 formed the regular opposition, of whom 30 were the nominees of Whig potentates and 52 were really elected. The majority contained 29 members

considered independent, 44 who expected to be bought, 4 ½ placemen, 12 sitting for regular Government boroughs, and 12 who were supposed to support the Government on public grounds. The remaining seats were proprietary, and were let to Government for valuable consideration. The House of Lords, composed largely of borough-mongers and controlled by political bishops, was even less independent. Only Protestant freeholders had votes, which encouraged leases for lives, about the worst kind of tenure, and the object of each proprietor was to control as many votes as possible. The necessity of finding Protestants checked subdivision for a time, but in 1793 the Roman Catholics received the franchise, and it became usual to make leases in common, so that each lessee should have a freehold interest of 40s. The landlord indeed had little choice, for his importance depended on the poll book. Salaries, sinecures, even commissions in the army were reserved for those who contributed to the return of some local magnate.

But no political cause swelled the population as much as the potato. Introduced by Raleigh in 1610, the cultivation of this dangerous tuber developed with extraordinary rapidity. The Elizabethan wars were most injurious to industry, for men will not sow unless they hope to reap, and the very essence of military policy had been to deprive a recalcitrant people of the means of living. The Mantuan peasant was grieved at the notion of his harvest being gathered by barbarian soldiers, and the Irishman could not be better pleased to see his destroyed. There was no security for any one, and every one was tempted to live from hand to mouth. The decade of anarchy which followed 1641 stimulated this tendency fearfully. The labour of one man could plant potatoes enough to feed forty, and they could neither be destroyed nor carried away easily. When Petty wrote, early in Charles II.'s reign, this demoralizing esculent was already the national food. Potatoes cannot be kept very long, but there was no attempt to keep them at all; they were left in the ground, and dug as required. A frost which penetrated deep caused the famine of 1739. Even with the modern system of storing in pits the potato does not last through the summer, and the "meal months"—June, July, and August—always brought great hardship. The danger increased as the growing population pressed ever harder upon the available land. Between 1831 and 1842 there were six seasons of dearth, approaching in some places to famine.

The population increased from 2,845,932 in 1785 to 5,356,594 in 1803. They married and were given in marriage. Wise men foresaw the deluge, but people who were already half-starved every summer did not think their case could well be worse. In 1845 the population had swelled to 8,295,061, the greater part of whom depended on the potato only. There was no margin, and when the "precarious exotic" failed an awful famine was the result.

Great public and private efforts were made to meet the case, and relief works were undertaken, on which, in March 1847, 734,000 persons, representing a family aggregate of not less than 3,000,000, were employed. It was found that labour and exposure were not good for half-starved men. The jobbing was frightful, and is probably inseparable from wholesale operations of this kind. The policy of the Government was accordingly changed, and the task of feeding a whole people was undertaken. More than 3,000,000 rations, generally cooked, were at one time distributed, but no exertions could altogether avert death in a country where the usual machinery for carrying, distributing, and preparing food was almost entirely wanting. From 200,000 to 300,000 perished of starvation or of fever caused by insufficient food. An exodus followed

which, necessary as it was, caused dreadful hardship, and among the Catholic Irish in America Fenianism took its rise. One good result of the famine was thoroughly to awaken Englishmen to their duty towards Ireland. Since then, purse-strings have been even too readily untied at the call of Irish distress.

Great brutalities disgraced the rebellion of 1798, but the people had suffered much and had French examples before them. The real originator of the movement was Cheobald Wolfe Tone, whose proffered services were ejected by Pitt, and who founded the United Irishmen. His Parisian adventures detailed by himself are most interesting, and his tomb is still the object of an annual pilgrimage. Tone was a Protestant, but he had imbibed socialist ideas, and hated the priests whose influence counteracted his own. In Wexford, where the insurrection went farthest, the ablest leaders were priests, but they acted against the policy of their church.

The inevitable Union followed (1st January 1801). Pitt had long before (1785) offered a commercial partnership which had been rejected on the ground that it involved the ultimate right of England to tax Ireland. He was not less liberally inclined in religious matters, but George III. stood in the way, and like William III. the minister would not risk his imperial desigus. Carried in great measure by the same corrupt means as the constitution of '82 had been worked by, the Union earned no gratitude. But it was a political necessity, and Grattan never gave his countrymen worse advice than when he urged them to "keep knocking at the Union." The advice has, however, been taken. Emmet's insurrection (1803) was the first emphatic protest. Then came the struggle for emancipation. It was proposed to couple the boon with a veto on the appointment of Roman Catholic bishops. It was the ghost of the old question of investitures. The remnant of the Catholic aristocracy would have granted it; even Pius VII. was not invincibly opposed to it; but Daniel O'Connell took the lead against it. Under his guidance the Catholic association became a formidable body. At last the priests gained control of the elections; the victor of Waterloo was obliged to confess that the king's government could no longer be carried on, and Catholic emancipation had to be granted (1829). The tithe war followed, and this most oppressive of all taxes was unfortunately commuted (1838) only in deference to clamour and violence. The repeal agitation was unsuccessful, but let us not be extreme to mark the faults of O'Connell's later years. He doubtless believed in repeal at first; probably he ceased to believe in it, but he was already deeply committed, and had abandoned a lucrative profession for politics. With some help from Father Mathew he kept the monster meetings in order, and his constant denunciations of lawless violence distinguish him from his imitators. His trial took place in 1844. There is a sympathetic sketch of O'Connell's career in Lecky's *Leaders of Opinion*; Wyse's *History of the Catholic Association* gives the best account of the religious struggle, and much may be learned from Fitzpatrick's *Life of Bishop Doyle*.

The national system of education introduced in 1833 was the real recantation of intolerant opinions, but the economic state of Ireland was fearful. The famine, emigration, and the new poor law have nearly got rid of starvation, but the people have not become frankly loyal, for they feel that they owe more to their own impotency, to their own misfortunes, than to the wisdom of their rulers. The literary efforts of young Ireland eventuated in another rebellion (1848); a revolutionary wave could not roll over Europe without touching the unlucky island. After the failure of that wretched outbreak there was

peace until the close of the American war released a number of adventurers trained to the use of arms and filled with hatred to England.

Already in 1858 the discovery of the Phoenix conspiracy had shown that the policy of Mitchel and his associates was not forgotten. John O'Mahony, one of the men of '48, organized a formidable secret society in America, which his historical studies led him to call the Fenian brotherhood. The money raised in the United States was perhaps not less than £80,000, but it is due to O'Mahony to say that he died poor. In Ireland the chief direction of the conspiracy was assumed by James Stephens, who had been implicated in the Phoenix affair, and who never cordially agreed with O'Mahony. Stephens was very despotic—a true revolutionary leader. As in all Irish political conspiracies there were traitors in the camp, who kept the authorities well informed, and in September 1865 the *Irish People* newspaper, which had been the organ of the movement, was suddenly suppressed by the Government. The arrests of Luby, O'Leary, and O'Donovan Rossa followed, all of whom, with many others, were afterwards prosecuted to conviction. Stephens for a time eluded the police, living with little concealment in a villa near Dublin, and apparently occupied in gardening. But in November he was identified and captured, much evidence being found in his house. Ten days afterwards he escaped from Richmond prison, and it is now known that some of the warders were Fenians. Another conspirator, sometimes called O'Brien and sometimes Osborne, afterwards escaped from Clonmel jail. American papers stated that Stephens was in actual want in New York in the winter of 1880, but he has since been heard of at Paris. The promptitude of the Government perhaps prevented a general insurrection, but there was a partial outbreak in February and March 1867, chiefly in Kerry, Limerick, and Tipperary. There was an affray, if it deserves the name, at Tallaght near Dublin, and a plot to seize Chester Castle was discovered and frustrated. The police, who behaved extremely well, were often attacked, but the Fenians abstained from plunder or from any acts which might estrange the rural population. The peasants, however, though for the most part nationalists, did not care to risk their lives in such a wild enterprise, and the young men of the towns furnished the only real force. Weather of extraordinary severity, which will long be remembered as the "Fenian winter," completed their discomfiture, and they suffered fearful hardships. There was enough sympathy with the movement to procure the election of O'Donovan Rossa for Tipperary in 1867, when he was actually undergoing penal servitude. John Mitchel, whose old sentence was unreversed, was chosen by the same constituency as late as 1875, but in neither case was the vote a large one. It became the fashion in Ireland to celebrate annually the obsequies of the "Manchester martyrs," as the three Fenians were called who suffered death for the murder of police-serjeant Brett. The Roman Catholic Church has always opposed secret societies, and some priests had the firmness to discountenance these political funerals, but strong popular excitement in Ireland has generally been beyond clerical control. Even now the Fenian spirit is not extinct, and one of the brotherhood, named Devoy, announced a new departure in January 1879. Devoy and his friends have certainly had considerable influence upon the recent agrarian agitation, which they have from motives of policy placed in the front, while keeping a separatist movement in reserve.

The Fenian movement disclosed much discontent, and was attended by criminal outrages in England. The abolition of the Irish Church Establishment, which had long been condemned by public opinion, was then decreed (1869). The land question was next taken in hand (1870), and

Fenianism.



many of those who opposed the changes made now think they have done good. These reforms did not, however, put an end to Irish agitation. The Home Rule party, which demanded the restoration of a separate Irish Parliament, showed increased activity, and the general election of 1874 gave it a strong representation at Westminster, where one section of the party developed into the "Obstructionists."

Bad seasons and distress among the peasantry (1878-1880) added force to the Land League, and agrarian outrages increased to an alarming extent on the expiration of the Peace Preservation Act and the rejection by the Lords of a bill temporarily limiting evictions. In 1881 a Coercion Act was passed, and was immediately followed by a new Land Act of large scope. (R. B.A.)

## INDEX.

- Absenteeism, 229.  
Administration, 239.  
Aed, King, 249.  
Agrarian offences, 239.  
Agriculture, 218; in Middle Ages, 255.  
Anglo-Norman invasion, 258.  
Area, 214.  
Assemblies, mediæval representative, 257.  
Bale, Bishop, 263.  
Banks, 236.  
Bards, ancient, 251.  
Beer manufacture, 233.  
Birmingham, John de, 269.  
Boayne, battle of, the, 268.  
Brehon system, 212.  
Breweries, 233.  
Brian Boruina, 253.  
Bruce, Edward, 269.  
Canals, 216.  
Carew, Sir Peter, 264.  
Catholic disabilities, 259, 265, 269; emancipation from, 271.  
Cattle, 223.  
Cereals, 223.  
Christianity, conversion to, 247.  
Church, early, 248, 259, temp. Henry VIII., 262; disestablishment, 271.  
Churches, mediæval, 255.  
Clans, 257.  
Climate, 218.  
Clontarf, battle of, 254.  
Coal, 217.  
Coast-line, 216.  
Colleges, 241.  
Columelle, St., 219.  
Commerce, 233.  
Cond, King, 245.  
Copper, 218.  
Cormac, King, 246.  
Costume in Middle Ages, 256.  
Cotton manufacture, 232.  
Counties, extent and population of, 215.  
County administration, 240.  
Coynce and livery, 262.  
Crime, 239.  
Cromwell, 267.  
Crops, 220.  
Customs in Middle Ages, 256.  
Dal-Cais dynasty, 253.  
Dances, invasions of, 252.  
Davies, Sir John, 265.  
De Lacy, Hugo, 259.  
Dermod, M'Murrough, 258.  
Henry granted to London citizens, 269; siege of, 268.  
Desmond, Earl of, 260.  
Desmond rebellions, 264, 265.  
Disabilities, Catholic, 259, 266, 269.  
Distilleries, 233.  
Dress in Middle Ages, 257.  
Dundalk, battle of, 260.  
Education, 241; national, inauguration of, 271.  
Elizabeth, Queen, 265.  
Emigration, 238.  
Emmet's insurrection, 271.  
Encumbered Estates Court, 229.  
English conquest, 238.  
Essex, Earl of, 264.  
Evidences, 228.  
Famine of 1739, 269; of 1846, 276.  
Farru holdings, 229.  
Feudalism, 271.  
Fisheries, 233.  
Flax culture, 231.  
Food in Middle Ages, 256.  
Forests, mediæval, 255.  
Fowlkind, 219.  
Geography, 214.  
Geology, 214.  
Government, 239.  
Grey, Lord-Deputy, 264.  
Henry II., invasion of, 258.  
Henry VIII., 262.  
History, 243.  
Holdings, farm, 220.  
Home Rule, 272.  
Horses, 224.  
Houses in Middle Ages, 255.  
Hui Neill dynasty, 249.  
Ireton, General, 267.  
Iron, 217.  
Islands, 216.  
James II., 268.  
Jesuits, 263.  
Kildare, Earl of, 260.  
Kings in Middle Ages, 256.  
Lakes, 216.  
Land distribution, 215; in Middle Ages, 255, 257.  
Land laws, 219, 228, 272.  
Landlords and tenants, 228.  
Landowners, statistics of, 227.  
Leal, 218.  
Legends, Irish, 214.  
Limerick, siege of, 268.  
Linen manufacture, 231.  
Live stock, 225.  
Local government, 210.  
Londonderry, grant of, 266; siege of, 268.  
Louth, Earl of, 260.  
M'Murrough, Dermot, 258.  
Malachy, King, 253.  
Man, Isle of, 252, 254.  
Manufactures, 230.  
Marriage customs in Middle Ages, 256.  
Marriage statistics, 238.  
Mathew, Father, 271.  
Middle Ages, state of Ireland in, 255.  
Milesians, 214.  
Mineral springs, 218.  
Minerals, 217.  
Mitchel, John, 271.  
Monasteries, ancient, 262.  
Mortality statistics, 238.  
Mountains, 214.  
Mug Nuadat, King, 246.  
Munster, city kingdom of, 245.  
Norman conquest, 258.  
Northmen, invasions of, 257.  
Norwegians, invasions of, 251.  
O'Kloy insurrection, 269.  
O'Connell, Daniel, 271.  
O'Neill, Hugh, 265.  
O'Neill, Owen Roe, 267.  
O'Neill, Shane, 264.  
Ormonde, Earl of, 269.  
Ormonde, Duke of, 269.  
Pale, the, 262.  
Parliament, 247.  
Parliament, imperial, representation in, 239; Irish, 266, 270.  
Patrick, St., 218.  
Peat, 217.  
Penal Acts, 268.  
Perrott, Sir John, 265.  
Pigs, 226.  
Plantation of Ulster, 266.  
Poor law, 239.  
Population, 247.  
Potter manufacture, 233.  
Potato culture, 224; dependence on, 270.  
Presbyterianism, Scotch, 269.  
Protestantism and Ultramontaniam, 262.  
Races, early, 213.  
Railways, 236.  
Rebellion (1583), 264; (1598), 265; (1641), 266; (1798, 1803, 1815), 271.  
Reformation, 263.  
Religion, statistics of, 240.  
Repeal agitation, 271.  
Representation, imperial, 269; in Middle Ages, 237.  
Revenue, 276.  
Rinuccini, 267.  
Rivers, 216.  
Ross, O'Donovan, 271.  
Round towers, 255.  
Schools, 241.  
Scott, 244.  
Scots, invasion of, 260.  
Sheep, 226.  
Shipbuilding, 235.  
Shipping trade, 233.  
Sidney, Sir Henry, 264.  
Silk manufacture, 232.  
Silver, 218.  
Simmel, Lambert, 261.  
Staples, Bishop, 253.  
Statistics, 214.  
Steelboys rising, 269.  
Stephens, James, 271.  
Strafford, Lord-Deputy, 266.  
Strongbow, 258.  
Tara, assembly of, 259.  
Taxation, 240.  
Templetogether, battle of, 260.  
Tenants and landlords, 228.  
Tiptoft, Earl of Worcester, 261.  
Tome, T. Wolfe, 271.  
Typography, 214.  
Trade, 233; restraint on, 267, 269.  
Trim, parliament of, 261.  
Tuathal, King, 245.  
Tyconnel, Earl of, 265, 268.  
Tyrrone, Earl of, 265.  
Ulster, plantation of, 266.  
Ultramontaniam and Protestantism, 262.  
Union, the, 271.  
United Irishmen, 271.  
Universities, 241.  
Valuation Acts, 236.  
Warbeck, Perkin, 261.  
Waste lands, 223.  
Waterford, Earls of, 261.  
Wealth, national, 236.  
Weapons in Middle Ages, 257.  
Whisky manufacture, 233.  
Whitboys, 270.  
William III., 268.  
Woollen manufacture, 239.  
Worcester, Earl of, 261.  
Worsted manufacture, 239.  
York, Duke of, viceroys, 271.  
Yorkist cause, espousal of, 261.

IRELAND, SAMUEL, the dupe of his son, the subject of the following article, in the publication of the supposed Shakespearian papers, was born in London, where he was originally a mechanic in Spitalfields. He afterwards became a dealer in old books and prints and similar articles; and, turning his knowledge of drawing and engraving to account, he published several books of travel, with illustrations in aquatinta. On December 24, 1796, Ireland published the *Miscellaneous Papers and Legal Instruments under the Hand and Seal of William Shakspeare; including the Tragedy of King Lear and a small fragment of Hamlet*, dated 1797, and purporting to be copies of originals furnished him by his son. Although, on the exposure of the fraud, the latter asserted his father's complete innocence, Samuel Ireland felt the disgrace very bitterly, and the occurrence is said to have hastened his death, which took place in July 1800.

His works, which at one time were in considerable request, include *A Picturesque Tour through Holland, Brabant, and part of France*, 2 vols., 1790; *Picturesque Views on the River Thames*, 2 vols., 1792, on the River Medway, 1793, on the Warwickshire Avon, 1795, on the River Wye, 1797, and on the River Severn, 1824; *Graphic Illustrations of Hogarth*, 2 vols., 1794; and *A Picturesque View, with an Historical Account of the Inns of Court*, 1800. On the forgeries question he published *A Vindication of his Conduct*, 1797, and *An Investigation of Mr Malone's Claim to the character of a Scholar or Critic*, 1797.

IRELAND, SAMUEL WILLIAM HENRY (1777-1835), generally known as William Henry Ireland, who at the age of seventeen produced the notorious Shakspeare forgeries, was the son of the subject of last notice, and was born in London in 1777. After spending four years at school in France, he was apprenticed in 1794 to a copyancer in London. The enthusiasm of his father for everything connected with Shakspeare suggested to young Ireland the idea of delighting him with a forged autograph of the poet. He carefully drew up a copy of an old deed, purporting to be a lease from Shakspeare to certain other parties, and presented it as a genuine document to his unsuspecting father. The complete success of this first attempt and the eager solicitations of his friends to ransack the papers among which he pretended to have found the lease were the incitements to a more ambitious career of literary forgery. He invented a story of a gentleman, accidentally met with, among whose old papers the documents were found, but who, for various reasons, refused to permit his name to be disclosed. A large collection of the most interesting relics was brought to light. A profession of faith, a love-letter, enclosing a lock of the poet's hair, to Anne Hathaway, private letters to and from Shakspeare, theatrical memoranda, notes of hand and receipts, agreements between Shakspeare and actors, pictures, annotated

books and tracts—all were produced and received with delighted credulity. Dr Parr, Dr Wharton, Sir Isaac Heard, James Boswell, and others came to register their belief in the authenticity of the papers. The assurance with which the imposture was conducted may be judged from the fact that a deed was brought forward, in which it was set forth that the papers and books had been bequeathed by Shakespeare to a certain contemporary William-Henrye Irelande, who had rescued him from drowning in the Thames, and who, there was evidence to show, was the direct ancestor of the Ireland whom chance had thrown in the way of the possessor of the relics. At last a whole new play, named *Vortigern*, was announced as having been discovered. Sheridan purchased it for Drury Lane Theatre, and an overflowing house assembled to sit in judgment upon it. But away from the glamour of crabbéd handwriting and yellow paper, the feeble dialogue and crude conceptions of the tragedy could not stand the test, and one representation sufficed to prove it a complete failure. Its fate prevented the composition of a series of historical plays, of which *Henry II.* had already been produced by the impudent Ireland. Samuel Ireland the elder had published the miscellaneous papers in what he asserts to have been the fullest belief in their authenticity, but the hostile criticism of Malone and others, and the unsatisfactory account of the source of the papers, combined to compel him to demand a full disclosure from his son. Harassed by the success of his own deceit, which had carried him far beyond his first intention, Ireland at last confessed his fraud, and published a tract with a full account in 1796. In 1805 he published more elaborate *Confessions*, in which he cannot conceal his satisfied vanity. After the exposure, Ireland was forced to abandon both his home and his profession. He wrote several novels of no value, and gradually sank to the condition of a bookseller's hack. He died in great penury in April 1835.

The more interesting publications on the Ireland forgeries are:—*Inquiry into the authenticity of certain Papers, &c., attributed to Shakespeare*, by Edward Malone, 1798; *An Apology for the Believers in the Shakespeare Papers*, 1797, and a *Supplemental Apology*, 1799, both by George Chalmers; and pamphlets by Bowden, Waldron, Wyatt, Webb, and Oulton. *Vortigern* was republished in 1832.

IRENÆUS, bishop of Lyons in the end of the 2d century, was one of the most distinguished of the theologians of the ante-Nicene church. Very little is known of his early history, and the accounts given in various biographies are for the most part conjectural. He himself has informed us that in his youth he was acquainted with Polycarp, the disciple of John (Eusebius, *Hist. Eccl.*, v. 20), and from this fact, together with his Greek name, his early and thorough Christian training, and his great acquaintance with Greek literature, it has been conjectured that he belonged to the neighbourhood of Smyrna in Asia Minor, and that he was the child of Christian parents. It is most probable that he died in the year 202, but the date of his birth is quite uncertain; the best authorities place it between 120 and 140. How he, born and educated in Asia Minor, came to spend his life in Gaul is also unknown. Eusebius tells us that he was a presbyter of Pothinus, bishop of Lyons, and it has been inferred from that passage that he was ordained by that bishop. In 177 the persecution under Marcus Aurelius reached Gaul, and the members of the churches of Lyons and Vienne suffered severely (see the letter of these churches to the brethren in Asia Minor and Phrygia, quoted by Eusebius, *Hist. Eccl.*, v. 1). Pothinus the bishop was one of the first martyrs. Irenæus was called to succeed him and to fill the honourable but dangerous post in the following year (178). Gregory of Tours has recorded his wonderful success in the city of Lyons, which in a short time became almost wholly Christian (*Hist. Eccl. Franc.*, i. 27), and tradition tells us

of many scholars of Irenæus who were notable missionaries among the Pagan Gauls. Irenæus, however, was best known by his endeavours to counteract the teachings of the Gnostics, and his attempts to mediate between the bishops of Rome and the churches of Asia Minor in their disputes about the proper time at which to keep Easter. The Gnostic teacher whose views spread to Gaul was Valentinus. He had come to Rome some time about the middle of the 2d century, and disciples had tried to propagate his opinions among the Christians in Gaul. It is said that the efforts of Irenæus resulted in a council held at Lyons, where the opinions of these Gnostics were condemned; but, as the evidence for this statement is not probably older than the 9th century, it may be considered doubtful. The Easter controversy, which lasted on to the council of Nicæa in 325, and assumed various forms, had a very simple origin,—the question whether, in reckoning the days on which our Lord died and rose again, Christians should keep by the day of the month simply, or so arrange it that the day to be observed in commemoration of our Lord's resurrection should always be a Sunday. The sacrament of the Lord's Supper was instituted on the 14th day of the Jewish month Nisan, and it was the opinion of the churches of Asia Minor that that day should always be observed; on the other hand, our Lord was crucified on a Friday and rose again on a Sunday, and the churches of Alexandria and Rome held that the two events should always be commemorated on a Friday and a Sunday respectively. In the time of Irenæus, Victor, bishop of Rome, made strenuous endeavours to bring about uniformity of celebration; and, when he failed to convince the churches of Asia Minor that the Western usage was right, he proposed to declare these churches heterodox, and to cut them off from ecclesiastical fellowship. The interference of Irenæus was intended to dissuade the pope from this hasty action, and his letter is interesting, not merely for its peace-loving sentiments, but because of the valuable information it gives upon the usages of the churches of the East and of the West (*cf.* Eusebius, *Hist. Eccl.*, v. 24). Gregory of Tours is our authority for saying that Irenæus died a martyr in the persecution under Severus; but, as this fact is not mentioned by Tertullian, Augustine, Eusebius, Theodoret, and other early writers, it is considered doubtful by most modern scholars. His death, whether crowned with the honour of martyrdom or not, must have taken place near the beginning of the 3d century. Gregory tells us that the bones of Irenæus were buried under the altar of the church at Lyons. The story that they were dug up and thrown into the street by the Calvinists in 1562 has been abundantly refuted.

Irenæus holds the same relation to the theology of the Greek fathers that Tertullian does to the doctrinal system of the Church of the West. In tracing back the history of a doctrine, it is common to find it first taking shape in the writings of one or both of these early theologians. Hence the great value of his writings. It is from Irenæus also that we get the earliest form of the creed which afterwards, through the labour of councils and theologians, became what we now know as the Niceno-Constantinopolitan creed (Lumby's *History of the Creeds*, p. 14, *cf.* Schaff, *The Creeds of the Latin and Greek Churches*, p. 40). The only writing of Irenæus which has come down to us, with the exception of fragments, is his work *Against Heresies*, and for this reason his opinions are all expressed by way of controversy. The treatise is divided into five books: of these the first two contain a minute description and criticism of the tenets of various heretical sects, both Gnostic and Ebionite; the other three set forth the true doctrines of Christianity, and it is from them that we find out the theological opinions of the author. Irenæus as a Christian theologian lays great stress on the existence of



the Christian church, and on the necessity of life within the church. Christianity does not consist merely in the possession of knowledge, but in partaking in a life which is to be lived in the world and beyond it. Believers have a common religious experience, and this rests both upon facts outside them and upon their association together within the church, while it implies a community of knowledge. The church rests upon the common facts contained in the gospel history; her historical succession of pastors places her in direct and outward relation to Christ, to whom her pastors ought to be inwardly related also by spiritual consanguinity. Her common knowledge—the true Gnosis, and not the false of the Gnostic—comes from the Holy Scriptures, which in Old Testament and New are inspired by the Holy Spirit and contain the truth of God. The church has also got, coming to her from apostolic times, and giving authoritatively the interpretation of the Scripture, certain forms of sound words or rules of faith which keep her from heresy. In speaking of God Irenæus is careful to insist that the God of the Christian church is the maker of heaven and earth, and the God of Abraham, Isaac, and Jacob; for it was a Gnostic inference from the supposed sinfulness of matter that the good God could not defile Himself with matter in a work of creation, and some carried their antipathy to the Old Testament so far as to make the Hebrew Jehovah a malignant deity whom Christ had come to destroy. Irenæus is at pains to explain that Christ, the Logos of God, the Saviour, is true man and true God, in opposition to the Gnostic Docetæ who taught that our Lord's body was only an assumed phantasm, and in contradiction to the Ebionites, who acknowledged Christ to be the last of the prophets, and looked upon Christianity as Judaism with a new prophet, but refused to confess him true God of true God. Irenæus also lays great stress upon the doctrine of the Trinity. His exposition is by no means either so full or so precise as that of theologians who write after the council of Nicæa, but he insists on the equality in divinity of the three persons, Father, Son, and Holy Ghost. The plan or method of salvation is commonly represented under the idea of a covenant, which word is used more in the sense of promise than of bargain. Sometimes the covenant is represented as twofold,—that given to the favoured nation and symbolized in the Mosaic economy, and that given to those who are not the descendants of Abraham and promised in the gospel; sometimes it is fourfold, and Irenæus speaks of a covenant given to Noah, and renewed through Abraham and Moses, and lastly in the gospel of our Lord. It is difficult to state with any precision what Irenæus holds about the nature of the effect of Christ's work of reconciliation upon man. He makes great use of metaphor, and evidently had not learnt to express himself otherwise. The doctrine was still in its pictorial state in his mind. Still, traces appear of that tendency afterwards common in the Greek Church to make the incarnation rather than the crucifixion and ascension of our Lord the most important part of his work, and to look upon the effect of that work as a transfusion of the incarnation through redeemed humanity. The doctrine of the sacraments is also too metaphorically expressed to admit of precise statement; but Irenæus seems to believe that in the sacrament of the Lord's Supper it is the heavenly body of Christ which is actually partaken of in the elements, and that such participation gives immortality.

Our knowledge of the writings of Irenæus comes principally from Eusebius. That church historian tells us that Irenæus wrote a *Letter to Florentius*, and a tract *On the Valentinian Octave* (of Æons), both against Gnostic theories; a *Letter to Pope Victor*, and another to *Blastus*, also at Rome, both on the Easter controversy; a work, probably an apologetic, called *Ἰρηναίου Ἐπιτομὴ τῶν Ἀποστολικῶν Καταβάσεων*; a *Picturæ of Apostolic Preaching*; and a book

of aphorisms. According to Plotinus, Irenæus wrote also on the *Substance of the World*. Fragments from these lost works and perhaps from others have been recovered from Eusebius, from Maximus of Turin, from Leontius of Byzantium, from John of Damascus, and from several collections of fragments, some of which were discovered in European libraries, and others came to the British Museum among Syrian MSS. from the Nitrian convents. The only work of Irenæus which has come to us entire is the treatise *Against Heresies*. The original Greek text, except the greater part of the first book, which has been preserved in quotations in Hippolytus and Epiphanius, has been lost, and the treatise has been preserved in a somewhat barbarous Latin version. The first edition was published by Erasmus in 1526. He used three MSS. which have since been lost. In 1570 Gallasius, a Calvinist professor in Geneva, published a new edition. He had before him the Greek text as far as given in the quotations in Epiphanius. The next important edition was that of Fenardent in 1596, and frequently reprinted. Fenardent used a Vatican MS. In 1702 Grabe published at Oxford a new edition, greatly better than preceding ones. He used the Amundel codex. In 1710 the Benedictine Massuet published at Paris another edition, in which three new MSS. were used. It long continued the standard, and forms the 5th volume of the Abbé Migne's *Patrologia Græca*, Paris, 1857. A valuable edition was published in 1849-53 by Adolph Stieren, which really superseded the others. The fragments discovered among the Syrian MSS., however, are only to be found in the Cambridge edition of 1857, edited by the Rev. W. Wigan Harvey. The extant writing of Irenæus, including the fragments, have been translated and published in Clark's *Ante-Nicene Library*. The facts of Irenæus's life and his dogmatic teaching and ecclesiastical position may be learnt from the prefaces of Fenardent, Massuet, and Stieren, as well as from such church historians as Tillemont, Schröck, Neander, and Fr. Chr. Haug. There is a very valuable monograph upon Irenæus in Ersch and Gruber's *Encyclopædie*, II. section, vol. xxiii., written by Stieren, the editor of the German edition. This was written, however, before the Syrian versions were discovered. (T. M. L.)

IRENE (752-803) was the wife of Leo IV., emperor of the East. A poor but beautiful Athenian orphan, she speedily added the confidence to the love of her feeble husband, and at his death in 780 was left by him sole guardian of the empire, and of their young son Constantine VI. Seizing the supreme power in the name of the latter, Irene's first endeavours were to revive the orthodox image-worship, which she had secretly cherished, although compelled solemnly to abjure it in the lifetime of her iconoclastic father-in-law and husband. In 784 she obtained the elevation of Tarasius, a partisan of her own, to the patriarchate; and, at first suffering the laws against image-worshippers to fall into disuse, she assembled a council of clergy at Nicæa in 787 to discuss the whole question anew. An attempt to hold the council at Constantinople in the preceding year had been frustrated by the iconoclastic zeal of the soldiers. Under the auspices of a ruler whose wishes were so clearly known, the decision of this second council of Nice could take only one direction, and the iconoclasts were hurled from their supremacy (vol. xii. p. 713). So long as Constantine remained a child, Irene was able to combine his interests and her own, and to rule wisely and faithfully; but as the prince approached maturity he began to grow restive under her autocratic sway. An attempt to free himself by force was met and crushed by the empress, who in her first indignation demanded that the oath of fidelity should thenceforward be taken to her name alone. The discontent which this occasioned swelled in 790 into open resistance, and the soldiers, headed by the Armenian guard, formally proclaimed Constantine VI. as the sole ruler. A hollow semblance of friendship was maintained between Constantine and Irene, whose title of empress he confirmed in 792; but the court, the army, and the capital were divided between rival factions, and that which supported the mother against her son grew daily in number and strength. Constantine perceived his danger too late to avert it; and when he saw the conspiracy ripe for action he could only flee for aid to the provinces. But even there he was surrounded by those who were already too deeply implicated in treason to refuse to complete their perfidy. Seized by his attendants on the Asiatic shore of the

Bósporus, the emperor was carried a captive back to the palace at Constantinople; and there, by the orders of his inhuman mother, in the very porphyry chamber where he first saw the light, his eyes were stabbed out by fierce blows of a murderous dagger. An eclipse of the sun and an obscurity of seventeen days were attributed by the common superstition to the horror of heaven at this crime. Irene, having thus removed her rival, reigned in prosperity and splendour for five years. She is said to have endeavoured to negotiate a marriage between herself and Charlemagne; but according to the Greek writers, who alone mention it, the scheme was frustrated by Aetius, one of her favourites. In 802 the patricians, upon whom she had lavished every honour and favour, conspired against her, and placed the avaricious Nicephorus on the throne. The haughty and unscrupulous princess, "who never lost sight of political power in the height of her religious zeal," who, hailed by the church as a second Helena, the mother of another great Constantine, had revealed herself to the world as a second Athaliah, was forced in her exile in Lesbos to support herself by the daily toil of her distaff. She died the following year. Her religious zeal has given her a place among the saints of the Greek Church.

See V. Mignet's *Histoire de l'Impératrice Irène*, 1762; Gibbon's *Decline and Fall*; Milman's *Latin Christianity*; Le Beau's *Bas-Empire*; and Schlosser's *Geschichte der bilderstürmenden Kaiser des oströmischen Reichs*, 1812.

IRETON, HENRY (1610-1651), Parliamentary general, was the eldest son of German Ireton of Attenton in Nottinghamshire, and was born in 1610. After graduating B.A. at Oxford, he entered the Middle Temple, London, as a student of law; but on the outbreak of the civil war he joined the Parliamentary army, in which his technical mastery of the military art gave him rapid promotion and helped him to obtain the special favour of Cromwell. On the formation of the "new model" he was appointed captain in Sir Robert Pye's regiment. Shortly before the battle of Naseby, in June 1645, he was promoted to a colonelcy, and on the eve of the battle he was on the suggestion of Cromwell made commissary-general and appointed to the command of the left wing, Cromwell himself commanding the right. The wing under Ireton was completely broken by the impetuous charge of Rupert, and Ireton was taken prisoner, but after the rout of the enemy which ensued on the successful charge of Cromwell he regained his freedom. He was present at the siege of Bristol in the September following, and he took an active part in the subsequent victorious campaign which resulted in the overthrow of the royal cause. While occupied with the siege of Oxford he was, in June 15, 1646, married at Holton House, 5 miles distant from the city—and at that time probably the headquarters of Fairfax—to Bridget, daughter of Oliver Cromwell. In the negotiations of the army with the Parliament, and in the conferences with the king, he took a leading part, being the person chiefly entrusted with the drawing up of the army papers, including the heads of proposals from the army to the king, a task for which he possessed the special qualifications of "a subtle-working brain" and a complete legal training. He is said to have been one of the principal instigators of the trial of the king, and was one of the most zealous supporters of his execution. The regiment of Ireton having been chosen by lot to accompany Cromwell in his Irish campaign, Ireton was appointed major-general; and on the recall of his chief to take the command in Scotland he remained with the title and powers of lord-deputy to complete the work of reduction. This he proceeded to do with his usual energy, and as much by the severity of his methods of punishment as by his military skill was rapidly bringing his task to a close. when during the sieg of Limerick he died, November

26, 1651, of an inflammatory fever, the result in all probability of exhaustion and exposure. His loss "struck a great sadness into Cromwell," and perhaps there was no one of the Parliamentary leaders who could have been less spared. He is said to have been of "melancholic, reserved, dark temperament;" and, while he possessed very high abilities as a soldier and great political penetration and insight, he resembled in stern unflinchingness of purpose the Protector himself.

IRIARTE, or YRIARTE, TOMAS DE (1750-1791), Spanish poet of the age of Charles III., was born September 18, 1750, at Orotava in the island of Teneriffe, and received his literary education at Madrid under the care of his uncle, Juan de Iriarte, a scholar who for forty years was head of the royal library, and whose name as a collector of proverbs still finds a place in the literary annals of his country. In his eighteenth year the nephew began his literary career by translating French plays for the royal theatre, and in 1770, under the anagram of Tinsó Imarete, he published an original comedy entitled *Hacer que hacemos*. In the following year he received an appointment as official translator in the foreign office, and in 1776 he became a keeper of the records in the war department. For a short time he now edited a journal entitled the *Mercurio Político*, and during this period of his life he added to the number of his original dramas (the best of these being *La Señorita mal criada*), and also composed various minor poems. In 1780 appeared his didactic poem *La Música*, the outcome of his proficiency in music, which attracted some attention in Italy and France as well as at home. It is composed in those masses of irregular lines known nationally as *silvus*, and consists of five books which severally treat of the elements of music, the various kinds of musical expression, the music of the theatre, of society, and of solitude. Its poetical merit is very small. In 1782 appeared the *Fábulas Literarias*, with which his name is most intimately associated. The work is of interest to the student of Spanish literature as being the first original attempt at fable-writing in that language; the stories, which numbered in the first edition about sixty and afterwards increased to eighty, are composed in a great variety of metres, and show in many cases considerable ingenuity (sometimes, it must be confessed, very far-fetched) and careful execution. As their name is intended to imply, they all relate to the follies and weaknesses of literary men. They have been translated into several European languages. An English version by Rockliffe reached a third edition in 1866. During his later years, partly in consequence of the *Fábulas*, he became involved in troubles with several of his literary contemporaries; and in 1786 he was charged before the Inquisition with having manifested leanings towards the new French philosophy. He died September 17, 1791.

The first collected edition of his works (*Obras*), prepared by himself, appeared at Madrid in six volumes in 1787; another, more complete, in eight volumes, in 1805. They include, besides those already mentioned, translations of the *Arts Poetica* of Horace and of the first four books of the *Æneid*, and also some metrical epistles.

IRIDIUM, one of the metals of the platinum group (see vol. v. p. 536), has recently acquired increased importance from its employment in alloy with platinum in the construction of the international standards of length and weight. Its separation from the associated metals is a matter of very considerable difficulty, and involves a long series of operations. These have been fully described by Deville and Debray (*Comptes Rendus*, lxxx. 839) and by Mr G. Matthey (*Roy. Soc. Proc.*, 1879, xxviii. 463). In practice, even when prepared with the utmost care, it still contains a minute though almost inappreciable amount of oxygen, rhodium, ruthenium, and possibly iron (Matthey).

Seubert has redetermined the atomic weight of iridium



by reducing ammonium iridichloride,  $(\text{NH}_4)_2\text{IrCl}_6$  and potassium iridichloride,  $\text{K}_2\text{IrCl}_6$ , by heating in a current of hydrogen, and finds as the mean of fifteen accordant experiments  $\text{Ir} = 192.74$  (*Berichte d. deut. chem. Gesellsch. zu Berlin*, 1878, 1767).<sup>1</sup> This result justifies the placing of iridium before platinum in the table in vol. v. p. 543.

The alloy used in the construction of the international geodesic standard was prepared by fusing together platinum and iridium in a lime crucible by a powerful blast of oxygen and coal gas; it has the following composition:

	Analysis 1.	Analysis 2.
Platinum .....	89.40	89.42
Iridium .....	10.16	10.22
Rhodium .....	0.18	0.16
Ruthenium .....	0.10	0.10
Iron .....	0.06	0.06

It is almost indestructible, and has extreme rigidity, especially in the tube form; its coefficient of elasticity is very great; it has a high density, and a most beautifully polished surface can be obtained upon it (comp. Deville, *Ann. Chim. Phys.* 1879 [5] xvi. 506). An iridio-platinum alloy containing about 20 per cent. of iridium has also a very high coefficient of elasticity (22.20), whilst its malleability and ductility are almost without limit. A 25 per cent. alloy can only with great difficulty be worked into sheet and wire when heated at a low temperature, 30 and 40 per cent. with great difficulty only at a temperature little below melting; it is brittle when cold, but has a grain of great beauty and fineness (Matthey).

IRIS, the rainbow, was personified as one of the secondary deities of Olympus, and occurs very frequently both in art and in literature. As the rainbow unites earth and heaven, Iris is the messenger of the gods to men; in this capacity she is mentioned frequently in the *Iliad*, but never in the *Odyssey*, where Hermes takes her place. According to Hesiod (*Theog.* 260) she is the daughter of Thaumas and Electra and sister of the Harpies, the stormwinds. With the swiftness of the wind (*ἀέλλοπος, ποδίηνμος*) she penetrates everywhere, bearing the messages of heaven. She often carries the caduceus, the herald's staff of Hermes. An epithet frequently applied to her is "golden-winged" (*χρυσόπτερος*), and in painting and sculpture she is always represented with wings. In the absence of other criteria, it is sometimes difficult to distinguish her from Nike. The latter is more frequently attendant on Athene, while Iris often accompanies Hera.

IRIS. The iris flower belongs to the natural family *Iridaceæ*, of the class monocotyledons, and to the petaloid division with inferior ovary and only three stamens (the outer series), being thus distinguished from the *Amaryllis* family, which has six stamens. They are handsome showy-flowered plants, the Greek name iris having been applied on account of the hues of the flowers. Two of the species are British,—*I. Pseudacorus*, or yellow flag, and the *I. fetidissima*, the fetid iris or roast-beef plant, with blue-purple rarely yellow flowers. The former species is widely distributed; the latter is English, although naturalized in Scotland and Ireland. The roasted seeds of *I. Pseudacorus* have been used as a substitute for coffee. *Iris florentina*, with white or pale blue flowers, is a native of the south of Europe, and is the source of the violet-scented orris root used in perfumery. *Iris versicolor*, or blue flag, is indigenous to North America, and yields "iridin," a powerful hepatic stimulant. *Iris germanica* of central Europe, "the most common purple Fleur de Luce" of Ray, is the large common blue iris of gardens, the bearded iris or fleur de luce. From the flowers of *Iris florentina* a

pigment—the "verdelis," "vert d'iris," or iris-green, formerly used by miniature painters—was prepared by maceration, the fluid being left to putrefy, when chalk or alum was added. The garden plants known as the Spanish iris and the English iris are both of Spanish origin, and have very showy flowers. Along with some other species, as *I. reticulata* and *I. persica*, both of which are fragrant, they form great favourites with florists. All these just mentioned differ from those formerly named in the nature of the underground stem, which is tuberous and not a rhizome as in *I. Pseudacorus*, *florentina*, &c. Modern botanists separate these bulbous irises from the genus *Iris*, and place them apart in the genus *Xiphium*, the Spanish iris,—*I. Xiphium* of the older botanists being now known as *Xiphium vulgare*. As defined by Baker, *Xiphium* includes 15 species, all from the Mediterranean region and the East, and *Iris* 81 species, mostly from the northern temperate region. Remains of three species of *Iris* have been met with in a fossil state, in rocks of Tertiary age.

IRISH MOSS, or CARRAGEEN (Irish *carrageen*, "moss of the rock"), is a sea-weed (*Chondrus crispus*) which grows abundantly along the rocky parts of the Atlantic coast of Europe and North America. It is collected for commercial purposes on the west and north-west of Ireland, and in very large quantities on the coast of Plymouth county, Massachusetts, United States. In its fresh condition the plant is soft and cartilaginous, varying in colour from a greenish-yellow to a dark purple or purplish-brown; but when washed and sun-dried for preservation it has a yellowish translucent horn-like aspect and consistency. The principal constituent of Irish moss is a mucilaginous body, of which it contains about 55 per cent.; and with that it has nearly 10 per cent. of albuminoids and about 15 per cent. of mineral matter rich in iodine and sulphur. When softened in water it has a sea-like odour, and from the abundance of its mucilage it will form a jelly on boiling with from 20 to 30 times its weight of water. The jelly of Irish moss is used as an occasional article of food, and is a popular remedy in cases of chest disease. It may also be used as a thickener in calico-printing, and in America it is used for fining beer. In the neighbourhood where it is obtained it is utilized for feeding cattle. As found in commerce, Irish moss is frequently mixed with *Gigartina mammillosa*, *G. acicularis*, and other sea-weeds with which it is associated in growth.

IRKUTSK, a government of Asiatic Russia, extending over an area of 272,140 square miles of eastern Siberia, and bounded by the Yenissei and Yakutsk governments, the Trans-Baikal region, and the Chinese frontier. It is divided into the districts of Kirensk, Nizhne-Udinsk, Irkutsk, Verkholensk, and Balagansk.

The surface of the government is mountainous, especially in the south-west. While the greater part lies at a level of from 1200 feet to nearly 3000 feet above the sea, the range of the Sayanski mountains reaches from 6000 feet to between 7000 and 8000 feet (the highest point, Mangu Sardnik, is in Chinese territory). Other mountains of note are the Gurbi Daban and Tunkinski Byelki ranges and the massif of the Khamar Daban. All the rivers of the government belong either to the system of the Yenissci (as the Angara and the two Tunguskas) or to that of the Lena (as the Kirenga, the Tchaya, the Tchuya, the Kuta, the Ilga). Of the geological features of the country the most remarkable is the wide distribution of volcanic products—basalts, dolerites, tuffs, obsidians even, and pumice. The mountain chains consist in the main of crystalline rocks. Iron is obtained in considerable quantities; coal-beds exist in various parts, especially in the basin of the Angara; graphite is wrought in several places; and salt-springs form the object of a considerable exploitation.

<sup>1</sup> Quite recently (Liebig's *Annalen*, cvii. 1), Seubert has corrected *he* atomic weight of platinum also, which he finds to be 194.34.

In 1879 the number of factories and public works in the government was 117, with 3322 workmen and a production amounting to 3,647,045 roubles, besides 57 workshops with upwards of 250 workmen and a production of nearly 280,000 roubles. The distilleries ranked first with 1,897,500 roubles. In the iron-works of Nicolaieff 795 workmen were employed, and the production was valued at 442,110 roubles. The salt-works were credited with 298,852 roubles, the cloth factories with 115,365, and the porcelain potteries with 85,962. The principal pottery is situated in the *okrug* or circle of Irkutsk, and employs about 1500 workmen; and its wares are widely known throughout all Siberia. The chief cloth factory is at Telninsk, about 40 miles from Irkutsk. Cigars are manufactured to the value of 115,000 roubles. See the *Pamyatnaya Knizhka* of the Stat. Com. of the Irkutsk Government, 1881.

The population, which in 1862 was 363,375, was 383,578 in 1879 (199,344 males). At the latter date the native tribes numbered 115,783 souls (59,979 males); the Buriats are the most numerous, these amounting to about 116,000 in 1862. The Yakuts and Tunguses are comparatively few. Of the European population a large proportion are exiles or descendants of exiles, most of them being of Polish blood. Shamanism was in 1879 the religion of 66,422, and Lamaism that of 12,491; 1837 were Mahometans, and 2878 Jews. Of the Christian population (319,919), the Orthodox Greek Church claims 296,521, and 2427 are Roman Catholics. In 1862 the Jews were under 900 and the Roman Catholics about 1200. The native tribes are being rapidly incorporated by the Orthodox Church.

According to observations taken at the town of Irkutsk, which is one of the regular meteorological stations of Russia (1536 feet above the sea), the temperatures ranged in 1879 from 99° Fahr in July to 34° below zero in January. In 1876 the minimum was 40° below zero. The mean temperature in summer is 56°, and in winter 7°.

IRKUTSK, the chief town of the government of the same name, is under various aspects the most important place in all Siberia, being not only the greatest centre of

1890 feet, is crossed by a flying bridge. The Irkut, from which the town takes its name, is a small river which rises in Lake Ilchin and joins the Angara directly opposite the present town, the main portion of which is separated from the monastery, the castle, the port, and the suburbs by another affluent the Ida or Ushakovka. Irkutsk has long been reputed a remarkably fine city for such an outlying situation—its streets being straight, broad, well paved, and well lighted; but in 1879, on the 22d and 24th June (4th and 6th July), the greater proportion of its houses being of wood, the central and most important part fell a prey to a great conflagration. In the accompanying plan the area laid waste is indicated by the lighter shade. The palace of the governor-general, the principal administrative and municipal offices, and many of the other public buildings were destroyed; and the government archives, the admirable library (10,000 vols.) and museum of the Siberian section of the Geographical Society, with minor collections of the same kind, were utterly ruined. The total loss was estimated at 30,000,000 roubles. Full details will be found in D. D. Larionoff's *Gub. gorod Irkutsk* (Irkutsk, 1880). A cathedral (built of wood in 1693 and rebuilt of stone in 1718) and other twenty-three Orthodox churches, a fine gymnasium, a school of medicine, a museum, a theatre, a town's hospital and a military hospital, an orphan asylum, an infirmary, the penitentiary, and the crown factories are among the public institutions and buildings.

The origin of Irkutsk is to be found in the winter-quarters established by Ivan Pokhaboff for the collection of the fur tax from the Buriats. Its existence as a town dates from 1686. The first church, that of our Saviour, and the monastery of the Ascension, 34 miles from the town, were built in 1672, and that of the Apparition of the Virgin in 1693. It was in 1731 that the town was made the administrative centre of the Irkutsk province, and its position as chief town of the government dates from 1784. Its population, which was about 6500 at the time of Gmelin's visit (1740), had increased to 16,569 by 1838, and to 24,779 in 1862 (12,639 males). An elaborate census taken in 1875 gave 18,076 males and 14,436 females, a total of 32,512. This increase is wholly produced by immigration; for the death-rate always considerably exceeds the birth-rate, a fact easily explained by the vast proportion of the unmarried classes,—public employes, soldiers, ecclesiastics, prisoners, and domestics amounting to 12,876 in 1875.

IRNERIUS, a distinguished jurist, sometimes referred to as "Incerna juris," who taught the "free arts" at Bologna, his native city, during the earlier decades of the 12th century. Other forms of the name are Yrnerius, Hirnerius, Hyrnerius, Warnerius, Wernerius, Guarnerius, Geroerius, some of which have been held to be suggestive of a German origin. Of his personal history nothing is known, except that it was at the instance of the Countess Matilda, Hildebrand's friend, who died in 1115, that he directed his attention and that of his students to the *Institutes* and *Code* of Justinian; that after 1116 he appears to have held some office under the emperor Henry V.; and that he died, perhaps during the reign of the emperor Lothair II., but certainly before 1140. He was the first of the Glossators (see GLOSS), and according to ancient opinion (which, however, has been much controverted in later times) was the author of the epitome of the *Novells* of Justinian, called the *Authentica*, arranged according to the titles of the *Code*. His *Formularium Tabellionum* (a directory for notaries) and *Questiones* (a book of decisions) are no longer extant. His position as the founder of all learned investigation into the laws of Justinian is an important one; and he and his school are generally held to present an almost brilliant contrast, not only with the law writers of the preceding, but also with the jurists of the latter part of the following century.

See Savigny, *Gesch. d. Röm. Rechts im Mittelalter*, iii. 83; Vecchio, *Notizie di Irnerio e della sua scuola*, Pisa, 1869; and Ficker, *Forsch. z. Reichs- u. Rechtsgesch. Italiens*, vol. iii., Innsbruck, 1870.



Plan of Irkutsk.

- |                         |                      |                                      |
|-------------------------|----------------------|--------------------------------------|
| 1. Cathedral.           | 10. Gymnasium.       | 19. Garden of Church of our Saviour. |
| 2. Archbishop's Palace. | 11. Kindergarten.    | 20. Custom House.                    |
| 3. Seminary.            | 12. Orphanage.       | 21. Ch. of Thaumaturgo.              |
| 4. Vladimir's Church.   | 13. Juvenile Asylum. | 22. Asylum.                          |
| 5. Retail Bazaar.       | 14. Town Buildings.  | 23. Sisters of Mercy.                |
| 6. Ch. of Annunciation. | 15. Museum.          | 24. Church of Trinity.               |
| 7. Synagogue.           | 16. Tikhvin Church.  | 25. Church of Gregory of Nyssa.      |
| 8. Female Gymnasium.    | 17. Merchants' Hall. |                                      |
| 9. Mining Commission.   | 18. New Cathedral.   |                                      |

population and principal commercial depôt to the north of Tashkend, but the residence of the governor-general, a fortified military post, an archbishopric, and the seat of several learned societies. It is situated in 52° 17' N. lat. and 101° 12' E. long., 3780 miles from St Petersburg. The town proper lies on the right bank of the Angara, a tributary of the Yenissei, and on the opposite bank is the Glaskovsk suburb. The river, which has a breadth of



## I R O N

**I**N the short space that can be allotted to the wide subjects of IRON and STEEL, it is impossible to do more than briefly describe the main facts in connexion with the general properties and relationships of iron and steel, and their modes of manufacture. These points will be considered under the following general heads.

- I. *General characters of iron; its relationships to other elements.*
  1. Properties of iron.
  2. Chemical and physical relationships of iron.
  3. Relationships between iron and steels of various kinds.
- II. *Natural sources of iron.*
  4. Meteoric iron.
  5. Iron ores.
  6. Methods of analysis of iron ores, metallic iron, and steel.
- III. *Extraction of iron from its ores.*
  7. General history of the manufacture of iron and steel.
  8. Classification of methods of manufacture.
- IV. *Manufacture of cast iron; iron smelting.*
  9. Preliminary treatment of ores.
  10. Fuel.
  11. Fluxes.
  12. Construction of blast furnaces.
  13. Subsidiary appliances; hoists and lifts.
  14. " " blowing engines.
  15. " " apparatus for superheating the blast, and for determining its temperature; tuyeres.
  16. Collection of pig iron and cinder, and their composition.
  17. Utilization of cinder.
  18. Collection of waste gases, and their composition.
  19. Chemical changes taking place in the blast furnace.
  20. Development and appropriation of heat in blast furnaces.
  21. Conditions regulating economy of fuel in blast furnaces.
- V. *Conversion of pig iron into malleable iron and steel by decarbonization processes.*
  22. Malleable cast iron.
  23. Refining, fining, and puddling of pig iron.
  24. Machine puddling.
  25. Machinery and appliances for working malleable iron.
  26. Puddled steel and natural steel.
  27. Bessemer's original process (pneumatic process).
  28. Heaton's process.
- VI. *Production of malleable iron and steel from the ore at one operation without passing through the stage of cast iron.*
  29. Catalan forge and analogous appliances.
  30. Spongy iron processes.
  31. Siemens's precipitation process.
- VII. *Conversion of malleable iron into steel by direct carbonization.*
  32. Cementation process and subsequent operations.
  33. Cast steel.
  34. Case hardening.
  35. Crucible steel; Wootz; Mushet and Heath's processes.
- VIII. *Methods of steel production essentially involving combinations of the preceding processes.*
  36. The Bessemer-Mushet process and its precursors.
  37. The "basic" process.
  38. The Uchatius process.
  39. Siemens-Martin processes; open-hearth steels.
  40. The Perrot and Ponsard furnaces.
  41. Manufacture of spiegel-eisen and ferro-manganese.
- IX. *Physical qualities of iron, and steel in their practical relationships.*
  42. Hardening, tempering, and annealing.
  43. Tenacity and strength of iron and steel.
  44. Foundry operations; casting under pressure.
  45. Protection of iron from rust.
- X. *Statistics of the iron trade.*

## I. GENERAL CHARACTERS OF IRON AND ITS RELATIONSHIPS TO OTHER ELEMENTS.

1. *Properties of Iron.*—The peculiar physical characters of iron, more especially when in the form of steel or slightly carbonized iron, have rendered this element one of special importance since the earliest ages for the fabrication of cutting instruments, weapons, and tools of various kinds.

In the form of moderately-pure malleable or wrought iron, the metal is a substance possessed of considerable lustre and hardness, and of a bluish-white or bluish-grey colour; it takes a high polish, and when bright does not readily oxidize in dry air, although moist air, especially in presence of traces of acids, even of carbonic acid, readily effects its tarnishing and the subsequent formation of rust. It has a specific gravity near to 7.75, and requires a very high temperature to effect its fusion, the melting point being the more elevated the purer the substance; its most valuable and characteristic property is its power of becoming soft and pasty before undergoing complete fusion, so that two hot masses may be pressed or squeezed together into one by the process of *welding*, and so that by forging, rolling, hammering, or other analogous operations it can readily be fashioned into shapes which its rigidity and strength when cold enable it to maintain. Its strength and tenacity are very high, as also are its powers of being drawn into wire and rolled or hammered into sheets (ductility and malleability); these properties, however, are very largely influenced by the presence of impurities. In magnetic characters it is superior to all other substances, nickel and cobalt coming next to it in these respects, but being much lower in power; when it is almost pure, the magnetic influence produced, owing to induction, by the proximity of a permanent magnet or of an electric current disappears entirely on removal of the magnet or current; if, on the other hand, carbon be present (as is usually the case to some extent even in the softest malleable iron), there remains after removal of the magnet or current a greater or less amount of permanent magnetism according to circumstances, hard steel exhibiting the greatest power of becoming permanently magnetized under given conditions, and substances intermediate between pure iron and hard steel (soft steels and hard irons) possessing this power to a lesser extent. Other elements besides carbon, e.g., oxygen and sulphur, can communicate to iron the power of becoming permanently magnetized, as in the case of the minerals loadstone (magnetic oxide of iron) and magnetic pyrites. The effect of a magnet on iron at high temperatures is far below that exhibited at ordinary temperatures; according to Matteucci the action of a given magnet on a molten globule of iron is only 0.0015 per cent. of that on the same globule when cold, so that the attractive action is wholly insensible in the case of molten iron except when a powerful electromagnet is employed. In electrical conductivity and power of conducting heat (which are always approximately in the same ratio), iron stands about midway amongst metals; Matthiessen's experiments give the specific resistance (C. G. S. system) of annealed iron as 9827 at 0° C., that of annealed silver being 1521 and that of mercury 96,190 at the same temperature. As with the other physical properties, the presence of small amounts of impurity largely affects the numerical value of the specific resistance, which is decreased some 35 per cent. by a rise in temperature from 0° to 100° C.

The specific heat of iron at the ordinary temperature is 0.11379 (Regnault), 0.110 (Dulong and Petit). Pouillet gives the melting point when in a state of high purity as between 1500° and 1600° (probably somewhat too low), Scheerer as 2100°, Deville as near to that of platinum, which is not far from 1900°–2000°. The presence of minute quantities of carbon, sulphur, &c., sensibly lowers the fusing point, whilst 1 per cent. of the former furnishes a steel melting at several hundred degrees lower than pure iron (at near 1600°),—cast iron containing some 3 per cent. of carbon,

mélting at near 1500°, and being rendered still more fusible by the presence of small quantities of sulphur and silicon; whence sulphurized pig irons are often blended with purer varieties in order to produce good casting metal for various purposes. At the ordinary temperature the linear coefficient of expansion of wrought iron is near to 0.000125 (values between 0.000115 and 0.000144 having been obtained by Borda, Smeaton, Lavoisier and Laplace, Troughton, and Dulong and Petit), so that 1 unit of length at 0° will become on an average 1.00125 units in length at 100°. Slightly lower values have been obtained with steel of different qualities by various of these observers, averaging 0.000115; whilst cast iron expands less still, averaging 0.000111 as linear coefficient of expansion; the precise numbers obtainable vary with the conditions, according as the metal has been hammered, rolled, hardened, annealed, &c. At somewhat elevated temperatures the rate of expansion is higher; thus Dulong and Petit find that the mean rate of expansion of iron between 0° and 100° is to that between 0° and 300° nearly in the ratio of 4 to 5. The force exerted during expansion is very great, being equal to that requisite to produce an elongation of the bar examined to the extent through which its length increases by heat; thus, according to Barlow, a weight of 1 ton suspended to an iron bar a square inch in section will extend its length by 0.0001 times the original length, so that 1 inch of length will become 1.0001 inches; this increase in length would be brought about by a rise in temperature of about 9° C.; hence for an increase of 36°, or less than the average difference between a cold and warm day in winter and summer respectively, a girder of iron of 20 square inches in section would exert a thrusting strain upon two walls, &c., built firmly up to its ends when coldest, equal to about  $20 \times \frac{36}{9}$  or 80 tons for each inch of its length, were it not that the pressure is more or less relieved by the giving of the walls long before this strain is reached. In consequence it is indispensable to allow a space for expansion in all constructions in which iron is employed, e.g., ordinary buildings, railways, furnaces braced together with tie-rods, &c.

With large masses of ironwork exposed to the weather, very great strains may be produced through unequal expansion in differently heated parts, e.g., in the portions exposed to sunshine and in the shade respectively; as just indicated, a difference of temperature of 9° between two portions rigidly connected will produce a strain of about 1 ton per square inch. Edwin Clark has calculated that half an hour's sunshine produces more effect in the way of developing strain on the tubes of the Britannia bridge over the Menai Straits than the heaviest rolling loads or the most violent storms. Variations of temperature also exert some effect upon the strength and tenacity of iron; the numerical values are largely variable with the quality of the metal. At temperatures below a red heat the strength is considerably lessened, and at high temperatures approximating to the welding temperature the tenacity becomes comparatively small (see § 43).

A peculiar suspension of the chemical activity of iron in reference to nitric acid (passive condition) appears to be connected with its electrical relationships; when placed in nitric acid very slightly diluted (specific gravity about 1.4), iron is ordinarily violently attacked; but if whilst in the acid it be touched with certain substances, e.g., gold, platinum, plumbago, &c., the action stops (at least under certain conditions, especially when not heated above some particular temperature varying with the strength of the acid—Orlway); the iron thus rendered passive will induce the same condition in a second piece immersed in the acid by contact; on exposure to air the passive iron loses its power of remaining unattacked. Concentrated nitric acid, of specific gravity 1.45, produces the passive condition at once, so that a piece of bright metal may be kept for months immersed in the acid without any action being set up; a acid of strength below specific gravity 1.35, on the other hand, is usually incapable of permitting iron to become or

remain passive in contact with it. If, whilst passive and immersed in nitric acid, iron be made the positive pole for a voltaic current sent through the acid, oxygen is evolved from its surface without any oxidation being visible; if on the other hand it be made the negative pole, it immediately loses its passivity and is attacked by the acid. In consequence of the production of the passive state by contact with concentrated nitric acid, iron is sometimes substituted for carbon or for platinum in the forms of voltaic battery known as Bunsen's and Grove's cells. Passivity may also be brought about in iron by heating the bright metal in the flame of a spirit lamp, &c., so as to coat it superficially with a film of oxide.

*Preparation of Pure Iron.*—In order to prepare pure iron, special chemical operations must be gone through, of increasing complexity the greater the purity desired. Berzelius obtained a nearly pure fused substance by mixing filings of the purest soft iron of commerce obtainable with about 20 per cent. of pure ferric oxide and some glass powder (free from lead) as a flux, and exposing for an hour to the highest heat of a smith's forge in a covered crucible; in this way the small quantities of carbon and other impurities still retained by the filings are oxidized, and a button of silvery lustre results, of specific gravity 7.844, more tough but softer than ordinary iron. Matthiessen and Szczezanowski found the greatest difficulty in obtaining iron absolutely free from sulphur by means of the ordinary methods for preparing oxide of iron subsequently reduced by pure hydrogen, but ultimately succeeded in obtaining moderately large quantities of metal not containing more than 0.00025 to 0.0007 per cent. of sulphur by the employment of a specially prepared ferric oxide made by heating together pure ferrous sulphate and sodium sulphate (*Brit. Assoc. Reports*, 1868, 1869), and thoroughly washing out the sodium sulphate from the fluxed product. After reduction in platinum vessels by pure hydrogen, and fusion in lime crucibles by the oxyhydrogen flame fed with purified gases, buttons of metal were obtained absolutely free from phosphorus, silicon, and calcium, and practically free from sulphur. By the electrolysis of as nearly as possible neutral solutions of ferrous chloride, or better of double magnesium ferrous sulphate, iron is thrown down in hard brittle films containing a considerable amount of occluded hydrogen (usually about twenty times its volume); on annealing, the metal becomes soft, malleable, and silvery white, increasing considerably in density, the specific gravity when first deposited being about 7.87, and rising to 7.81 after annealing; Lenz finds that the amount of hydrogen occluded is greater the thinner the film of metal, the amount rising in the case of a very thin film to upwards of 180 volumes; the metal deprived of the occluded gas by heating in vacuo decomposes water at ordinary temperatures and rusts, partially reabsorbing hydrogen in so doing (*Pogg. Annalen*, v. 242, 1870); whereas before the expulsion of the hydrogen by heating in vacuo the iron is highly brittle and of a fine granular texture, showing no crystalline structure under the microscope (being deposited from solutions containing no free acid), after the expulsion of the hydrogen the metal becomes highly tenacious and capable of resisting repeated bending backwards and forwards without rupture; the hardness is lowered from 5.5 to 4.5 on the mineralogical scale, i.e., from something between the hardness of feldspar and apatite to something between that of apatite and fluor spar. Under certain conditions iron can be obtained in a crystallized state, the crystalline character being far more readily assumed when small quantities of other substances, notably carbon, are present; by reducing ferrous chloride by hydrogen at a red heat, Peligot obtained the metal in brilliant crystals belonging to the cubic system; by reduction with zinc vapour Poncelet transformed ferrous chloride into hollow tetrahedra of specific gravity 7.84. Bessemer iron has been obtained in distinct cubic crystals, whilst Percy has observed solid and skeleton octahedra in cast iron. Malleable iron that has been much rolled and forged during its manufacture exhibits on etching with acids a fibrous structure; when pulled asunder by a slowly acting force, this structure is also well seen; if, however, it be transversely ruptured by a suddenly applied force (e.g., the impact of a heavy shot on an armour plate), a crystalline fracture usually results. Iron exhibiting fibrous structure on etching is usually considerably more tough and tenacious than that which is crystalline. A change from the former kind of molecular structure to the latter, producing comparative brittleness, is believed by many to occur with crank-shafts, axles, &c., exposed to continuous vibration and jolting; in some cases the acquisition of a high degree of permanent magnetism (e.g., in pump rods) is said to have been observed as occurring just before rupture of the metal took place.

*2. Chemical and Physical Relationships of Iron.*—Iron unites with oxygen in several proportions, forming definite oxides, the best marked of which are those indicated by the formulæ  $\text{FeO}$ ,  $\text{Fe}_2\text{O}_3$ , and  $\text{Fe}_3\text{O}_4$ , O standing for 16 parts of oxygen, and Fe for 56 of iron, the value 56 being



chosen rather than the older combining number 28 in accordance with Dulong and Petit's law. Besides these, however, indications of the existence of a lower oxide  $\text{Fe}_2\text{O}$  have been obtained by Lowthian Bell (*Chemical Phenomena of Iron Smelting*, p. 85); for by partially reducing the higher oxides by carbon oxide at temperatures near to  $420^\circ\text{C}$ ., a mixture of metallic iron, unreduced oxide, and free carbon results, from which the iron can be dissolved out by digestion with water and iodine in closed vessels, after which the relationship between the undissolved iron and the oxygen present is very close to that indicated by the formula  $\text{Fe}_2\text{O}$ . On the other hand, derivatives of an oxide higher than  $\text{Fe}_2\text{O}_3$  exist, compounds known as *ferrates* being formed by heating iron with nitre, and in other ways, the composition of which may be expressed by regarding them as containing iron trioxide united to other metallic oxides, e.g., potassium ferrate,  $\text{K}_2\text{O}, \text{FeO}_3$  (just as potassium sulphate may be regarded as an analogous compound containing sulphur trioxide,  $\text{K}_2\text{O}, \text{SO}_3$ ). Neither the hypothetical ferric anhydride (or iron trioxide,  $\text{FeO}_3$ ) nor any other oxide intermediate between it and  $\text{Fe}_2\text{O}_3$  has as yet been isolated, although iron disulphide,  $\text{FeS}_2$ , is well known.

Of these oxides, two, viz.,  $\text{FeO}$  and  $\text{Fe}_2\text{O}_3$ , correspond to stable well-defined classes of salts conveniently referred to as the *ferrous* and *ferric salts* respectively, 56 parts of iron replacing 2 parts of hydrogen in an acid to form the corresponding ferrous salt, and replacing 3 parts to form a ferric salt. The heat of formation of all oxides up to  $\text{Fe}_3\text{O}_4$  appears to be about uniform, viz., near to 66,000 grammes degrees per 16 grammes of oxygen combined; but that of the formation of  $\text{Fe}_2\text{O}_3$  is sensibly less, so that when the latter oxide is reduced the rate of reduction is much more rapid prior to the removal of one-ninth of the oxygen present and consequent formation of  $\text{Fe}_3\text{O}_4$  than it is subsequently, in accordance with the general law which appears to exist connecting the rate at which reduction goes on with the development of heat during the chemical change (Alder Wright and Rennie, *Chem. Soc. Journal*, 1880 [*Transactions*], p. 757). Probably it is in consequence of this that  $\text{Fe}_2\text{O}_3$  breaks up at an intense white heat into oxygen and  $\text{Fe}_3\text{O}_4$ , and that when iron is burnt in oxygen so that the temperature is very high  $\text{Fe}_3\text{O}_4$  is formed and not  $\text{Fe}_2\text{O}_3$ ; just as higher oxides of manganese than the corresponding  $\text{Mn}_2\text{O}_3$  break up on strong ignition into oxygen and  $\text{Mn}_3\text{O}_4$ . On the other hand, just as oxides of manganese lower than  $\text{Mn}_3\text{O}_4$ , and also that oxide itself, take up oxygen forming higher oxides on heating in the air to moderate temperatures, so  $\text{Fe}_3\text{O}_4$  can be oxidized to  $\text{Fe}_2\text{O}_3$  by direct addition of oxygen taken up in the same way; it is noticeable, however, that, whilst  $\text{Fe}_3\text{O}_4$ , possessing a certain kind of physical structure, will thus oxidize to  $\text{Fe}_2\text{O}_3$  on being exposed to ordinary atmospheric influences, yet when other kinds of physical structure are possessed (producible by special modes of formation) its tendency to oxidize further even in moist city air becomes inappreciable.

It is remarkable that, whilst iron ores which mainly contain the oxide  $\text{Fe}_3\text{O}_4$  are highly magnetic in character (the loadstones being one variety of this class of minerals, and the generic names "magnetic iron ore" and "magnetic oxide of iron" being derived from this fact), the other iron compounds found in nature are far less marked in regard of their possession of this quality, one particular sulphide of iron excepted, termed magnetic pyrites in consequence, and indicated by the formula  $\text{Fe}_7\text{S}_8$ , or possibly  $\text{Fe}_8\text{S}_9$ . Thus the following values were found by Plücker as the relative effects of equal volumes of soft iron, loadstone, specular iron ore, and brown hematite on a given magnet under similar conditions:—

Soft iron.....100	Specular ore.....	0.533
Native magnetic oxide.....	Brown hematite.....	0.071
40 227		

Oxides of iron of all classes are readily acted upon by reducing agents (especially hydrogen, carbon, oxide, and free carbon and

silicon) in such a fashion as to cause the transference of the oxygen of the oxide to the reducing agent, a lower oxide of iron and finally metallic iron being set free. In accordance with the general rules obtaining in such cases (Alder Wright and Rennie, *loc. cit.*), the rate of reduction of ferric oxide of given physical character is less, *ceteris paribus*, when a reducing agent is employed which evolves less heat in uniting with oxygen than when one is used evolving more heat; so that a reduction by hydrogen with formation of water vapour goes on more slowly under constant conditions than reduction by carbon oxide forming carbon dioxide, whilst the temperature requisite to cause reduction to be brought about to a just measurable extent (*temperature of initial action*) is lower with carbon oxide than with hydrogen, and lower with hydrogen than with free carbon (Alder Wright and Luff, *Chem. Soc. Journal*, 1878 [*Transactions*], pp. 1, 504). The precise rate of reduction and temperature of initial action observed in any given case vary with the conditions of the experiment and also with the physical character of the iron oxide (see also Lowthian Bell, *Chemical Phenomena of Iron Smelting*).

When ferric oxide is reduced by carbon oxide, a peculiar secondary change is brought about under certain conditions, which has been investigated by Lowthian Bell with the present writer's co-operation (*loc. cit.*); this consists in the reaction of a lower oxide of iron ( $\text{Fe}_2\text{O}$ ?) formed at a certain stage of the reduction on the carbon oxide forming a higher oxide of iron and setting free carbon; the higher oxide of iron is then again reduced by a fresh portion of carbon oxide, and so on in a cycle, so that after some time the quantity of free carbon deposited largely exceeds the total iron present. This peculiar action is also exhibited by oxides of nickel and cobalt, but apparently by those of no other metals; it has a most remarkable influence upon the nature of the chemical changes ensuing in the process of smelting iron by the blast furnace (§ 19), and is doubtless the chief source of the carbon contained in pig iron thus produced; it is also the main reaction taking place during the conversion of iron into steel by cementation (§ 32).

Ferrous carbonate differs from most of the other compounds of iron found in nature in being soluble in water, especially when excess of carbonic acid is also present, an "acid carbonate" being formed. Such water on exposure to air forms a rusty deposit of hydrated ferric oxide produced by the combination of the oxygen of the air with the ferrous oxide contained in the ferrous carbonate, the carbon dioxide originally combined therewith being set free. In certain localities large deposits of more or less pure hydrated ferric oxide are thus formed, constituting "bog iron ores."

The *sulphides* of iron partly correspond to the oxides. Thus the sulphides  $\text{Fe}_2\text{S}$ ,  $\text{FeS}$ , and  $\text{Fe}_2\text{S}_3$  exist; besides these, the compound  $\text{Fe}_3\text{S}$  has been described, whilst *magnetic pyrites*,  $\text{Fe}_7\text{S}_8$  (or  $\text{Fe}_8\text{S}_9$ ), and ordinary *pyrites*,  $\text{FeS}_2$ , and its allotropic or metameric modification *marcasite*, constitute minerals of widespread occurrence, and of considerable value, mainly as sources of sulphur, secondarily on account of the iron they contain, and more especially with certain kinds of pyrites on account of the copper, silver, and gold sulphides intermixed therewith. It is to be noticed in connexion with pyrites that, by the action of reducing agents on solutions of iron compounds in presence of sulphates, a slow formation of crystalline  $\text{FeS}_2$  often results; thus many fossil plants and animals occur in various strata in which the deposition of pyrites by this means has produced a perfect cast or pseudomorph, so to speak, of the organism; it is probable that the pyritic deposits of large magnitude which exist in various localities have been formed by these agencies, the soluble iron salt having been originally the carbonate.

The *chlorides* of iron correspond to the ferrous and ferric series of salts, i.e., are indicated by the formulae  $\text{FeCl}_2$  and  $\text{FeCl}_3$  (or preferably  $\text{Fe}_2\text{Cl}_4$  and  $\text{Fe}_2\text{Cl}_6$ ) respectively; chlorides corresponding to  $\text{Fe}_2\text{O}$ ,  $\text{Fe}_2\text{O}_3$ ,  $\text{FeS}_2$ , &c., have not as yet been formed. The same remark applies to the salts of iron formed by the substitution of iron for hydrogen in all the acids of common occurrence. For the use of iron salts and other ferruginous compounds in the arts

<sup>1</sup> According to Grüner (*Comptes Rendus*, 1871, 281), the reaction is  

$$3\text{FeO} + \text{CO} = \text{Fe}_3\text{O}_4 + \text{C}$$

some metallic iron being always formed in addition to the ferrous oxide produced by the subsequent reduction of the  $\text{Fe}_3\text{O}_4$ , so that a ferruginous carbon always results.

generally see separate articles. Its therapeutic uses are noticed at p. 359.

3. *Relationships between Iron (Malleable and Cast) and Steel.*—Iron possesses the power of uniting with a number of elements, forming products which either are highly intimate mixtures of more than one substance presenting apparent homogeneity, or else are compounds of an indefinite character, *i.e.*, in which the constituents are combined in proportions which do not come under the usual chemical laws of invariableness of composition and of combination in multiple proportions; in short, these iron compounds are substances belonging to the same category as alloys generally and solutions, the placing of which inside or outside the class of true chemical compounds depends on the particular definition of a chemical compound adopted. Probably the most accurate view of the constitution of such substances is that which regards them as being "solidified solutions" of one substance in another (Mathiessen), *i.e.*, when the bodies in question have been fused: the most useful commercial forms of iron are of this class. Thus, for example, iron sulphide and metallic iron fused together in such proportions that the latter greatly predominates form a homogeneous mixture (or solution of iron sulphide in molten iron), which on cooling solidifies as a whole, not exhibiting any tendency to separation of the iron and iron sulphide; a product similar but melting more readily is formed if iron sulphide and sulphur be fused together, forming one of the varieties of the so-called "Spence's metal" recently patented; so that between the extremes of pure iron on the one hand and pure sulphur on the other an apparently homogeneous mass can be obtained containing iron or sulphur in any assignable proportions, the compound being a solidified solution of iron sulphide in either iron or sulphur, according as the former or the latter is in excess. Silicon and phosphorus can be similarly incorporated with excess of iron, forming analogous solidified solutions; the same remark is true for nitrogen and other non-metallic elements, as well as for manganese and many other metals, notably nickel, gold, tin, platinum, rhodium, aluminium, zinc, titanium, tungsten, and chromium. With arsenic and tin definite compounds can be produced expressible by simple formulae, *e.g.*, FeAs (Gehlen) and FeSn (Deville and Caron). When carbon is thus incorporated with iron a peculiar phenomenon is (under certain circumstances) observable which has no parallel with the other compounds, except perhaps to some extent in the case of silicon; this is that, whereas the carbon is in the amorphous condition when first dissolved, yet on long-continued maintenance in the molten state, but more especially on cooling (whilst the substance is still liquid or semisolid), a more or less complete separation of carbon in the crystallized graphitoid state<sup>1</sup> often ensues; so that the cooled mass is no longer visibly homogeneous, but consists of granules and crystals, partly of graphite and partly of solidified solution of amorphous carbon (and such other elements as were originally present) in iron. This phenomenon may be compared with a somewhat analogous change undergone by phosphorus: when this element is dissolved in carbon disulphide or certain organic bodies, *e.g.*, ethyl iodide, the phosphorus gradually changes more or less completely into the red variety, which, being insoluble in the menstruum, precipitates in flakes. The amount of carbon which changes during solidification from the amorphous into the graphitoid variety depends largely on the nature and amount of the substances present along with it dissolved in the iron, and also on the absolute amount of

carbon present and on the rate of cooling; it appears to be promoted by the presence of silicon, the greyest irons (*ceteris paribus*) being usually the richest in silicon. On remelting graphitoid cast iron, the graphite is again dissolved, so that by rapidly chilling the fused mass "white" iron results. Under certain conditions silicon appears to extrude from highly silicious irons in cooling, but not in a difficultly oxidizable form, so that the outside of the pigs becomes covered with silica of a peculiar physical aspect (Lowthian Bell, *Journal Iron and Steel Institute*, 1871, i. 44); under other conditions several parts per cent. of silicon can be permanently retained by the pig without extrusion on cooling, forming a peculiar metal known as "glazy iron," bearing to the silicious pig from which silicon does separate much the same relations as highly carbonized white iron bears to grey pig.

When foreign substances are present in but small quantity (manganese excepted), and the amount of total carbon does not exceed 1.5 to 2.0 per cent. of the iron, little or no separation of graphitoid carbon takes place, and the resultant product is tolerably homogeneous, and possesses the properties of steel more or less soft in proportion as the carbon percentage is minute or otherwise.

When the carbon amounts to some 2.5 or upwards per cent. of the iron, and especially when the fused substance is rapidly cooled, the metal often solidifies as an almost homogeneous mass, possessing somewhat different properties from those of good steel; it is then known as *white cast iron* (from its colour after fracture); under other conditions, especially when a longer time is allowed for solidification, a more or less complete separation of graphite and consequent production of a coarse-grained crystalline structure results, the product being then termed *grey cast iron*, which consequently stands to white cast iron in much the same relation as devitrified glass (Réaumur's porcelain) to ordinary glass. When the amount of manganese present is relatively large (constituting several parts per cent. of the iron present), this separation of graphitoid carbon takes place to but a small or even inappreciable extent; the cooled mass is homogeneous and highly crystalline, the fractured surface exhibiting great brilliancy, whence the term *spiegelisen* applied to such substances. As a rule cast irons, whether white or grey, contain more than traces of impurities, such as sulphur, phosphorus, and silicon; but otherwise no absolute line of demarcation between malleable iron and steel on the one hand, and between steel and white iron on the other, can be drawn, based on the chemical composition; so that it cannot be said that a substance containing so much carbon is malleable iron, and so much more carbon steel, and so much more still cast iron; the definition is purely arbitrary; moreover, the physical qualities of a steel containing a given amount of carbon often differ much, according as the proportion of other substances present varies.

The ordinary practical test applied to distinguish iron from steel is the ascertaining whether the substance hardens on heating and quenching in cold water, becoming again softened on reheating and cooling slowly: *a substance which does this may fairly be regarded as steel* (possibly of very bad quality, but still steel), *whilst one which does not may be fairly regarded as a soft iron*. With certain specimens it is difficult thus to classify the substances under either head satisfactorily, whilst such a classification would not be accepted by many who would define a steel as being either the product of the cementation of malleable iron or as a substance that has been fused during manufacture, and who consequently would not admit that a very hard puddled metal was steel, even though it did harden distinctly on heating and quenching in cold water.

— Although it is impossible to draw a sharp line distin-

<sup>1</sup> Snelus has shown (*Journal Iron and Steel Institute*, 1871, i. 28) that it is practicable to remove mechanically from a highly crystalline pig iron graphitoid scales, which consist so entirely of carbon as to leave little or no appreciable residue on combustion.



guishing between malleable iron when hard and steel when soft, there is no difficulty in tabulating the essential differences between good malleable iron, well-marked steel, and cast iron. Thus the following table may be drawn up:—

Chemical Composition.	Malleable Iron.	Steel.	Cast Iron.
Carbon .....	traces to 0.3 or 0.4	0.4 to 1.8	2.0 and upwards
Silicon .....	0 to 0.2	0 to 0.4	0.1 to 3.0
Sulphur .....	0 to 0.1	0 to 0.1	traces to .5
Oxygen .....	?	?	?
Phosphorus .....	0 to 0.5	0 to 0.3	traces to 2.0
Manganese .....	traces	0 to 0.2 in cementation steel; 0.2 to 2.0 and upwards in Bessemer's metal, &c.	traces to 2.0
Iron .....	99.0 to 99.5	97.0 to 99.5	99.0 to 97.0
Essential composition .....	Almost pure iron, containing very little if any impurity other than carbon, this not exceeding a few tenths per cent. Sometimes contains perceptible amounts of imperfectly removed slag, varying from 0.1 to 3.0 per cent.	More or less pure iron, containing from 0.4 to 1.8 per cent. of carbon, and as a rule not more than traces of other substances (manganese excepted, and in certain special qualities phosphorus and silicon), manganese being present only in minute quantity in cementation steel, in larger amounts in the products of Bessemer's process and certain other methods.	Usually considerably impure iron, containing upwards of 2.0 per cent. of carbon, and varying but usually notable amounts of sulphur, silicon, phosphorus, &c.
Physical characteristics .....	Welds readily; is comparatively soft and very difficultly fusible; will not harden; of fibrous texture; when well made very tough and tenacious. The limit at which the capability of hardening is first noticeable as regards carbon percentage is near to 0.35 per cent.	Can be welded with more or less difficulty, according to the amount of carbon present; less fusible than malleable iron, the melting point being lower the more carbon is present; can be hardened and annealed and will bear a cutting edge; is very tough and elastic when of good quality, much more so than malleable iron. Texture granular, fine granular, or slightly fibrous, according to quality and mode of preparation.	Will not weld; is comparatively readily fusible and easily cast; will not harden like steel; far more brittle than tempered steel or malleable iron, but still possessed of considerable strength, especially as regards crushing strain; crystalline or granular texture.

The following tables express the results of Karsten, Eggertz, and Siemens as regards the limiting amounts of carbon present in soft iron, steel, and cast iron respectively:—

Karsten.

Carbon percentage.	Character of Metal.	Physical properties.
0.25	Malleable iron.	Not capable of being perceptibly hardened by sudden cooling.
0.35	Steely iron.	Just capable of being slightly hardened.
0.50	Steel.	Will harden, and give sparks with a flint when hardened.
0 to 1.5	Do.	Best position for tenacity and hardness.
1.75	Do.	Limit of power of welding properly.
1.8	Do.	Very hard cast steel; cannot be forged easily.
1.9	Do.	Not malleable at all when hot.
2.0 and upwards.	cast iron.	Brittle; will not bear hammering.
5.0 to 6.0	Do.	Highest percentage of carbon obtainable in white irons and spiegeleisens, &c.

Eggertz.

Carbon percentage.	Nature of Metal.
0.08	Softest Swedish Bessemer iron.
0.75	Soft steel.
1.4 to 1.5	Best kinds of cast steel.
0.99 to 2.44	Forge steel.
0.5 to 1.9	Cement steel.
0.86 to 1.94	Cast steel.
1.80	Hardest cast steel that can be welded.
0.88 to 1.52	Malleable cast iron.
3.30	Diaw plate steel.

Siemens.

Carbon percentage.	Character of Metal.
Up to 0.3	When cast is homogeneous melted iron rather than true steel, being no longer capable of being hardened.
Above 1.4	No longer capable of taking a temper, and consequently rather approaching to cast iron in character than to steel.

Åkermann classifies commercial iron and steel as follows:—

Not Malleable.  
Cast or pig iron.  
Malleable.

Malleable cast iron, made by decarbonizing pig iron by cementation with oxide of iron.

Cementation steel (bilster steel), made by carbonizing piled bloom or ingot iron by cementation with carbon.

Ingot metal (Göt metal).	Made thoroughly fluid by heat, or molten.	Ingot iron.	Designated as "Bessemer," "Martin," "crucible," &c., according as it is made. Martin and crucible steel can also be made from malleable cast iron, bilster steel, ingot, bloom, or piled iron or steel, or a mixture with or without pig iron.
		Ingot steel.	
Bloom metal (Snäzt metal).	Made in open hearths from iron ore or pig iron.	Bloom iron.	Called by the extra name of "Catalan," "Lancashire," "Franche Comté," &c., according to the description of hearth in which it is made.
		Bloom steel.	
Piled metal (Garf metal).	Made by the welding together of unmelted particles.	Piled iron.	Can be made by welding the spongy iron reduced from iron ore, or, as is more often the case, by puddling pig iron, when it has the extra name of "puddled iron" or "puddled steel."
		Piled steel.	

The following recommendations as to the nomenclature of iron and steel were made by an international committee appointed at Philadelphia in the year 1876 by the American Institute of Mining Engineers, consisting of I. L. Bell, Dr H. Wedding, Professors Tünner and Åkermann, L. Grüner, A. L. Holley, and T. Egleston:—

1. That all malleable compounds of iron, with its ordinary ingredients, which are aggregated from pasty masses or from piles or from any form of iron not in a fluid state, and which will not sensibly harden and temper, and which generally resemble what is called wrought iron, shall be called *weld iron* (German, *Schweißisen*; French, *fer soudé*).
2. That such compounds, when they will from any cause harden and temper, and which resemble what is now called "puddled steel," shall be called *weld steel* (German, *Schweißstahl*; French, *acier soudé*).
3. That all compounds of iron, with its ordinary ingredients, which have been cast from a fluid state into malleable masses, and which will not sensibly harden by being quenched with water while at a red heat, shall be called *ingot iron* (German, *Flusseisen*; French, *fer fondu*).
4. That all such compounds, when they shall from any cause so harden, shall be called *ingot steel* (German, *Flusstahl*; French, *acier fondu*).

Siemens (Lecture to Chemical Society, *Journal Chem. Soc.*, 1868, p. 284) lays down the aphorism that "no method of producing steel can be considered admissible at the present day which does not pass the metal through the condition of entire liquefaction, for it is only by fusion that foreign admixtures can be thoroughly separated, and that flaws and fissures can be avoided;" which appears to imply that no substance that has not been completely fused should be termed a true steel even though it be susceptible of hardening. Nine years later (*Presidential Address to the Iron and Steel Institute*, 1877), in discussing the above proposed definitions of the international committee, he remarks that practical difficulties would be introduced by these definitions; for instance, railway bars, which ordinarily contain from 0.2 to 0.6 per cent. of carbon, would sometimes be stamped as ingot iron and sometimes as ingot steel; and he further objects that, unless the precise temperature to which the metal is to be heated in order to harden it is specified, and also the cooling medium into which it is plunged, discrepancies will be introduced between the results of tests of the same metal by different experimenters, certain conditions of temperature and cooling material enabling particular classes of metal to take a slight temper, the which substances would not be hardened by the use of lower temperatures or different cooling materials, e.g., oil in lieu of water or mercury.

In view of the difficulty experienced in defining precisely what is meant at the present day by the terms iron and steel, and the practical inconveniences and litigation thereby brought about, it has been proposed by Sir Joseph Whitworth and others to disuse the terms "iron" and "steel" as distinctive marks of quality, and instead to define the metal in terms of its tensile strength and ductility (percentage elongation before rupture). The following table illustrates such a "scale" of qualities, being one employed at Villing<sup>1</sup> for "steels" prepared by insion processes:—

<sup>1</sup> Recently a slightly different classification of the Sraing steels (Société John Cockerill) has been adopted (*Annales Industriels*, August, 1879), viz:—

Class.	Character.	Content of Carbon per cent.	Tensile strength in tons.	Extension in 8 inches per cent.	Welding and Tempering Properties.
1	Extra mild.	0.05 to 0.20	25 to 32	20 to 27	Welds, but does not temper.
2	Mild .....	0.20 ,, 0.35	32 ,, 38	15 ,, 20	Welds, but hard, but may be very slightly tempered.
3	Hard .....	0.35 ,, 0.50	38 ,, 46	15 ,, 20	Does not weld, but will temper.
4	Extra hard	0.50 ,, 0.65	45 ,, 51	5 ,, 10	Unweldable, but may be strongly tempered.

Name.	Tensile strength in kilos per sq. millim.	Elongation per cent.	Approximate percentage of carbon.	General Characters.
c. Extra soft.	43 to 56	29 to 25	0.25 to 0.15	Welds, but does not harden; used for boiler plates, rivets, &c.
d. Soft.....	56 .. 69	10 ,, 20	0.35 ,, 0.45	Welds but hardens slightly, and not to any great extent; used for tires, axles, rails, pistons, &c.
e. Semi-hard.			0.45 ,, 0.55	Hardens well, but does not weld readily; used for springs, cutting tools, saws, drills, &c.
f. Hard.....	69 .. 105	5 ,, 10	0.55 ,, 0.65	Hardens, but does not weld; used for machine springs and tools, spindles, &c.
g. Extra hard			above 0.65	

A tensile strength of 1 kilogramme per square millimetre is about equal to 0.63 tons per square inch, so that on this scale extra soft, soft and semihard, and hard steels have average tensile strengths of about 32, 39, and 55 tons per square inch respectively. Steels of the (a) class can be bent U shape without breaking, and will generally allow the two ends of the U to be hammered together without fracture; steels of the (c) class break when the angle of bend reaches to 130°-140°; and the other classes are intermediate between these limits.

Hackney has proposed a classification of iron and steel practically identical with this "Serling scale"; the main objections to such scales are that, as even the softest completely fused metals are thus designated "steel," the time-honoured definition of steel as being a substance that can be hardened and tempered is wholly done away with; and the circumstance that the numerical values expressing the ductility and tensile strength are variable with the dimensions of the piece of metal tested (§ 43). Much confusion and litigation would be avoided were some name other than "steel" applied to the modern metals of low carbon percentage obtained by fusion processes, and destitute of the power of taking any considerable amount of temper by heating red hot and rapidly cooling.

In practically testing a sample of steel, the difference between a specimen that has been prepared by a fusion process and by a process of puddling is usually very manifest when the specimens are slightly etched by dilute nitric acid or other agent that will gradually attack the metal: the fusion product exhibits a regular more or less granular structure, whilst the other exhibits more or less of a fibroid character. On dissolving the metal in cupric chloride (§ 6), a small amount of silicious cinder is left undissolved in the latter case, but practically none with a properly fused steel.

The presence of sulphur and phosphorus in true steels in other than the most minute proportions exercises a marked deteriorating effect upon the strength and tenacity of the metal, the former substance rendering the steel more or less brittle when hot (red-short or hot-short), the latter causing it to be liable to crack and break when cold (cold-short). The presence of manganese, however, and to some extent of carbon and silicon, modifies the exact amount of effect produced by a given quantity of phosphorus or sulphur; as a general rule it may be said that a steel containing 0.5 per cent. of carbon and upwards, and also containing more than 0.1 per cent. of sulphur, will be objectionably red-short, and that, if it contain more than 0.1 per cent. of phosphorus, it will be too cold-short for most applications; whilst a much smaller quantity, as little as 0.03 per cent., renders the steel almost useless for tools and cutting instruments, &c., in which a fine temper is essential. These figures, however, are subject to notable corrections: the presence of manganese to an extent of several times the amount of sulphur present considerably mitigates the evil effect of that substance, whilst, provided the carbon be very low (*i.e.*, that the metal is really not steel at all but only fused iron), much larger quantities of phosphorus than 0.1 per cent. may be present without deteriorating the properties of the substance to so great an extent as would be occasioned by the presence of much smaller quantities of phosphorus simultaneously with

several tenths per cent. of carbon. Thus years ago the practical experience acquired at the Terre Noire works proved that good rails could be made from steel containing about 1 per cent. of manganese and as much as 0.3 per cent. of phosphorus, provided the carbon did not exceed half that amount; subsequently, good serviceable rails have been rolled not only in England but also in Saxony, Austria, America, and elsewhere, containing 0.3 to nearly 0.4 per cent. of phosphorus and about half as much of carbon, or less. These "phosphoric steels" (more correctly "homogeneous irons," fused irons, or "ingot irons"), however, are wholly unsuitable for all purposes requiring the metal to be tempered, on account of the impossibility of having so much phosphorus present together with more than minute amounts of carbon without producing brittleness and utter inability to be worked.

The effect of silicon on the physical qualities of steel is far less marked than that of sulphur and phosphorus. Like that of the latter it is modified by the amount of carbon present: thus Riley has found 2 per cent. of silicon in rails of good quality; Gautier states that a siliceous steel containing upwards of 7 per cent. of silicon, but almost destitute of carbon, could be forged perfectly, whilst a steel containing 1.5 per cent. of silicon and slightly less than 0.2 per cent. of carbon (with 0.76 of manganese) rolled perfectly and was very strong. The presence of silicon, moreover, conjointly with that of manganese, exerts a remarkable action in diminishing the extrusion of gases from molten steel in the act of solidifying, thereby producing honeycombing; so that when very soft steels are cast into ingots much sounder masses are obtained by the ordinary casting processes (*i.e.*, not under hydraulic or other powerful pressure) when a little siliceous metal is added to the steel just before casting than when ordinary rich spiegelisen or ferro-manganese is employed. On the other hand, when carbon and silicon are simultaneously present to the extent of 0.5 to 1.0 per cent. or thereabouts, both hot and cold shortness are brought about to a greater or lesser extent.

Nitrogen has been supposed by many chemists and especially by Fremy to be an essential constituent of steel; and in favour of this view it is to be noticed that in the preparation of steel by cementation the addition of nitrogenous organic matter (scraps of leather, horn, ferrocyanide of potassium, &c.) is found to facilitate the conversion of bar iron into blister steel. On the other hand this may be due simply to the formation and absorption of cyanogen, which carbonizes the iron without necessarily communicating nitrogen to it. The actual quantity of nitrogen found in steel by various experimenters is always extremely small,<sup>1</sup> whilst it is possible to produce steel from iron free from nitrogen by cementation in pure carbon oxide, or in an atmosphere of coal gas (Macintosh's patent),—so that nitrogen is clearly not an essential constituent in these cases. Moreover, nitrogen has been found both in wrought and in cast iron in even larger quantity than in steel, so that the peculiar properties of steel as regards hardening

<sup>1</sup> From 0.011 to 0.15 per cent. of nitrogen was found by Bouis in various specimens of malleable iron, cast iron, and steel; from 0.007 to 0.057 per cent. in various steels and wrought irons was found by Bonssingault. By heating metallic iron in ammonia gas much more highly nitrogenized substances can be produced, Fremy having thus obtained substances containing as much as 9.8 per cent. of nitrogen. In these and other analogous experiments by others, various methods of analysis were adopted, the most conclusive ones being solution of the metal in pure hydrochloric acid, and determination of the ammonia freed by the combination of the nascent hydrogen with the nitrogen: Recently A. H. Allen has repeated these experiments, and also made others by passing steam over the red-hot metal, and determining the ammonia produced. The quantity of nitrogen thus obtainable varied from 0.0041 per cent. in spiegelisen to 0.0172 per cent. in steel made from Dancowara iron.



and tempering cannot be markedly influenced by the presence of this constituent. No connexion between the amount of nitrogen present and the physical properties of the metal, or the amount of carbon or other foreign elements present therein, has as yet been thus established by any experimenter.

As regards the presence of oxygen in iron and steel, and its effect on their qualities, little evidence as yet exists. It is well known that certain metals, *e.g.*, copper, will dissolve small proportions of oxide, the presence of which renders the metal much less tenacious than it otherwise would be, so that certain operations are usually gone through in the final stages of the extraction of these metals for the purpose of again reducing the oxide disseminated through the mass, *e.g.*, "poling" melted copper. The tenacity exhibited by "phosphor-bronze" is largely due to the complete reduction of copper and tin oxides by the phosphorus. This solution of oxide in the metal also takes place with iron, especially when tolerably free from silicon; this element is capable of reducing iron oxide when heated therewith, so that when present the silicon is oxidized in preference to the iron.

Overblown Bessemer metal is comparatively unforgeable and brittle, so that probably the presence of oxygen affects iron in the same way as sulphur. When iron and steel are overheated for a long time, they become "burnt" and brittle; this is supposed by some to be due to the formation of oxide disseminated through the mass of the metal, but many others consider that a more or less crystalline structure set up under the influence of a softening heat is the sole cause of the diminution in strength and tenacity (§ 43).

Iron and steel usually give off, on heating under diminished pressure, carbon oxide and more or less hydrogen, and the former gas is largely extruded from steel in the act of solidifying (Bessemer), thereby giving rise to honeycombing of the casting. This is usually attributed to the same cause as the "spitting" of silver, *i.e.*, to a physical inability on the part of the metal to retain in solution at a lower temperature the same amount of gas that it can dissolve when more highly heated; the presence of silicon diminishes this evolution of gas, probably by the decomposition of the carbon oxide with formation of non-gaseous silica. A number of observations and determinations of the gases occluded by and otherwise present in iron and steel have been made by Parry, Troost and Hautefeuille, Muller, and others, but without leading to any definite correlations between the physical properties of the metals and the gases occluded. Moreover, it does not seem to be absolutely established whether the carbon oxide obtained by heating in an exhausted tube really exists as dissolved gas or as a mixture of oxide and carbide (or solution of carbon); the writer has found that by varying the mode of heating and the temperature variable proportions of carbon oxide and di-oxide may be obtained from spongy iron (prepared by heating to a bright red heat ferric oxide in an atmosphere of carbon oxide) when it is heated in connexion with a Sprengel pump; which seems to suggest that a mixture of oxide and carbide is present rather than simply occluded gases.

Hydrogen when present in iron to a considerable extent appears very considerably to diminish the tenacity and strength; thus electro-deposited iron containing much hydrogen is brittle, but becomes soft and flexible on heating under diminished pressure so as to extract the hydrogen. When iron or steel wires are immersed in dilute sulphuric acid, especially in contact with zinc, so as to evolve hydrogen copiously from the surface of the iron, the wires take up about twenty times their volume of hydrogen, and become so brittle that they break on attempting to bend them.

Copper is often present in minute quantity in pig iron. When steel contains a few tenths per cent. of copper it is distinctly red-short, more so when the proportion is increased

(Eggertz). Malleable iron does not seem to be so much affected by copper, 0.5 per cent. giving but little red-shortness; the welding power is, however, considerably diminished. On the other hand, addition of iron to bronze and similar copper alloys increases their strength and tenacity, as in Aich's gun-metal and Gedge's metal. Antimony acts as injuriously upon iron as sulphur and phosphorus conjointly, a few tenths per cent. rendering

bar iron highly cold-short and also hot-short. Chromium, tungsten, vanadium, and titanium are all apparently capable of increasing the strength of iron more or less after the fashion of carbon, and accordingly have been regarded as valuable constituents in special kinds of iron and steel, *e.g.*, the so-called chromium steel and tungsten steel, and the iron containing traces of vanadium employed on the Swiss wire bridges at Freiburg. Faraday and Stodart found that about 1 per cent. of platinum or certain of its congeners (*e.g.*, palladium and rhodium) improved the toughness of steel, and communicated to it a fine grain. Nickel is largely present in meteoric iron (*vide infra*), from which knife blades, &c., are readily beaten out, so that the presence of nickel does not appear to diminish materially the malleability of iron.

The question as to whether the carbon which does not separate in the graphitoidal state on cooling molten cast iron or steel is truly combined or not (in the sense in which oxygen is combined in ferric oxide, and not in the sense in which silicate of cobalt may be said to be combined in blue glass to which it gives the colour, or in which sugar is combined with water in syrup) is one about which great divergence of opinion exists. It is usual to speak of this carbon as "combined carbon," because when the iron or steel is dissolved in an acid (*e.g.*, hydrochloric acid), this carbon combines with the evolved hydrogen and escapes as carburized hydrogen of some kind, whereas the graphitoidal carbon remains behind unaffected; just in the same way the sulphur escapes as sulphuretted hydrogen. It is by no means apparent, however, that carbon if set free in the amorphous condition in a state of excessively fine division and in presence of nascent hydrogen would not forthwith combine with the hydrogen, even though its condition in the iron were only that of a dissolved body; the probability is indeed rather the other way, for such carbon when free and warm is known to be often pyrophoric in the air, whilst the mixture of carbon and partially reduced iron and iron oxide, formed when carbon oxide is allowed to act on ferric oxide for some time at a low red heat, evolves hydrogen containing much carburized hydrogen on treatment with an acid, *e.g.*, hydrochloric acid. It is to be remembered also that, whilst definite sulphides of iron are known and are easily obtainable, the same can hardly be said of carbides of iron; it is true that spiegeleisen (manganese-iron alloy) contains a larger amount of so-called combined carbon than ordinary steel, amounts up to 6 per cent. having been found therein; but it hardly follows from this that spiegeleisen and steel, &c., contain a definite carbide, such as  $Fe_3C$ , or  $Fe_2C$ , which has sometimes been considered as present therein, *e.g.*, by Karsten, Gurlt, Mattieu Williams, and others. A compound the constituents of which separate on cooling would be a very unusual sort of substance, whereas it is well established that by fusing and very rapidly chilling certain kinds of grey cast iron they are more or less converted into white or mottled iron, the amount of "combined" carbon largely increasing, and that of graphite correspondingly decreasing; whilst the converse change can be brought about in some kinds of white iron by fusing and very slowly cooling them, a notable separation of graphite and diminution in the quantity of "combined" carbon present being thus brought about. According to Åkermann fusion is not indispensable, long continued maintenance at a yellow heat sufficing to change white iron into grey.

In practice the quality of pig iron is to a considerable extent decided by the degree of crystallinity exhibited by it, *i.e.*, by the extent to which graphite has separated out during solidification, and the size of the crystals of this substance and of the solidified partly decarbonized pig iron, the crystallization of which is promoted by the particles of graphite acting as nuclei. Pigs with the largest crystals are known as No. 1; those made up of somewhat smaller but still moderately large crystals, as No. 2; smaller-grained pigs, but still crystalline and grey, are known as Nos. 3 and 4. The finest-grained No. 4 pigs, being usually unsuitable for making castings, and only serviceable for the puddling forge, are designated "forge 4," the higher kinds being known generically as "foundry iron." Sometimes a pig will solidify partly as white iron partly as grey, the crystallization having commenced in patches, but not having spread throughout the whole mass before it solidified; such iron is known as "mottled pig." The price of market pig iron is regulated by these numbers and the locality of the furnace, *i.e.*, the nature of the ore from which it is smelted; those brands which are specially free from phosphorus, and are consequently applicable to the preparation of "Bessemer metal" (steel made by the Bessemer-Mushet process—§ 36), are usually designated "Bessemer pig." Special qualities of white iron free from sulphur and phosphorus and containing several parts per cent. of manganese smelted from sphatose and other highly manganeseiferous ores are known as *spiegeleisen*, from their mirror-like fracture. *Ferro-manganese* is a similar product containing a much larger amount of manganese (§ 41).

II. NATURAL SOURCES OF IRON.

4. *Meteoric Iron.*—Metallic iron in a more or less pure condition is occasionally met with in nature, but the supply of metal from this source is wholly inconsiderable. Probably nearly all such substances are of meteoric origin, with the exception of ferruginous metallic platinum. Certain masses of oxidized iron with unoxidized metal in the interior have been found in Saxony and elsewhere; but great doubt exists as to whether these substances are not artificially prepared metal which has rusted exteriorly in the course of time. Near Nery (France), at a spot where a seam of coal had been burning for some time, Mosnier found a mass of a very hard steely iron weighing upwards of 16 lb, together with smaller lumps, evidently formed by the reducing action of the burning coal on ferruginous matter in the soil and rock. True meteoric iron usually if not invariably contains nickel to the extent of from 1 or 2 parts per 100 of iron (as in meteorites analysed by Prout) up to considerably larger amounts. The following analyses of various specimens of meteoric iron consisting wholly or almost entirely of unoxidized substances may be taken as representing the general composition of the substance:—

Source.....	Zacatecas, Mexico.	Lenarto.	Krasnojarsk, Siberia (Pallas Meteorite).	Bohumlitz, Bohemia.	Cosby's Creek, Tennessee.	Cape of Good Hope.
Analyst.....	H. Müller.	Wohler.	Berzelius.	Berzelius.	Bergemann.	Uricæhea.
Specific gravity.....	...	...	7.75 to 7.84	7.14 to 7.71	7.26	6.63 to 7.94
Iron.....	90.81	90.883	88.27	95.25	91.89	81.20
Nickel.....	5.65	8.450	10.82	4.15	6.70	15.09
Cobalt.....	0.42	0.665	0.46	0.21	0.33	2.56
Manganese.....	...	...	0.13	...	...	...
Copper.....	trace	0.002	0.07	0.04	...	...
Magnesium.....	trace	...	0.10	...	...	...
Phosphorus.....	0.23	...	0.11	0.32	0.09	0.09
Carbon.....	...	...	0.04	...	0.18	...
Sulphur.....	0.07	...	trace	...	...	...
Tin.....	...	...	...	0.03	...	...
Silica, &c.....	3.22	...	...	...	...	0.95
	100.50	100.000	100.00	100.00	99.19	99.80

Many meteorites consist of nickeliferous iron intermixed with larger or smaller amounts of oxidized minerals, in particular olivine, augite, labradorite, and other silicates, together with chrome ironstone, magnetic pyrites, magnetic oxide of iron, and schreibersite (phosphide of nickel and iron), &c. On solution in acids many of these substances are left undissolved, especially schreibersite; in consequence meteorites of mainly metallic character often exhibit peculiar crystalline figures (something like the "noirée métallique" produced by pouring acids on tinplate) when etched by acids (Wiedemann's figures). Nordenskjöld has recently shown that many meteorites that have fallen at different times exhibit great uniformity in composition, so that it is highly probable that they all had a common extra-terrestrial origin. Graham found (*Proceedings of Royal Society*, xv. 502, 1867) that the Lenarto iron yielded on heating in vacuo 2.85 times its volume of gas, containing

Hydrogen .....	85.68 per cent.
Carbon oxide .....	4.46 " "
Nitrogen .....	9.86 " "

whilst ordinary malleable iron (horse-shoe nails) yielded a rather smaller amount of gas, of which carbon oxide and dioxide constituted the majority; from the fact that he was unable to impregnate ordinary metallic malleable iron with more than about its own volume of hydrogen, whilst this meteoric metal contained upwards of two and a half times its volume of that gas, Graham concluded that the meteorite was derived from a cosmical body possessing a dense atmosphere of hydrogen, such as spectrum analysis indicates as existing in various fixed stars, of which a Lyra may be taken as a type.

5. *Ores of Iron.*—Cutting instruments of a rough character have been fashioned by savage and semi-savage nations from meteoric iron; but the sources from which the metal is practically extracted are those ores in which the metallic properties of the element are masked by its combination with non-metallic substances. These ores are essentially divisible into three classes, viz., those respectively in which the iron exists as sulphide, as carbonate, and as oxide. The first class of ore is best exemplified by *pyrites* or iron disulphide, FeS<sub>2</sub>; comparatively little iron is directly pro-

duced from ores of this class, although the impure ferric oxide obtained from the residue left in the vitriol works after combustion of pyrites and extraction of copper from the residue, known as "purple ore" or "blue billy," is utilized as "fetting" in the puddling operation, and has sometimes been employed on the spot where it is produced as a source of finely divided metallic iron for the precipitation of the more valuable copper, the reduction being simply effected by heating together the iron oxide and small coal, or by passing over the heated oxide reducing gases prepared by the partial combustion of coal or other fuel, &c. It may be noticed in passing that the *ferrum reductum* of pharmacy, or spongy metallic iron, is produced in much the same way, purer materials being employed, ordinarily a pure ferric oxide or hydrated ferric oxide and hydrogen gas; and that several methods for the reduction of iron on a manufacturing scale from various ores based on the same principle have been attempted hitherto without much commercial success (§ 30). The ores in which iron exists as carbonate, FeCO<sub>3</sub>, are essentially of two kinds, viz., those in which the ferrous carbonate is crystalline and but little admixed with earthy matters, and those in which a larger or smaller amount of clayey matter is intimately intermixed with the ferruginous compound: the former class is generally termed *spathic iron ore* (sparry ore, siderite, spathose), and often contains a notable amount of magnesium or of manganese carbonate; the latter class is from its texture and appearance generally spoken of as *clay ironstone* or *argillaceous iron ore*. Large deposits of a variety of clay ironstone exist in the Coal Measures, frequently alternating with layers of carbonaceous matter, whence the term *blackband* is applied to this variety.

In many cases deposits of spathose and clay ironstone have become more or less altered by the action of air and moisture, the effect of which is to convert ferrous carbonate into ferric oxide; in other instances by the action of heat derived from the underlying strata by conduction, or due to trap dykes and analogous volcanic agency, the ferrous carbonate is more or less completely converted into an iron oxide akin to magnetic oxide,—so that the deposits of spathose ore or clay ironstone shade off in places into deposits of the iron oxide class.

The third class of iron ores in which the iron exists as oxide may be divided into three subclasses, viz., those in which the iron respectively exists as anhydrous ferric oxide, Fe<sub>2</sub>O<sub>3</sub>, as hydrated ferric oxide, Fe<sub>2</sub>O<sub>3</sub>.H<sub>2</sub>O, or other hydrate, and as ferrous and ferric oxides combined, of which magnetic oxide of iron Fe<sub>3</sub>O<sub>4</sub> is the type. To the first division belong the *red hæmatite* and *specular ores*, to the second *brown hæmatite* and *bog iron ore*, and to the third the *magnetic iron ore* properly so called, or *loadstone*, and various modifications of this found in different localities, and usually also designated as magnetic ore, although frequently not possessed of strongly marked magnetic properties, and also the *ironsands* of India, New Zealand, St Lawrence, and elsewhere. These latter are usually almost pure Fe<sub>3</sub>O<sub>4</sub>, intermixed with more or less silicious matter (often titaniferous), and are distinguished by their remarkable freedom from tendency to take up oxygen and pass into the state of ferric oxide, the which property is not by any means possessed to an equal extent by all so-called magnetic ores; just as deposits of ferrous carbonate by the action of heat, air, and moisture become changed, so beds of ore exhibiting in the main a composition akin to that of magnetic oxide of iron often contain portions which have become converted by similar agencies into ores more resembling red or brown hæmatite. Owing also to the variable intermixture of gangue of various kinds with the veins of iron ore, the physical properties of the substances become more or less altered, so that it is often difficult to



classify a particular ore otherwise than in broad general terms.

According to the nature and amount of the admixed substances, the value of the ore varies largely. The presence of certain impurities, notably of phosphorus, in more than minute quantity prevents the use of certain ores for particular purposes, and thus reduces their value; the admixture of particular kinds of gangue in other cases renders the ores unsuitable for working in the same kind of way that would otherwise be advantageous; in smelting such ores by means of a blast furnace different kinds and amounts of flux for the earthy impurities are requisite in different cases, thus affecting the cost of production, —so that in fine the value of an ore is by no means necessarily proportionate to the amount of actual iron present therein. The following table gives a rough idea of the general composition and characters of the leading classes of iron ores, such as are in actual use as sources of metal:—

	Oxide of Iron Class.			Ferrous Carbonate Class.	
	Hematite.	Brown Iron Ore.	Magnetic Oic.	Spathic Ore.	Clay Ironstone.
Ferrous oxide.....	60 to 95	50 to 90 usually absent or nearly so.	30 to 70	0 to 5	0 to 10
Manganese oxide.....	0 ,, 5		15 ,, 55	20 ,, 60	30 ,, 45
Magnesia.....	0 ,, 2	0 to 2	0 ,, 1	1 ,, 25	0 ,, 2
Alumina.....	0 ,, 1	0 ,, 2	0 ,, 2	0 ,, 10	1 ,, 10
Lime.....	0 ,, 5	1 ,, 10	0 ,, 10	0 ,, 5	1 ,, 10
Silica.....	0 ,, 3	0 ,, 5	0 ,, 5	0 ,, 25	1 ,, 10
Carbon dioxide.....	1 ,, 25	1 ,, 30	0 ,, 25	0 ,, 5	2 ,, 25
Phosphoric anhydride.....	0 ,, 2	0 ,, 5	0 ,, 5	35 ,, 40	20 ,, 35
Sulphur.....	0 ,, 3	0 ,, 3	0 ,, 2	usually absent, or only present in traces.	0 ,, 3
Water.....	0 ,, 1	0 ,, 1	0 ,, 2	ditto.	0 ,, 2
	0 ,, 5	5 ,, 20	0 ,, 5	0 to 5	0 ,, 4
Mata composition	Anhydrous ferric oxide, with a greater or less admixture of silicious or quartzose matter, and sometimes a little clay or other aluminous gangue.	Hydrated ferric oxide, with more or less admixed earthy and clayey matter.	Ferrous and ferrous oxides, more or less approaching to the ratio Fe <sub>2</sub> O <sub>3</sub> , FeO, and more or less admixed with clayey matter and gangue.	Crystalline ferrous carbonate, with more or less magnesia and manganese carbonate, and a little gangue.	Ferrous carbonate disseminated through a clayey mass, the former predominating in the richer ores of the kind usually worked.

Red hematite ores (including specular ore or fer oligiste and micaceous ore) vary considerably in their external appearance; the variety known as "kidney ore" is well exemplified by the Cumberland deposits, and constitutes dark brownish-red botryoidal and reniform concretions, occasionally with a considerable amount of smoothness and lustre externally, and of crystalline frequently radiating structure; softer varieties are known as "red ochre" and "puddlers' ore," owing to their use for "fetting" puddling furnaces and as pigments, and are of unctuous consistency almost earthy in character. "Specular ore" is a hard well-crystallized form, deriving its name from the brightness of the surface of its crystals, which appear dark grey or black by reflected light; this variety is well exemplified by the Elba ore; its specific gravity is near 5.0, the crystalline system being the hexagonal. "Titaniferous iron ore" or "ilmenite" resembles specular ore in appearance and crystalline form; it is more strictly a variety of magnetic ore, however, inasmuch as it usually contains a considerable amount of ferrous oxide; the ferrous titanate present may on the other hand be regarded as FeTiO<sub>3</sub>, or Fe<sub>2</sub>O<sub>3</sub>, in which half of the iron is replaced by titanium; whilst some of the ferrous iron is frequently replaced by magnesium. "Micaceous iron ore" is a crystalline scaly substance which, when of sufficient brilliancy, forms a good pigment for iron-work, known as "minium de fer." As a rule hematites are considerably free from phosphorus and sulphur; various hematitic deposits in Spain, however, have been found by the writer and others to contain large amounts of phosphorus, sometimes to the extent of several parts per cent. of that element in relation to the iron; whilst occasionally pyrites veins are found in hematite beds. The chief hematitic ores worked are those from Cumberland and North Lancashire (Ulverston, Furness, Whitehaven, &c.); from Sweden and Norway (Dalkarlsberg, Utö, &c.); from Liège, Saxony, the Harz, Silesia, and Austria; from Elba and Brazil (specular ore); and from Missouri (Iron Mountain, Pilot Knob), Lake Superior, Ohio, Ten-

nessee, and Alabama; many other deposits, however, exist, this class of ore being very widely spread; thus it is found in some quantity in Cornwall (Restormel), Brixham, Ayrshire, Glamorgan-shire, North Wales, the Isle of Man, the Erzgebirge, Russia, Spain, &c. Hematitic ores are usually found in the older geological formations, especially the Huronian, Cambrian, Silurian, Devonian, and Carboniferous rocks; in many cases they are distinctly of sedimentary character, i.e., they have obviously been deposited by aqueous agency. Some deposits have probably been originally thrown down either as ferric oxide detritus from the abrasion of rocks, &c., containing ferruginous matter, or as hydrated oxide from the oxidation of water containing ferrous carbonate in solution, the ochreous deposits thus formed having been rendered more or less completely anhydrous and indurated by the long-continued effect of pressure and the conduction of the internal heat of the earth to them. The Cumberland hematite largely occurs in pockets in Carboniferous Limestone, and has doubtless been produced by the latter kind of agency, the cavities of the limestone rock becoming gradually filled up by the deposition of iron oxide. Red sandstones, on the other hand, represent deposits of ferric oxide thrown down simultaneously with much sand; whilst the earthy varieties of hematite have probably been less indurated by heat and pressure, and were doubtless formed by deposition from water containing clayey matters in suspension to a greater or lesser extent. The Alabama deposits exhibit distinct stratification, forming a bed between the Coal Measures and the Devonian Limestone upwards of 100 feet in thickness, and several square miles in extent. In Cornwall, North Wales, and especially in the Lake Superior and Missouri districts, the hematitic deposits form large veins and lodes. The specular ores of Elba, Sweden, Missouri, and elsewhere usually occur as massive deposits; portions of the latter occasionally show the passage of spathose ore into specular ore (Snelus), suggesting the effect of heat accompanied by oxidizing action. Occasionally brown hematite is found passing into red, indicating gradual dehydration more complete in one portion of the deposit than in another. The following analyses illustrate the composition of some hematites:—

Character of Ore and Locality.....	Ulverstone Red Hematite.	African Mokra Ore.	Elba Specular Ore.	Lake Superior Red Specular Ore.	Pictou County, Nova Scotia.	Pilot Knob, Missouri.
	R. Smith.	Siemens.	Elberfeld Works.	Geological Survey Reports.	Thorpe.	A. Blain.
Ferrous oxide.....	90.94	79.74	87.84	90.92	56.06	81.34
Ferrous .....	...	6.43	...	...	9.20	0.15
Manganese oxide.....	0.25	2.92	0.07	trace	...	...
Alumina.....	trace	...	3.47	1.39	5.59	2.19
Lime.....	0.97	0.52	0.22	0.70	1.88	0.21
Magnesia.....	trace	0.25	0.34	0.42	1.05	0.14
Phosphoric anhydride.....	trace	...	0.02	0.26	absent	0.04
Sulphuric do.....	0.24	...	...	...	...	...
Silica.....	6.68	4.75	5.97	5.89	23.68	13.27
Water, carbonic acid, volatile matters, &c. )	0.78	5.11	1.90	0.77	2.54	...
Sulphur.....	...	...	0.17	0.05	absent	...
	99.58	99.72	100.00	100.00	100.00	100.33
Total metallic iron.....	63.66	60.8	61.61	62.92	43.40	59.15

Brown hematite (including gothite, limonite, bog iron ore, lake ore, &c.) varies even more in appearance and character than red hematite, and is found of the most varied degrees of purity. Many deposits have been apparently formed by the alteration of argillaceous ferrous carbonate; others form superficial sandy beds produced by the deposition of ochreous matters from solution either by purely chemical action, such as the oxidation of dissolved ferrous carbonate, or by the action of organized beings, especially *Diatomaceae*. As a rule much earthy matters are contained in this class of ores, together with considerable amounts of sulphur and phosphorus; certain deposits found in Spain and Africa (Billao and Marbella ores, &c.) are, however, often considerably free from these objectionable ingredients. Usually brown hematites are distinctly of sedimentary character, forming beds; but they often occur also as veins, especially in the older formations, doubtless deposited (often along with other minerals, e.g., copper ores) from water flowing through the cracks and crevices of the rocks. Sometimes the brown colour is much lightened, the tint being almost red and sometimes even yellow. In texture these ores usually differ considerably from the more compact kinds of red hematite, being earthy, or sandy in character, and only comparatively rarely massive, save when they have been subjected to indurating and compressing influences since their deposition, in which case they have usually lost water and become partially converted into something more like red hematite. Sometimes a definitely crystallized hydrate, Fe<sub>2</sub>O<sub>3</sub>.H<sub>2</sub>O (gothite), is found; scaly minerals of the same composition have also been described under the names of lepidocrocite, &c. The larger deposits of brown hematite are found in the Secondary and

more recent formations as a rule, but some considerable ones occur among the Coal Measures and Carboniferous Limestone; the Oolite, Lias, Jurassic, Greensand, and Wealden formations of England especially Northamptonshire and adjacent counties), and of France (Boulogne and the Ardèche), Luxemburg, Bavaria, and Würtemberg, contain deposits often of considerable magnitude and extent, which occasionally show distinct passage into red hematite, and often passage of clay ironstone into brown hematite. Bog and lake ores are considered by Ehrenberg to be mostly formed by infusorial agency; or the dredging up of deposits of this kind (occurring in nodules and granular concretions), a new formation of lumps is often found to occur after the lapse of some years. In some cases these deposits are of large magnitude, e.g., those of Finland, Sweden, Norway, and Three Rivers (Canada). Pisolitic concretionary masses of a variety of brown hematite are found sometimes in large quantity in the German Oolites, and elsewhere in the cavities and crevices of limestones; these have been probably formed by deposition from water percolating through the rock, and the aggregation together of the ferric oxide thus thrown down, and the earthy matters also in suspension. The following table gives the composition of various kinds of ores belonging to the brown hematite class:—

Character of Ore and Locality	Northamptonshire Deposits	Pyrenean Ores used for the Catalan Forge	Fisolitic Ore, Audincourt, France	Limoote, Kentucky	London-derry, Nova Scotia	Bog Iron Ore, Flaten, Sweden
Analyst	Sjöller	François	Jordan	Caldwell	Chapman	Svanberg
Ferric oxide	52.86	65.50	70.00	69.93	83.16	67.59
Manganese do.	0.51	3.00	trace	...	1.04	1.45
Alumina	7.39	1.30	6.00	3.12	0.42	4.13
Lime	7.46	5.00	0.50	1.33	0.13	0.47
Magnesia	0.68	0.45	...	1.62	0.15	0.23
Silica	13.16	11.40	10.05	13.45	4.12	7.81
Phosphoric anhydride	1.28	...	...	0.24	0.29	0.18
Sulphuric do.	...	...	...	...	0.02	...
Sulphur	0.03	...	...	...	...	...
Water	11.37	13.20	14.00	10.21	10.67	17.81
Carbonic anhydride	4.92	...	...	...	...	...
Total metallic iron	99.64	99.55	100.55	100.10	100.00	99.72
Total metallic iron	37.00	45.87	49.00	48.95	58.22	47.32

**Magnetic Iron Ores.**—The substances most nearly approaching to the composition Fe<sub>3</sub>O<sub>4</sub> sometimes occur well-crystallized in forms belonging to the cubic system, and possessing a semi-metallic lustre; in the mineral *franklinite* (found in large quantities in New Jersey) the ferrous oxide present is largely replaced by zinc and manganese oxides without altering the crystalline shape (usually octahedral). The purest magnetites are strongly magnetic, and often show polarity, then constituting *loadstone*; they differ from hematites in the colour of the streak, magnetic ore yielding a black, red hematite and specular iron a red, and brown hematite a brown streak; the specific gravity is about the same as that of compact red hematite, viz., near to 5.0, while brown hematites are usually considerably less dense, their specific gravity being near to 4.2. Massive deposits are found in the older formations in Sweden and Norway (crystalline limestones, talcose schists, and diorites), North America (Laurentian series), the Ural mountains (doleritic porphyry), and Mexico (Cerro Mercado—felspathic porphyry); whilst considerable amounts are also found in somewhat more recent formations, e.g., in Piedmont (Traversella—talcose schists and dolomites), Spain, northern India, and Saxony (Bergschühel); in England only comparatively small quantities are found, notably at Rosedale (Yorkshire) and Brent and Dartmoor (Devonshire). The mines of Dannemora (southern Sweden) and Gellivara (Swedish Lapland) are of great antiquity, the iron produced from the ore thence raised being of the finest quality (partly owing to the use of charcoal in smelting); the Indian mines have also been a source of wootz for some two thousand years at least, whilst the Traversella deposits have been worked from time immemorial. Notable amounts of magnetic ore also occur in various parts of France, Germany, Spain, Portugal, North Africa, Greece, Australia, and Brazil; whilst in New Zealand (Taranaki), as also in the Bay of Naples, and especially along the north-east coast of British America and Labrador, enormous quantities of "iron sand" occur along the beach, derived from the disintegration of rocks containing crystalline magnetic oxide of iron (usually more or less titaniferous); this variety of magnetic oxide is capable of resisting indefinitely the oxidizing effect of air and water, and from its hardness and density becomes mechanically separated from the felspathic and silicious particles of matrix simultaneously formed during the erosion of the rocks; owing to its great freedom from sulphur and phosphorus, it is practicable to obtain from it (by the aid of charcoal) the finest qualities of iron. It has been supposed by some that the presence of titanium in the ore communicates special qualities to the steel thence prepared; but evidence in proof of this is requisite, inasmuch as it seems that the titanium

present in the pig iron smelted from titaniferous ores, to the extent of some tenths per cent. or more, becomes eliminated during the transformation into malleable iron and steel just as silicon is similarly oxidized and removed. The following analyses illustrate the composition of various kinds of magnetic ore:—

Character of Ore and Locality	Rosedale, York-shire	Dannemora, Sweden	Magnetic Iron Sand, River, St Lawrence, Canada	Titaniferous Iron Ore, Cling Valley, Wyoming	New Jersey Magnetite	Lake Champlain Ore, Moriah, "No. 21" Bed
Analyst	Pattinson	Ward	Sterry Hunt	Carson	Berthelot	Chandler
Ferric oxide	32.67	27.55	32.60	45.03	63.18	35.99
Ferrous do.	33.85	58.93	...	17.96	26.52	...
Manganese oxide	0.69	0.10	0.40	1.53	0.12	0.10
Alumina	3.15	0.29	...	3.98	3.28	2.00
Lime	2.86	0.38	0.90	1.11	0.38	0.52
Magnesia	1.59	0.61	...	1.56	...	0.60
Silica	7.79	12.64	1.95	0.76	6.68	0.64
Phosphoric anhydride	1.41	trace	...	trace	0.064	0.10
Sulphuric do.	trace	...	...	...	...	...
Carbonic do.	10.96	0.12	...	...	...	...
Sulphur	0.03	0.04	...	1.44	0.012	0.10
Water	3.76	0.11	...	...	...	...
Titanic oxide	...	...	4.15	3.49	...	...
Chromium do.	...	...	...	2.45	...	...
Zinc do.	...	...	...	0.47	...	...
Total metallic iron	95.16	100.67	100.00	99.78	100.226	100.05
Total metallic iron	40.17	62.6	66.73	45.49	64.86	69.51

**Spathose Iron Ores.**—Ferrous carbonate, being isomorphous with magnesium, manganese, and calcium carbonates, frequently occurs crystallized either by itself as *siderite* or with large intermixture of one or the other of these salts; when manganese is present to any considerable extent, the ores are more especially suitable for the production of spiegeleisen and ferro-manganese, especially when they contain little or no phosphorus. In Great Britain the chief deposits are those of Weardale (Carboniferous Limestone), Alston Moor (Cumberland), Brendon hills (Somerset), and Exmoor (Devonshire); these frequently show passage of the mineral into brown hematite by oxidation through access of air and moisture. Large massive deposits are found in Germany (Stahlberg near Müsen, Westphalia), Styria (Eisenerz), Thuringia, and Carinthia, mostly in rocks of the Devonian period or thereabouts, and sometimes constituting almost entire mountains; also in the Basque provinces, the Pyrenees, South Spain, and Nova Scotia. These ores are as a rule extremely free from phosphorus and sulphur, whence they are largely employed for the manufacture of malleable iron, steel, and spiegeleisen of high qualities; they are of notably less density than compact hematite or magnetite, usually possessing a specific gravity of near 3.8. The following analyses represent the composition of certain kinds of spathose ore:—

Locality	Wear-dale	Brendon Hills, Somersetshire	Eisenerz, Styria	Müsen, West-phalia	Allevard, Isère, France	Pictou County, Nova Scotia
Analyst	Tookey	Spiller	Baldinger	Peters	Jordan	Thorpe
Ferric oxide	0.81	0.61	...	2.75	...	...
Ferrous do.	49.77	43.84	53.42	43.51	48.15	54.99
Manganese oxide	1.93	12.64	3.08	0.83	9.03	2.85
Alumina	...	0.01	...	1.63	...	...
Lime	3.96	0.23	...	1.75	2.50	1.53
Magnesia	2.83	3.63	5.00	2.29	0.37	0.55
Silica	3.12	0.07	0.06	1.62	4.85	2.70
Phosphoric anhydride	trace	...	...	0.54	0.11	...
Carbonic do.	37.20	38.86	38.10	39.92	40.49	33.60
Water	0.30	0.18	...	0.45	...	...
Zinc oxide	...	...	...	0.04	...	...
Sulphur	0.04	...	...	0.22	0.16	...
Calcium sulphate	...	...	...	...	...	3.48
Total metallic iron	99.96	100.32	99.66	100.55	99.73	99.76
Total metallic iron	38.95	34.67	41.51	42.59	37.45	42.76

**Clay Ironstone.**—When ferrous carbonate occurs largely mixed with clayey matter, the crystalline structure is usually non-apparent; frequently so much calcium carbonate is also present as to make the ore useless for smelting purposes except when intermixed with others, the calcareous matter then serving as flux; nodules of this poor or "lean" ironstone found in the London clay and elsewhere are, however, largely used in the manufacture of cements, and hence are often known as *cement stones*. The largest deposits of clay ironstone are found in the Coal Measures, and often exhibit distinct stratification, fossils being not unfrequently met with, especially in the nodular varieties; *blackband* ores (layers of ironstone and clay alternating with coaly matter) are largely found in Staffordshire, Wales, and Scotland, and to some extent in the Rhinish and West-



phalian coalfields and in Ohio. When carbonaceous matter is not present in any considerable quantity, clay ironstone forms a dark bluish-grey or greyish-yellow mass, sometimes forming layers of nodules, sometimes distinctly bedded deposits of large area, e.g., the Cleveland beds of North Yorkshire, the ores of Glamorganshire, Shropshire, Derbyshire, France, Westphalia, and various parts of the United States, notably Alabama, Tennessee, Kentucky, Ohio, and Pennsylvania. Curiously, although an ordinary concomitant of coalfields, clay ironstone is almost entirely absent from the Coal Measures of Durham and Northumberland. In many localities clay ironstone has become so changed by oxidizing and hydrating influences as to contain but little ferrous carbonate, the iron being converted into a hydrate, giving to the ore the character of a brown hematite; this is specially noticeable in the Northamptonshire deposits, most of which are usually classed as brown hematite, although containing some amount of carbonate, whilst occasionally ferrous carbonate is found in them having undergone but little alteration, and forming a clay ironstone closely resembling that of Cleveland. As a rule Coal-Measure ironstones are somewhat highly phosphorized; this is especially noticeable with the Cleveland ore, which usually yields on smelting a pig iron containing between 1 and 2 parts of phosphorus per 100 of iron. The following table illustrates the composition of some of the more important clay ironstone deposits:—

Character of Ore and Locality....	Average Scotch Blackband.	Dudley Ore, Staffordshire.	Cleveland Ore, North Yorkshire.	Dowlaith, South Wales.	Abercorn Blackband.	Blue Ore, Hanging Rock, Ohio.
Analyst.....	Colquhoun	Dick.	Pattinson.	Reley.	Hatchliffe.	Wormley.
Ferrous oxide.....	1.0	0.13	2.60	...	4.10	13.51
Ferrous oxide.....	40.0	46.30	38.66	44.29	43.37	42.48
Manganese oxide.....	...	3.14	0.74	1.13	1.50	0.13
Alumina.....	5.0	4.80	5.92	6.45	6.05	0.59
Lime.....	4.0	0.76	7.77	3.06	3.00	3.41
Magnesia.....	4.0	0.94	4.16	3.73	0.25	1.00
Silica.....	8.0	10.29	10.36	13.01	2.80	7.52
Phosphoric anhydride.....	...	0.74	1.07	0.42	trace	0.35
Carbonic do.....	32.0	30.44	22.90	32.48	30.86	30.76
Sulphur.....	0.5	0.67	0.14	...	1.83	0.15
Water.....	0.5	1.38	4.45	1.45	0.31	...
Organic matter.....	5.0	1.14	...	0.35	0.25	...
Potash and soda.....	...	...	trace	0.11	0.92	...
Total metallic iron.....	100.0	98.43	97.27	100.51	100.28	99.92
Total metallic iron.....	32.0	36.14	31.42	34.72	36.40	41.89

**Pyrites.**—As already stated, pyrites is never used directly by the smelter as a source of iron; but the residue left after burning pyrites to make vitriol and extracting copper from the residue by Henderson's process consists almost entirely of ferric oxide, and from its physical characters is valuable as settling for puddling furnaces; so that the iron contained in the pyrites ultimately becomes largely reduced to the metallic state, either in the puddling furnace itself, or subsequently from the tap cinder produced therein on its being smelted in combination with other ores. The cupreous pyrites of Spain and Portugal (Huelva and Tharsis ores), and certain other analogous substances from other countries, containing but little silicious matter or other ingredients besides iron, sulphur, and copper, are in consequence largely used by vitriol makers. The following table illustrates the average composition of Huelva and Tharsis ores before burning and subsequently, and also of the "purple ore" or "blue billy" left when the copper has been almost entirely extracted (together with quantities of silver and gold, relatively small, but absolutely sufficiently great to be a distinct source of profit) by conversion into chloride by heating in contact with air with sodium chloride and lixiviation of the product, the "purple ore" remaining undissolved:—

Analyst.....	Raw Ores.		After passing through the pyrites kilns.		Dry Purple Ore.	
	Clapham.	Alder Wright.	Alder Wright.	J. A. Phillips.	Snelus.	
Iron.....	41.92	44.28	...	...	...	...
Sulphur.....	47.50	49.07	3.0	0.36	0.32	...
Copper.....	4.21	2.75	3.0	0.20	0.30	...
Arsenic.....	0.31	0.33	...	...	...	...
Zinc.....	0.22	...	...	...	...	...
Lead.....	1.52	traces	...	0.75	0.75	...
Silica, quartz, and substances insoluble in acids.....	3.40	2.34	3.0	2.11	4.02	...
Ferrous oxide.....	...	...	90.0	96.00	94.51	...
Phosphorus.....	...	...	...	absent	absent	...
Lime, soda, &c.....	...	1.16	1.0	0.50	0.10	...
Total metallic iron.....	100.00	100.00	100.0	99.92	100.00	...

A valuable report on the character of various British iron ores is to be found in the *Journal of the Iron and Steel Institute*, 1871, whilst numerous analyses and descriptions of ores from almost all parts of the world are given in the volumes published during the last ten years or so.

**6. Analysis of Iron Ores and of Metallic Iron and Steel.**—The analysis of iron ores by the "dry method" (fusing with reducing agents, such as powdered charcoal, and suitable fluxes, and weighing the button of cast iron produced) has the advantage of giving in a comparatively short time a notion both of the amount of iron contained in the ore and of the presence or absence of phosphorus, manganese, &c. (judged of by the physical characters of the button), but has little to recommend it on the score of minute accuracy. The results are usually in excess of the iron actually present by  $\frac{1}{50}$  to  $\frac{1}{100}$ , on account of the button containing carbon, &c.; whilst it does not by any means necessarily follow that the reduction of a given ore on the small scale in a crucible and on the large scale in a furnace will produce a metal of the same characters in each case. Accordingly the "wet method" of analysis (solution in appropriate solvents and separation of the various constituents from one another or other treatment equivalent thereto) is ordinarily preferred.

The ore, after being finely pulverized and sifted, &c., and representing a fair average sample of the material operated on, is dissolved in hydrochloric acid (if this fails by itself to produce ready solution, the ore may be heated to a low red heat in hydrogen so as to reduce to the metallic state, and then dissolved in hydrochloric acid); the ferric salt present is then reduced to the ferrous state by nascent hydrogen (evolved by adding fragments of pure zinc or other reducing agents, such as sulphur dioxide), and the amount of iron contained in the fluid determined either by adding a standard solution of potassium permanganate to the diluted fluid until a pink tint just appears (Mauguerite), or by adding standard potassium dichromate solution until a drop of fluid just ceases to form a blue precipitate or greenish colour with potassium ferriyanide (Penny); the oxygen communicated by the test fluid being known from the volume of liquid consumed, the amount of iron peroxidized is known. When the ores contain iron in both the ferrous and ferric states, and the amount of each is required to be determined, the ore is boiled with hydrochloric acid, and the ferrous salt determined in one part of the solution, and the total iron in another portion. If the iron exist wholly or partially as carbonate, the amount of carbon dioxide may be determined by treating the finely pulverized ore with sulphuric acid in a suitably constructed apparatus, and weighing the apparatus after the (completely dried) gas has been wholly removed, or by absorbing the evolved gas in ammonia, boiling with calcium chloride, and weighing the precipitated calcium carbonate, a correction being made by means of a blank experiment for any ammonium carbonate originally present in the ammonia solution, or formed by absorption of carbonic acid from the air during the operation. **Manganese** is conveniently determined by dissolving the ore, peroxidizing if necessary, rendering nearly neutral, and boiling with sodium or ammonium acetate, whereby all iron and alumina present are thrown down as basic acetates, carrying with them all the phosphoric acid which is in solution; to this filtrate bromine is added (or it is saturated with chlorine), and the whole allowed to stand in not too cold a place for some hours, when the manganese is precipitated as a hydrated dioxide, or oxide approaching in composition thereto, which is collected, washed, ignited, and weighed as  $Mn_2O_3$ ; when more than a trace of manganese is present it may be determined volumetrically by several methods, e.g., Pattinson's, consisting of addition of ferric chloride if the iron present is not already present in larger quantity than the manganese, of bromine water or calcium hypochlorite, and finally of freshly precipitated calcium carbonate, the liquid being at a temperature of  $60^\circ - 70^\circ C.$ ; the precipitate thrown down contains all the manganese as  $MnO_2$  (Pattinson, *Chem. Soc. Journal*, 1879 [*Transactions*], p. 365), which may be estimated by dissolving with dilute sulphuric acid and a known amount of standard ferrous sulphate solution, and determining the iron which remains unoxidized by the  $MnO_2$ . Kessler (*Zeitsch. Anal. Chem.*, 1879, 18, part i.) employs an analogous method for manganese determination, adding zinc chloride and bromine, boiling for a long time to ensure that all the manganese is precipitated as  $MnO_2$ , and finally dissolving in solution of antimonious chloride in hydrochloric acid, and titrating the non-perchlorinated antimony by permanganate. Alder Wright and Menke (*Chem. Soc. Journal*, 1880 [*Transactions*], p. 22) find that Pattinson's process gives more satisfactory results if zinc is present as well as iron in the precipitation of the manganese as  $MnO_2$ , the formation of oxides of manganese lower than  $MnO_2$  and of permanganate (which may sometimes otherwise

occur and cause error) being thus avoided; whilst they also find that a modification of a method originally due to Guyard (precipitation of manganese as  $MnO_2$  by the addition of permanganate) will give good results provided that a zinc salt be added to ensure the formation of  $MnO_2$  only, and that the amount of free acid be not too great. When it is required to determine the *alumina* dissolved by the acid employed to act on the original ore, the phosphoric acid in the total precipitate thrown down by the acetate treatment for the estimation of manganese gravimetrically may be determined; subtracting this and the  $Fe_2O_3$  from the weight of the precipitate, the  $Al_2O_3$  is approximately known; or the alumina may be separated by other processes, e.g., use of caustic soda, &c. *Sulphuric acid*, if present in the ore, is precipitated as barium sulphate from the hydrochloric acid solution of the ore; sulphur in the form of *pyrites* is determined by fusing the ore with sodium carbonate and nitrate in a gold crucible, and determining the total sulphate formed, the sulphate existing as such in the ore being subtracted. *Phosphorus* may be determined by dissolving the ore in aqua regia (usually the phosphorus exists as phosphate, and is wholly dissolved by hydrochloric acid), precipitating the phosphoric acid (best after separation of dissolved silica by evaporation to dryness and re-solution in dilute acid) in combination with part of the iron, by reducing most but not all the iron to the ferrous state, and then precipitating the ferric iron and phosphoric acid by boiling with an acetate; the precipitate is finally converted into magnesium pyrophosphate by solution in hydrochloric acid, addition of citric acid (less conveniently tartaric acid), ammonia, and magnesia liquor, and ignition of the precipitate collected after standing twenty-four hours; Eggertz's method of determining phosphoric acid is, however, more suitable for the estimation of minute quantities, this depending on the precipitation by molybdic acid of a peculiar yellow crystalline phosphomolybdate of ammonium on bringing together the phosphoric acid solution (from which dissolved silica has been removed by evaporation to dryness) and excess of molybdate of ammonium solution supersaturated with nitric acid. *Calcium* and *magnesium* are conveniently determined in the filtrate from the basic acetate and phosphate of iron and alumina thrown down in the separation of manganese gravimetrically, the filtrate from the precipitated manganese dioxide being employed, the calcium being first precipitated as oxalate, and then the magnesium as ammonio-phosphate; or the ferric oxide and alumina may be thrown down by ammonia free from carbonate, and the filtrate employed. *Hygroscopic water* and ordinary *moisture* are determined by drying at  $100^\circ$ , and noting the loss of weight; whilst *combined water* is subsequently determined by heating to redness in a tube through which dry air is aspirated, the issuing gases passing through a drying tube to absorb the water evolved; if nothing but water is lost on ignition, the weight so lost may be directly determined without collecting the water. *Titanic oxide*, *chrome ironstone*, *complex silicates*, &c., are often contained in the substance left undissolved by acid; for the modes of determination and analysis of these, and for the precautions in the determination of the soluble constituents should titanium be present and partly dissolved by the acid, &c., the reader is referred to larger treatises, in which also are to be found numerous methods of analysis other than those briefly indicated above.

The analysis of iron and steel is carried out on much the same lines as that of iron ores. The metal being dissolved in nitric acid or aqua regia, *phosphoric acid* is separated as above described, usually by Eggertz's process, the acid solution being previously evaporated to dryness and treated with dilute hydrochloric acid, which leaves behind *silica* formed from the *silicon* present, *graphite*, and *slag*; after ignition to burn off graphite, the silica is dissolved out by sodium carbonate solution and the residual slag weighed; in this way, however, more silica is generally obtained than represents the silicon originally present, as the silicates of the slag are apt to be more or less attacked by the acid; a better method for the determination of the slag is to dissolve the iron in bromine or iodine water, or by means of copper chloride (or mixed copper sulphate and ammonium chloride solution), which gives rise to cuprous chloride, dissolved out by beating; the slag is thus left undissolved, and may be weighed after boiling with sodium carbonate; the silica in the united sodium carbonate and bromine solutions being determined, the silicon is readily calculable. *Manganese* is determined just as in the case of ores. *Sulphur* is conveniently determined by treating with hydrochloric acid, and leading the evolved gases through a solution of lead or silver or some analogous metal, and finally converting the precipitated sulphide into barium sulphate; or by dissolving in aqua regia, evaporating, and converting the sulphuric acid found into barium sulphate: this method usually gives lower values than the others, barium sulphate not precipitating readily from very dilute highly acid solutions. The so-called "*combined*" carbon is found by determining the *graphite* left undissolved during the treatment of the metal with hydrochloric acid (by collection and burning to  $CO_2$  in oxygen, and absorption in caustic potash), and subtracting the amount from the total carbon found by digesting with copper sulphate or chloride, or with bromine water, collection of the undissolved mass on an

asbestos filter, and burning in oxygen, preferably with lead chromate in the front of the tube, to prevent chlorine or bromine vapours, &c., passing over, should the precipitate contain (through insufficient washing, &c.) substances which may evolve chlorine or bromine. Copper sulphate leaves behind an amount of copper equivalent to the iron dissolved; this covers up the finely divided particles of carbon, and diminishes the chance of pyrophoric oxidation and consequent loss of carbon during drying, which may otherwise occasionally take place, especially when the filter is dried by the aid of heat; but the solution of the iron is less rapid, and it is difficult to see or feel with a glass rod when all the iron is dissolved. Weyl dissolves the iron by making it the positive pole of a weak galvanic current passing through hydrochloric acid. Fresenius determines the "*combined*" carbon directly by dissolving in hydrochloric acid, passing the evolved hydrogen and carbonated hydrogen over red-hot copper oxide, and determining the carbon dioxide formed by absorption in potash as usual; if much sulphur is present, lead chromate should be employed to avoid errors due to formation of sulphur dioxide; if the amount of "*combined*" carbon is large, liquid non-volatile hydrocarbons are apt to be formed, which causes the method to yield too low a result. Ullgren determines the total carbon by oxidation to  $CO_2$  in the wet way with chromic and sulphuric acids of the residue left after treatment with copper chloride or bromine; the results are apt to be too low, owing to incomplete oxidation of the graphite. Regnault determines the total carbon by heating the finely powdered metal with copper oxide or lead chromate, and absorbing the  $CO_2$  produced by potash; by passing air over the finely divided metal at a low red heat, and when the oxidation is nearly complete finishing the operation in oxygen at a somewhat higher temperature, the use of copper oxide or lead chromate is rendered unnecessary; if too high a temperature and oxygen be employed at first, there is risk of forming fusible  $Fe_3O_4$  and of enclosing portions of carbonized unoxidized metal within a coating of that substance, which more or less protects it from the action of the oxygen, and tends to decrease the amount of  $CO_2$  collected. Eggertz determines the "*combined*" carbon in steel by solution of a known amount of borings or slings in a known amount of nitric acid, and comparison of the fluid as regards its colour with a similar solution prepared from steel of a known carbon percentage, or with a series of solutions of caramel made so as to exhibit the same tints as those yielded by steels of known carbon percentage when treated in this way. The principle of the method depends on the formation of soluble humus-like carbon compounds by the action of the nitric acid, probably analogous to the vegetable colouring matter of peaty water. Opinions differ widely amongst chemists as to the absolute accuracy of the method for general analytical operations, especially where nothing is known of the precise details of the mode of manufacture of the steel; but for a works laboratory, where speed is essential, and where it is only required to compare one specimen of steel with another one prepared in the same way but harder (the hardest steels being taken for the preparation of the standards, and the solutions representing the lower carbon percentages being obtained by diluting the fluid proportionately), the method is invaluable. For the sake of saving time under analogous circumstances, Eggertz somewhat modifies the above-described methods for the determination of sulphur and phosphorus, the amount of sulphur present being estimated by noting the discoloration produced on a plate of silver exposed to the gases evolved on solution in hydrochloric acid, or digestion with sulphuric acid, and comparing it with that produced under the same conditions from a metal of a known degree of sulphurization, and the amount of phosphorus being estimated by transferring the phospho-molybdic precipitate into a narrow measuring tube, and observing the volume occupied by it comparatively with that occupied by the precipitate similarly produced from metal containing a known amount of phosphorus. Sir J. Allyn has described a method of determining approximately the quantity of phosphorus present in iron and steel by means of the spectroscope (*Journal I. and S. Inst.*, 1875, 62). Nitrogen is determined by solution in hydrochloric acid free from ammonia, and titration by Nessler's test of the ammonia formed (A. H. Allen, *Chemical News*, xli. 231, 1880). The less commonly occurring substances, copper, chromium, arsenic, cobalt, nickel, zinc, aluminium, vanadium, titanium, tungsten, molybdenum, &c., are sought for and separated by special methods for which the larger text-books must be consulted.<sup>1</sup>

### III. EXTRACTION OF IRON FROM ITS ORES.

7. *History of the Manufacture of Iron and Steel.*—Neither the period when malleable iron was first prepared from its ores nor the precise mode of manipulation then adopted is known with certainty, although the remains of iron

<sup>1</sup> Parry and Tucker have employed the spectroscope successfully in this direction, see *Journal I. and S. Inst.*, 1880, 163.



implements manufactured in prehistoric times are so numerous as to leave no room for doubt as to the extreme antiquity of the use of that metal instead of the yet earlier stone implements of primeval man. There is every reason to believe that the earliest methods of iron smelting essentially consisted in placing lumps of ore in a fire of wood or charcoal, and, after the lapse of a sufficient length of time to permit of their more or less complete reduction, hammering the mass of spongy metal thus formed; so that what is known as the "Catalan forge" of modern times is but a comparatively slight modification of and improvement upon the oldest metallurgical appliances for the extraction of iron, the main difference being in the size of the apparatus and the use of an artificial air blast. Tradition assigns a very remote period to the first discovery of the possibility of extracting iron or crude steel from its ores, Tubal Cain (who has been compared with Vulcan) being the first name mentioned in connexion with the metallurgy of this substance. In the time of the Assyrians iron appears to have been in somewhat extensive use, saws, knives, and other analogous tools having been found by Layard at Nineveh, many of which are very similar to those in use at the present day. Both Homer and Hesiod refer to the forging of iron, whilst the hardening and tempering of steel also appear to have been operations in common use amongst the early Greeks; indeed the employment of a rough kind of bellows for the forging of tools (probably of iron) is figured in Egyptian sculpture of 1500 years and upwards B.C.,—the inflation being accomplished by the aid of cords worked by the hand, whilst the pressure of the foot caused the expulsion of the air thus drawn in, much in the same way as is still practised by some almost savage Eastern nations, *e.g.*, the Burmese. In the time of Hioy (about 50 A.D.) the existence of large masses of iron ore in Spain, Elba, Styria, and elsewhere was well known, these minerals being described by him as largely employed in the manufacture of iron and steel; whilst evidently the conditions requisite to produce the best temper of the latter had been carefully examined at that epoch, as he states that the quality of the steel depends on the nature of the water used to harden it, and that oil is preferable for small articles. Prior to this the discovery of cast iron or cast steel appears to have been made, for Aristotle (about 350 B.C.) describes the preparation of the fused or fritted steely iron still prepared in India and known as *woolz*, whilst Galen refers to cutting knives made of this steel, and mentions that they are apt to be brittle through excessive hardness. Through the agency of the Romans the manufacture of iron was introduced almost all over the then known world, and into those regions where it had not been previously practised; this, however, does not appear to have been the case with Britain, as the use of iron was probably known there before the Roman invasion; the knowledge, however, may very possibly have been originally derived from the Romans through the Gauls.

The earliest kind of iron forge or bloomery was probably simply an excavation on the windward side of a hill; the application of an artificial stream of air doubtless soon followed, the blast being either produced by the alternate dilatation and compression of a bladder or goat skins, &c. (as still practised in India and elsewhere), or by means of a fan propelling air through a hollow tube, the fan developing into a kind of loosely fitting piston as still employed in Orissa, Borneo, Madagascar, and elsewhere; so that the modern bellows and cylinder blowing machine are merely advanced and improved forms of these crude contrivances. The construction of a clay chamber to contain the fuel and ore, with the employment of a tyner at the base, so as to be independent of the direction of the wind and of the nature of the ground, was doubtless an early improvement, and probably was the kind of forge used by the Romans, as it still is substantially that used by various Eastern races.<sup>1</sup> The use of valved single bellows is attributed to the

Romans in the 4th century by Franquoy; when these developed into double-acting bellows is uncertain, although it is known that such blowing machines were in use in the Harz and elsewhere about the beginning of the 17th century. The date of the invention of the *trompe* (or air blast, due to the fall of water and the carrying down of air with it) is also uncertain, but was probably a little later, near 1640 (François); its use was probably almost confined to the Pyrenees and similar districts where the requisite fall of water was readily obtainable from natural rivulets and torrents. Cylinder blowing machines were introduced at the Carron iron-works about 1760, water-power being usually employed when practicable at that period; some twenty or thirty years later, when the steam engine came into use, a great impetus was thereby given to the iron industry, as to most other trades, owing to the increased facilities in all directions given by the increased command of power thus obtained. The precise date of the introduction of cast iron is unknown; probably it was an accidentally formed product in the first instance, due to the employment of larger furnaces and increased blowing power; in the 14th and 15th centuries it appears to have been known, castings of this period made in Sussex (especially of the later date) being said to be still extant, whilst in the 16th century cannon of some 3 tons weight each were cast by Johnson. About the end of the century the iron-works of Sussex and neighbouring counties had attained to such dimensions that their consumption of timber for fuel became a serious matter, so that an Act was passed in Elizabeth's reign prohibiting their further extension. Probably this restriction was the cause of attempts being made to utilize coal as fuel in iron smelting, a patent for this purpose being granted in 1611 to Simon Sturtevant, who, however, does not seem to have been successful. Somewhat later Dud Dudley succeeded in producing both cast iron and malleable iron by the aid of coke, but met with so much opposition from the charcoal smelters that he abandoned the process; a similar result befell Strada in Hainault about the same time; a century later, however, about 1735, Abraham Darby of Colebrookdale reintroduced coke as fuel with complete success. About 1766–1784 great improvements in the mode of working malleable iron and of transforming cast iron into wrought iron were introduced, partly by Thomas Crunage of Colebrookdale, and Peter Onions, but more particularly by Henry Cort, who patented the use of grooved rolls so as to supersede hammering in 1783, and of the puddling forge in 1784. Since the invention of puddling, and its improvement by Rogers by the introduction of iron instead of sand bottoms, the main improvements in the iron manufacture are the use of the hot blast instead of cold air, due to Neilson, and patented in 1828; the employment of the waste gases from blast furnaces for raising steam, &c. (and subsequently for superheating the blast), first patented by Aubertot in France in 1811, and subsequently largely employed in most iron-producing districts, Scotland and Staffordshire excepted; the invention of the steam hammer by Nasmyth, patented in 1842; and the introduction of the Bessemer-Mushet process for steel making (1856) by blowing air through molten cast iron so as to burn out the carbon, and then adding spiegeleisen so as to produce a metal of any required degree of carbonization. In every department of the iron industry, however, numerous improvements have been made, amongst which must be specially mentioned the Siemens regenerative furnace and gas producer, and the improved processes for making steel thence resulting; the use of machinery in lieu of hand labour for puddling, introduced at first unsuccessfully by Toth and Menelaus, and several others, but brought to a considerable degree of practical success by Danks, Crampton, and others; the casting of steel under great pressure, due to Sir Joseph Whitworth; the application of waste gases and the Siemens regenerative principle to the superheating of the blast by the Cowper-Siemens and Whitwell stoves; and the recently introduced improvements in Bessemerizing due to Snelus and to Thomas and Gilchrist, whereby even highly phosphorized pig is rendered capable of furnishing a fairly good quality of steel.<sup>2</sup>

8. *General Classification of Methods employed for the Extraction of Iron from its Ores.*—The various modern developments of the earliest methods of iron extraction, consisting of the heating of iron ores with fuel until more or less complete reduction was brought about, and hammering the mass, may be conveniently divided into four classes, viz.:—(1) those in which cast iron is produced by a smelting process (§§ 9–21), and subsequently transformed into steel or wrought iron by decarbonizing the resulting pig iron (§§ 22–28); (2) those in which malleable iron or steel is obtained direct from the ore at one operation without

<sup>2</sup> A lengthy series of papers on the "History of Modern Invention in the Manufacture of Iron" has appeared in *Iron*, 1876 and following years, from which much detailed information on the subject may be obtained.

<sup>1</sup> For a description of the different kinds of rude furnace in use in Borneo and other Eastern districts, see Percy's *Metallurgy*.

passing through the stage of cast iron (§§ 29-31); (3) those in which steel is formed from wrought iron by directly carbonizing it (§§ 32-35); and (4) those in which steel is finally prepared by intermixture of carbonized and wrought iron in the fluid state (§§ 36-41). The methods of class 1 include the preparation of pig iron; its purification by refining, and conversion into wrought iron by fining and puddling (both by hand and by machinery) and by inverse cementation (heating in contact with iron oxide); and the preparation of puddled steel and pneumatic steel and iron, *i.e.*, steel prepared by Bessemer's original process, *viz.*, decarbonization more or less complete by blowing air through molten pig iron, and also of Heaton's steel (pig iron decarbonized by nitrate of sodium), &c. Class 2 includes the Catalan forge and allied processes, and the "direct" methods of Clay, Chenot, Yates, Blair, Snelus, Du Puy, Siemens, and others. The processes included in class 3 are those of steel manufacture by cementation and partial acieration by case hardening, together with various other allied methods of producing steel from soft iron; whilst class 4 includes the Bessemer-Mushet steel process, in which blown Bessemer metal is made into what is usually known as "Bessemer steel" by incorporating with it spiegeleisen; and the allied open hearth steel processes, in which wrought and cast iron are melted up together, or iron is decarbonized in a Siemens hearth and then mixed with ferro-manganese, &c.; together with various modifications of these processes, such as the Snelus-Thomas-Gilchrist method of blowing phosphorized pig, the Uchatius process, the Ponsard process, &c.

rapid combustion, which might otherwise cause the ore to frit. Blackband usually requires only lighting with a little coal, &c., when properly heaped, furnishing its own fuel.

When economy in fuel is desirable, a calcining kiln is employed, generally resembling a lime kiln in construction. Fig. 1 represents a kind of kiln (Gjers's) used extensively in the Cleveland district; it is usually

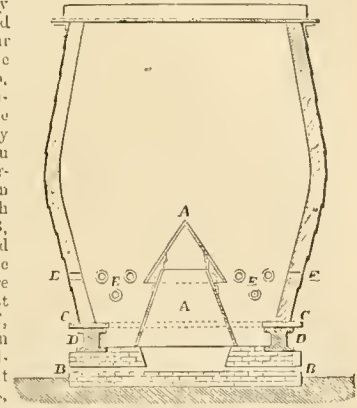

FIG. 1.—Gjers's Kiln.

built of fire-brick cased with iron plates, circular in section, wider in the middle than at top, and tapering downwards from the middle slightly more rapidly than upwards. An iron double cone AA surmounts an orifice in the base connected with radiating flues B, B, whereby air is introduced into the interior. The whole superstructure rests on an annular cast iron entablature CC, supported on stout iron pillars D, D; the calcined ore is raked out between these pillars, the spaces between them serving for the admission of air at the base; a further air supply is obtained from orifices E, E, E, E in the lower conical portion. A usual size is some 20 feet maximum diameter, and a little more in height, with a capacity of

IV. MANUFACTURE OF CAST IRON.—IRON SMELTING.

9. *Preliminary Treatment of Ores.*—Many kinds of ore are unsuitable for use in the blast furnace without some preliminary treatment,—consisting either of washing with water and dressing in the ordinary way adopted with heavy minerals to wash out clay, &c.; weathering by exposure to air and moisture for considerable periods of time so as to oxidize pyrites, &c., and wash out the soluble matters formed; roasting, so as to expel carbon dioxide and water and burn off organic matter, peroxidizing the iron in so doing; or a combination of some or all of these processes. Even with such ores as magnetic ironstone calcination is usually found to increase the ease with which the ores are subsequently smelted, the lumps being rendered somewhat porous, and hence more readily acted upon; indeed, with compact Swedish magoetites previous calcination is indispensable, otherwise great waste of fuel is occasioned. In the case of franklinite, a mangano-zinciferous magnetite, the mineral is first roasted with lime and anthracite so as to distil off the zinc, and the residue then smelted for spiegeleisen. Certain Westphalian and other ores are deprived of sulphur existing as pyrites by roasting in a kiln, into which superheated steam is admitted at intervals, whereby sulphuretted hydrogen is first formed and subsequently burnt to sulphur dioxide, whilst the iron of the pyrites is converted into oxide; by using a mixture of highly carbonaceous blackband and other ores, the roasting is effected without the use of any fuel other than that contained in the blackband. Where fuel is not an object, calcination of iron stone is frequently effected in heaps analogous to those produced in the burning of "ballast" (clayey soil) for foundations of houses, roads, &c.; a fire of slack being made, shovelfuls of ironstone are thrown on to it, and then more slack and more ironstone alternately, until a sufficiently large heap is prepared; or the heap is first built up and subsequently fired, the spots where the fire comes visibly out of the heap being, when requisite, damped over with moist small ore so as to prevent too

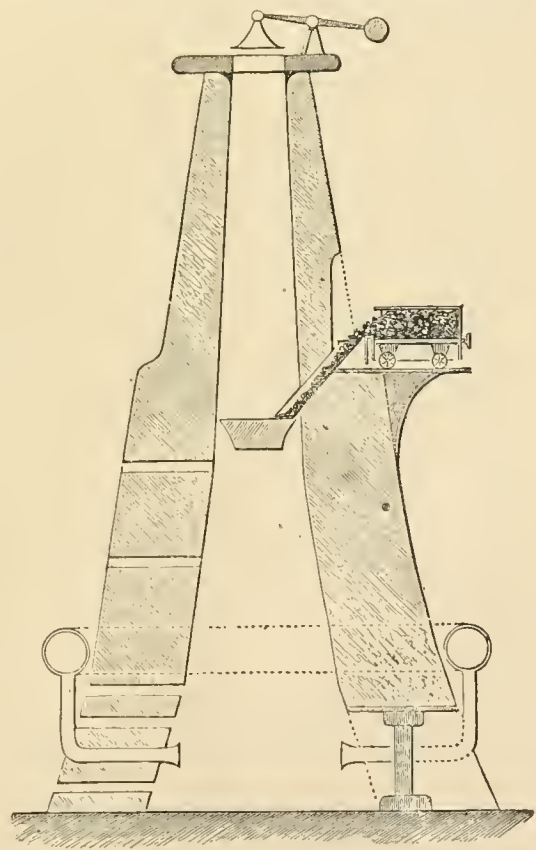

FIG. 2.—Westmann's Kiln.

upwards of 5000 cubic feet; but considerably larger kilns are often used; the consumption of slack is from 4 to 5 per cent. of the ore (Cleveland ironstone) calcined. Siemens has patented a somewhat analogous calcining furnace, combustible gas and air being led into the centre and distributed by a cone; Rchette's calciner is oval,



with three firing gates, two on one side and one on the other. The magnetic ores and quartzose hematites of Sweden, Russia, America, and elsewhere are often calcined in Westmann's kiln (fig. 2). This is a nearly tubular vertical kiln slightly diminishing in diameter upwards, and fed at the base with waste gases from the blast furnace, together with air for their combustion; the ore is thus rendered somewhat less dense than at first, whilst pyrites, when present, is decomposed; and analogous arrangements are employed in many Continental iron-works. Many attempts have been made to smelt clay ironstone without previous calcination, but as a general rule but little saving appears to be effected, if indeed any at all is brought about; the value of the small coal and slack saved in the roasting barely, if at all, compensates for various practical disadvantages attending the use of raw ore as compared with calcined ores. Much the same remarks apply to brown ores, especially when earthy. Several methods have been proposed to remove phosphorus compounds from ores containing that constituent before smelting them, so as to produce a purer metal; the success of these as manufacturing operations, however, has been mostly indifferent, the cost and labour involved not being adequately repaid by the results. Amongst these processes may be noticed those of Jacobi and Velge; the former places the broken-up ores in tanks, and lixiviates them with aqueous solution of sulphurous acid obtained by burning pyrites; in this way phosphates are dissolved out, from which manures may be made; the latter impregnates the ores (previously calcined) with brine, and after drying calcines again, subsequently washing out the phosphate of sodium produced by water, or preferably water containing a little hydrochloric acid. Jacobi's process has been tried on a considerable scale, and apparently could be worked commercially were it not that, to extract the phosphates thoroughly, the ore requires crushing to coarse powder, or at least to lumps so small as very materially to interfere with its employment in the blast furnace; moreover, whilst calcium phosphate is readily soluble in solution of sulphurous acid, ferrous phosphate is not soluble in that menstruum, and hence is not removed from ores containing phosphorus in this form.

The ores being ready for smelting, the next stage in their treatment consists in subjecting them to the reducing action of carbon oxide (and also of carbon), at a temperature gradually increasing as the reduction goes on, until finally the reduced metal melts; in order to promote the separation of the earthy impurities of the ore from the metal, and to facilitate their fusion, it is requisite either to mix various classes of ores together in such a fashion that the silicious admixtures of the one and the calcareous and aluminous impurities of the others may jointly be in suitable proportions relatively to one another; or, which is usually more convenient, to add calcareous or other matters (in the form of limestone, ferruginous clay, aluminous poor iron ores, &c.) to serve as a flux. To carry out this operation the *blast furnace* is employed, the ore, flux, and fuel being charged in at the top of the erection, and air being blown in at the base, so that a mixture of carbon oxide and nitrogen is formed at the lower levels, which, passing upwards, effects the decoxidation of the ore; the heat produced at the base fuses the reduced iron and the earthy matters, &c., which accumulate in two layers (the former being the heavier), and are drawn off from time to time, the one as cast or pig iron, into moulds for the market, the other as cinder or slag, usually of little or no value. Fresh materials are added at the top, so that the furnace works continuously.

10. *Fuel*.—The fuel employed in iron smelting by means of the blast furnace is substantially always one of three kinds, viz.; raw coal (anthracitic, or more or less bituminous), coke, or charcoal;<sup>1</sup> inasmuch, however, as raw coal inserted into the mouth of a blast furnace speedily becomes coked, the combustible matter reaching the tuyere level is invariably carbon in a greater or less state of purity. The effect of using raw coal instead of coke in the first instance is chiefly marked as regards the alteration thereby produced in the character of the gases in the upper part of the furnace, and the consequent alteration in the chemical changes taking place, chiefly owing to the presence of hydrogen and hydrocarbons in much larger proportion. For numerous other operations in connexion with the metallurgy of iron, other kinds of fuel are often employed, lignites, turf, wood, &c. The following analyses will give

<sup>1</sup> Peat has been used successfully as fuel in some Austrian furnaces, especially in the Voeltemberg district, in open-topped furnaces about 30 feet high. The peat was made into compressed balls and dried in the air; these descended to the tuyere without losing their shape, but of course wholly carbonized. The iron produced was white, but of as good quality as that obtained with charcoal. Lignites and brown coal have similarly been employed in districts where better coals are scarce.

an idea of the general character of the fuels usually employed. In the north of England a very hard variety of coke, often known as "Durham coke," is made specially for iron smelters; during the production of this, on an average about one half of the sulphur originally present in the raw coal is expelled, the yield of coke being about two-thirds of the coal employed.

Character of Coal and Locality	Durham Coal <sup>1</sup>	Dowlais Non-caking, poor in Oxygen.	South Staffordshire Non-caking, rich in Oxygen.	Amais, France, Caking Coal. <sup>2</sup>	Anthracite, Swansea.	Lancashire Coals. <sup>3</sup>
	Average.	Biley.	Vaux.	Regnault.	Regnault.	Admiralty Reports.
Analyst	Alder Wright.	Biley.	Vaux.	Regnault.	Regnault.	Admiralty Reports.
Carbon	82.5	88.13	78.57	89.27	92.56	77.53
Hydrogen	5.6	4.51	5.29	4.85	3.33	5.32
Oxygen	5.0	2.94	12.88	4.47	2.53	9.35
Nitrogen	1.0	1.41	1.84	0.39	1.41	1.30
Sulphur (total)	1.2	1.01	0.39	1.41	1.53	1.44
Ash	5.3	2.00	1.63	...	...	4.88
	100.0	100.00	100.00	100.00	100.00	100.00
Sulphur in ash	0.95	...	...	...	...	...

<sup>1</sup> "Busty" and "Brockwell" seams, largely used for making blast furnace coke.  
<sup>2</sup> Yields a good blast furnace coke.  
<sup>3</sup> Average of 28 samples of various kinds.

Character of Fuel and Locality	Dovey Tracey Lignite, Devonshire.	Dartmoor Peat.	Oak Wood. <sup>1</sup>	Highly burnt Black Alder Charcoal. <sup>2</sup>	Coke from Durham and Northumberland Caking Coal. <sup>3</sup>	Hard Coke used in Cleveland District for Blast Furnaces.
	Vaux.	Vaux.	Chevan dier.	Violette.	Alder Wright.	Lowthian Bell.
Analyst	Vaux.	Vaux.	Chevan dier.	Violette.	Alder Wright.	Lowthian Bell.
Carbon	66.51	54.02	59.09	96.51	92.5	93.5
Hydrogen	5.63	5.21	6.03	0.62	0.5	0.4
Oxygen	22.86	28.18	42.00	0.93	1.0	...
Nitrogen	0.57	2.30	1.23	...	...	...
Sulphur	2.36	0.56	...	...	1.0	...
Ash	2.27	9.73	...	1.94	5.0	6.6
	100.00	100.00	100.00	100.00	100.00	100.00

<sup>1</sup> Exclusive of 2.01 per cent. of ash.  
<sup>2</sup> Heated to an intense white heat to expel as much volatile matter as possible; similar charcoal prepared at somewhat lower temperatures retained 10 to 15 per cent. of oxygen and hydrogen jointly.  
<sup>3</sup> Average coke from "Busty" and "Brockwell" seams of coal, specially prepared for blast furnaces.

It is somewhat difficult to fix on an average value for the heat of combustion of coal, great variations being observable with different classes. The following values of Scheurer Kestner and Meunier (*Annales de Chim. et Phys.* [4], 21, 436, and 26, 80) are calculated after allowing for ash, and on the supposition that the carbon dioxide and water produced were formed at the ordinary temperature, near 20°:—

Character of Coal	Percentage Composition.			Calorific Value.	
	Carbon.	Hydrogen.	Oxygen and Nitrogen.		
Lignites from Basses-Alpes...	66.31	4.85	28.84	6991	
	70.57	5.44	23.99	7363	
Non-caking coal, Creusot	90.79	4.24	4.97	9293	
Caking do. do.	88.48	4.41	7.11	8622	
Anthracite.....	Blainzy.....	87.02	4.72	8.26	9111
	Creusot.....	92.36	3.66	3.98	9456
Saarbrück coals.....	83.82	4.60	11.58	8724	
	76.87	4.68	18.45	8215	
Romchamp coal, average	88.59	4.69	6.72	9120	

Hence average true coal may be taken to have a heat of combustion of 9000 when ash free; assuming it to contain 5 per cent. of ash, 8550 will be the heat produced. If aqueous vapour at 20° were formed instead of liquid water, assuming average coal to yield 40 per cent. of aqueous vapour on complete combustion, 0.4 × 593 = 237 heat units less would be evolved, 593 being the latent heat of water at 20° (Regnault); so that 8300 may be taken as an approximation to the heat of combustion of ordinary

coal burnt to carbon dioxide and water vapour at 20°. The heat of combustion of coke and charcoal is somewhat less than this: 1 part by weight of carbon gives out about 8000 units of heat, so that, if the coke contained 7.5 per cent. of ash and no appreciable amount of hydrogen, the heat of combustion (burnt to carbon dioxide) would be about 7400 (see § 20).

For certain purposes, and more especially for use in the blast furnace, the physical properties of the coke used are important; when caking coal is coked in furnaces so constructed as to permit of the collection of the products of the decomposition of the coal by heat, a larger yield of coke is obtained than is got when the coking is effected at a higher temperature brought about by the combustion of the volatile matters as fast as they are generated; but the softer coke obtained in the former way is less suited for smelting iron in the blast furnace than the harder variety obtained by the latter process; where lofty furnaces are in use, a hard coke that will stand the crushing action of the weight of the superincumbent materials answers better than a softer coke which is disintegrated by the pressure. Moreover, the hard compact form is less readily acted upon by carbon dioxide so as to produce carbon oxide (the carbon of the coke being gasified) than is the case with the softer form of coke; accordingly it results that when soft coke is employed in the blast furnace a larger amount of it is requisite per given weight of iron made than would be required were hard coke used instead; so that the greater yield of soft coke from the coal used in the first instance is counterbalanced, and even more than counterbalanced, by the increased quantity required to do the work of the furnace.

**Crampton's Furnaces.**—For various purposes for which fuel is employed, whether for raising steam or producing a more or less oxidizing or reducing flame (e.g., in puddling), a form of flame-producer is available obtained by blowing into the furnace a jet of air carrying with it finely ground coal; for this purpose Crampton employs a mill like an ordinary flour mill with Derbyshire grit stones. The ground coal is placed in a hopper A (fig. 3) con-

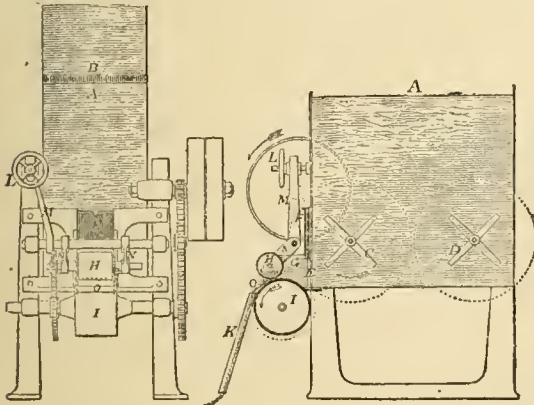

FIG. 3.—Crampton's Mill.

taining a sieve B, two agitators C and D stirring up the fine coal under the sieve, and urging it outwards through an opening E, the size of which is controlled by a sliding door F; from this opening it passes between rollers H and I, the distance between which can be regulated by a screw L acting on a lever MN, which adjusts the position of the bearings of the upper and smaller roller; in this way the feed is perfectly under control; the agitators cannot force out the coal-dust from the hopper at a greater speed than that regulated by the rollers. The stream of issuing coal-dust falls down a shoot K, a scraper O being provided to prevent adherence to the rollers; at the bottom of the shoot it is blown away continuously by an air blast, the shoot delivering the dust into the blast pipe continuously; the blast remaining the same, the amount of fuel is regulated by the screw and levers; or, the coal-dust supply being constant, the air blast can be varied. The flame thus produced on kindling the jet of air and coal (suitably proportioned to one another) is smokeless, and perfect combustion is effected with an intensely high temperature; for puddling and reheating furnaces, for heat-generating purposes generally, and for steam raising, the arrangement answers admirably (*Journ. I. and S. Inst.*, 1873, 91, and 1874, 384; see § 21).

Besides coal, coke, and charcoal, various other forms of combustible matter are used as sources of heat in certain of the operations involved in the extraction of iron from its ores. Among these may be mentioned the following.

**Coal Tar.**—At the Wyandotte Rolling Mills, Michigan, coal tar has been employed as fuel, being injected into the puddling furnace to be heated by means of a jet of superheated steam, which carries with it a certain amount of atmospheric air, the principle being much the same as that of firing tar-stills with waste naphtha. The steam at a pressure of four atmospheres (60 lb per inch) is superheated by forcing through a coil in the exit flue of the furnace, whereby it is raised to a red heat, and issues from a  $\frac{1}{8}$  or  $\frac{1}{4}$  inch nozzle into an opening at the level of what would be the bridge were the ordinary firehole employed, the tar dripping down into the opening, and the air drawn in thereat being impelled onwards by the jet so as to fill the whole furnace with flame.

**Petroleum.**—Raw petroleum and the lighter benzoline obtained as a bye product in the manufacture of illuminating and lubricating oils have been used in America as fuel applied in much the same way as the above-described. Experiments at Pittsburg indicated that for puddling and steel melting furnaces this fuel answered well, a consumption of a gallon of benzoline used in this way producing the heating effect of several times its weight of coal burnt in the ordinary fire-place.

Crude petroleum contains, according to Plagge,

Carbon.....	84.00 per cent.
Hydrogen.....	13.75 "
Oxygen.....	2.25 "

Hence its calculated heat of combustion is about 11,300 per unit weight of substance burnt (i.e., 1 part by weight, on combustion to carbon dioxide and water, will give out heat enough to raise the temperature of 11,300 parts of water 1° C.), or considerably in excess of that of charcoal and coke; if burnt to carbon dioxide and steam, the heat evolved by petroleum will be some 6 per cent. less, or 10,600, that of coal being 8300 on an average, as stated above. At the Eames Iron-Works, Titusville, Pennsylvania, petroleum is allowed to trickle over a series of shelves in a chamber through which highly superheated steam passes; the current of combustible vapour produced is used for reheating and puddling furnaces, with the result of employing thirty barrels of petroleum daily for an output of iron that would otherwise require 40 tons of coal.

**Natural Gas.**—In Pennsylvania the gas evolved from petroleum wells and springs into a subterranean stratum (some 1600 feet below the surface) is largely utilized as fuel. One of the largest of these, the Delamater Well, some 30 miles from Pittsburg, was described in 1877 by Professor Laurence Smith as having at first yielded considerable amounts of petroleum, but then giving off nothing but gas coming up with a velocity of 1700 feet per second at the rate of about a million cubic feet per hour, or upwards of 1400 tons daily. In a 5½ pipe at the well the pressure was 100 lb per square inch, so that large engines were worked by the gas current pressure alone. The illuminating power was about 7½ candles, or less than half that of good coal gas; the calorific effect was considerably superior to that of the most bituminous coal (weight for weight) on account of the much larger percentage of hydrogen (free and combined). Puddling and reheating furnaces fired with this fuel fed in through pipes in the rear of the fire bridge answer well, but emit some smoke; when it is used with a more plentiful supply of air under steam boilers, no smoke at all is produced. — The composition of the gas from some of these wells is indicated by the following analyses by Sadtler:—

		Burns, Butler Co.	Lechburg, Westmore- land Co.	Harvey, Butler Co.	Cherrytree Indiana Co.
Ethane.....	C <sub>2</sub> H <sub>6</sub>	18.12	4.39	5.72	6.80
Olefines.....	C <sub>n</sub> H <sub>2n</sub>	...	0.56	...	...
Marsh gas.....	CH <sub>4</sub>	75.44	89.65	80.12	60.27
Hydrogen.....	...	6.10	4.79	13.50	22.50
Carbon oxide.....	CO	trace	0.26	...	...
Carbon dioxide...	CO <sub>2</sub>	0.34	0.35	0.66	2.21
Nitrogen.....	...	...	...	...	7.39
Oxygen.....	...	...	...	...	0.83
		100.00	100.00	100.00	100.00

**Gaseous Fuel.**—Various forms of arrangement for producing combustible gases in one place and leading them by means of tubes elsewhere to be burnt as fuel have been devised by numerous inventors. The object arrived at being essentially cheapness of production, the combustible substances have usually been coal, slack, lignites, shales, and the like, more or less submitted to distillation by the heat developed by the combustion of a part of the mass, the ultimate product of this combustion being largely carbon oxide formed by the action of the heated carbonaceous



matter on the carbon dioxide first formed. One of the most successful of these is the *Siemens gas producer*, which is applicable to the production of heat by means of gaseous fuel generated from all kinds of waste materials, such as shale and combustible rubbish of all sorts, and is represented in fig. 4; the air, being admitted only through the

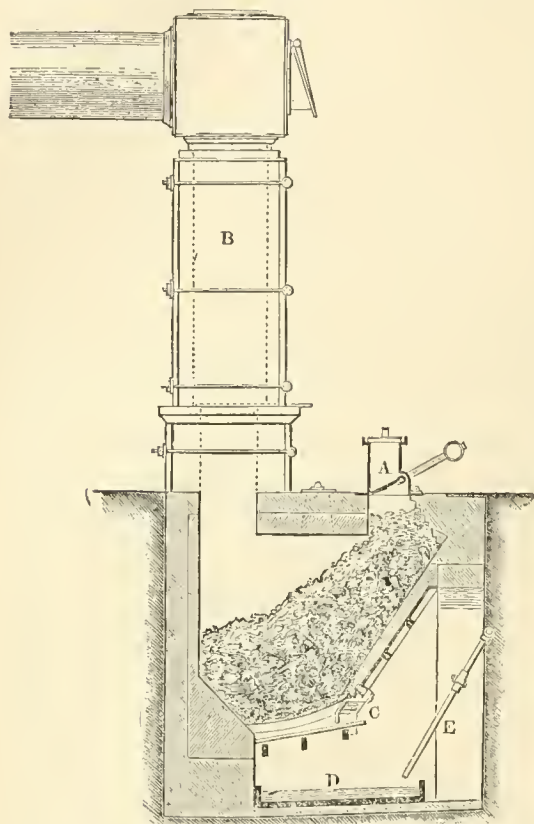
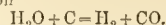

FIG. 4.—Siemens Gas Producer.

bars, C, is converted into nitrogen and carbon oxide in its passage through the incandescent mass, whilst hydrocarbons and hydrogen are also evolved in the upper portion by the action of the heat on the organic substances used as fuel, passing off by the gas flue B. A is the charging hole for the introduction of fresh fuel; the ashes are stoked out from time to time from between the bars, which may with advantage be made capable of rotation about their own axes when shale is burnt, so as to facilitate the extraction of the burnt residue. E is a pipe which allows water to drip down into the ash pit D, and so to keep it always wet. The following analyses will give an idea of the composition by volume of the gas from such producers:—

Analyst.....	Siemens.	Snelus.		
Particulars.....	Mixture of 3 parts caking coal and 1 part non-caking.	Dowlais.		
Combustible gases.	Hydrogen..... 8.2 Carbon oxide..... 24.2 Marsh gas..... 2.2 Other hydrocarbons.....	8.6 24.4 2.4 traces	... 25.6 1.6 2.8	
Incombustible gases.	Carbon dioxide..... 4.2 Nitrogen..... 61.2	5.2 59.4	4.3 65.7	39.0 70.0
	100.0	100.0	100.0	100.0

When steam is allowed to pass into the producer along with the air, it reacts on the hot carbon of the fuel, producing "water gas" in virtue of the reaction



The extent to which this can be safely done depends on the fuel burnt, the decomposition being attended by an absorption of heat; if more steam be admitted than can be decomposed, the surplus passes on unchanged and dilutes the gases, serving no useful purpose, but rather the contrary. Usually the small amount of steam requisite is produced by placing a water-tank underneath the grate, supplied continually with water as indicated in fig. 4, so that evaporation is set up by the radiating effect of the fire; only a relatively small volume is thus drawn in with the air used for combustion, but enough to give several parts per cent. of additional hydrogen and carbon oxide in the gas, and sensibly to increase the heating power. Roughly speaking, the calorific value of a unit of weight of gas from a Siemens producer is about 650; for one part by weight of carbon oxide will develop 2400 units of heat, and average gas contains about 25 per cent. by weight of carbon oxide with a little hydrogen (some 0.5 per cent. by weight), and hydrocarbons equivalent to some few parts per cent. more of carbon oxide. The mean specific heat of the gases being about 0.24, an alteration in temperature of 300° would represent about 72 units of heat, or 11 per cent. of the heating power; so that by conveying the hot gases from a Siemens producer such a distance that their temperature is reduced by 300°, a considerable loss of effective heating power is experienced, amounting to about one-ninth of the actual heat developed by combustion. Partly owing to this cause, and partly owing to radiation, absorption of heat by the brickwork of the fireplace, &c., it has been calculated that the heat actually producible by means of gaseous fuel is only about two-thirds of that due to the fuel actually employed; but manifestly the latter sources of loss apply to solid fuel burnt in an ordinary firegrate just as much as to a gas producer. Experience shows that when the producers are near to the furnaces fed by them the fuel consumption is perceptibly lessened.

*Siemens Regenerative Furnace.*—The peculiar feature of this furnace is that the waste heat is employed to heat up both the gaseous fuel and the air requisite to burn it before they are introduced into the furnace or chamber in which they undergo combustion. This is effected by making the exit gases pass through "regenerators," consisting of piles of firebricks stacked loosely together so as to expose as much surface as possible. Figs. 5 and 6 represent such a regenerative furnace as arranged for melting steel on an open hearth (*Journal of Chemical Society*, 1873, p. 661).

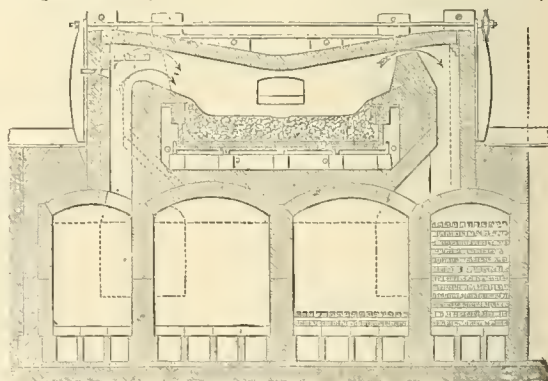

FIG. 5.—Open-Hearth Furnace—Longitudinal Section.

Four such piles are employed, two being heated up by the waste gases escaping from the melting furnace, whilst the other two are in use, the one for heating the gaseous fuel supplied from a Siemens gas producer, or from a gas main fed by several such producers, the other for heating the air requisite for the combustion of the gas. By suitable valves the waste gases are shunted from the first to the second pair of regenerators, whilst simultaneously the gas and air are changed from the second to the first pair; as the temperature at which the gas and air enter is close to that at which the products of combustion leave the furnace, whilst the regenerators are being heated up, the temperature of the combustion chamber continually rises (when not reduced by the introduction of cold substances) with each reversal of the currents through the regenerators; so that ultimately the only limit to the temperature attainable is the refractoriness of the materials of which the furnace is constructed. Even Welsh Dinas brick, which perfectly resists the ordinary steel melting

temperatures of coke-fired furnaces, even when the least fusible mildest steels are being prepared, can be easily melted when the furnace is pushed; these bricks are made from a silicious clay (containing 98.31 per cent. of silica, 0.72 of alumina, 0.18 of ferrous oxide, 0.22 of lime, 0.14 of potash and soda, and 0.35 of combined water), mixed with 1 per cent. of lime, and are usually considered the most refractory in ordinary use. A specially prepared brick made from a mixture of crushed pure quartz and 2 per cent. of lime answers much better. Bauxite bricks are somewhat less refractory, and have the further objectionable quality of shrinking much when highly heated, whilst fresh bauxite introduced for repairing cavities caused by wear and tear will not adhere properly to them; where

	By Volume.	By Weight.
Carbon dioxide.....	11.8	19.6
Carbon oxide.....	19.8	20.8
Hydrogen.....	11.3	0.9
Marsh gas.....	4.0	2.4
Nitrogen.....	53.1	56.3
	100.0	100.0

*Brook & Wilson's Producer* (fig. 7) consists of a solid hearth with no firebars: the coal is fed in at the top by means of a hopper-shaped conical tube closed by a "bell and cone" arrangement; the air requisite for combustion is supplied by means of a steam jet, and blows into a bell-mouthed pipe outside, communicating with a box-shaped cast iron chamber in the middle of the base of the producer; this chamber, being perforated, distributes air and steam uniformly throughout the mass of fuel, and so prevents unchanged steam and excess of air from passing away in the gases, which are led away by a tube communicating with the annular upper part of the producer between the hopper and the outer wall. Siemens has recently introduced a modification of his gas producer differing chiefly from

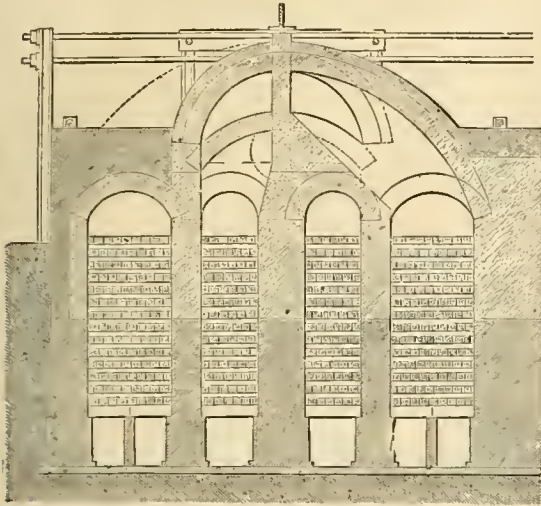

FIG. 6.—Open-Hearth Furnace—Cross Section through Regenerators, Air and Gas Flues.

ores requiring lime as flux are employed, however, they are less readily corroded than silica bricks. The hot air and gas currents and the waste gases are reversed through the regenerators at convenient intervals by means of a cast iron valve on the principle of a four-way cock; when the regenerators are placed vertically and heated from the top, their action is more uniform than when the draught is in any other direction; they should be at a lower level than the heating chamber, and may be worked either with a gas pressure just about atmospheric, or preferably with a slightly increased pressure so as to avoid possible chilling of the furnace by the drawing in of cold air, the pressure being regulated by the chimney damper and the valves governing the gas and air supplies.

Since the composition of the gas from a Siemens gas producer is, roughly speaking, somewhat less than one-third carbon oxide or gases equivalent thereto, and somewhat more than two-thirds nitrogen and carbon dioxide, and as carbon oxide requires half its volume of oxygen and hence about two and a half times its volume of air for complete combustion, the volumes of gas and air equivalent to one another are roughly equal; but, since an excess of air is usually requisite, and is indispensable when an oxidizing atmosphere is desired, the regenerators by which the air is heated are made somewhat larger than those used for heating the gas; by suitably adjusting the speed of the air current by the valve, the atmosphere can then be rendered neutral, reducing, or oxidizing at will. This point is of less importance for other applications of the regenerative furnace such as glass making or steel melting in crucibles than it is for puddling and reheating furnaces. For every pound of coal burnt per hour about 6 square feet of surface is requisite in the regenerators to take up the heat; whilst about 60 lb weight of brickwork is requisite to expose the surface to the best advantage, i.e., between three or four times the weight of brickwork which would have the same capacity for heat as the waste gases (equal to about 17 lb).

*Lundin's furnace* (or gas producer), employed in Sweden for the production of gas from moist sawdust, is constructed on much the same principles as Siemens's gas producer, saving that the air is driven in by a blast; as the sawdust contains upwards of 40 per cent. of moisture, the steam and hot gases passing off from the furnace are cooled down, and the former condensed, by jets of water-spray and a kind of scrubber consisting of piles of iron pigs over which water flows. Peat and turf can be used with the same arrangement, if not too wet. The gas evolved from sawdust has about the following composition after condensation of steam, exclusive of about 3 volumes per cent. of aqueous vapour:—

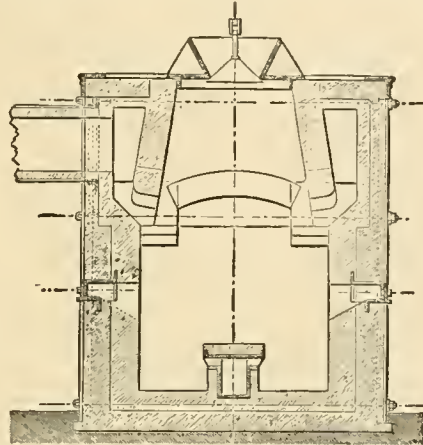

FIG. 7.—Brook and Wilson's Gas Producer—sectional elevation.

this one in details of construction, being more simple. The *Tessie du Molay* generator is in form like a small close-topped blast furnace fed by means of a cup and cone with coal dust or other low-class fuel; the hearth is cylindrical, with a brick bottom, on which are formed four channels, each communicating at its ends by passages with cast iron mouthpieces or windboxes, connected with an annular blast main through which blast is supplied at a pressure of about 8 inches of water. Doors are provided at the mouthpieces for the removal of ashes from time to time (see *Engineering*, April 23, 1880). Several other gas producers have been introduced by various inventors, and are employed to a greater or lesser extent; the limits of the present article forbid these being discussed.

*Peat and peat charcoal* have been proposed by Kidd as sources of gaseous fuel. Steam at a pressure of 20 lb being injected, together with a considerable volume of air carried along with it, into a mass of incandescent peat charcoal in a suitable chamber produces a fuel of much the same composition as that obtained from sulphur dioxide. Keates gives the following analysis of gas thus produced:—

Carbon oxide.....	28.6
Hydrogen.....	14.6
Nitrogen.....	53.0
Carbon dioxide.....	4.0
	100.2

the figures representing the volume in cubic feet of gas formed from 1 lb of peat charcoal, so that upwards of 200 000 cubic feet of gas are yielded by a ton of charcoal.

11. *Fluxes and Cinder*.—When a very pure iron ore is smelted, such as Cumberland hematite or Swedish magnetite, the amount of silicious and earthy matter present relatively to the iron oxide is but small, and in consequence the amount of flux requisite to be added is also small. By proper combination of ores of different kinds the necessity for the addition of flux may be almost or altogether avoided; thus a highly aluminous ferric oxide known as bauxite (valuable as a source of aluminium and its compounds, as well as serviceable as a source of iron and flux in the blast furnace) and silicious hematite smelted



together, with the addition of a little limestone or quicklime, furnish a cinder consisting mainly of calcareous aluminium silicate which readily melts and separates from the pig iron; similarly aluminous shales from the Coal Measures may be used instead of bauxite, whilst certain Swedish ores naturally containing as gangue fusible silicates of lime and magnesia, together with limestone, can be smelted without any additional flux of any kind, and will even serve to take up the silicious gangue from other ores when smelted with them if the latter are not in too large a proportion. On the other hand, clay ironstone and clayey ores generally usually require a considerable admixture of limestone or quicklime in order to yield a sufficiently fusible cinder, the presence of a sufficiently large amount of basic matter (lime and magnesia, or manganese oxide) in the cinder being essential in order to prevent the pig iron from taking up too much sulphur from the coke or coal when these fuels are employed. Phosphorus, however, when present in either the ore, the flux, or the fuel, is almost entirely taken up by the pig iron, as was shown in 1833 by Berthier, and subsequently confirmed by other observers; thus Lowthian Bell found that in a furnace smelting Cleveland ironstone, with a consumption per 100 parts of pig of

Ironstone containing 0.522 per cent. of phosphorus = 240 parts  
 Limestone " 0.011 " " = 60  
 Coke " 0.265 " " = 120 "

and a formation of 150 parts of cinder containing 0.098 per cent. of phosphorus, the amounts of phosphorus leaving the furnace in the slag and pig iron respectively were almost exactly 10 and 90 per cent. of the total phosphorus present; whilst in the same series of experiments the sulphur retained by the iron and that passing out in the slag were respectively between 2 and 2.5 and between 97.5 and 98 per cent. of the total sulphur present (which amounted to upwards of 4 parts per 100 of pig).

According to Riley the amount of phosphorus retained in the slag is greater the more iron is present. When the reduction of the metal is all but complete, and the furnace consequently is working well, the pig contains practically all the phosphorus present, whether it be white or grey; but if the slag becomes more or less of a "scouring" character through incomplete reduction of considerable amounts of iron, notable quantities of phosphorus are also present therein. Witherbee finds that a certain small amount of phosphorus contained in the charge fails to appear in the pig iron, this amount being greater the higher the temperature of the hearth, i.e., being greater when Bessemer pig is being run than with iron smelted at a lower temperature. This he explains by supposing that phosphorus is volatilized in the furnace, a view apparently corroborated by direct experiments made by Akermann.

Some of the Lincolnshire ores are imbedded in a calcareous matrix or gangue; in order to smelt these an admixture of silicious ore is necessary. For this purpose the more or less silicated forge mill cinders from the manufacture of malleable iron are frequently used, these substances virtually constituting rich iron ores, the only drawback of which is that their texture is compact, and they generally are in small pieces, so that they could not be smelted advantageously alone; moreover, they usually contain considerable quantities of phosphorus, if that constituent was present to any extent in the original pig used for puddling, mill cinder (the scale formed and detached during rolling) being much purer in this respect than forge cinder (the molten slag squirted out during hammering).

When any notable amount of manganese oxide is present in the cinder, it is generally very fluid and easily fusible; accordingly, when a furnace shows a tendency to "scaffold" (by the fritting together of lumps which form a comparatively solid skeleton mass inside the furnace, preventing the charge from descending properly), a manganese ore is sometimes employed as a sort of flux to assist in removing the obstruction by melting it down. In Sweden, when sulphur is present in the ores to an undue amount (through imperfect calcination, &c.), it is usual to add some titaniferous ore to the charge (some 10 per cent. or so); the pig is thereby prevented from taking up the sulphur, possibly through the formation of titanium sulphocyanide. In the anthracite furnaces at Cedar Point, U.S., it was found that a much more fluid cinder was produced when a magnesian limestone, containing 67 per cent. carbonate of lime and 27 per cent. carbonate of magnesia, was used than with ordinary limestone of 35 per cent. carbonate of lime, other things being the same.

As a general rule it may be said that the composition of the cinder from a blast furnace working satisfactorily varies between that of an orthosilicate,  $2RO, SiO_2$  or  $2R_2O_3, 3SiO_2$ , in which the oxygen of the bases present is equal to that of the silicon dioxide, and that of a metasilicate,  $RO, SiO_2$  or  $R_2O_3, 3SiO_2$ , in which the oxygen of the bases is one half of that of the silicon dioxide,—the dyad metals being essentially calcium and magnesium, and with certain ores manganese, whilst the triad metals are usually only represented by aluminium. More or less ferrous oxide is, however, invariably present; *ceteris paribus*, the darker the colour of the slag the more iron it contains. When the furnace is working properly the amount of ferrous oxide is small, not exceeding 1 or 2 per cent. of the cinder; but when the reduction of the iron is imperfect, and a "scouring clader" is being produced, the quantity of ferrous oxide present may amount to one-fifth or more of the cinder, representing a very large loss of metal. The following analyses represent the composition of various kinds of limestones and other fluxes employed:—

Calcareous Fluxes.

Character of Flux and Locality...	Mountain Limestone, Skipton.	Durham Limestone, Wear-dale.	Crystal-Isle Limestone, Springfield.	Undried Surrey Chalk.	Oyster Shells from Chesapeake Bay, <sup>1</sup>	Ankerite, London-derry, Nova Scotia.
Analyst .....	Riley.	Abel.	Abel.	Clapham.	Lowthian Bell.	Clapham.
Calcium carbonate .....	98.17	95.55	88.85	78.00	94.48	51.24
Magnesium " .....	1.17	3.20	2.03	trace	0.94	23.28
Ferrous " .....	0.36	trace	1.21	..	..	24.46
Manganese " .....	..	..	trace	..	..	0.98
Alumina .....	..	..	..	0.15	..	..
Ferrie oxide .....	trace	..	..	0.22	0.53	..
Calcium sulphate .....	0.03	..	..	0.24	0.80	..
" phosphate .....	traces	0.12	0.26	0.12	0.06	..
" silicate .....	..	..	..	0.33	..	..
Silica and matters insoluble in acids .....	0.28	0.90	8.15	0.60	2.54	0.04
Organic matter .....	traces	0.23	trace	..	..	..
Water .....	0.13	..	..	20.60	..	..
Soda .....	..	..	..	0.16 <sup>2</sup>	0.85	..
	100.14	100.00	100.60	100.62	100.00	100.00

<sup>1</sup> Used in Baltimore furnaces as flux.

<sup>2</sup> As sodium chloride.

Aluminous and Magnesian Fluxes.

Character of Flux and Locality.....	Bauxites from Baux, France	Bauxite, Belfast.	Pisolithic Alumina, Red Bay, Antrim.	Coal-measure Shale, Lancashire.	Variety of Hornblende used in Sweden as Flux.
Analyst .....	Deville.	Ritchie.	Crossley.	Frankland.	Rammelsberg.
Alumina .....	53.1	30.3	41.30	20.37	21.73
Ferrie oxide .....	3.0	34.9	28.74	71.63	..
Ferrous " .....	..	..	0.78	0.69	4.78
Manganese oxide .....	..	..	trace	..	..
Lime .....	trace	..	1.70	trace	0.09
Magnesia .....	..	..	0.23	trace	0.59
Silica .....	21.7	..	14.65	6.00	61.91
Phosphoric anhydride .....	..	..	0.01	..	..
Sulphuric " .....	..	..	0.01	..	..
Water and organic matter .....	14.0	22.1	13.85	1.15	7.43
Titanic oxide .....	3.2	..	0.30	0.75	..
Calcium carbonate .....	..	12.7	..	..	..
Putash and soda .....	..	..	..	3.41	..
	100.0	100.0	100.97	100.38	99.89

Effects of Calcination of Limestone.—When quicklime, or calcined limestone, is employed instead of raw limestone, a certain diminution in the amount of fuel requisite to run a given quality of pig with a given furnace is noticed, arising from the circumstance that in calcining limestones heat is absorbed, so that when quicklime is used there is a less demand on the heat developed in the furnace than with raw limestone. The saving in this way, however, is rarely equal to the amount of fuel used in the limekiln itself, probably because in the top portion of the furnace the quicklime becomes partially recarbonated by the escaping gases. When the amount of limestone used is large, the carbon dioxide introduced into the furnace in that form is a large fraction of the total carbon dioxide expelled in the escaping gases, and consequently the carbon of the fuel cannot be burnt to so great an advantage as it

would be were less carbon dioxide introduced in the form of flux, since the total amount of dioxide in the escaping gases is limited (see § 20); accordingly, a further saving in fuel might be expected to accrue by calcining the limestone previously, when large amounts of limestone flux are employed. The two sources of saving jointly sometimes considerably exceed the fuel expenditure in the limekiln during the process of burning the lime; thus at Ougrée, near Liège, comparative trials lasting over some three and a half years indicated not only increased production but also a notable saving in fuel when lime was used. Two similar furnaces gave the following results per unit of iron run (A), the results (B) being obtained with the same furnace throughout:—

	Furnace with Quicklime.	Furnace with Raw Limestone.	Saving.
(A) Coke consumed.....	1·465	1·005	0·140
(B) Do. do. ....	1·4725	1·020	0·1475

Analogous results, but not so strongly marked, were obtained by Eck at the Royal Smelting Works, Upper Silesia:—

	Furnace with Quicklime.	Furnace with Raw Limestone.	Saving.
1st Furnace—Coke per unit of iron ...	2·250	2·280	0·050
2d Do. do. do. do. ...	2·1825	2·2725	0·090

1st Furnace—Increase of make by using quicklime, 3·3 per cent.  
2d Do. do. do. do. do. do. 2·4 „

From these results as well as others described by Percy (*Metalurgy*), and by Grüner (*Annales des Mines* [vi.], xx. 525) and others, it would seem that, with certain ores at any rate, a distinct practical advantage attends the use of quicklime instead of raw limestone. On the other hand, Lowthian Bell regards the advantage with Cleveland ores as at least doubtful, his own experiments unmistakably indicating “that the expense of calcining the limestone was unaccompanied by any advantage whatever in the operation” (*Journ. I. and S. Institute*, 1875. 406); similar results have also been observed by others.

As regards the quantity of flux requisite to produce good results, no general statements can be made, the proportion being highly variable with circumstances, and especially with the nature of the ore. Thus, with Cleveland ironstone containing after calcination some 40 per cent. of iron, about 11 cwt. of limestone are usually requisite per ton of pig iron, or about 22 per cent. of the weight of “mine” used. Much larger quantities have been employed at various Continental works using poor ores with much earthy matter, up to 20 cwt. and more per ton of iron; on the other hand, some of the Swedish ores require no flux at all, and Lake Superior ores often do not require more than some 2 cwt. of limestone per ton. When it is practicable to mix aluminous, calcareous, and silicious ores together, the amount of flux otherwise requisite may be largely reduced; but the conditions governing the amount and nature of flux to be used are too variable to be briefly generalized.

12. *Construction of Blast Furnaces.*—Intermediately between the comparatively open hearths of the Catalan forge and analogous early arrangements for the direct production of iron from its ores (§ 29) and the completely closed-in blast furnaces of gigantic dimensions in use at the present day, may be classed the smaller closed-in blast furnaces used amongst various nations, the products of which were either something approaching to malleable iron, more or less carbonized and imperfectly fused, a fused or semi-fused steel, or a completely melted more highly carbonized cast iron, according to circumstances. Of this intermediate class of furnace the “Stückofen,” or high bloomery furnace, formerly considerably used on the Continent, may be taken as a type. By increasing the amount of fuel relatively to the ore smelted, a completely fluxed cast iron resulted, run out as in the ordinary modern blast furnace through a tapping hole; with less fuel, *i.e.*, increased “burden,” the product approximated more to the pasty mass produced in the Catalan forge, being extracted as a ball through a much larger opening in the hearth than was necessary for simple tapping; in this latter mode of working the cinder was usually allowed to escape *pari passu* with its formation so as not to allow the mass of reduced metal to be covered and protected from the oxidizing action of the blast, otherwise a too highly carbonized metal resulted. Essentially the Stückofen was a brickwork tower of some 10 to 15 feet in height, the inner cavity being shaped like

two truncated cones placed base to base; in short differing from the ordinary blast furnaces for producing cast iron in little but dimensions. As far back as 1841 these appliances were stated by Karsten to have been entirely abandoned in Carinthia, Carniola, and Styria (where formerly they were largely employed), on account of their large consumption of fuel; at that period they were still in use to a small extent in Hungary and near Henneberg in Germany. The “Osmund” furnace, formerly in use in Sweden for converting bog iron ores into malleable iron, was essentially a Catalan forge with the sides built up to a height of several feet so as to constitute a small blast furnace entirely closed in save at the top.

The modern blast furnaces for pig iron production in use in different districts vary considerably in the details of their construction. The changes that have been introduced during the last half century are mainly in the direction of increased size, which up to a certain point has been found advantageous so far as the consumption of fuel is concerned, at any rate with certain classes of ore. Thus about 1830 the largest furnaces in use in Great Britain were usually but little upwards of 40 feet in height, with a capacity of 4000 to 5000 cubic feet, and were often much smaller; about 1864 Vaughan of Middlesborough built a much larger one, 75 feet high; at the present day furnaces of 80, 90, and even upwards of 100 feet in height and of 20,000 to 40,000 cubic feet capacity are in use in certain localities, some of the largest being those at Ferryhill and Ormesby in the Middlesborough district, furnaces of 103½ feet in height and 33,000 cubic feet capacity, and of 90 feet in height and 40,000 cubic feet capacity, having been built at these places respectively. The researches of Lowthian Bell on blast furnaces smelting Cleveland ironstone, and the practical experience of iron smelters using this ore alone, or mixed with hæmatite, coincide in indicating that, whilst a considerable saving in fuel consumed (several cwt.) per ton of iron of given quality made at a given rate of working from a given class of ore and flux accompanies the increase in dimensions from 40 or 50 feet in height and 5000 or 6000 cubic feet capacity up to about 80 feet in height and some 12,000 cubic feet capacity, the economical effect of increasing the dimensions beyond these limits is not marked, although, according to Bell, a further increase in capacity up to some 15,000 or 16,000 cubic feet (without increase of height beyond 80 feet) appears on the whole to tend to increase of regularity during working. On the other hand, when a very hard coke (such as that specially made in Durham and Northumberland for the purpose) is not obtainable as fuel, or when very friable ores are employed, the extra weight of material in a very high furnace so crushes and pulverizes the ore and fuel as seriously to interfere with the working; so that with charcoal or soft anthracite or other coal as fuel, or with ores which either at first or when partially reduced have but little coherence, the disadvantages of increasing the size of the furnace beyond certain limits outweigh the benefit derived from the saving of fuel. Accordingly the 80 feet furnaces and upwards of the Cleveland district are but little used out of England; the furnaces employed in the North Lancashire and Whitehaven districts, where hæmatite mainly is smelted, are usually 60 to 70 feet in height, and those in use in the United States for similar ores rarely exceed 55 to 65 or 70 feet in height, with a maximum width of 15 or 16 feet at the boshes, and are often only from 40 to 50 feet in height; whilst furnaces very much smaller than these are in use both in America and on the Continent where charcoal iron is made; thus at Vordernberg in Styria furnaces of only some 28 feet in height, 6 feet greatest internal diameter, and 450 cubic feet capacity were in use a few years ago and probably are still, whilst in various places



in Sweden, Norway, and Lapland furnaces of 30 to 40 feet in height and 1000 to 2000 cubic feet capacity are employed. Of late years, however, large furnaces have been built in Sweden of 50 to 60 feet in height, especially for Bessemer pig smelting.

The internal shape of the blast furnaces in general use is somewhat variable. Those of the older construction may be described as being made up of two truncated cones placed base to base, the greatest diameter (the *boshes*) being about one-third way up; those of more recent construction exhibit much less angle at the boshes, and are internally shaped more like a barrel, or like an inverted soda water bottle with most of the neck and the conical bottom cut off. Fig. 8 illustrates the alterations in size and shape that have

taken place in the blast furnaces of the Cleveland district during the last thirty years or so (abridged from a paper by J. Giers, *Journal Iron and Steel Institute*, 1871, ii. 202). Similar alterations in dimensions and shape of furnaces have taken place in other localities. The smaller furnaces of 30 to 35 or 40 feet in height have mostly been replaced (when worn out) by larger and higher ones, the angles of the internal cavities of the older shapes being rounded off.

Fig. 9 illustrates the section and ground plan of one of the older form of open-mouthed furnaces used at Dowlais (Truran), consisting of a heavy mass of masonry, square at base, strongly braced together with iron tie-rods, rising in the shape of a truncated pyramid to the height of the boshes, and then surmounted with a conical top surrounded at the throat by a gallery for the introduction

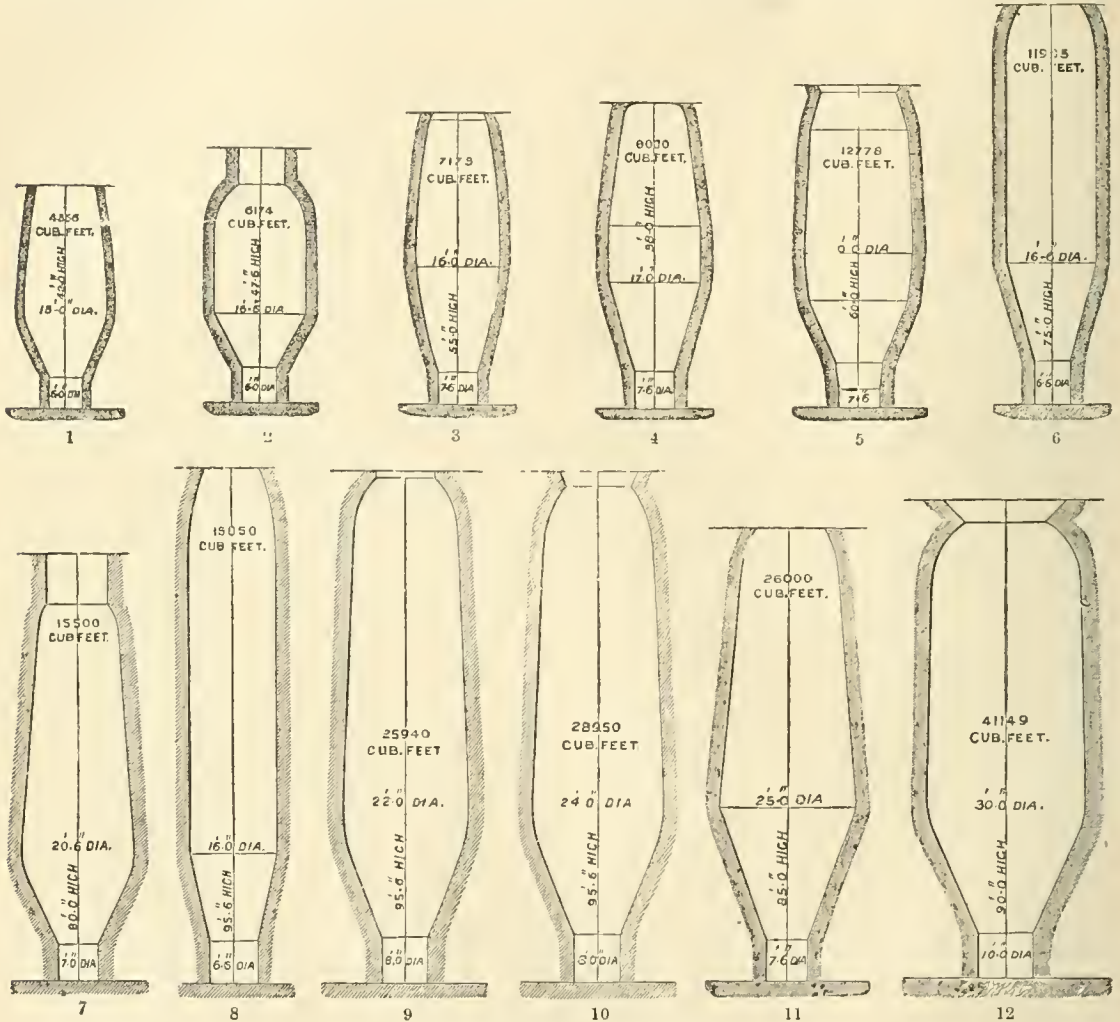

FIG. 8.—Different Forms of Blast Furnaces.

of the charging materials. In the square base were four arched recesses or *tuyere houses*, one on each side, F, F, for the introduction of the blast through blowing holes by means of *tuyeres*, the front recess G also serving for the removal of cinder and the tapping of the furnace for the running of the pig. The lowest portion of the hearth or *crucible*, A, was constructed of refractory sandstone, grit, or conglomerate, or of difficultly fusible firebrick, the inner portion of the upper part of the furnace being also built of firebrick set in fireclay with an air course between the double lining thus constructed; exteriorly the furnace was built of less expensive and refractory materials, usually of stone, strongly bound round with iron hoops. Above the charging gallery D a slighter brickwork continuation of the internal cavity arose, E, termed the *tunnel head*, in which door-holes, closed with movable iron doors, were perforated for the introduction of the charge. At the level of the boshes BB or thereabouts, the

pyramidal base was finished off exteriorly with a cap or coping, the conical shaft C rising upwards therefrom. Fig. 10 represents a somewhat later form, chiefly differing from the former in that the base is circular instead of square, the whole forming a truncated cone into which the tuyere houses A, A, A, B are sunk, the *cinder notch* and *tapping hole* for the outflow respectively of the cinder and pig iron being in the tuyere house B, towards which the walls of the hearth and crucible are cut away; the outer portion of this form of furnace consisted of a shell of boiler plate rivetted together, and the masonry was considerably less massive than that of the older form. The more modern furnaces (such as fig. 11) are constructed like this, but the masonry at the base is still less massive, so that, instead of there being four distinct tuyere houses, the separating walls of the houses are wholly cut away and replaced by a number of stout iron pillars on which rests the greater portion of

the weight of the superstructure ; through the walls of the hearth are pierced conical arched openings for the tuyeres ; the throat is fitted with a valve for introducing materials from time to time, such as the cup and cone arrangement (see § 18). Just below the cup a perforation through the furnace wall allows the gases to pass out into a down flue of rivetted boiler plate through which the gases pass (when the cone is in its normal raised position) to the boiler fires, blast superheaters, &c.; in order to prevent the fire being extinguished when the cone is lowered, a small coal fire is kept burning under the boilers, &c., unless the temperature of the fireplace is sufficiently high to relight the gases when the cone is again raised. Even at the present day, however, many furnaces are in use of the open-mouthed class, the escaping gases simply passing into the air through the tunnel head as a mass of roaring flame, unless the temperature is too low to enable them to ignite spontaneously, in which case they escape without flame except when accidentally or intentionally lit.

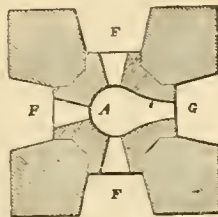
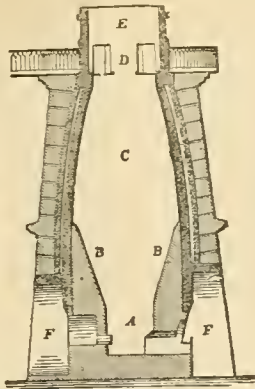

Fig. 9.

The precise angle made at the boshes between the lower and upper portions of the inner furnace wall is a matter of some moment. If the hearth slopes too gently, the fall of the materials downwards as the reduced metal and cinder melt is apt to be retarded, and "scaffolding" to be produced. Modern furnaces usually have the walls of the hearth more nearly vertical than the older ones, whilst the shaft instead of being conical from the boshes upwards is often cylindrical for some considerable distance, then gradually closing in barrel-wise towards the throat; the tuyeres also are often more than four, especially in the larger furnaces. In some of the furnaces in use some twenty years ago and upwards, the hearth was originally built square in plan, like the still older ones of half a century back and more; but observation of the fact that the hearth of blown-out furnaces was always corroded or fused away to an irregular circular outline, and that the same kind of effect was also produced in the inner lining of the boshes and shaft where an angle originally existed, led to the gradual substitution of inner cavities shaped in the first instance as much as possible like the ultimate shape to which the furnace became corroded.

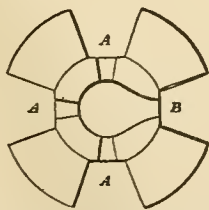

Fig. 10.

In building a blast furnace, the "stack" or upper portion is usually constructed first on its supporting columns, the hearth and its outer casing being built in subsequently. The firebrick used for the purpose should be as free as possible from iron, otherwise it is

apt to be disintegrated by the reducing action of carbon oxide on the ferruginous matter, a continual reduction of iron and reoxidation of the metal with deposition of carbon being produced in virtue of the reactions described in § 19, equations (3) and (4); according to Pattinson's observations (*Journ. I. and S. Inst.*, 1876, 101) this action has in several instances caused considerable injury when iron was present to a notable extent (3 or 4 per cent.). In Austria and Hungary steatite is often used for lining the charcoal furnaces in use there; serpentine has also been employed, but is not so advantageous on account of the difficulty in obtaining it of uniform texture and sufficient compactness; it does not wear so well as good firebrick. The hearth and foundations frequently require to be specially prepared, consisting of a large mass of concrete, broken stone, &c., with air courses interspersed; above this is the *hearth bottom*, formerly made of one or more large slabs of sandstone or grit, but with the modern large furnaces of masses of firebrick or sandstone laid inverted dome-wise, or like the under portion of a barrel drain, to diminish the tendency to undermining and forcing upwards by the molten metal

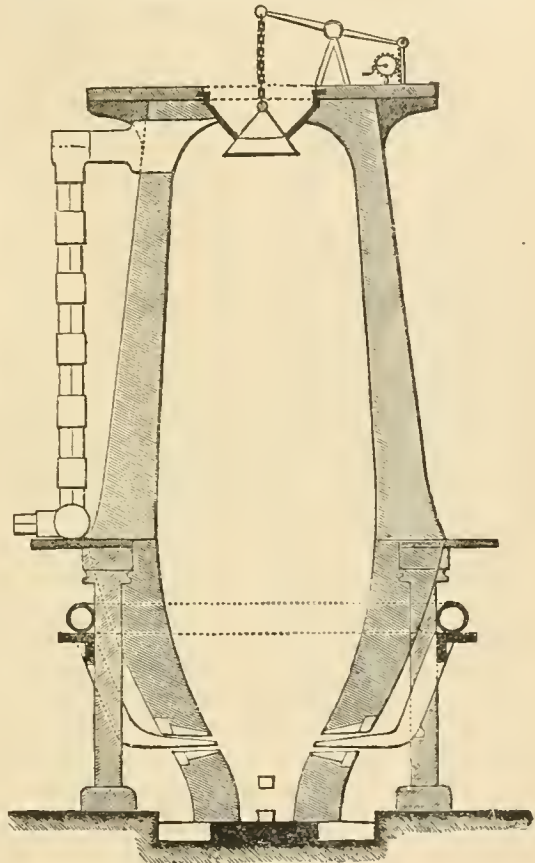

Fig. 11.

and slag. The crucible and hearth are then constructed of as great thickness and as infusible material as convenient, so as to increase the time requisite before renewal is necessary, owing to the solvent action continually being exerted by the cinder, especially when the furnace is working irregularly and forming a slag containing much unreduced iron (*scouring cinder*) which attacks the hearth lining powerfully. The tuyere holes are built in as conical perforations through the hearth wall at a level of some few feet above the bottom, — the front tuyere hole being made into an arched recess (like the old "tuyere house," but on a smaller scale) reaching from the bottom to a level of 2 or 3 feet above the other tuyeres; the *tymp arch* usually projects a little forward from the earth wall, constituting the "fore hearth," at the base of the front of which is the *dam*, a block of stone or mass of firebrick pierced by a vertical cavity (*tapping hole*), the bottom of which is on a level with the base of the hearth, and through which the molten pig iron is drawn off from time to time, the liquid metal being dammed back by ramming a mixture of clay and sand or small coal into the hole when the furnace is not being tapped, and the stopping being withdrawn by hammering with a pointed crowbar when all is ready for tapping. The top of the *dam*



is nearly on a level with the tuyeres, and has a groove (*cinder notch*) cut in it forming a channel through which the cinder continuously flows out when the iron and cinder have risen to a level with the top of the dam since the last tapping; occasionally the top of the dam is raised to a somewhat higher level than the tuyeres, when it consequently results that the blast is blown in *through* and not *over* the liquid cinder. The space between the dam and the top of the tympan arch is filled up with brickwork, or with clay and sand, &c., with the exception of the cinder channel terminating in the cinder notch; when the furnace has been tapped and the level of the cinder has sunk below the notch, this cavity is temporarily stopped until the cinder level rises again, to prevent the blast issuing from the hole. In order to prevent wearing away of the dam, water cooling arrangements are sometimes applied analogous to those used for the hot-blast tuyere (§ 15); various arrangements of this kind are in use, notably Lürman's.

On the Continent the older massive round or square-based class of furnace (of variable dimensions in different localities) is still employed to a considerable extent. In some of the smaller-sized furnaces, such as those in use in Sweden and Finland, the heavy external masonry is replaced by a log casing, prevented from heating by a jacket of earth and rock between it and the furnace casing proper. When the furnaces are only in blast at certain seasons (being blown out during the rest of the year), holes for the escape of moisture from the interior brickwork or stonework on relighting are usually provided. The hearth is constructed of a mixture of fireclay and crushed quartz or old used fireclay moulded whilst soft into shape by being rammed in between the outer casing and a wooden internal mould and carefully dried gradually before use. Rchette's furnace (fig. 12),<sup>1</sup> adopted at Nijne Tagilsk and

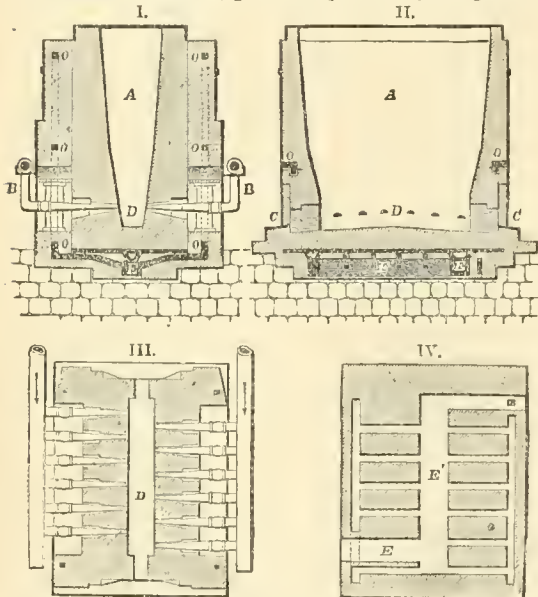

FIG. 12.—Rchette's Furnace. I. Cross section. II. Longitudinal section. III. Plan at tuyere level. IV. Plan of air courses below the hearth.

elsewhere in the Urals, at Mulheim on the Rhine, and in a modified form in certain copper smelting works, differs considerably in shape from the ordinary English form; the shaft A is an inverted four-sided pyramid, the throat being the widest part of all, about 7 feet wide and 18 long; towards the hearth D the width diminishes to 2.75 feet, the total height being about 30 feet. At each end of the oblong hearth is a slag-hole and a tapping hole, C, C. The tuyeres B, B are some dozen in number, arranged in two ranks opposite to one another, each tuyere on one side being midway between the axes of two adjacent tuyeres of the opposite side. In order to keep the walls cool air courses E, E are built under the hearth and others O, O, O in the walls of the shaft, all communicating with one another; when the furnace is being blown in these also serve to heat up the walls and dry them, fuel being placed in the lowest and largest air space E and fired. The chief advantages claimed for this form of furnace are that its small height and comparatively slight construction render it far less costly to build than more massive furnaces; that the ascending current of gases must slacken in vertical

speed as it reaches the wider uppermost portion, and must consequently be more efficacious in reducing the ore than in furnaces the shafts of which taper the other way at top, so that the yield of iron relatively to the cubic capacity is larger; and that when first built it can be blown in much sooner than ordinary furnaces owing to the air courses. The yield of one of the Ural furnaces, when smelting a rich magnetic ore furnishing 67 per cent. of grey pig with charcoal and cold blast, was from three to three and a half times that of the old type of furnace (measured for equal cubic capacity), the consumption of fuel being from 10 to 15 per cent. less (Stölzel).

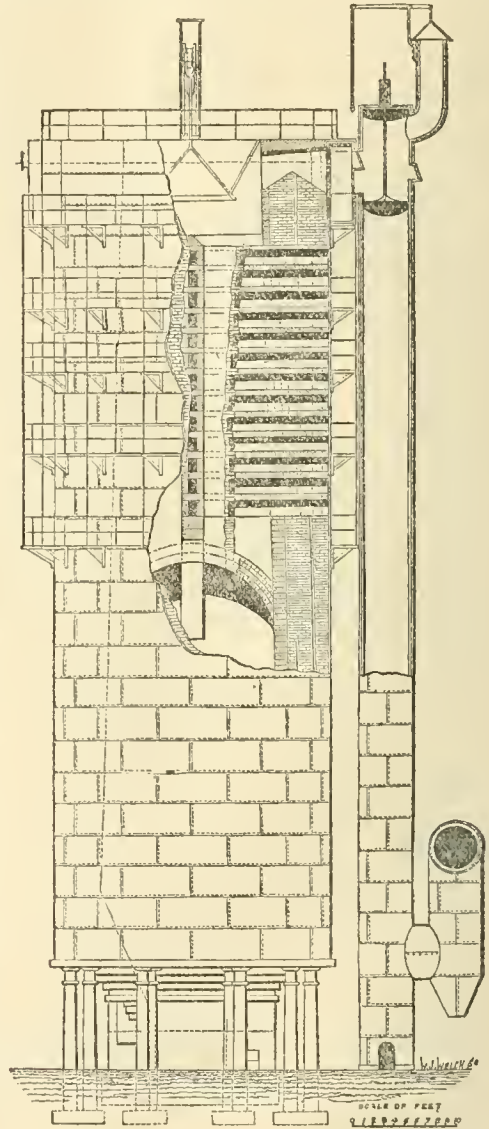

FIG. 13.—Ferrie's Furnace.

A peculiar furnace, known as Ferrie's self-coking furnace, after the name of its inventor, in which raw coal is employed, has been used at the Monkland Iron Works and elsewhere during the last few years. On the top of an ordinary furnace of about 53 feet in height and 7000 cubic feet capacity were erected four chambers or retorts about 20 feet in depth, each having a capacity of 500 cubic feet; external flues, in which a portion of the waste gases were burnt, served to heat these chambers in such a way as to coke the raw coal, the temperature of the flues being about 800° to 900° C. Fig. 13, taken from the *Journal Iron*

<sup>1</sup> Taken from Bolley's *Handbuch der Chemischen Technologie* vol. ii., part ii., by Dr C. Stölzel.

and *Steel Institute*, 1871, i. p. 433, illustrates the arrangement. That part of the gas not consumed in the coking regiment flues is led off by the usual bell and cone arrangement.

Before these chambers were erected the quantity of raw coal requisite to make a ton of pig from the Lanarkshire ironstone averaged about 52.5 cwt.; the addition of the coking chambers reduced the amount of coal to 33.5 cwt., producing a saving of 19 cwt. of raw coal, equivalent to upwards of 12 cwt. of coke per ton of iron. According to Lowthian Bell this result is largely due to the increase in the height of the furnace produced by the addition of the coking chambers; i. e., a large proportion of the saving (estimated by Bell at about one half) would have been brought about by an increase in furnace height, even though the upper part were not specially heated by the combustion of waste gases, the balance being due, first, to the avoidance of a large portion of the heat absorption during the coking of the coal that would otherwise have taken place at the expense of the heat developed by chemical changes in the upper part of the furnace, owing to the supply of heat from the combustion of waste gases in the external flues, and, secondly, to the modifying action of the hydrocarbons developed on the chemical changes themselves, the direction of the modification being that of increased rate of reduction of iron oxide. In any case, the consumption of fuel is by no means inferior to that which with the most advantageous conditions will suffice to smelt a given iron ore (§ 21). For further details see *Journal Iron and Steel Institute*, loc. cit., and 1871, ii. 228. A modification of this furnace has been tried, in which the coking chambers at the top are connected with condensers for collection of tar and ammoniacal liquor; the fuel only is placed in these chambers, the mice and flux being introduced at their base.

*Double Rows of Tuyeres.*—Experiments have been made, notably at Pittsburg, U.S., on furnaces with two sets of tuyeres, one row at a lesser height above the sole than that of the other row, both rows used simultaneously; the general effect has been found to be the reverse of advantageous. It is, however, frequently convenient to have two or more tuyeres symmetrically disposed round the furnace at a somewhat higher level than those ordinarily used, the higher series being employed, not in the ordinary working of the furnace, but only in case of certain derangements of working such as scaffolding, &c.; accordingly several furnaces of recent construction, especially in America, have been thus fitted with "auxiliary tuyeres," at 16 to 18 inches level above the others, ready for use when occasion needs. In certain cases when scaffolding had taken place to such an extent that the furnace did not give any fused matter at all at the hearth, and it was probable that it would have to be put out of blast and partly rebuilt, proper working has been brought about and the obstruction removed by what was thought when first practised to be a desperate remedy, viz., cutting holes in the shaft at some elevation (15–20 feet) above the tuyeres and introducing by means of temporary tuyeres blast at the orifices thus formed, so as to flux away the obstructing matter. In certain American works scaffolds have been melted away by introducing a little above the tuyere a pipe communicating with a barrel of petroleum, so as to create an intense local heat by the combustion of the petroleum allowed to run in in a gentle stream.

13. *Hoists and Lifts.*—Except when the natural variations in the level of the ground permit of the materials being drawn in waggons or trucks to the top of the furnace directly, lifts of various kinds are employed to raise them. "Water lifts" consist of a pair of chambers or cages working in guides suspended to the two ends of a chain passing over a pulley, and provided with water boxes, so that a stream of water from a tank or reservoir at a higher elevation can be directed into the uppermost waterbox, rendering that heavier than the other, when the weighted cage descends with the empty trucks drawing up the other one with the trucks laden with materials, the rate of descent being regulated by a brake. In frosty weather lifts of this kind are apt to become impracticable. Hydraulic lifts are sometimes used, consisting of a similar chamber suspended from a chain passing over multiplying pulley blocks and attached to the piston of a hydraulic ram, so that when the ram makes a stroke the chain draws up the cage; if the blocks multiply tenfold a stroke of 7 feet of the ram draws up the cage 70 feet. At the Bethlehem Works, U.S., an hydraulic hoist is employed in which the relatively short stroke of the ram is made to raise the cage through a much greater height by making the ram actuate an axle by means of a rack and pinion, a large wheel being fixed

on the axle over which the cage rope passes. Besides these lifts, an inclined plane and stationary engine, or a vertical lift like a colliery winding engine, is sometimes employed. Pneumatic lifts of various kinds are also in use, one consisting of a tall bell immersed in a water tank like an exaggerated thin gasometer; the bell is attached to the cage (underneath it) and also to a chain passing over a pulley to a counterpoise, the weight being so arranged that the bell, when not containing air under pressure, together with the cage and empty trolley, is heavier than the counterpoise, and sinks when a valve is opened, so that the internal air pressure becomes atmospheric; whilst on closing the valve and forcing air in, the water inside the bell is partially displaced, and the bell and cage, being relatively lighter, rise like an ordinary gasometer. Gjers's pneumatic lift is a piston box, such that, the air being exhausted or compressed under the piston which is connected with the cage, a motion up or down as the case may be is brought about. Fig. 14, taken from a paper by Gjers in the *Journal Iron and Steel Institute*, 1871, ii. 209, illustrates the mode of action; the cylinder is about 36 inches diameter, the piston being connected with the travelling platform (through the centre of which the cylinder passes freely) by four wire ropes passing over pulleys overhead; the platform runs along guides bolted to the cylinder. The platform and empty barrows being at the top, air at about 2 lb pressure per square inch is forced into the cylinder underneath the piston, which suffices to make it ascend, and consequently to cause the table to descend; when barrows full of mine, coke, &c., are wheeled on to the platform, the air is sucked out from underneath the piston so as to make a vacuum of about 4 lb (i. e., the pressure is reduced from 14 to 10 lb per square inch) with heavy loads, and proportionately less with lighter ones, when the atmospheric pressure now forces the piston down and draws the cage up. The strain on the ropes is thus diminished, whilst the objection to water lifts of being unworkable in frosty weather is entirely done away with. For heavier weights two larger cylinders are employed, working conjointly with the cage or platform between them.

14. *Production of Blast.*—The earliest blowing machines were made of goats' skins, inflated by hand by pulling cords, and compressed either by standing on them or by a weight or a bent bamboo acting as a spring, &c.; such rude arrangements are still in use amongst certain Eastern nations; a kind of rudimentary cylinder blowing machine is also employed in certain districts, consisting of a hollowed log with a piston packed with feathers, leaves, &c. About the middle of the 17th century the trompe appears to have been first invented, probably in Italy. The action of this arrangement depends on the suction of air into a stream of falling water running from a tank by an orifice not too far from the surface of the water, just as occurs on pulling out the plug of an ordinary lavatory basin so as to discharge the water therein; the air carried down by the water is discharged into a chamber with an outlet at bottom for the water and one at top for the air, so that as long as the stream of water is kept up a continuous air current passes out of the air hole, the force of which is regulated by a plug-valve attached to a lever and cord, so that the furnaceman can at will diminish or increase the amount of falling water. In practice the trompe only utilizes a small fraction of the power of the descending water. It is of course inapplicable in cold climates during frost; a serious disadvantage too is the fact that much fine spray accompanies the blast and interferes with the production of heat thereby. With a fall of 20 to 30 feet a well-proportioned trompe will deliver a sufficient air supply for a Catalan forge at a pressure of about 9 or 10 centimetres of mercury (about  $\frac{1}{8}$  atmosphere = nearly 2 lb per square inch).



The blowing engines in ordinary use in England are worked by steam, but in other countries, *e.g.*, Sweden, where water-power is available, this is frequently utilized. In principle cylinder blowing machines are precisely like inverted steam engines, the air taking the place of the steam; the single-acting machines are the reciprocal analogues of the atmospheric engine (saving of course in the means by which the return stroke is effected), whilst the double-acting machines are high-pressure steam engines inverted. In clack valve machines the motion of the piston in one direction causes a diminished pressure behind it, and consequently air rushes in through the intake valve at that end, whilst the compression of the air in front of it opens the outlet valve of the other end and causes the air to escape; on the return motion this outlet valve is closed and the intake valve of the same end opened, whilst the intake valve of the other end is closed and the outlet valve opened. In "slide valve" machines the moving clack valves are replaced by aliders connected with the piston rod by means of an eccentric on the shaft driving it, so that, when the piston begins to make its stroke, the appropriate valves are closed or unclosed as the case may be. In order to equalize the intermittent blast thus produced, a regulator is sometimes interposed between the blowing cylinder and the furnace, consisting of a reservoir or chamber of considerable size which acts in much the same way as the air chamber of an ordinary force pump, the whole mass of air becoming somewhat compressed when air is blown in, and the expansion during the momentary cessation of the supply keeping up a sufficiently equable stream of air issuing from the reservoir until the next cylinderful of air is blown in. To economize space, a piston box with a piston loaded with weights, or a loaded gasometer in a water tank, may be substituted for the reservoir; the latter expedient is objectionable, causing the air to be saturated with moisture. If the furnace is at some distance from the blowing engine, the large mass of air in the blast main and superheaters serves to render uniform the current supplied to the furnace without any other regulator being requisite.

15. *Hotblast Stoves.* — The oldest form of blast heating apparatus, applied by Neilson, consisted of a tubular rivetted boiler plate heating vessel (*h, h*, fig. 15), mounted in a brick chamber OOOO, and heated by a fire underneath fed through the door D, the waste gases from the fire passing out at the far end to the chimney. Crescent-shaped partitions *p, p, p* inside the heater caused the current of air from the blowing engine which entered at B to take a serpentine course as indicated

16), consisting of two parallel tubes L, L running along the base of the stove above the firebars *d, d*, communicating the

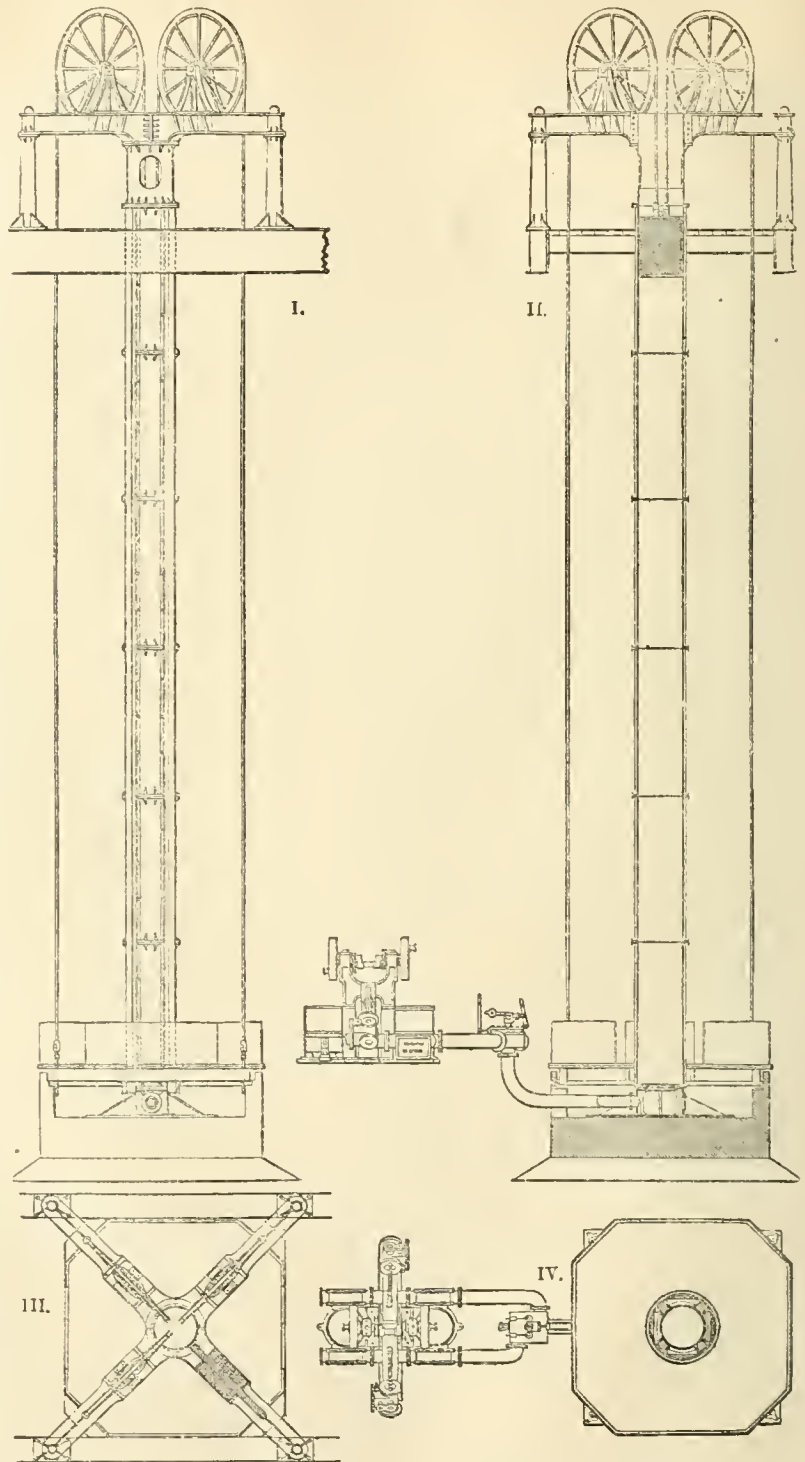

FIG. 14.—Gjers's Furnace Hoist. I. Section. II. Elevation. III. and IV. Plans.

by the arrows, finally passing off at S to the furnace. This one with the other by a series of inverted U or horse-shoe shaped tubes; the blast being introduced into the cold was speedily superseded by the

main *Bb*, the air passes over into the hot main *S* through the curved tubes *h, h*, becoming heated in so doing, the flames from the fire *Dd* enveloping the horse-shoe tubes and then passing by the flue *f* to the chimney *C*. Many modifications of this stove have been introduced, several of which are still in use: thus in some the air is compelled to pass alternately from a portion of the one main to the other

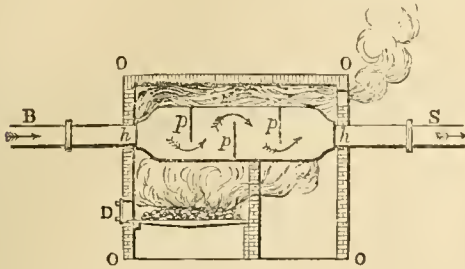

Fig. 15.

and *vice versa* several times so as to be more completely heated, passing through several horse-shoes before emerging; the horse-shoes are sometimes altered into inverted V's, and made rectangular or flatly elliptical in section instead of circular so as to expose greater heating surface. To avoid the liability to fracture through unequal expansion, the U's are sometimes made of two parallel vertical tubes united by

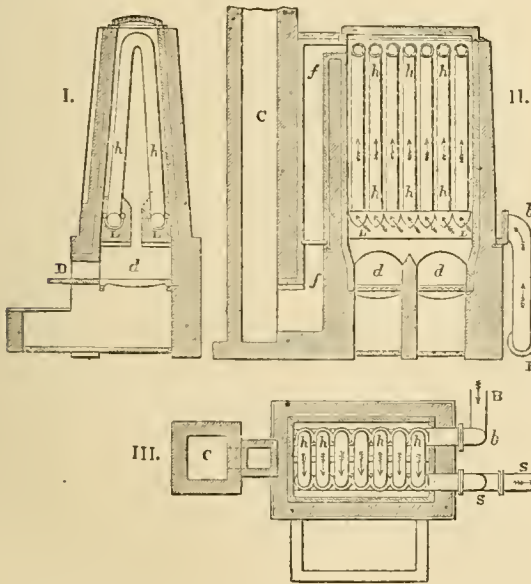

FIG. 16.—Calder Pipe Stove. I. End Elevation. II. Elevation. III. Plan.

a horizontal connecting tube socketed into each, just as each vertical tube is socketed into the main (fig. 17). The "pistol pipe" stove, still largely used (fig. 18), chiefly differs from this in having the limbs of the U tube closely adjacent, so as to consist in fact of a single tube with a partition *D* in the centre, the cold air passing up one side of the partition and down the other so as to become heated in passing; to accommodate the pipe to an arched roof, the upper end is bent inwards, thus giving the form of a pistol stock and barrel to the double pipe, two ranks of pipes facing one another being built in the same stove. Another modification of the older tubular superheater consisted of a serpentine or coil of piping made of cast iron pipes bent into half circles and socketed together, so as to form a continuous

worm tube which was mounted inside a brickwork stove and heated by a fire in much the same way as the Calder pipe stove. The "Wasserralfingen superheater" consists of a kind of serpentine of which the curved parts lie outside

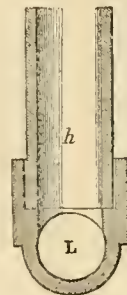

Fig. 17.

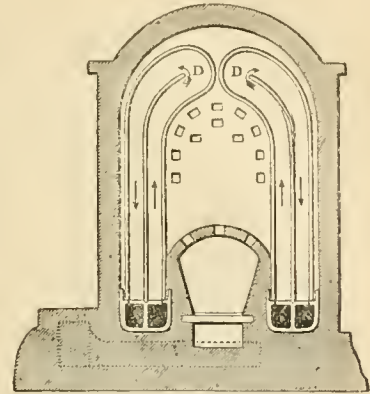

FIG. 18. Pistol Pipe Stove.

the stove, only straight tubes being exposed to heat. The "Blaina oven" differs from this chiefly in the serpentine being vertical instead of horizontal, and in the whole of the serpentine (the curved ends inclusive) being exposed to the heating flame.

The substitution of the waste gases from the blast furnaces as fuel for the coal or coke-fired fireplaces originally used for these and various other forms of superheater not only works advantageously in saving the fuel that would otherwise be requisite, but also keeps up a more regular heating effect, and diminishes the liability to breakage through unequal expansion, &c. All these forms of superheater, however, are open to the same objection, viz., that it is impracticable to heat the blast continuously by means of them to a higher temperature than about 450° C., otherwise the iron pipes get speedily burnt away. In order to obtain a higher temperature, the principle of the Siemens regenerative furnace is employed in the Siemens-Cowper stove, the flame from the combustion of the waste gases from the blast furnaces being made to traverse piles or stacks of brickwork loosely heaped together or regularly laid so as to heat up the brickwork, the products of combustion finally passing off to the chimney at a comparatively low temperature. After the lapse of a certain time the flame is shut off, and the cold air blast made to traverse the heated brickwork in the reverse direction, entering at the cooler chimney end, and leaving at the hottest point near where the furnace gases and the air to burn them originally entered; two such regenerators are used together alternately, the flame heating up one whilst the blast is being heated in the other, and *vice versa*, the shifting of the blast and furnace gases from the one to the other being accomplished by opening and shutting suitable valves. Owing to the presence of dust in the blast furnace gases, the cavities between the piled bricks are apt to become filled up with deposit; to remedy this inconvenience in the "Whitwell stove" the piles of brickwork are replaced by a series of parallel firebrick walls about 9 inches apart, each wall being perforated by arched openings at the top and bottom respectively in each alternate wall, so that the flame passes alternately up and down between each wall and the adjacent one, thus heating up the surfaces of the walls (figs. 19, 20). By means of manholes at the top and sides scrapers can be introduced from time to time, and the deposit of flue dust scraped off the walls and removed from the stove without rendering it necessary to take down the internal brickwork at all. With regenerative stoves of this description worked in pairs it is easy to obtain a continuous blast at a temperature of 750° to 800° C.

*Determination of Temperature of Blast.*—A rough and ready method often employed is to take out a plug from the blast main, or "gooseneck," supplying the tuyere, and to hold in the issuing stream of hot air a rod of zinc or other test metal for a determinate time, noting how long it takes to melt its end. More accurate methods consist in the use of specially constructed pyrometers. Certain forms containing a compound silver and platinum spiral, working on much the same principle as that of Breguet's thermometer, and others in which the expansion of a bar of metal moves an index by means of multiplying wheels or levers, although useful for comparatively low temperatures (below 500° C.), are out of the question for intensely heated blasts; in such cases two forms of pyrometer invented by Siemens are applicable. One of these is an adaptation of the method employed by Pouillet for determining



high temperatures, consisting of a calorimeter into which a heated ball of platinum is dropped; the rise in temperature of the water being noted, the amount of heat lost by the platinum, and consequently its initial temperature, is known. The calorimeter in

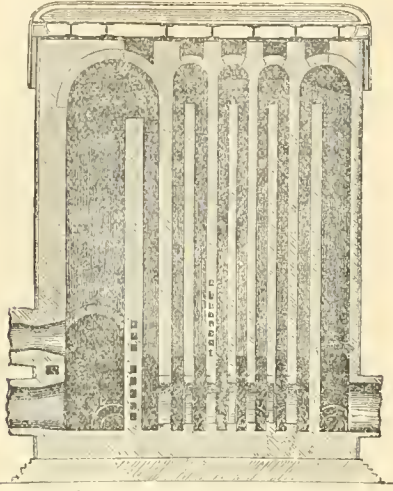

FIG. 19.—Whitwell Stove—Vertical Section.

Siemens's instrument (fig. 21) is a copper cylinder jacketed outside with a double jacket, the inner portion of which is an air space and the outer a concentric layer of hair so as to diminish errors due

to radiation and atmospheric action; this is provided with a thermometer, the bulb of which is protected by a copper gauze covering, fixed in a groove in the wall of the innermost vessel; a sliding scale is attached, so constructed as to indicate at sight the temperature of the ball dropped in when the zero of the scale is adjusted to the temperature of the calorimeter before starting as indicated by the height of the thermometric mercurial column, and the level of the mercury subsequently read off on the scale in that position after the ball has been dropped in,—the size of the ball and the quantity

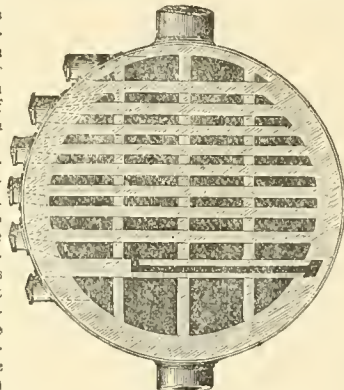

FIG. 20.—Whitwell Stove—Horizontal Section.

of water in the instrument being duly proportioned to one another. The "ball" is a cylinder of copper with a perforation in the axis, so that it can be lifted up on a pointed rod and introduced through a small opening into the blast main, &c., to be examined; after a few minutes, when the ball has attained to the temperature of the blast, it is quickly withdrawn and dropped into the copper calorimeter previously filled up to a mark with water, which is well stirred up before setting the movable scale and subsequently after the ball is dropped in, so as to equalize the temperature. Usually the calorimeter holds a pint of water, the copper being of such a weight that its thermal capacity is equal to  $\frac{1}{5}$  of a pint of water. With an instrument that has been "calibrated" (i.e., the error of each scale indication determined by previous experiments at accurately measured temperatures), the writer's experience is that very concordant and accurate results may be obtained by an expert operator working in precisely the same way as that employed in the calibration of the instrument, but that very considerable errors are apt to be introduced if the instruments as sold are employed without such corrections being made, and if the times which elapse during the withdrawal of the heated ball from the blast main and its dropping into the water are at all unequal, so that different amounts of heat are lost by atmospheric cooling before the ball reaches the water. Moreover, with use the balls become lighter, and the temperature indicated is then too low.

The other Siemens pyrometer depends on the alteration of the electrical resistance of a platinum wire when heated. The current from a suitable battery is divided into two branches, one of which

passes through the experimental wire and the other through a counterbalancing resistance consisting of another wire which is not heated, the two branches again meeting in one conducting wire which completes the circuit. If the two counterbalancing wires are at the same temperature, equal amounts of current will flow through each branch, the resistance of the conductors, &c., in each branch other than the two wires being equal; but if one wire be hotter, less current will flow through that branch as compared with the other in proportion as the temperature is more elevated. By determining electrically the difference between the amounts of current in the two branches, a means is afforded of calculating the temperature to which the hotter wire has been raised. In the newest form of instrument (fig. 22) a pair of ingeniously constructed voltmeters is employed as the current-difference measurer, one being in each branch of the compound circuit, so that by reading off the volumes of gas evolved in the two, and referring to specially constructed tables, the temperature of the heated wire is at once known. In order to apply this to the measurement of the temperature of blast mains, furnaces, &c., the wire to be heated is wound spirally upon a porcelain cylinder, which is then enclosed in a protecting iron tube; the ends of the platinum wire are connected with thick copper leading wires insulated by kaolin, &c., at the hot part of the tube, and by ordinary gutta percha, &c., at the other end. An equal amount of the same copper

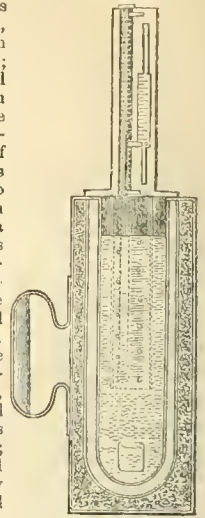

Fig. 21.

wire is included in the second branch, usually by carrying three wires through the hollow iron tube,—one to convey the current before branching (the division taking place near the heated end), the other to convey the current through the branch containing the heated wire, and the third for the current in the other branch to pass through; in this way errors through the unequal length and heating of the copper conductors in the two branches are avoided. Very accurate measurements are obtainable with instruments of this class when newly arranged; but it is not always certain that the resistance of a given platinum wire will remain constant after long-continued heating or interrupted exposure to high temperatures, &c.; in consequence it is requisite that the actual resistance after cooling of the heated wire should be verified from time to time, and the numerical values in the instrumental tables suitably adjusted when any alteration has taken place, otherwise serious errors may be introduced.

For temperatures above 800° or 900° C. a peculiar pyrometer has been proposed by Lamy (*Comptes Rendus*, lxi. 347), based upon the connexion between the amount of dissociation of calcium carbonate and the pressure and temperature to which it is subjected; a glazed porcelain tube closed at one end with some fragments of marble and caespar is filled with carbon dioxide gas and connected with a mercurial manometer; on placing the end of the tube containing the caespar on the furnace to be examined, the extra pressure due to the evolved carbon dioxide is read off on the manometer, and the temperature thence deduced by a table; on cooling, the evolved gas is reabsorbed by the partially causticized lime.

*Tuyeres.*—The heated blast passes into the furnace through nozzles or *tuyeres* supplied from an annular or horse-shoe shaped tube carried round the lower part of the furnace at an elevation of a few feet above them by means of slanting tubes at right angles to the ring known as "swan necks" or "goose necks." Usually the annular tube is carried by the column supporting the superstructure by means of suitable braces or gibbets, and communicates with the blast main at a point as near to the superheater as possible, slide valves being provided for each goose neck so that any one of the tuyeres can, when necessary, be shut off without stopping the supply of blast to the others; when more than one furnace is supplied from the same hot main, a similar valve is provided in the branch from the main leading to each furnace. In order to adjust the nozzle of the tuyere accurately to the tuyere hole in the hearth wall, a sliding telescope joint is often inserted between the nozzle and the end of the goose neck, the lowest portion of the nearly vertical part of which is provided with a tubulus closed with a hollow stopper, the hollow of which is covered with a plate of mica; by looking through

the mica along the axis of the nozzle a view of the furnace interior is obtained, whilst by removing the stopper a jet of hot blast rushes out, by means of which the temperature

furnace, this effects an equal distribution of blast, and facilitates regular working. With small-sized furnaces such as are used in various parts of the Continent (with

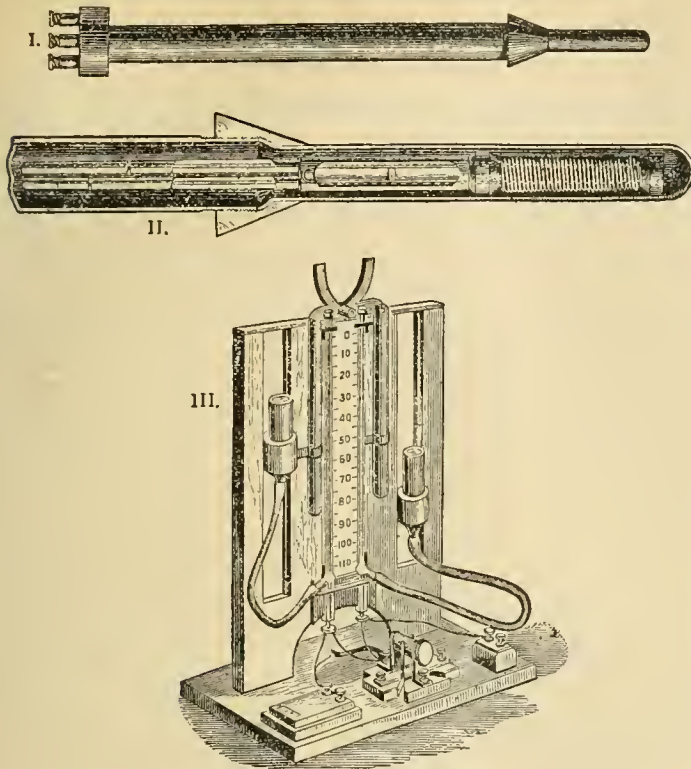

FIG. 22.—I. Siemens Electrical Pyrometer. II. Section of Heated End. III. Double Voltmeter.

can be ascertained by holding rods of zinc, &c., in the jet; or the ball of a Siemens pyrometer can be introduced into the tuyere through the orifice.

In the early days of the hot blast it speedily became manifest that unless the tuyere nozzles were artificially cooled they became so rapidly eaten away that practically the hot blast was inapplicable; to remedy this the "water tuyere" was invented by Condie. This simply consists of a nozzle with double walls, the outer one forming a "jacket" round the inner one or nozzle proper, water being allowed to circulate through the space between the walls.

Another way of effecting the cooling is by bending a coil of wrought iron piping into a conical spiral (fig. 23), placing this in the cavity of a mould furnished with a core, and casting round it a hollow cone of cast iron, so that by connecting the projecting ends of the coil with a water main and escape pipe respectively a continual circulation of water is kept up through the coil, whilst the blast passes through the central cavity. Sometimes bronze and especially "phosphor-bronze" nozzles are employed; these have the advantage that the molten pig iron as it runs down inside the furnace does not adhere to them so readily as it does to iron tuyeres. The tuyeres are generally arranged symmetrically in a horizontal plane round the base of the

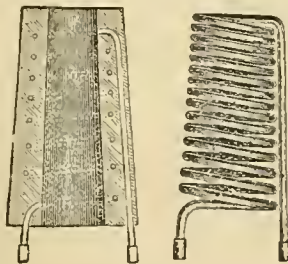

Fig. 23.

to the tuyere owing to the heat absorption in the conversion of the water into steam and the reaction of the water vapour on the red-hot coke, forming carbon oxide and hydrogen (the presence of extra hydrogen thus formed also modifies to some extent the chemical actions taking place in the upper part of the furnace in a direction rather the reverse of economical as regards consumption of fuel); if, on the other hand, a large volume of water is suddenly introduced, and especially if by a "slip" (or sudden jerky motion downwards of a mass of material that had previously more or less "scaffolded"); it is forced into the mass of molten cinder and pig in the hearth, or, what amounts to the same thing, if the cinder and molten pig are suddenly forced or splashed up by the slip, a sudden explosive generation of steam (and probably decomposition into oxygen and hydrogen, or formation of iron oxide and free hydrogen) takes place, sometimes giving rise to serious accidents. Why contact with vitreous matter (such as cinder, &c.) should cause a more explosive formation of water vapour or gases than contact with metal is unknown, but probably the cause is the same as that in virtue of which a piece of sodium in contact with water only will evolve hydrogen quickly but not explosively, whereas if the sodium touch glass, glazed crockery, &c., and water simultaneously, a violent explosion often occurs. In foundries and during the refining of iron (§ 23), if water be thrown on the surface of the molten or semi-fused metal, and a piece of solid cinder or slag be mechanically carried under the surface of the hot metal, a more or less loud explosion often occurs, sometimes sufficiently violent to produce fatal consequences and do much damage (Menelaus); on the other hand, in cold blast furnaces where water tuyeres are not used, explosions of this class never happen, although in all kinds of furnaces explosions may occur due to admixtures of air and blast furnace gases being formed when the blast is cut off for tapping, &c., and then being fired on putting on the blast again. This class of accident is usually guarded against as far as possible by means of appropriately constructed valves in the gas main, &c. Sudden violent mechanical squirting out of molten pig or cinder by a slip inside the furnace sometimes occurs with serious consequences; but this is a different thing from (though often combined with) the effect of water being carried suddenly into contact with the cinder,



&c. In order to diminish the liability to explosions from this effect of water, Lloyd has patented a peculiar tuyere into which the cooling water is injected in the form of spray or fine jets all over the outer surface of an inner conical tube through which the hot air passes, as well as over the inner surface of an outer covering cone, so that in case of the end of the tuyere being burnt away the volume of water injected into the furnace is much lessened, as owing to the incline backwards of the lowest part of the cone (the axis being horizontal) most of the water runs out *away from* the furnace instead of being forced into it by the pressure of the head of water as in the ordinary coil tuyere. When the water supplied is muddy, or is apt to deposit matter on warming or standing, there is a liability to stopping up of the holes through which the fine jets of water pass; to remedy this Plum modifies the arrangement by making the water pass through a slit or against a sheet of metal so as to spread it out into fan-shaped jets delivered against the nose of the tuyere and the upper half of the outer shell. For drawings of this "spreader tuyere," see *Journal I. and S. Inst.*, 1878, 299.<sup>1</sup>

16. *Collection of Cinder and Pig Iron.*—As the cinder flows off from the furnace it is usually received in rectangular or cylindrical iron tanks mounted on wheels and running on a railway at a few feet lower level than the base of the furnace; the *cinder balls* thus formed are usually discharged on to some vacant piece of ground in the vicinity of the furnace, thus entailing the loss of the value of the ground.<sup>2</sup> The Kloman machine used in America for the reception of the cinder consists of a series of iron boxes placed in a water tank on a turn-table, the object being to quicken the solidification of the cinder and get it out of the way more rapidly. In order to cast the pig iron into convenient marketable forms, the ground in front of the tapping hole is made into a *pigbed*, by arranging it at a gentle slope from the tapping hole and covering it with loam or sand. A channel is dug in this with a spade, &c., leading down the slope in a right line from the tapping hole; and at right angles to this side channels are dug the ground sloping laterally away from the main channel; from each side channel moulds are made to spring, prepared by pressing into the yielding sand wooden blocks some 2 or 3 feet in length, and in section like a capital D, the convex side (on which is embossed or engraved the particular mark or brand of the iron-works) being downwards. When the furnace is tapped the rivulet of molten metal running down the main channel is first directed into the lowest row of moulds, and when these are full the supply is shut off by plunging a spade coated with fireclay into the channel at *a* (fig. 24), so as to fill up the second row of moulds, and so on successively until only cinder flows out at the tapping hole. Whilst the castings are still at a dull red heat and the metal is consequently brittle, the *pigs* or masses of metal filling the moulds are detached from the *sows*, or irregular larger pigs from the channels, by means of a crowbar. In some works the tapping is performed only once in twelve hours; in others a cast is made every eight hours or even more frequently; of course the oftener the furnace is tapped the less the size of the pigbed required. Occasionally the molten metal is

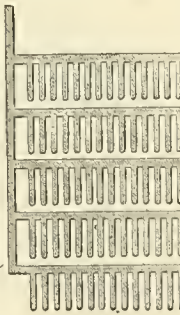

Fig. 24.

<sup>1</sup> A large amount of detailed information as to the dimensions and construction and general working of the blast furnaces and subsidiary plant of a number of the more important American iron-works is to be found in a series of papers on "American Iron and Steel Works," by A. L. Holley and Lenox Smith, *Engineering*, 1877, &c.

<sup>2</sup> In the vicinity of Middlesborough they have for some time been largely disposed of by using them to build a retaining wall to keep the sea back from low-lying ground and mud banks covered at high water to a greater or lesser extent, whereby not only is a valueless waste product got rid of, but a recovery of what may hereafter prove to be valuable land from the sea is effected.

run into waggons lined with firebrick serving as reservoirs supplying with fused pig Bessemer converters conjoined with the smelting furnaces; so that the molten cast iron is run directly into the converters and finished off without ever solidifying before the completion of the steel-making process. Sometimes the metal is cast into pigs in iron moulds instead of a sand bed.

*Composition of Pig Iron.*—The following analyses illustrate the difference in composition of various kinds of pig iron as met with in the market:—

*Pig Irons comparatively free from Sulphur and Phosphorus.*

Character of Pig and Locality....	Cumberland and Lancashire Haematite Fig.		Danemora Charcoal Pig, Magnetic.	Elsenerz Charcoal Pig, Spathic Ore.	Lake Superior Charcoal Iron.	Brown Haematite and Spherule Iron, Neva Scotia, No. 1.
	Whitehaven, No. 2.	Cleator Grey Foundry				
Analyst .....	Abel	Abel	Henry.	Müller.	Snelus.	Tookay.
Iron .....	94.66	93.94	95.57	95.69	93.34	94.85
"Combined" carbon .....	trace	4.18	4.20	3.57	0.38	3.50
Graphite .....	2.24				3.39	
Silicon .....	2.77	1.92	0.08	0.13	2.28	0.84
Sulphur .....	1.01	0.65	trace	0.01	0.05	0.19
Phosphorus .....	0.05	0.08	0.05	trace	0.10	0.19
Manganese .....	0.07	0.02	0.10	0.61	0.17	0.44
	100.00	100.19	100.00	100.00	99.69	99.84

*Pig Irons containing much Sulphur, Phosphorus, Silicon, &c.*

Character of Pig and Locality....	Cleveland Ironstone, Claencia Furnaces.		Calder Works, Foundry Pig.	Northamptonshire Ores mixed with tap-cinder.	Arsenic Pig, White.	Glazy Iron, Cleveland.
	No. I.	Mortled.				
Analyst .....	Pattinson.	Pattinson.	Becher.	Henry.	Mittetregger.	Lowthian Bell.
Iron .....	92.43	93.69	92.30	92.825	93.30	68.18
"Combined" carbon .....	0.32	0.85	0.40	0.185	1.95	0.79
Graphite .....	3.43	2.70	1.60	2.456	0.55	2.59
Silicon .....	1.70	0.66	2.80	2.037	0.19	6.13
Sulphur .....	0.13	0.35	1.40	0.920	0.07	0.17
Phosphorus .....	1.24	1.05	1.90	1.432	0.04	1.12
Manganese .....	0.30	0.79	...	0.720	2.02	0.77
Titanium .....	0.56	...	...	...	...	0.26
Arsenic .....	...	...	...	...	1.70	...
Copper .....	...	...	...	...	0.11	...
Calcium, Magnesium, Aluminium, &c., .....	0.06	0.33	...	traces	...	3.28
	100.17	100.32	100.00	100.000	100.00	99.29

*Composition of Cinder.*—Sometimes cinder is highly crystalline; that from clay ironstone, especially of the Cleveland district, however, is usually amorphous; the structure in all cases depends much upon the rate of cooling, a cinder which is distinctly crystalline when a large mass is cooled slowly being often vitreous and wholly devoid of crystalline texture when cooled quickly in a

*Analyses showing Composition of Cinder.*

Locality and Particulars...	Calced Cleveland Ore, Hard Coke, and Limestone.	Askam In Furnace, Askam Haematite and Fisher's Red Bay Aluminous Ore.	Cwm Celyn, Scouring Clader.	Olsberg, Westphalia, Brown Haematite and Charcoal.	Edstra, Sweden, Magnetic and Charcoal.	Elsenerz, Styria, Spathic Ore and Charcoal.
	Lowthian Bell.	Stock.	Noad.	Rammelsberg.	Folfer.	Wehrle.
Silica .....	27.65	38.00	42.96	55.25	58.1	54.6
Alumina .....	24.69	10.00	20.20	5.71	5.1	2.6
Lime .....	40.00	42.19	10.19	27.60	18.0	10.7
Magnesia .....	3.55	1.65	2.90	7.01	19.8	1.3
Potash and soda .....	1.45	3.63	1.10	...	...	...
Ferrous oxide .....	0.72	2.08	19.80	1.27	1.0	1.4
Manganese oxide .....	0.35	trace	1.53	3.16	4.1	28.6
Calcium sulphide .....	...	2.45	1.32	...	...	1.1
Sulphur .....	1.95	...	...	...	...	...
Phosphorus .....	0.26	...	...	...	...	...
	100.62	100.00	100.00	100.00	99.6	100.0

small quantities at a time. Presence of much lime makes the cinder chalky or stony in appearance; ferrous oxide communicates a dark green or black tint and a ready fusibility to it; manganese oxide often gives an amethystine shade. Ultramarine appears to be sometimes formed, some slags possessing a blue colour easily discharged by mineral acids; the blue tint is, however, attributed by

some to different causes, such as compounds of vanadium and titanium. When, in addition to the "mine" or ordinary ores, the substances smelted contain an admixture of the slags from puddling and reheating furnaces, or of "mill cinder" (scales from the rolling mills used in the production of malleable iron), the blast furnace cinder is apt to contain an undue proportion of iron, these additional substances being usually much more compact in their texture than ores, and at the same time more fusible, so that their complete reduction is often not effected in the time during which they are traversing the furnace. Since these slags are usually highly contaminated with phosphorus and sulphur, they are only employed as a rule in conjunction with ores yielding the commoner qualities of iron, furnishing "cinder pig," which is often wholly white, and less carbonized and more impure than other kinds or white iron. The accompanying analyses illustrate the composition of the cinder produced in furnaces smelting various kinds of ore.

17. *Utilization of Cinder.*—When the cinder does not contain too much lime or calcium sulphide, it often forms a material of moderate hardness and durability suitable for road metal; but frequently it is of but little value for this purpose, owing to its friability and tendency to fall to pieces on exposure to air and moisture. By casting the molten cinder (when of the requisite amount of durability) into rectangular blocks, a good substitute for building stone is produced; in other cases, by the addition of alkaline silicates, a serviceable coarse bottle glass can be obtained. Vitreous cinders also serve for the preparation of a variety of "mineral wool," a filamentous substance something like spun glass producible by blowing air or steam through the molten cinder, and useful for packing the jackets of steam pipes, boilers, &c., to avoid loss of heat, and superior for this purpose to organic substances in being not liable to char or burn. Certain kinds of cinder which approximate to cements in composi-

tion may be utilized in the manufacture of hydraulic mortars, Portland cement, &c.; by heating together with lime or hydraulic limestone; according to J. Huck, if the powdered slag be stirred up in a tank with dilute hydrochloric acid (containing some 17 per cent. of actual acid, HCl), sulphuretted hydrogen is evolved, and a partly gelatinized mass is produced by the decomposition of the silicates; this when washed, drained, dried, and ground to fine powder, and mixed with finely powdered ordinary slag so as to constitute about 10 per cent. of the mixture, affords a cement capable of use for all sorts of work as well under water as above it, and equal in quality to the best cements in ordinary use. Bricks for building purposes may be made from suitable kinds of cinder by grinding it to a coarse powder, moistening and mixing with a little lime, and strongly compressing in moulds by machinery; the brick sets in a few days to a hard stone-like mass; some cinders will thus set without addition of lime by merely grinding up fine, moistening, and compressing. In order to facilitate the grinding, C. Wood has patented the following process: the molten slag as it runs from the furnace is received on a slowly revolving horizontal table and cooled by a jet of water (fig. 25), which causes it to disintegrate into comparatively small fragments which are much more readily pulverized than the compact blocks formed when the molten slag runs into a receptacle and there solidifies; or it is reduced to a kind of sand by running it into water kept in agitation by a peculiar machine, the sand being a moderately useful manure for certain soils. See *Journal I. and S. Inst.*, 1873, 186, and 1877, 443; and *Journal Soc. Arts*, May 14, 1880 (vol. xxviii. p. 576). At the Sclessin Works, Liège, slag sand is made without any machinery at all by simply making the stream of molten slag run into a constant-running jet of water issuing obliquely from behind; the slag thus disintegrates spontaneously into small fragments. Many

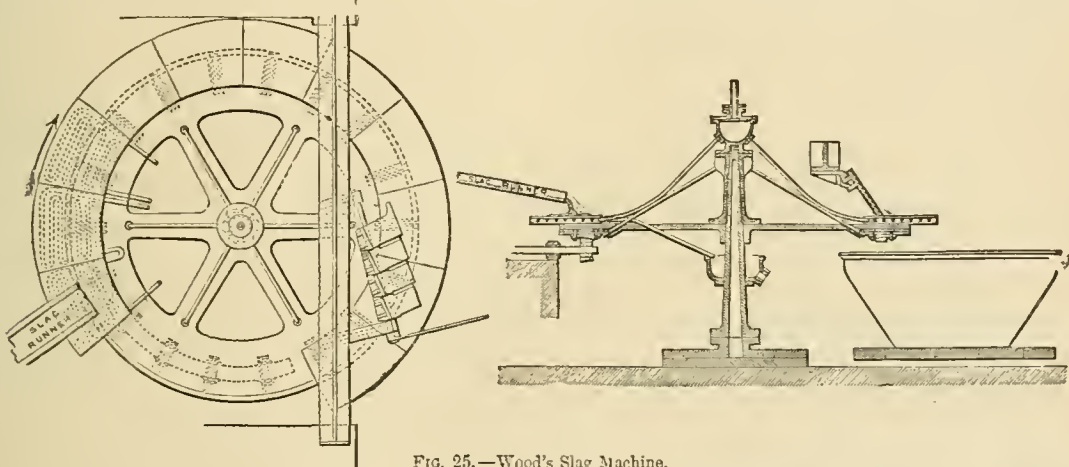

Fig. 25.—Wood's Slag Machine.

kinds of cinder, however, are of so little value for any of these purposes that they constitute a wholly waste product, the getting rid of which in the cheapest way possible is a desideratum.

18. *Collection of Waste Gases.*—To M. Aubertot of the department of Cher belongs the credit of having first attempted to utilize the gases escaping from blast furnaces, in 1811; a brick kiln being erected on the top of the furnace, the flame was allowed to pass in and so burn the bricks; the calcination of lime and the heating of the chests containing charcoal and iron bars for steel cementation was effected by him in the same way. In later years steam boilers were heated in much the same way; about 1840, at the Rustral furnaces (department of Vaucluse), the device was in use of drawing off the gases by means of a tube and burning them underneath the boilers placed, not on the top of the furnace, but in any convenient place even though at some distance. The use of the waste gases for heating the blast on this principle was patented in England by J. Palmer Budd in 1845. A few years later George Parry of Ebbw Vale adapted an old arrangement for distributing equally the charges introduced into the furnace (by shooting the materials on to a conical surface at the mouth of the shaft) so as to form a kind of valve, closing the furnace entirely when shut and allowing the

gases to pass out completely into a tube conveying them to the places where they were to be burnt, and at the same time allowing the charge to be introduced almost instantaneously when opened. This "cup and cone" arrangement is represented in fig. 26.

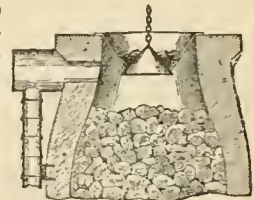

Fig. 26.

By simply lowering the cone (counterbalanced) the materials shoot off it into the furnace; by immediately raising it the furnace is again closed; on account of its simplicity and ease in working it has been very largely adopted, especially as it facilitates the proper distribution of materials inside the furnace by making them glide off the slanting conical surface so as to be deposited at the sides of the shaft and not at its centre; the effect of this is to tend to make the upper surface of the mass concave instead of convex, and in consequence the lighter coke or charcoal tends to roll down the slope towards the centre somewhat more than the heavier ore and flux, so that the central portion of the mass of materials in the shaft is somewhat richer in fuel than the sides; if the furnace is full nearly to the throat and of considerable width, the surface will be crater-shaped,—the heavier ore, &c., accumulating in the circular crater ridge, and the lighter coke rolling down inwards towards the centre, and onwards towards the side of the shaft. As the materials sink the outermost layers are retarded by friction against the sides



of the shaft, so that they have a tendency to fall over inwards during descent and produce intermixture; in this way a much more nearly uniform degree of porosity of the whole mass (and consequently of action of the ascending gases) is brought about than would be the case were the materials introduced through a narrow funnel so as to form a convex-surfaced heap in which the ore would accumulate in the centre. Sometimes the cup and cone arrangement is modified by making the cone to rest upon the inner and lower edge of the hollow in the cup, so that the introduction of fuel is accomplished by raising the cone instead of lowering it, the object of this being to diminish the height of the furnace by the space through which the cone would otherwise sink when lowered. With this arrangement the materials run into the furnace in a direction sloping towards the centre instead of away from it, sliding inwards along the converging sides of the cup. To avoid the central accumulation of fuel and the lateral preponderance of "burden" (ore and flux) thus promoted, an inverted annular funnel is suspended underneath the lower orifice of the cup, so that the falling substances impinge upon this and slide off again with a motion towards the circumference of the shaft just as they do from the cone itself in the ordinary arrangement.

Prior to the introduction of the cup and cone, a form of tunnel-head in which no valve or cone exists was employed, represented in fig. 27. A hollow annular chamber BB is built in the upper portion

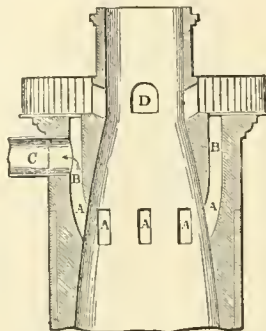

Fig. 27.—Collecting Top.

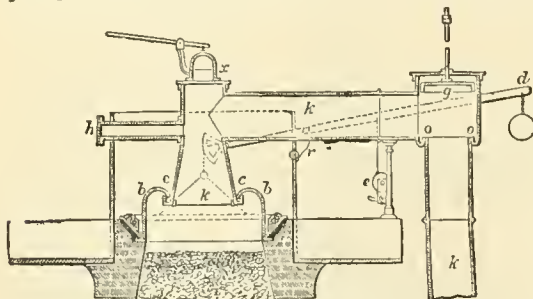

Fig. 28.—Langen's Collector—Vertical Section.

of the stack, communicating by arched cavities A, A, A with the shaft, and also with the exit gas main C; a considerable fraction of the gases then passes out through the arched cavities when the materials are heaped up to the level of the charging door D. With small furnaces the wall between the shaft and the chamber B is made of

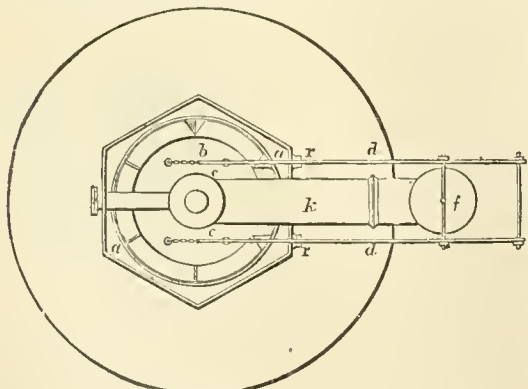

Fig. 29.—Langen's Collector—Horizontal Section.

cast or wrought iron; in some cases the gas has been collected through a central tube in the axis of the shaft supported by girders springing from the shaft, the ore, &c., being charged through the annular opening between this tube and the shaft. Arrangements of this kind are still used in Sweden. In Coingt's gas collector the central tube is combined with a modification of the cup and

cone arrangement. Langen's arrangement (figs. 28, 29) is a somewhat similar combination, the cone being made into a bell with perforated top, the edges of the perforation being turned over inwards *bb*; the bell rests upon the cup *aa*, the turned over edge *cc* fitting into a water lute surrounding the central tube *kkk*, so that whilst the bell is lowered the furnace top is gastight or nearly so. By means of a pair of levers *d, d* and a counterpoise swung on a horizontal axle at *r* by means of a winch *e*, the bell can be raised so that the charge in the cup falls into the furnace, sliding down the inclined surface. Two safety valves *x* and *fg* are provided, the latter being ordinarily supported by the pressure of the gases, but falling by its own weight when the gas pressure is relieved by raising the bell, so as to close the top of the gas shaft, the turned-down edges of *g* fitting into the annular groove *oo*. *h* is a small manhole for the introduction of scrapers to clear out flue dust when required.

**Composition of Waste Gases.**—In general terms the escaping gases may be said to be the nitrogen of the blast mixed with variable proportions of carbon oxide and dioxide, and usually small quantities of free hydrogen; when raw coal is the fuel, the proportion of hydrogen is greater, and carburetted hydrogens are also present. The main sources of hydrogen when coke and charcoal are used as fuel are probably the hydrogenous matter in the fuel, and the moisture contained in the blast and in the materials as water of hydration not expelled until they reach a part of the furnace sufficiently high to cause the water vapour to react whilst still nascent on the carbon present, forming carbon oxide and hydrogen (see § 10).

Various solid substances are mechanically carried up with the gases, these having in many instances been vaporized at the lower levels, condensing again in the relatively cooler portions of the furnace as finely divided particles. This especially applies to zinc oxide (formed by the oxidation of zinc vapour generated by the reduction of zinc compounds in the ores) and to compounds of the alkali metals, and gives rise in the latter case to a destructive fluxing action upon the brick-work of the upper portion of the furnace and to a complication in the chemical changes ensuing in the furnace; for the solid floating particles are more or less intercepted and filtered out, as it were, from the ascending stream of gases by the materials in the upper part of the furnace, and are thus brought back again to the lower level, so that an accumulation in the furnace of alkali metals is produced which ultimately causes the actual quantity of alkaline compounds in the furnace to bear a very considerable proportion to the iron present, although the amount of potash and soda in the ore flux and fuel is originally only trifling as compared with the iron. Those portions of the suspended solid matters which are not thus retained in the furnace by condensation on the materials are more or less deposited in the gas flues, and the heating stoves, &c., in which the gas is burnt, sometimes causing considerable inconvenience, and rendering it necessary to clean out the deposits from time to time. To avoid this clogging, the fume is sometimes washed out of the gases by jets of water in the form of spray before they pass on from the downcast pipe to the stoves; an arrangement of this description applied to the Lucy furnace (Pittsburg, U. S.) has worked well. The following analyses represent the composition of the fume deposited in the gas flues of various furnaces:—

Source of Fume and Analyst...	Dowling, Riley.	Clarence, H. Bivert.			Furnaces at Stenay (Meuse), Nivoit and Létiange.	Furnaces of Phoenix Iron Co., Phoenixville, Pennsylvania, Blagitt Briton.
		Soluble in Water.	Insoluble in Water.	Total.		
Silica .....	30.23	1.97	11.00	12.97	0.56	36.00
Alumina .....	8.43	12.29	10.76	22.06	1.90	5.57
Ferric oxide .....	47.95	...	...	...	...	21.72
Lime .....	2.33	traces	2.06	2.06	0.97	3.94
Magnesia .....	1.13	traces	traces	traces	...	0.69
Zinc oxide .....	...	4.58	13.28	17.86	89.10	2.84
Sulphuric anhydride .....	...	0.59	...	0.59	0.13	7.45
Chlorine .....	...	0.57	...	0.57	...	0.03
Potash and soda salts .....	2.16	22.90	3.07	25.97	...	17.93
Lead oxide .....	...	...	...	...	5.91	...
Carbonic anhydride .....	...	...	7.00	7.00	...	0.53
Water and matters lost on ignition .....	0.93	10.46	...	10.46	...	...
Manganese oxide .....	1.77	...	...	...	...	1.66
Calcium sulphate .....	4.42	...	...	...	...	0.38
Do. phosphate .....	0.75	...	...	...	...	(Phosphoric acid.)
	99.27	52.67	47.17	99.84	98.57	100.00

Amongst the alkaline salts thus deposited are considerable amounts (under certain circumstances) of potassium and sodium cyanides (§ 19); this circumstance appears to have misled Professors Bunsen and Playfair into the belief that cyanogen gas is occasionally one of the normal constituents of blast furnace gases as they escape at the top, the cyanides being more or less deposited in the collecting tube employed, and decomposed by the carbon dioxide and moisture present, with the production of hydrocyanic vapour, which on analysis gives the same numbers as the same bulk of a mixture of hydrogen and cyanogen in equal volumes; it is noteworthy that cyanogen has never been found by any other analyst. The following analyses indicate the general character of the waste gases escaping at the top of blast furnaces smelting various ores:—

Analyst .....	1.	2.	3.	4.	5.	6.
	Bunsen at 1 Playfair.	Ebel- meh.	Tünner.	Crossley.	Lowthian Bell.	Lowthian Bell.
Nitrogen.....	64.35	67.06	55.1	54.51	60.93	47.2
Carbon oxide.....	25.97	28.61	23.8	34.97	26.62	28.9
Carbon dioxide.....	7.77	11.59	13.6	8.36	11.75	13.6
Hydrogen.....	6.73	2.74	7.5	2.16	0.70	10.3
Marsh gas.....	3.73	0.20	...	...	...	...
Olefines (expressed as C <sub>2</sub> H <sub>4</sub> ).....	0.43	...	...	...	...	...
	100.00	100.00	100.00	100.00	100.00	100.00

1. Affricton furnaces using raw coal, calcined clay ironstone, and limestone; blast at 330° C.
2. Scaring furnace using coke, brown hæmatite with a little mill cinder, and limestone; blast about 180° C.
3. Wrbna furnace using spathic ore and charcoal; blast at 400° C.
4. Askam-in-Furness furnace using Askam hæmatite, Fisher's Red Bay aluminous ore, and coke; blast at 500° C.; exit gases at 380° C.
5. Average of a number of analyses of gas from an 80 foot furnace using calcined Cleveland ore, limestone, and hard coke; blast at 495° (average), and exit gases at 332° C.
6. Coltness furnace using raw coal.

The precise relative amounts of carbon oxide and dioxide that accompany the proper working of any particular furnace are governed by a variety of circumstances, many of which have been carefully investigated by Percy, Bunsen and Playfair, Vathaire, Tünner, Ebelmen, Scheerer, and others, and more especially by Lowthian Bell, with the present writer's cooperation (*Chemical Phenomena of Iron Smelting*), with the general result that the amount of heat produced in the furnace by the conversion of the fuel (coke or charcoal) into carbon oxide and dioxide, together with that introduced by the blast, is equal to the sensible heat carried out by the escaping gases and the molten pig and cinder, together with an amount constant for given conditions, but otherwise variable within certain limits, representing the sum of the heat absorptions during the various physical and chemical changes going on in the furnace, and the loss of heat from the furnace walls by radiation and conduction; so that for given sizes and shapes of furnace, given ores and fluxes, and production of given kinds of pig iron and cinder, the amount of carbon oxide relatively to the carbon dioxide in the escaping gases is regulated only by the proportion of fuel burnt, and the temperature of the issuing gases; this latter being also constant, the greater the amount of coke burnt per ton of iron run the more carbon oxide exists in the waste gases and the less carbon dioxide, and *vice versa*. There is always a natural limit, however, to the extent to which the quantity of carbon monoxide can be reduced and that of carbon dioxide increased in any given furnace under any given conditions (as to nature of ore, &c.) by diminishing the amount of fuel relatively to the burden; as this limit is being approached and passed, the pig iron begins to deteriorate in quality, first being less graphitoid or "grey" in character, then becoming entirely white iron of a less carbonized character than good pig of the kind; finally a large fraction of the iron is wholly unreduced, and passes into the cinder as ferrous oxide (silicate), producing a strongly marked "scouring cinder," and greatly diminishing the yield. The reason for this is simply the natural character of the complex chemical changes and reactions involved in the working of the blast furnace (dealt with in detail in § 19).

**Poisonous Effects of Blast-Furnace Gases.**—Carbon oxide being, as is well known, a poisonous gas, rapidly producing death when inhaled even in small quantity (as when badly ventilated rooms are warmed by charcoal braziers, &c., or when a considerable escape of coal gas—containing usually a few parts per cent. of carbon oxide—takes place into the air of the room), it results that unless care be taken serious effects may be produced by the inhalation of the waste gases from the blast furnace. Several fatal occurrences due to this cause have taken place, one of the most remarkable of which was the death of Mr Truian, manager of the Dowlais iron-works, through the escape into his office of the gases from the gas main, which was of brickwork, and poorly constructed underground. Besides carbon oxide, the waste gases often contain perceptible quantities of potassium cyanide disseminated through

them as dust; the effect of moisture and carbon dioxide upon such air is to impregnate it with vapour of hydrocyanic acid (prussic acid); in some of the cases of poisoning by waste gases the cyanide was believed to be the chief deleterious agent.

19. *Chemical Changes taking place in the Blast Furnace.*—At the level of the tuyeres, the entering blast comes in contact with a mass of incandescent coke through and over which molten cinder and pig iron are dropping and running; the almost instantaneous effect upon the air consequently is to transform the oxygen into carbon oxide either at once or through the two well-known reactions:—



If a hole be drilled through the walls of a furnace at the tuyere level, and the issuing gases collected (or, what is much the same thing, if the blast be shut off from one goos neck and the plug taken out so that the pressure of gases inside the furnace forces gas out at the orifice), it is invariably found that the amount of carbon dioxide present in the gases is inconsiderable or nil,—the composition of the gases being essentially a mixture of carbon and nitrogen with a little hydrogen (either derived from the moisture in the blast being converted into hydrogen and carbon oxide, or from the hydrogen of the coke first burnt to water vapour and then immediately reconverted into hydrogen and carbon oxide). Besides the carbon oxide due to these causes, there is also a small amount of that gas arising from the molten iron and cinder accumulated in the hearth, owing to the reaction of the dissolved carbon on the last traces of iron oxide disseminated through the pig and dissolved in the cinder; so that at the tuyere level there naturally is a little more oxygen relatively to the nitrogen than that corresponding to the oxygen of the original air and moisture in the blast, viz., a mixture of about 35 volumes of carbon oxide and 65 of nitrogen. In passing through the mass of materials in the furnace, the carbon oxide becomes more or less converted into carbon dioxide, reducing the iron ore in virtue of the change expressed in general terms by the equation

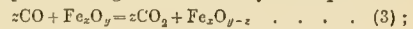

so that, were this the sole action taking place, at successive levels upwards the amount of carbon in the gases would remain constant relatively to the nitrogen, whilst the oxygen therein would increase. The actual changes, however, are far more complex than this. Thus, commencing with the top of the furnace, and proceeding downwards, when raw limestone is used as flux, it gives off carbon dioxide as it gets heated, thereby increasing both carbon and oxygen in the gases; during the passage downwards of the ore in the blast furnace it finds itself continually exposed to a heated atmosphere containing carbon oxide and dioxide; the first effect of the gases upon the newly introduced ore is simply to heat it up, but as soon as the outer portions of the lumps have attained a temperature of something like 200° C. (dependent on the physical character of the ore), which practically is almost immediately after introduction, reduction of the ferric oxide present commences, the carbon oxide of the gases becoming converted into carbon dioxide in accordance with equation 3. Simultaneously, however, the fuel introduced is more or less acted upon: if raw coal be not used, but coke or charcoal, as is most frequently the case, the effect of exposing this to an atmosphere containing carbon dioxide is to cause (when the temperature is sufficiently high) the occurrence of the reaction between the carbon dioxide and the carbon of the fuel expressed by equation 2. The temperature at which this change begins to take place to any considerable extent depends on the physical condition of the carbon, as does also the rate at which it goes on, which is also modified by the amount of carbon dioxide present in the gases relatively



to the other constituents, the reaction is not sensible with hard coke at temperatures lower than 300°, whilst at 400° and somewhat upwards it is not marked; at 500° and 600°, however, it goes on pretty rapidly, the more so the less hard and dense the coke, charcoal acting much more readily under similar conditions than coke. Accordingly as the iron ore and the fuel gradually sink in the furnace and become hotter, they tend to affect the composition of the gas in opposite ways, the former decreasing the carbon oxide and increasing the carbon dioxide, and *vice versa* with the latter. The rate of reduction of iron oxide under constant circumstances is, however, a diminishing one, inasmuch as the reduced particles cover up the unreduced ones and prevent their being so readily acted on; so that, whilst on descending into a hotter region the rate of reduction of the ore is at first increased owing to increase of temperature, by and by the rate of removal of oxygen as it sinks ceases to increase and ultimately diminishes. Long before anything like complete reduction is brought about, however, other changes are brought into play which greatly modify the actions. As soon as the iron ore is partially reduced, it begins to react on the carbon oxide in the way indicated by the equation

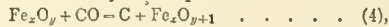

setting free finely divided amorphous carbon in contact with it.<sup>1</sup> Again, as soon as metallic iron in a spongy form is produced, it reacts on the carbon dioxide, thus—

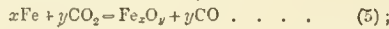

whilst very probably a parallel reaction takes place with lower oxides of iron not completely reduced to the metallic state, these actions being practically reciprocal to those in virtue of which carbon oxide reduces to ferric oxide, first to a lower oxide and then to metal. Yet again, when carbon and iron oxides are heated together, there takes place a change virtually reciprocal to that in virtue of which carbon is deposited from carbon oxide (equation 4),—carbon oxide and dioxide gases being formed, and the iron oxide being more or less reduced in virtue of the reactions

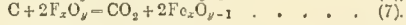
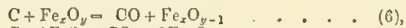

The ultimate result then is that before the ore and fuel have descended far they are subjected to a number of opposing forces: so far as the ore is concerned, the carbon oxide in the gases surrounding it and the deposited carbon in contact with it tend to remove oxygen by reactions 3, 6, and 7, whilst the carbon dioxide in the gases and the reaction causing deposition of carbon from carbon oxide tend to re-oxidize it by reactions 4 and 5: the fuel and carbon oxides in the gases on the other hand are analogously affected; the reaction of the carbon dioxide on the fuel, 2, tends to gasify the latter (the action being more rapid with charcoal than with coke—Lowthian Bell, also Akermann), and that of the carbon oxide on the partly reduced iron ore setting free carbon, 4, to reverse this action. The actions of the iron and its oxide on carbon, and on carbon oxide and dioxide, also are opposed, some tending to increase the carbon oxide, 5 and 6, and some to decrease it, 4, and others to affect similarly the carbon dioxide, viz., 3 and 7 to increase it, and 5 to decrease it. In consequence, at any given level of the furnace a sort of compromise is arrived at amongst all these varied oxidizing and reducing influences, the net or resultant chemical action being that, whilst a portion of the hard coke of the fuel is gasified, and reciprocally a portion of finely divided amorphous carbon precipitated from the gases, the iron is partially but not wholly reduced. On the whole, then, as the ore sinks in the furnace, it

becomes hotter and hotter and more and more deoxidized, but owing to the oxidizing influences at work it does not part with all its oxygen until it has descended some considerable distance to a point where the temperature is about sufficient to fuse it; at this stage the last portions of oxygen are removed, partly by the precipitated amorphous carbon, partly by the alkaline cyanides accumulating in the furnace, and the almost completely reduced metal melts, dissolving as much of the amorphous carbon in contact with it as it can take up under the circumstances; simultaneously the silicious and earthy matters present also fuse, forming cinder. The reducing influences at work here also cause the deoxidation of some of the silica present, whilst manganese, phosphorus, and sulphur compounds, &c., are also more or less reduced and taken up by the fusing iron. When the proportion of fuel relatively to the burden is diminished, a larger amount of incompletely deoxidized ore reaches the hearth, the result of which is that, as the silicious and earthy matters fuse, they dissolve some of the iron oxide before it has time to become reduced by the deposited carbon, giving a ferruginous cinder, whilst this carbon is used up in completing the reduction more rapidly than would otherwise be the case; the pig iron formed is less highly carbonized than before, becoming white instead of grey, partly owing to the diminution in the quantity of dissolved carbon, and partly because the temperature of the hearth is lowered, and there is less time for graphite to separate in cooling.

The formation of alkaline cyanides and their reaction on the imperfectly reduced iron oxide is brought about as follows: in the upper part of the furnace a crust of alkaline carbonates, &c., carried up as fume by the escaping gases (§ 18), is deposited on the surface of the materials, and so is brought down again to the hearth, where the nitrogen of the blast and carbon act on it conjointly, forming (for potassium carbonate) potassium cyanide, thus

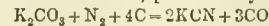

The exact nature of the reaction of potassium cyanide on the imperfectly reduced iron oxide with which it finds itself in contact is not known, but it is probable that potassium oxide and iron cyanide are formed, the latter becoming decomposed into iron, carbon, and free nitrogen, and the former being carried away by the escaping gases and deposited as potassium carbonate in the upper part of the furnace, so that where the cyanide is formed (mainly at or near the tuyere level) there is an evolution of carbon oxide and a disappearance of nitrogen, whilst a little higher up there is a re-evolution of nitrogen; that is, whilst at the tuyere level and thereabouts the carbon and oxygen in the gases are raised, relatively to the nitrogen, considerably above the amount due simply to the blast becoming transformed into carbon oxide and nitrogen, a little higher up the amounts of carbon and oxygen appear to diminish relatively to the nitrogen; not that they actually do diminish in quantity, but that the evolution of nitrogen from the cyanide decomposition causes their amounts to be lessened relatively to the total nitrogen. Thus the following numbers are calculated from some of Lowthian Bell's observations with an 80 foot furnace using coke and calcined Cleveland ironstone, the gases being obtained by drilling holes through the furnace wall at the different levels, and collecting the issuing gas; the amount of carbon in the gases is manifestly greater at the tuyere than that due to the blast; for some feet it apparently diminishes owing to the cyanide reaction, and then remains almost constant till near the top, where it increases from the expulsion of carbon dioxide from the flux. The oxygen again is considerably in excess of that due to the blast at the tuyeres, but at a somewhat higher level it apparently decreases, whilst higher up still it increases again owing to the reduction of the ferric oxide and the evolution of carbon dioxide from the limestone.

Composition by Weight of Gases at different Furnace Levels.

Height above tuyere in feet .....	0										Blast if wholly burnt	
	6	12	25	37	50	60	76	85	To CO	To CO <sub>2</sub>	To CO	To CO <sub>2</sub>
Carbon dioxide .....	1.2	trace	0.8	1.2	1.6	1.2	3.5	7.9	...	...	...	29.2
Carbon oxide .....	37.6	37.1	35.9	34.9	34.8	34.8	33.2	33.0	34.4	...	...	...
Nitrogen .....	61.2	62.9	63.3	63.9	63.6	64.0	63.3	59.1	65.6	...	...	70.8
Carbon and Oxygen calculated per 100 of Nitrogen.												
Carbon .....	26.8	25.2	24.6	23.9	24.1	23.8	24.0	27.5	22.5	...	...	11.3
Oxygen .....	36.5	33.7	33.3	32.6	33.1	32.4	33.9	41.5	30.0	...	...	30.0

<sup>1</sup> According to Grüner (*Comptes Rendus*, 1871, 28) this reaction is  $3FeO + CO = C + Fe_3O_4$

and does not commence until the iron ore is deoxidized to some considerable extent, at least on the outer surface of the lumps of ore.

Precisely similar results are calculable from the analyses of Tünner, Ebelmen, and others who have examined the composition of the gases at different levels of the blast furnace; the variations in the amounts of carbon and oxygen relatively to the nitrogen at the lower levels in all cases are of such a nature as to indicate that the amount of decomposition of iron cyanide with evolution of nitrogen is very considerable, i.e., that the reduction of iron oxide by alkaline cyanides takes place to an extent constituting a very considerable fraction indeed of the total amount of reduction.

The amount of alkaline cyanides disseminated through the gases of a furnace at different levels varies inversely with the height above the tuyere; thus, in the course of Lowthian Bell's experiments, the following analyses were made by the present writer of the substances dissolved by water through which known large volumes of the gases were aspirated, being drawn from the different levels into a large gasometer,—the weights being given in grammes per cubic metre of gas (at 0° and 760 mm.), and the experiments being all made within a short time of one another (all on the same day):—

Height above tuyere in feet	8	24	60	76	Exit pipe after leaving furnace.
Potassium .....	72.47	14.15	9.18	16.05	3.47
Sodium .....	39.23	17.84	16.69	7.99	1.72
Cyanogen .....	49.06	15.76	7.67	5.94	4.73
Other substances .....	61.31	15.10	9.85	19.38	1.40
Total constituents of the fume soluble in water	222.07	62.85	43.39	49.36	21.32

The amounts of alkaline cyanides were found to be considerably variable from day to day when the gases from any given perforation were examined; thus, for example, the following amounts of combined cyanogen were obtained in two other series of observations with the first and last of these perforations:—

	1st Day.	2d Day.	6th Day.	9th Day.	13th Day.	15th Day.
Eight ft. above tuyere	19.00	12.93	17.32	11.34	20.61	9.16
Exit pipe .....	...	4.00	6.60	3.57	2.91	1.79

In the furnace examined the quantity of gases at a few feet above the tuyere level per unit weight of pig iron made would be about 6 parts by weight, so that per 100 grammes of pig the gases would weigh about 600 grammes, occupying about 0.45 cubic metre. When the amount of cyanogen combined as cyanides disseminated through the gases was 20 grammes (equivalent to 50 grammes of potassium cyanide) per cubic metre (a quantity often exceeded), the potassium cyanide per 100 grammes of pig would consequently be about 22.5 grammes, or about  $\frac{2}{3}$  of the weight of the pig iron, and consequently about  $\frac{2}{3} \times \frac{1}{2} = \frac{1}{3}$  roughly of the oxygen in the form of ferric oxide in the ore originally used; hence evidently the influence exerted by the combined cyanogen upon the removal of the last portions of oxygen must have been very considerable indeed, especially as the cyanides that escape in the gases from the hearth probably represent considerably less than the total amount generated there, a considerable proportion being used up in deoxidizing the iron oxide *pari passu* with its formation. That this is so has indeed been urged long ago by Bunsen and Playfair, who found that the gases drawn from a perforation 2 feet 9 inches above the tuyere of the Alfreton furnace contained cyanogen compounds equivalent to from 8 to 10 grammes of potassium cyanide per cubic metre of gas, much smaller amounts than those above mentioned, but greater than those found on some other occasions when the alkaline substances contained in the fume consisted chiefly of carbonates.

The chief source of the alkalis which form the cyanides is the coke used as fuel, but the ore and flux also usually contain small quantities; when a furnace is newly blown in, the amount of cyanides is necessarily very small; but a very few weeks' use suffices to cause an accumulation of a quantity sufficient to exert a marked influence on the chemical actions taking place, whilst a somewhat longer period brings the accumulation up to the final working average attained when the alkaline compounds mechanically carried off in the fume, and escaping altogether from the furnace through not being intercepted and filtered out by the substances in the upper part, together with those in the cinder, just equal the alkalis brought in by the fuel and burden jointly. It is highly probable, although not absolutely demonstrated, that when charcoal is used as fuel the formation of alkaline cyanides is promoted, owing to the increased quantity of potassium carbonate in the ash of the charcoal as compared with coke; and that this is one of the reasons why the consumption of carbon in the form of charcoal in the Styrian, American, and Swedish furnaces is often less per ton of iron made than that of coke in even the best of the large English furnaces,—the greater ease with which the ores are reduced as compared with English ones being, at any rate in certain cases, another circumstance diminishing the quantity of fuel requisite.

A large number of direct observations as to the progressive changes undergone by the minerals in descending through the furnace have been made, more especially by Ebelmen, Tünner, and

Lowthian Bell, with the general result of showing that the changes as a whole are substantially those above described; as the iron ore sinks, it becomes deoxidized at a rate which at first gradually increases, the temperature rising; but by and by the reduction ceases to increase in rate, and would probably almost stop were the inner portions of the lumps as much reduced as the outer portions. Neither direct experiments on the ores in the furnace, nor laboratory experiments, nor the results deducible from the examination of the composition of the gases at different levels indicate that under the conditions of the blast furnace interior complete deoxidation of the ore ensues until the level of the hearth is reached and the iron begins to fuse,—the agents completing the deoxidation being partly the carbonaceous matter of the solid fuel, but to a much greater extent the finely divided carbon precipitated from the carbon oxide in the upper part of the furnace, and the alkaline cyanides.

20. *Development and Appropriation of Heat in the Blast Furnace.*—The sources of heat in the blast furnace are two in number, viz., the heat brought in by the hot blast, and that generated by the combustion of the fuel. The former of course varies considerably with the nature of the heating arrangement and with the actual weight of blast employed per unit weight of iron smelted; thus, if the weight of air used be 5.5 times that of the pig iron made (110 cwts. of blast per ton of pig), if its temperature be 500° C., and the average specific heat of its components 0.23, the heat brought in per unit weight of pig made will be  $5.5 \times 500 \times 0.23 = 632.5$  heat units, the weight of the pig iron being the unit of weight; and similarly in other cases. The heat generated by the combustion of the fuel, again, depends, first, on the amount of fuel burnt and the proportion of inert matters (ash) in it and other circumstances modifying its heat of combustion, and, secondly, on the relative amounts of carbon oxide and dioxide formed.

In transforming 1 part of amorphous carbon into carbon dioxide, the heat evolution (the materials and products being all at the ordinary temperature) is close to 8000, the following values having been found by different observers:—

Favre and Silbermann .....	8080	Wood charcoal
Despretz .....	7912	Do.
Andrews .....	7800	Do.
Favre and Silbermann .....	8947	Gas carbon.
Do. do. ....	7797	Graphite.

If, again, carbon oxide be burnt to dioxide, the amount of heat is near to 2400 per unit weight of carbon oxide.

Favre and Silbermann .....	2403
Andrews .....	2431

Hence the heat given out in burning one part by weight of carbon to carbon oxide must be  $8000 - \frac{1}{3} \times 2400 = 2400$ , since 3 parts of carbon yield 7 of carbon oxide. If then a given quantity of coke containing 95 per cent. of carbon be burnt, two-thirds to carbon oxide and a third to carbon dioxide, the heat produced will be

$$\frac{0.95}{3} \times 8000 + \frac{0.95 \times 2}{3} \times 2400 = 4053;$$

that is, the heat developed by this combustion of one part by weight of fuel would suffice to raise the temperature of 4053 parts by weight of water through 1° C.; or generally, if  $\frac{m}{m+n}$  of the carbon be

burnt to carbon oxide and  $\frac{n}{m+n}$  to carbon dioxide,  $p$  being the percentage of carbon in the coke (the trifling amount of hydrogen being neglected), the heat development per 100 parts by weight of coke is  $p \left( \frac{m}{m+n} \times 2400 + \frac{n}{m+n} \times 8000 \right)$ . One part by weight of hydrogen furnishes about 34,000 heat units when burnt to liquid water, between 28,000 and 29,000 if burnt to vaporous steam; so that, if  $q$  be the percentage of hydrogen, the total heat development per one part of fuel is close to  $p \left( \frac{m}{m+n} \times 24 + \frac{n}{m+n} \times 80 \right) + q \times 285$ ; if  $q$  is less than 0.5 (as is usually the case) the error caused by neglecting the term involving  $q$  altogether is not greater than that due to the uncertainty about the precise values of the heat evolved in burning carbon to carbon oxide and to carbon dioxide (taken above approximately as 2400 and 8000 respectively).

Knowing the quantity of fuel (coke) burnt and the average composition of the waste gases, together with the amount of flux (limestone) employed, the quantity of carbon dioxide and oxide formed by the combustion of the coke and the amount of blast employed to burn it can be readily calculated; for example, in one of many series of observations made by Lowthian Bell with the present writer's cooperation, it was found that the average composition by weight of the issuing gases was



Carbon oxide .....	25.20 per cent.
Carbon dioxide.....	17.30 " "
Hydrogen.....	0.19 " "
Nitrogen .....	57.49 " "

and that *per unit weight of pig made* the amount of coke used was 1.116, of which 0.096 was ash and moisture, leaving 1.020 of actual carbon, whilst the limestone and mine (calcined Cleveland ore) contained 0.682 carbon and 0.219 oxygen in the form of carbon dioxide, the iron being contained wholly as ferric oxide. The pig contained 3 per cent. of carbon, so that 0.030 of the total carbon entering the furnace did not escape in the gases; consequently the weight that did escape was  $1.020 + 0.082 - 0.030 = 1.072$ , whence the gases (leaving the hydrogen out of consideration) were made up of the following amounts:—

		Containing Carbon.	Containing Oxygen.
Nitrogen .....	3.965	...	...
Carbon oxide.....	1.741	0.746	0.995
Carbon dioxide .....	1.195	0.326	0.869
	9.01	1.072	1.864

The coke, however, contained a small amount of moisture (some 2.5 per cent.), which would escape as aqueous vapour in the gases; this, together with the hydrogen, would make the weight of the escaping gases a little more, about 6.93. The blast introduced containing 3.965 parts of nitrogen (which must have been associated with 1.185 of oxygen forming air) must consequently have weighed 5.150, or making allowance for the moisture contained in it about 5.20 parts; the total oxygen introduced into the furnace, therefore, must have been 1.185 in the air of the blast and 0.219 from the carbon dioxide of the flux; whilst, as the pig contained about 95 per cent. of iron,  $\frac{3}{4} \times .95 = 0.407$  is the corresponding oxygen, making a total of  $1.185 + 0.219 + 0.407 = 1.811$ , to which must be added the oxygen in the moisture of the blast, and that contained in the silica and other impurities reduced in the pig iron, which consequently will give a total very near to the 1.864 parts calculated from the composition of the gases, and consequently to some extent checking the accuracy of the determination.

The total development of heat inside the furnace is then as follows. The carbon contained in the pig, being produced by the reduction of carbon oxide, is formed in virtue of a reaction which absorbs heat; the total fuel added being in the first instance burnt to carbon oxide will develop  $1.020 \times 2400 = 2448$ ; of this a certain portion is further converted into carbon dioxide in the upper part of the furnace, the amount so converted containing of carbon  $0.326 - 0.032 = 0.244$ , and consequently giving a further heat evolution of  $0.244 \times (8000 - 2400) = 1366^1$  (the 0.082 being originally contained in the flux as carbon dioxide); whence the total heat evolution is  $2448 + 1366 = 3814$ .

The heat brought in by the blast is  $5.20 \times 485 \times 0.237 = 597, 485^o$  being the average temperature of the blast and 0.237 the specific heat of air; whilst that taken out of the furnace by the waste gases is  $6.93 \times 332 \times 0.24 = 553, 332^o$  being their average temperature, and 0.24 their average specific heat; hence finally the total amount of heat used up in doing the work of the furnace, and lost by radiation, &c., is  $3814 + 597 - 553 = 3858$ .

In a similar way in a number of other instances the quantities of heat used up in the various furnace requirements were measured, with the general result that, with large furnaces of the construction employed in the Cleveland and Durham districts (48 to 80 feet in height), smelting calcined Cleveland ironstone either alone or mixed with hematite, a certain amount of heat is required for purposes practically constant and not varying with the richness of the ore and the amount of flux consequently requisite; whilst another portion of the heat is used up for purposes which are much more variable. Including the heat absorbed in the reduction from the gases of the carbon in the pig, the comparatively constant requirements of such furnaces are close to 2600, so that in the instance taken for example above, the non-constant requirements amounted to about 1258, the two sets being made up as follows:—

Comparatively constant heat requirements.		Approximate average amount
Heat absorption during reduction of iron from ferric oxide .....	carbon from carbon oxide .....	1650
" " " phosphorus, silicon, and sulphur .....		72
Heat carried away by water used to cool tuyeres .....		269
" " molten pig .....		91
" " radiation and conduction .....		330
		248
		—2600
More variable heat requirements.2		
Heat absorption during causticizing limestone flux .....		250
" " decomposition of moisture of blast .....		142
" " evaporation of water in coke .....		16
Heat carried away by molten slag (one part of slag carrying away 550 units of heat).....		850
		—1259
		3858

Similar results were obtained in several other analogous series of observations, the variable heat requirements differing somewhat in some instances on account of the use of poorer or richer ores, different amounts of flux, &c.; for the details of the methods used in the determination of the various items of furnace requirements see Bell's *Chemical Phenomena of Iron Smelting*, and also the earlier experiments of Vathaire (*Etude sur les Hauts Fourneaux*). Various publications of Grüner, and also an essay by Habets (abstracted in the *Journ. I. and S. Inst.*, 1877, 225) may also be consulted with advantage; the numerical values of certain of the items deduced by Grüner from his observations differ somewhat from those of Vathaire and Bell, but not to any very material extent. The general result of these observations is that, with the large English furnaces used in smelting Cleveland ironstone with coke and limestone, about 3850 is the amount of heat required on an average per unit of weight of pig iron made for the various furnace requirements, and that in even the most economically working furnaces the quantity of carbon contained in the issuing gases in the form of carbon dioxide *does not exceed one-third of the total quantity of carbon, and rarely exceeds 30 per cent. of that amount*, the remainder passing out as carbon oxide. Some of the carbon that does escape as dioxide, about one-fourth, is originally introduced as carbon dioxide contained in the flux (in the illustrative example, given above, 0.082 was contained in the flux out of 0.326 escaping as dioxide), so that only about three-fourths is derived from the fuel; whence it results that even under the most favourable conditions, rarely met with in practice with this class of ores, not more than  $\frac{1}{3} \times \frac{3}{4}$ , or 25 per cent., of the carbon of the fuel is ultimately burnt to dioxide, the remaining 75 per cent. being burnt to carbon oxide, thus giving an effective heat development of  $0.25 \times 8000 + 0.75 \times 2400 = 3800$  instead of 8000; i.e., the "duty" actually performed by the fuel is only  $\frac{3800}{8000}$ , or 47.5 per cent. of the possible maximum amount; so that if the amounts of heat brought in by the hot blast, and carried out in the waste gases, are approximately equal (which is the case when ordinary cast iron stoves are used, delivering blast at temperatures near 450°), it finally results that, to produce the heat requisite for the various furnace requirements (amounting on an average to 3850), an amount of carbon must be burnt equal to  $\frac{3850}{3800}$  or 1.013 times the weight of the pig iron made. Taking average coke to contain 7 per cent. of moisture and ash, and, consequently 93 per cent. of carbon, this represents  $\frac{1.013}{0.93} = 1.089$  parts of coke per unit weight of pig iron, or  $21\frac{3}{4}$  cwt. per ton as the *minimum practicable consumption of fuel attainable with calcined Cleveland ironstone, under the condition that the blast brings in as much heat as the waste gases carry out*.

It does not by any means follow, however, that only this minimum practicable consumption of coke will be requisite in any given furnace. When the dimensions are not such as to cause the most economical employment of the fuel, a considerably larger quantity of fuel may be requisite to enable the whole of the iron in the

<sup>1</sup> Lowthian Bell calculates the total carbon in the carbon dioxide of the waste gases as being formed from carbon oxide, considering that the carbon dioxide of the flux is converted into carbon oxide by the hot carbon of the fuel *pari passu* with its formation; and hence introduces an additional item into the table of furnace requirements, viz., the heat absorbed in this conversion, and an additional complication into the calculation owing to the subtraction of the carbon of the fuel thus supposed to be consumed in the upper part of the furnace from that burnt by the blast at the bottom.

<sup>2</sup> Exclusive of that due (according to Bell's mode of calculation) to absorption of heat by the carbon dioxide of the flux in being converted into carbon oxide.





amount that would be requisite could perfect combustion be effected. If, however, the issuing gases be so burnt in heating the blast that more heat is brought into the furnace than is carried out by the waste gases, the excess is virtually obtained by more perfect combustion, though not actually so burnt inside the furnace; whilst, if the gases are also employed to raise steam for the blowing engines and lifts, &c., the fuel thus saved virtually is equivalent to a diminution in the blast furnace consumption; for, were perfect combustion obtainable in the furnace, extra fuel would have to be burnt outside for these purposes.

These remarks apply *a fortiori* to furnaces in which coal is employed as fuel instead of coke or charcoal. The heat of combustion of average coal (after allowing for ash and supposing it to be burnt to carbon dioxide and water vapour) may be taken as about 8300 (see § 10); hence to afford sufficient heat for the requirements of a furnace smelting average Cleveland ironstone, viz., 3350, only  $\frac{3350}{8300} = 0.404$  parts of coal would be requisite, could complete combustion be ensured, or 9½ cwt. per ton of pig (assuming the sensible heat carried out by the waste gases and brought in by the blast to be equal). The actual consumption in furnaces using raw coal is, however, several times this amount,—30 cwt. being a low estimate in such cases, whilst 40 and even 50 cwt. of coal per ton of pig made is not an infrequent consumption: thus even with Ferrie's self-coking furnace (§ 12), which reduced the consumption of coal from 52.5 to 33.5 cwt. per ton of pig, the consumption was upwards of three times the theoretical amount; with anthracite-consuming furnaces, such as those used in America, the consumption of fuel varies from 25 cwt. per ton of pig in the largest and best constructed furnaces to 40 cwt. or so in the older and smaller furnaces, the consumption being as a rule, however, somewhat less than that of more bituminous raw coal in the English open-topped furnaces. The reason for the extra fuel consumption in raw coal furnaces is simply that the nature of the chemical reactions taking place in the upper part of the furnace, especially the action of heat alone upon the coal, necessarily causes the evolution of much free hydrogen, carburetted hydrogen, and carbon oxide, which escape unburnt, thus preventing the consumption of the fuel to the maximum advantage: where the gases are collected and burnt, this loss would not be material were it not that ordinarily the heat obtainable from the gases is far in excess of that requisite to raise steam for blowing and lifting the burden to the furnace top, &c. These reasons are also to a great extent operative with anthracite as compared with coke. On the other hand, the smaller weight of charcoal ordinarily requisite to smelt a given ore is partly due to the more ready action of carbon dioxide on charcoal than on coke forming carbon oxide, so that virtually the ore is partly reduced by the carbon of the charcoal (this being converted into carbon oxide, which deoxidizes the ore) to a greater extent with charcoal than with coke; i.e., the charcoal is more completely oxidized, and the ore is more deoxidized at the top of the furnace and less at the bottom than is the case (*cæteris paribus*) with coke, so that a smaller weight of charcoal ultimately performs the same work as a larger quantity of coke. The larger amount of alkalis in charcoal, producing more cyanides, probably also aids in the more rapid reduction relatively to the weight of fuel used.

In a prize essay, Professor Habets has given formulæ for calculating the value of a given weight of iron ore of given composition, the price of the pig iron made from it, and the quantities of ore and limestone requisite to produce a unit of weight of pig, &c. (see abstract in *Journ. I. and S. Inst.*, 1877, 225), and has also arranged formulæ for calculating the amount of fuel that ought to be required for the smelting of such ores, &c., assuming that the duty actually performed by the fuel is 43 per cent. of the possible maximum amount. In these calculations slightly different values are taken for certain of the heat requirements from those given above; thus for the reduction of pig iron (containing carbon, silicon, &c.) the total heat consumption is taken as 1934, the amounts assumed by Bell, Crossley, and Tunner as above described being respectively 1931, 1871, and 1670; that carried out by the molten pig is taken at 260 for cold working, 270 for medium, and 285 for hot, Bell's figure (and Vathaire's) being 330, whilst Tunner takes 340 from Rinnann's observations; and the loss by radiation (presumably including the typer water) is taken as 400 (Bell—349—deduced by the present writer from a round general average result by difference: Crossley—359; Tunner—192, the furnace being a much smaller one in this latter case), and so on throughout; but on the whole Habets's formulæ are based on much the same valuations as those above cited. The instances given above, however, indicate that the results obtainable with one class of ores, fuels, &c., are only applicable to another class with considerable latitude of variation, and that it is impracticable to fix a hard and fast line as the limit of economy of fuel

universally applicable. Where, however, the fuel is burnt differently (to less advantage, for instance, so that, instead of one part of carbon giving 0.43 of the total heat production as "duty," it only gives say 0.40), the formulæ of Habets will still be applicable, only requiring the application of a coefficient ( $\frac{0.40}{0.43} = 1.2$  in the case supposed).

*Temperature of Blast Furnace at Various Levels.*—Many observations of the rate of increase of temperature from the mouth of the furnace have been made by Tunner, Ebelen, and Lowthian Bell. When fresh materials have been just introduced cool into the furnace, of course they intercept heat from the escaping gases, acting precisely like the brick-work stacks of a Siemens regenerative furnace; this effect, however, cannot be carried so far as to prevent the escaping gases from passing out at an average temperature which, if not elevated, is at least sensible,—the actual temperature varying with the conditions obtaining. Since heat is generated by the reduction of ferric oxide by carbon oxide, more heat being evolved by the oxidation of the carbon than is absorbed in the reduction of the iron oxide, roughly in the ratio of 3 to 2, it results that there is always a source of heat in the upper part of the furnace; and, unless fresh materials can be supplied sufficiently rapidly to keep the escaping gases always at a given low temperature by their direct cooling effect, the temperature must rise by the reduction of the ore. A condition of equilibrium as to temperature is consequently finally arrived at when the sums of the generations of heat by chemical action at each and every particular level, and of the absorptions of heat by direct communication to the fresh charges added from time to time, balance one another; when this condition of things is arrived at the temperatures of the escaping gas, and of the substances generally at each level, become constant, or rather would do so were the fresh materials added continuously instead of intermittently, and were the action of the furnace absolutely uniform. The circumstances which regulate the most advantageous way in which fuel can be burnt, i.e., the economy of fuel in the furnace, consequently regulate the temperature of the escaping gases, which accordingly is variable with the quantity of fuel burnt per unit of iron smelted, with the size and shape of the furnace, the character of the ore employed, &c. Under particular conditions, especially when a large mass of fresh materials has been added, the escaping gases may be so cool that the aqueous vapour present is condensed into mist, whilst the hand may be placed in the gases without being burnt; ordinarily, however, the temperature at the mouth averages 200° or 300° C., and with small furnaces and difficultly reducible ore requiring a large fuel consumption may be much higher. One great effect of increasing the height of furnaces smelting clay ironstone (e.g., Cleveland ore) is the reduction of the amount of fuel requisite owing to the cooling influence exerted upon the temperature of the escaping gases which pass off, thereby leaving in the furnace heat which otherwise would have to be provided by burning more fuel. Of the numerous particular determinations that have been made of the temperatures at different levels in different cases, the following may be cited as examples:—

*Wärna Furnace (Eiswerk): height 36 feet; using soft charcoal with a burden of syathic ore, cast iron scrap, and grauwacke-schist (as flux), in the proportion of 333, 8, and 20 respectively (Tünner and Richter).*

Distance from top in Feet.	Temperature.	Distance from top in Feet.	Temperature.
0	320°	21	840° C.
7	340°	24	910°
11	350°	25.5	950°
15	640°	29	1150°
17	680°	34	1450°

The temperature values were deduced by introducing alloys of known melting points, and noticing which were fused.

*Clarance Furnaces; using hard coke and caustic Cleveland ironstone with limestone as flux (Loithian Bell).*

Distance from top in Feet.	Fifty-eight foot Furnace.	Eighty foot Furnace.
0 (Exit gases).	452° C.	532° C.
4.25	Not visibly red hot.	N. 1 visibly red hot
9.75	Dull red heat.	Do. do.
15.50	Bright red heat.	Dull red heat
21.25	Very bright red heat.	Bright red heat.
26.75	Do. do.	Very bright red heat

A paper on the "Thermic Curves of Blast Furnaces," discussing a number of results of this class, and the conclusions to be drawn from them, by H. M. Howe, is given in the *Trans. Amer. Inst. Mining Engineers*, 1876; see also *Iron*, vol. x. p. 326 sq.

21. *Conditions Regulating Economy of Fuel and Cost of Production.*—It is evident from the data given in the preceding section that, when the amount of cinder formed is less, a smaller quantity of fuel will do the work of iron smelting, the amount of heat absorption for the variable requirements being lessened the less limestone is causticized and the less hot cinder flows out of the furnace. Evidently also, the hotter the blast and the cooler the issuing gases, the less fuel must be burnt to generate the particular amount of heat requisite for a given furnace working under given conditions as to quality of ore, &c.; whilst the more carbon is burnt to carbon dioxide and the less to carbon oxide the less total carbon is requisite for the same end. As regards the possibility of diminishing fuel consumption by the use of richer ores and less flux, this is largely a matter of local circumstances; when there is a choice possible between two deposits of ore, one richer than the other, and each equally good in other respects, the cost of smelting the richer ore will evidently be somewhat less than that of working the other; as regards the other circumstances, it is by no means a matter of indifference in reference to cost of production whether the more economical conditions be attended to or not; thus, in the case of the 48 and 80 foot furnaces referred to in the last section, the difference between 22.3 and 28.8 cwts. of coke consumed per ton of iron involves a very considerable difference in cost of production. It is calculated that the increased size of furnaces used in England at the present day, as compared with those in use some thirty or forty years ago, represents an average saving of fuel equivalent to about 50 per cent. of the weight of the pig iron made in coal, i.e., a saving of 10 cwts. of coal per ton of iron. The saving effected by the use of waste gases for heating the blast, although less than this, still represents an enormous aggregate; in the Cleveland district alone the saving in coal from this cause is calculated to amount to upwards of 1,000,000 tons annually.

To some little extent the amount of fuel consumed is variable with the rate at which the furnace is driven; that is, if a given quality of pig is produced when the furnace is making 300 tons per week with a given coke consumption (the fuel being burnt under the most favourable conditions practicable), and the furnace be then driven at a higher speed so as to make 400 tons, either a little more coke must be added relatively to the burden, or else there will be a tendency to make a less strongly marked crystalline pig; instead of producing the coarsest crystallized iron (No. 1 grey pig), this quality will sink to the less largely crystalline numbers (Nos. 2, 3, or 1), or even to mottled or white iron. If, however, the fuel is not burnt to the maximum possible advantage in the first instance, increasing the rate of production may under certain circumstances not only not cause an increase in the fuel consumption, but may even slightly diminish it, by lessening the amount of heat lost by radiation, &c., relatively to the metal produced, everything remaining the same, decreasing the fuel relatively to the burden decreases the quality of the iron run, and *vice versa*: with Cleveland ironstone an extra consumption of half a cwt. or less of coke per ton of pig suffices to raise the quality of iron run one number in the scale, i.e., from No. 4 to 3, from 3 to 2, or from 2 to 1. According to Crossley (*loc. cit.*) about 2 cwts. of coke per ton of pig corresponds to the difference between running white iron and grey Bessemer pig, the ore smelted being Askam hematite and Fisher Red Bay ore. Tunker states (*loc. cit.*) that at Neuberg,

with a blast at 200°, from 15.4 to 15.6 cwts. of charcoal were used per ton of white iron, but 23 to 24 cwts. per ton of grey iron, making a difference of some 8 cwts. per ton, or four times the amount given by Crossley; at 110°, with a blast at 200°, 12.6 to 14 cwts. of charcoal were formerly required per ton of white iron, and 20 cwts. and upwards per ton of grey iron, making a difference of more than 6 cwts. per ton, or upwards of three times Crossley's figure. Although a variation in the amount of fuel burnt under constant conditions denotes a correlative variation in the temperature of the hearth (No. 1 iron being actually hotter as it flows from a furnace in regular work than No. 4, for instance), yet the influence thereby produced on the chemical composition is, according to Loithian Bell's experiments, not marked, at any rate so far as Cleveland pig is concerned, the differences between various specimens of different numbers not being greater than those between various specimens of the same numbers,—the difference in the crystallinity of the pig being in fact more probably ascribable to the circumstance that the hotter the iron the longer is the time taken to solidify, and the more completely is the exsolution of the graphite and the crystallization upon it of the remaining iron, &c., effected, than to differences of actual constitution. On the other hand, it is a matter of usual opinion, if not of invariable experience, that highly crystalline grey Bessemer pigs are richer in silica than others, and that this is due to the higher temperature of the hearth facilitating reduction of silicon; again, it is usually considered that white irons are apt to contain more sulphur than grey irons made from the same ore; this circumstance, however, is possibly rather due to differences in the average composition of ore smelted and amount of flux added than simply to variations in amount of fuel consumed; thus diminishing the amount of lime added as a flux below a certain point often increases the sulphur in the pig, so that upwards of 1 per cent. may be present, when with more lime the quantity would be only one or two tenths per cent., the iron being white in the first case and grey when more lime is employed.

As regards the temperature of the blast, the fact that heating the blast enabled iron to be made with much less fuel consumption than was requisite with cold blast was recognized immediately after Neilson's discovery or invention; but it soon became also manifest that a deteriorating effect was often produced upon the iron smelted from certain kinds of ore by the use of the hot blast, due to the higher temperature attained in the hearth facilitating the reduction of phosphorus, sulphur, and especially of silicon. The advocates of the very highly heated blast obtainable by means of the Whitwell stove consider that, as the heat is obtained from the waste gases at a comparatively nominal cost, the more heat can be thus introduced into the furnace the better, the saving in fuel being directly proportionate to the increase in blast temperature; it would seem from Bell's observations, however, that the advantages thus obtainable are not always quite so great as appears at first sight to be the case. If less fuel be burnt in the furnace, a less absolute weight of blast per given amount of pig run will be requisite, and consequently a higher proportionate temperature must be given to the blast to enable it to introduce the heat equivalent to the fuel thus saved; for each successive diminution of fuel to the extent say of 1 per cent. an increase in temperature of blast will be requisite, the rate of increase not being constant, but accelerating at a rapid rate; so that finally an increase in blast temperature of 100° from 1100° to 1200° only represents about half the amount of heat introduced into the furnace that would be introduced by raising the blast from 300° to 400°. The advantage of highly heating the blast then is not directly proportionate to the temperature attained as regards saving of fuel, but something less; according to Bell, practical experience shows that with certain ores, e.g., Cleveland ironstone, the effect of highly superheating the blast to temperatures much above 500° is not to render any considerable saving of coke practicable, but mainly only to raise the temperature of the issuing waste gases. Other iron masters, however, dissent from this view, and consider that by the use of a blast heated to 700° and upwards by a Whitwell stove, instead of to 450° or 500° by the older iron stoves, a distinct saving in the amount of coke requisite to produce a ton of pig iron from Cleveland ironstone is



effected; so that, instead of requiring an amount of coke to be consumed equal in weight to about 1.09 times that of the pig iron made (nearly  $21\frac{3}{4}$  cwts. per ton), which as stated in the previous section is the minimum practical average consumption possible when the amount of heat brought in by the blast about equals that carried out by the waste gases, a smaller amount of fuel will suffice, from 0.95 to 0.90 parts of coke (19 and 18 cwts. per ton) only being necessary with blast heated to 700° and upwards by a Whitwell stove, the heat carried out by the waste gases being less than that brought in by the blast by an amount equal to that which would otherwise have been generated by the fuel saved. With ores other than Cleveland ironstone the same kind of result is obtained; not only in England and Wales, but also in France, Germany, Switzerland, America, and elsewhere, the Siemens-Cowper and Whitwell stoves have been extensively adopted on account first of the saving of fuel effected by them, and secondly of the greater regularity and efficiency in working.

On the other hand there is no doubt that increasing the height of a furnace smelting calcined Cleveland ironstone from 48 to 80 feet causes a considerable saving in fuel; as shown in the previous section, the increased height acts partly by permitting the gases to escape at a lower temperature, and partly by enabling the fuel to be burnt with the formation of a smaller relative proportion of carbon oxide and a larger one of carbon dioxide than is the case with the smaller furnace. When, however, a still greater height is given to the furnace, a further saving in fuel and larger relative production of carbon dioxide do not seem to occur, furnaces of 90 and 100 feet in height not exhibiting any marked advantages over 80-foot furnaces working under the same conditions, so far as consumption of fuel is concerned. Even if Bell's views as regards the non-apparent advantage of increasing the blast temperature above 500° C. with the furnaces smelting Cleveland ore experimented on by him be admitted to apply in all cases where this ore is used, it does not follow that they are applicable to other furnaces smelting different kinds of ore, nor does it follow that 80 feet in height is the limit beyond which no visible saving is effected in all cases; thus for instance with a furnace smelting (at Consett) a mixture of Cleveland ore and hematite in such proportions that about half the iron made came from each ore, a distinct saving of coke was found to accompany the substitution of Whitwell stoves giving blast at about 720° for iron stoves giving blast at about 450°; whereas with the less heated blast the coke consumption was 22.75 cwts. per ton of iron, with the hotter blast it was only 18 cwts., the conditions, character of ore and flux used and pig produced, &c., being pretty nearly the same, the furnace being 55 feet in height in each case. Again, on rebuilding such a furnace (for the purpose of using the same mixture of ores) to a height of about 70 feet, it was found that the increased dimensions, so far from producing the beneficial effects which such a change would have given had Cleveland ore only been used, introduced such irregularities in working that the height had to be reduced to the former amount, 55 feet or so. Similar results have also been found with furnaces using Lancashire hematite only; thus a Barrow furnace built to the height of 75 feet, and using Cowper stoves, worked so badly that it was reduced to 61 feet, when it worked well. Analogous results were also obtained at Workington, a 70-foot furnace working much better when cut down to 55 feet; in America also it has been found that charcoal furnaces, increased materially above the original height, worked irregularly until the height was reduced again, when the working again became good. With easily reducible Belgian ore furnaces of 50 to 60 feet in height are found to give the best results both as to quantity of iron run and as to economy of fuel. On the other hand, an increase in height from 45 to 60 feet in furnaces smelting Staffordshire ores was found to cause an average saving of upwards of 10 cwts. of coal per ton of iron (Plum, *Journal I. and S. Inst.*, 1871, ii. 227), whilst two furnaces at Stanhope (New Jersey) using magnetic ore, one 80 feet high and of 16,400 cubic feet capacity, the other 55 feet high and of 9200 cubic feet capacity, differed by several cwts. in the amount of coal requisite to produce a ton of pig, the difference being in favour of the larger furnace; similarly at Glendon, U.S., two furnaces, 72 and 50 feet in height and 11,900 and 4800 cubic feet capacity respectively, differed by 3 to 4 cwts. of coal per ton of pig, the taller furnace requiring the least fuel (F. Firmstone, *Trans. Am. Journ. Mining Engineers*).

With charcoal furnaces smelting grey iron, increasing the blast temperature from about 200° to 400° or 500° C. causes a marked saving of fuel; but the utility of heating the blast above 300° or even a somewhat lower limit for such furnaces when making white iron is regarded by Tünnner as extremely doubtful: thus he states

(*Journal I. and S. Inst.*, 1873, 442) that charcoal furnaces at Neunberg which used 23 to 24 cwts. of charcoal per ton of grey Bessemer pig (and only about  $15\frac{1}{2}$  for white iron) when the blast was at 200°, only required 19 to 20 cwts. per ton of grey pig when the blast was heated to 500°, representing a saving of some 4 cwts. per ton of charcoal; similarly at Heft the charcoal consumption was 20 cwts. and upwards per ton of first class grey Bessemer pig with blast at 200°, and only 17 to 18 cwts. with blast at 350° to 400° C., representing a saving of at least  $2\frac{1}{2}$  cwts. of charcoal per ton of pig. Analogous results have also been recorded as obtained with Carinthian furnaces, a saving of 25 to 30 per cent. in the charcoal used accompanying the heating of the blast to 500° or 600° instead of the much lower temperature formerly employed; similarly with Swedish charcoal furnaces smelting bog ores, the use of hot blast at 350° instead of cold blast producing a saving in fuel estimated as averaging one-third, or 33 per cent. of the larger amount, and the employment of blast at 200° effecting a saving of one-fifth, or 20 per cent., with mountain ores (*Jern-Kunskets Annaler*, 1859, p. 273). The much smaller consumption of fuel in the Wrba coal furnaces and others using certain Austrian ores as compared with English coke furnaces appears, from the results of Tünnner, quoted in the last section, to be mainly due to the smaller amount of slag produced, and the consequently diminished furnace requirements, a portion of the diminution being due to the somewhat larger formation of carbon dioxide relatively to the carbon oxide in the escaping gases; with other ores producing more cinder, the quantity of charcoal used per ton of iron run does not seem to be materially less than the amount of coke employed with English furnaces, so far as comparisons can be instituted.

On the whole, the precise details as regards the dimensions of furnace, temperature of blast, &c., the use of which will enable iron to be smelted from a given kind of ore with a minimum expenditure of fuel, cannot always be distinctly stated, the requisite data not existing: evidently the data available for one class of ore and fuel and iron produced are not applicable without material correction to other classes.<sup>1</sup> All existing experience, however, goes to show that the blast furnace is an instrument in which it is impossible completely to utilize the calorific power of the fuel burnt. Owing to the nature of the complex reactions regulating the resultant chemical changes taking place in the furnace, a considerable proportion of the fuel inevitably must escape as carbon oxide, and it is not practicable to restore to the furnace the whole of the heat thus not utilized by employing the waste gases to heat up the blast, although a portion of this heat may thus be saved. Thus, in the case of average Cleveland ironstone, the 3850 units of heat per unit of weight of pig requisite for the various items of furnace consumption would be obtained by the combustion of less than 0.5 part by weight of carbon (representing 10 cwts. of carbon or less per ton of pig, *i.e.*, about 10.5 cwts. of average coke per ton of pig), could all the carbon be burnt to carbon dioxide; whilst for ores containing less earthy matter, and hence requiring less flux and producing less cinder, considerably smaller amounts would be required, in some cases not more than 7 or 8 cwts. per ton. In practice, even with the most economical arrangements at present known, the consumption of fuel is largely in excess of the minimum quantity thus theoretically requisite, the coke used varying from 18 or 19 cwts. in the most favourable cases to 25 and even 30 cwts. per ton of pig under less economical conditions.

A portion of the excess of fuel thus burnt may be utilized in generating steam by burning the waste gases under the boilers. Bell calculates that somewhat upwards of 1400 heat units per unit weight of pig iron were thus utilized in the works serving as the chief basis of his inquiries,

<sup>1</sup> An instructive essay by J. Walters on the best-known means of increasing the production of blast furnaces without at the same time interfering with the quality of their products, discussing the dimensions as regards height, diameter of both size and throat, &c., and other conditions best suited for certain classes of ores, is to be found in the *Revue Universelle*, 1877, and in abstract in the *Journal I. and S. Inst.*, 1877 (*Foreign Report*), p. 125. See also papers by T. Whitwell (*Iron*, 1876) "On the Construction, Dimensions, and Management of Blast Furnaces."





from 7.65 to 2.95 per unit of pig iron made, the saving with the Welsh ore similarly represented a reduction in consumption at the Plymouth Works, Merthyr Tydvil, of from 53 to 36 cwt., or from 2.65 to 1.80 per unit of pig iron; so that if the Scotch iron master could compete on equal terms with the Welsh one when cold blast was used, he would have a decided advantage over the latter when hot blast was employed. Accordingly it became a matter of advantage to the Welsh smelter to smelt hot blast metal, because its manufacture gave him less profit relatively to smelters in other districts than that of cold blast metal.

Even at this early period, consequently, it was manifest that the advantages derived from a given modification of plant and processes attainable with one class of ore were not necessarily producible with another class; Dufrenoy found that the furnaces of La Guerche, smelting an impure ore containing 42 per cent. of iron, derived little or no benefit by the substitution of hot air for cold; the fuel used in each case amounted to some 25 cwt. per ton, and the only discernible advantage derived from the hot blast was that the resulting iron became grey instead of white, doubtless from the higher temperature of the issuing pig enabling the graphite to separate more readily whilst cooling and solidifying. Iron masters, however, have often failed to appreciate the truth of the proposition that what is advantageous for one ore may not necessarily be so for another; and in consequence very different estimates of the value of new processes and improvements have frequently been made, some condemning them wholly, because under the circumstances of their own particular experience no remarkable advantages accrued; others regarding them as universally beneficial, because under the different conditions of their experience a distinct advantage was gained. The early history of the Bessemer process for producing malleable iron and semi-steel direct from pig by decarbonizing it by blowing air through it affords a good illustration of this point, the process being at first considered by some a complete success, and universally applicable, good metal having been made by them from certain kinds of pig iron (naturally almost free from sulphur and phosphorus); whilst others regarded it as a failure because the less pure pig experimented on by them yielded only an inferior product.

V. CONVERSION OF CAST IRON INTO MALLEABLE IRON AND STEEL BY DECARBONIZATION.

22. Production of "Malleable Cast Iron."—It has been known for upwards of a century and a half that when articles of cast iron of not too great thickness are imbedded in powdered iron oxide (a pure red hæmatite as free as possible from earthy matters, smithy scales, or some

obtained from 100 of raw coal) was equivalent to 8 tons 1½ cwt. per ton of pig (8.06 per unit of pig iron) when cold blast was used; in 1830, when hot blast was used with the same coke as fuel, the consumption was reduced to an amount equivalent to 5 tons ¾ cwt. (5.16 per unit of pig); and in 1833, when a hotter blast and actual raw coal were employed, the consumption was only 2 tons 5¼ cwt. per ton of pig (2.26 per unit of pig), this being exclusive of 8 cwt. of coal used in heating up the blast, making a total of 2 tons 13¼ cwt. (2.66 per unit of pig),—figures substantially the same as those of Dufrenoy, representing a reduction in fuel consumption nearly in the ratio of one to three parts of Scotch coal used (as coke) with cold blast and Scotch ore. Much the same figures have also been given by Mushet: thus he states that in 1797 with cold blast the consumption of coal at the Clyde works was 7 tons 3 cwt. per ton of pig (7.15 per unit), whereas in 1839 with hot blast it was only 2 tons ¾ cwt. (2.175 per unit). On the other hand during the course of a lawsuit entered upon by Neilson to enforce his patent rights, attempts were made to show that the alleged saving in fuel due to the hot blast was really owing to other causes; and subsequently similar views have been urged, perhaps with not wholly disinterested motives; thus Truran states in his work that at Dowlais the coal consumption per ton of iron was reduced to the following extent between 1791 and 1831 by improvements other than the use of hot blast, cold blast being used throughout, with the following consumption per ton of iron:—

	1791.	1831.
Coal used for coke making .....	6 tons 6 cwt.	2 tons 10 cwt.
" " engines and calcining .....	1 .. 15 ..	... 17 ..
Total.	8 .. 1 ..	3 .. 7 ..

Very probably the increased dimensions of furnaces and various other causes all contributed to this large diminution; but it does not therefore follow that substituting hot blast for cold did not diminish the consumption still further. That such a substitution did actually save fuel with ores and coal from South Wales is shown by Dufrenoy's figures.

analogous substance) and then kept at a red heat for some days (three or more according to the thickness), a diminution is produced in the amount of carbon contained, so that the cast iron becomes more or less converted into soft iron. When the action is pushed to the extreme all or almost all of the carbon is removed, that in the outer layers disappearing first, but no material diminution in the amount of phosphorus, silicon, sulphur, or manganese is produced; if the heating is not continued long enough to remove all the carbon, that which remains is found in the innermost layers which constitute a core of more or less decarbonized cast iron, with an outer skin of malleable iron. Owing to the non-removal of constituents other than carbon, it is essential to the production of a good malleable metal that a tolerably pure cast iron should be employed in the first instance: unless the articles are thin, so that there is no considerable inner core of cast iron, they will not bear forging so as to weld them, the concussion fracturing the brittle core; on the other hand, the removal of the carbon from the outer skin renders this so much less readily fusible than cast iron that articles so treated (e.g., melting pots and crucibles) will bear a very much higher temperature than cast iron vessels, especially if the core is almost wholly decarbonized; whilst a much greater degree of toughness and power of resisting fracturing influences is communicated. Accordingly this method of preparing cheap small malleable iron articles by casting and subsequently decarbonizing is largely employed, the goods produced being known as "run steel"; whilst even with much larger castings, such as the propellers of screw steamers, the method is often adopted, especially in combination with "case hardening" or conversion of the outermost layer of all into steel by a subsequent process (*vide infra*). Although the process was described in 1722 by Réaumur, patents for it have been subsequently taken out, e.g., by Lucas in 1804, and Brown and Lennox some half century later.

In order to carry out the conversion of cast iron into malleable iron in this way, the articles to be treated are packed in cast or wrought iron chests in iron oxide powder; the chests are then stacked one above another in a kind of reverberatory furnace, and gradually heated up to a red heat, which is maintained for the requisite time, after which they are annealed by slow cooling; with charcoal pig pretty free from silicon, sulphur, and phosphorus, and with fuel in the furnace free from any large quantity of sulphur, a soft but tough, tenacious, and readily malleable skin is produced; if, how-

<sup>1</sup> Analyses by W. A. Miller, quoted in Percy's *Metallurgy* ("Iron and Steel," p. 111), seem to indicate entire removal of sulphur and partial purification from silicon; thus:—

	Before Treatment.	After Treatment.
So-called combined carbon .....	2.217	0.434
Graphite .....	0.553	0.446
Silicon .....	0.951	0.409
Aluminium .....	trace	trace
Sulphur .....	0.015	nil.
Phosphorus .....	trace	trace
Sand .....	0.502	...

Probably the cast iron contained irregularly distributed intermixed cinder, the silica of which was counted as silicon. When cast iron plates are slowly oxidized by hot air, according to Tünner, the silicon diminishes, as it does during refining and in the first stage of the Bessemer process; but recent analyses of "malleable cast iron" articles made on the large scale by cementation in hæmatite powder show that substantially no change whatever occurs in the phosphorus and silicon, and that what alteration there is in the sulphur is rather in the direction of increase (from the presence of sulphur in the fuel) than otherwise. For instance—

	Original Iron.	Malleable Cast Iron after two Annealings.	Original Cast Iron.	Malleable Cast Iron after two Annealings.
Total carbon .....	2.44	less than 0.10	3.45	less than 0.10
Silicon .....	0.445	0.614	0.585	0.449
Sulphur .....	0.039	0.162	0.105	0.083
Phosphorus .....	0.315	0.295	0.280	0.313
Manganese .....	0.129	0.575	0.585	0.525

ever, the heating is continued for some time after the whole of the carbon originally present has been removed, the articles become brittle, owing to the formation of oxide of iron disseminated through the mass, just as copper, bronze, and analogous substances are rendered brittle through a similar cause. This circumstance, together with the known character of the chemical actions of carbon dioxide on iron and carbon at a red heat, indicates the nature of the processes taking place during the decarbonization: the ferric oxide and the heated air in contact with it first oxidize the carbon in the outermost film to carbon dioxide; this then passes inwards by the process of "occlusion" (gradual solution of gases in solids), and reacts upon the carbon of the next layers in accordance with the equation

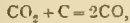

the carbon oxide thus formed first becoming dissolved in the iron, and subsequently when the iron is saturated therewith gradually diffusing outwards, becoming converted into carbon dioxide as soon as it comes in contact with either the ferric oxide of the packing or the partially oxidized iron of the outer film, which, when free from carbon, reacts on the carbon dioxide, thus

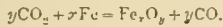

In the outermost layers, accordingly, there is always a tendency to the formation of iron oxide in virtue of this reaction, and simultaneously a tendency to the reduction of this oxide by the agency of the carbon oxide which is being formed in the interior layers and travelling outwards; as long as this latter action keeps the former in check, the accumulation of iron oxide in the outer layers does not take place to such an extent as to deteriorate materially the tenacity of the malleable iron skin; but, when the carbon of the core has been completely removed that the supply of carbon oxide from the interior almost ceases, the formation and accumulation of iron oxide in the outer layers goes on, rendering them more or less brittle. In the inner layers the removal of carbon by the penetration of the dissolved carbon dioxide and its reaction on the carbon is continually progressing, the decarbonization gradually creeping inwards, as it were, until finally the innermost central part becomes decarbonized also. The non-removal of silicon, sulphur, and phosphorus during the process is due simply to the fact that these elements are not acted upon by the occluded carbon dioxide as the carbon is, and consequently not being oxidized cannot be eliminated. The iron oxide used becomes partially reduced during the operation; in order to make it fit for use over again, it is moistened with a solution of sal-ammoniac and exposed to the air in order to rust and so re-oxidize it. The whole process is in effect an exact inversion of the chemical changes taking place during the manufacture of blister steel from malleable iron by the process of cementation (see § 32), and differs from the ordinary puddling method for the purification of cast iron in this salient respect that in the latter case the formation of oxide of iron by the effect of heated air, and its direct addition in the form of "fetliog," give rise to the production of a fluxed mass, in which is incorporated a notably larger amount of oxide of iron, which reacts on the carbon, sulphur, silicon, and phosphorus, oxidizing them and converting them into products which are either gaseous and escape (carbon and sulphur dioxides), or are non-metallic and fusible, and hence, separate from the iron as a fused slag or cinder.

23. *Refining, Fining, and Puddling of Cast Iron.*—In order to convert large masses of pig iron into wrought iron, a large variety of methods have been and to some extent are still employed, differing from one another in certain details; they may, however, be classified under two chief heads, viz., those in which the iron is more or less completely fluxed by heat in contact with the solid fuel used, by means of a blast of air on much the same principle as an ordinary smith's forge, and those in which the treatment of the iron is effected in a chamber separate from that in which the fuel is burnt when solid fuel is employed, or in which gaseous fuel is used in the first instance.

*Charcoal Finery.*—Prior to the invention of puddling, the conversion of cast into wrought iron was uniformly effected by a process which, though differing markedly in certain details in different countries, yet in all cases essentially consisted of exposure to an oxidizing atmosphere and agitation until practically all the carbon and silicon, &c., is removed. As the iron becomes purer its fusibility lessens, so that ultimately it collects into pasty semi-solid masses which when united together form a "ball," which is taken out and forged into a "bloom."

Of the different kinds of finery in use some fourteen principal modifications have been enumerated by Tunner, divisible into the

three classes of "Einmalschmelzerei" (single fusion process), "Wallonschmiede" (Walloon process), and "Aufbrechschmiede" or "Deutscheschmiede" (breaking up process, or German process). Of these most have been virtually out of date for years past; a few, however, are still in use, but like the puddling process are rapidly giving way to modern soft steel or ingot iron making processes, the use of malleable weld iron being on the whole rapidly decreasing, at least relatively to that of "steel" and fused iron. A single illustration of one of these processes (termed by Tunner the English Walloon process) will suffice: as carried out in Sweden in what is somewhat inappropriately termed the *Lancashire hearth*, this differs slightly from the method as used in South Wales, the chief difference being that in the former case the pigs are melted down and the whole operation finished in the same furnace (saving that the rough blooms produced are reheated in a second furnace for further hammering), whilst in the latter the pig is melted in a separate hearth, in fact is passed through a sort of "running out" fire or refinery before it reaches the finery proper; the bed of this latter is "brasqued" or lined with charcoal powder moistened and rammed in, and so forcibly compressed. The tuyeres are directed downwards, so that the blast impinges more or less directly upon the fused metal. The effect of the blast upon the metal broken up and stirred amongst charcoal heaped over it is gradually to cause the formation of iron oxide and silica, with oxidation of the carbon and other impurities, so that finally the metal used becomes changed into two separate substances, viz., a pasty mass of spongy residual purified metal, and a bath of fluid cinder mainly composed of ferrous silicate; the former is ultimately removed as a ball and hammered into rough slabs, and finally after reheating forged into bars, &c.; in the production of "charcoal plates" (for template-making), the first rough forged slabs are cut into pieces termed "stamps," which are then reheated in a reheating furnace termed a "hollow fire" on a mass of the same kind of metal forged into a shovel shape, the blades of the shovel and the mass of stamps piled on it being then forged into a slab, which is virtually a much bigger blade, this is doubled upon itself to ensure equality of the two sides, welded, cut off from the shank, and rolled into bars and plates, &c. In Sweden the metal is usually forged by hammering throughout and not rolled at all. For inferior iron plates this process has been used with the substitution of coke for charcoal and of less pure pig for the better qualities used for the finer plates; but puddled iron has for the most part long superseded that made in a coke-fired finery for general purposes.

The following analyses illustrate the character of Swedish iron produced in the charcoal finery:—

Brand .....	Dannemora Soft Iron.		Dannemora Steely Iron.	Hoop L.	Hoop C. L.
Analyst .....	Henry.	H. S. Bell.	Schaffhütel.	Pattinson and Stead.	
Iron .....	99.863	99.471	98.78	99.660	99.268
Carbon (total) .....	0.054	0.332	0.84	0.220	0.470
Silicon .....	0.028	0.050	0.12	0.032	0.037
Sulphur .....	0.055	0.027	...	0.116	0.035
Phosphorus .....	trace	0.025	...	0.008	0.032
Copper .....	...	...	...	trace	0.008
Manganese .....	trace	0.075	0.05	0.044	0.120
	100.000	100.000	99.79	100.000	100.000

*Refinery.*—The term "refining," although in strictness applicable to all methods by which impure iron is purified,

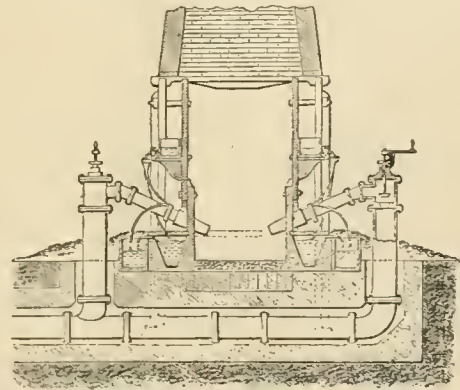

FIG. 30.—Refinery—Elevation.

is in practice restricted to one particular operation practised as a preliminary stage in the puddling process, viz., melting pig iron on a hearth such as that shown in figs. 30, 31 (taken



from Bolley's *Technology*), on which the fuel (coke or charcoal) is piled, the combustion being urged by a blast of air, which also partially oxidizes the iron, both as it melts and subsequently; the molten mass when the operation is complete is either run out into moulds, chilled by throwing water on to it (the solidified upper surface being removed as a rough cake), or tapped into a separate similar open furnace or into a puddling furnace, in which the conversion into malleable iron is finished.

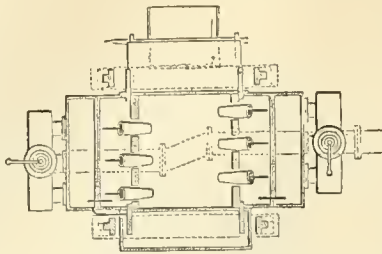

FIG. 31.—Plan of fig. 30.

The effect of this first treatment is materially to reduce the percentage of total carbon, and almost entirely to remove the silicon present, the latter forming a slag with the oxidized iron together with more or less of the ash of the fuel; when the metal from the refinery is cast, it solidifies as "white iron" destitute or nearly so of graphitoid carbon. Sometimes the removal of carbon and silicon is accelerated by adding to the fluxing pig mill scales or other tolerably pure readily fusible iron oxide; lime is also sometimes added, with the intention of either partially removing sulphur present in the pig or preventing its further absorption from the fuel.

A modification of the refinery has been introduced by Parry specially applicable to the direct treatment of the molten metal from the blast furnace; the molten pig being tapped straight into the refinery hearth, a jet of superheated steam is made to play upon its surface (the temperature being maintained by an air blast in addition); the oxidation of the iron is then rapidly effected, with evolution of hydrogen from the decomposition of the steam; in this way a notable saving in fuel is said to be effected. In South Wales a coke refinery has been largely employed to partially purify the iron subsequently finished in an ordinary puddling furnace; this refinery or *running-out fire* is a rectangular hearth with two or more tuyeres delivering blast slanting-wise downwards upon the surface of the fused metal, which is simply introduced as pig piled up on the hearth alternately with layers of coke, melted down, and kept fused with the blast playing on its surface for some time. Owing to the partial removal of silicon, &c., in this previous treatment, the subsequent puddling develops less cinder, and accordingly is sometimes distinguished as *dry puddling*; whilst puddling proper (consisting of the fusion in a more or less modified Cort's furnace of the pig, and its complete treatment therein at one operation) is spoken of as *pig-boiling*, the term "boiling" being derived from the rapid effervescent evolution of carbon oxide from the fused mass at a certain stage, when the iron oxide reacts vigorously on the dissolved carbon.

The following analyses by Rocholl illustrate the changes produced during the refining of Bowling cold blast pig:—

	Pig.	Just Melted.	10 Minutes after Fusion.	20 Minutes after Fusion.	28 Minutes after Fusion.	Refined Metal.
Iron .....	94.461	95.324	95.240	95.521	95.768	96.013
Carbon (total) .....	3.698	3.510	3.707	3.644	3.544	3.242
Silicon .....	1.255	0.575	0.478	0.273	0.174	0.139
Sulphur .....	0.033	0.034	0.038	0.032	0.025	0.025
Phosphorus .....	0.365	0.557	0.537	0.459	0.399	0.499
	100.000	100.000	100.000	100.000	100.000	100.000

**Puddling.**—In the "dry puddling" process (which, as compared with the "pigboiling" process, is so little used that the generic term "puddling" is much more frequently employed to indicate the latter operation than the former), the iron which has passed through the refinery is placed on the bed of a reverberatory furnace together with a certain amount of mill cinder or other fettling, and mowed down in a somewhat oxidizing atmosphere, the result of which is the formation of a fluxed mixture of pig iron and iron oxide; this is well stirred, whilst the flame keeps it fluid,

so that the iron oxide gradually reacts on the carbon, silicon, phosphorus, and sulphur present, oxidizing them and converting them either into gases which escape, or oxides which by uniting, with ferrous oxide form a readily fusible slag. As this process goes on, just as in the charcoal finery, the consistency of the mass alters, the whole thickening firstly to a porridge-like substance and finally to a mixture of pasty solid lumps partly of coherent spongy malleable iron and partly of fluxed slag, mechanically adherent thereto, and dripping from the spongy mass when this is lifted. When the proper consistency is reached the iron is said to "come to nature"; the spongy mass is then raked together with the iron rabble or stirring rod employed, and formed into a rough loosely coherent "ball," which is worked as described in § 25. The use of the refinery conjoined with the dry puddling process has almost ceased in England; certain brands of Yorkshire iron, however, of high reputation, are still prepared in this way. The superiority of the metal is largely due to the carefulness with which the plates and bars finally prepared are made; the puddled bars are broken into fragments, and each piece carefully examined as to its fracture, the crystalline portions being worked up separately from the fibroid portions which yield the better plates; by piling, reheating, and rolling, &c., the fragments are worked into bars, which are again piled and rolled into plates. Cold blast pig is preferred for certain of these brands.

In the "pigboiling" process, or puddling *par excellence* as now understood, the main differences as compared with the preceding are that raw pig iron is used in the first instance instead of refined pig, so that the purification takes longer owing to the greater amount of impurity to be removed, and, in consequence of this and of the larger amount of fettling used, a much larger amount of slag or "tap cinder" is formed; in other respects the operation is much the same. The furnace is usually lined in the first instance by melting down and partially oxidizing scrap iron on the bed so as to make a firm foundation; "bull-dog" or roasted tap cinder, mainly consisting of ferric oxide and silica, also forms a material largely used, the upper surface being finished off with a layer of a smooth unctuous variety of hæmatite or with "blue billy" (§ 5) or some other variety of ferric oxide.

In order to facilitate the removal of phosphorus and sulphur in the puddling forge, numerous chemical reagents have been employed incorporated with the mass by stirring. Thus common salt and manganese dioxide have been recommended by Schafhäntl, chlorides of phosphorus, arsenic, and sulphur being said to be formed and volatilized, whilst manganese is communicated to the iron, and by its oxidizing action whilst becoming oxidized itself promotes the purification; moreover it renders the slag more fusible. Henderson employs a mixture of titaniferous iron ore and fluor spar, whereby fluorides of phosphorus, silicon, &c., are said to be evolved. Good results are said to be produced by the employment of fluorides (cryolite or fluor spar) as a flux in puddling. Sherman recommends iodide of potassium; according to Siemens, who carefully tried the Sherman process at the Landore works, no appreciable diminution is produced in the amount of sulphur and phosphorus by the addition of the iodide even in some considerable quantity both during the ordinary process of puddling and in a steel converting furnace, and the same kind of negative result has also been testified to by others, notably Snelus (*Journal I. and S. Inst.*, 1871, ii. 181), and also by Euvette after full trial at Terre Noire. On the other hand, trials of the Henderson process appear to indicate that it causes a more rapid purification than ordinary puddling; thus in experiments made at Blochairn Works, Glasgow, the following percentages of phosphorus were obtained:—

Original pig iron .....	1.14 per cent.
Partly refined iron 30 minutes after fusion .....	0.23 "
" " 40 " " .....	0.15 "
" " 50 " " .....	0.12 "
Final wrought iron .....	0.07 "

The resulting cinder contained considerably less phosphorus than that in the pig employed, so that apparently some notable amount was volatilized.

Parry has proposed after puddling in the ordinary way to recarbonize the iron by melting it along with coke and a little lime, &c. (to avoid sulphuration as much as possible), in a cupola furnace, and then to puddle a second time; the phosphorus being considered by him to be reduced in each puddling operation to about one-fifth of the original amount, the double puddling would convert even a moderately phosphorized pig into a tolerably pure bar iron. Very good iron has thus been made from highly phosphorized pig on a moderately large scale (some 80 tons).

*Appliances for Puddling. The Puddling Forge.*—The puddling furnace introduced by Cort in 1784 differs from those in use at the present day only in one essential particular, viz., that whereas Cort used a bed of sand on which to run the metal fused previously in a running-out fireplace, the modern furnace as improved by Rogers some half century ago has a bed of iron plates cooled by air spaces underneath and covered with roasted scrap iron or with "bulldog," so to which the metal is heaped, having been previously refined or not according as the dry puddling or pig boiling process is used. The substitution of iron bottoms and a firm bed for the loose sand effects a great saving in iron through the formation of much less silicious cinder, and a great saving in time on account of repairs to the bed being much less frequently required; moreover, a much greater degree of purification from phosphorus is at the same time brought about.

Fig. 32 represents the general arrangement of a puddling furnace; *a* is the charging door for the fuel, *d* the bridge with an air course to cool it, *e* the bed supported on iron plates with air courses under them, *f* the exit flue leading to the chimney stack, which is surmounted with a damper *k* worked by a chain *i* from within the shed in which the forge is placed; *b* is the ashpit, *g* the slag-hole, and *e*

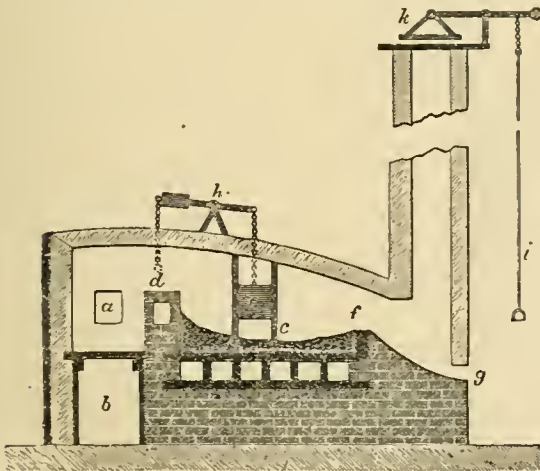

FIG. 32.—Puddling Furnace.

the working door suspended by a chain from a lever with a counterpoise attached *h*, resting on the front side of the furnace roof. A large number of patterns of puddling furnaces differing one from the other in details have been constructed by various inventors; the limits of the present article as to length forbid that these should be minutely discussed.

Instead of using solid coal or coke as fuel for the puddling forge, gas is equally applicable, *i.e.*, such as is described in § 10. In order to apply at will an oxidizing or a reducing atmosphere, it is only requisite to regulate the supply of air (usually hot blast) to the reverberatory furnace in which the gas is used. In Silesia gas puddling furnaces have been long in use, consisting of producers in which coal is burnt by means of a number of small jets of air forced in at the base of a square brick chamber some 5 feet in height, the top of the chamber being level with the bridge of an ordinary reverberatory furnace, the producer taking the place of the firegrate. In this way a mixture of nitrogen and carbon oxida with more or less hydrogen and carburated hydrogens from the distillation of the coal results, the combustion of which in the reverberatory is effected by blowing a series of jets of heated air from a row of tuyeres arranged horizontally, or from a long narrow horizontal slit-

shaped tuyere, across the issuing gases so as to form something like a gigantic blow-pipe, or series of parallel blow-pipe flames, which are somewhat inclined downwards so as to impinge on the substances in the bed of the furnace. Similar arrangements have been adopted elsewhere; thus in Carinthia gas-fired puddling furnaces are in use where wood is the fuel, the producer and furnace proper adjoining one another, and the combustion of the gas being completed in the furnace by a jet of blast from a tuyere inclining somewhat downwards; the blast is moderately beaten by being made to circulate through flues under the furnace bed, thus also cooling the brickwork; the pigs to be puddled are previously heated up to near their fusing point by the waste gases from a previous operation, being placed in a chamber just beyond the hearth. The waste gases have also been employed to heat the air blast by placing a pistol-pipe or other equivalent kind of stove between the furnace and the chimney. Several furnaces for thus utilizing the waste heat have been introduced, in England in particular; J. Head describes under the name of the "Newport furnace" a somewhat analogous arrangement, a dry steam jet being used in connexion with the air blast; a great diminution in consumption of fuel is thus said to be produced (*Journal I. and S. Inst.*, 1872, p. 220).

The Siemens regenerative furnace as applied to puddling consists essentially of a furnace fired by the gases from a Siemens gas producer heated (along with the air requisite to burn them) by means of Siemens regenerators (§ 10). The chief difference between this form of furnace, represented by fig. 33, and the Carinthian

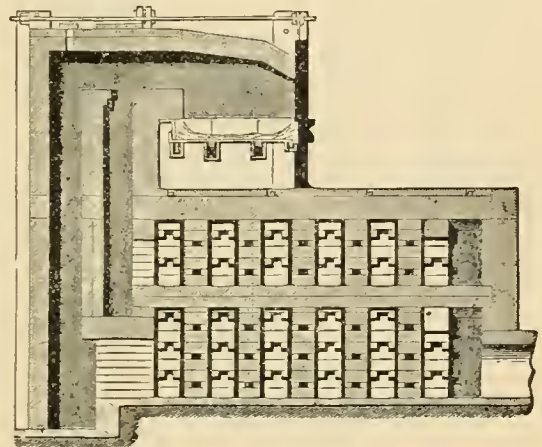

FIG. 33.—Siemens Regenerative Puddling Furnace.

gas furnaces is that the flame does not enter at one end and issue at the other, but leaves the furnace at the same end as that at which it enters, circulating in the furnace, and thereby leaving the other end free for access by means of an ordinary door. According to Siemens the loss of weight between pig and puddled bar did not exceed 2 per cent. on an average of six months' continuous working, whilst the consumption of coal (including the reheating furnace) was 30 cwt. 3 qrs. 5 lb per ton of finished wire rod (3 cwt. of ordinary fettling being used per ton of iron). Modifications of the Siemens furnace have been adopted in various iron-works differing more or less in detail, but not greatly in general principle; thus the Ponsard furnace (§ 40) and the Swindell furnace mainly differ in having the producer placed close to the furnace so that the gases are used directly without passing through the regenerators, which are only used to heat the air. The total fuel used in a Swindell puddling furnace in a large American works on a four months' average was 202½ lb of slack per ton of yield in iron (2940 lb), or 0.904 per unit of iron; the furnace, however, was not at work at night, so that a greater consumption of fuel was occasioned than would have been with double shifts of workmen. Kosmann has made a careful comparison (*Preussischer Zeitschr. f. Berg-, Hütten-, und Salinenwesen*, 1870, 145) between the effects and relative economy of puddling in the ordinary manner and in a Siemens regenerative gas puddling furnace, arriving at the conclusion that the latter is preferable in all cases where an extremely high heat is required, and where the fuel is of bad quality and unsuited for use in the ordinary way, or when a fixed temperature and particular constant quality of flame are required for any length of time. If, however, these conditions are not required, there is little advantage in the Siemens furnace over the ordinary one, whilst the latter admits of waste heat being utilized for heating boilers, &c. The waste of iron is nearly equal in the two cases, the ordinary furnace being slightly at a disadvantage; thus the cinder contained



	Ordinary Furnace.	Siemens Furnace.
Silica.....	11.98	15.36
Ferrous oxide.....	68.69	66.33
Phosphoric anhydride.....	14.43	14.28
Sulphur.....	0.24	0.28

Descriptions of the cost and working of Siemens puddling furnaces in several iron-works are given by the Puddling Committee of the Iron and Steel Institute (*Journal*, 1872, p. 123).

Besides the gases generated from coal, various other kinds of fuel for puddling furnaces are sometimes employed; thus petroleum and

vances have been introduced from time to time, mostly consisting of an ordinary rabble or some similar stirrer to which motion is communicated by machinery, in such a way as to move it (with some amount of guidance on the part of a workman) more or less in the same way as the puddler would use it. Fig. 34 represents one of this class of mechanical rabbles known as *Witham's machine* rabble applied to a double puddling furnace. *Dormoy's rabble* (figs. 35, 36) differs from others of this class in being worked by rotation like a hair-brushing machine; the tool

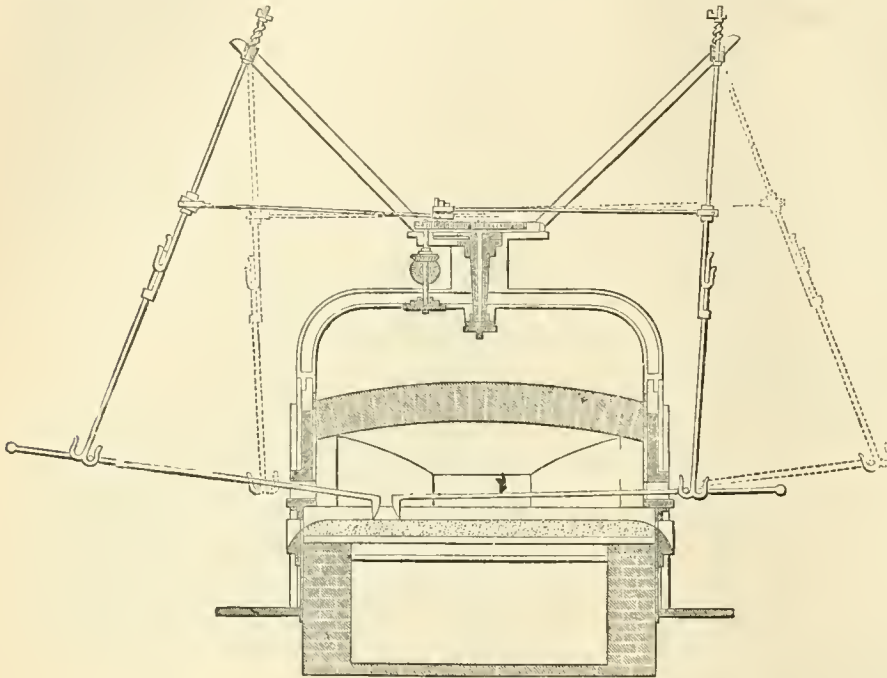

FIG. 34.—Witham's Mechanical Rabble.

coal tar have been used in American works, as also has the natural gas from the Pennsylvanian oil wells, and that produced by partially burning damp sawdust (see § 10).

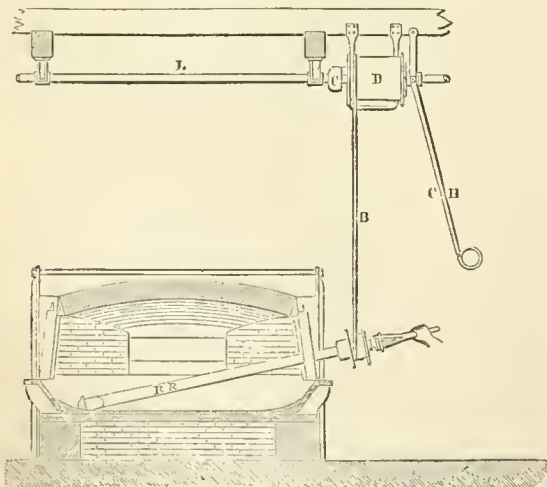

FIG. 35.—Dormoy's Rabble—Transverse Section.

24. *Machinery for Saving Labour in Puddling.*—In order to diminish the amount of laborious and exhausting work performed by the puddler, various mechanical contri-

being made to revolve very rapidly (300 to 500 turns per minute for white iron and 800 to 1000 for grey pig) gives the metal such an impulse that it gyrates horizontally round the bed, continually renewing the surface in contact with the atmosphere; this is further aided by making the end of the rabble to carry a disk, which is replaced by a short twisted point when the metal comes to nature; only for the final balling is a hand-worked rabble requisite. According to Paget (*Journal I. and S. Inst.*, 1872, 338) one fettling serves for forty charges worked in this way; an increase of 30 per cent. in the yield is effected, with an expenditure of only 0.552 parts of coal per unit of wrought

iron made (11.4 cwt. per ton); the puddler is but little fatigued, although charges are worked off much more rapidly, whilst sulphur and phosphorus are so well eliminated that inferior brands of pig produce iron equal to good charcoal iron. Numerous other mechanical rabbles and analogous appliances have been introduced by various

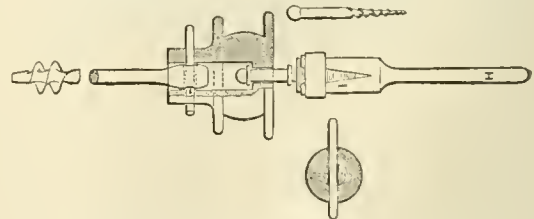

FIG. 36.—Dormoy's Rabble—Details of Puddling Tool.

inventors; reports on the working of several of these (Witham's, Griffith's, Stoker's, Wilson's, &c.), and on the construction and performance of several kinds of puddling furnace, are given by the Puddling Committee of the Iron and Steel Institute in the *Journal*, 1872; also of the Carron-Dormoy furnace and mechanical rabble *ibid.*, 1876, 109.

Many attempts were made prior to 1869, chiefly by Walker and Warren, Maudsley, Yates, Tooth, and Menelaus, to effect puddling by a revolving furnace rotated by machinery so as to cause the requisite intermixture of

pig, fettling, and slag mechanically; Bessemer proposed to employ an ovoid oscillating chamber fired by flame passing in through a hollow trunnion on one side and escaping similarly on the other side, whilst Oestlund (of Sweden) invented a rotating globular vessel into which the flame was directed from the front. Practically none of these machines ever came much into use. A considerable measure of success, however, has attended the improved form of rotary puddling furnace invented by Danks of Cincinnati, and represented in fig. 37.

The fuel is burnt in an ordinary fireplace, a blast B being admitted under the bars and another over them A, level with the firing hole, so that by regulating the two streams of air the atmosphere can be kept reducing or oxidizing at will. A circular chamber or drum C is supported on massive friction rollers and arranged so that its axis is about level with the top of the bridge; at the other end is a movable terminal shaped like the frustum of a cone D, supported by chains or rods from a crane so that it can be swung on one side if required, thus serving as a door; this is

connected by a lateral tube with the flue; a small orifice E closed by a stopper allows the interior of the furnace to be viewed when at work. The movable end being swung on one side and the blast turned off, the pigs are introduced at the end, and the terminal replaced; on turning on the blast and causing the drum to rotate slowly the pig is melted and incorporated with the fettling, &c., by the rotation; motion is communicated by means of a large external cog wheel F gearing into a pinion. Through a small cinder hole G the fluid slag is drawn off. The main difficulty experienced by previous inventors was to obtain a furnace lining that would last for any length of time, silicious bricks and analogous substances being used by them; this difficulty was overcome by Danks in the following way. The iron external drum is cased inside with fire-brick, or preferably a cement composed of crushed ore and lime; a fusible iron ore such as hammer slag or mill scale is then introduced and melted down, the drum being slowly rotated; the rotation being stopped, the melted mass collects as a pool at the lowest level; large irregular lumps of an infusible ore (American iron mountain ore in preference, or Marbella lumps when this is not attainable) are then thrown into the pool; the cooling effect of these soon sets the liquid mass, which then acts as a cement, binding the lumps to the lining. This operation is repeated several times, so that finally

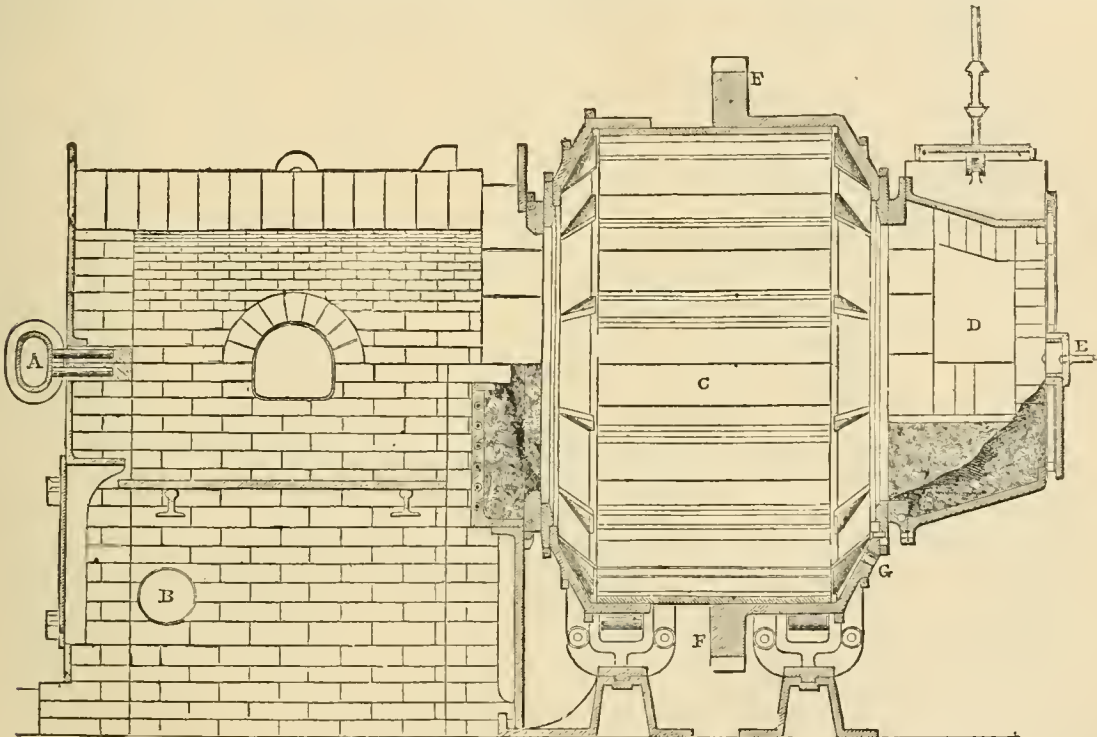

FIG. 37.—Danks Rotary Puddling Furnace.

the whole inside is lined, the pool being formed in a new place each time. The performance of the Danks puddler was very fully investigated a few years ago by a special commission of the Iron and Steel Institute, whose various reports are given in the *Journal of the I. and S. Inst.* for 1872 (see also *ibid.*, 1871, i. 258); the general results of the experiments being that the production from the rotator is several times that from a hand furnace using the same pig, and that a larger yield of iron is obtained, more being in fact taken out of the furnace than is put in as pig, the surplus arising from the reduction of the fettling; moreover, with suitable fettling the quality of iron produced is always at least equal to that yielded by the hand furnace, and is usually much superior owing to the more complete elimination of phosphorus due to the less "acid" nature of the slag; the consumption of fuel per ton of iron made is much about the same, but usually somewhat less with the rotator than with the hand furnace; thus whilst something like 21½ cwt. of pig were required to give a ton of wrought iron by the hand process, slightly less than 18½ sufficed with the Danks furnace; *i.e.*, 100 parts of wrought iron were obtained from 107½ and from 93½ parts of pig in the two processes respectively. It is to be noticed, however, that further practical experience has not altogether confirmed the results of the commission, and that so far as England is concerned the advantages derived from mechanical puddling by the

Danks machine (and also by others subsequently introduced) have not proved as great in actual practice as the success of the machine in America at first seemed to indicate would be the case in other countries.

In order to avoid the damage done to the lining by introducing solid pigs, Wood proposes to granulate the iron by means of a machine somewhat analogous to his slag granulator (§ 17), whilst fusion of the pigs in a separate furnace or cupola has also been often employed, the molten metal being then tapped into the rotary puddler.

A large number of modifications of Danks's furnace and many other more or less analogous rotating arrangements for puddling have been subsequently constructed by various inventors; thus Williams (Pittsburg, United States) makes the rotating chamber of the Danks furnace to be separated from the combustion chamber a little way, the flame being led in through a movable flue analogous to that at the chimney end, so that access to both ends of the rotator is possible.<sup>1</sup> Amongst other rotating puddling furnaces may be noticed the following.

*Seller's Furnace.*—In this arrangement the flame does not pass through the chamber to the chimney, but turns back on itself as

<sup>1</sup> See *Iron*, vol. x. p. 456, 1877, from the *Metallurgical Review*.



in the Siemens puddling furnace (fig. 33). The far end is cooled by water or steam; the fuel employed is gaseous, the generator being immediately in front of the furnace; mechanical arrangements of special character are also applied for the purpose of charging and discharging the furnaces. The rotating chamber rests on friction wheels which are made to turn by an engine instead of having an external cog wheel affixed to the drum itself as in Danks's machine. For drawings of the machine and further details see *Iron*, vol. x. p. 738.

*Spencer's rotating furnace* (fig. 38) is shaped like a rhombus reversing on a horizontal axis, supported at the end by disks perpendicular to the axis of rotation; the transverse vertical section is square, two sides being parallel to the axis, the other two, though parallel to each other, being pitched slightly diagonal, so that in revolving a throw is communicated to the charge from bridge to flue during one half of the revolution, and *vice versa* during the other half. The flat sides allow the rotator to be readily fettled; they are made of troughs filled with molten tap cinder, the ends being made up of bricks also of cast tap cinder, the whole put together and cemented with molten tap; in one side is the door for removing the ball when it has come to nature. The pig is

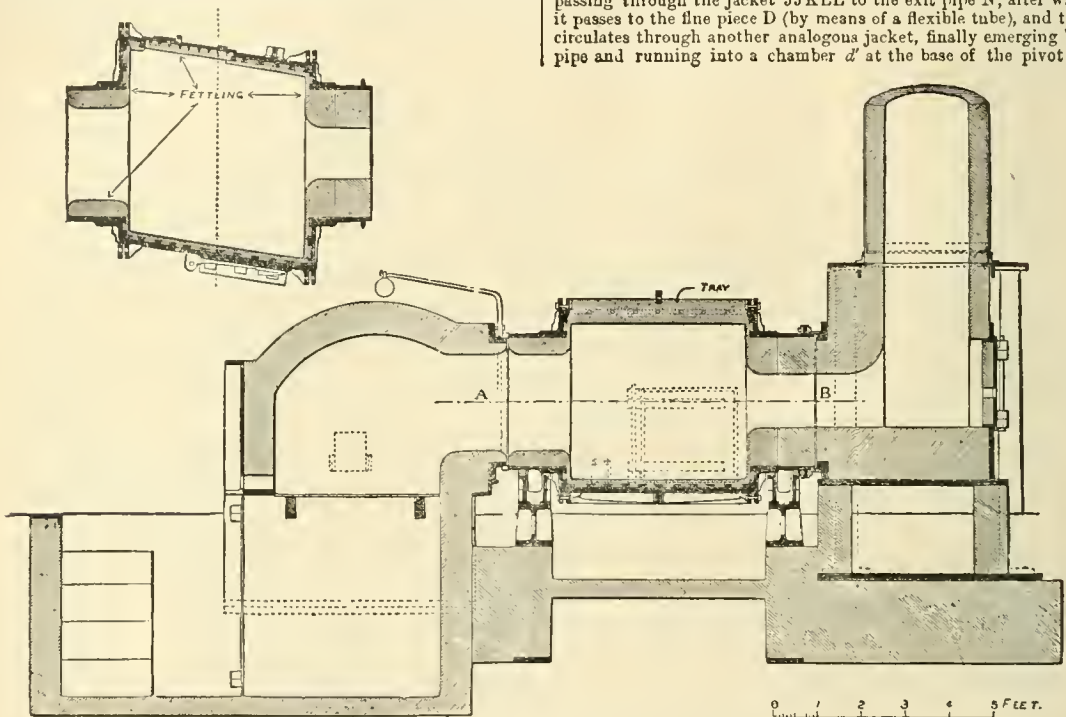

FIG. 38.—Spencer's Revolving Puddling Furnace. 1. Plan on line A B.

thence to the drum. The wearing joints O, O of the furnace and flue which rub together are iron rings, directly in contact with the water (forming the ends of the jackets); these are renewable when required. In fettling the furnace either oxide of iron bricks moulded to fit the furnace are built in and then baked *in situ*, and fettled in much the same way as Danks's furnace (viz., melting fusible ores or cinder, and throwing in irregular lumps of ore, splashing the cinder over the far end in so doing so as to cover it); or hammer slag, &c., is melted on the bare iron casing, and lumps of ore are thrown into the fused substance so as to be thereby cemented to the casing; or a thin firebrick lining may be built in and the fettling then put on. Owing to the cooling action of the water-jacket when the furnace is in use, the bricks are never melted down, and even a fluid drier applied directly to the iron plates in the first instance without bricks of any kind is completely prevented from fluxing; in the same way the far end gets spontaneously fettled by the consolidation of the cinder splashed against it. According to Crampton's description of the furnace (from which the above account is abridged—*Journal I. and S. Inst.*, 1874, 334), in puddling 130 cwts. of pig 147 cwts. of hammered iron were ultimately produced, with an expenditure of 70 cwts. of coal, i. e., the wrought iron was 118.5 per cent. of the pig used, and the coal employed was 47.3 per cent. of the wrought iron made (or 9.46 cwts. per ton); in another case, with smaller charges, the coal consumption was 70.1 per cent. of the wrought iron (14.02 cwts. per ton), which amounted to 114.5 of the pig used. Pig

melted in a cupola before running in; in about five minutes the boil commences, and it lasts about ten minutes, the operation being finished in other ten, when the ball is extracted, and quickly removed on a bogie to the hammer and rolls.

*Crampton's furnace* has a similar construction, with the additional modification that the flame is produced by coal dust and air (§ 10) instead of solid fuel (fig. 39). A is the revolving chamber supported on friction rollers C, C; B is the refractory lining, and D a movable flue piece, supported upon a pivot D' so as to wheel round when required into the position indicated by the dotted lines; it is kept in place against the furnace by the screws d, d when the operation is proceeding. By means of the injecting pipe G a jet of mixed air and small coal is blown into the furnace; this pipe is adjustable so that the flame can be directed into the furnace in different ways as required; when a number of furnaces are worked together from one central air and coal reservoir, each one is fed by a pipe G' radiating from the reservoir. By means of little doors f, f different parts of the opening F in the flue piece through which the jet enters can be closed at will. A water jacket surrounds the rotator fed through the two-way cock H with a stream of water circulating as indicated by the arrows entering by the pipe I, and passing through the jacket JJKLL to the exit pipe N, after which it passes to the flue piece D (by means of a flexible tube), and there circulates through another analogous jacket, finally emerging by a pipe and running into a chamber d' at the base of the pivot and

containing nearly one per cent. of phosphorus yielded wrought iron containing only traces.

*Howson and Thomas's Rotary Machine.*—The chamber is made up of two cones of wrought iron fixed base to base, lined with bricks made of ferric oxide and previously well-baked, ilmenite or hematite or any refractory ore being suitable. The fireplace communicates with an annular space surrounding the neck of the chamber nearest to it by a tube, so that any air which would otherwise be drawn in by the draught at the opening between the grate bridge and revolver is drawn over to the fire and not into the chamber. In order to withdraw the ball, and introduce a new charge, the revolver is mounted on a carriage (supporting the friction rollers), so that by running the carriage backwards or forwards, in a direction perpendicular to the axis, access is had to the interior through the ends, or the chamber is again put into position.

*Riley and Bentley's Furnace.*—This furnace has a bowl-shaped bed which revolves on a vertical axis by machinery, the sides and roof being fixed; when the pig is introduced and melted down, the workman inserts his rabble at the working door, and has simply to hold it in position to stir up the molten mass, this being facilitated by a projecting stud being fixed to the rabble and fitting into a cavity in the doorplate. When the metal begins to come to nature, it is worked with a differently shaped tool something like a ploughshare in shape; this, being pressed against the bottom, causes the plastic mass to roll over the plough like a small cascade; finally the

iron is balled up, the quantity worked at once being sufficient to form several balls. *Ehrenwerth's* and *Alleyne's furnaces* are very similar in construction and mode of use; in the latter the axis is hollow, containing a water pipe by means of which jets of water are made to play on the under surface of the upper bottom (the bottom being double), the water flowing away again through the hollow shaft; in a later modification, a mechanical rabble capable of rotary or reciprocating motion is also attached.

**Pernot Puddling Furnace.**—This furnace essentially differs from the preceding ones only in that, while the revolving hearth rotates on an axis not perfectly vertical (as also previously used by Maude-

ley), the axis is mounted on a carriage, so that when required for repairs the whole hearth can be withdrawn. Fig. 62 represents the furnace with this modification that, instead of an ordinary fireplace being employed, a Siemens regenerator and Siemens gas producer are used in connexion with the Pernot hearth, the arrangement being intended for steel melting by the Siemens-Martin process rather than for puddling (see § 40). According to Petin (*Journ. I. and S. Inst.*, 1874, 143) the fuel consumption with the Pernot hearth as compared with the ordinary puddling furnace is considerably less (the fuel being burnt in the same kind of fireplace in each case), whilst the loss in puddling is also less; thus per unit of wrought

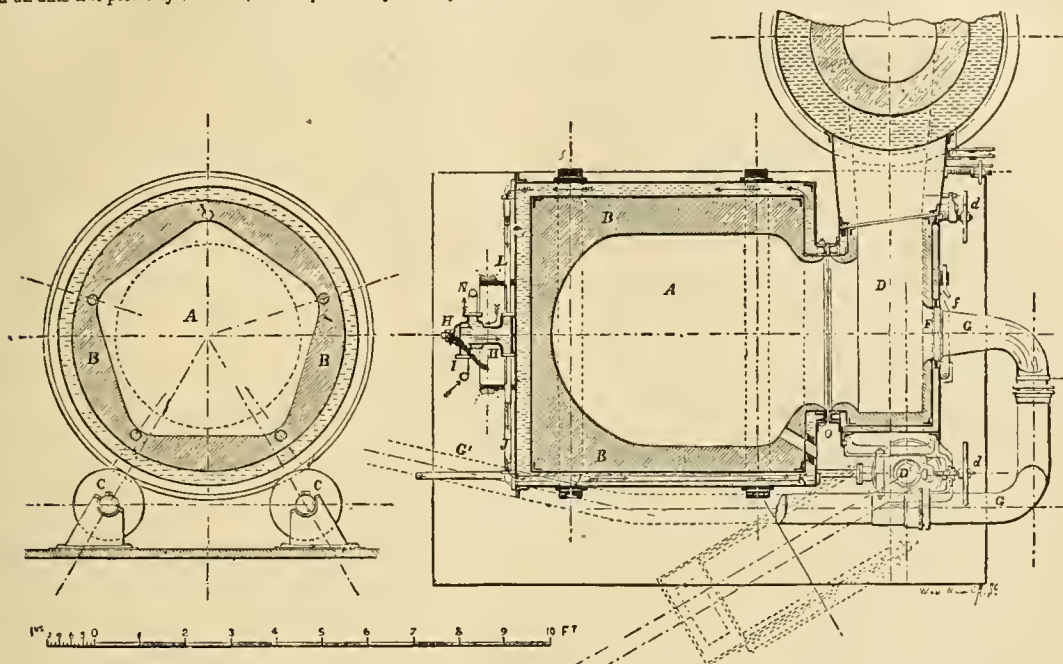

FIG. 39.—Crampton's Revolving Puddling Furnace—Cross Section and Sectional Plan.

iron the following figures were obtained during the puddling of nearly 300 tons of fine iron and 50 tons of ordinary iron (leaving out of account the saving of labour):—

	Pernot Hearth.	Ordinary Furnace.
Fine Pigs .....	{ Pig used = 1.021	1.060 to 1.070
	{ Coal „ = 1.279	1.770
Ordinary Pigs .....	{ Pig „ = 1.062	1.120 to 1.160
	{ Coal „ = 0.726	1.170

Further experience has confirmed these results to a considerable extent; thus the results of a year's working at Ougrée indicate that a yield of 1 part of puddle bars is obtained with a consumption of between 1.09 and 1.10 of the white Ougrée pig and 0.75 to 0.80 parts of coal, or 0.04 less of pig and 0.20 less of coal than is consumed with the ordinary puddling furnaces in use there.

**The Godfrey and Howson Puddling Furnace.**—Like the Pernot furnace, this has a pan-shaped hearth rotating upon an oblique axis; the obliquity of this can be adjusted to any required angle within certain limits, so as to admit of the ball being tilted out when the operation is over, the furnace bed having both a rotary and a tilting movement. The source of heat is like that of a Crampton's furnace, with this difference that instead of using coal dust a gas and air jet like a compound blowpipe of enormous magnitude is employed. Details of the construction and working are given in the *Journal I. and S. Inst.*, 1877, p. 416; when the pig iron is previously melted in a cupola, it is said that a consumption of 2500 cubic feet suffices to puddle a ton of metal, this amount representing only about 5 cwt. of coal, the coke of which is not consumed, and is consequently available for heating purposes.

It deserves notice that in 1858 Oestlund invented in Sweden a revolving furnace almost identical in principle and mode of working with the Godfrey and Howson furnace of some eighteen years later date; Jordan gives a description of this and some other Swedish early inventions in the same direction (*Revue Universelle des Mines*, tom. iii. No. 1. see also *Iron*, 1878, vol. xi. pp. 740 and 772).

The following analyses by Lewis illustrate the changes produced during the puddling by hand of Nova Scotia pig:—

Time from Period of complete Fusion of Pig .....	NIL Pig used.	8 Mins. Boil just commencing.	13 Mins. Boil in vigorous progress.	18 Mins. Iron beginning to drop.	22 Mins. Iron completely dropped.	40 Mins. and upwards. Final Puddle Bar.
Iron .....	95.39	97.72	97.90	98.20	98.67	99.68
Carbon (total) .....	2.36	1.89	1.75	1.57	1.10	0.16
Silicon .....	1.11	0.14	...	...	0.23	0.09
Phosphorus .....	0.36	0.25	0.09	trace	trace	0.07
Manganese .....	0.78	trace	0.09	trace	trace	0.07
	100.00	100.00	100.00	100.00	100.00	100.00

The following analyses indicate the character of various kinds of cinder produced during puddling, reheating, &c.

Particulars .....	Tap Cinder.		Hammer-slag Hand-puddling Furnace, Nova Scotia.	Refinery Cinder, Downais.		Charcoal Finery Cinder, Silesia.
	Cleveland Pig Puddled by Danks Machine.	Bromford Hand-puddled.	Louis.	Porous Cinder.	Crystal-line Cinder.	
Analyst .....	Snelus.	Percy.	Louis.	Riley.	Riley.	Karsten.
Ferrous oxide .....	59.14	48.43	63.92	65.52	54.94	61.2
Ferrie „ .....	20.94	17.11	15.07	...	2.71	6.7
Manganese oxide .....	1.21	1.13	3.18	1.57	5.75	0.2
Alumina .....	1.76	1.28	1.54	3.60	5.75	0.2
lime .....	0.25	0.47	traces	0.45	1.19	0.9
Magnesia .....	0.42	0.35	traces	1.28	0.50	2.4
Silica .....	14.17	29.60	14.69	25.77	33.33	28.1
Phosphoric anhydride .....	1.20	1.34	1.60	...	...	...
Phosphorus .....	...	...	...	1.37	0.90	...
Sulphur .....	0.33	...	...	0.23	...	...
Ferrous sulphide .....	...	1.61	...	...	0.27	...
	99.42	101.32	99.97	99.73	99.68	99.5

According to the care bestowed by the operator, and the nature of the fettling and other circumstances, the amount of silicon,



sulphur, and phosphorus in the puddle bars obtained from a given kind of pig will vary. Many of the machines for puddling above mentioned, and of the more or less analogous ones invented by Messier Jones, Gillow and Abbott, Bouvart, and others, are reported by their inventors to answer far better in this respect than ordinary hand-puddling furnaces, in particular as regards the removal of phosphorus; so that with Cleveland pig, for instance, containing 1.5 to 2.0 per cent. of that element, whilst the hand-puddle bars usually contain about 0.5 per cent. of phosphorus, only 0.2 and 0.1 per cent. and even less is contained in the machine-puddled metal.

This result has been traced in some instances to the use of fettling materials containing but little silica: the production of a comparatively non-silicious cinder greatly facilitates the oxidation and removal of phosphorus (as in the "basic" Bessemer process,— § 37); whilst, conversely, well-puddled iron, if left in contact with a highly silicious cinder, is capable of removing phosphorus therefrom and taking it up again. Based on this principle, several processes have been proposed for more or less completely dephosphorizing pig iron either during puddling or previously thereto; among them may be mentioned the following.

**Bell's Processes.**—Lowthian Bell has proposed to desilicize the pig by blowing for a few minutes in a Bessemer converter, and then to transfer to a puddling furnace and finish the operation therein so as to eliminate phosphorus; in case the metal contains so much phosphorus as to come to nature before a sufficient amount of that impurity is removed, spiegeleisen or other carbonized iron free from phosphorus is added to the partially blown metal, so as to prolong the operation of puddling, and consequently to enable a larger amount of phosphorus to be removed; or the too rapid expulsion of the carbon may be prevented by blowing into the converter along with the blast carbonaceous matter, such as ground coke or charcoal, &c. Partially refined metal thus prepared charged into the furnace in the fluid state causes much less injury to the lining than ordinary pigs, especially when used solid, and consequently with a good deal of sand adherent to them; and the process has the additional advantage of diminishing the time during which the furnace is required for each puddling heat, so that the yield per furnace is increased, whilst the quality of the metal is also improved; thus when Cleveland pig was treated by blowing for five minutes in a Bessemer converter, and the fluid metal then puddled, the phosphorus in the final product was reduced to 0.3 per cent., whereas when puddled in the ordinary way it amounted to 0.5 per cent. and upwards.

The same result as regards partial purification of the pig iron can also be produced in a more simple way and to a greater extent by "washing" molten pig iron with iron oxide (ore, cinder, &c.) in a fused state, the two being agitated together at a temperature sufficiently low to prevent the iron from being heated much above its fusing point; under these circumstances the greater portion of the phosphorus present is oxidized and removed, whilst only a fraction of the carbon is oxidized, although at higher temperatures the carbon is rapidly oxidized; to effect this either a rotating or an oscillating puddling furnace can be employed, or preferably a special arrangement consisting of a trough of boiler plate closed at the ends and covered with a brick arch and lined with purple ore at the bottom and sides; the trough rests on a horizontal axis, so that it can oscillate like the beam of an engine; hence any material placed inside is continually rolled or made to flow from one end to the other and back by the oscillation. The trough is about 12 feet long, 3 wide, and 3 high; the interior being red hot and the oxide introduced (either fluid or sufficiently hot to melt when in contact with fused pig iron), the pig is run in, and oscillation kept up for about ten minutes, when the partially purified metal is tapped out and puddled in the ordinary way; during the oscillation the metal and oxide travel altogether some 700 to 900 feet backwards and forwards from one end to the other. In this way a pig containing much phosphorus is almost wholly dephosphorized, as, for example, in the following instance.

	Pig before Treatment	Refined Metal.	Loss per 100 parts of original Non-metal.
	Per cent.	Per cent.	
Silicon .....	2.0	0.12	94
Carbon .....	3.5	3.1	11
Phosphorus .....	1.5	0.23	84

**Krupp's process (Narje's process)** for dephosphorizing iron is in principle very much the same as Bell's method, the phosphorus being oxidized by fused iron oxide, only at a much higher temperature than that used by Bell. Wedding describes the process as carried out at Essen thus: the pig is melted in a 13 foot cupola with coke (taking an hour and a half), and is then tapped into a modified Pernot hearth (§ 40) covered with a layer of fluxed ore almost a foot thick, melted on at a very high temperature; before every heat from 1500 to 1700 lb of ore, heated until sintered, are added before the iron is tapped from the cupola. At first the furnace is made to revolve twice only in a minute, but later the speed is increased to five revolutions per minute. In from five to ten minutes the phosphorus is almost completely removed, the point when this is the case being indicated by the formation of jets of carbon oxide; prior to the formation of these, the carbon percentage is barely altered, although the phosphorus is acted upon rapidly. Finkiner gives the following analyses of various specimens of metal thus treated:—

	Sample No. 1.		Sample No. 2.		Sample No. 3.	
	Before Treatment.	After Treatment.	Before Treatment.	After Treatment.	Before Treatment.	After Treatment.
Carbon (mean of duplicate determinations).....	3.94	3.76	3.80	3.57	3.17	3.03
Phosphorus do.	0.631	0.132	0.448	0.107	1.221	0.302

Manganiferous ores are employed in preference, the presence of manganese being said to increase the rate of removal of phosphorus whilst diminishing that of carbon. Both in Europe and America this method has been employed on the large manufacturing scale with considerable success, especially for the preparation and purification of metal for Siemens-Martin steel.

**Hamoir's process** as carried out at Mauberge (France) essentially consisted in the removal of silicon, &c., by blowing air through the molten pig before puddling it in the ordinary way; according to Deby an economy of 10 per cent. of fuel was thus occasioned, with an increase of 10 per cent. in daily output (10 heats being worked instead of 9), the quality of the metal being also improved.

**Smyth** has proposed to refine pig iron by blowing in a Bessemer converter or analogous specially constructed vessel with a blast containing petroleum disseminated through it, together with hydrochloric acid or caustic soda, these chemicals being introduced in a special piece of apparatus or "generator" somewhat analogous to an ordinary spray producer, and the partially refined metal being subsequently puddled in the usual way. A number of experiments made by Maynard at Gorton (near Manchester) indicated that the advantages of the process were hardly in proportion to the extra cost thereby entailed so far as the purifying action is concerned; but there is an advantage in the use of petroleum as a means of obtaining the high temperature in the converter or "receiver" used by Smyth requisite to keep the blown metal in fusion and prevent "skulls" forming when it is run out into a casting ladle, in cases where the iron has not the requisite amount of silicon present to enable it to generate this heat with the use of air alone (see § 27).

**Pettill's process** for dephosphorizing pig iron, strictly speaking, is in no way a modification of the ordinary methods of mechanical puddling, being more akin to the "basic" dephosphorization method (§ 37). Essentially it consists of the use of a blast carrying with it into the Bessemer converter iron oxide particles, the object being to bring iron oxide into intimate contact with the fused metal, and thus make the slag formed in the body of the iron "basic" *ab initio*, instead of its being mainly silicate, as in the ordinary process. According to the inventor it is not necessary, in order to produce steel, to employ spiegeleisen, nor to alter the mode of lining with ganister in any way; he gives the following analyses:—

	Pig Iron before Treatment.	Bar Iron Produced.
Carbon .....	2.76	0.37
Silicon .....	2.01	0.07
Sulphur .....	0.29	nil.
Phosphorus .....	1.44	0.07
Manganese .....	trace	trace

As yet the process does not seem to have attracted the attention, or to have produced the results, that were expected of it some two or three years back.

*Eaton's Process (Drown's Process).*—In connexion with the history of the dephosphorization of pig iron, and its conversion into steel, the experiments of Eaton (of Brooklyn, N. Y.) are of interest; in 1860 he patented the production of steel by the fusion together of cast iron and alkaline carbonates or by the exposure of the cast iron to the decarbonizing and purifying action of these salts in a fused state. No practical use seems to have been made of the process. Recently the subject has been investigated by Drown, who finds that cast iron plates immersed in melted sodium carbonate for several days become converted into malleable iron to a greater or lesser depth by a process substantially the same as that occurring when iron oxide is used as the "cementing" agent (§ 22), so far as the removal of carbon is concerned, but differing in that silicon and phosphorus are also largely oxidized and removed. Thus the following analyses represent the purifying effect of a seven days' treatment of a bar of pig iron:—

	Original Cast Iron Bar.	After Treatment for seven days.			Interior of Bar after Treatment.	
		Layer of outer Metal $\frac{1}{8}$ inch deep.	Next layer of $\frac{1}{4}$ inch deep.	Third layer of $\frac{1}{2}$ inch deep.		
No. 1.	Carbon . . . . .	3.56	0.11	0.33	...	3.58
	Silicon . . . . .	1.38	0.82	1.09	...	1.38
	Phosphorus . . . . .	0.87	0.45	0.67	...	0.91
	Carbon . . . . .	...	0.057	0.166	0.942	3.293
No. 2.	Silicon . . . . .	...	0.574	0.607	1.281	1.362
	Phosphorus . . . . .	...	0.015	0.201	0.776	0.911

25. *Machinery and Appliances employed in the Manufacture of Malleable Iron.*—When a ball has been prepared in the puddling furnace, it consists of a loosely coherent spongy mass of iron of doughy consistency with fluid slag filling up all the interstices and dripping from it. The first thing to be done with it is to hammer or squeeze it into a somewhat more compact mass or bloom, the fluid slag being thus to a considerable extent removed; the mass is then further hammered or rolled into rough bars, by which time it has so far cooled down that before it can be further manipulated it must be again heated up to welding heat; previously to this heating it is cut up into slips which are "piled" on one another and "fagoted" together with iron wire, and after being heated up again are hammered into a bloom and rolled or otherwise worked into bars, plates, rods, &c., as required. For very coarse bars piling and reheating is not always necessary; but for the better qualities of "merchant iron" these operations are carefully gone through, often more than once; the size of the piles, the way in which the separate portions are arranged in them, and the mode of rolling, &c., depending on the form ultimately desired; thus the arrangement is somewhat different when T iron is intended to be made from that adopted for plates, and so on; the pile being made in the former case pyramidal or somewhat  $\perp$  shaped, in the latter of rectangular section.

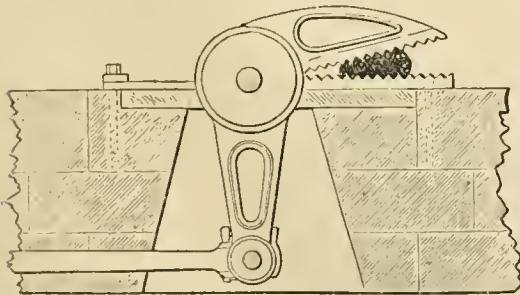

FIG. 40.—Alligator Squeezer.

Formerly the balls were squeezed by an "alligator" or "crocodile" squeezer such as that represented in fig. 40, and were then

"shingled" by shingling hammers, such as the "tilt" hammer (where the hammer forms a lever with the fulcrum in the middle, a cam pressing upon one end serving to depress that end and raise the other which carries the head) and the "helve" hammer (where

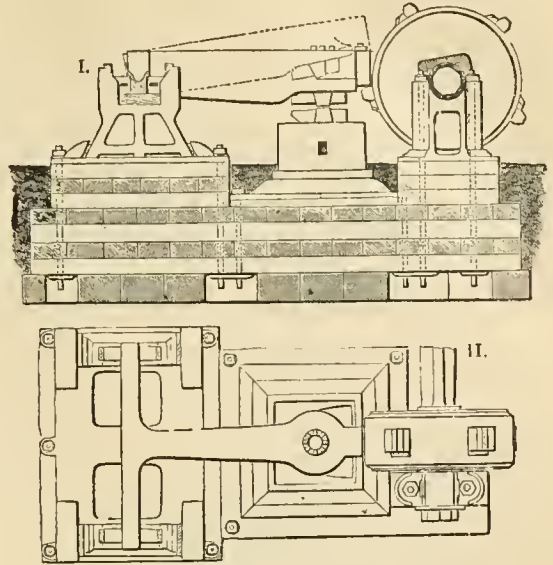

FIG. 41.—Helve Hammer. I Elevation. II. Plan.

the fulcrum is at one end, the lifting cam being at the other, and the hammer head between the two, as near the cam as possible, fig. 41); these arrangements were usually worked by water-power. With the increased use of steam power more powerful squeezers were employed. Fig. 42 represents Brown's revolving squeezer the ball being made to pass between two rotating cams which flatten it out, and subsequently between the second of these and a third which carries the operation further; in more powerful machines of the kind a larger number of cams still is employed. Fig. 43 represents another form of rotary squeezer, in which, by the friction of the revolving inner wheel C (studded with blunt projecting teeth) the ball D is urged

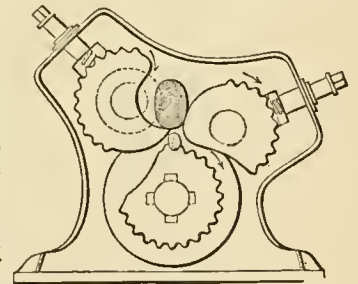

FIG. 42.—Brown's Revolving Squeezer.

onwards from A where it enters to E where it leaves, and is consequently flattened out and squeezed by the pressure between C and the outer circle B. The use of the steam hammer, however, has now largely superseded these arrangements for the produce of hand-puddling furnaces; for larger masses hydraulic squeezers are often used; thus Siemens employs an hydraulic compressor in which three or more hydraulic rams simultaneously advance horizontally to the ball being mounted on a turntable, so that when the rams retire it can be shifted round so as to present fresh surface to the rams; after lateral compression, a vertical ram or screw descends upon the ball so as to compress it in a new direction. For the large balls obtained in the Danks furnace, &c., a powerful squeezer is used, in principle analogous to Brown's (fig. 42), having two rollers at the base revolving in the same direction, and a large eccentric or cam geared to them and also revolving in the same direction, the end being hammered up by a horizontal steam hammer when the pressure forces the metal outwards.

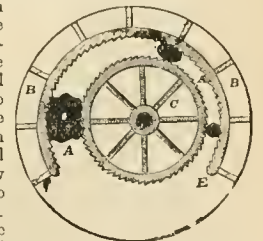

FIG. 43.—Revolving Squeezer.

Fig. 44 represents a single-acting hammer after Nesmyth's construction (Cave's modification), in which the cylinder is fixed and the



piston movable; and fig. 45 indicates a form of Condie's hammer<sup>1</sup> which has the piston fixed and the cylinder movable; in each case the movable part works vertically and carries a heavy hammer head at the lower end, underneath which is a massive anvil resting on a solid foundation. In the case of single-acting hammers, the steam pressure is only employed to lift the hammer head, the fall being simply that due to gravity; much greater force of impact is gained in double-acting hammers, where the steam is admitted on each side of the piston alternately, in the one case lifting the head as with the single-acting hammer, in the other adding to the force of gravitation by its pressure. By suitably working the valves the blow may be modified or arrested at any desired stage; a cushion of steam being left underneath the piston by closing the exhaust valve before the stroke is complete, the force of the blow is deadened; so that a

mass; in this way the steam hammer acts as both squeezer and helve hammer combined. Hammer blocks or "tups" of from 1 to 3 tons weight usually suffice for ordinary puddling furnace work, and lighter ones still for various kinds of smelting and forging work; but when large masses have to be forged for special purposes, e.g., thick armour plates, large crankshafts, coils for large guns, &c., much heavier tups are used, weighing many tons; thus in Krupp's works a 50-ton hammer is in use with a 10-foot stroke, the anvil weighing upwards of 180 tons, whilst at Creusot an 80-ton hammer with a fall of 5 metres (about 16 feet) is employed. The striking faces of both anvil and tup are usually removable, sliding sideways by dovetails into the body of the tup and the anvil block respectively. For certain classes of work curved faces are employed instead of plain ones; so that a roughly cylindrical bar can be forged by appropriate manipulation.

A duplex horizontal modification of the vertical steam hammer is sometimes used (Ramsbottom's hammer), consisting of two opposed hammer blocks running on wheels or rollers and meeting one another; the forging being placed between the two is struck by both simultaneously. In one form of this double horizontal hammer the two tups are actuated by the same piston, each being

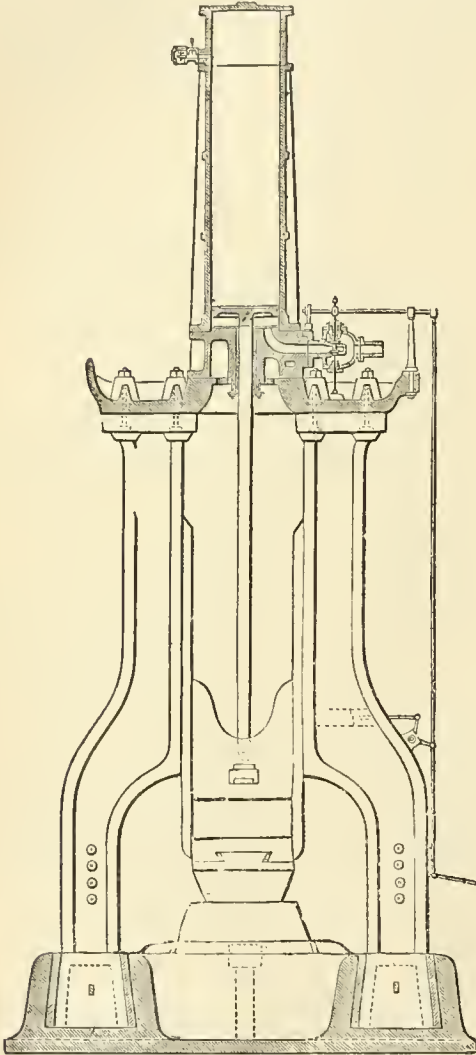

FIG. 44.—Cave's modification of Nasmyth's Hammer.

variable amount of impact can be imparted, it being possible for an expert hammerman to crack a nut without injuring the kernel, and at the next stroke to exert the full power of the machine. It is this adaptability that renders the steam hammer preferable to the old helve and tilt hammers, the blows from which could not be readily modified during the shingling of a given ball; whilst the ball is excessively pasty and spongy immediately after taking from the puddling furnace, comparatively light blows suffice to shape it into a bloom, the mass being dexterously turned about on the anvil by means of suitable tongs during the forging; the force of the blow is then greatly increased so as to squirt out the fused slag on all sides in a shower at each stroke, and forge the bloom into a compact

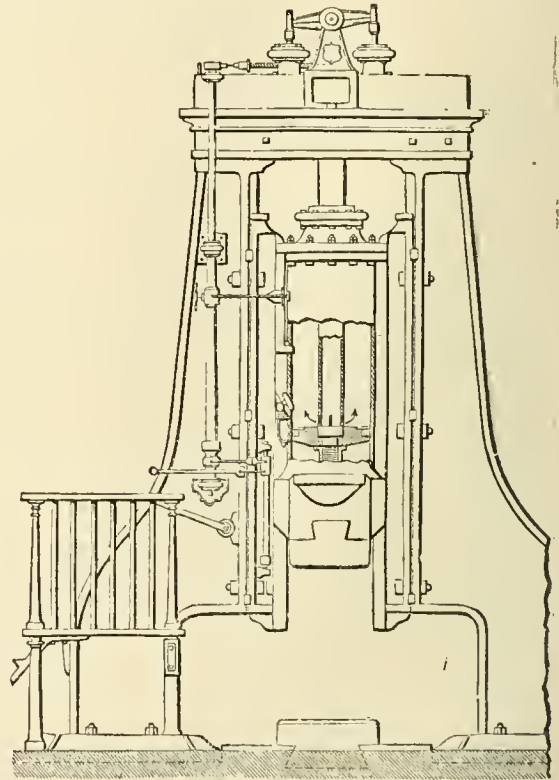

FIG. 45.—Condie's Hammer.

attached thereto by a link rod so that both necessarily approach and recede at equal ratio; in another form two pistons are employed, the steam valves of each being worked simultaneously by the controlling lever. For forging small articles such as bolts, screws, &c., special machines are in use, striking a large number of blows per minute, the hammer heads and anvil blocks being moulded or curved into the appropriate forms so as virtually to form dies; the blows are usually struck by means of cams hitting the hammers and bending strong springs which force the hammer back when the cams release them. See also HAMMER, vol. xi. p. 425.

For bending into shape large masses of metal such as thick armour plates that have to be curved to the ship's side, powerful hydraulic presses are employed; by means of the same appliances large weldings of metal that cannot readily be hammered on account of the shape can be readily made; thus, for welding the spokes and tyres of iron and steel wheels and the like operations, hydraulic forging, squeezing, welding, and bending machines are found to be eminently satisfactory. Crank axles thus bent are said to be stronger than ordinary forged ones.

*Rolling Mills.*—After the bloom has been forged more or less into shape by the steam hammers, it is passed between.

<sup>1</sup> Taken from Bolley's *Handbuch*, vol. vii., part 2, by Dr C. S. bzjel.

a pair of stout cast iron rollers, usually with roughened surfaces, which are made to revolve synchronously but in opposite directions by suitable gearing; the opposed faces of the rolls which meet the bloom between them are consequently moving in the same direction; by these "roughing rolls" the bloom is squeezed out into a rough irregular long plate or slab, much as a lump of dough is by a cook's rolling pin; this is passed through another pair of rolls with smoother surfaces, which draw the mass out into a thinner bar or slab. Instead of having the two sets of rolls arranged one in front of the other, they are often placed one above the other; the bar after passing in one direction between one pair is returned again through the other pair. Instead of four rollers, only three are generally used (forming a "three-high train"), the bar passing above the middle one whilst travelling in one direction and below it when passing the reverse way. The "puddle bar" or "muck bar" thus obtained in the form of elongated slabs of from 4 to 18 inches wide, and half an inch to 2 inches thick, according to the size to which it has been reduced, is then cut up into lengths of some few feet, several of which are piled one on the other, reheated, and rolled down again into another bar or slab of superior quality (No. 2).

For thick plates the pile is made much heavier than for thinner bars; two puddle bar wide slabs are used for the top and bottom of the pile, between which are arranged thinner bars, either of puddle bar or No. 2; the pile being heated to a welding heat is first passed between roughed rolls to consolidate it, then through other pairs of smooth rolls in succession, the space between each pair

high" train, and fig. 47 those for rails in a "three-high" train on A. Thomas's system. The bars are turned one quarter round at each passage, so that the pressure may be exerted alternately compressing and extending each component layer of bars in the pile, and thus developing a more uniform texture. Sometimes, in reducing the pile to the larger-sized bar which is ultimately sent through the "finish-

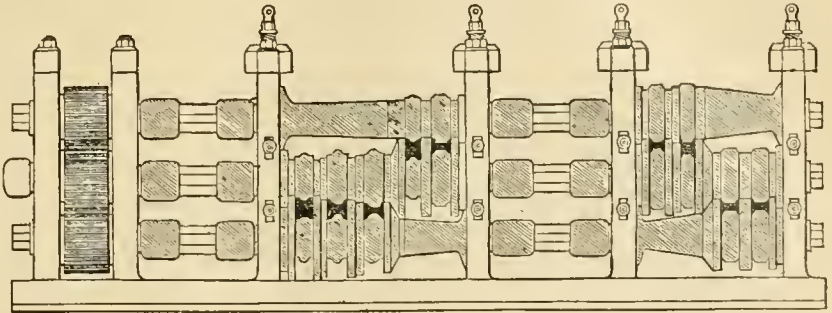

FIG. 47.—Three-high Train.

ing train" of grooved rolls, a combination set of rolls is employed, consisting of one horizontal pair of rolls and one vertical pair just behind it, so that the mass is compressed both laterally and vertically simultaneously (fig. 48). The "housings," or stout cast-iron supports for the rollers, are arranged with a slot so that the gun-metal bearings for the axles of the rollers can be raised or lowered by means of a powerful adjusting screw, and in this way the distance between the rolls is regulated, and consequently the thickness of the bar rolled out. In order to facilitate this adjustment the bearings of the upper roller are sometimes attached to a frame with a counterpoise, and connected with a hydraulic ram so as at will to bring the movable roll nearer to or further from the other; in this way one pair of rollers can be made to do the work of several

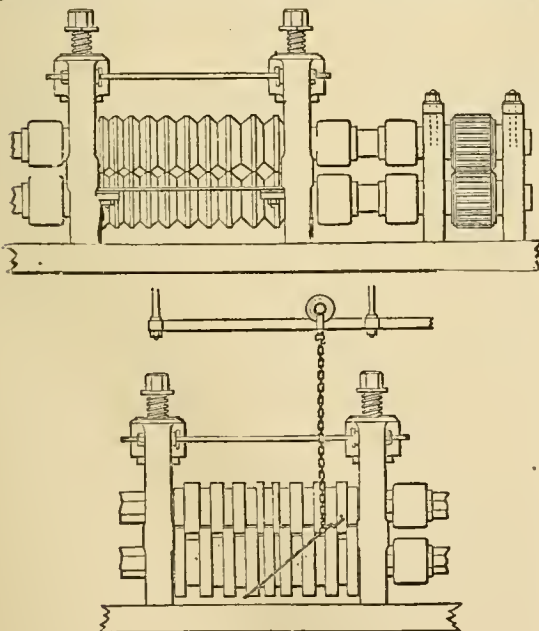

FIG. 46.—Two-high Trains.

being successively less and less so as to elongate the bar and diminish its section at each passage, much as wire is in wire drawing: this is usually effected by grooving the rollers used for the last few rolling stages so that the rolls are almost in contact with one another saving where grooved. Fig. 46 illustrates two kinds of successions of grooves used for rectangular bars in a "two-

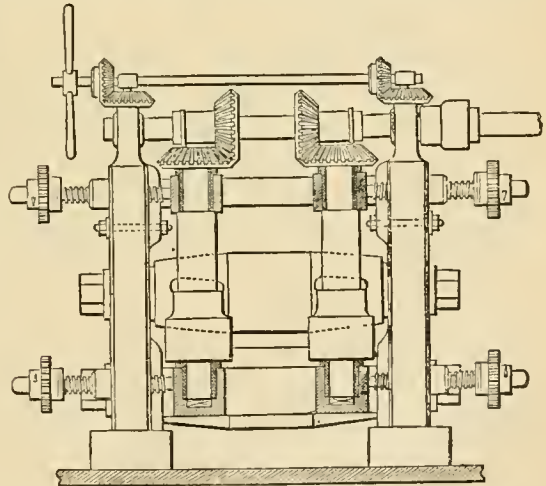

FIG. 48.—Universal Rolls.

rectangular groove. Sometimes two pairs of horizontal rolls are arranged one just in front of the other, so that the size of the bar passing through the hinder pair is still further reduced by passing through the front pair, which are a little closer together and revolve more rapidly. When very thick plates are rolled, the direction of rotation of the rolls is reversed instead of returning the plate back again, special "reversing engines" being used for the purpose. For special kinds of work, such as rolling taper iron (e.g., the movable tongues of railway "points"), a peculiar lifting arrangement is applied to the upper roll, so that as the metal passes between the distance apart is varied. When an hydraulic ram is employed to vary the distance apart of the rollers, this is simply effected by adjusting the ram so that the distance apart of the rolls is the minimum requisite, and opening a small discharge valve for the water when the bar is introduced; as the bar passes through, the water is ejected in a regular stream through the discharge valve, the rate being so adjusted that as the bar travels through the distance apart of the rolls gradually increases; by closing the valve the distance apart remains constant, so that after rolling a taper end the rest of the bar can be rolled of uniform section. With a "two-high"



train not reversed at each successive passage, the bar is lifted by hand or otherwise to the top of the top roller, which then guides it back to the side from which it started, after which it is put through the next groove, and so on; this causes loss of time, and prevents the bar being rolled so many times before it cools; accordingly for thin plates or rods of small section the three-high train is always used (or some more complex analogous combination of rollers). As a rule the speed of rotation of the rolls is less the heavier the plate, &c., rolled; for very thick armour plates (of which sizes up to 20 and 30 tons are sometimes rolled) a comparatively small number of revolutions per minute suffices; for thin rod a much larger number up to several hundreds; from 80 to 100 revolutions is about the usual speed for rolling rails and similar heavy bars, 50 or 60 being employed for very thick ones, 120 to 150 for lighter bars, and considerably more rapid speeds for very thin bars, rods, and wire. Space will not permit of descriptions of the details of various kinds of rolling-mill plant, &c., introduced in different works, and more especially of numerous American improvements in this direction, particularly those of Messrs Fritz; for descriptions of these, the technological journals, &c., of the last few years must be consulted.

For rolling tires a peculiar arrangement of comparatively small rolls is employed; the ingot after having a hole punched through it (or cast in a thick ring of molten "ingot metal") is subjected to a kind of rolling action between two surfaces, one inside the ring and the other outside, so that the circumference of the ring is gradually extended and its thickness diminished, whilst the flange is simultaneously formed.

When thin rods of rectangular section are required (*c.g.*, nail rod), they are often made by rolling out a bar into a long wide thin plate, which is then passed through a "slitting mill" consisting of a pair of steel rollers with deep grooves, the projecting portions of the one fitting into the grooves of the other, but not reaching to the bottom of the grooves. These projecting portions act as revolving shears, so that the plate is "slit" as it passes into thin rods, the width of which is regulated by the width of the grooves; after passing through the machine these are straightened by hand.

In order to cut puddle bars into lengths for piling, powerful shears are employed. Fig. 49 represents one form of double shears

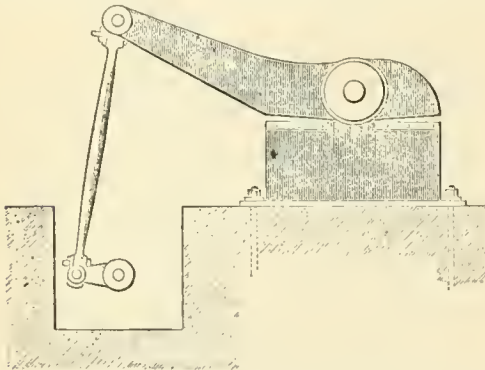

Fig. 49.

worked by a reciprocating lever actuated by an eccentric; fig. 50 represents a much more powerful form of guillotine shears. A massive plate B with a terminal shearing edge AA works slowly up

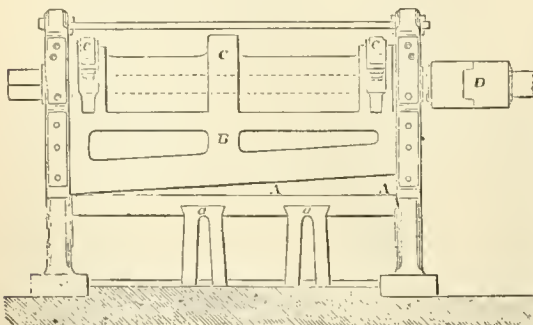

Fig. 50.

and down in guides by means of eccentrics C, C, on the shaft D; this cutting edge passes just in front of a similar one permanently fixed to the guide posts. The plate to be sheared is supported on a table in front of the shears, running backward and forward upon

a little railway; whilst the upper cutting edge is elevated, the plate is quickly run into position, and as the cutting edge descends is sheared across, the cut-off portion dropping down; as the cutter ascends again the plate is turned round or pushed forward, so as to bring under the cutter the portion to be sheared at the next down-stroke. The same kind of machine serves for cutting boiler plate to any required dimensions, and for shearing purposes generally. Substituting a solid steel plunger for the cutting edge, the machine becomes a punching machine, the plate to be punched being supported on a travelling table, and the spot where the rivet-hole, &c., are to be pierced being brought under the end of the punch whilst the latter is raised. A powerful fly-wheel is requisite whenever the plate to be sheared or punched is massive. For cutting "crop ends" off hot or cold railway bars after rolling so as to reduce them to a

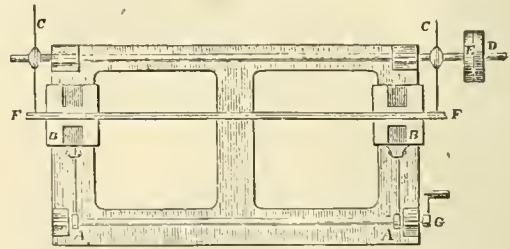

Fig. 51.

uniform length, an arrangement analogous to a travelling table is used, urged forward by an eccentric, a toothed wheel and screw, or a chain and axle; &c. fig. 51; on this the bar FF is placed against stops B, B, and the table then moved forward (as represented in the figure) by means of the handle G actuating an eccentric on the axis AA so as to bring the bar gradually against the pair of rapidly revolving circular (usually toothless) saws C, C worked by a band and pulley E, and thrown out of gear by shifting the band to the "idle pulley" D when required; to prevent the saws from becoming overheated, the lower portions dip into water troughs as they revolve. A single circular saw revolving 5000 times a minute (with a circumferential velocity of about 300 miles per hour) has been used for this purpose. For obliterating file marks, reducing to roughly plane surfaces, cutting slots, smoothing, and many other purposes for which grind-stones, &c., were formerly employed, emery wheels made of pulverized emery cemented together with calcium silicate are often used with great advantage.

**Cold Rolling.**—In the ordinary processes of rolling iron plates and rods, &c., the metal is at a high temperature so as to be softened by the heat; when cold iron is similarly rolled the compression thereby produced gives a much greater stiffness and elasticity: thus Fairbairn found that an increase in strength in bars from 60,746 lb per square inch before rolling to 88,230 after was thus effected. Whipple (of the U. S. navy) finds that in sheet iron the tenacity is thus increased by 60 and even 100 per cent. of the original value, and Thurston has recently found analogous results both as to increase in tenacity and power to resist strains and in the modulus of elasticity. The process is largely in use in America, being carried out by rolling the bars, &c., out to a little larger dimensions than the finished metal is intended to have; they are then "pickled" in dilute hydrochloric acid to dissolve off the film of oxide from the surface, passed through limewater to neutralize the adherent acid, and finally rolled many times in succession between grooves of great smoothness, so cut as only to compress portions and not the whole of the circumference at each passage through the rolls. For a description of the appliances used in cold rolling as carried out at the works of Jones & Laughling, U. S., who make a speciality of this business, see *Engineering*, vol. xxvi. p. 347 (1878).

For straightening and planishing circular steel bars such as shafting rods, &c., a peculiar machine is sometimes used, consisting of a pair of revolving disks with bevelled faces, which compress the rod slightly between them, at the same time rotating it and traversing it forwards (and, by reversal, backwards) by one continuous movement, so that all parts of the surface are equally operated on, and the bar leaves the machine circular, straight and bright-surfaced.

Numerous other machines<sup>1</sup> are in use for various special purposes, such as wire-drawing, drilling, screw-tapping, &c.; the description of these would take up more space than can be given here.

A marked feature in most American iron-works is the general handy, compact, and efficient nature of the machinery of all kinds, and the use of various physical-exertion-saving contrivances and arrangements for ventilation and cooling of workshops, &c., many of which appliances are not so frequently to be met with on the eastern side of the Atlantic, more especially in England. The general arrangement and planning out of works, moreover, is usually far superior to that of the older British works, which have gradually grown to their present dimensions, and consequently have not been systematically laid out as a whole. In consequence of attention to such details as these, the output of finished material from a given amount of plant is frequently considerably greater in America than would be attained in other countries, whilst the labour required is not proportionately increased; thus the largest makes of Bessemer metal from a given converter ever registered have been obtained in American works; and so in other instances. To a considerable extent the same remarks apply to Continental establishments, at any rate to many of those of more modern arrangement; of late years, however, the spirit of competition and other influences have rendered it imperative upon the British ironmaster to pay more regard to such matters than was formerly the case, and to adopt many American and Continental improvements in details,—experience

having opened his eyes to the fact that it is possible for other nations, though less naturally favoured as to ores and fuel, to compete successfully with him, and undersell him, not only as to foreign trade, but even in the case of English contracts for iron work for home use.

The *reheating furnaces* employed to heat up to a welding temperature the piles intended to be rolled are essentially low reverberatories, much resembling puddling furnaces, in which the atmosphere is kept as little oxidizing as possible; notwithstanding, a certain amount of slag is formed from the fusion of the oxide of iron coating the bars and its union with silica from the furnace bed when of sand, as is often the case; ferric oxide ores ("dry bottoms") are preferable, yielding less cinder and causing less waste in consequence, whence the name. To avoid introduction of air, the doors for introducing and withdrawing the piles are banked up with small coal, &c. Gas forms a most suitable fuel, and various forms of gas-fired reheating furnaces have been introduced: thus in Sweden Eckman's gas reheating furnace has been in use many years, consisting of a chamber in which charcoal is partially burnt by an air blast so as to form impure carbon oxide, which passes by a tube into the reheating furnace and is there burnt. Siemens regenerators applied to reheating furnaces have also been frequently employed, and with good results, either with his gas producers or with other forms of gas generator; at Munkfors the Lundin gas producer (using damp sawdust, § 10) is employed. Another form of reheating gas furnace is the Ponsard furnace (see § 40). The chief advantage of gaseous fuel for reheating furnaces is that the atmosphere can be much more exactly regulated so as

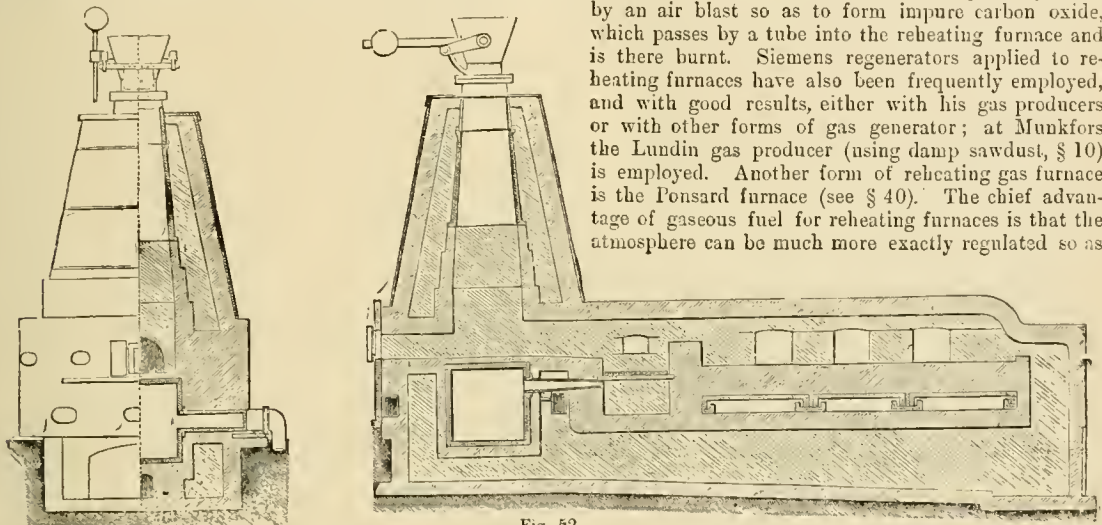

Fig. 52.

to be non-oxidizing, thus avoiding waste by "cutting" (*i.e.*, oxidizing) the piles; independently of which, moreover, a saving in cost of fuel consumed is effected; thus Holley states that, in reheating Bessemer ingots or ordinary blooms in Siemens furnaces, 350 to 400 lb of coal are used to the ton, whilst the ordinary fires would consume 800 to 1000 lb. On the other hand, if the waste heat from the reheating furnace is used to generate steam, the saving in fuel that would otherwise have to be burnt for the purpose just about equals the difference in fuel consumption between the Siemens and the ordinary reheating furnaces.

*Price's retort reheating and puddling furnace* (fig. 52) is a sort of combination of a gas producer and an ordinary puddling furnace; the firegrate is supplied with fuel which has been heated in a low tower surmounting the grate by the waste gases circulating in a flue round the tower; in this way the coal is coked, the gases passing to the fireplace; a blast is introduced under the fire bars so as to burn the coke and produce a large body of flame of reducing character owing to the admixture of hydrocarbons from the coking process in the tower; the blast is heated by passing through a chamber surrounded by the waste-gas flue; by regulating it the atmosphere can be made more or less reducing at pleasure. The saving of fuel effected is said to amount to about one-third of that which would be required in an ordinary puddling furnace, whilst when arranged as a reheating furnace a still greater saving is produced.

*Utilization of Waste Heat.*—In all iron works the amount of heat escaping from the puddling and reheating furnaces (except when regenerative) is enormously in excess of the amount actually utilized; to economize this waste heat to some extent, it is usual to employ the exit gases for raising steam, or for heating the air blast, or both. The actual amount of fuel employed in the operations of puddling and reheating (apart from that corresponding to the motive power) varies within wide limits according to the quality of the pig iron used in the first instance and the mode of operating adopted. When the coke refinery is employed a consumption of coke to the extent of 15 to 30 per cent. of the weight of the pig iron used usually suffices to produce a refined metal, which is then convertible into puddle bar with an expenditure of coal about equal to or somewhat exceeding that of the puddle bar made; where particular manipulation requiring the working of only small batches at a time is practised, *e.g.*, in some of the West Yorkshire iron-works, the consumption of fuel is often much larger, amounting in some cases to nearly double the weight of pig iron treated originally. In the ordinary pig boiling process, according to the purity of the metal, something between 100 and 150 parts of coal per 100 of puddle bar, and sometimes even more, are usually requisite, but considerably smaller amounts are said to be used with some of the more recently invented kinds of furnaces. Analogous

<sup>1</sup> During several years past a series of papers on "American Iron and Steel Works," by A. L. Holley and Lenox Smith, have appeared in *Engineering*, from which much detailed information may be gained as to modern American improvements in various directions.



results are obtained when lignite, wood, peat, or other fuel is employed, due allowance being made for its different calorific power. For reheating furnaces in which coal is burnt, the consumption of fuel is usually in excess of 50 per cent. of the metal ultimately rolled for each time it is reheated. The yield of puddle bars from a given quantity of pig varies somewhat with the quality: in spite of some of the iron oxide of the fettling being reduced, the weight of malleable iron (cinder being deducted) finally obtained in hand furnaces is always somewhat less than that contained in the pig iron used; the latter averaging say 94 or 95 per cent. of iron, the yield of puddle bar may be said to run from 88 to 92, averaging about 90 per cent. Before an ordinary class of iron ore is converted into good bar iron there is in practice requisite a consumption of coal (or of its equivalent in coke, taking say 3 parts of coke to represent 5 of coal) to about the following extent per 100 parts of malleable iron finally obtained, that is, when each operation is conducted about as economically as is practicable on the large scale:—

Smelting to pig iron (140 parts of pig) .....	250
Puddling to puddle bar (140 pig becoming 125 puddle bar) ...	140
Reheating for final rolling, &c. (125 puddle bar used).....	60
<b>Total.....</b>	<b>450</b>

In reference to this last item the consumption of puddle bar varies much with circumstances; a considerable fraction of the final iron is obtained in the form of mill scale, which is not lost, being utilized in the puddling forge, or for smelting, &c.; the rest is obtained in the form of cuttings, "crop ends," and "scrap" of various kinds, often not very largely inferior in value to the bar iron.

26. *Puddled Steel and Natural Steel.*—If in the operation of converting pig iron into malleable iron by puddling in a reverberatory furnace the process be stopped before the decarbonization is complete (the temperature of the furnace being a little lower, so that the partial solidification of the mass on decarbonization—"coming to nature"—takes place more easily), the resulting metal is a more or less carbonized iron, which, when prepared from pig free from any large quantity of sulphur and phosphorus, is susceptible of many of the applications to which steel is put. Considerable skill in manipulation is necessary in order to obtain anything at all approaching to a uniform product, the tendency being towards the production of a mass with lumps of soft wholly decarbonized iron, and sometimes of but little decarbonized pig irregularly distributed through it. This is best overcome by conducting the decarbonization more slowly and at a somewhat lower temperature than is usually done in ordinary puddling, and using less fettling and a less oxidizing atmosphere. A manganiferous pig is almost essential to the obtaining of a good product, first because the oxidation of the manganese gives a more fluid slag, and secondly because the small quantity retained by the product decreases the injurious effects of sulphur, phosphorus, &c., on the physical properties of the metal.

The manufacture of puddled steel in England is now but small, the Bessemer and Siemens-Martin processes having largely superseded it. Occasionally, however, substances apparently consisting of badly puddled iron, and possessing some degree of hardening power, are sold under the name of steel; but, not having been fused so as to give uniformity of composition, these products are incapable of being used advantageously for purposes for which the elasticity and capability of resisting wear and tear possessed by good steels are essential. The want of a definite understanding as to whether the term "steel" is nowadays to be understood as implying that the product has been completely fused (as maintained by some, see §3) or not leads occasionally to disputes and lawsuits, when inferior kinds of "puddled steel," or badly decarbonized puddled iron, are supplied under the terms of a contract which simply mentions "steel" as the character of the metal to be supplied, without precisely stating its nature, quality, or properties, or the mode of its production.

On the Continent, puddled steels made from pig of pure qualities so far as sulphur and phosphorus are concerned are more extensively employed. Schilling has examined the relative rates at which carbon, silicon, phosphorus, and sulphur are eliminated from the pig irons of Gittelde and Zorge in a charcoal steel-puddling forge at Zorge (Hanover), obtaining the results given in the following table:—

	Average Composition of Pig Iron used.	At 47 mins. Charge Melted.	66 mins. Commencement of Boil.	80 mins. Duing Boil.	111 mins. Beginning to come to Nature.	120 mins. Final Steel.
So-called combined carbon } .....	1.81	2.49	2.360	2.260	1.330	Average 1.01
Graphite .....	1.11	...	...	...	...	...
Phosphorus .....	0.47	0.24	0.170	0.110	0.071	0.076
Sulphur .....	0.10	0.03	0.027	0.012	trace	trace
Silicon .....	1.24	0.34	0.160	0.110	0.110	0.11
Manganese .....	1.66	0.47	0.470	0.470	0.310	0.27
Iron (by difference) .....	93.61	94.43	96.613	97.038	98.179	98.535
<b>Total.....</b>	<b>100.00</b>	<b>100.00</b>	<b>100.000</b>	<b>100.000</b>	<b>100.000</b>	<b>100.000</b>
Character of product .....	Tough cast iron.	White iron	Slightly malleable white pig, cellular.	Malleable very hard steel.	Steel.	Steel.

Similar results have been obtained by other observers; thus Parry gives the following analyses of British puddled steel (Ebbw Vale) and of the original pig employed:—

	Pig Iron used.	Puddled Steel.
Carbon (total) .....	2.680	0.501
Silicon .....	2.212	0.106
Sulphur .....	0.426	0.002
Phosphorus .....	0.125	0.096
Manganese .....	1.230	0.144
Iron (by difference) .....	93.327	99.151
	<b>100.000</b>	<b>100.000</b>

*Natural steel* is to refined pig iron (§ 23) in the inverse relation that puddled iron is to puddled steel: the last is derived from pig iron by stopping the decarbonization at a stage before it is complete; the first is obtained by carrying the refining process somewhat further than the stage usually attained in the refinery. The forge or hearth used for natural steel making is substantially like that employed for refining, a brasqued bottom of charcoal dust being put on, and the pig iron melted down and gradually decarbonized by the conjoined action of an inclined blast blowing downwards upon it and of the cinder floating above it; if the decarbonization is carried too far a little fresh pig is added to recarbonize the whole. The details of the manipulation (upon the mode of performance of which the character of the resulting product depends) vary in different localities; thus Tünner describes five distinct modifications practised in Siegen, Tyrol, Carinthia, and Styria; save in these districts the manufacture of this class of steel is but small. The bars ultimately formed from the blooms are usually hammered out by hand entirely, and not machine rolled at all. For further details see Percy's *Metallurgy*.

27. *Bessemer's (Original) Process.*—The method usually known in this country as "Bessemer's process" of steel making does not, strictly speaking, belong to the class of methods now under discussion, being a combination-process consisting of two parts:—one the Bessemer process proper, of which the essential feature is the conversion of cast iron into wrought iron by the method (due to Bessemer) of forcing air through the molten mass so as to burn out the carbon; the other (due to Mushet) consisting of the conversion of the molten wrought iron thus obtained into steel by mixing with it a suitable proportion of fused carbonized iron containing manganese, in the form of spiegeleisen or ferro-manganese; this combination process is discussed more fully in § 36.

The decarbonizing and desilicizing of iron by the action of an oxidizing atmosphere is the essential feature of the processes of refining pig iron (§ 23) and of making natural steel (§ 26); but prior to 1855 these processes had only been applied to the partial purification and decarbonization of pig iron, the air being blown over the surface of the fused metal; and, in consequence of the comparatively slow rate of oxidation of carbon and silicon thus brought about, the use of fuel to melt the iron and to keep it in fusion was essential.

On September 15, 1855, an English patent was granted to Gilbert Martien of Newark, New Jersey, U.S., for the purpose of partially purifying cast iron by passing streams of air or steam "through and amongst the melted metal as it flows from a blast furnace" or the melting furnace, the object being apparently, not to convert pig iron into wrought iron and to supersede the puddling furnace, but simply to act as an adjunct to the refinery. Shortly after, Parry made experiments at Ebbw Vale on a process substantially the same as this. On October 17, 1855, Bessemer took out his first patent for "forcing currents of air or of steam, or of air and steam, into and among the particles of molten crude iron or of remelted pig or refined iron, until the metal so treated is thereby rendered malleable and has acquired other properties common to cast steel, and still retaining the fluid state of such metal, and pouring or running the same into suitable moulds,"—i.e., for converting cast iron into cast steel. A succession of patents for various improvements was taken out during the next few months, in the course of which the use of steam was dropped, certain particular appliances described, and the production of malleable iron as well as steel claimed. It was speedily found, however, that the production of steel of uniform quality from English pig irons was impracticable, owing to the difficulty in stopping the blowing operation at exactly the right moment to produce the desired degree of carbonization, and that the production of malleable iron was equally an unsuccessful manufacturing operation, because if the "blow" continued a little too long, the product was "burnt iron," containing oxide disseminated through it which rendered it brittle; whilst if the metal were underblown it was hard and steely. Again, contrary to expectation in view of the known action of the puddling process, the oxidation of the copper, sulphur, and phosphorus contained in the pig iron was found to be so faintly marked that practically the resulting "semi-steel" contained the whole of these impurities originally present in the pig iron employed. Accordingly the value of the new process, of which the highest expectations were at first formed, was speedily found to be really but small, notwithstanding the various successive improvements patented by the inventor during 1855 and 1856; towards the end of the latter year, however, the difficulty was solved and the whole process rendered practical and readily controllable by Mushet, who patented the improvement in use to the present day of decarbonizing the iron by completely blowing it, and then adding melted spiegeleisen in known quantity so as to carbonize the total mass to any definite required extent, and also to introduce manganese into the composition, thereby diminishing the injurious effects of sulphur, phosphorus, &c., on its physical qualities,—the character of the metal being further regulated by choosing for the operation hematite pig, or some other kind, containing only minute amounts of sulphur, copper, and phosphorus. Mushet's patent right, however, was allowed to lapse through neglect to pay the requisite fees in the third year; and in consequence his name is all but forgotten in connexion with his improvement on Bessemer's own process, the combination being ordinarily termed "Bessemerizing." Details as to the practical working of the combination process are given in § 36.

It is to be here remarked in connexion with the Bessemer process proper (the blowing) that, whilst the difficulties in the way of preparing uniform products with English irons have led to the entire abandonment of the production of iron or steel thereby in England, the method is still in use to some extent in Sweden, at Seraing, and elsewhere, the proper moment when the blow should cease being determined by rapidly sampling and testing the metal, or by the colour of the slag. In Sweden the charges of metal blown at one operation are occasionally much smaller than those usually employed elsewhere where the combination-process is adopted, whilst the converters in use are sometimes of the fixed pattern adopted by Bessemer in his earlier experiments, now mostly superseded for the spiegeleisen process by the movable converters swinging on trunnions described in § 36; in the newer Bessemer works, however, the most improved methods and arrangements are in use.

In the John Cockerill Works (Seraing) it has been found practicable to ensure the continuous production of pig in the blast furnaces of sensibly constant composition, Algevan and Spanish ores being employed. From these, pig of the annexed composition is smelted and run direct into the converters without solidifying; 23·5 parts of limestone per 100 of ore are employed together with coko (containing 8 to 10 per cent. of ash) in the proportion of 22 cwts. per ton of pig.

	Average Composition of Ores used.	Cinder produced.	Fig.	
Water .....	6·50	..	Silicon .....	2·25
Carbon dioxide.....	2·50	...	Carbon .....	4·50
Silicon.....	15·00	87·00	Sulphur .....	0·04
Alumina.....	4·00	13·50	Phosphorus .....	0·06
Lime .....	8·00	43·00	Manganese .....	3·75
Magnesia.....	0·50	1·50	Iron .....	89·40
Ferrie oxide.....	64·00	0·50		
Manganese oxide.....	4·25	3·50		100·00
Sulphur.....	0·10	1·25		
Phosphoric anhydride	0·075	...		
	89·925	100·25		

Owing to the considerable amount of manganese present in the pig, sufficient of that metal remains unoxidized in the blown product to render it unnecessary to add spiegeleisen thereto; on this depends the practicability of the process; the blowing is continued until a specimen of the slag (obtained during a brief intermission of the blast for the purpose) exhibits a particular colour dependent upon the amount of residual carbon required, whilst the physical characters of the globules of metal interspersed throughout the sample are also noted; the metal is then tipped into the casting ladle, and run into ingots which are reheated when solid enough to be withdrawn from the moulds and rolled without ever cooling below a red heat. The colour scale and the corresponding carbon percentages are as follows:—

Colour of Slag	Percentage of Carbon in Steel.
Lemon yellow .....	0·75 or upwards.
Orange ya low .....	close to 0·60
Light brown.....	" 0·45
Dark brown.....	" 0·30
Bluish black.....	" 0·15

As regards the general character of the blowing operation, it is noticeable that the generation of heat by the oxidation of silicon and carbon is so large that without the use of any fuel at all the metal is not only kept melted but increases considerably in temperature, so that it remains fluid whilst the decarbonization goes on, instead of becoming pasty and almost solid as it does in the puddling forge when "coming to nature." The nature of the gaseous products on blowing a considerable mass of metal, say 5 tons, is somewhat different during the different stages of the process. At first when the metal is at a relatively lower temperature, a considerable amount of carbon dioxide is formed, together with carbon oxide, but later on, when the temperature is much higher, little but carbon oxide is produced. During the early stages, moreover, the amount of oxygen (combined as oxides of carbon) is much less relatively to the nitrogen than in ordinary air, showing that much of the silicon and manganese present are being oxidized; whilst in the latter half of the blow, when the silicon and manganese have largely become oxidized, the amount of oxygen in the issuing gases is much larger, nearly equal to that present in air. Thus the following series of analyses were made by Snelus during an eighteen minutes blow (*Journal Iron and Steel Institute*, 1871, ii. p. 247), the specimens being collected respectively after two, four, six, ten, twelve, and fourteen minutes from the commencement. Similar results have also been subsequently obtained by other chemists, notably Adolf Tamm (*Jern-Kontoret's Annaler*, xxx. 257; also *Iron*, 1879), with the iron made at Westanfors from charcoal pig.

	Time from Commencement, expressed as a Fraction of Total Duration of Blow					
	$\frac{1}{8}$	$\frac{2}{8}$	$\frac{3}{8}$	$\frac{6}{8}$	$\frac{3}{4}$	$\frac{7}{8}$
Carbon oxide .....	nil	3·95	4·60	19·59	29·44	31·11
„ dioxide .....	10·71	8·57	8·15	3·58	2·39	1·54
Oxygen.....	0·02	...	...	...	...	...
Nitrogen.....	88·37	86·58	85·25	76·83	66·01	...
Hydrogen.....	...	0·88	2·00	...	2·16	67·55
	100·00	100·00	100·00	100·00	100·00	100·00

From these analyses Snelus calculates that 43 per cent. of the total carbon oxidized in this blow was converted into CO<sub>2</sub>, and 57 per cent. into CO. It hence results that a considerable development of heat attends the operation, especially with irons moderately rich in silicon as well as carbon. Taking the heat of combustion of carbon to CO as 2400, of carbon to CO<sub>2</sub> as 8000 (§ 20), and of silicon to SiO<sub>2</sub> as 7800 (Troost and Hauteffeuille give 7830), and assuming that these are also the values of the combustion heats of these elements when dissolved in (or united with) iron,—which is not the case, the values being really somewhat lessened by the amounts of heat evolution during the solution in (or combination with) the iron,—it results that, on blowing an iron containing for instance 2 per cent. of silicon and 3 per cent. of carbon, there will be a heat developed to the following extent:—



$$\frac{4 \frac{2}{3}}{1 \frac{1}{3}} \times \frac{1}{1 \frac{1}{3}} \times 8000 = 103 \cdot 2 \text{ due to the formation of } \text{CO}_2$$

$$\frac{1 \frac{1}{3}}{1 \frac{1}{3}} \times \frac{1}{1 \frac{1}{3}} \times 2400 = 41 \cdot 0 \text{ " " " CO}$$

$$\frac{1 \frac{1}{3}}{1 \frac{1}{3}} \times \frac{1}{1 \frac{1}{3}} \times 7800 = 156 \cdot 0 \text{ " " " SiO}_2$$

or an evolution of 300·2 per unit weight of metal blown. Analogous but somewhat different values are calculable with irons of different composition, or with blows so conducted that less carbon dioxide is formed. The mean specific heat of the resulting fused metal and slag is probably somewhere near to 0·20 (at the ordinary temperature the specific heat of iron is 0·1138, Regnault: the specific heat is probably greater as the temperature rises, and, judging by analogy with water, greater in the fluid state than in the solid; the specific heat of the slag at the ordinary temperature is higher than that of iron, but its mass is much less); hence, pursuing the above calculation, the heat evolution would suffice to raise the temperature of the metal  $\frac{300 \cdot 2}{0 \cdot 2} = \text{about } 1500^\circ \text{ C.}$  above its initial temperature, were all the heat applied to that purpose. This is not the case, however, for the containing vessel or converter has also to be heated up, and the waste gases carry off a notable amount of heat with them, whilst radiation and the cooling effects of the air on the converter also take up a considerable fraction of the heat; on the other hand, however, a certain amount of iron becomes oxidized, thus increasing the heat development; if 5 per cent. of metal be thus oxidized, the heat of oxidation being taken as somewhere near to 1200 per unit of weight of metal oxidized, the heat evolution due to this will be  $\frac{1}{1 \frac{1}{3}} \times 1200 = 60 \cdot 0$ , or about  $\frac{1}{3}$  of that due to the joint oxidation of the carbon and silicon. Similarly manganese, if present, becomes oxidized with evolution of heat; on the whole it is, calculated by Jordan, Akermann, Snells, and others who have specially examined this subject, that with the kinds of pig iron usually employed at the present day, and with the size of converters used (holding 5 tons and upwards of metal), the net amount of heat actually employed in heating up the metal is sufficient to raise its temperature by at least  $600^\circ$ ; so that if the initial temperature of the fused pig is about  $1400^\circ$ , that of the blown metal is at least  $2000^\circ$ , being above the melting point of platinum; with highly silicious pig the temperature attained is notably higher than with metal containing less silicon.

When the blowing has gone on for a short period, so that the iron has become perceptibly raised above its initial temperature, a reaction commences between the iron oxide or silicate already formed and the as yet unoxidized carbon, giving rise to the evolution of gas with a sort of effervescence; this stage is technically termed the "boil." The precise period at which it is marked varies with circumstances, a longer time elapsing from the commencement of the blow when the iron is relatively cooler at first, and also when it is richer in silicon,—in the former case because the temperature requisite to produce the effervescent action is not reached until a longer time has elapsed, and in the second because the more oxidizable silicon is chiefly affected first, and the effervescent action of iron oxide, &c., on the dissolved carbon only commences when the silicon is to a considerable extent oxidized.<sup>1</sup> During the earlier part of the boil, whilst the silicon and manganese still present are being oxidized, a greyish or whitish kind of smoke issues from the converter, consisting of minute particles of slag, manganese oxide, &c., mechanically diffused through the gases. When practically all the silicon, carbon, and manganese have been oxidized, and the oxidizing action of the blast is concentrated on the iron, the colour of the smoke emitted changes to brown, and the iron becomes "burnt" or "overblown"; if to such metal containing much iron oxide diffused throughout its molten spiegeleisen be added, as in the after part of the Bessemer-Mushet process (§ 36), the effervescence or "boil" due

to the reaction of this iron oxide on the carbon of the spiegeleisen takes place with almost explosive violence.

The following analyses by Snells (*Journ. I. and S. Inst.*, 1871, i. 39) illustrate the gradual diminution in carbon, silicon, and manganese, and the non-removal of phosphorus during the process of blowing:—

Period since Commencement of Blow, in Minutes .....	Original Pig No. 1	Pig No. 2	Pig No. 3	Pig No. 4	Final Steel after addition of Spiegeleisen.	
					Ingot Boilings.	Ball Crop Ends.
So-called combined carbon.....	1·200	2·170	1·550	0·007	0·566	0·519
Graphite .....	2·470	...	...	...	...	...
Silicon .....	1·952	0·705	0·675	0·120	0·020	0·025
Sulphur .....	0·014	trace	trace	trace	trace	1·000
Phosphorus .....	0·048	0·051	0·044	0·047	0·055	0·053
Manganese.....	0·086	trace	trace	trace	0·209	0·209
Carbon .....	...	...	...	...	0·039	0·039
Iron (by difference).....	94·630	96·984	97·751	99·816	99·001	99·017
	100·000	100·000	100·000	100·000	100·000	100·000

Analogous figures have been obtained by various other observers; the results as a whole show that during the first few minutes of the blow the silicon and manganese mainly are oxidized, raising the temperature, during this period the carbon is also being oxidized, but not so rapidly as during the next interval whilst the boil is proceeding, a result also indicated by the analyses of the gases evolved (*supra*). The oxidation of the silicon, however, may not be complete even when the whole of the carbon has been burnt out, especially if highly silicious pig was used in the first instance; thus steels containing 0·5 and upwards of unoxidized silicon have been found to be formed; when excessively soft steel is required, so that but little spiegeleisen (or preferably ferro-manganese) is added to the blown metal, the presence of this silicon is not only not injurious, but is desirable as it diminishes "honeycombing"; but with ordinary "Bessemer steel" containing several tenths per cent. of carbon, the presence of this amount of silicon is almost fatal to its value, silicon conjointly with carbon producing brittleness to a marked extent. Accordingly it is of importance to blend a highly silicious pig with another kind containing less silicon, or to add to the highly silicious pig crop ends and scrap metal, so as to avoid the presence of too much silicon in the steel ultimately produced; this intermixture when judiciously performed also avoids certain practical difficulties attending the use of pig containing too high or too low an amount of oxidizable matter other than iron; in the former case the temperature attained during the blow is excessive, so that on casting the final steel (after adding spiegeleisen, see § 36) in iron moulds these are partly fused and destroyed; in the former case the temperature attained is not high enough to keep the metal fluid whilst pouring into the moulds, in which case it more or less solidifies in the casting ladle, forming a "skull," whilst the slag partially solidifies in the converter and gradually chokes it. In practice it is usually found desirable to have not less than 2 and not more than 3 per cent. of silicon in the metal before blowing, so as to avoid these difficulties; when the pig is melted in a cupola there is always a liability to loss of silicon and carbon during the fusion through oxidation, thus impoverishing the iron in combustible matter and risking the formation of skulls, owing to the metal not becoming hot enough during the blowing to remain fluid whilst casting; on the other hand, when the metal is run in from the blast furnace direct (by means of an intermediate ladle) there is a liability to variation from time to time in the quality of the pig; this difficulty can be overcome by carefully regulating the working of the furnace. Durfee has proposed to tap the blast furnace into large gas-fired heaters in which the metal is kept melted for a sufficiently long time to determine its charac-

<sup>1</sup> In all probability the reason why the silicon is first affected is simply because more heat is evolved in the formation of silicon dioxide than of carbon oxide, so that if carbon were burnt to carbon oxide silicon would probably react upon it, thus—

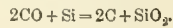

Since the heat of combustion of a unit of weight of carbon to CO is about 2400, and that of silicon to SiO<sub>2</sub> 7800, the transformation indicated by the above equation would evolve  $7800 - \frac{2 \times 12 \times 2400}{28} = 5743$  units of heat per unit of weight of silicon,—a tolerably high value, indicating a considerably strong tendency towards the occurrence of this transformation.

ter, pig rich or poor in silicon and carbon as the case may be being then added to give the requisite composition.

According to Stead the rate at which silicon is oxidized in the converter relatively to carbon is somewhat different according as the temperature attained is extremely high or comparatively low. In the latter case the silicon is wholly eliminated before the carbon disappears, even when the original amount was large, say 3 per cent. silicon and 3.5 of carbon; in the former case however, the relative rate of oxidation of the silicon is less rapid, so that the carbon becomes oxidized before the last traces of silicon have disappeared. Thus the curves illustrated in fig. 53 indicate the

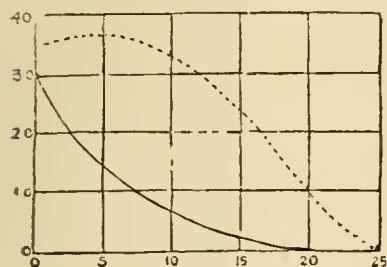

At lower temperature

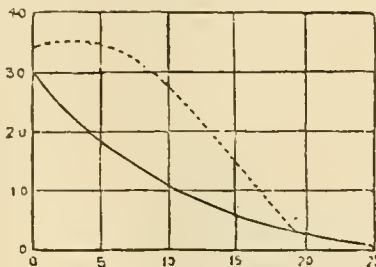

Fig. 53.

the blast furnace, chiefly on account of the much higher temperature of the converter gases and the intermittent character of their generation during a series of blows; but stoves for heating the blast for the cupolas used in melting the spiegeleisen, &c., have been successfully heated in this way, the flame being applied in much the same way as that obtained from blast furnace gases. For the description of a method used for this purpose in Sheffield, see a paper by C. B. Holland, *Journal I. and S. Inst.*, 1878, p. 104.

28. *Heaton's Process.*—The chemistry of this process is closely allied to that of Bessemer's, the oxidizing gases used to decarbonize the pig iron being blown through the fused mass so as to produce either a semi-steel, a harder steel, or something approaching malleable iron, according

percentages of carbon and silicon contained in the metal in different stages of the blowing, the dotted lines representing the former and the continuous lines the latter, the abscissæ representing times and the ordinates percentages. Just at first the carbon percentage slightly increases owing to oxidation of metal and silicon and their removal as slag; but by and by the rate of carbon removal becomes rapid, whilst the rate of silicon removal is a maximum at first and gradually diminishes, more rapidly at the higher temperature.

Attempts have been frequently made to use the spectroscope as a means of determining the moment when the last portions of silicon and carbon have become oxidized; but it is very doubtful whether the indications of the character of the flame as seen by the unaided eye are not as a general rule practically at least equally valuable with those of the spectroscope, and much more readily attainable. At any rate, the spectroscope is but little used in actual manufacturing practice in England; on the Continent, however, its use is somewhat more frequent.<sup>1</sup> The more smoky the flame the less distinct are the spectroscopic indications, so that with highly manganized pig (e.g., pig from Austrian sphatose ores) the instrument is all but useless. With certain kinds of pig the progress of the decarbonization can be readily judged by the colour of the slag; the peculiar roar of the blast alters slightly in character when the decarbonization is complete, so that an experienced hand can judge by the sound alone when the operation is about finished. For details of apparatus, &c., see § 36.

The slag formed during the blowing usually approximates in composition to the metasilicate formula  $R_2O, SiO_2$ , where  $R_2$  is either iron or manganese,—in this respect differing from the tap cinder of the ordinary puddling forge, which is much more basic. This arises from the highly silicious nature of the lining of the converter (see § 36).

It has been proposed by Snelus to utilize the gases discharged from the converter especially during the latter half or so of the blow, in the same way that blast furnace gases (which they closely resemble in general composition, § 18) are utilized; the practical difficulties are, however, considerably greater than in the case of

to the amount of carbon oxidation effected,—the gases employed being, not ordinary air, but the mixture of nitrogen, nitrogen oxides, and oxygen evolved by the action of heat upon sodium nitrate. This salt is packed at the bottom of the converting vessel (usually a vertical cylinder of iron lined with firebrick) to the extent of about 10 per cent. of the weight of the pig to be treated, and covered over with a perforated cast iron plate; the pig, previously melted in a separate furnace, is run into the converter; the heat melts the sodium nitrate and causes an evolution of gas, at first comparatively slow, but gradually increasing in violence as the perforated iron plate melts, until a rapid ebullition of the whole mass takes place; after a few minutes the reaction is over; the partly decarbonized fluid mass is then run into ingot moulds (if the mass operated upon is sufficiently large to render the product fluid enough) or otherwise removed from the converter, conveniently by detaching the bottom portion, which is made removable purposely; the masses of "crude steel" are then reheated and rolled, or melted in crucibles, so as to produce either bar or crucible steel as required.

Unlike the Bessemer process, Heaton's method brings about a sensible diminution in the quantity of phosphorus present. To all probability this is due to the alkalinity of the cinder owing to the soda from the nitrate, this acting like the lime lining to the converter in Thomas and Gilchrist's modification of the Bessemer process (§ 37); it is evident, however, that the character of the resulting product depends on the uniformity of the pig iron used, and the amount of nitrate of soda employed. The practical difficulties in the way of carrying out the process on the large scale, and of securing uniformity of product, and the non-entire removal of phosphorus, have prevented this method from seriously competing with the other leading steel-making processes; but a number of experimental trials made on a moderately large scale have demonstrated the possibility of obtaining a good class of useful steel by its means. According to Gruner the elimination of phosphorus becomes almost imperceptible if the cinder formed contains upwards of 30 per cent. of silica produced by the oxidation of the silicon in the pig.

## VI. METHODS INVOLVING THE PRODUCTION OF STEEL OR MALLEABLE IRON DIRECT FROM THE ORE WITHOUT PASSING THROUGH THE STAGE OF FUSED PIG IRON.

29. *Catalan Forge.*—This variety of bloomery may be taken as being a typical development of the earliest crude apparatus for extracting iron from its ores, represented in almost its simplest form by the rough clay furnace used for the first stage of wootz making (§ 35), and by the analogous small furnaces in use in Burmah, Madagascar, Borneo, &c.; with various modifications it is still in use in different localities, e.g., the Pyrenees, Corsica, and especially in some parts of America and Canada. In principle all these forges may be considered as a more or less enlarged blacksmith's or ordinary rivetting forge, in the bed of which are

<sup>1</sup> A report of a lecture on the use of the spectroscope in Bessemerizing, given by Roscoe to the Iron and Steel Institute, is to be found in the *Journal I. and S. Inst.*, 1871, ii. p. 33. Alleyne has attempted to utilize the spectroscope for the determination of phosphorus in steel, *ibid.*, 1875, i. p. 62.



placed together the ore to be reduced and the fuel; the blast being applied, partly by the direct action of the carbon, partly by the carbon oxide generated, the iron ore is gradually reduced to a spongy mass of metal which by stirring is gradually agglutinated into a ball which is removed and worked into bars, &c. The Pyrenean forge essentially consists of a silicious stone bottom (covered over with a "brasque" of charcoal powder rammed down), with a tuyere inclining downwards, as indicated in fig. 54.

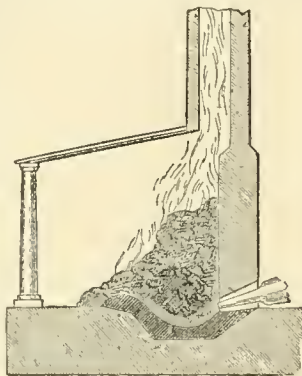

Fig. 54.

the front part of the forge is filled up with the ore to be reduced, and the hinder part with charcoal, and the whole coated over with a layer of moist mixed fine ore and charcoal dust (*greillade*) to moderate the combustion. A gentle blast is at first applied, and the formation of flame channels throughout the mass avoided by putting on more *greillade* wherever any flame of magnitude appears on the surface; in this way the ore gets largely reduced to spongy metal by the carbon oxide; a portion is only reduced to ferrous oxide, and this unites with the silicious gangue, forming a fusible cinder which, bathing the mass of spongy metal, prevents its becoming highly carbonized; finally, the blast being increased and the whole contents of the hearth being gradually stirred together, the reduced metal becomes agglomerated into spongy masses. According to the way in which the materials are manipulated, the resulting iron is more or less steely in character: a slow and prolonged reduction facilitates the carbonization of the metal, yielding a product containing 0.5 per cent. of carbon and upwards; a more rapid blast, and one impinging more directly on the bath of melted cinder and spongy metal at the base of the hearth, produces a softer and far less carbonized iron. Even after well working under the hammer until fibrous in texture, the bars produced are apt to be non-homogeneous, steely portions being irregularly interspersed. Owing to the non-addition of flux, a great waste of metal is produced by the formation of cinder containing usually some 30 per cent. and more of iron as silicate; the exact amount of loss of course varies with the ore employed, being less the purer the ore and the more open its texture, so that reduction takes place more readily; for this reason brown hematites of not too compact texture are the ores preferably worked by the Catalan forge, the expulsion of water on first heating leaving the residual oxide in a condition in which it is more readily attacked by the reducing agents than is the case with nearly anhydrous compact red hematites, &c.

In various places where the Romans smelted or reduced iron from different kinds of ore by processes substantially the same as this, large accumulations of highly ferruginous cinders exist, e.g., in the Forest of Dean, Elba, Spain, &c.; many of these contain sufficient iron to be capable of being profitably smelted in the blast furnace either alone or admixed with other ores, being frequently quite as rich as average Cleveland clay ironstone after roasting; they usually approximate in composition to the orthosilicate type,  $2R_2O, SiO_2$ .

The Catalan forges of the south of Europe are usually of such dimensions as hold from 3 to 10 cwts. of ore; those formerly in use in Austria, and to some extent still in America (e.g., the Champlain forge), have the blast heated to a greater or lesser extent by the waste flamas from the forge, which are made to heat a serpentine through which the blast is blown, thereby causing a considerable saving in the amount of charcoal required, sometimes amounting to

about 20 per cent. of the quantity requisite with cold blast when the blast temperature averages about  $300^{\circ}$  (Sterry Hunt). The titaniferous iron sand smelted at Moisie in similar forges is much less easily reducible than most other ores, and consequently consumes a much larger amount of fuel in proportion; owing to the almost complete absence of sulphur and phosphorus, a very fine quality of iron can be produced therefrom. The American bloomery processes, whilst resembling in general principles the old European Catalan forge methods, differ considerably therefrom in working details, mode of construction of hearth, dimensions, &c. An account of them and the ores worked by them, abridged from Sterry Hunt's Reports to the Canadian Geological Survey, is to be found in the *Journal Iron and Steel Inst.*, 1871, ii. 103 and 126.

**30. Spongy Metal Processes.**—The essential chemical reaction taking place in the Catalan forge being the reduction of oxide of iron to the metallic state by carbon and carbon oxide, it has been attempted by many inventors to effect this reduction on a larger scale and in separate apparatus, the spongy metal thus obtained being employed either to form malleable iron by heating to a welding heat and hammering, &c., or to produce steel by fusion in crucibles with carbonaceous matter or intermixture with fused cast iron (free from any considerable quantity of sulphur and phosphorus) so as to reduce the percentage of carbon to any required limits in proportion as more or less spongy non-carbonized metal is employed. This latter application comes rather into the category of processes described later on (§. 36 *et seq.*) than into the class at present under discussion; its employment has met with some considerable degree of success in one form or another,—which can hardly be said of the former methods of working up the spongy metal, at least from a commercial point of view.

Some of the earliest experiments in this direction were made about 1837 and 1840 by Clay,<sup>1</sup> whilst since then and even quite recently several attempts have been made to prepare either iron or steel by operations substantially of the same description by Gurllt, Larkin (who reduces very pure fine magnetic ore by heating with charcoal powder, separates the spongy metal by a magnet, and fuses it with spiegeleisen in crucibles), Renton (of Cincinnati and Newark), Henderson (of Glasgow), Yates, and Snelus, who utilizes the "Gherstonofer" furnace used for burning pyrites smalls in vitriol making, substituting powdered iron ore for the pyrites, and a reducing atmosphere for the hot air employed to oxidize the pyrites and burn off the sulphur. Moderately large scale experimental trials in this direction have been made by Chenot, and subsequently by Siemens and by Blair of Pittsburgh. Chenot's reducing furnace was essentially a series of vertical conical retorts heated externally, the ore (Bilbao, Sommorostro, or other ores containing but little sulphur and phosphorus) being either mixed with carbonaceous matter and the mixture heated in the retorts, or else being placed therein alone whilst a mixture of carbon oxide and nitrogen (prepared by blowing air through incandescent charcoal) was passed through them; from time to time the reduced spongy metal was drawn off at the base of the retorts into covered iron boxes, so as to prevent reoxidation as much as possible, and then heated in a charcoal hearth and made into a ball when pasty. It is mainly in this last stage that the practical difficulties of the process are encountered: if the sponge be not powerfully compressed into comparatively solid blocks, an enormous waste by oxidation during the balling is produced; in any case, as it is practically impossible to continue the reduction of the ore in the first stage sufficiently long to remove all oxygen from it (the time requisite and the cost of fuel being then excessive), a great waste of iron ensues. These difficulties have hitherto proved fatal to the commercial success of the process; but it has been shown conclusively that a very good iron may be produced by its means, provided sufficiently pure ore be used.

The same causes of failure for the most part apply to the earlier methods of Clay, and the subsequent ones of Gurllt, Renton, Yates, Snelus, and Blair, which in principle are all much the same, the nature of the apparatus employed in producing the spongy iron being the main difference in the various processes respectively. Chenot's attempts to produce steel from the reduced spongy iron answered no better, commercially speaking, than the malleable iron manufacture from that source; the sponge was simply compressed into small blocks after being mixed with charcoal powder, or after being moistened with melted resin, tar, or fatty matters, and heated to char the organic matters, and then melted up in crucibles. The

<sup>1</sup> For details of these experiments, see Percy's *Metallurgy*.

difficulties in the way of regulating the degree of carbonization, the cost, and the impurity of the resulting steel (unless excessively pure ores were used) rendered the process practically a failure. Fig. 55 indicates the apparatus used by Blair for the production of spongy iron. A is the reducing chamber into which the ore is placed along with about 5 per cent. of lime, which is found to accelerate the reduction considerably, so that a charge can be worked off in about a fifth of the time that would otherwise be requisite. Through this chamber a current of carbon oxide and nitrogen is led,

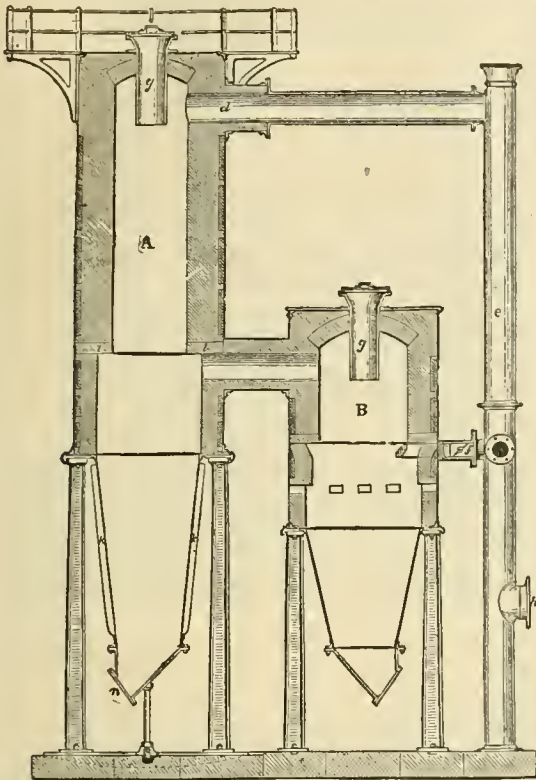

Fig. 55.

produced in the gas generator B; ore and fuel are supplied from time to time through the respective hoppers *g, g*. The escaping gases pass away through the flue *deh*, a valve *f* being applied so that part of the gas can be passed back again through the producer so as to keep the action from going on too quickly. From time to time the reduced metal is withdrawn by the slide *n* from the cooling-box *kk*, which is surrounded by a water jacket to facilitate the cooling of the spongy iron.

Siemens has attempted to apply a modification of the spongy iron process to the manufacture of steel, the spongy metal from a mixture of ore and carbonaceous matter heated in a revolving furnace being dropped into a bath of melted pig metal; this method, however, was found to give unsatisfactory results, first because the spongy iron would not readily dissolve in the molten pig but floated on its surface, and secondly because sulphur was taken up by it from the gases during its reduction; accordingly the precipitation method described below was adopted in its place.

Dupuy has recently proposed a direct process worked as follows: the ore to be reduced is mixed with carbon, and the mixture placed in an annular vertical cylinder of sheet iron some 3 feet high, the outer diameter of the cylinder being about 20 inches, and the inner diameter 7 or 8 inches; a number of these masses are arranged on the coke floor of a reverberatory furnace; after heating for some hours the reduced metal and the sheet iron coatings cake together so that the masses can be removed and hammered and squeezed to muck bar, cut up, piled, and reheated and rolled into plates, bars, &c.; or they may be fused down on the open hearth into steel. It is claimed that by this treatment the metal takes up not more than one-fourth of the phosphorus contained in the ore instead of practically the whole as when smelted in the blast furnace; thus the ore of the Republic Mine of the Lake Superior district and the metal made from it by Dupuy's process gave the following numbers (Dupuy, *Journal Franklin Institute*, December 1877; see *Iron*, vol. x. p. 803):—

	Ore.	Dupuy's Metal made therefrom.
Iron .....	69.48	98.704
Phosphorus .....	0.053	0.018
Carbon .....	...	0.042
Silicon .....	...	0.021
Sulphur .....	...	0.032
Slag .....	...	0.185
Phosphorus per 100 of iron.....	0.076	0.016

The inventor considers that the phosphorus compounds do not become largely reduced in the process owing to the incomplete fusion of the metal during the reduction, the phosphates remaining blended with the cinder; as he states that the process works much better when alkalis, in quantity and kind determined by analysis of the ore, are added to the mixture before reduction, presumably the non-reduction of phosphorus is due to the "basic" nature of the cinder.

31. *Siemens Precipitation Process.*—About the most successful of the methods for producing iron or steel direct from the ore at one operation is that designated by Siemens the "precipitation process" (*Chem. Soc. Journal*, 1873, p. 661); although it is doubtful whether this can yet be said to have completely emerged from the conditions of experimental trial as to the best conditions for competing with other methods in regard of cheapness of production, yet its practical success is demonstrated by its having been worked commercially not only in England but also in America. The principle of the process is essentially the fusion by means of an intensely heated "regenerative" furnace of the ore to be reduced with a suitable flux (lime, aluminous ore, &c.), and the reaction upon the fused substance of heated anthracite or hard coke forming the covering of a lower bed in the furnace (fig. 56), on to which the fused ore

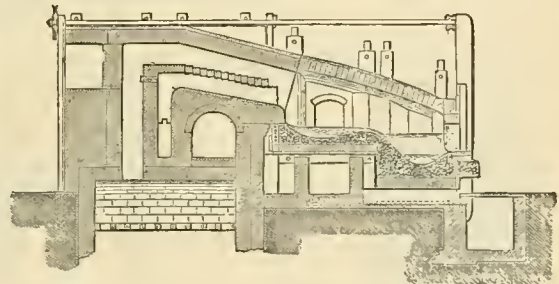

Fig. 56.—Cascade Furnace—Longitudinal Section.

is allowed to flow from the upper bed. Under these circumstances the solid carbon precipitates iron from the fluid in the same way that iron precipitates copper from copper sulphate solution (saving that in the latter case no gases are evolved as complementary products); the iron agglutinates together into a pasty ball immersed in a fluid bath of cinder; when the operation is sufficiently advanced the ball is removed and shingled into blooms or made into steel by dropping it into a mass of fused pig iron, in which it rapidly dissolves. The cinder thus produced contains much iron,—usually at least 15 per cent., and sometimes upwards of 40 per cent. In an improved form of process, the double bed is dispensed with and a rotary furnace substituted (figs. 57, 58), much resembling Siemens's puddling furnace, save that the combustion chamber is rotative; the ore and flux are introduced and melted; small coal of the size of nuts is then shovelled in, when a rapid evolution of carbon oxide results, so that it is unnecessary to introduce more than a little gas from the gas regenerative heater, but mainly only heated air to burn the evolved carbon oxide; when the reduction is nearly complete, the fluid cinder is drawn off and the spongy metal balled by quick rotation for a short time. In this way, according to Siemens, a ton of iron may be reduced with



a consumption of not more than 25 cwts. of coal, and a ton of cast steel made with about 40 cwts. of coal; whilst even though the ore and fuel may contain considerable amounts of sulphur and phosphorus, the "precipitated" iron is almost chemically pure. The temperature requisite in this process being excessive, the bricks of which the furnace is con-

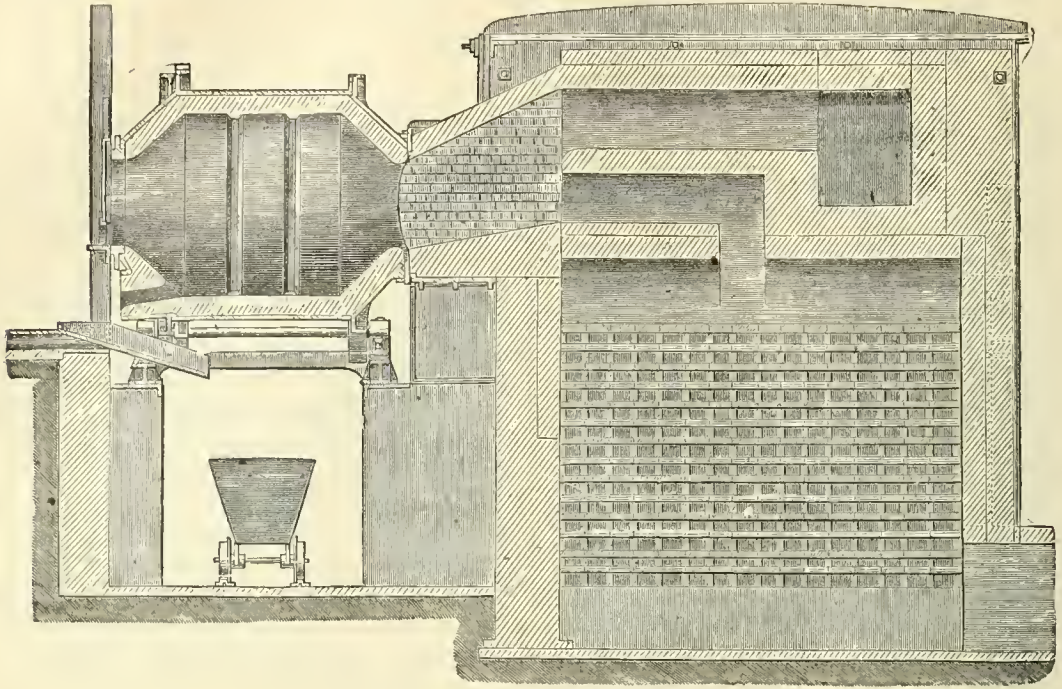

FIG. 57.—Siemens Rotator—Longitudinal Section.

structed must be of the most infusible material possible; and about 2 per cent. of lime mixed together and moulded into a particular kind of silica brick consisting of crushed quartz into bricks answers better than alumina (bauxite) bricks

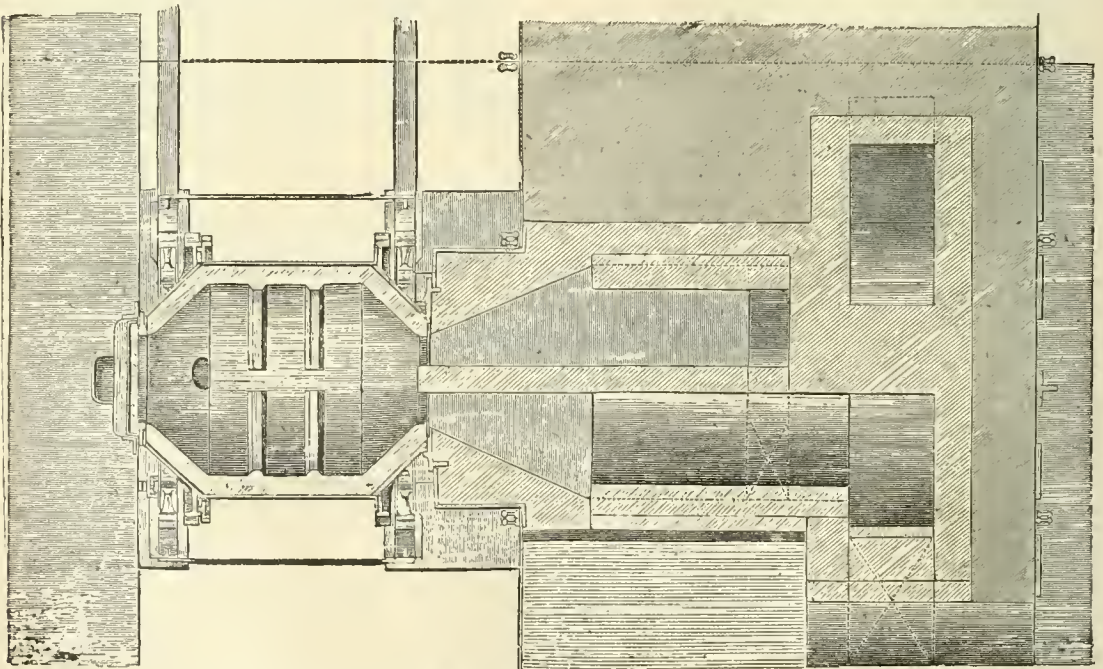

FIG. 58.—Siemens Rotator—Sectional Plan.

On comparing the actual consumption of fuel in this process with that used in the smelting of iron by the blast furnace and its purification by puddling, it is at once evident that a much less amount of heat is lost by radiation, conduction, and escape of hot gases and of only partially oxidized carbon (in the state of carbon oxide) in the regenerative direct process than in the blast and puddling furnaces



conjointly. When coal is completely burnt by cold air to carbon dioxide and water vapour (not liquid water), the products of combustion escaping at a temperature of say 300°, the actual heat development is variable with the character of the coal, but may be taken as approximately near to 7600, the unit of weight being the weight of coal burnt; for the heat of combustion of ash-free average coal may be taken as near to 9000, or about 8550, allowing 5 per cent. of ash (§10), when the resulting carbon dioxide and liquid water are at about 20° C.; a less amount of heat, however, is generated if the products of combustion escape at a higher temperature, say 300° C., the difference being  $0.4 \times 593 + (0.4 \times 0.48 + 3.0 \times 0.216) (300 - 20) = 462$  when the coal is considered to yield 3.0 times its weight of carbon dioxide and 0.4 times its weight of water on complete combustion, 593 being the latent heat of water vapour at 20°, and 0.48 and 0.216 the specific heats of water vapour and carbon dioxide respectively. The nitrogen of the air used for combustion, however, is also heated to 300°, starting originally say at 20°; making allowance for the oxygen supplied by the ore, suppose that in the Siemens process the nitrogen escaping is 6.0 times the weight of the coal used, its specific heat being 0.24; then the heat carried away by the nitrogen is about  $6.0 \times 0.24 \times (300 - 20) = 403$ . On the whole, therefore, the effective calorific value of the coal will be  $8550 - (462 + 403) = 7685$ , or 7600 in round numbers.

In order to reduce ferric oxide to metal, the heat consumption per unit weight of iron may be taken as about 1700 (contrast §20); the heat carried out from a Siemens furnace hearth by a ball of iron will be somewhat greater than that by an equal weight of fused pig iron from a blast furnace on account of the higher temperature, say 350 instead of 330; the same will apply to the cinder, but this increase will be more than counterbalanced by the smaller quantity thereof, so that, assuming 600 heat units to be carried out by one part of slag by weight, and the cinder to amount to 50 per cent. of iron, the heat thus carried out per unit weight of iron will be  $0.5 \times 600 = 300$ . Altogether, therefore,  $1700 + 350 + 300 = 2350$  units of heat would be requisite per unit weight of iron were it possible to reduce the ores in the Siemens rotator without loss by radiation, &c., and imperfect combustion, the gases leaving the regenerators at 300°; this would correspond to about  $\frac{2350}{7685} = 0.309$  parts of coal, or somewhat less than 6½ cwt. per ton of iron. If then 25 per cent. of the total heat generated by the fuel be utilized, 75 per cent. being wasted through incomplete combustion, gases leaving at a higher temperature than 300°, and radiation, &c., still reduction would be accomplished by an expenditure of only 25 cwt. of coal per ton of iron. By a somewhat different mode of calculation Siemens arrives at much the same result (*Chem. Soc. Journal*, 1873, p. 677), viz., that about 6.4 cwt. of carbonaceous matter should theoretically suffice to reduce a ton of iron in the precipitation furnace; and hence that about 25 per cent. of the heat actually capable of being generated is actually utilized. This high "duty" (as compared with other operations of the iron industry, especially with the blast and puddling furnaces conjointly) arises from the circumstance that whilst the reaction is proceeding carbon oxide is copiously evolved from the materials, and this is burnt in the furnace itself by admitting air and very little other gas so as to keep up the temperature almost without extraneous fuel; the carbon dioxide produced by the combustion, being above and not in contact with the reacting substances, does not in any way interfere with their action, in which respect the process of reduction in the precipitation furnace markedly differs from that in the blast furnace.

The following table, prepared by L. Gordon for Siemens (*Journ. I. and S. Inst.*, 1873, p. 57), is of interest as representing the relative consumption of fuel during the production of one part by weight of iron by various of the processes largely used at different epochs up to the present date.

Charcoal: Ancient Direct Processes.

		Average.	Equivalent in Wood. <sup>1</sup>
I. East Indian forges .....	5.0 to 8.16	6.58	21.9
Catalan .....	2.75, 2.98	2.87	9.6
Slegan .....	...	4.40	14.7
II. Styrian and Carinthian ...	2.85, 3.07	2.89	9.6
Stücköfen .....	...	4.00	13.3
Chenot's process .....	2.66, 2.00	2.78	9.3
III. Siemens rotator process ..	...	...	2.0

Charcoal: Blast Furnace and Puddling Forge.

	Blast Furnace.	Puddling Forge.	Total.	Equivalent in Wood. <sup>1</sup>
	Average	Average		
IV. Styria and Carinthia .....	0.71	0.90	1.61	5.4
Rhine .....	0.96	0.95	1.91	6.4
Norway .....	1.43	1.00	2.43	8.1
Sweden .....	1.21	1.00	2.21	7.4

<sup>1</sup> 100 parts of wood reckoned to yield 30 of charcoal.

Coal: Blast Furnace and Puddling Fire

	Blast Furnace.	Puddling Forge.	Total Coal.
	Average.	Average.	
Silesia .....	2.75	1.00	3.75
Belgium .....	2.78	0.99	3.78
France .....	2.39	0.90	3.29
VI. Scotland .....	2.72	1.00	3.72
Cleveland .....	1.99	1.00	2.99
Staffordshire .....	3.02	1.25	4.27
S. Wales (Dowlais) .....	1.48	0.85	2.33
VII. Siemens rotator process ..	...	...	1.25

Details of the manufacture of iron by this method, of its conversion into steel by further treatment with pig, &c., in the rotator itself, analyses of the metal and cinder produced, &c., are to be found in the *Journ. I. and S. Inst.*, 1877, p. 345; the total consumption of fuel for the production of wrought iron of highest quality is there described as being about 3.0 parts per unit of iron (60 cwt. per ton), of which quantity about one-third is assigned to the rotator, the remainder being used in the reheating furnaces.

Within the last twelve months Holley has communicated to the American Institute of Mining Engineers the results obtained with a large rotating furnace set up at Tyrone, Pennsylvania, to produce material for open hearth steel furnaces by Siemens's direct process. The charges were—ore (containing about 50 per cent. of iron) 2000 lb; reducing coal 600 to 700 lb; limestone 250 lb; scale and cinder 800 lb. The yield of blooms was 1600 to 1700 lb per charge, or 60 to 85 per cent. of the metal contained in the ore; nineteen operations per week producing 14 tons of blooms were made, the producer coal being 3800 lb per ton of blooms. The total coal consumption was thus on an average near to 4600 lb per ton.

*Jones's Process.*—A peculiar process, in principle somewhat analogous to the Siemens precipitation method, has been proposed by F. F. Jones (*Journ. I. and S. Inst.*, 1873, 251), consisting of a cupola furnace into which ironstone slag and coke or other fuel is charged, an air blast being applied so as to melt the ores by the heat developed by the combustion of the fuel; another blast is then turned on through a second set of tuyeres directed downwards obliquely towards the bottom of the hearth, the jet of gas thus introduced being the mixture of carbon oxide and nitrogen produced by blowing air through a second cupola full of coke only after the fashion of the Tésié du Motay gas producer (§10); by this means rapid reduction of the iron oxide is brought about, the process being a sort of inverted Bessemer blow, oxygen from fused oxide being burnt out by a stream of carbon oxide instead of carbon being burnt out from fused cast iron by a stream of air. Carbon is taken up by the metal thus produced to the extent of several tenths per cent., but it is remarkable that silicon is not thus reduced. Phosphorus is largely present in the resulting metal if contained in the materials used.

VII. CONVERSION OF MALLEABLE IRON INTO STEEL BY DIRECT CARBONIZATION.

32. *Cementation Process.*—It has been known for a long period, some two centuries at least, that when wrought iron is enveloped in powdered charcoal and heated to redness for a long time it gradually becomes carbonized and converted into steel, the deposition of carbon commencing at the outside and gradually penetrating inwards in precisely the same way as that in which the decarbonization of iron proceeds in the manufacture of malleable cast iron (§22), a longer time being consequently requisite for the carbonization of thicker than of thinner bars; the name of the inventor of the process, however, has been forgotten. In the middle of the 16th century it was known that when a bar of wrought iron was kept immersed for a long time in molten cast iron it gradually became acierated by taking up carbon from the cast iron; this process is clearly closely allied to cementation in solid carbon, and was probably the forerunner thereof; very likely it was in the first instance an accidental observation; it was described as being in actual use about that period by various writers, notably Biringuccio in 1540 and Agricola (*De Re Metallica*,



1561, p. 341). Early in the 18th century Réaumur investigated the character of the process, and found that under similar conditions a bar of iron of 0.2 inch in thickness was carbonized in six hours to the same extent as another bar of the same metal of 0.45 inch in thickness in about thirty-six hours. The crude "blister steel" produced by the cementation process (so termed from its blistered surface) is often simply cut into pieces, piled, heated to a welding heat, and forged, when it is converted into "shear steel"; or this process is repeated, when it becomes "double shear steel"; but when a perfectly homogeneous product is required it is melted in crucibles, when it becomes "cast steel": this process was introduced by Huntsmann about 1740. The nature of the chemical changes taking place during cementation have been often regarded as somewhat uncertain; but there seems to be little room for doubt that the action in the ordinary cementation process is mainly due to the occlusion of carbon oxide (formed by the action of the air in the pores of the charcoal) in the iron, and its decomposition by the metal into carbon and an iron oxide, which is subsequently again reduced by a second portion of carbon oxide, thus—

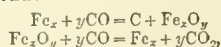

the two changes going on simultaneously. The escaping carbon dioxide, which penetrates through the metal less readily than does carbon oxide, and hence is apt to accumulate in certain parts, is probably the cause of the blistering of the surface of the steel often observed, especially with puddled bars containing small quantities of ferrous silicate disseminated through them; Percy has shown that fused homogeneous metal free from interspersed slag does not give rise to blisters on cementation. Certain hydrocarbons, e.g., paraffin vapour and coal gas, will carbonize iron heated therein, and the manufacture of steel by cementation in the latter has been patented by Macintosh (*vide infra*). Probably in these cases the carbon comes from the direct splitting up of the hydrocarbon, with elimination of hydrogen; but possibly the aëriation is due to carbon oxide present in the coal gas or formed from the paraffin vapour, &c., by the action of iron oxide disseminated through the bars or adherent to their surface. Many cyanogen compounds, especially ferrocyanide of potassium, when applied to iron in a heated state convert it exteriorly into steel (case hardening), and it has in consequence been supposed that nitrogenous substances are essential to the carbonization of iron by cementation, and that nitrogen is an essential constituent of steel. The evidence in behalf of this is, however, at present unsatisfactory; on the other hand, charcoal rich in alkalis, or a mixture of charcoal powder with a little lime and soda, will carbonize iron submitted to cementation therein more rapidly than charcoal more free from alkalis; and, as these conditions are those favourable to the formation of alkaline cyanide from the nitrogen of the air, there is some reason for supposing that the carbon in the steel formed under such circumstances (like that produced in case hardening by means of ferrocyanide) is more or less derived either from cyanogen separated from the cyanide and occluded by the iron and gradually decomposed with formation of carbon, or from some other reaction of iron upon the cyanide. Accordingly nitrogenous organic matter, such as animal charcoal, leather, horn, &c., is often mixed with the charcoal used for cementation with a view to facilitating the conversion into steel by the formation of gaseous carbon compounds with the simultaneous presence of nitrogenous vapours.

The theory that carbon oxide is the source of the carbon communicated to wrought iron during cementation, appears to have been first propounded by Leplay in 1846 (*Ann. de Chim. et Phys.* [3] xvii. 221), at a time when the properties of metals and other bodies in absorbing gases (*i.e.*, the phenomena of *occlusion*) had not been so well studied as they have been subsequently. Leplay appears to have

considered that the carbon oxide splits up *directly* into carbon and carbon dioxide, the latter becoming again transformed into carbon oxide by the surrounding charcoal, and to have left out of consideration the intervention of the iron in becoming alternately oxidized and reduced. Other chemists have considered that by direct contact with carbon combination of the iron therewith takes place, the carbon thus taken up by the outer layer quitting that and combining with the next layer, and so gradually travelling inwards, the outer layer recombining with more carbon as fast as it parts with carbon to the under layer, and so on throughout; the carbon thus traversing the iron by a process somewhat akin to that by which a drop of mercury in contact with a piece of gold (or certain other metals) gradually passes into and permeates the mass,—this being in short a kind of capillary action exerted upon a solid substance. Percy's observation (*Metallurgy*, "Iron and Steel," p. 109) that charcoal after being intensely ignited will not carbonize iron when air is excluded by means of hydrogen (although it will do so to some extent if still containing matters capable of being driven off by heat) negatives the possibility of the carbon being taken up by *direct contact* by this hypothetical kind of chemical union between solids, or solvent action of one solid on another; it may be that carbon deposited on the outer layer by the chemical action of the iron on carbon oxide, cyanogen compounds, carburetted hydrogen, &c., permeates inwards by this supposed diffusive process; but the known phenomena of the absorption of gases by colloid bodies, diffusion, dialysis, occlusion, &c., as elucidated by Graham and his followers, render it wholly unnecessary to suppose that any such action takes place, and do away with all experimental grounds for supposing that it can take place. In order to carry out the process of cementation, the bars of iron are placed in a firebrick box or chest several feet long, layers of charcoal and iron being alternately piled in until the box is filled, when a luting of fireclay or of the sandy ferruginous mud produced in grinding and polishing steel articles after manufacture, termed "wheel swarf," is applied so as to close up the upper part of the box and prevent access of air; two or more such chests are then arranged under the arched roof of a chamber erected over a fireplace in such a way that the flames from the fire pass under and lap round the sides of the chests, and impinge upon the roof, the gases escaping through orifices in the roof into a conical chimney built over the whole,—the chamber constituting in fact a kind of furnace somewhat like a glass house or pottery kiln, the flame passing upwards from the bed instead of laterally from a fireplace at the side as in the ordinary reverberatory furnaces. Trial bars are arranged in the mass of charcoal in such positions that they can be withdrawn from time to time, and the progress of the operation examined by fracturing the bars after cooling, and seeing when the core of malleable iron disappears; from seven to ten days' heating according to the amount of carbonization required (averaging about 1 per cent.) is generally allowed, with a total charge of some 10 to 20 tons of iron in the furnace. When the requisite carbonization is attained the fire is raked out and the chests allowed to cool; the blister steel is then either melted down into cast steel, or converted into shear steel by piling and forging, &c.

According to Boussingault a material diminution in the amount of sulphur present takes place during cementation; thus he found malleable iron specimens containing 0.012 to 0.015 per cent. of sulphur yielded steels containing only 0.005 to 0.006 per cent. of sulphur. Indications in the same direction but not to so great an extent have also been observed by others; no noticeable effect, however, is produced on the silicon, phosphorus, or manganese originally present, as far as the irregular way in which traces of cinder are always interspersed throughout bars of wrought iron will permit conclusions to be drawn. The following analyses indicate the effect of cementation on Swedish bar irons:—

Analyst .....	Pattinson and Stead.				H. S. Bell.	
	Hoop G L Bar.	Steel.	Hoop L Bar.	Steel.	Danne- mora Bar.	Steel.
Iron .....	99.298	98.571	99.600	98.699	99.471	98.608
Carbon .....	0.470	1.200	0.226	1.210	0.352	1.250
Manganese .....	0.120	0.100	0.044	0.044	0.075	0.072
Silicon .....	0.037	0.066	0.052	0.028	0.050	0.033
Sulphur .....	0.035	0.027	0.015	0.013	0.027	0.022
Phosphorus .....	0.032	0.030	0.008	0.006	0.025	0.018
Copper .....	0.005	0.006	trace	trace	...	...
	100.000	100.000	100.000	100.000	100.000	100.000

In consequence of the phosphorus originally present remaining unchanged, only the purest brands of iron as free as possible from these ingredients are converted into cementation steel, often known as "tool steel," commanding a high price in consequence of its physical properties, the most valuable of which are enormously deteriorated by minute quantities of sulphur and phosphorus. The process of cementation in an atmosphere of coal gas as patented by Macintosh of Glasgow consists of exposure of the bars of iron hanging vertically in a cylindrical chamber, the walls of which are kept

at a high temperature by an annular fireplace surrounding it, a gentle stream of well-desulphurized coal gas being allowed to pass through the chamber. The expense of the process seems to have been the chief bar to its adoption, as steel of excellent quality can readily be made by it from good malleable iron.

33. *Cast Steel.*—The crucibles or “pots” used for steel melting are usually made of refractory fireclay, often with an admixture of graphite, which not only communicates a greater degree of infusibility, but also diminishes the decarbonization which partial access of air unavoidably brings about during melting; they are of such size as to hold from 40 to 60 lb of steel, and occasionally more, even up to nearly a cwt., especially in certain American steel works. As a rule a pot that has served for three successive meltings in a coke-fired furnace is so much damaged as to be unsafe for a fourth; and with inferior kinds of clay two meltings or even one only are allowed; with superior pots and gas-fired furnaces four, five, and even six heats are attainable with ease and safety. After annealing, the crucibles are heated red hot and then placed

in the melting furnace on fireclay stands, round which and the pots coke is piled, two pots being usually fixed in the same “melting hole,” but sometimes more. When the pots are white hot the steel in small lumps is introduced by lifting up the cover and pouring the pieces down a long iron funnel; the covers being replaced and the fire made up, after some two or three hours the steel is fluid; but if cast immediately it is found that a much larger quantity of gas separates during solidification, rendering the steel porous, than is evolved if the metal is *dead-melted*, i.e., allowed to remain melted for an extra half hour or more, presumably from the reaction of the iron oxide interspersed throughout the steel upon the carbon evolving carbon oxide during the earlier period, this evolution subsequently ceasing, owing partly to the reduction of the oxide, and partly to its floating up to the top of the fused mass as scoria. According to Bessemer the chief part of the “dead melting” effect of the extra time allowed in fusing steel for the molten metal to stand in the furnace after fusion is brought

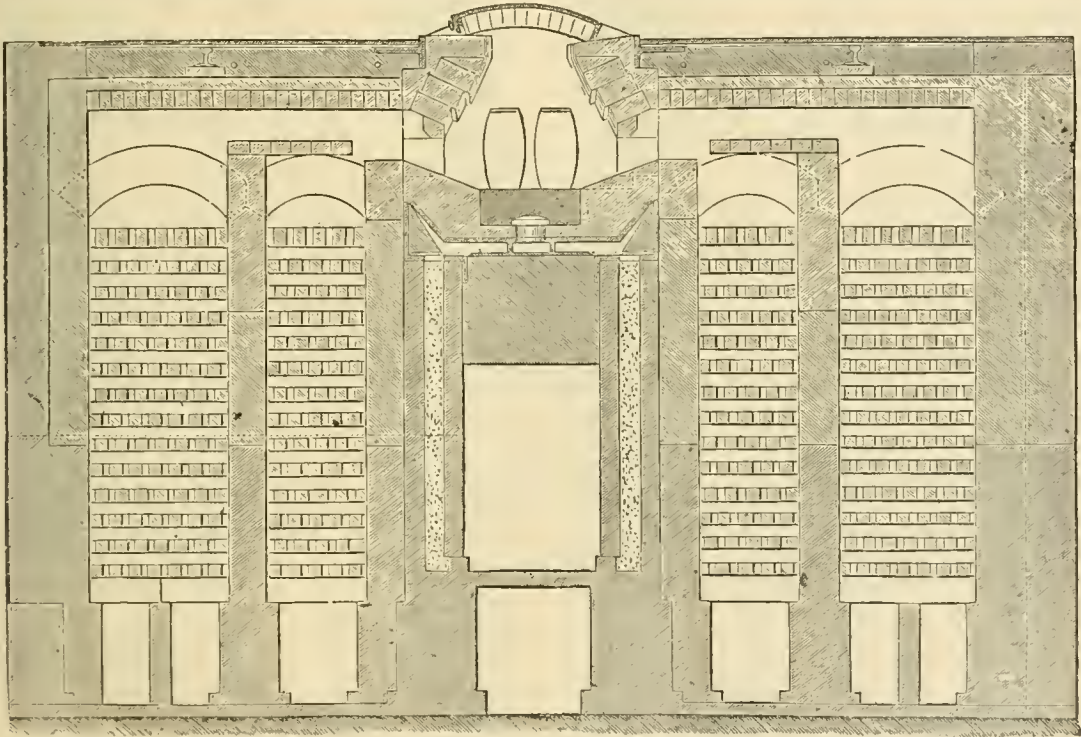

Fig. 59.

about is due to the reduction of a little silicon from the crucible materials, &c., the presence of that element greatly diminishing the tendency to evolution of gas during solidification (see § 44). When the pots are withdrawn and the casting made (frequently from the contents of many pots combined together), they are replaced in the melting holes before they cool, and used over again, a somewhat smaller quantity of metal being introduced for the second melting (and less still for the third), in order to prevent the surface of the fused scoria being at the same level as before, the pots being chiefly attacked at that place. About 3.5 parts of coke are required for 1 of mild steel melted, and somewhat less for harder steels, which melt more easily.

The Siemens regenerative furnace (§ 10), fed with gas from a producer, can be very advantageously employed instead of the older coal or coke-fired furnaces. In such a steel melting furnace (fig. 59) the fusion chamber generally contains some two dozen pots, and is

constructed in the form of a trench with overhanging sides, which are arched both horizontally and vertically to keep them from sinking in whilst in use. The floor is covered with finely ground hard coke, which burns away but slowly and does not flux or indurate, thus giving a firm foundation for the pots, which are set in a double row along the centre of the chamber; the upper roof of the chamber consists of firebrick tiles or frames filled with firebrick capable of being slid off separately by means of levers or handles attached to each, so as to permit of the introduction and withdrawal of the pots. The inventors state that the lining of a furnace of this description will last from fifteen to twenty weeks without repair, working day and night, whilst four to five weeks is the ordinary life of a coke-fired furnace; that the pots will stand four, five, and sometimes even ten successive meltings instead of two or three; and that, whilst 3 to 4 tons of hard coke are requisite in coke-fired furnaces per ton of steel melted, 15 to 20 cwt. of such inferior slack burnt in a gas producer will furnish enough fuel to melt a ton of steel on the regenerative principle (*Chem. Soc. Journal*, 1868, p. 276). The precise amount of fuel used in actual practice is somewhat variable, but consumptions as low as 0.64 parts of coal per unit of steel melted (nearly 20 tons being melted in all during one week) have been recorded. In other works the consumptions were 1.1 to



1.45 parts of coal per 1 part of steel melted (the heat requisite for drying the pots being included). A good deal of the saving in fuel is dependent on the character of the pots employed, the best pots, which will stand several successive meltings, raising considerable economy, in that the fuel requisite to heat up new pots (starting comparatively cold) is saved, the fusion being effected in much less time, averaging from two-thirds to three-fourths of that requisite for new pots. Various modifications of the Siemens regenerative steel melting furnace have been introduced by other inventors; thus the Swindell furnace has been used to a considerable extent in America.

34. *Case Hardening.*—This operation is essentially the reverse of that by which cast iron is converted into malleable iron (§ 22). In the latter the carbon is gradually removed, the outer portion being first affected; in the former carbon is added to the exterior layer of a malleable iron article so as to give it great hardness, strength, and power of resisting wear and tear by superficial conversion into steel. As applied to larger articles in which the steely coating is required to be of more than just perceptible thickness (0.1 to 0.3 inch), the operation is essentially that of cementation, the iron articles being packed in an iron chest or box in charcoal reduced to very coarse powder (burnt or charred leather, hoofs, bones, &c., answering best), and then heated to a red heat for a sufficient length of time (some four to six hours for a coating of steel of 0.1 inch or so in thickness) either judged by past experience or by withdrawing trial pieces from time to time, and breaking them so as to ascertain to what depth the acieration has proceeded. When this is effected the chest is withdrawn from the oven or furnace and the articles chilled by taking them out whilst still hot and quenching in water or oil, &c., so as to harden the exterior coating. Since the steel exterior is thus rendered too hard for working with ordinary tools, the articles to be treated must be as far as possible finished before case hardening, so as only to require cleaning and polishing subsequently.

Sometimes a portion only of an iron object is required to be case hardened. In this case a coating of loam or clay, &c., is applied to that part of the object not required to be hardened, and gradually dried on so as to form a jacket; this prevents the ready access of carbon and carbon oxide to the covered-up part, and hence hinders or entirely prevents acieration thereat; instead of a clay coating moulded on, a roughly made loose iron jacket may be made from iron tube or sheet iron, &c., and the space between the two surfaces filled in with clay well rammed in. In certain cases the article is case hardened as a whole, those portions required to be of malleable iron being made too large; after acieration the whole is annealed, and the softened steely coating filed or lathed off from these portions, and the whole then heated and hardened.

When only a thin coating of steel is required, it is unnecessary to acierate by packing in charcoal; the iron to be hardened is heated to redness and then sprinkled with powdered ferrocyanide of potassium either by itself or mixed with other saline substances; the salt fuses and carbonizes the surface of the metal to such an extent that after hardening the exterior film is usually hard enough to resist a file. Sometimes goods are cast in the first instance (for cheapness of manufacture) and then heated in hematite, &c., so as to convert them into malleable iron to a greater or lesser extent, the outer film being finally case hardened by ferrocyanide; so that occasionally cast iron as an inner core, malleable iron as an exterior coating, and steel as an outermost film are met with in the same article. For axles, shafts, and other portions of machinery apt to encounter sudden strains which would snap a solid hard steel mass, but where certain portions (bearings, &c.) are required to be as hard as possible to diminish wear and friction, the local case hardening of the parts required to be hard is frequently practised; and in this way certain of the advantages of both hard steel and wrought iron are combined.

For case hardening rails Dodd's process has given good results; as practised some years ago by the North-Eastern Railway Company, charcoal, soda ash, and limestone crushed small were mixed together in the proportion of 1 cwt. of the first to 1 stone of each of the others, and charged into the case hardening furnace between successive tiers of rails. The rails remained in the furnace sixty hours; when taken out they were covered with sand till cold. The cost of the process amounts to about 12s. 6d. per ton (Lowthian Bell); but when the rails are of ordinary puddled malleable iron, a certain degree of brittleness is communicated. With rails from Danks's machine puddled iron the carbonization was found to extend inwards for

nearly a quarter of an inch, the percentages of carbon in each successive  $\frac{1}{8}$  inch from the surface being found to be as follows:—

Outer $\frac{1}{8}$ inch	...0.740 to 1.013	Mean of seven specimens	= 0.862
Succeeding do.	...0.231 „ 0.696	„ „ „	= 0.498
Third do.	...0.030 „ 0.468	„ „ „	= 0.253

35. *Crucible Steel.*—The term "crucible steel," strictly applicable to the cast steel prepared by fusing cementation steel in crucibles, is often applied to denote various other somewhat different substances (also fused in crucibles), cementation cast steel being often designated "Huntsman's steel," from the name of its inventor. About the beginning of the present century Mushet patented the production of a crucible steel by the direct carbonization of malleable iron by the fusion together in crucibles of bar or scrap iron and "a proper percentage of carbonaceous matter"; and also the production of a similar product direct from the ore by substituting the ore for the malleable iron and increasing the amount of reducing matter. This latter process (which is substantially the method of assaying iron ores in crucibles by the dry method on a somewhat larger scale, and with less reducing matter) had been previously patented in 1791 by Samuel Lucas, whilst substantially the same process was again patented in 1836 by Hawkins. But little steel, however, was made by this process until 1839, when Heath patented the use of what he termed "carburet of manganese" as an ingredient in making crucible steel, this substance being prepared by heating together manganese dioxide and carbonaceous matter. It being speedily found that the same result was produced whether this heating together of the manganese, dioxide, and carbonaceous matter was previously carried out, or whether these materials were separately added to the contents of the crucible and the whole melted together, the validity of the patent was vigorously contested, the utility of the manganese thus introduced into the resulting mass as a means of partially correcting the deleterious effects of sulphur and phosphorus being speedily apparent, and the possibility of the production of useful qualities of steel from even inferior iron being rapidly recognized as a valuable improvement. This Mushet-Heath process of fluxing together in crucibles malleable iron and etel scrap, powdered charcoal, and manganese oxide or spiegeleisen is still used to some extent; the cast steel thus produced is apt to be somewhat vesicular and porous; to overcome this when bars are required the ingots are reheated and hammered or rolled, either with or without cutting and piling; the character of the cast steel is largely variable with the proportions of malleable iron and iron already carbonized that are used. Siemens or open hearth steels have of late years largely superseded this class of products.

When blister steel is judged to be somewhat deficient in carbon, and is converted into cast steel by fusion, the amount of carbon present in the cast steel can often be increased by adding carbonaceous matter to the fragments of steel with which the crucibles are filled,—the additional carbon being taken up precisely as in Mushet's process of date 1800. The same effect is produced to a slight extent by employing a considerable quantity of blacklead in the crucible composition, the graphite being then directly dissolved during the fusion. The Chenot process of steel making (by fusion in crucibles of spongy iron and carbonaceous matter) has been already adverted to (§ 30); Parry took out a patent in 1861 for converting puddled iron into steel by fusing it with coke and fluxes in a kind of cupola furnace so as to recarbonize the metal; by modifying the blast and proportion of fuel employed it is possible to produce either steel or cast iron containing 2 per cent. and upwards of carbon (§ 23). Apparently the cost of the fuel required for this process and other circumstances have prevented it from materially competing with the Bessemer and Siemens steel-making processes.

*Wootz* or Indian steel was described in 1807 by Buchanan as being prepared from the steely iron obtained by heating in a rough conical furnace of clay some 2 feet wide at the base and 1 at the top the pure magnetites and other ores of India and charcoal, the ore and fuel being supplied at the top, and the combustion urged by a rude bellows made of a goat's skin stripped from the carcass without

opening up the belly, the neck being furnished with a bamboo nozzle terminating in a clay tube, forming a rough tuyere. After the fire has been urged for some hours the contents of the furnace are removed by partially breaking down the front, in the form of a rough porous ball or bloom of partially melted metal, which is then cut into pieces and charged into a crucible (made of clay mixed with a small quantity of charred rice husks) together with the wood of *Cassia auriculata*, chopped into little fragments: each crucible holds about a pound of metal, and is covered over with a few green leaves, preferably of *Asclepias gigantea* or *Convolvulus laurifolius*, a clay cover being made by ramming in soft clay and drying gently. A number of these crucibles (some twenty or twenty-four) are then piled up in a clay furnace furnished with a bellows something like the original smelting furnace, the interstices being filled with charcoal. After some two hours' heating the steel is fused; the crucibles are then removed and allowed to cool, and the melted cakes extracted by breaking away the clay. If the operation has been successful, the cakes are smooth-surfaced, w. b. radiating striae; such cakes when remelted in larger quantities furnish an extremely fine quality of steel; when the conversion of the iron into highly carbonized steel is incomplete, the cakes are imperfectly melted down, and consist more or less largely of fritted lumps of metal not carbonized sufficiently to fuse; such cakes yield only an inferior steel when remelted. In order to forge the steel the natives heat the cakes in a charcoal bellows-furnace for some hours to a temperature short of fusion, and then hammer them out by hand into bars; these are welded together by forging to wedge-heads, tying together with wire, sprinkling with borax, and quickly heating and hammering till united; the long preliminary heating partially decarbonizes the steel, so as to make the final product less like a steely cast iron. When properly prepared, the temper which this steel will take is magnificent; it is said that sabres of such steel with an edge sharp enough to cut gossamer like a razor can be dashed with the full strength of a man's arm against a stone wall, or used to cut in two a bar of wrought iron, without having the cutting edge injured in the least degree if the swordsman be only sufficiently expert.

According to analyses made by Faraday, wootz contains a small quantity of aluminium; this probably existed as cinder disseminated through the mass, as subsequent analysts have entirely failed to detect aluminium in wootz free from slag; thus Henry (*Phil Mag.*, 1852) and Rammelsberg (*Berichte Deut. Chem. Ges.*, 1870, p. 461) found the following mean numbers, the sulphur being probably overestimated in Henry's analysis:—

	Henry.	Rammelsberg.
So-called combined carbon .....	1.356	0.867
Graphite .....	0.312	0.136
Silicon .....	0.042	0.009
Phosphorus .....	...	0.052
Sulphur .....	0.178	0.052
Arsenic .....	0.017	...
Iron (by difference) .....	98.096	98.986
	100.000	100.000

VIII. METHODS OF STEEL PRODUCTION ESSENTIALLY CONSISTING OF COMBINATIONS OF THE PRECEDING PROCESSES, MORE OR LESS PURE MALLEABLE IRON BEING PRODUCED IN ONE WAY, AND CARBONIZED IRON IN ANOTHER, AND THE TWO BEING BLENDED TO FORM STEEL.

36. *The Bessemer-Mushet Process and its Precursors.*—It has been known since the beginning of the 18th century at least that steel could be prepared by fusing together in crucibles cast and wrought iron; thus the operation was performed in 1722 by Réaumur employing the heat of an ordinary forge; whilst to the production of wootz it must have been observed centuries ago that by continued heating the badly prepared cakes (consisting partly of fused steel and partially of unfused iron) frequently resulting

from the first crucible operation could be fused into one mass of somewhat less hard steel than that produced at first in the more successful operations. The possibility of producing steel by fusing together a malleable and a carbonized iron is evidently a simple deduction from the processes whereby a steel is produced by the direct addition of carbon to malleable iron, e.g., those of Mushet and of Heath (§ 35). Accordingly a few years after the latter patented the use of "carhuret" of manganese, he proposed

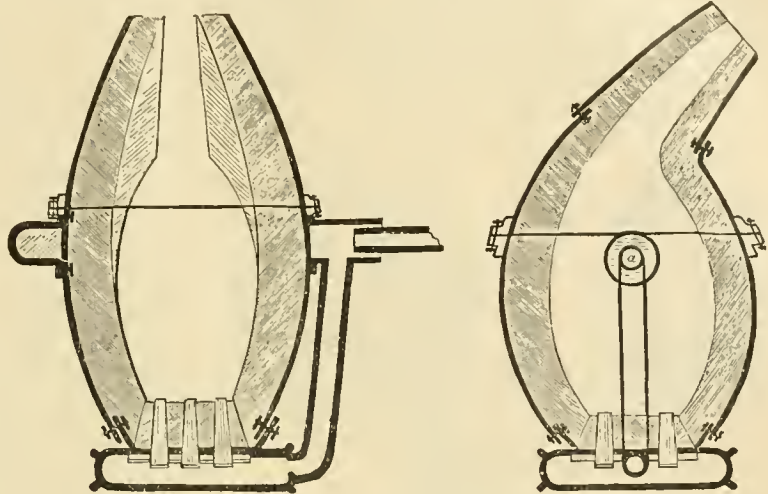

Fig. 60.

(1845) a method for making steel on a larger scale than crucible operations would permit, viz., by fusing in a cupola pig iron, running this into the bed of a steel-making furnace into the upper part of which the malleable iron was introduced in bars so as to be heated up by the waste heat and gradually pushed forward so as to dissolve, as it were, in the molten pig with formation of steel. This method is described by Siemens as being one which would doubtless have led to complete success had the regenerative principle been known to Heath, so as to enable him to obtain the requisite intensity of heat and absence of cutting draught essential to the proper combination together by fusion of the wrought and carbonized iron without oxidation; it is substantially one of the forms of steel making by means of the open hearth or regenerative processes now in use, and known collectively as Siemens or Siemens-Martin processes (see § 39). Other patents, amounting substantially to the same combination of wrought and cast iron by fusion so as to form steel, have been subsequently taken out by Price and Nicholson (1855), Gentle Brown, and Attwood (1862); a particular combination of this class patented by Mushet in 1855 (consisting of the addition to molten Bessemer blown decarbonized iron of fused spiegel-eisen) has proved of the highest practical value (§ 27), notwithstanding that the non-removal of phosphorus and sulphur to any marked extent in the ordinary blowing process render it applicable to certain kinds of pig iron only; the recently invented "basic" process, however, bids fair to overcome this difficulty (see § 37).

The earliest form of converter patented by Bessemer, October 17, 1855, consisted of a rectangular furnace with firebars at the side instead of at the bottom, so that a number of crucibles could be heated therein, each furnished with a tapping hole at the bottom, and a pipe dipping to the bottom of the fused metal inside, through which air was to be blown, or a mixture of air and steam, the former causing the temperature to rise, the steam having a cooling effect. Two months later another patent was taken out, the use of a spherical or egg-shaped vessel of iron lined with firebrick and supported by axes being the main novelty. In May 1856 a fixed vertical cylindrical vessel, with blast pipes at the base and a tapping



hole, was patented; not till some time later, however (after the introduction of Mushet's improvement of adding spiegeleisen), was the present form of converter arrived at, consisting of a pear-shaped or bottle-shaped vessel with tuyeres at the base, and supported upon axes, one of which being hollow serves as the tube by means of which the blast is communicated to the tuyeres, whilst the vessel can be rotated into any desired position round the axis (fig. 60); the use of hydraulic power to work the converter into position, and to manipulate the "ladle" into which the finished metal is run so as to be poured from it into moulds, soon followed. Subsequently various improvements in details of arrangement and construction of the plant have been introduced, notably by Holley in certain American works in the first instance; amongst these may more particularly be noticed the use of somewhat longer converters (fig. 61), with movable bottoms, so that, as the tuyeres wear out (which occurs much more rapidly than does the destruction of the lining), new previously constructed bottoms can be introduced without entailing large loss

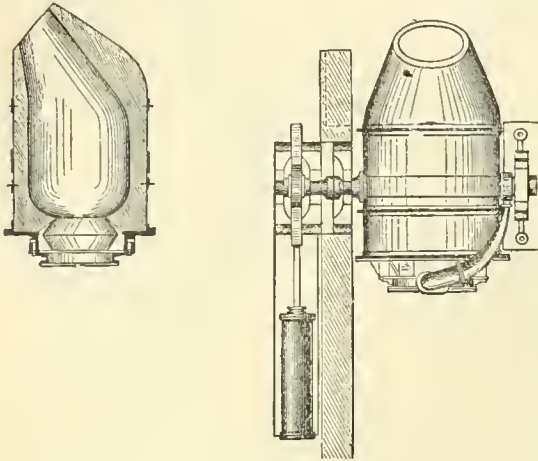

Fig. 61.

of time, whilst the greater length diminishes less by splashing and forcible ejection during the boil; the effect of these improvements is to increase the possible output from a given plant by at least 50 per cent. At first it was usual to melt the pig iron in a separate reverberatory furnace and then to run it into the converter; a cupola furnace (saving much fuel) was then substituted, a little lime being added to diminish its tendency to sulphuration; in this way scrap of all kinds can be utilized, being melted down with fresh pig in a cupola furnace much more readily than in a reverberatory, and being less decarbonized and desilicized in so doing, which is somewhat important (§ 27). Where the blast furnaces are not too far from the converters, the molten pig is often run direct from the furnace into the converter without solidifying into pig and remelting, an intermediate ladle running on a railway being employed instead of a long gutter, which would cool the metal too much and be otherwise impracticable. In some few Swedish works the old immovable cylindrical converter is still employed, the metal being tapped out into a ladle from which it is run into the ingot moulds, but in most works, even in Sweden, movable converters are now in use. The spiegeleisen usually added subsequently is melted in another smaller cupola; in some few works however, *e.g.*, in Styria, spiegel is not used, but when the charge is blown some more of the original pig is added; in others Bessemer's original process is adhered to (§ 27); the use of this method, however, is comparatively limited, the combination process being usually adopted in preference. When ferro-manganese is used instead of spiegeleisen, it is usually not melted, but simply heated in a suitable vessel by the waste flame of the converter, and emptied into the casting ladle together with the blown metal so as to intermix the two, the ferro-manganese fusing as soon as it comes in contact with the blown metal.

**Converters.**—The improved form of converter in use at the present day is indicated by fig. 61. It consists of a vessel in shape resembling a claret bottle with the neck somewhat shortened and slightly bent over sideways; this is made of stout boilerplate, lined internally with "ganister," a kind of sandstone possessed of peculiar physical properties, more especially of the power of binding together to a compact non-crumbling excessively infusible mass when ground to powder, moistened, and finally exposed to a high temperature. The base of the bottle is

removable, being kept in position by bolts and nuts; this being removed, a core is fitted concentrically within the shell, and the moistened ganister rammed lightly in; sometimes the shell is also made of two parts thus treated separately and afterwards bolted together. The bottom is double, constituting an air chamber or "blast box," the top portion of which is a perforated cast iron plate, into which are fitted tuyeres consisting of slightly conical elongated bricks or plugs perforated longitudinally with holes (between 0.15 and 0.3 inch diameter) and fixed in at the thicker end; these are composed of a mixture of fireclay and ganister, the space between them being filled up with ganister, so that the inner bottom is substantially the same as the lining sides of the converter, only perforated by a number of holes. The total number of orifices through which the blast thus comes is considerable, in order to spread it into numerous streams, the actual number varying with the size of the converter; for a 5-ton converter a dozen or more tuyere bricks, each perforated with about as many holes, are usually employed. The lower plate of the air chamber is removable for the purpose of examining the tuyeres from time to time without removing the entire bottom.

The different portions of the vessel being put together, and the joints well grouted with ganister slip, the whole is gently dried by lighting a small coke fire inside, and by and by increasing this, the blast being turned on gently until the whole vessel is thoroughly dry and hot, when it is ready to receive a charge of molten pig. The blast is communicated to the blast-box by a curved tube reaching thereto from the hollow trunnion box, inside which one of the trunnions of the converter lies; the other trunnion has a cogged wheel or pinion attached, by means of which the vessel can be rotated, a toothed rack gearing into the pinion and being worked directly by a hydraulic press or ram; the rack and press were formerly arranged horizontally, but now are usually placed vertically or slantwise to save space. By means of an automatic valve the blast is shut off when the converter is in an inclined position, so that the level of the mouth is not lower than the tuyere hole then lowest; in this position the molten metal is run in, the elevation of the tuyere holes preventing it from running into them; whilst erecting the converter by means of the rack and pinion before the tuyeres sink below the molten mass, the blast is turned on at a pressure of some 1.5 atmospheres or more (21 lb per square inch and upwards); the pressure due to the column of molten metal being less than this, the air is forced through it without it being possible for the fused matter to run down into the blast box. A large hood over the mouth of the converter and connected with a chimney or flue prevents the flame and ejected matter from being scattered about and injuring the workmen.

The ganister preferred for lining is a peculiar silicious deposit found under a thin coal-seam near Sheffield, of almost conchoidal fracture, therein differing from ordinary sandstones, and containing a few tenths per cent., or sometimes a little more, of lime and about the same amount of alumina, with small quantities of iron oxide and alkalis, the rest being silica; analogous substances, however, are found in various other localities, *e.g.*, in the Yorkshire, Northumberland, South Wales, and Shropshire Coal Measures. A well-prepared lining carefully repaired every few days will last several months, and even upwards of a year; the bottoms, however, wear away much more rapidly, the tuyeres either becoming melted or dissolved away by the oxidation of the iron in their vicinity, the oxide produced exerting a marked solvent action on the fireclay and ganister bricks; hence the advantage of Holley's removable bottoms. A damaged bottom can be removed and a new one put in its place, the joint being made up by ramming in ganister into the crevice whilst screwing up the bolts, without stopping the action of the converter for any lengthened period; whilst with the older vessels it was requisite to cool down somewhat, knock out the damaged tuyere bricks, replace them by others, and ram in ganister between them from the inside, and finally to heat up again by an internal fire before use,—the whole process causing much delay and waste of fuel, especially as the renewal of some at least of the tuyere bricks is requisite every few blows. In some American works, *e.g.*, Bethlehem, instead of a rammed ganister lining, one composed of blocks of a peculiar sandstone is employed, set in ganister as mortar for the joints.

**Subsidiary Appliances.**—The precise mode of arrangement of Bessemer plant varies in different works, but usually two converters are arranged to be worked together, one casting ladle being used for the pair, worked by a crane. In most of the European works the two converters are on opposite sides of the casting ladle, so that a

large portion of the circle covered by it cannot be used for running ingots into moulds, being occupied by the converters; in most American works the two converters are placed side by side, so as to leave a larger space for the casting bed when the metal is not used direct from the blast furnace. A range of cupolas is fitted up at a convenient distance, some larger for melting the pig, some smaller for the spiegelisen; the molten metal is either run out from these direct into one or other of the converters through a shoot or gutter of iron lined with fireclay and sand, or is tapped into an intermediate collecting ladle, and when the requisite quantity is collected run rapidly into the converter either by "tipping" the ladle over so that the metal runs out together with some little amount of slag floating on its surface, or by means of a tapping hole at the bottom. This latter arrangement allows the charging of the converter to be more quickly effected; when the iron is tapped directly from the blast furnace into the converter by means of an intermediate ladle, the cupolas are of course unnecessary, save those for melting the spiegelisen. The blast is generated by an ordinary blowing engine, but at a considerably greater pressure than that used for blast furnaces, 20, 25, and even 30 lb per square inch pressure being employed. The casting ladle into which the contents of the converters are emptied by tilting them up sufficiently when the operation is finished is a large iron bucket lined with clay with a hole at the bottom filled up with a perforated firebrick, into which fits a stopper consisting of a stout iron rod covered with a thick fireclay tube to protect the rod from the fused steel; when the ladle is full of molten metal, and the hole is closed by the stopper, the ladle is swung round by means of a crane over the ingot moulds (of cast iron); the stopper is then lifted, when the fused steel runs out, the scoria floating on the top of the metal being thus retained and pure steel only poured. Sounder ingots are obtained by running the metal into a cavity communicating by firebrick tubes with the bottoms of the moulds, so as to fill them from below, than by filling them from above directly. Detailed descriptions of the plant employed in various first-class American Bessemer works are given by Holley and Lenox Smith in a series of articles in *Engineering*, 1877 and following years.

The mode of carrying out the operation is briefly as follows:—The charge of pig iron being run into the converter, this is swung back into the vertical position, the blast being automatically turned on in so doing; when the blowing is at an end, the converter is turned into a nearly horizontal position, the blast being thereby shut off; a weighed quantity of fused spiegelisen is then run in, and the total contents of the converter forthwith poured into the casting ladle; formerly the converter was erected for a few seconds and the blast blown through to mix the spiegelisen and blown metal, but that is now found to be unnecessary. The ingots are finally reheated and passed through the rolling mills after forging so as to reduce them to rails, bars, plates, &c., as required, the machinery for this purpose being identical in character with that employed for malleable iron (§ 25).

The following analyses illustrate the general composition of "Bessemer steel" as made in different European countries, the first two specimens being prepared by Bessemer's original process (without addition of spiegelisen, § 27), and the others by the Bessemer-Mushet combination process (from report of E. Brusewitz to the Swedish iron office, *Jern-Kontorcts Annaler*, 1871, 199).

Locality .....	Westansfors (Sweden).		Barrow-in-Furness.	Germany		Neu-berg.
	Without addition of Spiegelisen.		For Coarse Wire.	Rails from Pig pool in Manganese.	Rails from Working-ton Heam-rite and German Manganese Pigs.	Plates: Pig used direct from Blast Furnace.
	Very soft.	Hard.				
Carbon .....	0.085	0.050	0.200	0.150	0.046	0.250
Silicon .....	0.008	0.047	0.179	0.091	0.034	0.016
Manganese .....	Trace	0.403	0.214	0.264	0.078	0.136
Phosphorus .....	0.025	0.032	0.026	0.122	0.035	
Sulphur .....	Trace	Trace	0.010	0.025	0.045	0.010
Iron by difference .....	99.882	99.508	98.351	99.338	98.544	99.588
	100.000	100.000	100.000	100.000	100.000	100.000

Analyses illustrating the composition of the slag are given in § 37.

37. *The Basic Process.*—On attentively examining the history of the puddling process, especially the improvement effected by Rogers in substituting bottoms of iron coated with fettling of iron oxide for the sand bottoms originally used by Cort, and also the various experiments that have been made during the last dozen years or so both on puddling by machinery and refining and purifying iron, the general conclusion deducible seems to

be that when phosphorized metal is in presence of iron oxide in a fused state, or of a melted mixture of iron oxide and ferrous silicate containing an amount of the latter not above a certain limit, the tendency of the phosphorus is to become oxidized and converted into phosphate, which separates in the cinder, leaving a purer iron; whilst on the other hand if the cinder is mainly silicate, especially of the metasilicate or "acid" type ( $R_2O, SiO_2$ ), the tendency is rather the other way, part of the metallic iron becoming oxidized whilst the phosphate is reduced, thus communicating phosphorus to the remaining iron.<sup>1</sup> Accordingly, in the modern ordinary puddling process, especially when machine puddling and regular mechanical agitation are substituted for hand labour, and when plenty of fettling of ferric oxide (not largely silicious) is employed, and in Bell's and Krupp's purification processes, phosphorus is largely removed from the pig; whilst on the other hand in the older method of puddling on sand bottoms and in the ordinary Bessemer blowing process the first action of the oxygen of the blast is concentrated rather on the silicon than on the iron (at least so far as the ultimate chemical change is concerned), and in consequence a highly silicious cinder results, so that removal of phosphorus by oxidation becomes impracticable; this result, moreover, is intensified by the nature of the lining material (ganister) used for the converters; similarly, in the Heaton process phosphorus is sometimes removed to a considerable extent and sometimes not, according as the soda produced by the decomposition of the nitrate and the iron oxide formed modify the character of the slag produced by the oxidation of the silicon and formation of silicates, rendering it of an "acid" or "basic" silicious character. Again, according to Riley, when the whole of the iron is reduced in the blast furnace, so that the cinder contains none, or practically none, the pig contains all the phosphorus present; but if the cinder contains unreduced iron to any extent, it also retains a proportionate amount of phosphorus, being then much more basic. The temperature also seems somewhat to influence the reaction of iron oxide on phosphorus and of iron on phosphate; the higher the temperature the more pronounced apparently is the tendency of the metal to retain phosphorus, *i.e.*, the less is the tendency of the phosphorus to oxidize and separate from the metal. Guided by these considerations, Snelus took out a patent in 1872<sup>2</sup> for the use of lime or limestone

<sup>1</sup> An instructive experiment on this point has been made by Pourcel. A quantity of metal (3 tons) containing 2.5 per cent. of carbon and 0.5 of phosphorus was melted in a Siemens-Martin hearth, the scoria removed, and the atmosphere made highly oxidizing (hot air alone passing); in fifteen minutes jets of carbon oxide were formed, and some of the silicon and iron was oxidized, forming a cinder containing no phosphorus. The bath was then heated up again and the cinder removed; and after some silico-manganese (10 per cent. silicon, 20 per cent. manganese) had been added, the oxidation by air alone was proceeded with; at first no carbon oxide was liberated (indicating the preferential oxidation of silicon), but after fifteen minutes more the jets reappeared; the cinder now was found to contain phosphates, the percentage of phosphorus in the metal having become reduced to 0.35, indicating that the iron and manganese oxides formed, whilst partly reacting on carbon and chiefly on silicon, nevertheless to some extent attacked the phosphorus. The atmosphere was now made much less powerfully oxidizing by turning on the gas supply as usual; in fifteen minutes the phosphorus had disappeared from the cinder, and was wholly taken up again by the iron, which now contained 0.50 per cent. as at first,—showing that prolonged contact with the silicious cinder enabled metallic iron (containing more or less carbon) to reduce the phosphate of this cinder, thus inverting the operation effected during the rapid oxidation of iron set up in the first part of the experiment.

<sup>2</sup> The idea of employing calcareous and other basic linings to furnaces used for the purification of iron by methods other than the pneumatic process of Bessemer is of considerably older date than 1872; thus such substances were used years ago by Siemens and Chatelier in the earliest experiments on the open-hearth process (§ 39), bauxite being extensively employed then, and also in Siemens's subsequent direct precipitation process. The use of lime in puddling has often been tried as an addition to the fettling, whilst in the Siemens ore process limestone is usually added as a flux.



as a lining material for the converter, and found that when a "basic" lining of this description was substituted for ganister a removal of phosphorus to a greater or lesser extent was actually brought about in the converter just as it is in the puddling furnace; for some few years, however, this method was not applied on a commercial scale, but subsequently the subject was again examined by Thomas and Gilchrist, who finally succeeded in reducing the principles of Snelus's patent to successful practical operation, finding that by the use of a "basic" lining to the converter, and especially the addition of a small amount of lime, or lime mixed with "blue billy" or some other form of iron oxide such as mill scale, to the charge together with the continuance of the blow for some short period after the decarbonization is complete, the elimination of phosphorus (even from highly phosphorized pig, containing 1.5 to 2.0 per cent. of phosphorus) could be very largely effected, some 80 to 90 per cent. at least of the total phosphorus present becoming oxidized and converted into phosphates, this action chiefly taking place during the "after blow"; provided that the cinder is sufficiently basic, the iron does not oxidize during this after blow as it does in the ordinary "acid lined" converter process. Owing to the success of these operations, the "basic" process has been more frequently spoken of as the "Thomas-Gilchrist process" than as being what it substantially is, the principle of Snelus's earlier patent in a somewhat but not very largely modified form. Warned probably by the disasters of previous inventors, the rival competitors for the honour (and profit) of the practical production of ingot metal of fair quality from phosphorized pig have coalesced and united their forces, instead of opposing one another in costly litigation.

Processes based upon the general principle of making the cinder of the Bessemer converter more or less "basic," but considerably different in details from the basic lining method of Snelus, Thomas, and Gilchrist, have been proposed at one time or another by various inventors; thus, in the earlier patents of Bessemer himself, the admixture of steam with air in the blowing operation was included, whilst steam had been previously employed as an adjunct in the refinery, the action being the formation of iron oxide (with evolution of hydrogen). Somewhat analogous uses of steam have been subsequently proposed by others, in some cases the phosphorus being alleged to be evolved as phosphoretted hydrogen (?), e.g., in Bull's process, in which the ordinary air blowing of a Bessemer converter or the effect of an oxidizing blast in a Siemens hearth, &c., on cast iron is first used to remove silicon and carbon, and then a jet of steam used to remove phosphorus. The direct incorporation of oxide of iron (blue billy, &c.) alone with the material (by blowing into the converter along with the blast) has also been proposed by Pettitt (§ 24), the object in all cases being to assist the formation of phosphate, and thereby remove phosphorus from the iron by making the cinder highly basic.

During the oxidation of phosphorus a large amount of heat is evolved, so that the temperature rises during the after blow just as it does during the oxidation of silicon. According to various experimenters the heat of combustion of phosphorus is a little short of 6000, so that, as that of silicon is near to 8000, 4 parts of phosphorus are thermally about equivalent to 3 of silicon. Hence if a pig containing 2 per cent. of silicon will furnish sufficient heat to keep the blown metal and slag fluid, the same result will be attained by means of a pig containing about 0.5 per cent. of silicon and 2.0 per cent. of phosphorus, i.e., if the radiation loss be the same, and also the diminution in heat evolution due to separating the non-metal from the iron,<sup>1</sup> as well as the fusibility of the slag. In actual practice the "basic" method is found to take a little longer time than the ordinary "acid" blow, so that the radiation loss is a

<sup>1</sup> The experiments of Troost and Hautefeuille show that this is not the case, the heat evolution during the union of silicon and iron being much less than that taking place when phosphorus and iron combine together; so that considerably more than four parts of phosphorus would be requisite to produce the same amount of heat as three of silicon if both non-metals are severally combined with iron.

little greater; the calcareous cinder too is somewhat less fusible than the ferrous silicate cinder of the ordinary ganister-lined converter; so that a practical inconvenience is apt to be occasioned owing to the frothy mass of imperfectly fused cinder formed foaming up to the mouth of the converter and there solidifying, whilst the greater extent of the foaming causes more material to be ejected than is usual with the ordinary converters. To remedy this, it has been proposed to add the basic matter in a highly heated or even molten state, and to make the air used for blowing traverse a chamber filled with coke on to which petroleum is allowed to drop, so that combustible vapours are blown into the converter along with the air, thus raising the temperature considerably, and preventing the blocking of the converter-mouth by solidification of cinder, and the production of metal too little heated to remain fluid during the pouring of the ingots, and consequently solidifying in the ladle forming a "skull." Wilks finds that the action of this arrangement is very satisfactory and effective in preventing "cold blows" from occurring. The same result is also producible by means of coal dust or other freely divided combustible matter blown in along with the blast.

With silicious pig iron the lining is apt to be attacked by the silica formed during the first part of the blowing operations; this is partly but not wholly avoided by the addition of heated lime to the charge. Harmet has proposed, and at Witkowitz attempts have been made, to blow phosphorized and silicuretted pig successively in two converters, one acid-lined for removing silicon and carbon, and the other basic-lined to get rid of the phosphorus, the blown metal being transferred from the one to the other; much cooling of the metal was thus produced, and the operation was prolonged some fifteen minutes, so that the method was speedily abandoned.

According to Tunner, in order to produce 100 parts of pure ingots of blown metal 122.5 parts of pig are requisite with "basic" converters, and only 118.7 with the ordinary "acid" ones (waste in remelting being included in each case; when the metal is used direct from the blast furnace, only 112 parts are required with acid converters); hence an extra loss of nearly 4 per cent. of metal is experienced in the basic process. The following analyses, by Müller, of specimens taken during a prolonged investigation at Herde illustrate the non-removal of phosphorus and sulphur during the earlier part of the blow, and indeed their slight increase (in percentage amount) owing to the oxidation of manganese, silicon, and carbon; and also the rapid removal of phosphorus during the after-blow:—

Time in Minutes ....	0.	4½.	9½.	11½.	13.
	Original Metal.				
Carbon .....	2.97	2.460	0.811	0.049	...
Silicon .....	0.53	0.009	nil	nil	...
Phosphorus .....	1.22	1.250	1.320	0.786	0.021
Manganese .....	0.61	0.247	...	...	0.123
Sulphur .....	0.15	0.206	0.262	0.262	0.206
Copper .....	0.111	0.111	0.111	0.111	0.119
Iron by difference ....	94.52	95.697	97.607	98.903	99.531
	100.00	100.000	100.000	100.000	100.000

The composition of the slag produced during the basic process differs greatly from that of the ordinary method; the following analyses illustrate the difference:—

Analyst .....	Ordinary Process.		Basic Process.	
	A. Tamm.	Scheerer.	Pattinson and Stead.	Pink.
Particulars .....	From Westanfors Charcoal Pig: no Spiegel-eisen used.	Crystalline Slag from Höfde, Westphalia.	Middleborough Slag.	Höfde Slags: some 15 per cent. of Lime added to Converter.
Ferrous oxide .....	15.62	20.50	12.21	7.24
Ferric " .....	...	...	1.17	1.56
Manganese oxide .....	36.83	32.74	4.76	6.16
Lime .....	0.70	1.53	40.08	59.35
Magnesia .....	traces	0.17	10.65	5.01
Alumina .....	3.94	...	2.50	traces
Silica .....	42.85	44.73	15.20	9.50
Phosphoric anhydride .....	0.015	...	12.23	9.76
Calcium sulphate .....	...	...	0.87	1.15
Sulphur .....	...	...	0.12	...
	99.955	99.76	98.92	99.45
				99.78

The phosphoric anhydride in the basic process slag appears to exist as calcium phosphate, and not as iron phosphate; for after roasting to peroxidize iron, no soluble phosphate is dissolved out on digestion with ammonium sulphide, nor is any formed by fusion with sodium chloride, whilst sulphurous acid solution readily dissolves out phosphate (Pattinson and Stead).

**Basic Lining Material.**—Some of the earliest of Bessemer's experiments (made at Dowlais) on his air-blowing process were made with a converter lined with Stombridge firebrick, and in this vessel a Bessemer metal was made which contained only minute quantities of carbon and silicon, and much less phosphorus than the batches subsequently prepared from the same phosphorized Welsh pig in other converters lined with ganister, the non-success of which substances as commercial products (owing to their brittleness due to the phosphorus present) ultimately led to the use of hematite and other phosphorus-free pig only for Bessemerizing. Without doubt the superiority of the earliest samples was due to the less silicious character of the brick lining. The lining materials used by Snelus in his experiments on the subject were lime and limestone, especially magnesian limestone; those first employed by Thomas and Gilchrist were crushed limestone and sodium silicate solution added so as to moisten the limestone, which was then rammed into the converter like ganister. Bricks made of a limestone containing some aluminous silicate and fired at a very high temperature were then employed, but were found to be subject to disintegration by moisture when kept in stock; magnesian limestone bricks containing a little silica and alumina similarly prepared answered much better. Riley has found that freshly burnt pretty pure magnesian limestone mixed with about 10 or 15 per cent. of crude petroleum can be rammed into converters or moulded by hydraulic pressure into bricks, the substance in either case becoming compact and hard upon firing, so as to present a very durable lining material. Instead of petroleum, crude shale oil, resin oil, or tar may be used to moisten the lime. The bricks thus prepared do not slake or disintegrate on keeping, or even if immersed in water, provided they have been fired at a high temperature; in this case they contract slightly, whereas if only comparatively slightly heated they do not materially diminish in volume on firing.<sup>1</sup>

38. **The Uchatius Process.**—In the process of puddling (§ 23) the oxidation of the carbon and other impurities of the pig iron is essentially effected by oxide of iron incorporated mechanically with the fluxed mass, and derived either from the oxidation of part of the iron of the pig, or from the fettling, or both. By fusing down in crucibles a mixture of small fragments of pig iron and ferric oxide of tolerable purity in suitable proportions it might therefore be expected that the percentage of carbon of the iron would be reduced so that a steel would result, a portion of the iron oxide added becoming simultaneously reduced to the metallic state; this experiment was actually made by Reaumur upwards of a century ago; the reaction forms the foundation of the Uchatius process, patented in 1855. In order to obtain a usable steel, the iron oxide employed should also contain manganese oxide; the product of the continued roasting of a manganiferous spathic ore answers well. Independently of the costliness of crucible operations, however, as compared with other modes of production, the method is open to objection on the score of the practical difficulty in exactly regulating the degree of carbonization of the resulting steel, and also in its requiring a tolerably pure pig iron in the first place, so that, like the Bessemer process proper, it is unsuited for the production of steel from many classes of iron. The method has, however, been employed on a manufacturing scale in Sweden, the non-phosphorized charcoal smelted from Swedish magnetite being employed along with some of the crushed ore; whilst a modification of the process, in which an open hearth heated by a regenerative furnace is employed instead of crucibles, has been employed of late years by Siemens (see § 39), and is usually known as the "ore process" for open hearth steel making. At Wikmanshytta in Sweden a few years ago various qualities of steel were prepared from the richest Bisberg mine ores stamped fine and intermixed with pig iron granulated by running

into a rapidly revolving wheel in a water tank. Only hard steel for miners' picks, cutting tools, razors, dies, &c., were thus prepared, containing 0.7 to 1.3 per cent. of carbon, about 50 lb being melted in each crucible at one operation; the crucibles lasted longer than in ordinary cast steel making, usually for some half dozen heats.

Rosteing effected the granulation of the iron by running the melted pig on to a rapidly revolving horizontal cast iron disk, so that the liquid was scattered around (by centrifugal action) in globules which solidified into a kind of iron shot; these being sifted into tolerably uniform sizes admitted of the production of a more nearly homogeneous metal than would otherwise have been obtained. The principles of Uchatius and Rosteing's patents, however, were long previously known and even patented; thus in 1781 J. Wood obtained a patent for reducing iron "into small grains (as oxides do act) by pouring it into water upon a wheel or roller turned briskly round," and for decarbonizing the granulated metal by fusing with various fluxes, &c., including ironinder, scales, and scoria; whilst Mushet has described, as being in use long ago at Cyfartha, a method of granulating iron by pouring on to a revolving horizontal stone in a water trough molten pig iron, stating that the granulated metal was fused with oxide of iron in the form of bloomery welds, and thereby rendered less easily fusible and capable of welding,—in short, that it was decarbonized to a greater or lesser extent.

The method of purification or refining of pig iron proposed by Bell (§ 24) is substantially the Uchatius process applied on a large scale and at a somewhat lower temperature, with mechanical agitation and interruption at a certain stage. By stopping the process when the action has only gone on sufficiently long to oxidize the majority of the silicon and phosphorus without materially affecting the carbon, a refined cast iron is produced; whilst, were somewhat more carbon removed by longer action, a kind of Uchatius steel would result.

*Ellershansen's process* consisted in running molten pig iron upon a bed of iron oxide, sprinkling ore on the surface, and running on another layer of pig iron, and so on until a mass of alternate layers of pig and oxide is formed; on heating this the pig gradually becomes decarbonized, the reaction being in fact a kind of modification of the "malleable cast iron" process described in § 22. Finally the mass is forged and rolled. The results obtained were not uniformly satisfactory, whilst the fuel consumption was found to be large; accordingly the method never became anything much more than an experimental process.

39. **The Siemens-Martin Process.**—As already stated, this process in its original form is substantially the method patented by Heath in 1845, with the addition of the use of a regenerative furnace, and of certain improvements in the working details, &c., the effect of which jointly is just to convert a practically useless process into a most valuable working method. Fig. 5 represents the kind of furnace employed. Since the date of Heath's patent the fusion of steel by means of a fan blast in an open hearth (under a layer of molten glass to protect from the oxidizing action of the flame which was the main cause of failure in Heath's original process) was experimented upon by Sudre and a commission from the French emperor (consisting of Deville, Beaulieu, and Caron) at the Montataire iron-works, with the result of showing that, whilst the operation could be readily effected and a good tool steel prepared, the practical difficulties in the way, especially the corrosion of the furnace and the great cost of the requisite fuel, rendered the process commercially of but little value. In 1863, however, Chatelier attempted to prepare cast steel by puddling a good pig iron so as to form a very mild puddled steel, and then fusing it, not in crucibles, but on the hearth of a furnace containing molten pig and fitted on the regenerative principle. To enable the hearth to resist the high temperature it was composed of a bed of bauxite, a material highly suitable, so far as infusibility and the absence of injurious ingredients are concerned, but open to the objection of not indurating properly, and consequently becoming dislodged and floating up to the surface of the fused mass; this inconvenience was subsequently remedied by mixing the bauxite with a 1 per cent. solution of calcium chloride, moulding the paste into bricks, and calcining them, whereby a highly refractory coherent bottom can be obtained. Siemens, however, prefers (*Chem. Soc. Journal*,

<sup>1</sup> For further details respecting the working of the Snelus-Thomas-Gilchrist process, see various papers in the *Journal I. and S. Inst.*, 1879 and 1880, and in *Iron*, &c.



1868, 279) to use a silicious sand of a particular degree of fusibility (such as that from Gornal near Birmingham, or Fontainebleau sand with an admixture of about 25 per cent. of common red sand); this, being introduced dry into the furnace in a layer of about an inch in thickness, is fritted by increasing the heat up to a full steel-melting temperature; another similar layer is then introduced and fritted down again, and so on until the hearth is made into a shallow basin sloping towards the tapping hole. The experiments of Chatelier not being attended with the desired success in the first instance, the subject was taken up by E. & P. Martin, who subsequently introduced certain improvements in details, such as the use of particular fluxes to cover the surface of the molten metal, the application of a *separate furnace* for heating the iron before introducing it into the melting chamber, the employment of particular brands of iron, &c.

Under the names of "Siemens process" and "Siemens-Martin process" are usually included several different modifications. In what may be called the older or original process, which was essentially the combination of pig iron and malleable iron fused together in a regenerative furnace hearth, the same kind of difficulty was met with that nearly proved fatal to Bessemer's original process, viz., that it is difficult if not impracticable to make sure of obtaining any required degree of carbonization of the resulting steel, so that the finer classes of steels cannot readily be thus made; for rails, however, the process has been largely adopted. Much the same way of overcoming the difficulty was adopted in the Siemens-Martin process as was used by Mushet, thus giving the second modification, viz., making the atmosphere slightly oxidizing, and continuing the heating until the metal is decarbonized, when the required amount of carbon is added in the form of spiegeleisen or ferro-manganese, and the steel forthwith cast. This modification is consequently substantially the refining process formerly adopted as a preliminary stage to puddling (§ 23) carried out a great deal further (so as wholly to decarbonize the metal) at a much higher temperature, and differs from the Bessemer blowing process mainly in this that the oxygen requisite to burn off the carbon and oxidize silicon, &c., is made to play *over* the surface of the fused mass instead of passing *through* it. The decarbonization is carried out in precisely the same way (so far as principle is concerned) as that by which the oxidation of lead and base metal is effected in the ordinary process of gold and silver cupellation in an oxidizing atmosphere at a high temperature. These modifications, of which the second is now much the more largely adopted, are generally referred to as the "Siemens-Martin" process, or "Martin process." A third modification is substantially the Uchatius process carried out in a regenerative hearth instead of a crucible; this is known as the "Siemens process" or "ore process," and consists in melting hematite pig, or other pig iron free from sulphur and phosphorus, and then adding in small quantities at a time an equally pure ore until a sample taken out from time to time does not harden on plunging into water whilst still red hot; to the fused iron spiegeleisen, &c., is then added as before; in this way a somewhat larger quantity of steel is obtained from a given amount of pig, the ore becoming partly reduced whilst oxidizing carbon and silicon, &c.; but this advantage is counterbalanced by the greater wear and tear owing to the larger amount of cinder formed and its corrosive action on the brickwork, and by the necessity for using somewhat more fuel. A fourth modification consists in a sort of combination of the Martin method and the ore process, the pig and scrap, &c., being fused together and the decarbonization being then effected, not by oxidation by the gases alone, but by that together with ore added to the mass.

When Siemens's precipitation process (§ 31) is used, or when the ore is reduced to spongy metal in a rotating furnace, &c. (§ 30), the resulting iron is readily converted into steel by simply adding it instead of malleable scrap to the fused pig in the above process,—spongy metal when thus employed being made up into a sort of ball by stirring it up with fused magnetite, and the whole added to the fused pig; another variety of combination of "ore process" and ordinary Siemens-Martin process is thus obtained, the finishing up of the metal by adding spiegeleisen, &c., in known quantity when complete decarbonization has been effected being the same in all cases. An analogous modification is that of Blair, who first prepares spongy iron by reducing the ore in much the same fashion as in Chenot's process (§ 30), and then fuses it up in a regenerative furnace with more or less pig to give a fluid bath to begin with.

In the ordinary working of the process when ore is not used, the materials employed are pig iron (free from sulphur and phosphorus) and malleable scrap of various kinds, together with scrap and waste Bessemer steel, crop ends of rails, &c. The pig being melted and

the malleable iron raised to nearly a white heat (either in a separate furnace or by the waste gases before passing to the regenerator), the latter is gradually added to the former until the whole is liquid; the heating is then continued, the flame being made somewhat oxidizing so as to gradually decarbonize the metal, until a sample of the metal drawn and cooled in water is scarcely hardened thereby; at this stage the metal is virtually molten decarbonized iron, all silicon, manganese, and carbon having been removed by oxidation. To give the requisite steel character, a definite quantity of spiegeleisen is added (or of ferro-manganese when a larger relative percentage of manganese is desired, or in certain cases of silico-manganese when silicon is wanted to be present), and the whole cast into ingots. Pig iron alone can be used in the first instance, only then a longer time is requisite to effect decarbonization. The following analyses by A. Willis illustrate the relative rates at which the oxidation of manganese, silicon, and carbon is effected, the quantity of the last not suffering any material diminution until the others have almost disappeared:—

Time In Hours since Fusion just completed	0.	1.	2.	3.	4.	5.	6.	7.
Manganese per cent. ...	1.14	0.58	0.20	0.08	nil	nil	nil	nil
Silicon " ...	0.57	0.23	0.18	0.05	nil	nil	nil	nil
Carbon " ...	1.90	1.50	1.70	1.65	1.60	1.10	0.60	0.20

When pure ores are used in the ore process, no appreciable alteration takes place in the percentage of sulphur in the pig and scrap, but if sulphates (*e.g.*, barium sulphate) be present in the ore, the resulting steel contains more sulphur than the pig and scrap used to the extent of about 30 per cent. of the sulphur present in the ore (Willis). When ferro-manganese is used to finish the process and prepare a soft steel, the requisite quantity of ferro-manganese is heated up either on the bed between the hearth proper and the regenerators on which the materials are heated up by waste heat or otherwise without fusion; when spiegeleisen is used, the requisite quantity may either be added in the same way, or fused in a cupola and then added; burning out of more or less carbon and manganese is always a possibility where a cupola is used, wherefore when possible the spiegeleisen is fused in the hearth itself or its adjuncts. In order to obtain the best castings at Terre Noire, the decarbonized metal is treated with siliceneisen, and then allowed to remain for some twenty minutes in as nearly neutral an atmosphere as possible, so that cinder may completely be separated by gravitation and the reaction of the silicon on the carbon oxide may be complete (§ 44); the ferro-manganese is then added, and the casting proceeded with.

In the Siemens-Martin process (where ore is not used) the yield of steel finally obtained is somewhat below the weight of metal originally employed, owing to oxidation; in the ore process, on the other hand, a larger weight of steel is ultimately obtained than that of the metal used, owing to the reduction of iron from the ore. The consumption of fuel per ton of ingot steel is, however, somewhat higher in the ore process, owing to the larger quantity of slag. According to Gantier a considerable loss of fuel results if the gas producers are not placed close to the steel furnaces, even to the extent of one-third in some cases; probably this figure is a little overestimated (see § 10).

In order to avoid the necessity of decarbonizing completely the metal and then recarbonizing by addition of spiegeleisen or ferro-manganese, which is practically entailed by the difficulty experienced in finding out the exact composition of the partially decarbonized metal at any given stage of the operation, it has been proposed by Ryder to sample the steel and cast the sample into a small ingot of definite size and shape, and then to determine the magnetic qualities developed in the ingot by the influence of a powerful electromagnet, using a particular apparatus devised for the purpose. In this way a fairly correct estimate of the amount of residual carbon is obtained, rendering it unnecessary to prolong the operation of decarbonization further when the test shows that an amount is present sufficient to give a steel of the required quality on addition of a known amount of ferro-manganese. In the inventor's hands the method has been found to work successfully, enabling the open hearth operations to be considerably shortened as to duration. An improved form of apparatus for the purpose has also been described by Wattenhofen.

40. *The Pernot and Ponsard Furnaces and Allied Appliances.*—The Pernot furnace as applied to steel making differs in no material respect from the Pernot puddling furnace; it is substantially a Siemens-Martin furnace with a rotating bed. The hearth is a saucer-shaped cavity supported by an iron frame, mounted on the top of a slightly inclined nearly vertical axis, and running on wheels upon a rail or guide supported on a stout bogie (fig. 62). When in position the hearth is just under a dome or roof, which is perforated with orifices for the entrance and exit of the

gas and blast and exit gases passing to the regenerators; as the furnace revolves the liquid metal always forms a pool at the lowest portion, but any solid matter is carried round, alternately rising above the pool and being plunged beneath it; the effect of this is greatly to facilitate melting down and also considerably to shorten the time requisite

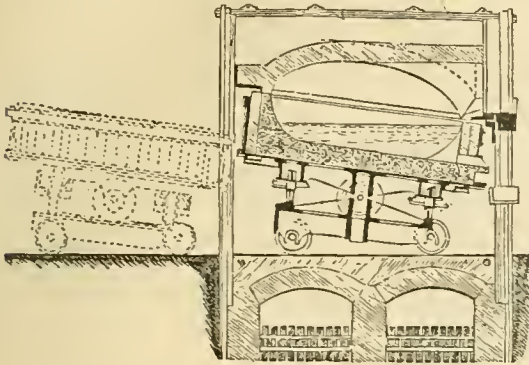

Fig. 62.—Pernot Furnace.

for oxidizing out the carbon. At the required stage of decarbonization the blast and gas supply are shut off, the spiegeleisen or ferro-manganese added, and the bogie withdrawn carrying with it the hearth and metal; or it may be tapped *in situ*, and removed only for repairs (relining, fettling, &c.).

Comparing the working of a furnace of this kind with one of similar dimensions but fixed bed, Hackney found that the output of steel was about double in a given time, and the coal used per unit weight of steel was less than one half, viz., 0.40 to 0.43 instead of 0.90 (8 to 8½ cwt. per ton instead of 13 cwt.). At St Chamond an improved Pernot 7-ton furnace gave during three months working the following results per unit of ingot steel:—

Coal used for smelting . . . . .	0.318
„ lighting, repairing, &c. . . . .	0.156
Total . . . . .	0.474

The metal used per unit of ingot steel was 1.06, the output being about 21 tons per day of twenty-four hours, the conversion taking about seven hours per charge. In English works where the Siemens process ("ore process") is used with fixed hearths the yield of steel is somewhat in excess of the metal used originally, but the time of working is inferior to that just mentioned, the yield with 5-ton furnaces being only some 14 tons per twenty-four hours.

Holley states that the removable Pernot furnaces set up in America (especially at Springfield, where 20-ton hearths have been recently erected) are highly satisfactory, especially as regards the ease with which repairs can be made; the hearth can be run out on Saturday night, and is cool enough to repair on Sunday; firing up being commenced on Sunday night, the furnace is ready for the usual charge on Monday forenoon. Krupp's dephosphorizing pro-

cess is adopted to purify the pig before finishing in the Pernot hearth, the metal being run from the melting cupolas into the Krupp washing furnace, and thence into the steel furnace by means of a ladle. Essentially the Pernot furnace is an ingenious combination of various previously well-known principles, the rotating circular bed having been previously used not only for puddling iron, but also for roasting ores, and the withdrawing carriage having also been employed previously in the manufacture of armour plates, whilst the inclined axis had also been previously used.

**The Berard Process.**—This method is essentially a sort of combination of the Bessemer converter principle and of the open-hearth method. A double furnace is employed, heated by gas, and provided with movable tubes dipping into the melted metal, or with a tuyere at the base in the case of the first hearth, in which the metal is blown, and the carbon, &c., oxidized by means of an air-blast; in the fellow hearth the metal is partially recarbonized by the gases from coal similarly blown into it, the object being to facilitate the removal of sulphur and phosphorus. Finally the purified metal is treated with spiegeleisen or ferro-manganese in the usual way.

**Ponsard Furnace or Furno-Convertisseur.**—This apparatus is essentially a combination of the Pernot furnace with the Bessemer converter, consisting of a hearth movable about an obliquely vertical axis (figs. 63, 64). Instead of rotating round and round on this axis, the hearth D only moves through half a revolution; when in one position (as in-

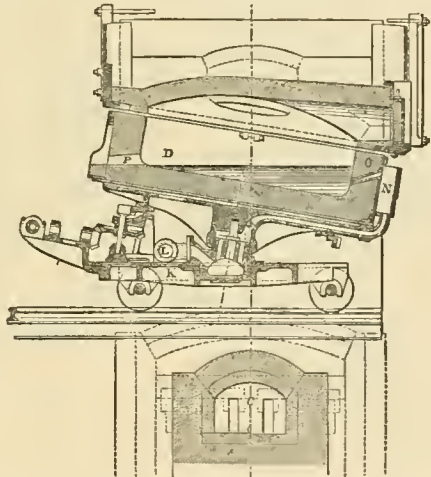

Fig. 63.—Ponsard Furno-Convertisseur—Transverse section.

indicated in fig. 63) the surface of the molten metal is above the level of a series of tuyeres O fed by a blast pipe LMN; under these circumstances the apparatus performs the functions of a Bessemer converter, the blast passing through the molten metal; when it is half turned round, the tuyeres are raised above the surface of the metal and the blast is shut off, so that it then becomes an ordinary Siemens open hearth. The air blast is introduced, as in the Bessemer converter, through a hollow axis of rotation; the hearth is fixed, as in the Pernot furnace, upon a carriage or bogie K, so that it can be withdrawn and the metal tapped out at the tapping hole P. A gas producer A is attached, the gases from which are burnt as they are formed without cooling by passing through a long pipe, &c., or heating by a regenerator; the air used to burn them, however, is heated by a regenerative arrangement consisting of a pair of chambers H filled with brick stacked in a peculiar way; through one chamber the waste flame passes by the flue EFG, heating it up; through the other one used alternately the air passes reaching the furnace by the flue CC. F is a chamber in the waste gas flue for the deposition of solid suspended matters, dust, &c., from the blowing opera-



tion, and G is a small bed for heating scrap, &c., before its introduction into the main hearth D. Owing to the regenerator only heating up the blast, the waste gases escape at a much higher temperature than with a Siemens regenerator; accordingly they may be advantageously utilized to produce steam.

According to Perissé (from whose paper—*Journ. I. and S. Inst.*, 1878, 459—the cuts, figs. 63 and 64 are taken) the average duration of a blow and subsequent operations in a 5-ton furnace is five to six hours when the metal is charged cold, whilst six to eight operations may be made in twenty-four hours when it is previously melted in a spare hearth; 250 kilos (about 5 cwt.) of Monis coal were consumed per hour, or about 6 tons per twenty-four hours for 20 tons and upwards of production (charged cold), or for 30 to 40 tons (charged with fluid metal). Phosphorus is not materially eliminated, because, as in the ordinary Bessemer and Siemens-Martin hearths, there is a silicious flux always present, owing to the nature of the lining; this objection, however, is readily remediable by simply using a "basic" lining (§ 37), when more or less complete dephosphorization results, just as is the case with the Pernot hearth when a large amount of fused iron oxide is added, as in Krupp's dephosphorizing process.

By omitting the movable bed, and substituting the ordinary fixed bed of a reheating furnace, the Ponsard forno-couvertisseur becomes changed into the Ponsard reheating furnace; the advantages of this form of arrangement over that of Siemens's reheater are said to be considerable saving of cost in construction and capability of producing steam by the waste heat.

41. *Manufacture of Spiegeleisen and Ferro-manganese and Allied Substances.*—In all the above combination processes which are successfully worked, the final stage is almost invariably the addition to more or less completely decarbonized molten iron of carbonized manganese-ferrous iron in definite proportion, so as to communicate a known amount of carbon (and also of manganese) to the mixture; accordingly the preparation of *Manganeisen* (as such substances may be conveniently termed) is an important step in the steel making processes. When highly manganese-ferrous iron ores, such as the Styrian spathose ores, are smelted in the ordinary way in a blast furnace, a large fraction of the manganese is not reduced, but passes away in the cinder; by using a larger amount of fuel

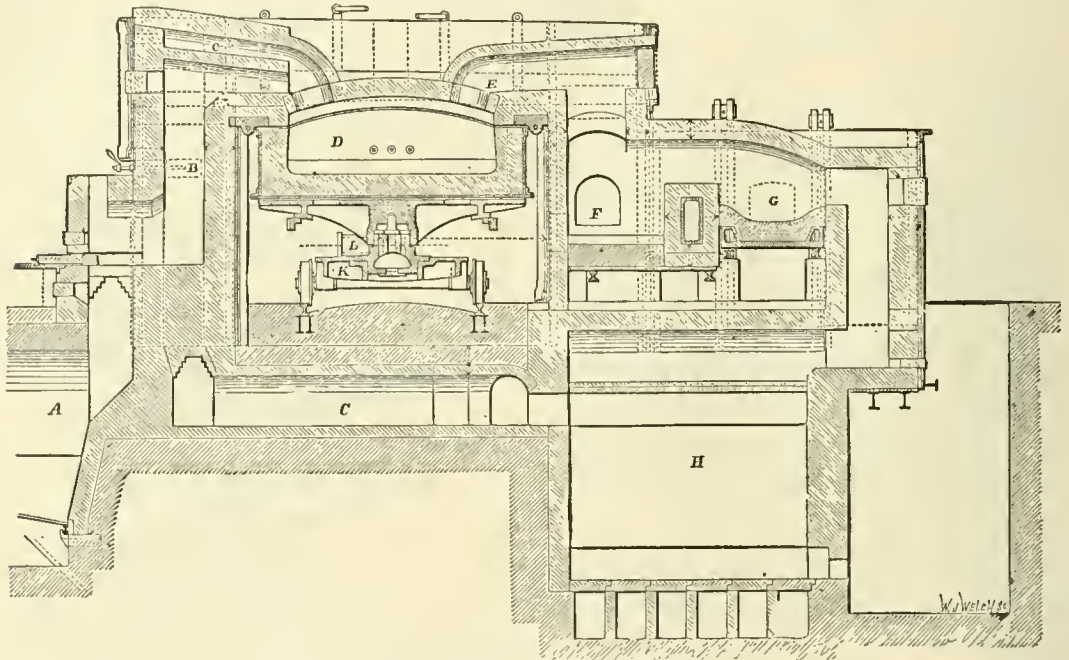

FIG. 64.—Ponsard Forno-Convertisseur—Longitudinal section.

relatively to the burden, however, the quantity of manganese reduced and obtained in the pig iron is increased; the hotter the blast the greater the richness in manganese of the pig, at least with the ores used in the Siegen district. At Nijne Tajilsk (Urals) a ferruginous manganese dioxide occurs of the following composition:—

Manganese dioxide .....	58.00 per cent.
"    sesquioxide .....	13.86 "
Ferrous oxide .....	15.33 "
Silica .....	4.13 "
Water .....	8.68 "

From this a fine brand of spiegeleisen is smelted. At Schisshyttan (Sweden) occurs a mixture of magnetite, manganese garnet, and knebelite (silicate of iron and manganese), of which mixed ore the average composition is

Silica .....	25.88 per cent.
Ferrous oxide .....	54.57 "
Manganese oxide .....	17.17 "
Alumina and calcium carbonate, &c. ....	2.38 "

Of late years this has been extensively used for manufacturing spiegeleisen (chiefly used for Swedish Bessemer

iron) containing about 4 per cent. carbon and upwards of 10 of manganese, sometimes 15 or even more per cent. being present. These higher manganese-ferrous irons show little or no magnetic action.

During the early period of the development of the fused steel industry, the richer manganese-ferrous (containing 15 per cent. and upward of manganese) used for crucible steels were themselves prepared in crucibles, the term "ferro-manganese" being applied to these products, "spiegeleisen" indicating the less manganese-ferrous pig containing some 6 or 7 per cent. of manganese prepared in the blast furnace; subsequently, however, the blast furnace spiegeleisens of commerce were prepared much richer in manganese than formerly, whilst ferro-manganese of 30 and upwards per cent. of manganese came into use prepared by Henderson's method, viz., by reducing upon the open hearth of a Siemens furnace a mixture of manganese carbonate (obtained from bleaching powder residues or "still-liquor") and ferric oxide in presence of excess of carbon, a neutral or slight reducing flame being employed. The furnace bottom is made of coke ground up and consolidated, so as virtually to form a large carbon shallow crucible or basin,—the finely divided mixture being put in and the temperature raised to a low red heat for some hours. A metallic sponge is obtained which subsequently runs down to a regulus when the temperature is raised to a full white. An important influence in the amount of manganese

reduced and contained in the final alloy is exerted by silica; if much of that substance be present the product is comparatively poor in manganese, a green slag (mainly manganese silicate) being formed; a very high temperature too is essential; of late years blast furnace manganese have almost superseded these open hearth products. Alloys containing 25, 50, 75, and even more per cent. of manganese are usually employed in the manufacture of so-called extra soft steels (or more properly fused irons), the use of spiegeleisen being in such cases inadmissible inasmuch as too high a degree of carbonization would be effected if sufficient spiegeleisen were added to communicate as much manganese as is desired to be present; thus at Terre Noire, where the preparation of ferro-manganese has been extensively experimented with and adopted, only about 1.5 parts of 45 per cent. manganese are added to 100 of the decarbonized product from the Siemens-Martin hearth or Bessemer converter, thus communicating some 0.7 per cent. of manganese with less than 0.1 per cent. of carbon; whereas were spiegeleisen used at 8 per cent. manganese only, either the carbon percentage would be far too great, or the manganese would be too low to give the particular physical qualities required. For the manufacture of spiegeleisen the franklinite of New Jersey (essentially a compound of ferric oxide with oxides of zinc and manganese) has been long utilized, being first heated with anthracite so as to reduce and distil off most of the zinc (the vapour of which is allowed to oxidize, the resulting oxide being collected), and then smelted in small blast furnaces with anthracite and limestone flux with a large excess of fuel (about three times the weight of spiegeleisen run or more).

According to Snelus (*Journ. I. and S. Inst.*, 1874, 68) the best results are obtained when a certain quantity of manganese remains unreduced and escapes in the slag, which should have about the following composition to give the best results:—

Silica .....	35 per cent.
Alumina .....	10 "
Lime .....	30 "
Manganous oxide .....	12-20 "

constituting a green vitreous smooth mass of conchoidal fracture. The composition of the charges introduced into the furnace must be calculated out so as to give about this amount of manganese unreduced together with that reduced in relation to the other constituents respectively; thus from the following average composition of charge the annexed slag and spiegeleisen result:—

Charge.	Slag.	Spiegeleisen.
Per cent.	Per cent.	
Silica .....	33	Iron .....
Alumina .....	14.6	Manganese .....
Manganese oxide .....	16.0	Carbon .....
Lime and magnesia .....	32.0	Silicon .....
Ferric oxide .....	{...}	Sulphur .....
		Phosphorus .....
		99.90

Much more richly manganiferous metals than this have been obtained in the blast furnace by W. G. Ward (Cartersville, Georgia) by simply increasing the amount of lime added, and employing a smaller burden; in this way ferro-manganese of upwards of 50 per cent. has been manufactured readily, about three-fifths of the manganese in the charge being reduced. Analogous metals have been obtained by many other smelters; thus specimens of ferro-manganese containing upwards of 80 per cent. of manganese and prepared in the blast furnace were exhibited in the Paris exhibition. According to Akermann, to produce ferro-manganese of 85 per cent. in the blast furnace is a matter of no great difficulty, but the consumption of coke is about four times greater than that required for common pig iron, whilst the daily output is only about one-fourth of that of the latter. No advantage attends the production of manganese of upwards of about 80 per cent., but rather the contrary, richer metal being very brittle. It is noteworthy that, notwithstanding the use of much more fuel in a furnace smelting rich manganese, the escaping gases do not contain more carbon oxide than (and often not as much as) those of an ordinary blast furnace, the extra oxygen in the carbon dioxide escaping coming from the higher oxides of manganese employed as manganese ores. A description of the older modes of producing spiegeleisen in Germany is given in a report by Wiborg to the Swedish iron office (*Jern-Konforets Annaler*, 1870; also in abstract in *Journal I. and S. Inst.*, 1872, 138).

When lime fluxes are employed, it is indispensable that they should not contain phosphorus; thus the spiegeleisen prepared in New Jersey from franklinite was found to contain phosphorus to a decidedly prejudicial extent when oyster shells were employed as flux, but ceased to do so when good limestone was used instead. It is noteworthy, however, that when a highly manganiferous iron is smelted a considerably larger preparation of phosphorus finds its way into the cinder and less into the pig than is the case when

the resulting pig contains less manganese; and the same remark is also largely true of sulphur.

According to several chemists and metallurgists as the percentage of manganese in manganese increases, so, roughly speaking, that of carbon decreases; so that whilst spiegeleisen of 7 or 8 per cent. manganese usually contains some 4 or 5 per cent. of carbon and sometimes more, ferro-manganese of 20 per cent. manganese contains much less carbon, and when the manganese attains to 30 per cent. and upwards the carbon becomes diminished to something below 1 per cent., being often as low as 0.4 or even 0.25 per cent. (Henderson). Others, however, have obtained diametrically opposite results; thus Riley and Grüner both find that the carbon percentage increases *pari passu* with that of manganese. The peculiar large mirror-like crystals from which the term "spiegeleisen" (mirror iron) is derived are not exhibited by ferro-manganese containing large amounts of manganese.

By mixing finely divided iron (sponge, filings, turnings of cast or wrought iron or steel, &c.) with finely powdered ores of manganese, tungsten, or titanium, or with quartz in suitable quantity, moistening with dilute acid or ammoniacal solution, and compressing into lumps, hard masses are formed (after standing a few hours) which can be heated to a red heat without breaking up. By melting these in a small cupola furnace with a crucible or hearth of alumina, magnesia, or lime, or of hard carbon and a tuyere letting in a hot blast just above the top of the hearth, manganese and siliceneis containing up to 75 per cent. of manganese or 22 per cent. of silicon, or iron-tungsten or iron-titanium alloys, or ternary alloys can be readily produced (*Chronique de l'Industrie*, 1873, ii. 235).

The following analyses illustrate the composition of various kinds of spiegeleisen, ferro-manganese, and allied products:—

Analyst .....	English Spiegeleisen.	New Jersey Spiegeleisen, Franklinite.	Misen Spiegeleisen.	Ferro-manganese, Reschitzky, Hungary.	Chrom-eisen.	Titaniferous Pig, Titanite and Haematite.
	Snelus.	Henry.	Fresenius.	Sium.	Riley.	Riley.
Iron .....	75.96	85.30	82.860	23.46	87.28	93.47
"Combined" carbon .....	5.25	5.48	4.323	6.21	2.82	3.31
Graphite .....	...	...	...	...	...	...
Silica .....	0.37	0.20	1.000	0.28	0.21	1.86
Manganese .....	18.26	4.50	10.707	69.64	trace	0.50
Sulphur .....	nil	0.08	0.014	trace	trace	0.06
Phosphorus .....	0.06	0.15	0.053	0.06	0.12	0.03
Zinc .....	...	0.50	...	...	...	...
Copper .....	...	...	0.066	0.74	...	...
Chromium .....	...	...	...	...	9.57	...
Titanium .....	...	...	0.006	...	...	1.15
Nickel and cobalt .....	...	...	0.016	...	...	...
Calcium, magnesium, aluminium, arsenic, &c., and loss .....	...	...	0.349	...	...	...
	100.00	95.01	100.000	99.73	100.00	100.43

*Siliceneis.*—In order to produce highly silicious iron, according to Jordan, the main conditions are that the blast shall be extremely hot, the furnace not driving rapidly, and that the charge whilst containing much silica shall be highly aluminous and not markedly calcareous. An accident at the Heardt iron-works, Dusseldorf, necessitated the shutting off of the majority of the blast, three tuyeres instead of six being used, and the pressure being reduced from 15-18 to about 10 centimetres of mercury (*i.e.*, from about 3.1 to 1.9 lb per square inch); the blast became highly heated (from 500° to 600° C.), whilst the burden was increased, the charge containing 12½ cwt. ore at 33 per cent. iron, 6 cwt. limestone, and 10 cwt. coke, so that the slag contained silica 50, lime 33, alumina 16, manganese oxide 1, the coke being 42 cwt. per ton of iron. Under these conditions a pig was run containing silicon 7.9, phosphorus 0.72, and carbon 2.60 per cent. Analogous results as regards increased percentage of silicon on decreasing lime and increasing alumina relatively to the silicon have been observed in various other instances. Troost and Hautefeuille consider that the presence of alkali silicates in the furnace promotes the silicizing of the iron,—the alkali metals formed at a high temperature by the reduction of the alkalis reacting whilst still nascent on the silica, and thus reducing it; a mixture of potassium carbonate, charcoal, iron



filings, and silica melted in a wind furnace affords a cast iron containing 15-16 per cent. of silicon and nearly 3 per cent. carbon; lime or calcium silicate on the other hand removes silicon from silicious iron when the two are melted together. It is a matter of usual belief that silicon expels sulphur from pig iron; at any rate the conditions most favourable to production of highly silicious pig are not so favourable to the presence of sulphur, and hence grey silicious pig is much less sulphurized than white pig made from the same materials. According to Riley the greater the percentage of silicon in siliceous iron the smaller is the amount of carbon present, so that when 15 or 20 per cent. of silicon is present the carbon is reduced to a very small amount.

**Silicon-Manganeisen.**—Silicious spiegel-eisen (or manganese silicide, as it is sometimes termed) is prepared by the ordinary blast furnace methods of making rich spiegel-eisens by increasing the amount of silica present and using large amounts of fuel. For the purpose of preventing "blowholes" in cast soft steels containing but little carbon, an alloy containing about 8 per cent. of silicon, 14-15 of manganese, and about 1.3 per cent. of carbon, has been extensively used at Terro Noire. The steel thus produced gave the following numbers (Euvette, *Bulletin Soc. des Ing. Civ.*, 1877):—

	Hard Metal for Projectiles.		Very soft Metal.	
	Crude Metal.	Tempered Metal.	Crude Metal.	Tempered Metal.
Percentage of carbon.....	0.550 to 0.635	0.260 to 0.317	0.260	0.330
" silicon.....	0.405 " 0.550	0.41	0.48	
" manganese.....	0.95 " 1.05	12.5	14.8	
Breaking strain in kilogr. per sq. millim. ....	52.2 to 38	77.2 to 116	46.8 to 56.8	56.5 to 67.7
Elongation.....	1.2 " 4.0	9.7 " 6.5		

**Chromium-steel,** or "*Chrom-eisen*," as it may conveniently be termed, is closely allied to manganese; the capabilities of this substance for the most part yet remain undeveloped, but the effect of the chromium is analogous in some respects to that of manganese, in others to that of carbon, communicating a fine close texture with hardness and brittleness when present in any quantity. Chrom-eisens containing 10 per cent. and upwards of chromium have been prepared by crucible operations, and of somewhat less richness in the blast furnace from ores containing a notable amount of chrome ironstone; Sergius Kern obtained a very hard chrom-eisen containing 74 per cent. of chromium and 25 of iron by heating chrome ironstone and charcoal powder in graphite crucibles. The Tasmania Iron Company produced from Tasmanian ores a pig containing some 6 or 7 per cent. of chromium and 4 of carbon; according to Riley a mixture of this pig with ordinary hæmatite pig (half and half) would not puddle well, being incapable of welding and forming a bloom on account of the thick cinder; with less chrom-eisen (one-tenth) the puddling period was prolonged; a little of the chromium remained unoxidized in the iron without materially affecting its qualities; at first the ordinary grey pig melted whilst the chromium pig remained unfused. By melting chromium pig containing upwards of 0.2 per cent. of sulphur with ferro-manganese, the sulphur becomes almost entirely eliminated, the resulting product only containing 0.035 per cent.; on adding it (in a fused state) to blown Bessemer metal a product was obtained not at all resembling good manganese Bessemer steel, as it crumbled under the hammer at a red heat. The experience of a Sheffield firm as to the tempering qualities of chromium steel has been very unsatisfactory; and Boussingault states that he was unable to use to iron any of the useful properties of steel by adding chromium unless carbon were also present; on the other hand, it has been stated that in America mining tools made of chromium steel have been found to be more durable than any others, the tempering being readily managed. Yet again, K. Brown finds that by adding potassium dichromate to blown Bessemer metal or other varieties of steel a certain amount of chromium is reduced and counteracts the evil effects of phosphorus, steel so made being capable of being bent and twisted cold even though containing as much as 1 per cent. of phosphorus; thus samples of steel so prepared gave the following numerical results (*Journ. I. and S. Inst.*, 1879, 355):—

Percentage of carbon present.....	0.19	0.18	0.28	0.30	0.30	0.52	0.41
" chromium.....	0.18	0.29	0.21	0.14	0.16	0.20	0.26
" phosphorus.....	0.314	0.360	0.785	0.90	0.95	1.16	1.39
Tensile strain (tons per square inch).....	57.5	49.0	60.3	43.6	44.4	6.0	4.5
Percentage ultimate extension.....	4.61	34.0	8.7	19.35	21.9	...	...

**Tungsten-steels** have been often brought forward as possessing valuable properties, but do not appear to have been largely manufactured in England. On the Continent they have attracted more attention; thus Biermann of Hanover has prepared ferro-tungsten containing from 20 to 50 per cent. of tungsten and a few parts per cent. of manganese with the object of using the composition in the same way as ferro-manganese, *i.e.*, intermixing it with larger amounts of decarbonized iron so as to obtain a tungsteniferous steel of known

composition. Grüner states that the hardness of steel is increased by addition of tungsten almost indefinitely, but that when more than 2 or 3 per cent. is present the metal becomes brittle from extreme hardness; for lathe tools steel up to 8 per cent. tungsten may be used provided they be submitted only to a mild oil tempering, for with water they would fly to pieces; thus a hook tool used in a steel tire shop of the West of France Railway Company contained

Tungsten.....	7.98 per cent.
Carbon.....	1.40 "
Silicon.....	0.22 "

In the manufacture of such steels the tungsten is introduced either as a triple manganese alloy (prepared on a Siemens hearth or in the blast furnace like ferro-manganese) or as crude fitted metallic tungsten obtained by reducing wolfram with a mixture of coal and tar, &c.

Levallois has patented in France the use of ternary nickel-tungsten-iron alloys containing

	No. 1.	No. 2.	No. 3.
Iron.....	95.0	95.0	97.0
Tungsten.....	4.5	4.5	2.5
Nickel.....	0.5	0.5	0.5
	100.0	100.0	100.0

They are said to be very hard, but can be worked like ordinary cast steel; they are prepared by putting the tungsten and nickel into a small soft iron tube together with a little flux (composed of 9 parts boric anhydride and 8 each of calcined quartz and washed calcium carbonate), and placing the tube in the midst of the rest of the iron in a crucible, the surface being covered with some of the flux. When melted up, the whole is poured into moulds in the usual way.

**Manganese Bronze.**—By melting ferro-manganese and copper together, or preferably mixing the two metals separately fused, all traces of oxide disseminated through the copper are removed by the agency of the readily oxidizable manganese, and a close-grained tough alloy results, capable of very many useful applications. The percentage of iron in the alloys usually prepared, however, being but small, the description of these products more properly belongs to the metallurgy of copper and manganese.

### IX. PHYSICAL QUALITIES OF IRON AND STEEL IN THEIR PRACTICAL RELATIONSHIPS.

#### 42. *Hardening, Tempering, and Annealing of Steel.*—

It has been already stated (§ 3) that the characteristic property of steel as distinguished from malleable iron is that when heated red hot and suddenly cooled (by plunging into cold water, oil, mercury, &c.) it becomes hardened to a greater or lesser extent, and rendered more or less brittle and also elastic; when the steel thus hardened is heated red hot and cooled slowly, on the other hand, it loses this acquired hardness and becomes soft and malleable again; this inverse process is strictly termed "softening" or "annealing." The generic phrase "tempering" is usually applied to mean a combination of the hardening and annealing processes practically applied to all steel goods in order to give such a degree of hardness as will best fit them for resisting wear and tear, conjoined with the minimum possible of brittleness,—this being effected by first hardening them by heating to a red heat and suddenly cooling, and then heating up again to a somewhat lower temperature and allowing to cool slowly. According to the temperature to which the hardened steel has been heated before annealing, so is the diminution in the hardness effected by the process; and the particular resultant combination of hardness with toughness and elasticity is spoken of as the "temper" of the steel. Occasionally, however, this latter phrase is applied in somewhat different senses; thus steels of different carbon percentages are sometimes said to differ in temper irrespective of whether they have actually been hardened and annealed or not; the term "tempering capacity" or "hardening capacity" would better express the idea. Sometimes again, especially amongst "practical" men and workmen, the phrase "to temper a tool" is understood as signifying simply to harden it: whilst on the other

hand the same term is often used to imply the softening or annealing only of the tool.

In the act of hardening, steel becomes specifically lighter to an extent varying with the temperature attained before cooling, the composition of the steel, and its form and dimensions, and according as it has been rolled or otherwise worked before treatment; thus Eisner found a specimen of cast steel had the specific gravity 7.9238 before hardening, and 7.6578 after (both at 11° C.), indicating an expansion in volume of about 3.5 per cent. Similarly Rinman found expansions of 2.6 to 3.5 per cent. for blister steel; and Hausmann found for a very hard steel and for a soft welding steel expansions of 1.7 and 0.8 per cent. respectively. The expansion, however, is not uniform in all directions; thus Caron found that a hammered steel bar 20 centimetres long and 1 centimetre square in section altered after repeated hardenings to the following extent in percentages of the original dimensions:—

Number of Hardenings.....	10.	20.	30.
Decrease in length.....	2.5	6.8	10.15
Increase in width.....	2.0	3.0	6.0
Decrease in specific gravity.....	...	...	0.9

whilst with rolled steel there was an increase in length of 2.25 per cent. and no change in the other dimensions.

On thoroughly annealing hardened steel it recovers the original dimensions possessed before hardening; evidently therefore when a large steel tool is hardened, since the inner portion cannot possibly become cooled at the same rate as the outer film, a kind of strain must be developed amongst the particles; for, whilst the rapid chilling of the outer portion causes that part to occupy a larger volume than it otherwise would, this is not effected to so large a relative extent with the inner portions. The opposite result is necessarily produced during annealing. Accordingly, in the process of tempering steel goods, cracking and splitting or "buckling" and otherwise getting out of shape are inconvenient results that are apt to happen, especially when all parts of the surface are not equally and simultaneously heated or chilled, a result difficult to bring about with articles of certain shapes; the hardening process may in such cases be more safely effected by heating the article up gradually in a fluid bath such as melted lead (or in some cases oil) and then chilling in a cool fluid bath, preferably of oil; whilst the annealing may be performed by allowing the fluid in which the article is slowly heated up to cool down again spontaneously when the requisite temperature is attained. For special articles, e.g., saws, a particular manipulation is requisite to avoid buckling; in some cases the annealing of a flat plate, e.g., a circular saw, is effected between two solid flat masses of iron, which keep the plates from getting out of shape whilst cooling. In some instances when the point only of an article is required to be tempered, e.g., certain kinds of chisels, the whole mass is heated red hot and the point dipped into water or oil to harden it; on taking out, the heat from the body of the hot article is rapidly conducted to the point; as soon as its temperature is sufficiently raised the body is somewhat cooled by a short immersion so as to reduce the temperature of the whole approximately to uniformity, and then the article is allowed to cool altogether slowly; so that the hardening and annealing are effected by one heating only. For articles the temper of which requires to be somewhat exactly determined, the temperature attained is judged of by the tint of the hideous film of oxide which forms on the surface (previously brightened) during the heating; the higher the temperature the thicker the film, the colours and temperatures being approximately as follows:—

Colour.	Approximate Temperature.	Class of Tools for which the Temper is best suited.
Very pale yellow.....	220° C.	Lancets.
Straw colour.....	230-235°	Surgical instruments and razors.
Golden yellow.....	240-245°	Pen-knives and common razors.
Brown.....	255°	Scissors, cold chisels, shears, &c.
Brown dappled with purple.....	265°	Axes, planes, &c.
Purple.....	275-280°	Table knives, large shears.
Bright blue.....	285-290°	Springs, watch springs, swords.
Full blue.....	290-295°	Fine saws and augers.
Dark blue.....	315°	Hand saws and large saws.

For instance, if a saw is to be tempered at a full blue it is heated over a clear fire or a mass of red hot iron or in a sand bath until the tint appears on the brightened surface, when it is allowed to cool. In many cases the tempering of tools is effected with sufficient accuracy without brightening them, by coating them with tallow, oil, or some similar composition, and then heating over a lamp or a mass of hot metal until the tallow, &c., begins to decompose; with sufficient experience as to the size of the article, the mode of heating, and the character of the decomposition set up, much the same results are arrived at as when the colour is watched on the brightened surface. In some instances the requisite temper is given by one operation only, the point of the article to be hardened (a

drill, say) being coated with tallow and heated in a flame until the tallow decomposes rapidly, and then plunged into a mass of tallow to chill it; the point is thus rendered harder than the body of the drill. By heating the point of a small tool nearly white hot and plunging it into a stick of sealing wax for a second, and then into another part of the wax, and so on till cold, steel may be made so hard as to be readily capable of boring into similar steel hardened in the ordinary way.

Instead of determining the temperature of the object to be annealed by the tint developed on it, various fusible alloys may be used, a series of such being placed in the annealing bath, so that by observing which are fluid the temperature is known approximately. Parkes gives the following compositions of lead-tin alloys for this purpose:—

Parts of Lead to four parts of Tin.	Temperature at which Alloy melts.	Parts of Lead to four parts of Tin.	Temperature at which Alloy melts.
7	215° C.	19	265° C.
7.5	221°	30	277°
8	225°	48	288°
8.5	232°	100	299°
10	243°	Boiling linseed oil.	316°
14	254°	Melting lead.	322°

The first five of these alloys consequently correspond to the various yellow shades; the next three to brown, brown and purple spots, and purple; and the last four to the blue shades.

43. *Strength and Tenacity of Iron and Steel.*—Independently of the additional strength communicated to iron by the presence of small quantities of carbon, producing steels or so-called steels of various kinds, a considerable increase in this property is brought about by the removal of portions of cindery matter by fusion. Wrought iron that has simply been welded, reheated, and rolled a given number of times is, *ceteris paribus*, less tenacious than iron from which complete fusion has removed the films of silicate, &c., enveloping the component layers and fibres of the welded material, and preventing their complete union together. Thus the best qualities of weld iron, containing usually about 0.2 to 0.3 per cent. of carbon, possess a tensile strain of from 20 to 30 tons per square inch, whilst mild "steels" and ingot irons are usually considerably higher in this respect, viz., from 30 to 40 tons per square inch; harder steels of higher carbon percentage are proportionately stronger. The following numbers may be quoted, representing tensile strains in tons per square inch.

*Weld Irons, or Wrought Irons made without Fusion.*

Kirkaldy.		
Govan puddled bar.....	20.9	
" hammered bar.....	28.7	
" rolled.....	25.4 to 26.6	
Diochrair bar, cold rolled.....	29.5	
" annealed.....	29.2 to 27.8	
" boiler plate, cold rolled, lengthways.....	32.7	
" " " crossways.....	36.0	
" " annealed, lengthways.....	22.7	
" " " crossways.....	21.7	
Lowmoor bars (0.3 per cent. of carbon).....	28.9	
Styffe.		
Lowmoor rolled tyre bar.....	27.3	
Lesjöfors rolled bar (made in Lancashire hearth).....	22.6	
Fairbairn.		
Average of five classes of plates { in direction of fibre.....	22.5	
{ across fibre.....	23.0	

*Ingot Irons, or Mild Steels, made by Fusion Processes.*

Greiner-Serlach extra mild steels, carbon per cent., 0.25 to 0.35.....	30 to 85
" " medium soft, " " 0.35 to 0.55.....	35 to 45
" " hard and extra hard, " " 0.55 and upds.....	45 to 70
Styffe: Högbo Bessemer iron, " " 0.23.....	33.0
" " hammered steel, " " 0.68.....	46.8
" Krupp's cast steel, " " 0.62.....	39.5
Kirkaldy: Bessemer soft steels, " " 0.3 to 0.4.....	33 to 35

Steel wire of as high a breaking strain as 206,170 lb, or 92 tons, per square inch section, has been drawn by Johnson and Nephew (Manchester), whilst wire of tensile strength of 70 to 80 tons per square inch is readily procurable. According to Collingwood, galvanizing increases the strength of freshly drawn wire by about 15 per cent., whilst ungalvanized wire has been found to gain nearly 5 per cent. by merely being allowed to remain at rest for a week or so; the increase of strength in each case appears



to be simply due to internal adjustment of the strains produced during drawing.

It does not necessarily follow that the resistance to percussive force exhibited by a given sample of metal will be in the ratio of its tensile strength. Thus phosphorus when present together with only minute quantities of carbon (forming the so-called "phosphoric steels") does not very materially decrease the tensile strength, such steels containing 0.3 per cent. of phosphorus being often but little inferior to soft non-phosphorized steels in this respect; but when tested by a "falling weight" (a mass of known weight falling once or oftener from a known height upon the centre of the bar or rail firmly gripped in supports a known distance apart) the phosphorized metals generally show themselves considerably inferior to the non-phosphorized ones. The same remark applies to silicon. According to

BEFORE RUPTURE



AFTER RUPTURE



Fig. 65.

Dudley the effect of phosphorus, silicon, and carbon in hardening iron and making it less capable of resisting percussion are nearly in the proportions of 3, 2, and 1 relatively to one another. The presence of manganese diminishes this deleterious effect of non-metals; whilst, if more than minute quantities of carbon be present, the tensile strength as well as the resistance to percussion is greatly diminished by the additional presence of phosphorus or silicon in proportions beyond certain small limiting amounts. Accordingly it is the usual practice to test rails, bars, &c., not only by the determination of the breaking strain for tensile force (measured by pulling asunder, preferably by hydraulic power, a bar turned to known definite dimensions, and made into the shape of fig. 65), but also by a falling weight,—a "monkey" (somewhat like a pile driver) being raised to a known height and let drop upon the rail.

The particular tests applied in different instances vary much; for instance, some little while ago the official falling weight test for Bessemer rails at Grätz (Austrian South Railway Company's Works) was to permit a weight of 1000 kilos (about a ton) to fall from a height of 15 feet upon the centre of the rail supported by two rests 3 feet apart, any amount of bending being allowed, but not fracture, whilst a test for elasticity or resistance to permanent deflexion was applied by placing a weight of 17,500 kilos on the middle of the rail similarly supported. The North-Eastern Railway (England) similarly at one time tested rails by allowing a weight of 1800 lb to fall from 4 feet height, the number of blows requisite to produce rupture and the permanent bending produced by each being noted. In other instances the test applied has been a ton weight falling a greater height, such as 20 feet or even 30 feet, the rail being required to stand one such blow only, or a succession, the particular details of the test to be applied being usually specified in each particular case; thus the Midland Railway Company has tested steel rails by allowing a weight of 1 ton to fall three times from a height of 12 feet, the supports being 4 feet asunder.

In just the same way as regards the determination of tensile strength, the dimensions of the piece to be tested (6 inches, 8 inches, 10 inches long, &c.) are usually specified, and the strain which the metal will just stand without becoming permanently elongated (limit of elasticity) determined, as well as the total strain requisite to produce rupture, together with the "ductility" or amount of permanent extension of the test piece and the diminution in section of the bar at the point of rupture. Thus for instance the following numerical data were obtained by Kirkaldy with a particular specimen

of West Cumberland Bessemer steel plate, three pieces being tested, each 10 inches long, and respectively  $\frac{1}{4}$ ,  $\frac{1}{2}$ , and  $\frac{3}{4}$  inch in thickness.

Thickness in Inches.	Limit of Elasticity in Tons.	Ultimate Breaking Strain per Square Inch.	Percentage diminution of Section at Place of Fracture.	Permanent Extension in Percentage of Original Length.		
				With 50,000 lb per Square Inch.	With 60,000 lb per Square Inch.	At Rupturing Strain.
0.25	20.7	29.8	54.4	2.60	8.02	23.2
0.49	16.0	27.7	50.7	5.52	13.9	27.3
0.75	15.0	27.6	49.6	6.09	15.0	30.2

These numbers illustrate, amongst other things, the effect upon the final values produced by variations in the diameter of the test pieces; the shorter and thicker the piece the greater in amount is the permanent extension. In calculating the rupturing strain per square inch, the dimensions of the metal as originally employed before permanent alteration was brought about are employed; by taking the diminished area at the point of fracture as the section, a much higher value is obtained as the tensile strength per unit area of the extended metal. Tempering steel greatly increases its breaking strain and limit of elasticity, but decreases the permanent extension; thus the following values represent certain results obtained with Crenzot steels of the A class, in tons per square inch (see *Engineering*, 1875, p. 119).

No. of Classification.	Not Tempered.			Tempered.		
	Limit of Elasticity.	Breaking Strain.	Percentage Extension.	Limit of Elasticity.	Breaking Strain.	Percentage Extension.
1	24.72	48.31	13	45.64	74.16	0.2
3	23.07	44.57	17	41.71	66.95	7.2
5	21.04	39.81	21	35.63	56.17	11.1
7	18.25	33.72	25	27.77	43.49	14.6
9	14.26	28.53	29	21.30	35.63	21.0

In making a contract for the supply of steel of a particular quality, the details of the tests of strength to be applied should consequently be duly set forth; for instance, a short time ago the French Government required certain steel navy tubes, of which the limit of elasticity and breaking strain tested in a particular way were respectively to be 21 and 38 tons per square inch. Similarly in the construction of the Mississippi great bridge the cast steels used were contracted to be of the following qualities:—"To be of crucible cast steel; the staves of the tubes to stand a compressive strain of 60,000 and a tensile strain of 40,000 lb per square inch section without permanent set, and to stand a tensile strain of 100,000 lb per square inch without fracture. Modulus of elasticity to be between 26 and 30 million lb, preferably nearer the lower limit, and as constant as possible; bars of the same modulus to be selected for the tubes, so that each side shall have same power of resistance; each bar to be tested and modulus stamped on it. Steel pins, rods, bolts, eyewashers, rivets, &c., and the  $\frac{1}{2}$  inch steel plates for enveloping the staves to stand a tensile strain of 40,000 lb per square inch without permanent set, and an ultimate tensile strain of 100,000 lb without fracture."

Practical tests of the capability of metal to stand bending double or through some given angle, or twisting round and round in the cold without fracture are often applied, as are also tests of the capability of being bent hot, forged, welded, &c. A test as to the power of resisting repeated bending strains backward and forward through a given angle is sometimes applied; a particular mechanical arrangement for effecting this has been described by Olrick.

James Price has constructed a machine for testing rails as to durability under rolling wear and tear, consisting of a pair of metal rollers 5 feet in diameter and 16 inches wide, weighing 45 cwt. each, supporting a frame weighing  $6\frac{1}{2}$  tons, connected with a centre boss and vertical axle, so that the rollers are driven round in a circle, one bearing with 5 the other with 6 tons pressure; the rails to be tested are bent into a circle or preferably a polygon, to equalize the wear of the rollers, which are driven over them at a speed of 13 or 14 miles per hour until the rails are broken or wear out.

It by no means follows that the rail which possesses the greatest tensile strength will resist wear and tear and rolling friction best, although this might be anticipated if, other things being equal, increased tensile strength corresponds to greater hardness; on the other hand, experience does not always indicate that the most carbonized rails last the longest, although the superiority of ingot metal (Bessemer steel, &c.) over weld iron (not fused) rails is well demonstrated; it is probable that the interposed film of cinder between the metallic fibres in the latter case greatly facilitates the destruction and wearing away of the upper surface, just as the accumulation of dust and sand on the rail between the passage

of consecutive trains, especially conjoined with moisture, conduces to mechanical abrasion. Price Williams has calculated from the results of various British lines that the average tonnage lives of wrought iron and Bessemer rails (*i.e.*, the traffic in tons requisite to wear away  $\frac{3}{8}$  inch of the head of the rail) are respectively close to 17½ and 161 million tons, the latter being thus more than nine times as lasting as the former.

Numerous observations have been made on the effect on the strength of iron and steel of punching and drilling holes, of notching and otherwise removing part of the surface, and of shearing, with the general result of indicating that the disturbance produced in the relative positions of the constituent particles by forcibly punching and shearing in the cold materially decreases the strength of a bar or plate (apart from the actual removal of substance); but that drilling does not effect the strength in the same way (see various papers in the *Journal I. and S. Inst., Iron, and Engineering* during the last few years). Annealing restores the strength to a considerable extent; if the plates be punched whilst red hot the annealing takes place spontaneously.

The strengthening effect upon soft steels and ingot irons of hardening by heating and plunging into oil is often very marked, the tendency to crystallinity observable in large masses of cast metal being thus largely removed. A valuable paper on the causes and effects of hardening iron and steel, by Professor Akermann, is to be found in the *Journal I. and S. Inst.*, 1879, 504; whilst the Research Committee of the Institution of Mechanical Engineers has recently issued reports containing much information on this subject.

*Effect of Temperature on the Strength of Iron and Steel.*

—Many observations on this point have been made by different experimenters, with the general result of indicating that at 0° C. and below the tensile strain and resistance to percussion of iron and steel bars, rods, &c., are substantially the same as at the average ordinary temperatures of 15° to 20°, but that what difference there is usually in the direction of diminution in strength; the numerical values obtainable are considerably variable with the composition of the metal, &c.; thus Webster finds that a severe cold of -15° C. does not affect the tensile strain of wrought iron and steel, although it slightly increases the ductility by about 1 per cent. with iron and 3 per cent. with steel; the power of resisting transverse strain is, however, some 3 per cent. lower, whilst the flexibility and the resistance to rupture by impact are reduced by the following amounts:—

	Reduction in Power of Resisting Impact.	Reduction in Flexibility.
	Per cent.	Per cent.
Wrought iron .....	3·0	18
Best cast steel .....	3·5	17
Malleable cast iron .....	4·5	15
Cast iron .....	21·0	...

A committee of engineers appointed by the Russian Government for the purpose of examining carefully into this question has recently found that, when the amount of phosphorus, silicon, and carbon in Bessemer and Siemens-Martin steel rails exceeds jointly about 0·54 (varying from 0·44 to 0·67) per cent., the rails are decidedly more brittle at temperatures near to -20° C. than at the ordinary temperature (+10° to 20°); whilst the effect of low temperature in producing brittleness is not marked when the phosphorus, silicon, and carbon jointly amount to only about 0·41 (0·37 to 0·55) per cent. Expressing the amounts of non-metals on the scale proposed by Dudley (3 parts of carbon, 2 of silicon, and 1 of phosphorus being considered as equivalent to one another, so that a rail containing carbon = 0·30, silicon = 0·20, phosphorus = 0·05, would be equivalent to one containing phosphorus = 0·25), these results may be expressed as follows: when the percentages of carbon, silicon, and phosphorus are jointly equivalent to an average of 0·19 per cent. of phosphorus, the effect of low temperatures is not marked; but when they are equivalent to an average of 0·31 per cent. of phosphorus, the rails are more brittle at temperatures near -20° than at ordinary average temperatures near to +15°.

Breakages of axles, crankshafts, pumprods, &c., exposed to atrans and vibration appear to be more common in frosty weather than at other seasons of the year; it is considered by many that exposure to vibration, &c., and low temperature simultaneously tend to diminish tenacity and set up a brittle structure in a way not observed when only one of the two causes alone acts; direct evidence on this point is, however, wanting. It is noticeable that large masses of cast metal (cast iron, true steel, or ingot metal) if cooled too quickly are apt to have the internal portions in a high state of tension or strain; for the outer portion, when solidified, prevents the contraction taking place that would otherwise ensue during the solidification and cooling of the inner portion; hence the amount of extra strain requisite to produce rupture is much diminished, so that the want of elasticity of bearings, foundations, &c., connected with the almost rigid ground during hard frosts in certain cases causes the strain applied during use to exceed the reduced amount which the metal can then bear without fracture. Chilled castings, case hardened iron, and tempered steel, moreover, are affected by low temperatures in another way; the outer harder portions do not expand at exactly the same rate as the inner softer parts; and consequently alteration of temperature produces such variations in the internal strain as in some cases to lead to fracture either spontaneously or by the superaddition of the strain due to ordinary use. On the whole it appears that no clear evidence is as yet extant proving that vibration either alone or concurrently with low temperature does actually cause a brittle crystalline structure to be developed; whilst on the other hand thousands of examples are extant of axles, engine beams, connecting rods, tires, girders, &c., continually subjected to vibration, percussive action, and varying strains of all kinds for years, in which no such development of brittleness has taken place; in those cases in which fracture has been thus brought about, the probability is that defective workmanship and the development of internal strain are the true causes of the rupture, and not a gradual alteration in texture.

At 300° to 350° soft irons and steels become much deteriorated in power to resist percussive action and bending strains, whilst at lower temperatures and at a red heat this peculiar comparative rottenness is not marked. Phosphorized iron appears to be affected to a greater extent than purer varieties, but mild Bessemer and Siemens-Martin steels are by no means exempt from the deteriorating influence. A railway wheel that has become heated through the grease-box taking fire by friction rapidly fired guns, and tools that become much heated in use, &c., may readily attain to a temperature sufficiently high to be much less capable of resisting strain than when cool. A large number of experiments on this and allied points are described by Adamson, *Journal I. and S. Inst.*, 1878, 383 and 1879, 30.

Closely akin to the comparative brittleness developed in iron and steel on the one hand by interspersed films of cinder, and by the presence of phosphorus, &c., and on the other by temperature, is the phenomenon which gives rise to the production by over-heating of what is termed "burnt iron"; according to some the want of strength of burnt iron and steel is due to the formation of oxide disseminated through the mass as cinder is through weld iron, this oxide coating the constituent particles and preventing their adhesion to one another; others, however, wholly dissent from this view. Caron (*Comptes Rendus*, March 4, 1872) has shown that by simply strongly igniting good qualities of malleable iron either in a smith's forge, or in porcelain tubes in an atmosphere of hydrogen or of nitrogen, the "burnt" crystalline structure can be developed under circumstances where no oxidation can occur. Akermann also has been led to the same conclusion, defining "burnt" iron as "iron which, through too long continued or strong heating, has had the opportunity of assuming a crystalline texture, with the brittleness which accompanies it on account of the diminished cohesion of the crystals."

44. *Foundry Operations.*—Occasionally for rough castings, such as tuyere nozzles, &c., the pig iron is used as it comes from the blast furnace, a small side channel leading off a portion of the molten pig flowing to the sand bed containing the pig moulds (§ 16) to some other convenient part of the bed in which the moulds have been prepared; but much more frequently the iron employed for castings is remelted by the founder in a cupola furnace, various kinds of pig being intermixed together according to circumstances. A reverberatory furnace is preferable to a cupola, the metal being less altered by oxidation; but a much greater consumption of fuel is thus occasioned. A very coarse grained iron, No. 1, will, on remelting and running into small moulds, give a much finer grain than the original pig; whilst, on the other hand, a large massive casting which takes a long time to solidify would, if of the same metal, develop a large grain like that of the original pig.



To obtain just the right grain under any given circumstances requires an amount of special knowledge and experience of a peculiar kind only to be gained in the foundry itself, the mixture of brands that answer well for a certain kind of casting not being necessarily at all suitable for one of different size; different mixtures, moreover, are apt to differ more or less in the amount of contraction taking place in solidifying and cooling, so that a somewhat different allowance for shrinkage must be made in different cases; as a rule the moulds are made about 1 per cent. larger in each direction than the casting is intended to measure (one-eighth inch to the foot).<sup>1</sup>

For complex forms, a number of different pieces are required to make up the whole mould, each piece being a metal box or "flask" containing sand mixed with charcoal powder, loam, or similar materials somewhat varying in their nature according to the character of the casting, moistened so as just to cohere together and enable the outline of the casting to be defined by the surface of the mixture. The "pattern" or model being placed in a suitable position, the flasks are separately moulded to the variously shaped parts, and then set up (being bolted or otherwise fixed together) so as to enclose a space shaped precisely to the pattern; the molten metal being then allowed to run into this space, by tapping the cupola and letting the fluid iron pass along a runner or gutter on the sand bed floor of the casting house, gradually fills it up, the scoria floating on the top; the air which previously filled the mould passes away through orifices left for the purpose, along with steam and gases formed by the action of the hot metal on the materials of the mould. To ensure the casting being free from scoria, and to give sufficient hydrostatic pressure to enable the impression to be sharp, the liquid metal is allowed to rise to some little height above the top of the casting by making the highest part of the cavity of the mould to be some inches or more below the surface of the floor, so that the metal fills up the tubular hollow above the mould thus formed, making a projection ("gate" or "git") above the top of the casting; this is ultimately detached by a hammer or chisel, as are also the ridges formed where the different flasks meet, and any similar protuberances at places where a little of the sand has fallen away from the surface of the mould, thus increasing the dimensions of the cavity at such places.

More simple forms are cast in moulds prepared with a smaller number of flasks, two often sufficing, or for some purposes one only; machinery is employed for moulding such objects as gas pipes, railway chairs, &c., required in large quantities. For certain purposes metal moulds are used, or combinations of metal and sand moulds; owing to the greater conducting power, the iron in contact with the metallic parts of the mould is rapidly solidified; a peculiar hardness is thus communicated to the casting, which is then termed a "chilled" casting. For the best qualities of chills certain particular classes of pig are requisite; thus for the cast iron car wheels used largely in America the brands of pig preferred are certain kinds of cold blast charcoal brown hematite or specular iron; iron smelted from the pure magnetites of Lake Champlain does not chill in the required way so as to produce an outer film of white iron constituting the "tread" of the wheel, passing into a mottled iron with a soft grey inner centre, thus combining the maximum of strength with a hard wearing face. The peculiarity of some of the American cast iron in this respect enables machinery of certain kinds to be constructed in part of that kind of metal with a strength difficult if not impracticable to obtain with the same weight of metal from most British brands. In order to produce the chilling effect a cast iron ring is imbedded in the sand mould so as to embrace the circumference of the wheel to be cast; the metal is consequently rapidly solidified in contact with the iron ring, the "chill," or portion solidified as white iron, penetrating inwards some 0.75 inch. It is found that confining the chill to the middle portion of the outer circumference only, and not communicating it to the entire flange and the opposite outer portion of the external surface, gives greater strength without diminishing the resistance to wear; this is effected by narrowing the cast iron chilling ring.

*Casting under Pressure.*—During the solidification of iron, and especially of steel, after running into moulds, bubbles of gas are often extruded, causing the substances to become vesicular and honeycombed, especially at the upper portion; the gas thus evolved from Bessemer metal was found by Bessemer and Henry to be almost entirely

carbon oxide;<sup>2</sup> on casting in a mould from which the air was rapidly pumped out, ebullition was set up, owing to the rapid evolution of gas, just as ordinary spring water apparently boils under the exhausted receiver of an air pump. Three methods of overcoming this practical difficulty of vesicular structure being set up have been used. The first, or "dead melting," applied to cast crucible steel, is simply to allow the crucibles to stand for some time in the furnace with the molten metal in them before casting; in this way the iron oxide disseminated through the mass is acted upon by the carbon, and this source of gases eliminated; according to Bessemer, silicon is also introduced (by the action of the metal on the pot-material), the presence of which retards or stops altogether the gas evolution (see § 33). The second method is the application of this principle in a more direct way by adding silicious pig, preferably as silicious spiegeleisen (silico-manganese), to the fused metal; this process has been long used on the Continent in one form or another by steel-makers who have attained a high reputation for their cast steel products, e.g., in Krupp's works, at Terre Noire, &c. The third method is one which prevents the formation of bubbles of gas by mechanical means, the fluid metal being subjected to powerful compression during its solidification. In 1856 a patent for this was taken out by Bessemer, the mould being closed by a strong cover and hydraulic power employed to force inwards a stout wrought iron plunger; Whitworth's system of casting "compressed steel" is a more perfect development of this notion.

Other methods of arriving at the same end have been also suggested, the pressure being derived either from the admission of high pressure steam on the top of the ingot mould, or by the generation of gases by the heat of the metal introduced on some chemical composition in the upper part of the closed mould; thus by employing a mixture of nitre and coal dust, the mould being closed by a screw plug and strongly bound round to strengthen it, a high pressure can be excited, regulated by varying the amount of mixture used in the first instance. A description of the steam process as employed at the Edger Thomson Works, Pittsburg, is given by H. R. Jones in the *Journal I. and S. Inst.*, 1879, 477; it appears to be simple and inexpensive as compared with the Whitworth hydraulic arrangements, but generates far less pressure,<sup>3</sup> Whitworth steel being compressed by forces up to 6 to 9 tons per square inch; increasing the pressure up to 20 tons produces little or no further effect, but, *caloris paribus*, the ductility of the compressed metal increases with the pressure used when below some 6 tons per square inch. According to Enveret, no practically valuable results were obtained at Terre Noire nor at St Etienne by the application of intense pressure to the open-hearth steels there made,—indicating probably that the removal of gas bubbles effected by Whitworth's operation in crucible steel is accomplished chemically in soft so-called steels of low carbonization made with silico-manganese.

The *modus operandi* of pressure in consolidating steel during casting appears from Bessemer's observations as to the more copious evolution of gas on diminishing pressure to be simply the application of the well-known law of increased solubility of gas in any given medium with increased pressure; under high pressure the fluid metal retains the gas dissolved just as soda water does the carbon dioxide whilst it remains in bottle; but, just as effervescence is produced in this latter case as soon as the pressure is relieved, so in the case of steel would gas bubbles appear under the ordinary pressure which would not have been developed under high pressure. It is, however, somewhat difficult to understand why steel should retain hydrogen and carbon oxide dissolved when at a high temperature and perfectly fluid, and should extrude it on cooling somewhat and when just on the point of solidifying; but the phenomenon is not an isolated one, fused silver behaving in precisely the same way towards oxygen, and thus giving rise to the well-known "spitting" of silver during solidification. The function of silicon in preventing the extrusion of gas may be ascribed either to its communicating the physical peculiarity to the steel of dissolving as much

<sup>1</sup> Wrightson has recently made some interesting observations on the variation in the volume occupied by a given mass of molten cast iron during solidification and subsequent cooling; see *Journal I. and S. Inst.*, 1279, 418, and 1880.

<sup>2</sup> Müller has recently found hydrogen to be the chief constituent of the gases contained in the bubbles found in ordinary solid cast steels, along with nitrogen, and much smaller quantities of carbon oxide than those found by Henry.

<sup>3</sup> Recent experiments made in England with Bessemer ingots have indicated that no appreciable diminution in honeycombing is brought about by the use of steam at only 40 or 50 lb pressure per square inch.

gas at the solidifying temperature as at the higher temperature, and consequently of preventing the separation of gas during solidification; or else to its chemical reaction upon the dissolved carbon oxide forming particles of silica disseminated through the mass and setting free carbon, so that the metal containing less dissolved carbon oxide can thus retain more hydrogen; experimental evidence is wanting finally to decide the question, but the latter view seems to be highly probable.

45. *Protection of Iron from Oxidation by Surface Appliances.*—One of the greatest inconveniences in connexion with the use of iron and steel for constructive and general purposes is the tendency of the metal to oxidize and rust in the air under ordinary atmospheric conditions, *i.e.*, in presence of free oxygen together with moisture and small quantities of carbon dioxide (and in the case of the air of seaside places of saline spray, and in that of coal-consuming districts of sulphur acids, &c.). Highly polished iron can be kept in perfectly dry air without rusting at all; and in contact with a solution of an alkali, such as caustic soda or ordinary carbonate of soda, the tendency to oxidize is far less than in simple spring water, sea-water, or moist air; in certain cases this property may be utilized for the preservation of bright steel objects kept in stock, a coating of ordinary whitewash (chalk and water, or preferably lime and water) being brushed over them and allowed to dry on; a similar coating of lime or whiting and oil is even more efficacious, especially if the oil be a non-drying one, *i.e.*, one that does not spontaneously take up oxygen and become more or less acidified. Protective coatings of paints of various kinds—tar, melted pitch, &c.—are generally applied to the exterior of large iron constructions, such as bridges, pillars, girders, rainwater spouts and conduits, railings, and the like; the function of these is more mechanical than chemical, the coating simply preventing the metal from coming in contact with the oxidizing medium; but in some of the paints used the basic character of certain of the materials probably also diminishes the tendency to oxidation. In certain cases the corrosion of iron can be diminished by placing a more active metal in contact with it (*e.g.*, zinc), so that by a galvanic action the oxidation is largely limited to the zinc; by causing the surface of the iron to be closely adherent to the protecting zinc coating (by dipping the brightened metal in fused zinc), a sort of permanent metallic paint coating is obtained, which acts as a preservative in the threefold manner of mechanically preventing contact with air, of galvanically confining the oxidation to the zinc, and of chemically causing the iron to be coated with a basic film of zinc oxide (when the zinc has become slightly oxidized).

Many other metallic protective coatings can be similarly applied. Of these the most frequently employed is tin, forming ordinary "tinplate," the manufacture of which dates back a considerable length of time. Other coatings can also be applied by means of electricity, at least to small articles; electro-coppered iron goods and nickelized steel articles thus prepared are now frequently manufactured.

It has long been noticed that iron bars, plates, &c., from the forge or rolling mill are coated externally with a film of magnetic oxide formed by the action of the air on the heated metal; during rolling this film becomes somewhat thick and peels off, forming "mill-scale"; when the film is but thin and is closely adherent, it has long been known that the metal does not rust so readily at the parts thus covered up with a protective coating as at points where this coating is removed. Similarly it has been long known that certain natural forms of magnetic oxide of iron, and in particular the "iron sands" of New Zealand, Canada, and elsewhere possess the power of resisting the rusting action of sea-water and atmospheric air cojoined. The idea of purposely coating iron articles with a film of magnetic oxide prepared in such a way as to resist to the greatest possible extent natural peroxidation, and so closely adherent to the underlying metal as not to be readily detached by ordinary usage, has accordingly been successfully carried out in practice by more than one person. *Barff's process* for producing such a coating is based on the reaction occurring between iron and steam at moderately elevated temperatures, *viz.*,

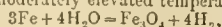

hydrogen and magnetic oxide being produced; the articles to be

protected, having first been worked into shape, are placed inside a large muffle or chamber of brick heated to a suitable temperature (400° to 600° C.), and subjected to the action of superheated steam for a period of from five to ten hours according to the thickness of the coating required. *Bowser's process* consists in the exposure of the iron articles to be protected to the action of air and carbon dioxide in a chamber or retort heated externally and capable of being closed air-tight; when hot, air is blown in from time to time so as to produce a thin coating of oxide on the surface. A modification of the process consists in alternately oxidizing and reducing the surface, the fuel being burnt inside the chamber; heated air, in excess of that requisite for the combustion, is introduced, and the surface oxidized, so that the outer film is peroxide, magnetic oxide underlying; by shutting off the air supply for a short time the peroxide is reduced and a uniform film of adherent magnetic oxide produced. Both processes can be so worked as to give a highly protective coating to the iron, so that the articles treated will resist ordinary atmospheric influences for long periods of time. The chief weak point in each case (excluding the question of cost) is that it is impossible to apply any amount of force to the treated articles without cracking or stripping off chips of the coating, so that protected iron articles cannot be hammered, rivetted together, bent, or otherwise subjected to mechanical strains, but must be worked to the dimensions and shape (however large) that are ultimately required before treatment; hence the processes become too costly for large girders, &c.

*Tin and Terne Plates.*—In order to protect thin iron plates from oxidation and to enable them to be readily soldered together so as to manufacture the numerous articles in ordinary use made by the "whitesmith" or "tin-man," they are coated over with a closely adherent layer of metallic tin, forming *tinplate*; when instead of pure tin an alloy of tin and lead is used as a protective coating, the product is known as *terneplate*. The charcoal plates (§ 23) prepared from a good quality of iron used for the tinning process and properly annealed are thoroughly scoured with sand and water and "pickled" in dilute sulphuric acid alternately until perfectly clean and bright; they are then washed and immersed in a pan full of melted grease until all adherent water has boiled away, and dipped into a bath of melted tin (covered with grease to prevent oxidation) which adheres to the surface more or less completely; the first bath is of less pure tin than that contained in a second into which the plate is further dipped so as to complete the coating; the plate is then taken out, and wiped with a hempen rubber to remove superfluous tin and make sure that the surface is completely covered, and dipped for a third time into another bath, after which it is placed in a grease bath of tallow and palm oil at a moderately high temperature, so that the surplus tin may run off, and then into a cooler grease bath to avoid too sudden chilling, which would impair the face of the coating, and finally taken out and cooled in the air. As the tin in the third bath becomes alloyed with iron from the operation, it is removed into the second, fresh pure tin being used instead; similarly the metal from No. 2 bath is by and by removed to supply the first one, so that the plate is covered with less and less ferruginous tin successively as it passes through the three baths. For *terne plates* the process is much the same, only an alloy of about half tin and half lead is used instead of pure tin; in consequence, the surface produced is not so brilliant.

When tin plates are partially etched by dilute aqua fortis mixed with common salt or sal ammoniac, they acquire a peculiar spangled appearance, owing to the dissolving away of adherent tin, leaving behind a less readily attacked crystalline tin-iron alloy; the "moiré métallique" thus prepared, after varnishing to prevent oxidation, is frequently used for ornamental purposes.

*Galvanized Iron.*—When perfectly cleansed iron is immersed in melted zinc instead of tin, the zinc adheres to the surface just as tin does in the tinplate manufacture, forming "galvanized iron," the name being derived from the circumstance that the coating is analogous to that producible by electrical means. Norwood and Rogers apply a thin coating of metallic tin to the iron before dipping it in the zinc bath, by putting in a wooden tank alternately granulated zinc and the cleaned iron plates, the tank containing a dilute solution of chloride of tin, so that the tin is deposited by a kind of galvanic action.

By the ordinary processes of electroplating manufactured iron and steel goods can be covered over with protective coatings of other metals, notably copper and nickel. Similarly by various processes silver and gold coatings can be laid on, especially by means of the application of mercurial solutions of the precious metals (water gilding), the mercury being volatilized by heat and the residual gold or silver made more adherent by burnishing, the process being repeated several times if necessary. "Pyrosilver" goods are prepared by heating the silvered steel whereby the silver sinks, as it were, into the metal; successive coatings are then applied and "burnt in," until the siakage ceases; in this way a coating is obtained not readily detachable by wear and tear. Protective coatings of various forms of enamel are often employed for various classes of iron goods, more especially advertisement boards, *i.e.*, sheets of enamelled iron



with the lettering done in some differently coloured enamel. A modification of this class of coating has been recently introduced by Dodd, metallic platinum being mixed with the enamelling composition so as to "platinize" the metal and thus add to the durability; according to the inventor, the comparatively high price of platinum does not interfere with the applicability of the process, one platinizing application costing no more than three coats of good paint, and only about a tenth of the expense of nickelizing.

X. STATISTICS OF THE IRON AND STEEL MANUFACTURE.

46.—The following data are abridged from the *Journal of the Iron and Steel Institute, 1880.*

Production of Iron Ore in different Countries (in Thousands of Tons).

	In 1872.	In 1877-79.
Great Britain .....	14,371	1879 .....14,300
United States, estimated .....	6,500	" ..... 7,200
Germany .....	4,846	1878 ..... 5,822
France .....	2,574	1879 } 3,500
Austria .....	1,157	" ..... 1,079
Sweden .....	733	1878 ..... 677
Italy .....	167	1877 ..... 248
Spain (Bilbao) .....	423	1878 ..... 1,118
Russia .....	894	" ..... 897
Luxembourg .....	1,171	" ..... 1,613
Africa (Algeria) .....	320	" ..... 400
Belgium .....	750	1877 ..... 340
Canada .....	...	1879 ..... 30
Australia, estimated .....	...	" ..... 15
Japan do. ....	...	" ..... 25
Turkey do. ....	...	" ..... 150
India do. ....	...	" ..... 30
Mexico do. ....	...	" ..... 20
	33,906	37,434

Production of Pig Iron and Steel in different Countries (in Thousands of Tons).

	Pig Iron.	Bessemer Steel.	Open Hearth Steel.	Crucible, Puddled, and German Steels.
	1877-79.	1879.	1878.	1879.
Great Britain.....	1879 5,995	835	175	3.5
United States.....	" 3,071	929	50	62
France .....	" 1,345	303	72	35
Belgium .....	" 494	155	...	...
Germany and Luxembourg... }	" 2,136	460	65	133
Austria-Hungary...	" 469	110	25	16
Russia .....	1878... 410	54	22	(1878) 4.0
Sweden .....	" 333	19	...	(1878) 3.0
Italy .....	1877... 45	...	...	2.9
Canada .....	1879... 22.5	...	...	...
Mexico .....	1877... 7.5	...	...	...
Australia .....	" 2.6	...	...	...
Japan .....	" 7.4	...	...	...
India .....	" 12.5	...	...	...
Africa .....	" 12	...	...	...
Turkey .....	" 4.3	...	...	...
Switzerland .....	" 6.5	...	...	0.3
	14,373.3	2,865	409	261.2

Position of Pig Iron Trade.

	Country	Number of Furnaces Built.	Number of Furnaces in Blast.	Tons of Pig Iron Produced.	Tons of Pig made per Furnace at Week.
		1876	Austria .....	279	166
1877	Belgium .....	61	26	425,200	16,353
1877	France.....	464	270	1,217,838	4,510
1876	Germany.....	463	297	1,846,345	6,216
1878	Great Britain .....	948	498	6,381,351	12,813
1876	Sweden .....	325	224	350,541	1,560
1878	United States .....	692	257	2,577,361	10,028
		3,232	1,738	13,198,762	

Position of Bessemer Steel and Open Hearth Steel Trade.

	Bessemer.		Total Capacity (in Thousands of Tons).	Open Hearth.	
	Converters erected.	Additional ones being built (1880).		Number of Furnaces erected and in course of erection (1880).	Estimated Capacity (in Thousands of Tons).
Great Britain ..	104	11	1461	129	481
United States ..	24	10	500	39	275
Germany .....	80	8	1564	42	150
France .....	24	0	632	47	110
Russia .....	10	..	100	23	76
Austria .....	32	2	350	(1879) 15	?
Belgium .....	14	6	380	(1879) 2	?
Sweden .....	35	...	80	...	...
	323	47	6067	297	Upwards of 1092

Total Steel Production (in Thousands of Tons).

	1872.	1879.	Increase.	Increase per Annum
Bessemer steel .....	780	9864	2084	298
Open hearth steel .....	82	409	327	47
Crucible and other steels	217	267	50	7
	1079	3540	2461	352

The following table, abridged from Hunt's *Mineral Statistics of the United Kingdom*, illustrates the gradual increase of the pig iron manufacture in Great Britain during the last twenty years or so:—

	Furnaces in Blast.	Make of Pig (in Thousands of Tons).	Average Annual Make per Furnace (in Thousands of Tons).
1860	582	3827	6.6
1866	618	4564	7.4
1868	560	4970	8.9
1870	664	5962	9.0
1872	702	6742	9.6
1874	649	5991	9.2
1875	629	6365	10.1
1876	585	6506	11.1
1877	541	6609	12.2
1878	498	6381	12.8

The following table, abridged from the *Statistical Report of the British Iron Trade Association*, gives compendiously a synoptical view of the iron and steel trade of the United Kingdom in 1878 and 1879:—

	1879.	1878.
British output of iron ore (in thousands of tons)...	14,300	15,726
Cleveland .....	4,714	5,605
Imports of ore {		1069
" From Spain .....	...	49
" Italy .....	...	13
" Norway .....	...	1.0
" Turkey .....	...	3.2
" Russia .....	...	8.1
Exports of ore .....	50	1163.3
British production of pig iron .....	5,995	...
Exports .....	2,886	...
Home consumption.....	3,309	...
Stocks in hand December 31, 1879 ..	1,025	...
Blast furnaces existing December 31, 1879.....	931	...
Average make per furnace per annum (in thousands of tons) .....	12.1	...
Average coal used per ton of pig .....	44 cwt.	...
Aggregate production of Bessemer steel (in thousands of tons) }	636	819
Do. open hearth steel .....	175	...
Number of Bessemer works in operation .....	20	...
Average production per converter (in thousands of tons) .....	16.8	...
Number of new converters being erected .....	11	...
" Siemens open hearth furnaces at work .....	102	...
Bessemer steel rails .....	520	633
Open hearth .....	30	...
Iron vessels launched, tonnage .....	273	325
Steel .....	12.5	...
" building .....	40	...

In America, which comes next to Great Britain in amount of pig iron production, and slightly exceeds that country in make of steel, the following figures illustrate the production of pig iron during the last twenty-five years (in thousands of tons of 2000 lb each):—

	Anthracite.	Charcoal.	Bituminous.	Total.
1854	339	342	54	736
1858	361	285	58	704
1862	470	187	131	788
1866	749	333	268	1350
1870	930	365	570	1865
1873	1313	578	978	2869
1876	795	309	990	2094
1879	1273	359	439	3071

The following list of American iron and steel works is abridged from the *Directory of the Iron-Works of the United States*, April 15, 1880:—

Completed blast furnaces, March 1, 1880 ...	{ Bituminous .....	203
	{ Anthracite .....	228
	{ Charcoal .....	266
		697
Blast furnaces building, ..	{ Bituminous .....	23
	{ Anthracite .....	12
	{ Charcoal .....	9
		44
Annual capacity of completed furnaces (in thousands of tons).....		6800
Completed rolling mills and steel works, March 1, 1880 .....		382
Rolling mills building .....		10
Single puddling furnaces (double ones counting as two).....		4467
Heating furnaces .....		2419
Trains of rolls .....		1397
Annual capacity of rolling mills (in thousands of tons) .....		4000
rail mills .....		2150
Completed Bessemer steel works, March 1, 1880 (2 more building) ...		11
converters ..	10	82
Open hearth steel works ..	9	22
furnaces ..	6	33
Crucible cast steel works ..	3	35
Forges for making iron direct from ore, March 1, 1880 ..		69
Bloomsaires ..	(1 more building)	59
Annual capacity (in thousands of tons)...	{ Forges .....	85
	{ Bloomsaires.....	80
		165

The present position of the iron and steel trade generally as compared with that at a period of some quarter of a century ago, may be put in a few sentences thus. An enormous increase in the production of iron and steel from natural sources has occurred; not only have the older iron-producing countries, as a rule, shared

largely in this increase, but further, in many countries and districts where the amount of iron production was formerly little more than a nominal amount or even absolutely nil, the manufacture has now attained to notable dimensions, whilst there is every prospect of this increase in production continuing, notwithstanding the great fluctuations in trade experienced from time to time in particular districts. This is mainly due to the vastly increased use of iron and steel (or so-called steel=fused iron of a low degree of carbonization) for constructive and other general purposes, and especially to the introduction of the peculiar melted products obtained from pig iron by means of Bessemer's blowing process conjoined with Mushet's spiegeleisen-addition improvement; by Siemens's open-hearth "steel" making process involving the use of gaseous fuel and the regenerative principle; or by various modifications of these methods, such as the Snelus-Thomas-Gilchrist process, by means of which phosphorus is removed to a large extent from the pig iron whilst undergoing decarbonization. By this and various other allied devices, the production of useful kinds of so called "steels" from impure ores, which till recently could only be utilized for inferior cast and wrought iron production, has become possible. On the other hand the increasing use of fused "steels," prepared by various of these methods for many purposes for which wrought iron was exclusively used some quarter of a century ago, has stimulated the wrought iron department, and has in consequence caused the invention of numerous machines for diminishing the cost and increasing the output of puddled iron, and for effecting a greater degree of purification than hand puddling ordinarily produces. Notwithstanding these advances, however, it is evident that the weld iron industry is by no means increasing in magnitude as rapidly as the ingot metal manufacture. So evident is the disparity that it is believed by many competent judges that puddled metal will in a longer or shorter time become practically a thing of the past, and that ingot metal will almost wholly take its place,—especially when the advantages of the latter as regards physical qualities and cheapness of production have become more extensively appreciated. (C. R. A. W.)

**IRON, THERAPEUTIC USES OF.** The use of iron in the cure of disease dates from a very early period. Pliny speaks of its medicinal effects, and there is reason for believing that it was administered several centuries before his time. But Sydenham was the first to point out its most important therapeutic property, its blood-restoring power. "To the worn out and languid blood," he says, "it gives a spur or flip whereby the animal spirits which before lay prostrate or snuk under their own weight are roused and excited."

The blood is composed of a fluid wherein float roundish red bodies, the blood corpuscles, which play a leading part in those tissue changes essential to life. Each corpuscle consists of a stroma permeated by a red fluid, hæmoglobin, which has the remarkable property of readily combining with either oxygen or carbonic acid, but so loosely that under slightly altered conditions these gases are as readily separated from it. In the lungs the corpuscles, through their hæmoglobin, take up oxygen which they carry to all parts of the body. But in the presence of the vital processes of disintegration and repair constantly going on in the tissues, the corpuscles yield up the oxygen they have brought, and supply an element necessary for these processes. Having got rid of the oxygen, the hæmoglobin then unites with the carbonic acid produced by tissue disintegration, and the corpuscles thus reladen carry their burden back to the lungs, and discharge there the carbonic acid,

taking up anew a supply of oxygen. If the hæmoglobin of the blood fall below a certain standard, the supply of oxygen necessary to healthy tissue changes in brain, nerve, muscle, &c., becomes too limited, and the changes will be imperfectly performed; hence defective vitality, general or local. Now the ingestion of iron increases the hæmoglobin supply when it is defective; it promotes the production of blood corpuscles, and causes each corpuscle to carry with it more hæmoglobin; hence the health-giving power possessed by this metal. The exact method in which the increase in red colouring matter is brought about we do not know, but in the fact that iron forms an essential constituent of hæmoglobin we have some clue to its utility.

Anæmia or spanæmia is the name given to that condition in which the red colouring matter of the blood is below the normal amount. It is indicated by pallor of skin and mucous membranes, and by a depressed condition of brain, of muscle, and of the tissues generally. A beating headache is often present, sustained mental or physical exertion is difficult, palpitation and breathlessness are sources of inconvenience; in the female the uterine functions are often in abeyance. By a chalybeate course we can usually restore to the blood its due supply of hæmoglobin, and cause the gradual disappearance of all these symptoms.

It would be impossible here to enumerate all the special forms of spanæmia in which iron is prescribed. It will be sufficient to point



out the leading conditions under which it may be given with every hope of advantage, and those in which it usually fails to do good. First of all, it is of marked benefit in the spanæmia of young females, which is often accompanied by a faint greenish or yellowish discoloration of the skin. Chlorosis is the name usually given to this condition. Here iron almost unfailingly though slowly removes the pallor, breathlessness, and palpitation, increases mental and physical vigour, and restores the uterine functions. Where the blood has been impoverished by hæmorrhages, want of proper food, or exposure to bad hygienic conditions, iron rarely fails to improve its character, provided the causes of such impoverishment are removed. In convalescence from many illnesses, iron is employed with advantage, and it aids recovery from such constitutional diseases as rickets and scrofula by its restorative effect on the blood, sometimes too in syphilitic cachexia it is of service. On the other hand, in the obscure disease called pernicious anæmia, the cause of which is so far unknown, but in which the deficiency of hæmoglobin is extreme, iron is rarely even of temporary service. It is generally useless too in the spanæmia attendant on advancing consumption where the temperature is high; some physicians indeed hold that in such cases it is injurious, because it increases temperature. In chronic diseases leading to spanæmia, where the cause of the poverty of blood is continuously present, iron is often of but little service. Such is the case in cancer and most of those emaciating ailments which tend naturally to a lethal termination. But in valvular disease of the heart, iron though not curative often helps to prolong life and relieve suffering, for by enriching the blood it spares the heart some of its labour, and at the same time strengthens the cardiac walls. In Bright's disease too, which is often accompanied with bloodlessness, iron is a most valuable medicine in prolonging life even though incapable of saving it.

Hitherto we have spoken of iron only in its capacity of a strengthening agent acting through its power of stimulating the production of hæmoglobin, but it may be beneficial in other ways. It is supposed to augment the production in the blood of that active oxidizing agent ozone, but of this we have little or no proof; there is, however, considerable probability that the iron which exists as an albuminate in the blood serum has some direct tonic effect on the tissues through which it circulates; and the astringent preparations, such as the sulphate, are most effective in bracing the gastro-intestinal mucous membrane when it is relaxed.

Iron is of use in some diseases of special organs and systems, partly perhaps from its general tonic effect, but in part too no doubt from some local nutritive action which it has. In neuralgia, for example, it is sometimes curative, more certainly so, however, if combined with quinine. In chorea, or St Vitus's dance, too, it is of value, especially when combined with arsenic. On the digestive organs chalybeates have at times a good effect, some forms of dyspepsia and diarrhoea being favourably influenced by them. Iron too is of service often in the nocturnal incontinence of children, and is often given as an emmenagogue. In gout, plethoria, and most febrile ailments, the administration of iron is usually held to be injurious, but in erysipelas the administration of half drachm doses of the tincture of the perchloride of iron every four hours has been highly lauded, and Dr Russell Reynolds advocates the use of similar doses in acute rheumatism. Iron is valued for the astringent effects of some of its preparations on parts with which they come in contact, as well as for its good effects on the blood and various organs after ingestion.

The tincture of perchloride of iron is used as a styptic to stop bleeding from the gums or from leech bites, or other slight hæmorrhages. Sometimes too it is of service locally applied in bleeding of a more serious character, but it is a strong irritant to the parts with which it comes in contact. One part of the tincture of the perchloride mixed with three of water is sometimes injected up the nostril to check persistent nose bleeding. Lint moistened with the tincture is also used as a plug for the same purpose. For stopping hæmorrhage after confinement, the plan introduced by Dr Barnes of injecting a solution of perchloride of iron into the uterus is frequently followed with the greatest advantage. The perchloride and sulphate of iron may be given to check hæmorrhage from the stomach, and these salts have likewise been used to decrease the discharge in gonorrhoea and leucorrhœa. The local application of the tincture of perchloride of iron in diphtheria has been highly recommended, and a very dilute solution is sometimes used as a rectal injection to destroy thread-worms.

As a medicine iron is used in many forms and combinations, and thirty-three of these are described in the *British Pharmacopœia*. The metal itself, finely divided, is often administered in 1 or 2 grain doses,—ferrum redactum the preparation is called,—and lozenges are made of it, each containing 1 grain of reduced iron. The vinum ferri or solution of iron in wine is probably the most ancient of all iron preparations. Of the oxides, the peroxide and the magnetic oxide are officinal. The former was in early times known under the name of saffron or crocus of iron, and was much used; but now more soluble preparations of iron are usually prescribed. Recently precipitated peroxide in a moist condition is one

of the best antidotes for arsenical poisoning if given in quarter to half ounce doses. The carbonates of iron readily undergo oxidation unless mixed with sugar, which therefore enters into all the pharmaceutical preparations of iron, the seccarated carbonate of iron, the pill of the carbonate of iron, and the compound iron mixture. Perhaps the most commonly used and the best known astringent preparations of iron are the combinations of this metal with vegetable acids, the ammonia citrate of iron and the tartrate of iron, which are given in 5 to 10 grain doses, the former too in the form of wine (vinum ferri citratis). The combination of citrate of iron and quinine is an exceedingly valuable preparation, and is given in 3 to 5 grain doses. The acetate of iron is somewhat astringent, but, though officinal, is very rarely used. The sulphate and perchloride of iron are powerful astringents, constricting the tissues with which they come in contact. Several preparations of these salts are officinal. Their use as local applications has been alluded to; internally they are given instead of the non-astringent chalybeates, when a tissue-bracing as well as a blood-restoring effect is desired. They are more constipating than the non-astringent chalybeates. The dose of the solution and tincture of perchloride of iron is from 5 to 20 minims. The sulphate is given in 1 to 3 grain doses. Iodide of iron, in the form of pill or syrup, is specially used in cases of struma. The phosphate of iron and its syrup are of the greatest value when given to weakly and rickety children.

All the above-named iron medicines are officinal. Of those not mentioned in the *Pharmacopœia*, two only need be alluded to—solution of dialysed iron, which of all preparations is perhaps the least liable to disagree with the stomach, and solution of the magnetic phosphate of iron in citric acid, commonly known as Lightfoot's steel, one of the most agreeable of the acid solutions of iron.

Many mineral waters contain iron. In most it exists as a carbonate, but in one of the springs at Harrogate as chloride. Chalybeate waters are in suitable cases the most effective of blood tonics.

Ingestion of iron in all forms causes the stools to become black. This arises from the fact that, when iron is taken, but little is absorbed; the rest passing into the intestinal canal is converted into the black sulphide by the sulphuretted hydrogen present there. The discoloration is devoid of all significance. The evil effect of iron preparations on the teeth has been much exaggerated. The acid chalybeates, if taken in a concentrated form, may indeed do harm, and all iron medicines tend to blacken the teeth somewhat, but by washing the mouth out with water after taking them the possibility of injury is readily prevented. (D. J. I.)

**IRON MASK.** The Man in the Iron Mask is the name by which a French state prisoner, whose identity has given rise to much curious inquiry, is universally known. The facts established by contemporaneous evidence respecting this mysterious personage, who died in 1703, were, until a modern writer largely added to them, neither numerous nor of very great importance.<sup>1</sup> Enough indeed is related

<sup>1</sup> Dujanca, the chief turnkey of the Bastille, whose register has fortunately been preserved, gives us this account of the captive:—"On Thursday, the 18th September 1698, at three o'clock in the afternoon, M. Saint Mars, the governor, arrived at the Bastille for the first time from the islands of Sainte Marguerite and Sainte Honnat. He brought with him in his own litter an ancient prisoner formerly under his care at Pignerol, and whose name remains untold. This prisoner was always kept masked, and was at first lodged in the Basinière tower. . . . I conducted him afterwards to the Bertandière town, and put him in a room, which, by order of M. de Saint Mars, I had furnished before his arrival." A letter of M. de Formanoir, a grand-nephew of Saint Mars, furnishes the following details:—"In 1698 M. de Saint Mars exchanged the governorship of the islands for that of the Bastille. When he set off to enter on his new office he stayed with his prisoner for a short time at Paltean, his estate. The Mask arrived in a litter which preceded that of M. de Saint Mars; they were accompanied by several men on horseback. The peasants went out to meet their seigneur. M. de Saint Mars took his meals with his prisoner, who sat with his back towards the windows of the room, which looked into the court-yard. The peasants of whom I made enquiry could not see if he had his mask on when eating; but they observed that M. de Saint Mars, who sat opposite to him at table, had a pair of pistols beside his plate. They were attended by a single valet only, Antoine Ru, who took away the dishes set down to him in an antechamber, having first carefully shut the door of the dining-room. When the prisoner crossed the court-yard a black mask was always on his face." Dujanca's journal contains this entry respecting the death of the secluded prisoner, who, it may be added, was named "M. de Marchiel" in the Bastille register:—"On Monday, the 19th of November 1703, the unknown prisoner, who had continually worn a black velvet mask, and whom M. de Saint Mars had brought with him from the island of Sainte Marguerite, died to-day at about ten o'clock in the evening, having been yesterday taken slightly ill. He had been a long time in M. de Saint Mars's hands, and his illness was exceedingly trifling."



to show that even in his lifetime the veiled prisoner had become an object of curious mystery. Other instances occur, however, of captivity under like conditions; and nothing in the treatment of the Mask proves that he was a personage of rank and importance. It has been indisputably shown that it was no uncommon practice, especially in the reign of Louis XIV., to isolate human beings and keep them immured, their very features being carefully hidden, and that the victims were persons of all conditions. Though one or two efforts had been previously made to find out the name of the unknown prisoner, Voltaire was the first writer of note to give form and life to the vague traditions that had been current about the Mask; and we may probably ascribe to his suggestive account the increased importance which since his time the subject has been supposed to possess. In his *Age of Louis XIV.* the historian hinted that the Mask was a person of high rank; and he graphically described how this mysterious being endeavoured to commune with the outer world by throwing out, on the shore of Sainte Marguerite, from the grated window of his gloomy dungeon, a piece of fine linen, and a silver plate, on which he had traced some strange characters to reveal a horrible tale of misfortune. This work was published in 1751, nearly fifty years after the death of the Mask; and from this time the problem who he was has been investigated with no little diligence. The editor of the *Philosophic Dictionary* suggested that he was an illegitimate son of Anne of Austria, born in 1626; and in 1790 he was identified, in the *Memoirs of Cardinal Richelieu* with a supposed twin brother of Louis XIV., put out of the way by the great Cardinal to avoid the ills of a disputed succession. As early as 1745 the Mask was said, by an anonymous writer, to have been the count of Vermandois, one of the bastards of Louis XIV.; in 1759 M. Lagrange-Chancel endeavoured to prove that he was the duke of Beaufort, a hero of the Fronde; a few years afterwards M. St Foix conjectured that he was the duke of Monmouth, the English pretender of 1685; and others have laboured to show that he was either a son of the Protector Cromwell, or Fouquet, the minister of Louis XIV., or Avdick, the Armenian patriarch, whose treacherous imprisonment by the ambassador of France was one of the worst acts of that unscrupulous king. The claim, finally, of Ercole Mattioli, a diplomatic agent of the duke of Mantua, was put forward in 1770, and since that time has found zealous advocates in MM. Roux-Fazillac, Delort, Topin, and in the late Lord Dover; indeed, until lately it was generally thought that Mattioli was the mysterious captive.

The claims, however, of none of these can stand the test of the searching inquiry which recent discoveries have made possible. Voltaire does not inform us who the Mask was; his hint that he was an exalted personage is at variance with a remark of his on the same subject in a later work; and as for the tale of the attempts made by the Mask to divulge his name and fate, these have been traced to a Huguenot pastor, imprisoned in the islands of Sainte Marguerite. There is no evidence that the illegitimate child of Anne of Austria, or the twin brother of Louis XIV. ever existed. Fouquet died in 1680, the count of Vermandois in 1683, and the duke of Beaufort in 1689; Monmouth fell under the axe of the headsman; Avdick was not imprisoned until 1706. The case made on behalf of Mattioli also breaks down when carefully sifted. Mattioli was certainly imprisoned at Pignerol, and that for a considerable time; he was also long under the care of Saint Mars; and he was detained at the Sainte Marguerites, in the custody of the same jailer. But on the other hand the Mask is never named in the numerous documents that refer to him; he was certainly imprisoned at Exiles; and he was brought from the Sainte Marguerites, and died in the Bastille; whereas Mattioli's name occurs not seldom in the correspondence of Saint Mars; he cannot be traced to Exiles; and it is almost certain that he died at the Sainte Marguerites in 1694.

Is it impossible, then, to fix the identity of the unknown Mask? The latest writer upon the subject is M. Jung, a French staff officer, and his diligent investigations have brought us perhaps very near the solution of the problem. He appears to have fully proved that

the prisoner of 1698—beyond question the mysterious Mask—had for many years been guarded by St Mars; that he had long been known as "your ancient prisoner," "your prisoner of twenty years standing"; and that at the Sainte Marguerites he was jealously watched with precautions nearly of the same kind as those afterwards taken at the Bastille. He has shown, moreover, that this very prisoner was, in 1687, removed to the Sainte Marguerites from Exiles, always under the eye of the same jailer, and that, too, with the care and secrecy observed in the journey to the Bastille; and, finally, he has traced the captive to Pignerol, still in the hands of the relentless St Mars, where, in 1681, we find him designated as one of the "two prisoners of the Lower Tower," apparently for some years in confinement. This prisoner, too, is never once named, which, as we have seen, was the case with the Mask. On the whole it would seem that M. Jung has established the identity of the object of our search with this unknown person. He goes, however, a great deal further, and endeavours to find out the name and the history of the prisoner of the Lower Tower of Pignerol. His theory is that he was a criminal who probably played a prominent part in one of the numerous poisoning plots which disgraced the reign of Louis XIV.; and he identifies him with a Lorraine gentleman who seems to have belonged to a murderous band of conspirators against the life of the king, and who, being then arrested at Peronne, was lodged in the Bastille in 1673, and thence taken, he makes out, to Pignerol. His narrative abounds in interest, but he has adduced no valid proof to connect the supposed prisoner captured at Peronne with the prisoner of 1673; and he has not given us anything like evidence to associate this last-named person with either of the prisoners of the Lower Tower at Pignerol, or even to show that he reached that fortress. Besides, he has not ascertained the identity of these two prisoners. The mystery of the identity of the Mask thus remains unsolved; but the field of inquiry has been greatly narrowed, and further investigation will not improbably discover this strange historical secret. (W. O. M.)

IRONTON, the chief city of Lawrence county, Ohio, is situated on the river Ohio, 142 miles south-east of Cincinnati. Occupying a central position in a productive mineral district, its chief industry, as its name suggests, is connected with iron. There are iron-furnaces, rolling and planing mills, and machine shops in the town; and stoves, boilers, nails, and other iron goods are manufactured to a considerable and yearly increasing value. Ironton was founded in June 1849 by the Ohio Iron and Coal Company, and received its city charter sixteen years later. The population in 1880 was 9000.

IRON-WOOD is the name applied to several kinds of timber, the produce of trees from different parts of the tropics, and belonging to very different natural families. Usually the wood is extremely hard, dense, and dark-coloured, and sinks in water. The true iron-wood of the East Indies and Malay archipelago, of which anchors are often made, seems to be the *Metrosideros vera* of Rumphius, a tree belonging to the *Myrtaceæ*, and formerly extensively used in China, Japan, and the Moluccas. Several species of *Sideroxylon* (*Sapotaceæ*) also yield iron-wood, *Sideroxylon cinereum* or *Bojerianum*, D. C., being the *bois de fer blanc* of Africa and Mauritius.

West Indian iron-wood is the produce of *Colubrina reclinata* and *C. ferrugina*, Ad. Br. (*Rhamnaceæ*), and of *Egiphila martinicensis*, Linn. (*Verbenaceæ*). *Izora* (*Siderodendron triflorum*, Vahl. (*Rubiaceæ*)), is the *bois de fer* of Martinique, and *Zanthoxylum Pterota*, H. B. K. (*Rutaceæ*), is the iron-wood of Jamaica, while *Robinia Ponacoco*, Anbl. (*Leguminosæ*), is described as the iron-wood of Guiana. The iron-wood of Ceylon is the produce of *Mesua ferrea*, Linn. (*Guttiferæ*). The endemic *bois de fer* of Mauritius, once frequent in the primeval woods, but now becoming very scarce, is the *Stadtmannia Sideroxylon*, D. C. (*Sapindaceæ*), while the *Cossignya pinnata*, Lam., is known as the *bois de fer de Judas*. *Coccoloba grandifolia* and *C. pubescens* (*Polygonaceæ*) yield a kind of West Indian iron-wood. *Muba burxifolia*, Pers. (*Ebenaceæ*), yields a variety of iron-wood which is used at Tavoy in Burmah to make anchors for large boats. Tasmanian iron-wood is the produce of *Notelaea ligustrina* (*Oleaceæ*), and is chiefly used for making ships' blocks. The iron-wood or lever-wood of North America is the timber of the American hop horobeam, *Ostrya virginica* (*Cupuliferæ*). In Brazil *Apuleia ferrea*, Mart., and *Cassalpinia ferrea*, Mart., yield a kind of iron-wood, called, however, the *Pao ferro* or false iron-wood.

IRRAWADDY. See IRRAWADI.



IRRIGATION is the systematic application of water to land in order to promote present or prospective vegetation. Water, thus used for the general purpose of growing or increasing the crops on which animals and man have to subsist, is employed in special ways and at special times according to the particular end in view, the individual plant to be grown, and the very divergent conditions of soil and climate which have to be studied in different countries. Sometimes the art of irrigation is practised for the simplest of all reasons, to make up for the absence or irregular seasonal distribution of rain or for a local deficiency of rainfall; sometimes a particular crop is irrigated, because the plant is of an aquatic or semi-aquatic nature; sometimes lands are irrigated for the sake of the encouragement to early growth afforded by the warmth of the water, or for the sake of the dissolved plant-food which it furnishes; and sometimes the object is that the land may be enriched and its level raised by means of the deposit from the water used.

In considering the vast importance of water to plant growth, it must be remembered that seeds must absorb a very large quantity of water before germination can begin; that the growth of the young plant, while still dependent upon the seed, involves the employment of a constant supply of water in order that the transference of nutrients from the stores in the seed to the newly developed parts may proceed without interruption; that soils which do not contain more than 5 to 9 per cent. of moisture will yield none of it to the plant, and that when such low percentages of moisture are approached there is a constant struggle—often fatal to the plant—between the soil and the plant for water; that during the period of the plant's active growth, the absorption of all mineral matter and all nitrogen compounds from the soil takes place through the medium of an exceedingly weak aqueous solution of these substances, which solution is indeed absorbed in such quantities that a single plant of barley needs the passage through it during the five months in which it occupies the ground of more than an imperial gallon of water. It should be also remembered that all vegetable produce when in a growing state contains an immense proportion of water, often 70 to 80 per cent., and sometimes as much as 92 to 96 per cent., the latter figures representing the percentage of water in turnips and watercress respectively.

From all this it will be readily understood that artificial supplies of water are needed for vegetation in many dry countries. An illustration of this need presents itself in the district which comprises parts of the south of Spain, Portugal, and Italy, including Sicily and Greece. Along this zone, which includes the Mediterranean coasts north of the rainless region of Africa, with its currents of hot dry air from the Sahara, the annual rainfall may be as high as 30 inches, but the amount during the summer quarter is but 4 per cent. of the whole. All the district suffers from droughts, which are often most severe. Again, in many parts of central and eastern Europe there are table-lands, as in Moravia, Poland, and parts of Russia, where the yearly rainfall is insufficient—from 10 to 15 inches only. There are about twice as many rainy days in western as in eastern Europe. In very many of these rainless or arid countries and districts there are remains (mostly in ruins) of important ancient irrigation works; Spain, Sicily, and Syria furnish abundant examples of aqueducts and canals for agricultural irrigation. In Egypt, and in some parts of Persia, India, and China, artificial watering is employed for the reasons given above; while in Peru and many other parts of America the same scarcity or irregular distribution of rain occurs. Special reference will be made further on to the very important irrigation works of India.

The next point to which reference has been made is the peculiar aquatic or semi-aquatic nature of some of the plants which are grown by means of artificial watering. Rice is the chief example of a plant of this kind; a rice swamp is proverbial, and wherever rice is grown in China, in India, in Japan, in Egypt, or in Italy, the land is under water till the crop is just ready for harvesting.

The third reason for irrigating mentioned above is the determining cause of nearly all the artificial watering of land in temperate climates. It is not performed because the soil is dry and hot, for it is carried out mainly in the wettest and coldest months of the year. It is not performed because the crop to be raised is of an essentially aquatic nature, for ordinary grasses and meadow herbage only are watered. But it is performed that growth may be stimulated and fed, through certain agencies which the water brings to bear upon the vegetation in question. The water-meadows of England afford examples of this kind of irrigation. These are, in some instances, of immemorial origin, and may, like those of the Avon in Wiltshire and the Churn in Gloucestershire, be traceable back to Roman times. In the early part of the present century the system received further developments, but at present there is some tendency to depreciate the value of this kind of irrigation.

A fourth reason for irrigation is found where the solid matter suspended in the water is valuable and valued for its richness as manure, and for the actual increase which its deposition on the land makes to the height or level of the country. In England this kind of irrigation is practised mainly in the estuary of the Humber. But wherever a decided deposition of fertilizing silt, clay, or mud from water allowed to rest on the land takes place, there "warping," the name given to this kind of irrigation, may be said to be practised. The waters of the overflowing Nile in Egypt act, partly at least, in this manner, for their dissolved constituents (about 10 grains per gallon) are perfectly insignificant when compared with those which are suspended.

In addition to these various kinds of irrigation with ordinary water, there are several systems in which town sewage is employed. These involve the introduction of many new and complex conditions, and may be more conveniently considered under the heading SEWAGE.

It is the irrigation determined by the third of the foregoing reasons—water-meadow irrigation—that calls for more particular notice here. The subject may be conveniently treated in the following order:—quantity of water; quality of water; influence of mining refuse on water-meadows; grasses suitable for water-meadows; changes in irrigated herbage; methods of irrigation, including (1) bedwork irrigation, (2) catchwork irrigation, (3) upward irrigation, and (4) warping; management and advantages of water-meadows; theory of irrigation of water-meadows. The article will close with some account of irrigation in India, and in Italy, France, and Belgium, and of the history of irrigation.

Before the systematic conversion of a tract into water-meadows can be safely determined on, care must be taken to have good drainage, natural or artificial, a sufficient supply of water, and water of good quality. It might indeed have been thought that thorough drainage would be unnecessary, but it must be noted that porous subsoils or efficient drains do not act merely by carrying away stagnant water which would otherwise cool the earth, incrust the surface, and retard plant growth. They cause the soil to perform the office of a filter. Thus the earth and the roots of grasses absorb the useful matters not only from the water that passes over it, but from that which passes through it. These fertilizing materials are found stored up in the soil ready for the use of the roots

of the plants. Stagnation of water is inimical to the action of the roots, and does away with the advantageous processes of flowing and percolating currents. Some of the best water-meadows in England have but a thin soil resting on gravel and flints, this constituting a most effectual system of natural drainage. The fall of the water supply must suffice for a fairly rapid current, say 10 inches or 1 foot in from 100 to 200 yards. If possible the water should be taken so far above the meadows as to have sufficient fall without damming up the river. If a dam be absolutely necessary, care must be taken so to build it as to secure the fields on both sides from possible inundation; and it should be constructed substantially, for the cost of repairing accidents to a weak dam is very serious.

¶ *Quantity of Water.*—Even were the objects of irrigation always identical, the conditions under which it is carried on are so variable as to preclude calculations of quantity. Mere making up of necessary water in drouthy seasons is one thing, protection against frost is another, while the addition of soil material is a third. Amongst causes of variation in the quantity of water needed will be its quality and temperature and rate of flow, the climate, the season, the soil, the subsoil, the artificial drainage, the slope, the aspect, and the crop. In actual practice the amount of water varies from 300 gallons per acre in the hour to no less than 28,000 gallons. Where water is used, as in dry and hot countries, simply as water, less is generally needed than in cold, damp, and northerly climates, where the higher temperature and the action of the water as manure are of more consequence. But it is necessary to be thoroughly assured of a good supply of water before laying out a water-meadow. Except in a few places where unusual dryness of soil and climate indicate the employment of water, even in small quantity, merely to avoid the consequences of drought, irrigation works are not to be commenced upon a large area, if only a part can ever be efficiently watered. The engineer must not decide upon the plan till he has gauged at different seasons the stream which has to supply the water, and has ascertained the rain-collecting area available, and the rainfall of the district, as well as the proportion of storable to percolating and evaporating water. Reservoirs for storage, or for equalizing the flow, are rarely resorted to in England; but they are of absolute necessity in those countries in which it is just when there is least water that it is most wanted. It is by no means an injudicious plan before laying out a system of water-meadows, which is intended to be at all extensive, to prepare a small trial plot, to aid in determining a number of questions relating to the nature and quantity of the water, the porosity of the soil, &c.

¶ *Quality of Water.*—The quality of the water employed for any of the purposes of irrigation is of much importance. Its dissolved and its suspended matters must both be taken into account. Clear water is usually preferable for grass land, thick for arable land. If it is to be used for warping, or in any way for adding to the solid material of the irrigated land, then the nature and amount of the suspended material are necessarily of more importance than the character of the dissolved substances, provided the latter are not positively injurious. For use on ordinary water-meadows or on rice-fields, however, not only is very clear water often found to be perfectly efficient, but water having no more than a few grains of dissolved matter per gallon answers the purposes in view satisfactorily. Water from moors and peat-bogs or from gravel or ferruginous sandstone is generally of small utility so far as plant food is concerned. River water, especially that which has received town sewage, or the drainage of highly manured land, would naturally be considered most suitable

for irrigation, but excellent results are obtained also with waters which are uncontaminated with manurial matters, and which contain but 8 or 10 grains per gallon of the usual dissolved constituents of spring water. Experienced English irrigators generally commend as suitable for water-meadows those streams in which fish and waterweeds abound. But the particular plants present in or near the water-supply afford further indications of quality. Water-cress, sweetflag, flowering rush, several potamogetons, water milfoil, water ranunculus, and the reedy sweet watergrass (*Glyceria aquatica*) rank amongst the criteria of excellence. Less favourable signs are furnished by such plants as *Arundo Donax* (in Germany), *Cicuta virosa*, and *Typha latifolia*, which are found in stagnant and torpid waters. Water when it has been used for irrigation generally becomes of less value for the same purpose. This occurs with clear water as well as with turbid, and obviously arises mainly from the loss of plant food which occurs when water filters through or trickles over poor soil. By passing over or through rich soil the water may, however, actually be enriched, just as clear water passed through a charcoal filter which has been long used becomes impure. It has been contended that irrigation water suffers no change in composition by use, since by evaporation of a part of the pure water the dissolved matters in the remainder would be so increased as to make up for any matters removed. But it is forgotten that both the plant and the soil enjoy special powers of selective absorption, which remove and fix the better constituents of the water, and leave the less valuable.

¶ *The Influence of Mining and other Refuse.*—In some of the districts of Devonshire and of Wales, in which the sloping sides of narrow valleys have been converted into small catchwork irrigated meadows, the injurious effects of water from mines have been most marked. A stranger visiting the district in early spring would notice, along the sides of a valley, a number of small irrigated fields. Some of these, watered directly from little streams behind and above them, would show grass of great luxuriance, especially close to the main and secondary carriers. But where the river-water, contaminated by mining refuse, had been used, the grass bordering the water-courses would show a sickly yellow tint, and be generally less developed than the herbage of the rest of the field. This difference between the fields irrigated by small local brooks and those watered by the river cannot be explained by any inferiority in the river water as river water; for above the entrance of the refuse from the first mine it was everything that could be wished. But just below the place of entrance of the mine water the grass on the banks looked as if it had been burnt up with vitriol, while in the stream itself not a vestige of a living waterweed could be detected.

The injurious effects thus caused by the mine water have led to its partial disuse for the purposes of irrigation. Some of the most profitable water-meadows are no longer irrigated: the herbage in these is now of inferior character, and mosses and weeds, suppressed by total immersion, have reappeared, to the detriment of the more valuable grasses. Besides, there is now no early feed. Manure, not before wanted, has now to be applied, and the yield of grass is reduced in annual value by 30s. to 60s. per acre. To get a fair growth of grass the plant-food which the water formerly brought at little expense has to be furnished by costly farmyard manure; and even with this the crop is late and light.

It is clear in the particular instance to which reference has been made that water pumped from copper mines or used in dressing the ores is the origin of the mischief. Several changes in the composition of the water have been



found to occur in its passage through the mine. The original water lost much of its free carbonic acid gas; its carbonates were converted into sulphates; and it contained now the metals iron, manganese, cobalt, and aluminium, all as sulphates,—hardly a trace of any of these metals being present in the uninjured water. And matters in suspension were found to be both more abundant and more injurious than matters in solution. They consisted chiefly of copper pyrites and iron pyrites, in a very fine state of division. According to their degree of fineness the pyritic particles which escape from the settling pits at the mines travel varying distances down the stream, and may even be detected several miles below, both in the mud of the bed of the stream and on the leaves of grass and other occasionally immersed plants. Oxidation of the pyrites into the sulphates of copper and iron was proved to occur all through the course of the stream,—these salts, with their concomitant free sulphuric acid, producing a most injurious effect on vegetable growth. The presence of this acid in the free state has been detected in the waste water from a Welsh lead mine, in sufficient abundance to kill instantly, on several occasions, many salmon in the river into which it was discharged. The evil done by some of the most deleterious materials in mine-waters can be arrested by the interposition of conduits filled with chalk or limestone, which act as chemical filters. The carbonate of lime neutralizes the free sulphuric acid and stops the heavy metals by converting them from soluble sulphates into insoluble carbonates.

Among the most injurious sorts of refuse which can find their way into streams used for irrigating meadows are the chemical wastes from mills and factories in which the processes of dyeing, paper making, metal working, &c., are carried on. In the majority of such cases the fatal effects on vegetation are obvious, and the rivers polluted in this way, even if their volume of pure water be very large, cannot be used at all for irrigation.

*The Seeds for Water-Meadows.*—Of the few leguminous plants which are in any degree suitable for water-meadows, *Lotus corniculatus major*, *Trifolium hybridum*, and *T. pratense* are those which generally flourish best: *T. repens* is less successful. Amongst grasses the highest place must be assigned to ryegrass, especially to the Italian variety, commonly called *Lolium italicum*. The mixture of seeds for sowing a water-meadow demands much consideration, and must be modified according to local circumstances of soil, aspect, climate, and drainage. From the peculiar use which is made of the produce of an irrigated meadow, and from the conditions to which it is subjected, it is necessary to include in our mixture of seeds some that produce an early crop, some that give an abundant growth, and some that impart sweetness and good flavour, while all the kinds sown must be capable of flourishing on irrigated soil.

The following mixtures of seeds (stated in pounds per acre) have been recommended for sowing on water-meadows, Messrs Suttou of Reading, after considerable experience, regarding No. I. as the more suitable:—

I.		II.	
<i>Lolium perenne</i> .....	8 12	<i>Festuca pratensis</i> .....	0 2
<i>Lolium italicum</i> .....	0 8	<i>Festuca loliacea</i> .....	3 2
<i>Poa trivialis</i> .....	6 3	<i>Anthoxanthum odoratum</i> 0	1
<i>Glyceria fluitans</i> .....	6 2	<i>Phleum pratense</i> .....	4 2
<i>Glyceria aquatica</i> .....	4 1	<i>Phalaris arundinacea</i> ...	3 2
<i>Agrostis alba</i> .....	0 1	<i>Lotus corniculatus major</i> 3	2
<i>Agrostis stolonifera</i> .....	6 2	<i>Trifolium hybridum</i> .....	0 1
<i>Alopecurus pratensis</i> .....	0 2	<i>Trifolium pratense</i> .....	0 1
<i>Festuca elatior</i> .....	3 2		

*Changes in Irrigated Herbage.*—In irrigated meadows, though in a less degree than on sewaged land, the reduction of the amount or even the actual suppression of certain species of plants is occasionally well-marked. Sometimes

this action is exerted upon the finer grasses, but happily also upon some of the less profitable constituents of the miscellaneous herbage. Thus *Ranunculus bulbosus* has been observed to become quite rare after a few years watering of a meadow in which it had been most abundant, *R. aeris* rather increasing by the same treatment; *Plantago media* was extinguished and *P. lanceolata* reduced 70 per cent. Amongst the grasses which may be spared, *Aira cespitosa*, *Brisa media*, and *Cynosurus cristatus* are generally much reduced by irrigation. Useful grasses which are increased are *Lolium perenne* and *Alopecurus pratensis*, and among those of less value *Avena favescescens*, *Daactylis glomerata*, and *Poa pratensis*.

*Methods of Irrigation.*—There are four ways of irrigating land with water practised in England:—(1) bedwork irrigation, which is the most efficient although it is also the most costly method by which currents of water can be applied to level land; (2) catchwork irrigation, in which the same water is caught and used repeatedly; (3) subterraneous or rather upward irrigation, in which the water in the drains is sent upwards through the soil towards the surface; and (4) warping, in which the water is allowed to stand over a level field until it has deposited the mud suspended in it.

There are two things to be attended to most carefully in the construction of a water-meadow on the first or second of these plans. First, no portion of them whatever should be on a dead level, but every part should belong to one or other of a series of true inclined planes. The second point of primary importance is the size and slope of the main conductor, which brings the water from the river to the meadow. The size of this depends upon the quantity of water required, but whatever its size its bottom at its origin should be as low as the bed of the river, in order that it may carry down as much as possible of the river mud. Its course should be as straight and as near a true inclined plane as possible. The stuff taken out of the conductor should be employed in making up its banks or correcting inequalities in the meadow.

*Bedwork Irrigation.*—In this species of irrigation, which is eminently applicable to level ground, the ground is thrown into beds or ridges. Here the conductor should be led along the highest end or side of the meadow in an inclined plane; should it terminate in the meadow, its end should be made to taper when there are no feeders, or to terminate in a feeder. The tapered end will retard the motion of the water; and, as this contains, of course, less water, the water will overflow the banks of the conductor. The main drain to carry off the water from the meadow should next be formed. It should be cut in the lowest part of the ground at the lower end or side of the meadow. Its dimensions should be capable of carrying off the whole water used so quickly as to prevent the least stagnation, and discharge it into the river. The stuff taken out of it should be used to fill up irregularities in the meadow. In case the river takes a turn along the lower end or side of the meadow, the turn should be utilized to carry off the water. It might be imagined that, as a portion of the water will be absorbed by the soil, the main drain need not be made so large as the conductor, merely to carry off the water that has been used; but in practice it will be found that, when the water is muddy, very little of it comparatively will enter the ground, the sediment acting as an impervious covering. The next process is the forming of the ground intended for a water-meadow into beds or ridges. That portion of the ground which is to be watered by one conductor should be made into beds to suit the circumstances of that conductor; that is, instead of the beds over the meadow being all reduced to one common level, they should be formed to suit the different swells in the ground, and, should any of these swells be considerable, it will be necessary to give each side of them its respective conductor. The beds should run at or nearly at right angles to the line of the conductor. The breadth of the beds is regulated by the nature of the soil and the supply of water. Tenacious soils and subsoils, with a small supply of water, require beds as narrow as 30 feet. Porous soils and a large supply of water may have beds of 40 feet. The length of the beds is regulated by the supply of water and the fall from the conductor to the main drain. If the beds fall only in one direction longitudinally, their crowns should be made in the middle; but, should they fall laterally as well as longitudinally, as is usually

the case, then the crowns should be made towards the upper sides, more or less according to the lateral slope of the ground. The crowns should rise a foot above the adjoining furrows. The beds thus formed should slope in an inclined plane from the conductor to the main drain, that the water may flow equally over them.

The beds are watered by "feeders," that is, channels gradually tapering to the lower extremities, and their crowns cut down, wherever these are placed. The depth of the feeders depends on their width, and the width on their length. A bed 200 yards in length requires a feeder of 20 inches in width at its junction with the conductor, and it should taper gradually to the extremity, which should be 1 foot in width. The taper retards the motion of the water, which constantly decreases by overflow as it proceeds, whilst it continues to fill the feeder to the brim. The stuff which comes out of the feeders should be carefully and evenly laid along the sides of the beds. The water overflowing from the feeders down the sides of the beds is received into small drains formed in the furrows between the beds. These small drains discharge themselves into the main drain, and are in every respect the reverse of the feeders; that is, their tapering extremities lie up the slope, and their wide ends open into the main drain, to accelerate the motion of the departing water. The depth of the small drain at the junction is made about as great as that of the main drain, and it gradually lessens towards the taper to 6 inches in tenacious and to less in porous soils. The depth of the feeders is the same in relation to the conductor. The stuff obtained from the small drains is employed to fill up inequalities in the meadow. For the more equal distribution of the water over the surface of the beds from the conductor and feeders, small masses, such as stones, or solid portions of earth or turf fastened with pins, are placed in them, in order to retard the momentum which the water may have acquired. These "stops," as they are termed, are generally placed at regular intervals, or rather they should be left where any inequality of the current is observed. Heaps of stones answer very well for stops in the conductor, particularly immediately below the points of junction with the feeders. When tough pieces of turf are used, care must be taken to keep the tops of the pins below the reach of weeds floating on the surface of the water. These stops, however, are nothing but expedients to rectify work imperfectly executed. It must be obvious that a perfectly formed water-meadow should require few or no stops. The small or main drains require no stops. The descent of the water in the feeders will no doubt necessarily increase in rapidity, but the inclination of the beds and the tapering of the feeders should be so adjusted as to counteract the increasing rapidity. At all events notches cut into the sides of the feeders to retard the velocity of the water are much more objectionable than stops, although some recommend them. The distribution of the water over the whole meadow is regulated by the sluices, which should be placed at the origin of every conductor. By means of these sluices any portion of the meadow that is desired can be watered, whilst the rest remains dry; and alternate watering must be adopted when there is a scarcity of water. All the sluices should be substantially built at first with stones and mortar, to prevent the leakage of water; for, should water from a leak be permitted to find its way into the meadow, that portion of it will stagnate and produce coarse grasses. In a well-formed water-meadow it is as necessary to keep it perfectly dry at one time as it is to place it under water at another. A small sluice placed in the side of the conductor opposite to the meadow, and at the upper end of it, will drain away the leakage that may have escaped from the head sluice.

To obtain a complete water-meadow, the ground will often require to be broken up and remodelled. This will no doubt be attended with cost; but it should be considered that the first cost is the least, and remodelled the only way of having a complete water-meadow which will continue for years to give satisfaction. To effect a remodelling when the ground is in stubble, let it be ploughed up, harrowed, and cleaned as in a summer fallow, the levelling-box employed when required, the stuff from the conductors and main drains spread abroad, and the beds ploughed into shape,—all operations that can be performed at little expense. The meadow should be ready by August for sowing with one of the mixtures of grass-seeds already given. But though this plan is ultimately better, it is attended with the one great disadvantage that the soft ground cannot be irrigated for two or three years after it is sown with grass-seeds. This can only be avoided where the ground is covered with old turf which will bear to be lifted. On ground in that state a water-meadow may be most perfectly formed. Let the turf be taken off with the spade, and laid carefully aside for relaying. Let the strip ground then be neatly formed with the spade and barrow, into beds varying in breadth and shape according to the nature of the soil and the dip of the ground,—the feeders from the conductor and the small drains to the main drain being formed at the same time. Then let the turf be laid down again and beaten firm, when the meadow will be complete at once, and ready for irrigation. This is the most beautiful and most expeditious method of making a complete water-meadow where the ground is not naturally sufficiently level to begin with.

The water should be let on, and trial made of the work, whenever it is finished, and the motion of the water regulated by the introduction of a stop in the conductors and feeders where a change in the motion of the current is observed, beginning at the upper end of the meadow. Should the work be finished as directed by August, a good crop of hay may be reaped in the succeeding summer. There are few pieces of land where the natural descent of the ground will not admit of the water being collected a second time, and applied to the irrigation of a second and lower meadow. In such a case the main drain of a watered meadow may form the conductor of the one to be watered, or a new conductor may be formed by a prolongation of the main drain; but either expedient is only advisable where water is scarce. Where it is plentiful, it is better to supply the second meadow directly from the river, or by a continuation of the first main conductor. In some instances it may be necessary to carry a conductor over a hollow piece of ground along an aqueduct made for the purpose, called a "carry-bridge." Such an aqueduct may be made either of wood, cast-iron, or stone and mortar; or inverted siphons may be used.

**Catchwork Irrigation.**—In the ordinary catchwork water-meadow, the water is used over and over again. On the steep sides of valleys the plan is easily and cheaply carried out, and where the whole course of the water is not long the peculiar properties which give it value, though lessened, are not exhausted when it reaches that part of the meadow which it irrigates last. The design of any piece of catchwork will vary with local conditions, but generally it may be stated that it consists in putting each conduit save the first to the double use of a feeder or distributor and of a drain or collector. The following description of one of the best ways in which a catchwork meadow plan may be constructed is condensed from Mr. Rickford's account in the *Journal of the R. Agric. Soc.*, 1852. This comparatively cheap system, though at first chiefly used on the sloping sides of Devonshire and Somersetshire valleys, has been successfully applied to level meadows. In one case the fall was but 1 in 528.

"This system has the advantage over the common system of obviating the necessity for large and frequent level gutters; it has the effect of continuing (and even causing) a smooth and uniform surface to the meadow, allowing of the operations of mowing and carting without any sensible perception of the existence of the gutters; and also that of accelerating the speed of the water over the land when 'turned on,' and the speedily draining the water from the surface when 'turned off.' It becomes a ready instrument in the hands of the irrigator, and obviates that waste of land occasioned by the usually large gutters. It is every way better than the old system: it can be done in half the time, and for less than half the expense. The chief features of the system consist in causing the ground intended to be irrigated to be covered with a network of small gutters, intersecting each other as nearly at right angles as circumstances will permit. These gutters are about 4 inches wide and 1 inch deep; they are cut with a 'die,' fixed in a sort of plough of simple construction, drawn generally by one horse. This network of gutters is fed at the highest level possible, or thought desirable, by a carriage gutter of sufficient size.

"Let fig. 1 be a piece of meadow; look first where the water enters the meadow, or where it can best be made to enter. Let this be ascertained to be at A 1. Then estimate roughly where it may be supposed the water will run,—say, along the dotted line 1 . . . 2. Next proceed, using a simple level adjusted by means of a plumb-line.

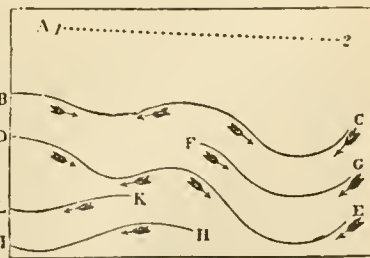

Fig. 1.

to lay down a level line made across the meadow, such as BC'. The arrows marked on the line show the way the water is to be made to run on in the gutter line,—to obtain which it is necessary to deviate from precise levelling, and allow the plumb-line to drop a little before the level mark when inclining down, and a little behind it when inclining up the meadow. This will have the effect of running the water out of the low places, and upon the high places. Care must be taken in levelling to follow out the indications of the level, however crooked and curved the line may appear, going down around every elevation, and avoiding every disposition to cut the line straighter.

"Having completed that line, return to the side first begun, say to D, about 10 paces down from B; and, by proceeding as in BC the line DE will very likely be produced. Should C and E be too far asunder, begin again at F, and produce the line FG. The middle of the meadow is supposed to be lowest, and the meadow itself to be flat, rising on each side of the middle by two gentle



undulations, so that the lines of gutter curve very considerably. From the nature of the ground it may next be necessary to begin at H, and to produce HI. It will now be perceived that D and I are too far asunder, making it necessary to introduce KL, beginning at K. The higher side must be finished in like manner.

Let now fig. 2 represent a meadow, with all the lines of fig. 1 marked with the level and ploughed, but not 'turned out.' It will be perceived that the curves of the lines form a series of loops, and that the undulations of the meadow are prettily mapped out by the curves going down round the hills and up round the valleys. It will be at once seen where the water is principally wanted, viz., just above where the curves form the greatest downward bend, as at A, fig. 2.

Next draw the lines which, upon an average, will be at right angles to the level, but in each particular line will deviate from the right angle, more or less, according as the ground is more or less irregular. This may be done by walking in advance of a plough, and leaving foot-prints to mark where the plough must follow. Care must be taken to go as nearly through the centre of the downward loops as possible. In order to do this, first cut the lines 1, 2, 3, 4, 5, and then fill up the intervals by cutting a, b, c. The best distance for these seems to be from ten to fifteen paces apart.

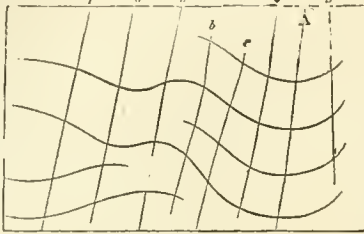

Fig. 2.

The next business is to bring in the water, after just lifting the turf out of the gutters already cut. A spirit-level may be used, the gutter being allowed to drop 1 1/2 or 2 inches every 2 poles, if the nature of the ground will allow of it; not less than 1/2 inch will do at all well. A much larger gutter is required at 1/2-inch drop than at 2 inches; and, besides, it will not run itself dry so well when the water is turned off. The 2-inch drop gutters will run the water off directly; the 1/2-inch will scarcely do it at all. Regard must be had to the supply of water required at the further end. In the case supposed in fig. 2, it is wanted on the rising ground, at the further end A; therefore the gutter should drop that way, and be of a good size. If the water is wanted chiefly at the beginning of the gutter, the drop need not be so much, and the gutter should taper away so as to end nearly in a point.

The size of the stream is the next consideration. If it can water the whole piece at all times, one gutter, of sufficient size, should be made. Stops in a gutter should be avoided. Where the stream is small, make a leading gutter, and take out from it taper gutters, each of a size suited to the stream when at its smallest, so that when the stream increases (from rain or any other cause), as many taper-gutters may be used as will disperse the whole stream. The leading gutter should continually decrease in size from the place where the first taper-gutter is taken out of it, and finish in a tapering water-gutter itself at last. In fig. 3, AB is a carriage-gutter as

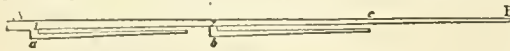

Fig. 3.

far as c, and a watering-gutter from c to B; a and b are watering-gutters taken out of it. When the stream is small, a stop at 1 will cause it to work in a, a stop at 2 will work in b; without any stop it will work in c. If the stream is too much for c, it will work b at the same time; and, should there be water enough, it will also fill a without any stop at all. Care should be taken not to make AB larger than just to carry the full stream wanted; and in every case when the gutter becomes too large by frequent cleaning out, cut it anew on one side or the other.

The hedge-trough may be made a carriage-gutter wherever it can be done conveniently, care being always taken to keep the water running in it. Covered gutters made with large tiles could also be substituted for the deep open carriage-gutter, where it is necessary to cross the middle of meadows; this obviates the danger of the open gutter to sheep and lambs, and the tiled gutter does not require the annual 'cleaning out.'

When a small stream insufficient for the whole meadow is used, the water must be confined to ground determined on by stops in the gutters which run on the two sides of it, thus:—

Fig. 4 is a section of the network of gutters; AB is the carriage-gutter; a is a taper watering-gutter, to the extent of which the water is supposed to be determined to be confined; b, c, d, e, are the feeding gutters (perpendicular to the levele); the cross-gutters are the 'level' ones; b and c serve as the two side gutters of the section to be watered. The water is confined to the ground between them by stops at the crossings, arranged thus:—b and c (fig. 5) are

crossings on the feeders; 1, 2, 3, 4 are stops, the purpose of which is obvious enough. The arrows show the direction the water is made to run. The stops are pieces of the turf taken out of the gutters, which, being cut with a 'die,' fit the gutters with exactness, and can be put in operation instantly, without trouble or loss of time.

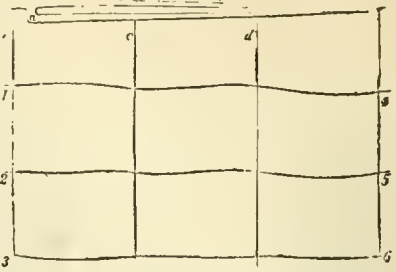

Fig. 4.

The gutters are not to be cut in the same places two successive years, but on one side, as near as can be conveniently done, say about a foot and a half from the former ones; and the turf of the new gutter is to be used to fill in the old one, the latter not being crammed too full. By this means the gutters are always new, and always the proper size. If cut on the right-hand side and above one year, the next year they should be cut the left-hand side and below.

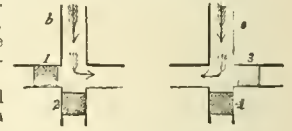

Fig. 5.

It will be proper now to call attention to the manner in which the water is carried, with its suspended matter, to the extreme end of the meadow, by the plan we are pursuing. It will be observed that the ground is covered by a sort of network of little gutters, one set being, in a sort, parallel to each other, intersected by another set at right angles to them and also parallel to each other. This would be strictly true were the surface strictly a plane surface; but, this being very rarely the case, both sets deviate from a strictly parallel condition in order to meet the undulations of the ground,—the deviations compensating each other on the aggregate. Now, instead of carrying the water down to the lower end by means of one large gutter, and then dispersing it by another large gutter (a level one), we do it by twenty or so little gutters which feed the dispersing gutter about every ten or fifteen paces; being so small, these never fret away, and, being newly cut every year, they never increase in size.

These small gutters are sufficient when the little stops are taken out of the perpendicular gutters, and the level gutters are stopped so as to confine the water to the perpendiculars, to carry down the requisite water. The level gutter of a lower section (if a lateral section is to be watered), instead of being fed by a large stream at the end, is supplied every ten or fifteen paces by one of those little gutters, thus giving a uniform supply throughout the length of the level gutter. A larger supply than this will afford is an evil. When the water is shut out from the 'leading-in' gutter it is not necessary to move any of the little stops; the same perpendicular gutters that are effectual to run the water on are effectual to run it off, leaving the surface of the meadow dry and solid. The water is evenly distributed over the surface by these minute gutters, which are made to follow all the undulations of the land (which can never be done by the large gutters), and also, from the draining effect of the perpendicular gutters, the water is never suffered to accumulate in ponds. The water on the meadow is therefore never 'over-shoe' anywhere. These gutters are no way dangerous to sheep or lambs, are never in the way of mowing, have an elegant rather than an unsightly appearance, are not perceived either in raking or carting, and suit the horse-rake or hay-making machine admirably. It may be added that the leading-in gutters can be so arranged as to tend themselves in cases of flood.

Upward or Subterranean Irrigation.—In this kind of irrigation the water used rises upward through the soil, and is that which under ordinary circumstances would be carried off by the drains. The system has received considerable development in Germany, where the elaborate method invented by Petersen is recommended by many agricultural authorities. In this system the well-fitting earthenware drain-pipes are furnished at intervals with vertical shafts terminating at the surface of the ground in movable caps. Beneath each cap, and near the upper end of the shaft, are a number of vertical slits through which the drainage water which rises passes out into the conduit or trench from which the irrigating streams originate. In the vertical shaft there is first of all a grating which intercepts solid matters, and then, lower down, a central valve which can be opened and closed at pleasure from the top of the shaft. In the ordinary English system of upward or drainage irrigation, ditches are dug all round the field. They act the part of conductors when the land is to be flooded, and of main drains when it is to be laid dry. The water flows from the ditches as

conductors into built conduits formed at right angles to them in parallel lines through the fields; it rises upwards in them as high as the surface of the ground, and again subsides through the soil and the conduits into the ditches as main drains, and thence it passes at a lower level either into a stream or other suitable outfall. The ditches may be filled in one or other of several different ways. The water may be drainage-water from lands at a higher level; or it may be water from a neighbouring river; or it may be drainage-water accumulated from a farm and pumped up to the necessary level. But it may also be the drainage-water of the field itself. In this case the mouths of the underground main pipe-drains are stopped up, and the water in them and the secondary drains thus caused to stand back until it has risen sufficiently near the surface. Of course it is necessary to build the mouths of such main drains of very solid masonry, and to construct efficient sluices for the retention of the water in the drains. Irrigation of the kind now under discussion may be practised wherever a command of water can be secured, but the ground must be level. It has been successfully employed in recently drained morasses, which are apt to become too dry in summer. It is suitable for stiffish soils where the subsoil is fairly open, but is less successful in sand. The water used may be turbid or clear, and it acts, not only for moistening the soil, but as manure. For if, as is commonly the case, the water employed be drainage-water from cultivated lands, it is sure to contain a considerable quantity of nitrates, which, not being subject to retention by the soil, would otherwise escape. These coming into contact with the roots of plants during their season of active growth, are utilized as direct nourishment for the vegetation. It is necessary in upward or subterranean irrigation to send the water on and to take it off very gently, in order to avoid the displacement and loss of the finer particles of the soil which a forcible current would cause.

*Warping.*—In this variety of irrigation the suspended solid matters are of importance, not merely for any value they may have as manure, but also as a material addition to the ground to be irrigated. The waters of the Nile and the Ganges afford conspicuous examples of rivers rich in suspended matter, which occasionally amounts to one hundredth of their volume, and frequently to more than one part in two hundred parts of water. The warping which is practised in England is almost exclusively confined to the overflowing of level ground within tide mark, and is conducted mostly within the districts commanded by estuaries or tidal rivers. The best notion of the process of warping may be gained by sailing up the Trent from the Humber to Gainsborough. Here the banks of the river were constructed centuries ago to protect the land within them from the encroachments of the tide. A great tract of country was thus laid comparatively dry. But, while the wisdom of one age thus succeeded in restricting within bounds the tidal water of the river, it was left to the greater wisdom of a succeeding age to improve upon this arrangement, by admitting these muddy waters to lay a fresh coat of rich silt on the exhausted soils. The process began more than a century ago, but has become a system in recent times. Large sluices of stone, with strong doors, to be shut when it is wished to exclude the tide, may be seen on both banks of the river, and from these great conduits are carried miles inward through the flat country, to the point previously prepared by embankment, over which the muddy waters are allowed to spread. These main conduits, being very costly, are constructed for the warping of large adjoining districts, and openings are made at such points as are then undergoing the operation. The mud is deposited, and the waters return with the falling tide to the bed of the river. Spring-tides are preferred, and so great is the quantity of mud in these rivers that from 10 to 15 acres have been known to be covered with silt from 1 to 3 feet in thickness during one spring of ten or twelve tides. Peat-moss of the most sterile character has been by this process covered with soil of the greatest fertility, and swamps which used to be resorted to for leeches are now, by the effects of warping, converted into firm and fertile fields. The art is now so well understood that, by careful attention to the currents, the expert warp farmer can temper his soil as he pleases. When the tide is first admitted, the heavier particles, which are pure sand, are first deposited; the second deposit is a mixture of sand and fine mud, which, from its friable texture, forms the most valuable soil; while lastly the pure mud subsides, containing the finest particles of all, and forms a rich but very tenacious soil. The great effort, therefore, of the warp farmer is to get the second or mixed deposit as equally over the whole surface as he can, and to prevent the deposit of the last. This he does by keeping the water in constant motion, as the last deposit can only take place when the water is suffered to be still. Three years may be said to be spent in the process, one year warping, one year drying and consolidating, and one year growing the first crop, which is generally seed hoed in by hand, as the mud at this time is too soft to admit of horse labour.

The immediate effect, which is highly beneficial, is the deposition of silt from the tide. To ensure this deposition, it is necessary to surround the field to be warped with a strong embankment, in order to retain the water as the tide recedes. The water is admitted by

valved sluices, which open as the tide flows into the field, and shut by the pressure of the confined water when the tide recedes.—These sluices are placed on as low a level as possible, to permit the most turbid water at the bottom of the tide to pass through a channel in the base of the embankment. The silt deposited after warping is exceedingly rich, and capable of carrying any species of crop. It may be admitted in so small a quantity as only to act as a manure to arable soil, or in such a large quantity as to form a new soil. This latter acquisition is the principal object of warping, and it excites astonishment to witness how soon a new soil may be formed. From June to September a soil of 3 feet in depth may be formed under the favourable circumstances of a very dry season and long drought. In winter and in floods warping ceases to be beneficial. In ordinary circumstances, on the Trent and Humber, a soil from 6 to 16 inches in depth may be obtained, and inequalities of 3 feet filled up. But every tide generally leaves only  $\frac{1}{2}$  inch of silt, and the field which has only one sluice can only be warped every other tide. The silt, as deposited in each tide, does not mix into a uniform mass, but remains in distinct layers. The water should be made to run completely off, and the ditches should become dry, before the influx of the next tide, otherwise the silt will not incrust, and the tide not have the same effect. Warp soil is of surpassing fertility. The expense of forming canals, embankments, and sluices for warping land is from £10 to £20 an acre. A sluice of 6 feet in height and 8 feet wide will warp from 60 to 80 acres, according to the distance of the field from the river. The embankments may be from 3 to 7 feet in height, as the field may stand in regard to the level of the highest tides. After the new land has been left for a year or two in seeds and clover, it produces great crops of wheat and potatoes.

Warping is practised only in Lincolnshire and Yorkshire, on the estuary of the Humber, and in the neighbourhood of the rivers which flow into it—the Trent, the Ouse, and the Don. The silt and mud brought down by these rivers is rich in clay and organic matter, and sometimes when dry contains as much as one per cent. of nitrogen.

*The Management and Advantages of Water-Meadows.*—Constant care is required if a water-meadow is to yield quite satisfactory results. The earliness of the feed, its quantity, and its quality will all depend in very great measure upon the proper management of the irrigation. The points which require constant attention are—the perfect freedom of all carriers, feeders, and drains from every kind of obstruction, however minute; the state and amount of water in the river or stream, whether it be sufficient to irrigate the whole area properly or only a part of it; the length of time the water should be allowed to remain on the meadow at different periods of the season; the regulation of the depth of the water, its quantity, and its rate of flow, in accordance with the temperature and the condition of the herbage; the proper times for the commencing and ending of pasturing and of shutting up for hay; the mechanical condition of the surface of the ground; the cutting out of any very large and coarse plants, as docks; and the improvement of the physical and chemical conditions of the soil by additions to it of sand, silt, loam, chalk, &c.

Whatever may be the command of water, it is unwise to attempt to irrigate too large a surface at once. Even with a river supply fairly constant in level and always abundant, no attempt should be made to force on a larger volume of water than the feeders can properly distribute and the drains adequately remove, or one part of the meadow will be deluged and another stinted. When this inequality of irrigation once occurs, it is likely to increase, from the consequent derangement of the feeders and drains. And one result on the herbage will be an irregularity of composition and growth, seriously detrimental to its food-value. The adjustment of the water by means of the sluices is a delicate operation when there is little water, and also when there is much; in the latter case the fine earth may be washed away from some parts of the meadow; in the former case, by attempting too much with a limited water current, one may permit the lauguid streams to deposit their valuable suspended matters instead of carrying them forward to enrich the soil. The water is not to be allowed to remain too long on the



ground at a time. The soil must get dry at stated intervals in order that the atmospheric air may come in contact with it and penetrate it. In this way as the water sinks down through the porous subsoil, or into the subterranean drains, oxygen enters, and supplies an element which is needed, not only for the oxidation of organic matters in the earth, but also for the direct and indirect nutrition of the roots. Without this occasional drying of the soil the finer grasses and the leguminous plants will infallibly be lost; while a scum of ferns and other algae will collect upon the surface, and choke the higher forms of vegetation. The water should be run off thoroughly, for a little stagnant water lying in places upon the surface does much injury. The practice of irrigating differs in different places with differences in the quality of the water, the soil, the drainage, &c. As a general rule, when the irrigating season begins in November, the water may flow for a fortnight continuously, but subsequent waterings, especially after December, should be shortened gradually in duration till the first week in April, when irrigation should cease. It is necessary to be very careful, in irrigating during frosty weather. For, though grass will grow even under ice, yet if ice be formed under and around the roots of the grasses the plants may be thrown out by the expansion of the water at the moment of its conversion into ice. The water should be let off on the morning of a dry day, and thus the land will be dry enough at night not to suffer from the frost; or the water may be taken off in the morning and let on again at night. In spring the newly grown and tender grass will be easily destroyed by frost if it be not protected by water, or if the ground be not made thoroughly dry.

Several other important matters in the management of water-meadows have to be noticed. Among these the times for depasturing with sheep and other stock are of considerable moment, not only because one of the main services rendered by a water-meadow is the early and valuable feed which it ought to afford, but for securing the health of the animals, particularly their immunity from sheep-rot. A water-meadow cannot be trusted late in the season, especially in view of what is now known concerning the liver-fluke of sheep. It seems to be judicious to depasture the early grass on water-meadows with ewes and lambs at the end of March and in April, and to have it eaten down here before May with a heavy stock. On good land and in good seasons a second and even a third crop of feed may be got before the 1st of May, the water being let on after each feed. After that the grass is allowed to stand for hay, but it should be irrigated for a few days to clean the pasture. Further particulars as to the management of irrigated meadows may be gathered from the two accounts which follow, which embody, though in a very condensed form, the system pursued in the district which is perhaps the most noted for its water-meadows, namely, that of the Christchurch Avon. Some of these afford characteristic examples of the usual English system of irrigation. They consist in the main of alluvial soil, often very shallow, lying upon gravel. Professor Wrightson, of the College of Agriculture at Downton, near Salisbury, gives the following particulars concerning the water-meadows in his own neighbourhood. They are very valuable as they assist to keep sheep from Lady Day until the end of April, a time when green food is scarce; at that season they never rot sheep. After sheep have been pastured on the water-meadows, these are shut up for hay, of which they yield in fair seasons about 2 tons per acre. The hay is cleared off in July, and the meadows are then fed off by cows until about the first week in October. At this time the work of clearing out the water-carriers and ditches is proceeded with; banks, stops, sluices, &c., are repaired; and holes and deep hoofprints filled up or laboriously stamped out. As soon as possible the water is let on, the irrigation being continued throughout November, December, January, and February. On the Downton College farm the water, during the above four months, is shared, on alternate weeks, with the neighbours. The water is caused to flow regularly over all the meadows, and the "meadman" is almost constantly employed in "watering" and "drowning." In March the water is shut off, and the meadows are ready for sheep during the first week in April. In about four weeks' time the sheep are taken off, and the meadows are again watered on alternate weeks up to mid-June. At this time the ground is allowed to become dry and firm so as to permit of grass-cutting (with scythes) and of hay-making. The hay is good and of agreeable flavour, but not equal to upland

hay. The Avon meadows begin at Britford, just below Salisbury; and here the results of irrigation are as good if not better than anywhere else in England. They continue from Britford to Fordingbridge, but below the latter place down to Ringwood and Christchurch they degenerate into mere flooded meadows and marshes abounding in wild duck, and yielding a very coarse and unwholesome herbage. The Avon valley waters are derived from the Chalk, the Upper Greensand, and the Upper Oolite.

The late Mr J. Combes gave, in a paper read before the Royal Agricultural Society, some remarkable instances of the value of the grass produced on some of these Avon water-meadows. He mentioned the fact that £7 or £8 per acre had been given for the spring feed when there had been a failure of the turnip crop; once under such circumstances the spring feed of 6½ acres fetched no less than £80. He cited an instance of a meadow of 20 acres, depastured by sheep in spring, as keeping eight hundred sheep twenty-five days, and as yielding after this, in the first and second cuttings, no less than 40 tons of hay.

The following directions for the management of water-meadows given by the late J. Combes of Tisbury (whose observation as a practical irrigator was exact, and whose experience was very extensive), though in the first instance applicable to the Wiltshire Avon meadows, are of general value.

Let the meadows be ready to receive the water in the first week in November, that the manurial matters present in the first freshet of the river after the autumnal rains have commenced may be caught and utilized. Water as much as possible during November and December. In January let the water on six days out of seven, in February three out of four, in March two out of four, in May and June two out of seven, in July and August one out of six; and shut off the water entirely during September and October. The young grass coming up where sheep have just fed off a portion should not be immersed; but generally their watering is bad, and, if there is not enough water for the whole meadow, let one portion be generously treated at a time. Such sections, in Wiltshire called stems, may be watered for five days at a time in winter and two days at a time in summer. It is better to water by night than by day, and in shady rather than in sunny weather.

Assuming that the sluices are in working order, and the conductors or carriers, the feeders, and the drains sound and clear of all obstructions, then actual irrigation begins thus. The sluice is drawn up, and if the water be abundant the conductor and feeders will be filled in about half an hour. The motion of the water should first be adjusted in all the conductors, then in the feeders nearest the upper part of the meadow, and then successively in those which are lower. The sluices regulate the water in the conductors, and the position of the "stops" regulates the water in the feeders. The stops should be so placed as to cause the water to overflow the sides of the feeders, by so adjusting the stops as to make the openings or waterways at either side of them wider or narrower as required. The first general inundation will show any irregularities in the levels and meadow surfaces; these should be noted for rectification in the ensuing summer. It will in general need three trial adjustments of the sluices and stops before an experienced irrigator can satisfy himself that the meadow is properly irrigated with the requisite depth of 1 inch of water. During each period of irrigation the meadow should be visited and inspected at regular intervals to see that obstructions are removed and accidents repaired. In Scotland irrigation is generally continued all April, though in reduced amount towards the end of the month.

The average annual repairs of a water-meadow have been estimated at 5s to 6s. an acre; the greatest expense will be incurred for levelling, &c., in the second year after laying out the ground.

Mention has been made already not only of the general advantages resulting from that variety of irrigation practised in water-meadows, but also of particular examples of profitable results. It would not be difficult to accumulate many further examples of the latter sort, but they must always be received as applying to the particular circumstances of the case, and very often to seasons and commercial and agricultural conditions different from those which have ruled. An example or two of favourable results obtained by irrigation of water-meadows may be cited here. The late Mr Pusey, after having converted a field of 2 acres on his Berkshire home farm into a water-meadow, was able to obtain from it five months' keep for seventy-three sheep. The grass of the meadow had previously become hardly worth cutting, from the land having got out of condition; but by irrigation 2 acres of it had become equal to 5 acres of superior grazing land unwatered. The late Mr Stephens quoted in his *Practical Irrigator* a case of the conversion of 5 acres (valued at 8s. per acre) of a peat bog into a bedwork water-meadow. The expense was £6 per acre, and the crop of hay was 4 tons 11½ cwt. per acre, with an aftermath valued at 18s. per acre.

*Theory of Irrigation.*—Although in many cases it is easy to explain the reasons why water artificially applied to land brings crops or increases their yield, the theory

of our ordinary water-meadow irrigation is rather obscure. For we are not dealing in these grass lands with a semi-aquatic plant like rice, nor are we supplying any lack of water in the soil, nor are we restoring the moisture which the earth cannot retain under a burning sun. We irrigate chiefly in the colder and wetter half of the year, and we "saturate" with water the soil in which are growing such plants as are perfectly content with earth not containing more than one-fifth of its weight of moisture. We must look in fact to a number of small advantages, and not to any one striking beneficial process, in explaining the aggregate utility of water-meadow irrigation. We attribute the usefulness of water-meadow irrigation, then, to the following causes:—(1) the temperature of the water being rarely less than 10° Fahr. above freezing, the severity of frosts in winter is thus obviated, and the growth, especially of the roots of grasses, is encouraged; (2) nourishment or plant food is actually brought on to the soil, by which it is absorbed and retained, both for the immediate and for the future use of the vegetation, which also itself obtains some nutrient material directly; (3) solution and redistribution of the plant food already present in the soil occur mainly through the solvent action of the carbonic acid gas present in a dissolved state in the irrigation-water; (4) oxidation of any excess of organic matter in the soil, with consequent production of useful carbonic acid and nitrogen compounds, takes place through the dissolved oxygen in the water sent on and through the soil where the drainage is good; and (5) improvement of the grasses, and especially of the miscellaneous herbage, of the meadow is promoted through the encouragement of some at least of the better species and the extinction or reduction of mosses and of the innutritious weeds.

To the united agency of the above-named causes may safely be attributed the benefits arising from the special form of water-irrigation which is practised in England. Should it be thought that the traces of the more valuable sorts of plant food (such as compounds of nitrogen, phosphates, and potash salts) existing in ordinary brook or river water can never bring an appreciable amount of manurial matter to the soil, or exert an appreciable effect upon the vegetation, yet the quantity of water used during the season must be taken into account. If but 3000 gallons hourly trickle over and through an acre, and if we assume each gallon to contain no more than one-tenth of a grain of plant food of the three sorts just named taken together, still the total, during a season including ninety days of actual irrigation, will not be less than 9 lb per acre. It appears, however, that a very large share of the benefits of water-irrigation is attributable to the mere contact of abundance of moving water, of an even temperature, with the roots of the grass. The growth is less checked by early frosts; and whatever advantages to the vegetation may accrue by occasional excessive warmth in the atmosphere in the early months of the year are experienced more by the irrigated than by the ordinary meadow grasses by reason of the abundant development of roots which the water has encouraged.

*Irrigation in India.*—The irrigation works of India may be grouped under five descriptions or classes, as follows:—(1) *perennial canals*,—works fed by rivers of which the discharge at all times of the year suffices, without storage, to supply the canals; (2) *intermittent canals*,—works fed by rivers having an uncertain and very variable discharge, which is stored and rendered constantly available for the canals by means of reservoirs formed in the river-basins themselves; (3) *periodical canals*,—works fed by rivers having a supply available during the rainy season only; (4) *inundation canals*,—works fed by rivers having a constant discharge of some magnitude, but fed only when the rivers are in flood; (5) *tanks*,—works which either impound a supply from rivers or small catchment areas, or collect a supply by means of embankments thrown across valleys or gorges.

The rainfall of India is not only very irregular in its yearly distribution, but the annual amount varies much from year to year, while the annual average differs in the twenty-two "meteorological tracts" into which the empire has been divided. The following table of average annual rainfall, stated in inches, is from the Report for 1879 of the Select Committee on Indian Public Works:—

1. Sind and Cutch.....	9	12. Western Bengal.....	56
2. Punjab plains.....	22	13. Western Himalaya.....	65
3. Hyderabad and South Deccan.....	25	14. Lower Ganges plains.....	68
4. North Deccan plateau.....	28	15. Pegu.....	76
5. Khandeish and Berar.....	29	16. Assam and East Bengal.....	96
6. Rajputana and Gujerat.....	32	17. Bay Islands.....	108
7. Carnatic.....	64	18. Malabar and Ghats.....	112
8. Northern Circars.....	36	19. Eastern Himalaya.....	144
9. Upper Ganges plains, North-West Provinces.....	28	20. Concan and Ghats.....	145
10. Central India and Nerbudda.....	44	21. Tenasserim.....	153
11. Central Provinces (South).....	49	22. Arakan.....	193

The following statistics of the irrigated acreage in different Indian presidencies and provinces belong generally to the years 1877-8, but are in several directions imperfect. Averages are in many cases not yet available. Of course the figures here given must be received with due reserve, since the areas irrigated vary much, from year to year, according to the season; while, as new works are brought into action, great additions to the irrigable acreage are suddenly made.

	Acres Irrigated.	Annual Rainfall.
Madras.....	5,265,320	35 inches.
Bombay.....	20,786	24 "
Sind.....	1,267,054	9 "
Bengal.....	360,304	50 "
North-West Provinces and Oudh.....	1,461,429	40 "
Punjab.....	1,520,124	18 "

The annual average rainfall refers only to that of the irrigable areas, and is a very rough approximation.

*Irrigation in Italy, France, and Belgium.*—In Italy the practice of irrigating meadows and crops has been long followed, and is carried out in some parts by means of a complex and costly system of canals. The extent of lands irrigated was in 1878:—

Lombardy.....	678,000 hectares.	Emilia.....	96,000 hectares.
Piedmont.....	443,000 "	Other provinces.....	214,000 "
Venice.....	74,000 "		

Rice is extensively grown in artificially irrigated lands in the basin of the Po. The produce in rough grain oscillates between 30 and 50 times the weight of seed sown; if official reports may be trusted, a hectolitre and a half of seed rice will yield from 45 to 75 hectolitres. During the four years in which a field is in rice the annual crop, beginning at 70 hectolitres, sinks successively to 65, 50, and 40. About 42 hectolitres of cleaned rice is the general average yield.

In some parts of Italy the system of winter irrigation, with which we are familiar in England, is carried out upon meadows in which the *Lolium italicum* abounds. This is the case in many of the valleys of Lombardy and in the neighbourhood of Padua. The cuttings of grass are about six in the year, but where certain sewage waters from towns are mingled with the natural water supply eight or even nine cuttings are not unusual. The average yield of hay in these meadows when irrigated with clean river water is about 14,000 kilograms annually, or twice the amount obtained from permanent pasture in the same district. The cuttings begin as early as the end of February, the heaviest amount being obtained in the May cutting, and the lightest in that of October.

In France irrigation has met with increasing favour of late years. Since 1875 there have been Government competitions for prizes for the best examples of irrigated farms. In 1879 there were competitors from eight departments of France, two departments, those of the Basses Alpes and Hautes Alpes, in which the areas irrigated amount respectively to 8500 and 20,000 hectares, furnishing no less than seventy-two. There are many canals in these departments. Other important irrigation works are to be found in Provence, Dauphiné, and Languedoc. The valley of the Isère near Grenoble affords a good illustration of how a devastating torrent may be turned into a source of continual fertility, 3000 hectares of useful land having now been conquered from floods and reclaimed. In the Roussillon district the irrigated area has been doubled between 1820 and 1880, and exceeds 25,000 hectares. One farmer, M. François Coste, whose grandfather was ruined by having to pay 2 francs per hectare for a rugged mountain farm, now obtains from 18 hectares of the same land no less than 125,000 kilos of hay, or 6000 to 7000 kilos per hectare, a fair yield even for the average meadows of the north of France. In the Pyrénées Orientales there are canals which have been constructed since 1850, and which now water over 6000 hectares. It is scarcely necessary to say that in some lands irrigation without any application of manure has been unremunerative, but that with manure the natural produce has been raised from 7000 to 16,000 kilos of hay per hectare.

There appear to have been some instances where that terrible vine scourge, the *Phylloxera*, has been entirely eradicated by autumnal submersion of the roots of the affected plants. Irrigation



has also been employed in the cultivation of lucerne, of green maize fodder, and of asparagus and other market-garden produce.

The notion that irrigated rice fields are unhealthy has led to the abandonment of rice-growing in France and Portugal. But it is only when the layer of water is exceptionally shallow or discontinuous as well as stagnant that bad effects on the health of the district have followed. It is at the close of the growing season, when during very hot weather the water no longer covers the soil, and also in the case of badly-planned and badly-managed rice fields, that there is danger from the rapid decomposition of organic matters in the earth.

In Belgium irrigation is extensively practised in the district La Campine, where the whole process is carried out in the most methodical way, and under strict Government supervision. The following figures, given by Mr E. Laveleye, afford some notion of the results of Belgian irrigation. An area of 2281 hectares of barren soil (sand dunes, in fact), yielding absolutely nothing, now produces an average of about 3000 kilos. of hay per hectare, 100 kilos. being worth 10 francs. The value of the aftermath is further estimated at 100 francs per hectare, so that the total yield from one hectare becomes 400 francs, or £16. Full particulars concerning irrigation in Belgium may be learned from the treatise by J. Keelhoff, entitled *Traité Pratique de l'Irrigation des Prairies* (Brussels, 1856). M. Keelhoff recommends the following mixture of seeds (stated in kilos. per hectare) for sowing on the Belgian sandy fields which are to be irrigated:—

<i>Lolium perenne</i> .....	16	<i>Tris pratensis</i> .....	5
<i>Phleum pratense</i> .....	6	<i>Aulhoranthum olorum</i> .....	10
<i>Alopecurus pratensis</i> .....	25	<i>Medicago lupulina</i> .....	4
<i>Holcus lanatus</i> .....	25	<i>Trifolium pratense</i> .....	4
<i>Cynurus cristatus</i> .....	5		

*History of Irrigation.*—This part of the subject is very extensive, not merely because it deals with a very ancient art, and one very widely practised, but because the materials are very varied, and in many cases very difficult of interpretation. Still we possess not merely a considerable number of allusions to irrigation in ancient Egyptian, Hebrew, and Oriental records, and in Latin and Greek authors, but we have very tangible remains, still extant, of ancient irrigation works in many countries of Europe and Asia, and in some parts of northern Africa. In Egypt the art can be traced back to a very early period. In that comparatively level country an extensive system of artificial ponding reservoirs or lakes, with a network of distributing canals, was in existence at least as early as the time of Sesostris. If the art of irrigation was taught to the ancient Egyptians by the natural overflowing of the Nile, it is probable that Egypt in her turn afforded an example to Assyria and Babylon, to Carthage and Phœnicia, and also to Greece and Italy. The early history of irrigation in Persia and China has received some little elucidation in recent years, but even in the case of India our exact knowledge of the development of this art remains imperfect. What has been done during the present century in India may, however, be studied in a compact form, though rather from the financial than from the agricultural side, in Mr R. B. Buckley's *Irrigation Works of India* (1859), a book which has been laid under contribution in preparing the present article. Amongst Latin authors Cato, and more particularly Columella, speak of the formation and management of irrigated meadows as well as of watered gardens. The Lombard kings, following the Roman practice, encouraged and extended irrigation in Italy. From Lombardy the art extended to France; while the Moors encouraged it in Spain, Sicily, and Algeria. In Great Britain irrigation was not extensively practised until the close of the 18th and beginning of the present century, although one Pallavicino, an Italian of the time of Mary and Elizabeth, introduced the irrigation of fields on a large scale on his estate of Babraham in Cambridgeshire. It has been thought that some of the existing English water-meadows originated in Roman engineering skill. And the extensive tracts of irrigated land in the vicinity of ancient Roman stations, as in the neighbourhood of Cirencester, lend some support to this view.

The irrigation of grass land, laid out in accordance with one or other of the plans to which reference has been made, is in England a localized custom almost confined to a few southern counties:—Berkshire (watered by the Kennet); Derbyshire (valley of the Dove); Dorset (the Stour in the vale of Blackmore); Devonshire (cote-meadows in the valleys of many rivers and brooks); Gloucestershire (valleys of the Churn, Severn, Avon, Lidden, &c.); Hampshire (the Avon, Test, and Itchen); Wiltshire (valley of the Avon); Worcestershire (certain canals). In Scotland systematic irrigation is practised to a very limited extent, and was not introduced until the early part of the present century. It is, however, peculiarly adapted to many lands lying near rivers, which could be made most serviceable in fertilizing poor soils and bringing on an early feed of grass for sheep, while at the same time an ample supply of hay for the winter feeding of stock could thus be secured.

(A. H. C.)

**IRUN**, a frontier town of Spain, in the province of Guipúzcoa, on the left bank of the Bidassoa, opposite the French village of Hendaya. It is the northern terminus of

the Spanish Northern Railway. It has a fine Renaissance church, that of Nuestra Señora del Juncal; and its industries (iron-works, tanyarda, potteries) are in a flourishing condition. The population in 1877 was 7040.

**IRVINE**, a royal and parliamentary burgh, market town, and seaport of Ayrshire, Scotland, is situated on the north bank of the estuary of the Irvine river, and on the Glasgow and South-Western Railway, 29 miles south-south-west of Glasgow and 10 north of Ayr. It is connected with the suburb of Fullarton on the south side of the river by a fine stone bridge of four arches, originally built in 1746 and widened in 1827. The principal street is wide and spacious; and a number of handsome villas have been erected in the suburbs. Among the public buildings are the new town-hall, erected near the site of the old town-hall and jail, which dated from the end of the 14th century; the academy, erected in 1814; and several elegant churches. The ancient cross was removed in 1694. Two miles distant is Eglinton castle, the seat of the earls of Eglinton. The principal relics of antiquity are the square tower of Stanecastle, and the ancient Seagate castle, which contains some good specimens of Norman architecture,—notably a fine arch. A water-supply has lately been introduced at a cost of about £45,000. The industries include engine-making, shipbuilding, iron-founding, brass-founding, the manufacture of chemicals, brewing, and soapmaking. The shipping trade, which had considerably declined, has been steadily increasing since about 1865. The exports consist principally of coal, iron, and chemical products, and the imports of grain, timber, limestone, ores, and general produce. The population of the royal burgh in 1871 was 4229, and in 1881 it was 4511, that of the parliamentary burgh in the same years being 6866 and 8503.

Mention is made by Hoveden of a castle of Irvine or Irwin existing as early as 1184. The town is styled a burgh in a document of Robert Bruce, dated February 1308, and in a later document of the same reign mention is made of a charter granted to it by Alexander II. Towards the end of the 17th century it ranked as the third shipping port in Scotland, being next to Port-Glasgow and Leith. Irvine is the birthplace of James Montgomery and John Galt.

**IRVING, EDWARD** (1792–1834), a minister of the Scotch church, was born at Annan, Dumfriesshire, 4th August 1792. By his father's side, who followed the occupation of a tanner, he was descended from a family long known in the district, and the purity of whose Scotch lineage had been tinged by alliance with French Protestant refugees; but it was from his mother's race, the Lowthers, farmers or small proprietors in Annandale, that he seems to have derived the most distinctive features of his personality. The first stage of his education was passed at a school kept by "Peggy Paine," a relation of the well-known author of the *Age of Reason*, after which he entered the Annan academy, taught by Mr Adam Hope, of whom there is a graphic sketch in the *Reminiscences* of Thomas Carlyle. Of Irving's career at school there is nothing special to record if we except a slight liking for mathematical study, which afterwards developed itself more decidedly. Even in his early years he had a predilection for what was grave and solemn, but this tendency was also united with genial mirthfulness and a special fondness for athletic exercises.

At the age of thirteen Irving entered the university of Edinburgh. In 1809 he graduated M.A.; and in 1810, on the recommendation of Sir John Leslie, he was chosen master of an academy newly established at Haddington, where he became the tutor of Jane Welsh, afterwards the wife of Thomas Carlyle. His appointment at Haddington he exchanged for a similar one at Kirkcaldy. In 1812, completing his divinity studies by a series of partial sessions, he was "licensed" to preach in June 1815;

But continued to discharge his scholastic duties for other three years. As a teacher he acquired the reputation of being a severe disciplinarian,—apparently rather from the stern gravity with which he regarded every kind of delinquency than from excessive severity in the actual administration of chastisement; out of doors he identified himself with the recreations of his pupils in a degree rare even at the present time, mingling instruction and amusement so as to win their enthralling respect. During the latter period of his stay at Kirkcaldy Irving renewed an acquaintanceship with Thomas Carlyle, which ripened into lifelong friendship. While waiting with some impatience for a permanent opportunity to exercise his gifts in the ministry, he devoted his leisure, not only to mathematical and physical science, but to a course of reading in English literature, his bias towards the antique in sentiment and style being strengthened by a perusal of the older classics, among whom Richard Hoëker, denominated by him “the venerable companion of my early days,” was his favourite author. At the same time his love of the marvellous found gratification in the wonders of the *Arcadian Nights*, and it is further characteristically related of him that he used to carry continually in his waistcoat pocket a miniature copy of *Ossian*, passages from which he frequently recited with “sonorous elocution and vehement gesticulation.”

The impression which Irving's early appearances as a preacher produced upon his hearers seems to have been more of a perplexing and bewildering than an edifying character; but he himself never seems to have been troubled with doubts as to whether preaching was his “vocation.” In the summer of 1818 he resigned his mastership, and, in order to increase the probability of obtaining a permanent appointment in the church, took up his residence in Edinburgh, where he now resolved to write according to a new system specially adapted to the wants of the age. Yet, although his exceptional method of address seems to have gained him the qualified approval of certain dignitaries of the church, the prospect of his obtaining a settled charge seemed as remote as ever, and he was meditating a missionary tour in Persia when his departure was arrested by steps taken by Dr Chalmers, which after considerable delay resulted, in October 1819, in Irving being appointed his assistant and missionary in St John's Parish, Glasgow. Except in the case of a select few, Irving's preaching awakened little interest among the congregation of Chalmers, Chalmers himself, with no partiality for its bravuras and flourishes, comparing it to “Italian music appreciated only by connoisseurs”; but as a missionary among the poorer classes he wielded an influence that was altogether unique. The benediction “Peace be to this house,” with which, in accordance with apostolic usage, he greeted every dwelling he entered, was not inappropriate to his figure and aspect, and it is said “took the people's attention wonderfully,” the more especially after the magic of his personality found opportunity to reveal itself in close and homely intercourse. This half-success in a subordinate sphere was, however, so far from coinciding with his aspirations that he had again, in the winter of 1821, begun to turn his attention towards missionary labour in the East, when the possibility of fulfilling the dream of his life was suddenly revealed to him by an invitation from the Caledonian church, Hatton Garden, London, to “make trial and proof” of his gifts before the “remnant of the congregation which held together.” Over that charge he was ordained in July 1822. Some years previously he had expressed his conviction that “one of the chief needs of the age was to make inroad after the alien, to bring in the votaries of fashion, of literature, of sentiment, of policy,

and of rank, who are content in their several idolatries to do without piety to God and love to Him whom He hath sent;” and, with an abruptness which must have produced on him at first an effect almost astounding, he now had the satisfaction of beholding these various votaries thronging to hear from his lips the words of wisdom which would deliver them from their several idolatries and remodel their lives according to the fashion of apostolic times. This sudden leap into popularity seems to have been occasional in connexion with a veiled allusion to Irving's striking eloquence made in the House of Commons by Canning, who had been induced to attend his church from admiration of an expression in one of his prayers, quoted to him by Sir James Mackintosh. As far as the mere manner of Irving's eloquence was concerned, it was improbable that any eulogy could err on the side of warmth and enthusiasm, for perhaps there never was any one more highly gifted with what may be called the personal qualifications of an orator. His commanding stature, the admirable symmetry of his form, the dark and melancholy beauty of his countenance, rather rendered piquant than impaired by an obliquity of vision, produced an imposing impression even before his deep and powerful voice had given utterance to its melodious thunders; and harsh and superficial half-truths enunciated with surpassing ease and grace of gesture, and not only with an air of absolute conviction but with the authority of a prophetic messenger in tones whose magical fascination was inspired by an earnestness beyond all imitation of art, acquired a plausibility and importance which, at least while the orator spoke, made his audience entirely forgetful of their preconceived objections against them. The subject-matter of his orations, and his peculiar treatment of his themes, no doubt also at least at first constituted a considerable part of his attractive influence. He had specially prepared himself, as he thought, for “teaching imaginative men, and political men, and legal men, and scientific men who bear the world in hand”; and he did not attempt to win their attention to abstract and worn-out theological arguments, but discussed the opinions, the poetry, the politics, the manners and customs of the time, and this not with philosophical comprehensiveness, not in terms of warm eulogy or measured blame, but of severe satire varied by fierce denunciation, and with a specific minuteness which was concerned primarily with individuals. Indeed it was the titillation produced by his picturesque unconventionality rather than any contagious emanation from his intense moral energy that formed the principal basis of connexion between him and his audience, with the majority of whom he was so deeply out of sympathy. The pungency of the titillation was sufficiently evidenced by the fire of criticism from pamphlets, newspapers, and reviews which opened on his volume of *Orations*, published in 1823; but the excitement produced was merely superficial and essentially evanescent. Though cherishing a strong antipathy to the received ecclesiastical formulas, Irving's great aim was to revive the antique style of thought and sentiment which had hardened into these formulas, and by this means to supplant the new influences, the accidental and temporary moral shortcomings of which he detected with instinctive certainty, but whose profound and real tendencies were utterly beyond the reach of his conjecture. Being thus radically at variance with the main current of the thought of his time, the failure of the commission he had undertaken was sooner or later inevitable; and shortly after the opening of his new church in Regent Square in 1827, he found that “fashion had taken its departure,” and the church, “though always well filled,” was “no longer crowded.” By this desertion his self-esteem, one of his strongest passions, though curiously united with singular sincerity and humility, was doubtless hurt



to the quick; but the wound inflicted was of a deeper and deadlier kind, for it confirmed him finally in his despair of the world's gradual amelioration, and imparted to his tendency towards supernaturalism a supremacy which virtually produced the partial suspension of his intellectual faculties. For years the subject of prophecy had occupied much of his thoughts, and his belief in the near approach of the second advent had received such wonderful corroboration by the perusal of the work of a Jesuit priest, writing under the assumed Jewish name of Juan Josafat Ben-Ezra, that in 1827 he published a translation of it, accompanied with an eloquent preface. Probably the religious opinions of Irving, originally in some respects more catholic and truer to human nature than generally prevailed in ecclesiastical circles, had gained breadth and comprehensiveness from his intercourse with Coleridge, but gradually his chief interest in Coleridge's philosophy centred round that which was mystical and obscure, and to it in all likelihood may be traced his initiation into the doctrine of millenarianism, although Irving's imagination laid hold of this doctrine as an indispensable contrast to the dark and hopeless foreground of the present, which his morbid and incurable melancholy had led him to represent as robed in the gloomy draperies of the "reign of Satan." Towards supernaturalism he was indeed impelled, apart altogether from any accidental association with individuals, both by certain peculiar blemishes in his character and by its noblest excellences; and it seemed a foregone necessity that he should become the moral victim of the struggle between the old and new faiths. He had so imbibed the spirit of apostolic times, and had accepted the old forms of Scriptural truths in such entire good faith, that he virtually lived in an atmosphere of which the miraculous constituted the principal element, and the tendency towards supernaturalism thus associated with a profound moral sincerity was strengthened as well as tainted by alliance with a love of outward magnificence and splendour, and a restless craving after excitement, the result of misused and over-exerted energy.

The history of the remainder of Irving's career is a striking example of the power of one delusive prepossession partly to stifle and partly to frustrate the beneficent exercise of noble mental and moral gifts. Impracticable, visionary, deficient in appreciation of a whole side of human nature, and without real depth of humour, he became the compliant tool of almost any one who offered to supply him with the necessary corroboration of his own absorbing hallucination. The first stage of his deflexion was associated with the prophetic conferences at Albany, followed by an almost exclusive study of the prophetic books and especially of the Apocalypse, and by several series of sermons on prophecy both in London and the provinces, his apocalyptic lectures in 1828 more than crowding the largest churches of Edinburgh in the early summer mornings. In 1830, however, there was opened up to his ardent imagination a new vista into spiritual things, a new hope for the age in which he lived, by the seeming actual revival in a remote corner of Scotland of those apostolic gifts of prophecy and healing which he had already in 1828 persuaded himself had only been kept in abeyance by the absence of faith. At once he welcomed the new "power" with an unquestioning evidence which could be shaken by neither the remonstrances or desertion of his dearest friends, the recantation of some of the principal agents of the "gifts," his own deflexion into a comparatively subordinate position, the meagre and barren results of the manifestations, nor their general rejection both by the church and the world. His excommunication by the presbytery of London, in 1830, for publishing doctrines regarding the humanity of Jesus Christ now generally held by the broad school of theologians, and the condemnation of these opinions by the General Assembly of the Church of Scotland in the following year, were irrelevant and secondary episodes which only affected the main issue of his career in so far as they tended still further to isolate him from the sympathy of the church; but the "irregularities" connected with the manifestation of the "gifts" gradually estranged the majority of his own congregation, and on the complaint of the trustees to the presbytery of London, whose authority they had formerly rejected, he was declared unfit to remain the minister of the National Scotch Church of Regent Square. After he and those who adhered to him had removed to a new building in Newman

Street, he was in March 1833 deposed from the ministry of the Church of Scotland by the presbytery of Annan on the original charge of heresy. With the sanction of the "power" he was now after some delay reordained "chief pastor of the church assembled in Newman Street," but unremitting labours and ceaseless spiritual excitement soon completely exhausted the springs of his vital energy. "Commissioned" by the "power" as "a prophet to do a great work in his native land," he, notwithstanding that he was "sinking under a deep consumption," undertook a mission to Glasgow, where, though his "gigantic frame" was now seen to "bear all the marks of age and weakness," and his "tremendous voice" had become "tremulous," he bated no jot of heart or hope; and even when "stretched in utter weakness," and "visibly dying," he, with unflinching faith in the testimony of the prophetic voice, waited for the moment when God "should bring life and strength." He died worn out and wasted with labour and absorbing care while still in the prime of life, 4th December 1834.

The writings of Edward Irving published during his lifetime are *For the Oracles of God, Four Orations*, 1823; *For Judgment to come*, 1823; *Babylon and Infidelity foredoomed*, 1826; *Sermons, &c.*, 3 vols., 1828; *Exposition of the Book of Revelation*, 1831; an introduction to a translation of Ben Ezra; and an introduction to Horne's *Commentary on the Psalms*. His collected works have been published in 5 volumes, edited by Gavin Carlyle. The earlier of his writings abound in passages of finely figurative eloquence rising occasionally into a strain of sublime poetic spiritualism, sometimes breaking out into wild notes of melancholy and touching lamentation, and again hardening into vehement and scornful invective. They manifest, not only a keen sense of the beauties of nature, but a genuine interest in literature and art, a comprehensive if somewhat vague intellectual grasp, and a moral discernment penetrating and subtle, but tending towards narrowness of temper and sympathy. The style, however, is so much influenced in its forms by his study of the older writers as to seem stiff and antiquated, in addition to which many of its finer passages are marred by glaring errors of taste, while there are already signs of that tendency to irrelevancy and diffuseness which imparts such tediousness to his later writings, and along with the exaggeration of his other defects, contributed to deprive them of nearly all literary charm as well as of moral and intellectual worth.

*The Life of Edward Irving*, by Mrs Oliphant, appeared in 1862 in two vols. Among a large number of biographies published previously, that by Washington Wilks, 1854, has some merit. See also Hazlitt's *Spirit of the Age*; Coleridge's *Notes on English Divines*; Carlyle's *Miscellanies*; and Carlyle's *Reminiscences*, vol. 1., 1881. (T. F. H.)

IRVING, WASHINGTON (1783-1859), the first American who obtained a European reputation merely as a man of letters, was born at New York, April 3, 1783. Both his parents were immigrants from Great Britain, his father, originally an officer in the merchant service, but at the time of Irving's birth a considerable merchant, having come from the Orkneys, and his mother from Falmouth. Irving was intended for the legal profession, but his studies were interrupted by an illness necessitating a voyage to Europe, in the course of which he proceeded as far as Rome, and made the acquaintance of Washington Allston. He was called to the bar upon his return, but made little effort to practise, preferring to amuse himself with literary ventures. The first of these of any importance, a satirical miscellany entitled *Salmagundi*, written in conjunction with his brother William and J. K. Paulding, gave ample proof of his talents as a humorist. These were still more conspicuously displayed in his next attempt, *Knickerbocker's History of New York* (1809). The satire of *Salmagundi* had been principally local, and the original design of *Knickerbocker's History* was only to burlesque a pretentious disquisition on the history of the city in a guide-book by Dr Samuel Mitchell. The idea expanded as Irving proceeded, and he ended by not merely satirizing the pedantry of local antiquaries, but by creating a distinct literary type out of the solid Dutch burgher whose phlegm had long been an object of ridicule to the mercurial Americans. Though far from the most finished of Irving's productions, *Knickerbocker* manifests the most original power, and is the most genuinely national in its quaintness and drollery. The very tardiness and prolixity of the story are skilfully made to heighten the humorous effect. The next few years

were unproductive. Upon the death of his father, Irving had become a sleeping partner in his brother's commercial nouse, a branch of which was established at Liverpool. This, combined with the restoration of peace, induced him to visit England in 1815, when he found the stability of the firm seriously compromised. After some years of ineffectual struggle it became bankrupt. This misfortune compelled Irving to resume his pen as a means of subsistence. His reputation had preceded him to England, and the curiosity naturally excited by the then unwonted apparition of a successful American author procured him admission into the highest literary circles, where his popularity was insured by his amiable temper and polished manners. As an American, moreover, he aroused no jealousy and no competition, and stood aloof from the political and literary disputes which then divided England. Campbell, Jeffrey, Moore, Scott, were counted among his friends, and the last-named zealously recommended him to the publisher Murray, who, after at first refusing, consented (1820) to bring out *Geoffrey Crayon's Sketch Book*, which was already appearing in America in a periodical form. The most interesting part of this work is the description of an English Christmas, which displays a delicate humour not unworthy of the writer's evident model Addison. Some stories and sketches on American themes contribute to give it variety; of these Rip van Winkle is the most remarkable. It speedily obtained the greatest success on both sides of the Atlantic. *Bracebridge Hall*, a work purely English in subject, followed in 1822, and showed to what account the American observer had turned his experience of English country life. The humour is, nevertheless, much more English than American. *Tales of a Traveller* appeared in 1824, and Irving, now in comfortable circumstances, determined to enlarge his sphere of observation by a journey on the Continent. After a long course of travel, he settled down at Madrid in the house of the American consul Rich. His intention at the time was to translate Navarrete's recently published work on Columbus; finding, however, that this was rather a collection of valuable materials than a systematic biography, he determined to compose a biography of his own by its assistance, supplemented by independent researches in the Spanish archives. His work appeared in 1828, and obtained a merited success. It is a finished representation of Columbus from the point of view of the 19th century, affecting neither brilliancy nor originality, but a model of tasteful elegance, felicitous in every detail and adequate in every respect. *The Companions of Columbus* followed; and a prolonged residence in the south of Spain gave Irving materials for two highly picturesque books, *The Conquest of Granada*, professedly derived from the MSS. of an imaginary Fray Antonio Agapida, and *The Alhambra*. Previous to their appearance he had been appointed secretary to the embassy at London, an office as purely complimentary to his literary ability as the legal degree which he about the same time received from the university of Oxford. Returning to the United States in 1832, after seventeen years' absence, he found his name a household word, and himself universally honoured as the first American who had won for his country recognition on equal terms in the literary republic. After the rush of fêtes and public compliments had subsided, he undertook a tour in the western prairies, and returning to the neighbourhood of New York built for himself a delightful retreat on the Hudson, to which he gave the name of "Sunnyside." His acquaintance with the New York millionaire John Jacob Astor prompted his next important work—*Astoria*, a history of the fur-trading settlement founded by Astor in Oregon, deduced with singular literary ability from dry commercial records, and, without laboured attempts at word-painting, evincing a

remarkable faculty for bringing scenes and incidents vividly before the eye. *Captain Bonneville*, based upon the unpublished memoirs of a veteran hunter, was another work of the same class. In 1842 Irving was appointed ambassador to Spain. He spent four years in the country, without this time turning his residence to literary account; and it was not until two years after his return that Forster's *Life of Goldsmith*, by reminding him of a slight essay of his own which he now thought too imperfect by comparison to be included among his collected writings, stimulated him to the production of his own biography of his favourite author. Without pretensions to original research, the book displays an admirable talent for employing existing material to the best effect. The same may be said of *The Lives of Mahomet and his Successors*, published two years subsequently. Here as elsewhere Irving has correctly discriminated the biographer's province from the historian's, and, leaving the philosophical investigation of cause and effect to writers of Gibbon's calibre, has applied himself to represent the picturesque features of the age as embodied in the actions and utterances of its most characteristic representatives. His last days were devoted to a biography of Washington, undertaken in an enthusiastic spirit, but which the author found exhausting and his readers tame. His genius required a more poetical theme, and indeed the biographer of Washington must be at least a potential soldier and statesman. Irving just lived to complete this work, dying of heart disease at Sunnyside, on November 28, 1859.

Although one of the chief ornaments of American literature, Irving is not characteristically an American author. Like most of the Transatlantic writers of his generation, he disappointed expectation by a scrupulous conformity to acknowledged European standards. The American vine had not then begun to produce the looked-for wild grapes. Irving, however, is one of the few authors of his period who really manifests traces of a vein of national peculiarity which might under other circumstances have been productive. *Knickerbocker's History of New York*, although the air of mock solemnity which constitutes the staple of its humour is peculiar to no literature, manifests nevertheless a power of reproducing a distinct national type. Had circumstances taken Irving to the West, and placed him amid a society teeming with quaint and genial eccentricity, he might possibly have been the first Western humorist, and his humour might have gained in depth and richness. In England, on the other hand, everything encouraged his natural fastidiousness; he became a refined writer, but by no means a robust one. At the same time he is too essentially the man of his own age to pass for a paler Addison or a more decorous Sterne. He has far more of the poet than any of the writers of the 18th century, and his moralizing, unlike theirs, is unconscious and indirect. The same poetical feeling is shown in his biographies; his subject is invariably chosen for its picturesqueness, and whatever is unessential to portraiture is thrown into the background. The result is that his biographies, however deficient in research, bear the stamp of genuine artistic intelligence, equally remote from compilation and disquisition. In execution they are almost faultless; the narrative is easy, the style pellucid, and the writer's judgment nearly always in accordance with the general verdict of history. They will not, therefore, be easily superseded, and indeed Irving's productions are in general impressed with "that signet of classical finish which guarantees the permanency of literary work more surely than direct utility, or even intellectual power. This refinement is the more admirable for being in great part the reflection of his own moral nature. Without ostentation or affectation, he was exquisite in all things, a mirror of loyalty, courtesy and good



taste in all his literary connexions, and exemplary in all the relations of domestic life which he was called upon to assume. He never married, remaining true to the memory of an early attachment blighted by death.

The principal edition of Irving's works is the "Geoffrey Crayon," published at New York in 1880, in 26 vols. His life, accompanied by copious extracts from his correspondence, was published by his nephew Pierre (London, 1862-64, 4 vols.). A German abridgment of this work has been ably executed by Adolf Lamm (Berlin, 1870, 2 vols.). There is a good deal of miscellaneous information in a compilation entitled *Irvingiana* (New York, 1860); and Bryant's memorial oration, though somewhat too uniformly laudatory, may be consulted with advantage. It has been republished in 1880, along with C. Dudley Warner's introduction to the "Geoffrey Crayon" edition, and Mr G. P. Putnam's personal reminiscences of Irving, which originally appeared in the *Atlantic Monthly*. (R. G.)

ISAAC (צִיָּאָה or צִיָּאָה, "he laughs"; Ἰσαάκ, Ἰσαάκος), the only child of Abraham and Sarah, was born when his parents were respectively a hundred and ninety years of age (Gen. xvii. 17). Explanations of the name seem to be intended by the sacred writer in more than one reference to the incredulous or joyous laughter of his parents when a son was promised to them (Gen. xxi. 6, xviii. 12, xvii. 17). Like his father, Isaac lived a nomadic pastoral life, but within much narrower local limits, and with an occasional experiment in agriculture (Gen. xxvi. 12). After the death of his mother, he married Rebekah the daughter of his cousin Bethuel, by whom after twenty years of married life he became the father of Esau and Jacob. He died at the age of one hundred and eighty. The most striking episode of his life as related in the Biblical record is that which took place while he was still young, "in the land of Moriah," when at the last moment he was by angelic interposition released from the altar on which he was about to be sacrificed by his father in obedience to a divine command. Other occurrences which have been recorded have striking resemblances to incidents in the life of Abraham. Of a less marked and energetic individuality than his father and sons, Isaac is by general consent of the Christian church taken as a representative of the unobtrusive, restful, piously contemplative type of human character. By later Judaism, which fixed its attention chiefly on the altar scene, he was regarded as the pattern and prototype of all martyrs. The Mahometan legends regarding him are curious, but trifling. Among the far-fetched attempts of those who prefer a mythological interpretation of the early incidents of the Bible narrative may be mentioned those of Goldziher, who sees in Isaac a personification of the smiling light of the ruddy evening sky, and of Popper, who identifies the name with that of the dragon Azhi dahāka of Eranian folklore. See Ewald, *Gesch. d. V. Isr.*, vol. i.; and Herzog-Plitt, *Realencyk.* vol. viii., art. "Isaak."

ISAAC I., COMNENUS, Roman emperor of the East from 1057 to 1059, was the son of a gallant officer under Basil II., named Manuel Comnenus, who on his deathbed commended his two sons Isaac and John to the emperor's care. Basil caused them to be carefully educated at the monastery of the Studium, and afterwards advanced them to high official positions. During the disturbed reigns of Basil's seven immediate successors, Isaac, serving in the army, acted prudently and cautiously; and, when the insults of Michael, the eighth from Basil, stung the nobles and generals into rebellion, Caracalon, the leader of the conspiracy, induced the rebels to proclaim Isaac emperor. Michael, conquered in one battle, was forced to assume the monastic habit, and Isaac ascended the throne in August 1057. The first care of the new emperor was to reward his noble partisans with appointments that removed them from Constantinople, and his next was to repair the beggared finances of the empire. He revoked numerous

pensions and grants conferred by his predecessors upon idle courtiers, and, disregarding the charge of sacrilege, and meeting the insolent menaces of the patriarch of Constantinople by a decree of exile, resumed a proportion of the revenues of the wealthy monasteries. Isaac's only military expedition was against the Hungarians and Patzinaks, who began to ravage the northern frontiers in 1059. Shortly after his successful return he was seized with an illness, and believing it mortal appointed as his successor Constantine Ducas, to the exclusion of his own brother John. Although he recovered from his illness, Isaac did not resume the purple, but, retiring to the monastery of the Studium, spent the remaining two years of his life as a humble monk, alternating menial offices with literary studies. His *Scholion* to the *Iliad*, and other works on the Homeric poems, are still extant in MS. Isaac died in the year 1061. He was a good and just prince, and his reign justified his choice as emperor. He was grave and reserved, and, more affable in deed than in word, offended many by his haughtiness and soldierlike brusqueness; while the fact that he coined money with the image of a drawn sword was attributed to his arrogance and impiety. His great aim was to restore and maintain the early splendid organization of the government, and his reforms, directed to that end, though unpopular with the aristocracy and the clergy, and not understood by the people, certainly contributed to stave off for a little while longer the final ruin of the Byzantine empire.

ISAAC II., ANGELUS, Roman emperor of the East from 1185 to 1195, and again in 1203-4, who came to the throne in the manner described under ANDRONICUS I. (vol. ii. p. 23), succeeded also to the unfinished Sicilian war. The favourable close of that was counterbalanced by the failure of an attempt to recover Cyprus, where Isaac Comnenus had established an independent throne. Of the numerous revolts excited during Isaac's reign by his vices and incapacity, the most serious was the rebellion of the Bulgarians and Wallachians between Mount Hamus and the Danube, which, breaking out in 1186, resulted in the independence of a second Bulgarian kingdom. Alexis Branas, the general sent against the rebels in 1187, after temporarily repulsing them, treacherously turned his arms against his master, and, leading his troops to Constantinople, attempted to seize the city. There he met with more resistance than Isaac's vices had led him to expect, and in the ensuing battle was defeated and slain. After a hastily-arranged truce with the Bulgarians, the emperor's attention was next demanded in the east, where several claimants to the throne successively rose and fell. In 1189 Frederick Barbarossa of Germany sought and obtained leave to lend his troops on the third crusade through the Byzantine territory; but he had no sooner crossed the border than the wily and treacherous Greek, who had meanwhile sought an alliance with Saladin, threw every impediment in his way, and was only by force of arms compelled to fulfil his engagements. The next five years were disturbed by fresh rebellions of the Wallachians, against whom Isaac led several expeditions in person. During one of these, in 1195, Alexius, the emperor's brother, taking advantage of the latter's absence from camp on a hunting expedition, proclaimed himself emperor, and was joyfully hailed by the soldiers, who heartily despised the craven vices of their late emperor. Isaac was seized; his eyes were put out, and he was imprisoned in a lonely tower at Constantinople. It has already been related (CRUSADES, vol. vi. p. 629) how after eight years Isaac was raised for six months from his dungeon to his throne once more. But both mind and body had been enfeebled by captivity, and his son Alexius IV. was the actual monarch. Isaac's feeble hold on life was loosened by the turmoil which followed the restoration,

and he died in 1204. He was one of the weakest and most vicious princes that ever occupied the Byzantine throne. His father had been censured as a general for cowardice, and Isaac II. seems to have inherited a full share of the paternal failing, which his connexion on the mother's side with the Comnenian family had not counteracted. He was vain, superstitious, and sensual; and, while he neglected the duties of his lofty position, he abandoned himself to all the pleasures which it commanded. Surrounded by a crowd of slaves, mistresses, and flatterers, he permitted his empire to be administered by unworthy favourites, while he squandered the vast sums of money wrung from his unhappy provinces on costly buildings and expensive gifts to the churches of his metropolis. It is little to be wondered at that his cowardice and vice stirred up numerous rivals, who sought to emulate the ease with which a creature so worthless had obtained an empire.

ISABELLA (1451-1504), surnamed *la Católica*, "the Catholic," queen of Castile from 1474, was the second child and only daughter of John II. of Castile by his second wife Isabella, granddaughter of John I. of Portugal (thus being through both parents a descendant of the famous John of Gaunt, duke of Lancaster), and was born at Madrigal on April 22, 1451. On the death of her father, who was succeeded by her brother Henry IV. (1454), she was withdrawn by her mother to Arealo, where her early education was conducted in the deepest seclusion; in 1462, however, after the birth of Joanna "Beltraneja," she was, along with her uterine brother Alphonso, removed by Henry to the court, where she showed a remarkable example of staidness and sobriety. Already more than one suitor had made application for her hand, Ferdinand of Aragon, who ultimately became her husband, being among the number; for some little time she was engaged to his elder brother Carlos, who died in 1461. When in her thirteenth year her brother promised her in marriage to Alphonso of Portugal, but to this union she firmly refused to consent; her resistance seemed less likely to be effectual in the case of the marquis of Villena, the grand master of the order of Calatrava, to whom she was next affianced, when she was delivered from her fears by the sudden death of the bridegroom while on his way to the nuptials (1466). After an offer of the crown of Castile, made by the revolutionary leaders in the civil war, had been declined by her, she was in 1468 formally recognized by her brother as lawful heir, after himself, to the united crowns of Castile and Leon. New candidates for her hand now appeared in the persons of a brother of Edward IV. of England (probably Richard, duke of Gloucester), and of the duke of Guienne, brother of Louis XI., and heir presumptive of the French monarchy. Finally, however, in face of very great difficulties, she was married to Ferdinand of Aragon at Valladolid on October 19, 1469. Thenceforward the fortunes of the two spouses were inseparably blended (see FERDINAND, vol. viii. p. 81). For some time they held a humble court at Dueñas, and afterwards they resided at Segovia, where on the death of Henry she was proclaimed queen of Castile and Leon (December 13, 1474). The first months of her reign were fully employed in coping with domestic disaffection and in repelling invasion from Portugal; but peace was soon secured on a basis of such firmness and permanence as rendered possible that successful policy the main features of which have already been sketched elsewhere. Spain undoubtedly owed to Isabella's clear intellect, resolute energy, and unselfish patriotism much of that greatness which for the first time it acquired under "the Catholic sovereigns." The moral influence of the queen's personal character over the Castilian court was incalculably great; from the debasement and degradation of the preceding reign she raised it to being "the nursery of virtue and of

generous ambition." The very sincerity of her piety and strength of her religious convictions led her more than once, however, into great errors of state policy, which have never since been repaired, and into more than one act which offends the moral sense of a more refined age; her efforts for the introduction of the Inquisition into Castile, and for the proscription of the Jews, are outstanding evidences of what can only be called her bigotry. But not even the briefest sketch of the facts of her life can omit to notice that happy instinct or intuition which led her, when all others had heard with incredulity the scheme of Columbus, to recall the wanderer to her presence with the words "I will assume the undertaking for my own crown of Castile, and am ready to pawn my jewels to defray the expenses of it, if the funds in the treasury should be found inadequate." She died at Medina del Campo on November 24, 1504, and was succeeded by her daughter Joanna "la loca" (the "Crazy") with Ferdinand as regent. See Prescott, *History of the Reign of Ferdinand and Isabella*, where the original authorities are exhaustively enumerated.

ISABEY, JEAN BAPTISTE (1767-1855), was born at Nancy on the 11th April 1767. At nineteen, after some lessons from Dumont, miniature painter to Marie Antoinette, he became a pupil of David. Employed at Versailles on portraits of the dukes of Angoulême and Berry, he was given a commission by the queen, which opens the long list of those which he received, up to the date of his death in 1855, from the successive rulers of France. Patronized by Josephine and Napoleon, he arranged the ceremonies of their coronation and prepared drawings for the publication intended as its official commemoration, a work for which he was paid by Louis XVIII., whose portrait (engraved, Debucourt) he executed in 1814. Although Isabey did homage to Napoleon on his return from Elba, he continued to enjoy the favour of the Restoration, and took part in arrangements for the coronation of Charles X. The monarchy of July conferred on him an important post in connexion with the royal collections, and Napoleon III. granted him a pension, and the cross of commander of the Legion of Honour. Review of Troops by the First Consul was one of his most important compositions, and Isabey's Boat,—a charming drawing of himself and family—produced at a time when he was much occupied with lithography—had an immense success at the Salon of 1820 (engraved, Landon, *Annales*, vol. i. p. 125). His portrait of Napoleon at Malmaison is held to be the best ever executed, and even his tiny head of the king of Rome, painted for a breast-pin, is distinguished by a decision and breadth which evidence the hand of a master.

A biography of Isabey was published by M. E. Taigny in 1859, and M. C. Lenormant's article, written for Michaud's *Diog. Univ.* is founded on facts furnished by Isabey's family.

ISÆUS owes his place in the decade of the Attic orators to his mastery of forensic argument; but his literary significance, in relation to the historical development of Attic prose, is not inferior to that of any other name in the series. The chronological limits of his extant work fall between the years 390-353 B.C.; and his birth may with probability be placed about 420 B.C. The Plutarchic life describes him as a Chalcidian; Suidas, whom Dionysius follows, as an Athenian. The accounts have been reconciled by supposing that his family sprang from the settlement (*κληρονομία*) of Athenian citizens among whom the lands of the Chalcidian hippobotæ (knights) had been divided about 509 B.C. In 411 B.C. Eubœa (except Oreos) revolted from Athens; and it would not have been strange if residents of Athenian origin had then migrated from the hostile island to Attica. Such a connexion with Eubœa would explain the non-Athenian name Diagoras which is borne by the father of Isæus, while the latter is



said to have been "an Athenian by descent" (*Ἀθηναῖος τὸ γένος*). So far as we know, Isæus took no part in the public affairs of Athens. "I cannot tell," says Dionysius, "what were the politics of Isæus—or whether he had any politics at all." These words strikingly attest the profound change which was passing over the life of the Greek cities. It would have been scarcely possible, fifty years earlier, that an eminent Athenian with the powers of Isæus should have failed to leave on record some proof of his interest in the political concerns of Athens or of Greece. But now, with the decline of personal devotion to the state, the life of an active citizen had ceased to have any necessary contact with political affairs. Professional pursuits, determined by private choice and directed to private ends, could now engross all those energies which would once have been devoted, at least in large measure, to the service of the city. The very fact that almost nothing is known about the life of Isæus is itself the most suggestive of facts. Already we are at the beginning of that transition which is to lead from the old life of Hellenic citizenship to that Hellenism whose children are citizens of the world.

There is good authority for the tradition that Isæus was the pupil of Isocrates,—probably about 393 B.C., when Isocrates was beginning his career as a teacher, and while Isæus was not yet occupied with his special calling. Internal evidence for such intercourse may be found in the method of handling subject-matter which some extant speeches of Isæus exhibit. Though not a pupil, Isæus had certainly been a student of Lysias. A passage of Photius has been understood as meaning that personal relations had existed between Isæus and Plato; but this view appears to rest on an erroneous construction of the passage in question.<sup>1</sup>

The profession of Isæus was that of which Antiphon had been the first representative at Athens—that of a *λογογράφος*, who composed speeches which his clients were to deliver in the law-courts. But, while Antiphon had written such speeches chiefly (as Lysias frequently) for public causes, it was with private causes that Isæus was almost exclusively concerned. The fact marks the progressive subdivision of labour in his calling, and the extent to which the smaller interests of private life now absorbed the attention of the citizen.

The most interesting recorded event in the career of Isæus is one which belongs to its middle period—his connexion with Demosthenes. Born in 384 B.C.; Demosthenes attained his civic majority in 366. At this time he had already resolved to prosecute the fraudulent guardians who had stripped him of his patrimony. In prospect of such a legal contest, he could have found no better ally than Isæus, a master of Attic law, especially where claims to property were at issue, and one who for upwards of twenty years had been eminently successful as a writer of speeches for the law courts. That the young Demosthenes actually resorted to the aid of Isæus is beyond reasonable doubt. But the pseudo-Plutarch embellishes the story after his fashion. He says that Demosthenes, on coming of age, took Isæus into his house, and studied with him for four years—paying him the sum of 10,000 drachmas (about £400), on condition that Isæus should withdraw from a school of rhetoric which he had opened, and devote himself wholly to his new pupil. The real Plutarch gives us a more sober and a more probable version. He simply states that Demosthenes "employed Isæus as his master in rhetoric, though Isocrates was then teaching, either (as some say) because he could not pay Isocrates, he prescribed

fee of ten minæ, or because he preferred the style of Isæus for his purpose, as being *vigorous and astute*" (*δραστήριον καὶ πανοῦργον*). It may be observed that, except by the pseudo-Plutarch, a school of Isæus is not mentioned,—for a notice in Plutarch need mean no more than that he had written a text-book, or that his speeches were read in schools;<sup>2</sup> nor is any other pupil named. As to Demosthenes, his own speeches against Aphobos and Onetor (363–62 B.C.) afford the best possible gauge of the sense and the measure in which he was the disciple of Isæus; the intercourse between them can scarcely have been either very close or very long. The date at which Isæus died can only be conjectured from his work; it may be placed about 350 B.C.

Isæus has a double claim on the student of Greek literature. He is the first Greek writer who comes before us as a consummate master of strict forensic controversy. He also holds a most important place in the general development of practical oratory, and therefore in the history of Attic prose. Antiphon marks the beginning of that development, Demosthenes its consummation. Between them stand Lysias and Isæus. The open, even ostentatious, art of Antiphon had been austere and rigid. The concealed art of Lysias had charmed and persuaded by a versatile semblance of natural grace and simplicity. Isæus brings us to a final stage of transition, in which the gifts distinctive of Lysias were to be fused into a perfect harmony with that masterly art which receives its most powerful expression in Demosthenes. Here, then, are the two cardinal points by which the place of Isæus must be determined. We must consider, first, his relation to Lysias; secondly, his relation to Demosthenes.

A comparison of Isæus and Lysias must set out from the distinction between choice of words (*λέξις*) and mode of putting words together (*σύνθεσις*). In choice of words, *diction*, Lysias and Isæus are closely alike. Both are clear, pure, simple, concise; both have the stamp of persuasive plainness (*ἀφέλεια*), and both combine it with graphic power (*ἐνάργεια*). In mode of putting words together, *composition*, there is, however, a striking difference. Lysias threw off the stiff restraints of the earlier periodic style, with its wooden monotony; he is too fond indeed of antithesis always to avoid a rigid effect; but, on the whole, his style is easy, flexible, and various; above all, its subtle art usually succeeds in appearing natural. Now this is just what the art of Isæus does not achieve. With less love of antithesis than Lysias, and with a diction almost equally pure and plain, he yet habitually conveys the impression of conscious and confident art. Hence he is least effective in adapting his style to those characters in which Lysias peculiarly excelled,—the ingenuous youth, the homely and peace-loving citizen. On the other hand, his more open and vigorous art does not interfere with his moral persuasiveness where there is scope for reasoned remonstrance, for keen argument, or for powerful denunciation. Passing from the formal to the real side of his work, from diction and composition to the treatment of subject-matter, we find the divergence wider still. Lysias usually adheres to a simple four-fold division—proem, narrative, proof, epilogue. Isæus frequently interweaves the narrative with the proof.<sup>3</sup> He shows the most dexterous ingenuity in adapting his manifold tactics to the case in hand, and often "out-generals" (*καταστραγγεῖ*) his adversary by some novel and daring disposition of his forces. Lysias, again, usually contents himself with a merely rhetorical or sketchy proof; Isæus aims at strict logical demonstration, worked out through all its steps. As Sir William Jones well remarks, Isæus lays close siege to the understandings of the jury.<sup>4</sup>

<sup>1</sup> Plut., *De glor. athen.*, p. 350 c, where he mentions τοὺς Ἰσοκράτους καὶ Αντιφώντας καὶ Ἰσαίου among τοὺς ἐν ταῖς σχολαῖς τὰ μερῶνα προδιδάσκοντας.

<sup>2</sup> Here he was probably influenced by the teaching of Isocrates. The forensic speech of Isocrates known as the *Egineticus* (Or. xix.), which belongs to the peculiar province of Isæus, as dealing with a claim to property (*ἐπιδικασία*), affords perhaps the earliest example of narrative and proof thus interwoven. Earlier forensic writers had kept the *διήγησις* and *πίστευσις* distinct, as Lysias does.

<sup>3</sup> This is what Dionysius means when he says that Isæus differs from Lysias—τῶ μὴ κατ' ἐνθυμητὰ τι λέγειν ἀλλὰ κατ' ἐπιχείρημα (*Isæ.* 16). Here the "enthymeme" means a rhetorical syllogism with one premiss suppressed ("curtium," *Juv.*, vi. 449); "epicheireme," such a syllogism stated in full. Cf. Volkmann, *Rhetorik der Griechen und Römer*, 1872, pp. 153 f.

<sup>1</sup> On this point (as on some others which can be, but briefly noticed here) the reader is referred to the detailed treatment of the subject in *Jebb's Attic Orators from Antiphon to Isæus*, vol. ii. p. 264.

Such is the general relation of Isæus to Lysias. What, we must next ask, is the relation of Isæus to Demosthenes? The Greek critic who had so carefully studied both authors states his own view in broad terms when he declares that "the power of Demosthenes took its seeds and its beginnings from Isæus." A closer examination will show that within certain limits the statement may be allowed. Attic prose expression had been continuously developed as an art; the true link between Isæus and Demosthenes is technical, depending on their continuity. Isæus had made some original contributions to the resources of the art; and Demosthenes had not failed to profit by these. The composition of Demosthenes resembles that of Isæus in blending terse and vigorous periods with passages of more lax and fluent ease, as well as in that dramatic vivacity which is given by rhetorical question and similar devices. In the versatile disposition of subject-matter, the divisions of "narrative" and "proof" being shifted and interwoven according to circumstances, Demosthenes has clearly been instructed by the example of Isæus. Still more plainly and strikingly is this so in regard to the elaboration of systematic proof; here Demosthenes invites direct and close comparison with Isæus by his method of drawing out a chain of arguments, or enforcing a proposition by strict legal argument. And, more generally, Demosthenes is the pupil of Isæus, though here the pupil became even greater than the master, in that faculty of grappling with an adversary's case point by point, in that aptitude for close and strenuous conflict which is expressed by the words *ἀγών, ἐργασίος*.<sup>1</sup> Thus far Isæus and Demosthenes are related to each other as technical proficient in a progressive art. It might be added that there was some degree of resemblance between the natures of the two men, in so far as the intellectual character of both was marked by a certain vigorous intensity of logic. But it would be as perverse to overstate the debt of Demosthenes to Isæus as it would be unjust to rest the significance of Isæus solely or chiefly on his relation to Demosthenes. As Demosthenes holds his unrivalled place in virtue of qualities which no teacher could have communicated, so, too, the writings of Isæus have the independent value of masterpieces in their own kind.

**Works.** The pseudo-Plutarch, in his life of Isæus, mentions an *Art of Rhetoric* and sixty-four speeches, of which fifty were accounted genuine. From a passage of Photius it appears that at least the fifty speeches of recognized authenticity were extant as late as 850 A.D. Only eleven, with large part of a twelfth, have come down to us; but the titles of forty-two others are known.<sup>2</sup>

The titles of the lost speeches confirm the statement of Dionysius that the speeches of Isæus were exclusively forensic; and only three titles indicate speeches made in public causes. The remainder, concerned with private causes, may be classed under six heads:—(1) *κληρικοί*—cases of claim to an inheritance; (2) *ἐπικληρικοί*—cases of claim to the hand of an heiress; (3) *διαδικασίαι*—cases of claim to property; (4) *ἀποστασίαι*—cases of claim to the ownership of a slave; (5) *ἐγγύης*—action brought against a surety whose principal had made default; (6) *ἀνταμοσία* (as = *παράγραφῃ*)—a special plea; (7) *ἔφεσις*—appeal from one jurisdiction to another.

Eleven of the twelve extant speeches belong to class (1), the *κληρικοί*, or claims to an inheritance. This was probably the branch of practice in which Isæus had done his most important and most characteristic work. And, according to the ancient custom, this class of speeches would therefore stand first in the manuscript collections of his writings. The case of Antiphon is parallel: his speeches in cases of homicide (*φονικοί*) were those on which his reputation mainly depended, and stood first in the manuscripts. Their exclusive preservation, like that of the speeches made by Isæus in will-cases, is thus primarily an accident of manuscript tradition, but partly also the result of the writer's special prestige.

**Classification.** Six of the twelve extant speeches are directly concerned with claims to an estate; five others are connected with legal proceedings arising out of such a claim. They may be classified thus (the name

<sup>1</sup> Cleon's speech in *Thuc.* iii. 37, 38, works out this image with remarkable force; within a short space we have *ἐπιείσεως ἀγώνων τοιαύτῳ ἀγώνων—ἀγωνιστής—ἀγωνί(σθαί)—ἀνταγωνί(σθαί)—ἀγωνοθετεῖν*. See *Attic Orators*, vol. i. 39; ii. 304.

<sup>2</sup> For the words of Photius (cod. 263), *τοῦτων δὲ οἱ τὸ γνήσιον μαρτυρηθέντες ἢ καταλείπονται μόνον*, might be so rendered as to imply that, besides these fifty, others also were extant. See *Att. Orat.*, ii. 311, note 2.

<sup>3</sup> The second of our speeches (the Meneclean) was discovered in the Laurentian Library in 1785, and was edited in that year by Tyrwhit. In editions previous to that date, Orat. i. is made to conclude with a few lines which really belong to the end of Orat. ii. (§ 47, *ἀλλ' ἐπειδὴ τὸ πᾶν γὰρ . . . ψηφισασθε*), and this arrangement is followed in the translation of Isæus by Sir William Jones, to whom our second oration was, of course, then (1779) unknown. In Orat. i. all that follows the words *μη τοῖσάντες* in § 22 was first published in 1815 by Mei, from a MS. in the Ambrosian Library at Milan.

given in each case being that of the person whose estate is in dispute):—

- I. *Trials of Claim to an Inheritance* (*διοδικασίαι*).
  1. Or. i., Cleonymus. Date between 360 and 353 B.C.
  2. Or. iv., Nicostratus. Date uncertain.
  3. Or. vii., Apollodoros. 353 B.C.
  4. Or. viii., Cron. 375 B.C.
  5. Or. ix., Astyphilus. 369 B.C.
  6. Or. x., Aristarchos. 377-71 B.C.
- II. *Actions for False Witness* (*δικαί ψευδομαρτυριῶν*).
  1. Or. ii., Menecles. 354 B.C.
  2. Or. iii., Pyrrhus. Date uncertain, but comparatively late.
  3. Or. vi., Philoctemon. 364-63 B.C.
- III. *Action to Compel the Discharge of a Suretyship* (*ἐγγύης δίκη*).
  - Or. v., Dicoeogenes. 300 B.C.
- IV. *Indictment of a Guardian for Maltreatment of a Ward* (*εἰσαγγελία κατώστων ὀρφανῶν*).
  - Or. xi., Hegesias. 359 B.C.
- V. *Appeal from Arbitration to a Dicastery* (*ἔφεσις*).
  - Or. xii., For Euphiletus. (Incomplete.) Date uncertain.

The speeches of Isæus supply valuable illustrations to the early history of testamentary law. They show us the faculty of adoption, char-actil, indeed, associated with the religious motive in which it acter- originated, as a mode of securing that the sacred rites of the family ities. shall continue to be discharged by one who can call himself the son of the deceased. But practically the civil aspect of adoption is, for the Athenian citizen, predominant over the religious; he adopts a son in order to bestow property on a person to whom he wishes to bequeath it. The Athenian system, as interpreted by Isæus, is thus intermediate, at least in spirit, between the purely religious stand- point of the Hindu and the maturer form which Roman testa- mentary law had reached before the time of Cicero.<sup>4</sup> As to the form of the speeches, it is remarkable for its variety. There are three which, taken together, may be considered as best representing the diversity and range of their author's power. The fifth, with its simple but lively diction, its graceful and persuasive narrative, recalls the qualities of Lysias. The eleventh, with its sustained and impetu- ous power, has no slight resemblance to the manner of Demosthenes. The eighth is, of all, the most characteristic, alike in narrative and in argument. Isæus is here seen at his best. No reader who is interested in the social life of ancient Greece need find Isæus dull. If the glimpses of Greek society which he gives us are seldom so gay and picturesque as those which enliven the pages of Lysias, they are certainly not less suggestive. Here, where the innermost rela- tions and central interests of the family are in question, we touch the springs of social life; we are not merely presented with scenic details of dress and furniture, but are enabled in no small degree to conceive the feelings of the actors.

The best manuscript of Isæus is in the British Museum,—Crippsianus A Manu- scripta. (=Burneianus 95), which contains also Antiphon, Andocides, Lycargus, and Dinarchus. The next best is Bekker's Laurentianus B (Florence), of the 15th century. Besides these, we find Marcianus L (Venice), sœc. 14, Vratkislavensis Z. sœc. 14, and two very inferior MSS., Ambrosianus A. 89, P (which he dis- missed after Or. i.), and Ambrosianus D. 42, Q (which contains only Or. i. B.). Schœmann, in his edition of 1831, generally followed Bekker's text; he had no fresh apparatus beyond a collation of a Paris MS. R in part of Or. i.; but he had sifted the Aldine more carefully. Baiter and Sauppe (1856) had a new collation of A, and also used a collation of Burneianus 95, M, given by Dobson in vol. iv. of his edition (1828). C. Scheibe (Teubner, 1860) made it his especial aim to complete the work of his predecessors by restoring the correct Attic forms of words; thus (e.g.) *ἡ κτίσις ἡγρία* for *ἐνγρία*, *δέδμεν* for *δέδιμεν*, and the like,—following the consent of the MSS., however, in such forms as the accusative of proper names in *-ῃ* rather than *-ῆ*, or (*εἶ*) the future *φανήσονται* rather than *φανόμεθα*, &c., and on such doubtful points as *φράγεται* instead of *φράττει*, or *Ἐλγυθίος* instead of *Ἐλκλυθίος*.

*Recent Editions*.—In *Oratores Attici*, by I. Bekker, 1823-8; G. E. Dobson, 1828; J. G. Baier and Hermann Sauppe, 1856. Separately, by G. F. Schœmann, with commentary, 1831. In Teubner series, by C. Scheibe, 1860. English translation by Sir William Jones, 1779. (R. C. J.)

**ISAAH.** I. Isaiah is the name of the greatest, and both in life and in death the most influential of the Old Testament prophets. We do not forget Jeremiah, but Jeremiah's literary and religious influence is secondary compared with that of Isaiah. Unfortunately we are reduced to inference and conjecture with regard both to his life and to the extent of his literary activity. In the heading (i. 1) of what we may call the occasional prophecies of Isaiah (i.e., those which were called forth by passing events), the author is called "the son of Amoz," and Rabbinical legend identifies this Amoz with a brother of Amaliah, king of Judah; but this is evidently based on a mere etymo- logical fancy. We know from his works that (unlike Jeremiah) he was married (viii. 3), and that he had at least two sons, whose names he regarded as, together with his own, symbolic by Divine appointment of certain decis- ive events or religious truths—Isaiah (Yesh'a-yâhû), meaning

<sup>4</sup> Cf. Maine's *Ancient Law*, ch. vi.; and the *Tagore Law Lectures* (1870), by Eertert Cwells, lect. ix., "On the Rite of Adoption," pp. 566-7.



"Salvation—Jehovah"; Shear-Yāshūb, "a remnant shall return"; and Maher-shalal-hash-baz, "swift (swiftly cometh) spoil, speedy (speedily cometh) prey" (vii. 3, viii. 3, 4, 18). He lived at Jerusalem in the "middle" or "lower city" (2 Kings xx. 4), exercised at one time great influence at court (chap. xxxvii.), and could venture to address a king unbidden (vii. 4), and utter the most unpleasant truths, unassailed, in the plainest fashion. Presumably therefore his social rank was far above that of Amos and Micah; certainly the high degree of rhetorical skill displayed in his discourses implies a long course of literary discipline, not improbably in the school of some older prophet (Amos vii. 14 suggests that "schools" or companies "of the prophets" existed in the southern kingdom). We know but little of Isaiah's predecessors and models in the prophetic art (it were fanaticism to exclude the element of human preparation); but certainly even the acknowledged prophecies of Isaiah (and much more the disputed ones) could no more have come into existence suddenly and without warning than the masterpieces of our own Shakespeare. In *The Prophecies of Isaiah* by the Rev. T. K. Cheyne, vol. ii. p. 218, a list has been given of the points of contact both in phraseology and in ideas between Isaiah and the prophets nearly contemporary with him; Isaiah cannot be studied by himself—he gives much to his successors, but he takes something from his less gifted colleagues.

The same heading already referred to gives us our only traditional information as to the period during which Isaiah prophesied; it refers to Uzziah, Jotham, Ahaz, and Hezekiah as the contemporary kings. It is, however, to say the least, doubtful whether any of the extant prophecies are as early as the reign of Uzziah. Exegesis, the only safe basis of criticism for the prophetic literature, is unfavourable to the view that even chap. i. belongs to the reign of this king, and we must therefore regard it as most probable that the heading in i. 1 is (like those of the Psalms) the work of one or more of the Sopherim (or scribes and editors of Scripture) during the Babylonian exile, apparently the same writer (or company of writers) who prefixed the headings of Hosea and Micah, and perhaps of some of the other books.

In fact, the view of Hengstenberg that the prophecies of Isaiah are arranged chronologically, though not without justification, fails to satisfy the requirements of historical interpretation. Let us put it aside and briefly sketch the progress of Isaiah's prophesying on the basis of philological exegesis, and a comparison of the sound results of the study of the inscriptions. Chap. vi., which describes a vision of Isaiah "in the death-year of King Uzziah," may possibly have arisen out of notes put down in the reign of Jotham; but for several reasons it is not an acceptable view that, in its present form, this striking chapter is earlier than the reign of Ahaz. It seems, in short, to have originally formed the preface to the small group of prophecies which now follows it, viz., vii. 1-ix. 7. The portions which may presumably represent discourses of Jotham's reign are chap. ii. and chap. ix. 8-x. 4—stern denunciations which remind us somewhat of Amos. But the allusions in the greater part of chaps. ii.-v. correspond to no period so closely as the reign of Ahaz, and the same remark applies still more self-evidently to vii. 1-ix. 7. Chap. xvii. 1-11 ought undoubtedly to be read in immediate connexion with chap. vii.; it evidently presupposes the alliance of Syria and northern Israel, whose destruction it predicts, though opening a door of hope for a remnant of Israel. The fatal siege of Samaria seems to have given occasion to chap. xxviii.; but the following prophecies (chaps. xxix.-xxxii.) synchronize rather with the reign of Sargon than with that of Shalmaneser. Sargon is one

of those kings whose influence upon the fortunes of the chosen people was the strongest, however little we might suspect this from the Old Testament records. The truth is that Sargon as well as Sennacherib invaded Judah; the date of the invasion of the former appears to be 711. Judah had, in fact, joined that unfortunate coalition, another member of which was the Philistian town Ashdod. The record of the vengeance taken upon Ashdod is preserved in the narrative in chap. xx.; to that upon Judah no distinct reference is made in Isaiah, but no less than five prophecies, or groups of prophecies, are for the first time fully explained when referred to this king's invasion of Palestine (xiv. 29-32, xxix.-xxxii., x. 5-xi. 16, xxii., and probably i.). Sargon was a successful warrior; and his subjugation of Babylonia, revealed to us by the cuneiform monuments, throws a flood of light upon the obscure but striking little prophecy in xxi. 1-10, so often referred, but referred wrongly, to the Babylonian exile. It has always been a difficulty hitherto to understand the depression with which Isaiah announces his tidings (see xxi. 3). But we can now easily realize the apprehensions of a member of one of the smaller states when their chief bulwark against Assyria had fallen. Merodach-baladan, as we know from xxxix. 1 (2 Kings xx. 12), had shortly before opened negotiations with Hezekiah. Isaiah had been opposed to a Babylonian alliance, and recognized the divine necessity of the tyrant city's fall, but he felt a human sympathy for the smaller states of whose ruin this was but the prelude. This view of the origin of xxi. 1-10 had already suggested itself to the late Mr George Smith (*Transactions of Soc. of Biblical Archaeology*, ii. 329), but was first raised to the rank of a philological certainty by Professor Kleinert in an important paper in the *Theologische Studien und Kritiken* for 1877 (pp. 174-79). The oracle on the fall of Babylon was soon followed by prophetic warnings to the other neighbouring states, Philistia, Egypt, and Ethiopia, and probably Moab and Arabia, though it is a growing opinion, for which strong philological reasons may be advanced, that the epilogue in xvi. 13, 14 was attached by Isaiah to an oracle in archaic style by another prophet (Isaiah's hand can, however, be traced in xvi. 4b, 5). In fact, no progress can be expected in the accurate study of the prophets until the editorial activity both of the great prophets themselves and of their more reflective and studious successors is fully recognized.

Thus we have already met with two great political events (the Syro-Israelitish invasion under Ahaz, and the first Assyrian invasion under Sargon) which called forth the wonderful spiritual and oratorical faculties of our prophet, and quickened that mysterious power of insight into the future which cannot reasonably be denied (to say the least) to simpler ages and races (see Tholuck, *Die Propheten und ihre Weissagungen*, Gotha, 1861). A third still more remarkable invasion remains—that of Sennacherib, to which four of the extant prophecies must undoubtedly be referred, viz., chap. xviii., chap. xvii. 12-14, chap. xxxiii., and chap. xxxvii. 22-35 (or at any rate as far as ver. 32). The last of these is specially interesting, as it has evidently not been so elaborately worked up as the rest of Isaiah's prophecies, and seems to correspond more nearly to a spoken discourse. Its incisiveness is exactly what we should expect from the stirring circumstances under which it purports to have been delivered.

A special reference seems needed at this point to one of the two oracles on Egypt which, in the light of Oriental discovery, seems to be rightly ascribed to the period of Sargon—chap. xix. The comparative feebleness of the style warrants a hesitating conjecture that, though the basis of the prophecy is Isaianic (the points of contact with the prophet's acknowledged works are opposed to any

other view of its origin), yet in its present form it has undergone the manipulation of a disciple of the prophet. (Isaiah's disciples are indeed expressly referred to by the prophet himself as the guardians of one important prophecy (viii. 16); and, granting an editorial activity, it is the most conservative and current view open to us to suppose that the disciples of the prophet were also his first editors. Every one is familiar with the idea of the editorial process through which the historical books of the Old Testament have passed; it would be culpable indolence to neglect the phenomena which record the similar process through which the other books, especially the prophetic, have passed. It should be added, however, that the Isaianic origin of the epilogue in xix. 18-24 (the point of commencement of the epilogue is given differently by some) has been frequently called in question. The chief stumbling-blocks are the precise, circumstantial details of the prophecy, which are thought to be not in the manner of Isaiah. In particular the reference to the "city of destruction," *'ir ha-héres* (v. l., "city of the sun," *'ir ha-khères*), has awakened suspicion. Accepting (which it is not necessary to do) the various reading, it would be plausible to regard ver. 18 as a fictitious prophecy in the interests of Onias, the founder of the rival Egyptian temple to Jehovah at Leontopolis (in the nome of Heliopolis), Josephus, *Antiq.*, xii. 9, 7.

II. We are now brought face to face with the question whether the whole of the book which now bears the name of Isaiah was really written by that prophet. The question relates to xiii. 2-xiv. 23, xxiv.-xxvii., xxxiv., xxxv., and xl.-lxvi. (xxi. 1-10 must henceforth be excluded, on objective, historical grounds, from the list of doubtful prophecies). It is not necessary here to enter into the history of the controversy (the father of which may be said to be the subtle-minded Aben Ezra). Nor will it be necessary to spend much time on the well-worn but inconclusive arguments of the older critics. The existence of a tradition in the last three centuries before Christ as to the authorship of any book is (to those acquainted with the habits of thought of that age) of but little critical moment;—the Sopherim or students of Scripture in those times were simply anxious for the authority of the Scriptures, not for the ascertainment of their precise historical origin. It was of the utmost importance to declare that (especially) Isaiah xl.-lxvi. was a prophetic work of the highest order; this was reason sufficient (the Sopherim may have had other reasons, such as phraseological affinities in xl.-lxvi., but this was sufficient) for ascribing them to the royal prophet Isaiah. When the view had once obtained currency, it would naturally become a tradition. The question of the Isaianic or non-Isaianic origin of the disputed prophecies (especially xl.-lxvi.) must be decided on grounds of exegesis alone. There are indications among critics, bred in very different schools, of a growing perception of this truth. We therefore simply chronicle the fact that the older critics appeal to Ezra i. 2 (interpreted by Josephus, *Antiq.*, xi. 1, 1-2), to the Septuagint version of the book (produced between 260 and 130 B.C.), in which the disputed prophecies are already found, and to the Greek translation of the Wisdom of Jesus, the son of Sirach, which distinctly refers to Isaiah as the comforter of those that mourned in Zion (Ecclus. xlvi. 24, 25). It will be remembered that our prophet himself flourished in the 8th century B.C., and that the Babylonian captivity intervened.

The fault of the combatants (for there has been far too much animosity on both sides) in the controversy as to the origin of what we may call, for brevity's sake, II. Isaiah (including all the disputed prophecies) has been that each party has only seen "one side of the shield." It will be admitted by philological students that the exegetical data supplied by (at any rate) Isa. xl.-lxvi. are conflicting, and

therefore susceptible of no simple solution. (In other words, Isa. xl.-lxvi. cannot have been written as it stands either by Isaiah or by a prophet at the close of the exile.) This remark applies, it is true, chiefly to the portion which begins at lii. 13. The earlier part of Isa. xl.-lxvi. admits of a perfectly consistent interpretation from first to last. There is nothing in it to indicate that the author's standing-point is earlier than the Babylonian captivity. His object is to warn, stimulate, and console the captive Jews, some full believers, some semi-believers, some unbelievers or idolaters. At lii. 13 new phenomena begin to show themselves, indicative, not indeed of a changed standing-point, but at least of another date and pen. No doubt an author may change his style, writing in a different mood; we must at all events suppose that the author (whoever he may have been) was in a different tone of mind when he wrote so "hardly, obscurely, and awkwardly" (Delitzsch) as in lii. 13-liii. [Ewald is bolder. He traces this passage to an anonymous prophet of the reign of Manasseh, to whom are also due xl. 1, 2 (?) and lvi. 9-lvii. 11; and it must be owned that the style of the latter is equally harsh with that of lii. 13, &c.]

III. But let us devote a somewhat closer attention to the easier and more intelligible portion of the last twenty-seven chapters. It will amply remunerate us; for there is no more striking specimen of prophetic rhetoric in the Old Testament. More particularly, it will be well to study continuously chaps. xl.-xlviii., which evidently form a section by themselves, introductory to that which begins at chap. xlix. They have one leading idea—the great crisis impending over Babylon and Israel. Babylon and her gods must fall, that Israel may rise again with the glorious function of giving a religion to the world. The development of this idea is full of contrasts and surprises: the vanity of the idol-gods and the omnipotence of Israel's helper, the sinfulness and infirmity of Israel and her high spiritual destiny, and the selection (so offensive to patriotic Jews, xlv. 9, 10) of the heathen Cyrus as the instrument of Jehovah's purposes, as in fact His Messiah or Anointed One (xlv. 1), are brought successively before us. [The prophet, however, does now and then speak as if Jehovah Himself would interpose to help His people, see xlii. 13, &c.] Hence the semi-dramatic character of the style. Already in the opening passage mysterious voices are heard crying, "Comfort ye, comfort ye my people"; the plural indicates that there were other prophets among the exiles besides the author of Isa. xl.-xlviii. Then the Jews and the Asiatic nations in general are introduced trembling at the imminent downfall of the Babylonian empire. The former are reasoned with and exhorted to believe; the latter are contemptuously silenced by an exhibition of the futility of their religion. Then another mysterious form appears on the scene, bearing the honourable title of "Servant of Jehovah." Who this personage may be is much disputed, and naturally enough; for while, according to xliii. 1, he may "in some sense be called" Israel, it is clear from xliii. 8 that in another sense he is perfectly distinct from Israel. This is a paradox to which this, the first book as it may be called of the Prophecy of Israel's Restoration, does not supply the key. All that we learn from this portion is that Jehovah has removed the two chief obstacles to Israel's accomplishment of its destiny, the one by a free pardon, the other by raising up Cyrus as the instrument of the national regeneration.

The section which begins at chap. xlix. is written (at first, at any rate) in the same delightfully flowing style as its predecessor. We are still among the exiles at the close of the captivity. But the new book has one peculiarity, viz., that Babylon and Cyrus are not mentioned in it at



all. [True, there was not so much said about Babylon as we should have expected even in the first book; and the paucity of references to the local characteristics of Babylonia is one of the negative arguments urged in favour of the Isaianic origin of the prophecy.] Israel himself, with all his inconsistent qualities, becomes the absorbing subject of the prophet's meditations. The section opens with a soliloquy of the "Servant of Jehovah," in which the same paradox meets our view which we discovered in the earlier books; the "Servant of Jehovah" is addressed as Israel, and yet is shortly afterwards distinguished from that people. The immediate prospects of Israel seem now to be overlaid; but the prophet "bates not heart nor hope." He comforts Zion with the thought of the unchanging love of God: "Can a woman forget her sucking child," &c. (xlix. 1, comp. li. 12, 13). Then his tone rises, Jerusalem can and must be redeemed; he even seems to see the great divine act in process of accomplishment. Is it possible, one cannot help asking, that the abrupt description of the strange fortunes of the "Servant"—by this time entirely personalized—was written to follow chap. lii. 1-12?

The whole difficulty arises from the prevalent assumption that chaps. xl.-lxvi. form a whole in itself. Natural as the feeling against disintegration may be, the difficulties in the way of admitting the unity of chaps. xl.-lxvi. are insurmountable. Even if, by a bold assumption, we grant the unity of authorship, it is plain upon the face of it that the chapters in question cannot have been composed at the same time or under the same circumstances; literary and artistic unity is wholly wanting. But once admit (as it is only reasonable to do) the extension of Jewish editorial activity to the prophetic books, and all becomes clear. Just as the historic records were filled out and adapted to the religious wants of later ages, so too were the prophetic. Orthodoxy loses nothing by the admission; for why should not the same Spirit of wisdom which, as the church believes, inspired the prophets, have vouchsafed all needful gifts to the "sons of the prophets"—the prophetically-minded Sopherim? Even the lowest degree of inspiration, as Rudolf Stier remarks, is one of faith's mysteries. But we are not now concerned with orthodoxy, but only with the religious records of the Israelites. The record before us gives no information as to its origin. It is without a heading, and by its abrupt transitions, and honestly preserved variations of style, invites us to such a theory as we are now indicating.

There are portions of Isa. xl.-lxvi. of Palestinian origin, and some of them composed previously, others subsequently, to the exile. These are partly imbedded in, partly appended to, a work written at the close of the exile by a true though literary prophet, well acquainted with the more archaic and less purely literary prophet Isaiah, but not without numerous peculiarities of his own. These insertions and appendices are seven in number. The first (a) is lii. 13-liii., which, as Ewald (who pointed the way which later critics have to follow) rightly felt, proceeds from a time of persecution. It should be taken in connexion with (b) lvi. 9-lvii., which is in the same harsh but strong style, and has a large number of distinct historical data. "The strikingly Palestinian character of the scenery in lvi. 5, 6, the presumed reference to persecution in lvii. 1, and the correspondence of the sins imputed to the people with pre-exile circumstances," seem to favour a reference to the persecution of Manasseh. (See Ewald, Bleek, and even Luzzatto, who ascribes all the rest of the book to Isaiah.) It must be admitted that a religious persecution set on foot by Manasseh is not directly affirmed in the Old Testament; but it is a legitimate inference from a combination of passages, and it were hypercriticism to doubt it. Next comes (c) a short prophecy complete in itself (lvi. 1-8), directed against the Jewish pride of race. The circumstances presupposed are manifestly neither those of the age of Isaiah nor yet those of the latter part of the exile:—(1) the temple is in existence, ver. 5; (2) a special duty is inculcated (Isa. xl. and the following chapters are entirely taken up with infusing a new spirit into the Jews; the correction of details is left to the future); and (3) this duty is one which was specially enforced in the age of Jeremiah (xvii. 19-27) and in that of Nehemiah (Neh. xiii. 15-22). If we further consider the apprehensions of exclusion from religious

privileges expressed by the eunuchs, we can hardly doubt that the period of Nehemiah (when proselytes began to gather to Jerusalem) is that to which this prophecy belongs—a period specially characterized by legal rigour (see Neh. xiii.). Another isolated prophecy (d) is chap. lviii. Its practical, hortatory tone reminds us of lvi. 1-8, and the stress laid upon fasting—the true fasting of the heart—points equally to the post-exile period. See Zech. vii. 5 (comp. viii. 19); Joel ii. 12, 13. (It is here assumed that the book of Joel is a work of the Persian period. Nothing but the habit of looking at each book of Scripture separately, instead of in connexion with those of similar style and contents, hinders this theory from attaining a more general prevalence.) Whether this prophecy comes from the same author, or simply from the same school, as lvi. 1-8, it is neither possible nor of any importance to determine. From the same school, too, if not from the same author, must have proceeded (e) chap. lix. It has no distinct connexion with chap. lviii., but the tone is similar. The first part of the chapter presents affinities with the book of Proverbs (a favourite subject of study during or after the exile, when, as it would seem, the introductory chapters, with their glowing portraiture of life in a metropolis, were prebent). (f) The prophecy in chap. lxiii. 1-6 is one of the most obscure in the prophetic literature. It would indeed not be hopeless to assign a probable date, but this would depend upon a consideration of other prophecies (notably Joel and Malachi), for which we have not space here. Suffice it to point out the eschatological apocalyptic tone which prevails in it. How unlike it is to the homed rhetoric of him whom we are accustomed to call the Second Isaiah: "It is certainly a strange phenomenon, this reference to a great battlefield in Edom, when the grand object of II. Isaiah is to help the Jews to realize their coming deliverance from Babylon. It creates a serious difficulty for those who maintain that II. Isaiah was written at one time and under one set of impressions. The complications of the problems of Biblical criticism are only beginning to be adequately realized" (*The Prophecies of Isaiah*, ii. 99). At present lxiii. 1-6 is an isolated passage, but it has affinities with lix. 15b-20, and with chap. xxxiv., and it is probable that chaps. xxxiv., lix., and lxiii. 1-6 were occasioned by the same contemporary circumstances. The gorgeousness of the theophany reminds us of Ezekiel and of the Apocalypse.

With regard to the rest of chaps. xl.-lxvi., one general remark seems necessary. It is only the inveterate habit of reading lxiii. 7-lxvi. as a work relating to the close of the exile that prevents us from seeing how inconsistent its tone and details are with this presupposition. Looking at it with eyes that strive to be impartial, we cannot resist the impression that it has not only come down from the restoration period, but that it was written at different parts of that period. Let us pursue the examination of the sections separately.

(g) Chaps. lxiii. 7-lxiv. This consists of "thanksgiving, penitence, and supplication in the name of the pious portion of the Jewish nation." The tone is exactly that of the Lamentations; the desolation of the temple and of the Jewish cities (lxiii. 18, lxiv. 10, 11) is described with all the emotion of an eye-witness. The style of the section is unusually abrupt.

(h) Chap. lxv. The subject-matter is "alternate threatening and promise. Most commentators regard this chapter as the answer of Jehovah to the [prayer of the] church [in chaps. lxiii., lxiv.]." But there are grave objections to this view. "The divine speaker makes not even a distant allusion to the difficulty stated in the foregoing prayer." Observe, too, that in chap. lxv. the church speaks as representing the nation, whereas in chap. lxv. the national union is described as broken by open idolatry. The sins referred to in vers. 3-5 and 11 are at least in part characteristic of Canaan rather than Babylonia; and so also is the reference to the vintage in ver. 8. On the other hand, there are passages in vers. 11-25 which have been thought to point to the period of the exile, —e.g., "that forget my holy mountain" (ver. 11), and the entire description of the new Jerusalem. We admit that one of the exiles might have written such passages, but it is more probable that they were written by one of the returned Jews. The actual condition of the new Judaean state was very far from corresponding to the glorious predictions of chap. lx. What more natural than that prophetic voices should have continued to point to the future for the fulfilment of those predictions? [Hence we can account for the parallel between lxvi. 12 and lx. 4. Note in passing that the figure in lx. 16 has received a different application in lxvi. 11: the writer of chap. lxvi. is familiar with the works of his predecessors, and uses them with freedom.] As to the phrase "that forget my holy mountain," a similar one occurs in ver. 5 of Ps. cxxxvii., which is gene-

<sup>1</sup> See *The Prophecies of Isaiah* (1880-81), vol. ii. The view maintained is that the idolatrous practices referred to, so far as they are distinctively Palestinian, were renewed by some of the Jews on their return to Palestine. We are apt to forget the local character of ancient cults, also the mixed motives of men. The Jews who returned, and still more the succeeding generations, cannot have been uniformly as pious and believing as Ezra.

rally admitted to belong to the restoration period. A phraseological argument for a post-exilic date may at any rate be deduced from the words "the God of Amen" (lxv. 16), which point to an age in which liturgical forms containing the word Amen were abundant.

(i) Chap. lxvi. This chapter has peculiar difficulties, and we must take it in two parts, vers. 1-4 (or 1-5) and 5-24 (or 6-24). (1) Verses 1-4 are highly perplexing. Everywhere else in II. Isaiah the existence of a temple is assumed to be a necessity for the highest religious life (see xliv. 28, lvi. 7, lx. 7, lxvi. 20, 21). In these four verses alone the prophet appears to assume a position of hostility both to it and to the sacrificial system. The temple appears to be unbuilt, and the writer to be opposed on principle to its re-erection. It is not at all impossible that a religious Jew should have taken up this position. In the central portion of the book of Ezech the second temple is boldly denounced, and the offerings of those who worshipped in it are called "unclean," on the ground that the rebuilding ought to have been postponed till the kingdom of Israel had been set up in the ends of the earth (lxxxix. 73, xc. 13). If, therefore, we follow appearances, we are bound to regard vers. 1-4 as a separate fragment, interpolated by the latest editor. The fatal objection to such an hypothesis comes from ver. 5, which unites two phrases peculiar—the one to the section vers. 1-4, the other to the section vers. 6-24. It is evidently a designed link between the two parts of the prophecy in chap. lxvi., and as evidently is not the work of a mere manipulating scribe, but of the author. We must therefore interpret vers. 1-4 on the analogy of the famous passage Jer. vii. 22, which seems to discountenance sacrifices altogether, but in reality only condemns them when gone through as mere forms (see Jer. xxxiii. 18). (2) Verses 5-24 consist, like chap. lxv., of alternate threatening and promise. The threatening is mainly addressed to the hostile Gentiles, but partly also to the idolatrous Jews; and the idolatrous practices denounced (ver. 17) are the same as those in lxv. 4, 5 (initiation into heathen mysteries and eating "unclean" food). The temple has been rebuilt, and the sacrificial system in some form has been restored,—such at least appears the most natural interpretation of the allusions in vers. 6, 20, 21.

On the whole, we seem to be led to the following conclusions with regard to (g), (h), and (i):—first, that the passage lxvii. 7-lxviii. is entirely distinct from the prophecies in the midst of which it occurs, and that it was probably written early in the exile by one of the Jews left behind in Palestine; and, secondly, that the whole of chaps. lxv. and lxvi. proceed from one author, though they were certainly not written continuously. A comparison of ver. 6 with Joel iii. 12-16, and also of the contexts of both passages, suggests that chap. lxvi. (and consequently lxv.) was written by a contemporary of Joel (i.e., well on in the Persian period).

As the result of our digression, we are enabled to do better justice to what may be called the second book of the prophecy of Israel's restoration. Chap. lii. 13-liiii. is based upon an early work, descriptive, however, as it would seem, not of the martyrdom of an Isaiah or a Jeremiah, but, even in its original form, of an ideal (or, as orthodoxy holds, ideal and historical) personage, the first sketch as it were (Job, in the poem which bears his name, is another) of the Servant of Jehovah. But it is proper to speak here with great hesitation. No analysis can be skilful enough to bring out a description of a mere martyr; it is simply on linguistic grounds that we assume the existence of this remarkable section in some form or other, but a form not very unlike the present, at a date previous to that of the other portraits of the "Servant." By omitting it, however, we obtain a much improved connexion; chap. liv. forms the finest of all possible sequels to lii. 9-12. The transition to the next chapter is, it must be confessed, a little abrupt, and indeed the remainder of the book has the appearance of not having been completely worked up; it was the more natural, therefore, for the Sopherim to insert or append to it prophecies mostly of later origin. But no one can fail to observe how greatly chap. lx. gains by being read in connexion with lv. 12, and especially with liv. 1, &c.

In chap. lxi. the "Servant of Jehovah" appears for the last time (if it be not rather the prophet who is the speaker); and chap. lxii. closes the second book of the prophecy of restoration with the welcome summons to depart from Babylon.

IV. We have said nothing hitherto, except by way of allusion, of the disputed prophecies scattered up and down the first thirty-nine chapters of the book of Isaiah. It is indeed not absolutely necessary to devote a special survey to them here; the data which they furnish are found (with important additions) in the second part of the book. There is only one of these prophecies (putting aside xxi. 1-10) which may, with any real plausibility, be referred on exegetical grounds to the age of Isaiah, and that is chaps. xxiv.-xxvii. The apparent grounds are (1) that according to xxv. 6 the author dwells on Mount Zion; (2) that Moab is referred to as an enemy (xxv. 10); and (3) that,

at the close of the prophecy, Assyria and Egypt are mentioned as the principal foes of Israel (xxvii. 12, 13). But the explanation was long ago seen by Ewald, viz., that the author, being less richly endowed with the prophetic spirit, has interwoven precious fragments of old prophecies. The tone and spirit of the prophecy as a whole point to the same late apocalyptic period to which chap. xxxiv. and the book of Joel in a faint degree, and much more strikingly the last chapter (at any rate) of the book of Zechariah, may unhesitatingly be referred.

A word or two may perhaps be expected on Isa. xiii., xiv., and xxxiv., xxxv. (a suggestion has already been offered with regard to the latter prophecy). These two oracles agree in the elaborateness of their description of the fearful fate of the enemies of Jehovah (Babylon and Edom are merely representatives of a class), and also in their view of the deliverance and restoration of Israel as an epoch for the whole human race. There is also an unrelieved sternness, which pains us by its contrast with Isa. xl.-lxvi. (except passages of this portion which are probably not homogeneous with the bulk of the prophecy). They have also close affinities with Jer. l., li., a prophecy (as Budde has proved on philological grounds) of post-exile origin, but are apparently earlier than that longest and least striking of all the prophecies.

The literary characteristics of the acknowledged prophecies of Isaiah have been thus summed up by Ewald:—

"The thing of chief importance is, that we are wholly unable to name a special peculiarity and favourite manner of style in the case of Isaiah. He is not the specially lyric, or the specially elegiac, or the specially rhetorical and monitory prophet, as, e.g., Joel, Hosea, Micah, in whose writings a special manner is predominant; but every kind of style and every variation of exposition is at his command to meet the requirements of his subject; and this it is which in respect of style constitutes his greatness, as well as generally one of his most prominent excellences. His fundamental peculiarity is only the exalted majestic repose of style, proceeding from the full and sure command of his subject. This repose by no means requires that the language should never be more violently agitated, and not blaze up where the subject demands it; but even the most extreme agitation is bridled by this repose in the background, and does not pass beyond its proper limits, and soon returns with higher self-mastery to its regular flow, not again to leave it, ii. 9-iii. 1, xxviii. 11-23, xxx. 9-14."—*The Prophets*, Eng. transl., ii. 10, 11.

This representation has sometimes been misused in the interests of a party to show that Isaiah's versatility was absolutely unlimited, and that no conceivable prophecy, in which affinities with Isaiah can be traced, may not have proceeded from his pen. But Isaiah, though more versatile than his predecessors (*sovra gli altri come aquila vola*), was not unmindful of that "limitation" which, Goethe assures us, is the first sign of mastership. He was not a Proteus, and the characteristics mentioned above by Ewald cannot be transferred without large modifications to the prophecy of Israel's restoration.

We sink to a lower level when we pass to the disputed prophecies interspersed in chaps. i.-xxxix., which cannot lay claim to a high perfection of style, with, however, one exception, and that such a striking one that it is difficult to believe that the passage always occupied its present position. The ode on the fall of the king of Babylon in chap. xiv. 4-21 is as brilliant with the glow of lyric enthusiasm as the stern prophecy which precedes it is, from the same point of view, deficient; it is too faint a eulogy which Ewald gives to it in the words, "a poetical and highly finished lyric." It is in fact worthy to be put by the side of the finest passages of chaps. xl.-lxvi.,—of those passages which irresistibly rise in the memory when we think of "Isaiah."—But what shall we say—what language is adequate to the divine beauty of such passages as Handel linked to music almost as divine: "Comfort ye, comfort ye my people, saith your God"; "He shall feed His flock like a shepherd"; "He was oppressed, and He



was afflicted, yet He opened not His mouth"? Silver tones of which the ear is never weary; honied rhetoric, which thrills, like a subtle odour, even those who have lost the key to its meaning. It should be remembered, however, that these delightful passages are mostly confined to that part of chaps. xl.-xlv. which has, on the whole, a literary and æsthetic unity. Among the passages which we have indicated as of doubtful age and origin there are but two which are generally remembered. One of these has apparently been adopted and restricted by the great prophet of chap. xl.-xlviii., and is therefore not absolutely an exception. The other has commended itself not so much to the affections as to the imagination of later readers (we refer to the wonderfully picturesque vision in lxiii. 1-6).

V. From a religious point of view there is a wide difference, not only between the acknowledged and (taking them altogether) the disputed prophecies of the book of Isaiah, but also between those of the latter which occur in chaps. i.-xxxix., on the one hand, and the greater and more striking part of chaps. xl.-lxvi., on the other. We may say, upon the whole, with Dr Duhm, that Isaiah represents a synthesis of Amos and Hosea, though not without important additions of his own. Isaiah's "place in the affections of all succeeding generations is due to the fact that he was, perhaps, the first to preach in distinct terms the doctrines of a personal Messiah and of the spiritual brotherhood of all nations. He foresaw that, in the awful 'day of Jehovah' which former prophets had announced, few even of the chosen people should pass the ordeal, and so deep was his conviction of this that he expressed it in the name of one of his sons, Shear Yashub, 'a remnant shall return.' But he was too 'bold,' as St Paul says, to terminate his speculations at so early a point. By combining the doctrine of the few that should be saved with that of the necessary triumph of Jehovah's kingdom, he was prepared to receive a new and grand revelation. He saw in prophetic vision an exalted personage ascending the throne of David, who should attract the whole world into voluntary submission to his rule. . . . And thus to the twofold elementary doctrine of the sole divinity of Jehovah and the awful strictness of the impending judgment a fellow-truth was added, viz., that of the personal Messiah, which developed finally into the crowning doctrine of the spiritual equality of all nations" (Cheyne, *The Book of Isaiah Chronologically Arranged*, Introduction, p. xi).

This very conception, which is, as it were, the blossom of the revelations of the acknowledged portions of Isaiah, is conspicuously wanting in the disputed prophecies; or rather, this particular form of the conception has disappeared. Not the ideal king of Israel, but a figure variously described, and susceptible (as experience proves) of different explanations, is the centre of the longest and grandest of this cognate group. Who is the "Servant of Jehovah"? Certainly not, in the proper sense of the word, the Messiah; certainly not, in all the extant descriptions, an individual. Both these explanations must from the very first be excluded as absolutely opposed to a philological exegesis. The following are, in brief, the leading opinions which have been held:—(1) Hitzig's, that the Jewish people in exile is referred to, as distinguished from the heathen; (2) that of Paulus and Maurer, that the Servant is the pious portion of the people; (3) that of Gesenius, that the prophetic order is intended; (4) that of Hofmann, combining (2) and (3), that it means Israel, the prophetic people, suffering on behalf of the heathen world; (4) that of Oehler and Delitzsch, that "the conception of the Servant of Jehovah is, as it were, a pyramid, of which the base is the people of Israel as a whole. the central part Israel 'according to the

Spirit,' and the summit the person of the mediator of salvation who arises out of Israel." [Delitzsch, however, who now traces this historical person, the Christ of the gospels, in the strongly individualizing portrait in chap. liii., formerly considered the subject of that chapter to be the spiritual Israel; see his article in *Zeitschrift für lutherische Theologie*, 1850, pp. 29-42.] This last theory has been advocated on partly new grounds by the writer of this article in his work called *The Prophecies of Isaiah*, ii. 194-200, where it is further admitted that though the Servant of Jehovah, even in the most individualizing passages, is not properly speaking the Messiah, yet there are features in the description borrowed from the earlier portraits of the Messianic king, features which, regarded strictly, may be inconsistent, but which serve to keep up the historical continuity of the announcement of salvation. "It was natural and necessary that the die from which the coins with a royal stamp had proceeded should be broken, the royalistic form of the Messianic conception having become antiquated with the hopeless downfall of the kingdom of Judah; but equally so that fragments of the die should be gathered up and fused with other elements into a new whole."

Among the other characteristic religious peculiarities of the disputed as opposed to the acknowledged prophecies are—(1) the emphasis laid on the uniqueness, eternity, creatorship, and predictive power of Jehovah (xl. 18, 25, xli. 4, xlv. 6, xlviii. 12, xlv. 5, 6, 18, 22, xlv. 9, xlii. 5, xlv. 18, xli. 26, lxiii. 9, xlv. 7, xlv. 21, xlviii. 14); (2) the ironical descriptions of idolatry (Isaiah in the acknowledged prophecies only refers incidentally to idolatry), xl. 19, 20, xli. 7, xlv. 9-17, xlv. 6; (3) the personality of the Spirit of Jehovah (mentioned no less than seven times, see especially xl. 3, xlviii. 16, lxiii. 10, 14); (4) the influence of the angelic powers (xxiv. 21); (5) the resurrection of the body (xxvi. 19); (6) the everlasting punishment of the wicked (lxvi. 24); (6) vicarious atonement (chap. liii.).

It is unnecessary to do more than chronicle the singular attempts of the Jewish scholar, Dr Kohut, in the *Z. D. M. G.* for 1876 to prove a Zoroastrian influence on chaps. xl.-lxvi. Were this proved, of course the date of these chapters would be determined. But the baselessness of this hypothesis has been shown by M. de Harlez in the *Revue des questions historiques*, and by Dr Matthes in the *Theologisch Tijdschrift*.

There is, however, an equally striking difference among the disputed prophecies themselves, and one of no small moment as a subsidiary indication of their origin. We have already spoken of the difference of tone between parts of the latter half of the book; and, when we compare the disputed prophecies of the former half with the Prophecy of Israel's Restoration, how inferior (with all reverence be it said) do they appear! Truly "in many parts and many manners did God speak" in this composite book of Isaiah! To the Prophecy of Restoration we may fitly apply the words, too gracious and too subtly chosen to be translated, of M. Renan, "ce second Isaïe, dont l'âme lumineuse semble comme imprégnée, six cent ans d'avance, de toutes les rosées, de tous les parfums de l'avenir" (*L'Antéchrist*, p. 464); though, indeed, the common verdict of sympathetic readers sums up the sentence in a single phrase—"the Evangelical Prophet." The freedom and the inexhaustibleness of the undeserved grace of God is a subject to which this gifted son constantly returns with "a monotony which is never monotonous."<sup>1</sup> The defect of the disputed prophecies in the former part of the book (a defect, as long as we regard them in isolation,<sup>2</sup> and

<sup>1</sup> The Rev. G. G. Bradley, Master of University College, Oxford, in an acedemical sermon on the Book of Isaiah, preached February 18, 1875.

not as supplemented by those which come after) is that they emphasize too much to a Christian feeling the stern, destructive side of the series of divine interpositions in the latter days. But we will not attempt to exhaust a subject on which any thoughtful reader is competent to speak.

VI. How is it, then, that so many Biblical students (especially in Great Britain and America) still adhere to the view, so profoundly opposed to philological exegesis, that one man wrote the whole of the book of Isaiah? Partly no doubt from a fear lest, in giving up the view of Isaiah held in the time of Christ, the orthodox theology should be insensibly undermined. The fear was at one time justified, *i.e.*, in the early stages of the critical controversy; but the fact that orthodox theologians and men of deep Christian faith do hold the composite origin of Isaiah is a practical proof that the fear is no longer opportune. Another reason is a certain instinctive aversion to the questioning of time-honoured traditions, and an æsthetic abhorrence of disintegration—a bad reason, for (1) ancient traditions are seldom entirely wrong, and it is the element of truth which gives them vitality, and (2) disintegration is only a preliminary to reconstruction. A third reason, often operating in combination with the second, is worthy of all respect. It is that in reading the disputed prophecies, especially those which form the latter part of the book, conservative critics (if we may be allowed the phrase) are conscious of a number of peculiarities both of phraseology and (in chaps xl.-lxvi.) of historical allusion which raise associations of the age of Isaiah. We have already referred to the latter class of peculiarities. They are indeed of more importance than the former, which can obviously be explained by the profound influence which so great a prophet as Isaiah must have exercised, and demonstrably did exercise, on his successors. The view which has been indicated above as the most just to exegetical facts, and to what we know from other sources of the editorial activity of the *Sopherim*, is that the latter part of the book of Isaiah is of an origin as composite as the former. It is, however, of course our duty to mention the prevalent explanation of the conservative school of critics, *viz.*, that the allusions to the scenery of Palestine and to the religious condition of the Jews of a time prior to the exile are Isaiah's involuntary betrayals of his authorship. It is admitted that there are numerous passages which presuppose the fall of Jerusalem and the residence of the exiles in Babylonia. But it is urged that the other class of passages are so many providentially permitted indications of the true date of the author, who was in reality the subject of an extraordinary ecstatic impulse, which almost, but not altogether, effaced his consciousness of the present. To quote from the same able and interesting sermon referred to above, "The Isaiah of the vexed and stormy times of Ahaz and Hezekiah is supposed in his latter days to have been transported by God's Spirit into a time and a region other than his own. . . . The voices in his ears are those of men unborn, and he lives a second life among events and persons, sins and suffering, and fears and hopes, photographed sometimes with the minutest accuracy on the sensitive and sympathetic medium of his own spirit." The objection is, first, that this theory is extremely artificial; secondly, that the only allusions greatly worth considering occur in masses in those portions only of the second part of Isaiah which, for a combination of reasons, should most probably be separated from the remainder; and thirdly, that this theory does not do justice to those passages which contain indications at once of a Palestinian locality and of a post-exile date.

But if sufficient account has not yet been taken by many

anti-traditionalist critics of the data which conflict with the Babylonian origin of Isa. xl.-lxvi. as a whole, it must in fairness be admitted that conservative critics have not adequately appreciated those which make distinctly for a Babylonian origin. Take Isa. xl.-xlviii. by itself (it must be allowed to form a whole), abstracting from all considerations of modern controversy, and no one would dream of assigning it to any other time than the close of the exile, any more than he would of ascribing "By the waters of Babylon we sat down and wept" (Pa. cxxxvii.) to the authorship of David. There might have been a case for the Isaianic origin of "Go ye out from Babylon" (xlviii. 20), if the passage had only run, "Behold, in days to come my people shall go forth from Babylon." There might have been a case for such an origin of "Thus saith Jehovah to Cyrus" (xlv. 1), if the passage had but run thus, "Behold the days come that I will raise up a king, Cyrus by name." But no one fresh from the perusal of the other great prophetic writings would imagine such a thing as that Isaiah had died to his actual present, and lived again among men still unborn.

A few points of detail have still to be considered.

(a) To the argument from phraseology, on which Kuebel in particular has laid great stress in the anti-traditional interest, it is impossible to do justice here. A bare list of names would not be luminous, and the lists given by recent English conservative critics warn us of the difficulty of constructing such catalogues fairly. None of these critics appear quite to understand the object of the appeal to phraseology, or to be aware that the mere peculiarity of a word is not important, unless it points to a different linguistic stage from that of the historical Isaiah, or unless its sense is one that implies a great development of thought. It appears to us indeed that the argument from phraseology is not one of much critical moment; but on this part of the subject we must refer to more special treatises.

(b) Nor can we satisfy ourselves that the existence of parallels between passages of the disputed prophecies and passages of pre-exile prophets—a chief bulwark of the conservative theory as presented by Delitzsch—is a fact of much greater value.<sup>1</sup> In some respects indeed these parallels are most interesting and instructive. They help us to form a fuller idea of the literary and prophetic physiognomy of the prophecies. They show us too "how instinctively the prophets formed as it were a canon of prophetic Scriptures for themselves, and also how free they were from the morbid craving for originality." But on which side the originality lies it is not always easy for a candid mind to determine; one must be on one's guard against a prejudice in favour of the more brilliant genius, and against thinking that the more strikingly expressed passage is necessarily the more original. For has not a brilliant genius been known to copy word for word from an extremely ordinary writer? Having said thus much by way of caution, let us add some of the more striking parallels to passages of Isa. xl.-lxvi. in prophets earlier than the close of the captivity.

Isa. xxxiv. 6, 7;	comp. Jer. xlv. 10.
Isa. xl. 13, 14,	Jer. xxxii. 18.
Isa. xl. 18, 20,	} Jer. x. 3-11.
and parallels,	
Isa. xli. 14,	} Jer. xxx. 10, xlv. 27.
Isa. xliii. 5,	
Isa. xlv. 2,	
Isa. li. 15,	Jer. xxxj. 35.
Isa. lv. 3,	Jer. xxxii. 40.
Isa. lvi. 9,	Jer. xii. 9.
Isa. lvii. 9,	Ezek. xxiii. 40, 41.
Isa. lviii. 7,	Ezek. xviii. 7, 16.
Isa. li. 19,	Nah. iii. 7.
Isa. li. 20,	Nah. iii. 10.
Isa. lii. 1, 7,	Nah. i. 15 (Heb. ii. 1).
Isa. xlvii. 8, 10	Zeph. ii. 15.
Isa. lxvi. 20,	Zeph. iii. 10.

(c) With regard to the historical appendix to the first part of the book of Isaiah (chaps. xxxvi.-xxxix.), we must be, as usual, on our guard against admitting too simple a solution. Knowing, as we do, from 2 Chr. xxxii. 32 (comp. ix. 29) that the prophet wrote one, if not more than one, historical monograph, it would be natural to assume that this appendix is an extract from that monograph. When we examine it more closely, however, we see that this cannot be the case. "This is shown (1) by the variations with which the

<sup>1</sup> For similar arguments of minor importance, see Cheyne, *The Prophecies of Isaiah*, vol. ii. pp. xv., 202.



narrative is repeated in 2 Kings xviii. 13–xx. 19, and which are, generally speaking, very peculiar, and therefore probably more authentic. See especially Isa. xxxviii., noticing the abbreviation of vers. 4 and 5, the addition of the Psalm of Hezekiah, and the wrong position given to ver. 21. (2) By the circumstance that the style of Isa. xxxvi. and xxxvii. (2 Kings xviii.–xix. 37) contains nothing to distinguish it from that of many other portions of the two books of Kings, which are evidently extracted from the royal chronicles, and that the style of Isa. xxxviii. (excluding the Psalm) and xxxix. closely resembles that of the final editor of the historical books (Genesis–2 Kings) (*The Book of Isaiah Chronologically Arranged*, p. 102). To this it may now be added that the first verse of the narrative contains a glaring mistake (which also profoundly affects the sequel), which can only be accounted for on the supposition that a long period had elapsed since the events referred to. We refer to the substitution of “the fourteenth year (of King Hezekiah)” for “the twenty-seventh,” and the confusion of the invasion of Sargon with the later one of Sennacherib (see *The Prophecies of Isaiah*, vol. i. p. 192, &c.). In short, the case of this appendix appears to be similar to that of the passage vii. 1–ix. 7, which can be shown to have assumed its present form not till long after the utterance of the prophecies imbedded in it. That the great prophecy enshrined in our historical appendix is in the highest degree Isaianic we have already pointed out; it were to be wished that there were equal grounds for assuming that the so-called Psalm of Hezekiah were really the work of that pious and literary king. The probability is that we have in this Psalm the work of one of those inspired but less original Sopherim of whom we have spoken above.

(d) Isaiah, it is admitted, was a prophet and an historian; was he also a psalmist? His twelfth chapter (if really by him) is in fact a psalm; but Hitzig goes further, and conjectures that Psalms xlv.–xlviii. were composed by our prophet on the successive overthrows of the Syrians, Philistines, and Assyrians (*Die Psalmen*, i. 255–6). All, however, that can safely be inferred from the parallelisms which Hitzig produces is that the prophecies of Isaiah exercised a strong influence on contemporary or later writers, especially those which dealt with the great turning points in the history of the nations. A still larger harvest of affinities may be reaped in the later psalms, as Canon Elliott has well shown (*Speaker's Commentary*, iv. 506–512), and it will be noticed that only one of them, and that not one of the closest, relates to the acknowledged prophecies of Isaiah. Similarity of style is not an infallible proof of unity of authorship.

(e) One of the most important contributions to the right estimate of II. Isaiah (as also of the book of Daniel) has been the discovery of two cuneiform texts relative to the fall of Babylon and the religious policy of Cyrus. The results are not favourable to a mechanical view of prophecy as involving absolute accuracy of statement on points not essentially connected with moral and religious truth. Cyrus appears in the unassailably authentic cylinder inscription “as a complete religious indifferentist, willing to go through any amount of ceremonies to soothe the prejudices of a susceptible population.” He preserves a strange and significant silence with regard to Ormazd, the supreme God of Zoroastrianism, and in fact, as Professor Sayce and M. Halévy have shown, cannot have been a Zoroastrian believer at all. “Cyrus, on whom the prophet of Jehovah lavishes such honourable titles,—Cyrus, who, the prophet even appears to hope, may be won over to the true faith, is a polytheist and an idolater.” On the historical and religious bearings of these two inscriptions the reader must be referred to the essay on “II. Isaiah and the Inscriptions” in the work already several times quoted from. It must be carefully remembered that “the inscription, when rightly understood, is not in conflict with the prophecy, but only with a gloss upon the prophecy,” and that our estimate of prophecy must be brought into harmony with facts, not facts with our preconceived theory of prophecy.

In conclusion, it seems not inopportune to remind the student that the investigation of the critical problems of the Old Testament is not mere guess work, but proceeds on the sure basis of comparison and analogy. We have got beyond the stage at which the books of the Old Testament were regarded as so many isolated phenomena, and reached the conception of a literature, with closely related parts, slowly and very gradually brought into its present shape. The coordination in an historical outline of the results already attained would be the most effectual justification of the critical analysis of the Old Testament. It is worse than idle, however, to meddle with analytical work without a preliminary discipline in the disinterested exegetical study of the texts.

*Commentaries, &c.*—1. On the entire book:—Calvin, *Comm. in Jes.*, 3d. ed., Geneva, 1570; Vitringa, *Comm. in libr. proph. Jesajæ*, 2 vols., Leeuwarden, 1714–26, and 1724; Lowth, *Isaiæ: a new translation, with a preliminary dissertation and notes*, London, 1778; Gesenius, *Der Pr. Jes. überetzt*, &c., Leipzig, 1821; Hitzig, *Der Proph. Jes.*, Heidelberg, 1833; Ewald, *Die proph. des A. B.*, 2d. ed., 3 vols., Göttingen, 1867–68 (in course of translation); Knebel, *Der Pr. Jes.*, 4th ed. (by Diestel), Leipzig, 1872; Drechsler, *Der Pr. Jes.*, 3 vols., Stuttgart and Berlin, 1845–57; Delitzsch,

*Der Pr. Jes.*, 3d. ed., Leipzig, 1879; Nägelsbach, *Der Pr. Jes.*, in Lange's *Bibelwerk*, Bielefeld and Leipzig, 1877; Alexander, *Commentary*, ed. Eadie, 2 vols., Edinburgh, 1865; Kay, in *Speaker's Commentary*, vol. v., London, 1875; Cheyne, *The Book of Isaiah Chronologically Arranged*, London, 1870, and *The Prophecies of Isaiah*, 2 vols., London, 1880–81. 2. On portions of the first part:—Meier, *Der Pr. Jes. I.* (on chaps. i.–xxiii.), Pforzheim, 1850; Roerla, “Annotationes . . . ad vaticinia Jes. i.–ix. 6” (in Jayn-boll's *Orientalia*, vol. i. p. 67, &c.); Stade, *De Jes. vaticiniis Æthiopicis diatribæ*, Leipzig, 1873. 3. On the second part:—Stier, *Jesajas nicht Pseudo-jesajas*, Barmen, 1850; Seinocke, *Der Evangelist des alten Testaments*, Leipzig, 1870. 4. On the critical question of the second part:—Delitzsch, “Schlussbemerkungen,” in Drechsler's *Commentar*, Theil iii.; Rutgers, *De eehtheid van de tweede gedeelte van Jesaja*, Leipzig, 1866; Klostermann, *Zeitschr. für lutherische Theologie*, 1876, p. 1, &c. 5. Monographs and generally illustrative works:—Hengstenberg, *Christologie des alten Testaments*, vol. ii. (translated in Clark); Strachey, *Jewish History and Politics in the Times of Sargon and Sennacherib*, 2d. ed., London, 1874, 8vo; Neubauer and Driver, *The Fifty-third Chapter of Isaiah according to the Jewish Interpreters*, 2 vols., Oxford; 1877; Urwick, *The Servant of Jehovah, a Commentary*, Edinburgh, 1877; Caspari, *Beiträge zur Einleitung in das Buch Jes.*, Berlin, 1848; Payne Smith, *The Authenticity and Messianic Interpretation of the Prophecies of Isaiah*, Oxford and London, 1862; McGill, “Critical Remarks on Isaiah, xviii. 1, 2,” in *Journal of Sacred Literature*, 1862, pp. 310–324; Cheyne, *Notes and Criticisms on the Hebrew Text of Isaiah*, London, 1868; Lagarde, *Semítica*, i., Göttingen, 1878 (pp. 1–32 contain critical notes on Isaiah i.–xvii.). (T. K. C.)

ISAURIA, in ancient geography, was a district in the interior of Asia Minor, bounded by Mount Taurus and Cilicia on the S., by Lyeaonia on the E., by Phrygia on the N., and by Pisidia on the W. Like the neighbouring Lyeaonia, it consisted in great part of a cold and barren upland plain, while the southern portions were rugged and mountainous. No mention is found of the Isaurians during the early periods of the history of Asia; but they were doubtless, like their neighbours the Pisidians, in all ages a lawless race of freebooters, owing merely a nominal allegiance to either the Persian or the Macedonian monarchy. The only occasion on which they come prominently forward in history was during the war of the Cilician and other pirates against Rome, in which they took so active a part that the proconsul P. Servilius deemed it necessary to follow them into their mountain fastnesses, and compelled the whole people to submission, an exploit for which he received the title of Isauricus (75 B.C.). They were afterwards placed for a time under the rule of Amyntas, king of Galatia; but it is evident that they always continued to retain their predatory habits and their virtual independence; and under the Roman empire they gave so much trouble that it was ultimately agreed to leave them in the undisturbed possession of their inaccessible mountain homes. In the 4th century they are still described by Ammianus Marcellinus as the scourge of the neighbouring provinces of Asia Minor; but they are said to have been effectually subdued in the reign of Justinian.

From the nature of the country Isauria contained but very few towns, the most important of which bore the name of Isaura, as the capital of the district. It was rebuilt by Amyntas, and extensive remains of it are still visible at a place called Zengi Bor. Carallia, which seems to have been included in the province, and was noted as giving name to the Lake Carallitis, was situated farther north. This lake, now known as the Kereli Göl, is a considerable sheet of water; it communicates by the river called Bei Sechr with a lesser lake called by Strabo Trogitis, now known as Soghla Göl; both are perfectly fresh. The boundary of Isauria and Lyeaonia seems to have been always unsettled. Strabo indeed speaks of Isauria as a part of Lyeaonia, but it is certain that they were separate districts for administrative purposes, though their limits cannot be accurately defined. Of the ethnographical character or origin of the Isaurians we know nothing.

The comparatively obscure tribe of the Isaurians had

the honour on two occasions of giving birth to a Byzantine emperor. The first of these, Zeno, in the 5th century (474-495 A.D.), was not calculated to reflect any lustre on his native country; but at a later period Leo III., who ascended the throne of Constantinople in 718, and reigned till 741, was a monarch of vigour and capacity, and became the founder of a dynasty which ruled over the empire for three generations.

ISCHIA, the ancient *Pithecosa*, *Ænaria*, or *Inarime*, and the mediæval *Iscla*, a volcanic island of Italy, is situated at the north entrance to the Bay of Naples, about 15 miles south-west of the Cape of Miseno. The circumference, omitting the irregular indentations of the coast-line, is about 19 miles, and the superficial area about 26 square miles. Monte Epomeo or San Nicola, the ancient Epomens or Epopeus, which rises to the height of 2600 feet above sea-level, is the highest point. The principal summit is surrounded by twelve inferior volcanic cones, from one of which the last eruption in the island took place in 1302. The valleys between the mountains and the plain which occupies a part of the interior are remarkable for their luxuriant vegetation and beautiful scenery. The vegetable products of Ischia are very rich and various. Most of the cultivated land is occupied by vines, from which a somewhat acrid white wine is manufactured. Corn, oil, and southern fruits are produced in luxuriant profusion. Oak and chestnut groves, thickets of myrtle and leutiscus, cotton-trees, mulberries, and arbutus stretch up the mountain sides and along the pastures. Iron and sulphur are found on the island, and bricks, tiles, and pottery are manufactured at Casamicciola. The great sources of wealth to the island are the numerous thermal mineral springs, which are among the strongest and most efficacious in Europe. Casamicciola is the headquarters of the water, hot-air, and sand baths, but Lacco is also popular in the season. Though the nominal bathing season lasts from June to September, the exquisite climate and lovely situation of Ischia allure visitors all the year round. The island has suffered heavily from earthquakes. A very severe shock in March 1881 occasioned great loss of life and property. The inhabitants, about 25,000 in number, are distinguished by a peculiar dialect and figure, and are chiefly engaged in tillage and fishing. The chief town is Ischia (6500) on the east coast, the seat of a bishop, with an old castle of the 15th century. Other towns are Forio (6100) on the west coast, Casamicciola and Lacco on the north, Pappia, and Moropana.

Ischia was first colonized by Greeks from Chalcis in Eubœa, but although the colony rose to prosperity it was driven from the island by volcanic outbreaks. Similar convulsions dispersed a second colony established by Hiero of Syracuse. From the Neapolitans, who were the next settlers, the island passed into the hands of Rome, but Suetonius informs us that Augustus again restored it to Naples, in exchange for the inferior Capree. The name of Ischia does not often occur in Roman history, but it seems to have been early in repute as a resort for invalids. After the fall of Rome, it suffered much and repeatedly at the hands of the successive invaders and rulers of Italy. In 1299 it was captured by Charles II. of Naples, since which time it has had a full share of the vicissitudes that are so characteristic of the history of Italian towns and provinces.

ISCHL, a favourite watering-place in the district of Gmunden, Upper Austria, is beautifully situated on the peninsula formed by the junction of the rivers Ischl and Traun, and is surrounded by high mountains, presenting scenery of the finest description. It has mineral springs and numerous brine and brine-vapour baths. The brine used at Ischl has in 16 oz. 233 grains of chloride of sodium (common salt) and 15 grains of other solids. The principal buildings include the casino, erected in 1875, the town church, with fine frescoes, the theatre, the official buildings, and the imperial villa surrounded by a beautiful park. Ischl first came into repute in 1822, and since that time the yearly advent of the imperial family

and of many of the Austrian nobility has made it one of the most fashionable and prosperous spas of Europe. In the neighbourhood is a very productive salt-mine, which has been worked for more than three hundred years. The place has some trade in wood, gypsum, and chalk. The population in 1869 was 6842.

See Kaan's *Ischl et ses Environs*, Vienna, 1879.

ISEGHEM, a town of Belgium in the arrondissement of Roulers and the province of West Flanders, is situated on the small river Mandel, about 10 miles north-east of Courtrai. It has manufactures of linen, hats, and sugar. Tobacco is cultivated in the environs. The population in 1876 was 7753.

ISÈRE, a department of south-eastern France, formed from the southern part of the old province of Dauphiné, is bounded on the N. by the department of Ain, E. by Savoie and Hautes-Alpes, S. by Hautes-Alpes and Drôme, and W. by Drôme, Loire, and Rhône. It lies between 44° 43' and 45° 43' 19" N. lat., and between 4° 43' 32" and 7° 6' 9" E. long., being about 100 miles long from north-west to south-east and 60 miles broad from north-east to south-west. It derives its name from the river Isère, which flows through it from north-east to south-west. The Rhone, with several tributaries, is the other chief stream. Lake Paladuc is the largest of several lakes in the department. The surface is mountainous, especially in the south-east, which is occupied by lofty offshoots of the Alps, some of whose summits are covered with perpetual snow. The Belledonne, the Grande-Rousses, the Oisans, the Grande Chartreuse, famous for its monastery, the Vercors, the Lans, and the Dévoluy are the chief groups and ranges which are found either wholly or partly within Isère. The highest point is the Aiguille du Midi (9800 feet). Towards the north and west the country gradually slopes down in fertile terraces to the Rhone. The river valleys are remarkable for their extent and fertility; that of Graisivaudan is reckoned one of the richest in France. The climate of Isère varies according to the irregularity of the surface, but is on the whole colder and ruder than is usual at its latitude. Agriculture occupies about four-fifths of the inhabitants, although less than half the total area is suited for cultivation. Wheat, barley, rye, oats, buckwheat, maize, potatoes, hemp, colza, and fruit, and, on the southern slopes, vines, walnuts, mulberries, and almonds, are the principal crops. Valuable pastures, on which mules and large flocks of sheep are bred, extend up the mountain to meet the large forests stretching down from the snow-line. Silkworms are reared easily and profitably; fish is exported in considerable quantity to Paris; and the cheese of the department is much esteemed. Gold and silver are found in small quantities. The chief minerals are coal, lignite, and iron; but copper, lead, mercury, zinc, and antimony, with marble, gypsum, granite, porphyry, and slate, are also worked. After agriculture the chief industry is the working of the minerals; glove-making occupies about 20,000 persons in and around Grenoble; while the department is the leading district of France for the manufacture of paper. Wine, felt, silk, linen, cloth, beet-root sugar, straw-hats, brandy, glass, and other commodities are also manufactured. There is trade in iron, steel, and other metals, cement, lime, grain, wine, liqueurs, and gloves. Isère is divided into the arrondissements of Grenoble, Vienne, La Tour-du-Pin, and Saint Marcellin, with 45 cantons and 558 communes. The chief town is Grenoble. The total area is 3200 square miles, and the population in 1866 was 581,386, and in 1876 581,099.

ISERLOHN, chief town of a circle in the government district of Arnsberg and province of Westphalia, Prussia, is situated on the Baar, in a bare and hilly region, 17 miles



west of Arnsberg. Among the principal buildings are the town-church, the synagogue, the hospital, the orphanage, the poorhouse, and the new town-house. There is a real school of the first class, and a commercial school for the province. Iserlohn is one of the most important manufacturing towns in Westphalia. Its chamber of commerce was founded in 1850. Both in the town and neighbourhood there are numerous foundries and works for iron, brass, steel, and bronze, while the manufactures include wire, needles and pins, fish-hooks, machinery, umbrella-frames, thimbles, bits, furniture, chemicals, coffee-mills, and pinchbeck and britannia-metal goods. A part of the town has recently been endangered by the calamine mines beneath. Iserlohn is a very old town, its guild of armourers being referred to as "ancient" in 1443. The population in 1875 was 16,838.

ISERNIA, a town of Italy, capital of a district in the province of Campobasso, is pleasantly situated among the Apennines, 54 miles north-east of Naples. The town, which is closely built and dirty, consists chiefly of one long narrow street running along the crest of a hill from south-west to north-east, near the middle of which are an ancient arch and a fine old marble fountain. Of the numerous Roman antiquities in and near the town the most considerable is the subterranean aqueduct, which may be traced for the distance of about a mile, and which is still used to supply the fountains and manufactories of Isernia with water. There is also a fine old Roman bridge just outside the town. On a hill half a mile distant is a chapel, once much frequented, to the saints Cosmas and Damian. Isernia has manufactures of woollens, paper, pottery, and tiles. It is the seat of a bishop, and of a civil and criminal court. Population in 1875, 9066.

Isernia is the ancient Samnite town *Æsernia*, which was conquered and colonized by the Romans about 264 B.C. The massive polygonal walls which form the basis of the present walls in nearly their entire circuit are attributed to the Samnites. During the social war Isernia was captured by the allied Italians, and became for a time their headquarters, and at the conclusion of the war was so severely chastized by the Romans as to be almost deserted. Its fortification in the Middle Ages seems to have been an occasion for destroying many of the Roman remains, a result which numerous earthquakes have helped to attain. That of 1805 overthrew the cathedral and did much damage. In 1799 Isernia was stormed by the French, and in 1860 it was sacked and suffered fearful atrocities during a Bourbonist insurrection.

ISHMAEL (יִשְׁמָעֵאל, "God hears"; Ἰσμαήλ), the son of Abraham by his Egyptian concubine Hagar, was born when his father was eighty-six years old, received circumcision along with Isaac when thirteen years of age, and some three or four years later (apparently in his sixteenth year) was, on account of the jealousy of Sarah, who had seen him "playing" (Hebrew), turned out of doors along with his mother. It had been foretold to his mother before his birth that he should be "a wild ass among men," and that he should dwell "before the face of" (that is, to the eastward of) his brethren. It is subsequently stated that after leaving his father's roof he "grew, and became an archer, and dwelt in the wilderness of Paran, and his mother took him a wife out of the land of Egypt." It is also related that he was present at the burial of Abraham. His twelve sons are enumerated by their "villages" and "encampments" in Gen xxv., where also (ver. 18) their locality is indicated by the expressions that "they dwelt from Havilah unto Shur that is east of Egypt, and he settled to the eastward of his brethren" (Heb.). Of the twelve names given, only a few have historical associations apart from the Biblical records. Nebajoth and Kedar suggest the Nabataei and Cedrei of Pliny (v. 12), the first-mentioned of whom were an important Arab people after the time of Alexander, and for some time both before and after the Christian era formed an independent kingdom

(Nabataene). Dumah may perhaps be the same as the Domata of Pliny (vi. 32) and the Δοίμεθα or Δομαιθα of Ptolemy (v. 19, 7; viii. 22, 3), and Jetur is obviously the Ituræa of classical geographers. The word "Ishmaelite" is sometimes used in Scripture in a wide sense, which includes such families as the Midianites (Judg. viii. 24), who, according to Gen. xxv., are children of Keturah. On the other hand, no connexion is alleged between the Ishmaelites and the Hagarites (I Chr. v. 10) or Hagarenes (Ps. lxxxiii. 7), the Ἀγραῖοι of Ptolemy and Strabo. According to the Mahometan Arabs, who recognize Ishmael as their ancestor, he lies buried with his mother in the Kaaba in Mecca.

ISHPEMING, a city and township in Marquette county, Michigan, U.S., is situated in the heart of the Lake Superior iron-fields, about 15 miles west of Lake Superior, and 400 miles north of Chicago, with which it is connected by rail. The export of iron-ore in 1880 was 700,000 tons, valued at \$3,500,000, while the lumbering and other industries are proportionately extensive. There are two blast furnaces, with a daily capacity of 60 tons of pig iron. Ishpeeming was incorporated as a city in 1873. In 1880 the population of the city was 6,039, and of the township 1,967.

ISIDORUS HISPALENSIS, or ISIDORE OF SEVILLE, one of the most influential writers of the early portion of the Middle Ages, flourished during the latter part of the 6th and the early part of the 7th century. The exact date of his birth is unknown; he died 636 A.D. Of the particulars of his life, specially of the earlier portion, little is known with certainty. He was the son of a wealthy and distinguished native of Cartagena, named Severianus, and his elder brother, Leander, was bishop of Seville. Isidore succeeded his brother in his bishopric at the beginning of the 7th century, and acquired high renown in the church, not only by his conduct of his see, but by his numerous theological, historical, and scientific works. His learning and eloquence are celebrated by his contemporaries, and his reputation was even greater in the succeeding ages. During the latter portion of the period which historians are accustomed to call the Dark Ages, extending from the 7th to the 10th century, the writings of Isidore furnished mental pabulum to all students and scholars; and, though one can find in them little of real value and no originality, they have at least the merit of having served to keep alive, even in a form far from adequate, some remnants of the older culture and learning. The most elaborate of his writings, that entitled *Etymologiarum Libri XX.*, or sometimes *Origines*, is an encyclopædic work, eclectic in character, and presenting in dry compendious form the sum of the knowledge of the age on all branches of scientific research. Later writers make continual references to the *Etymologies*, which served for long as the general text-book. The arrangement of materials in the twenty books is unsystematic, and on most matters of scientific experience it is evident that the writer depends on second-hand information. Perhaps the most interesting of the books are the fifth, containing a sketch of universal history, and the ninth, on language. Various smaller writings of Isidore, such as the two works *Differentiarum*, the two books on synonyms, and the short tractate *De Natura Rerum*, are supplementary to the *Etymologies*, and carry out in detail what is there given in epitome. The tract *De Natura Rerum* is specially interesting as containing the sum of physical philosophy during this period of the Middle Ages. Of Isidore's many writings on theological subjects no detailed account can be given.

The works of Isidore have been published with preface by F. Arevalo.—*S. Isidori Hispalensis episc. Opera omnia*, 7 vols. 4to, Rome, 1797-1803 (2 vols. of Prolegomena). The *De Natura Rerum* has been edited separately by G. Becker, Berlin, 1857. See

Ebert, *Geschichte d. Litteratur d. Mittelalters im Abendlande*, i. 555 sq. Also Pouchet, *Histoire des Sciences Naturelles au Moyen Age*, 1845, and the general histories of Latin literature.

ISINGLASS. See GELATIN.

ISKELIB, or ESKILUP, a town in the province of Kastamuni, Asiatic Turkey, is situated near the left bank of the Kizil Irmak, at an elevation of 2542 feet above sea-level. The population is estimated by Ritter at 9000.

ISLA, JOSÉ FRANCISCO DE (1703-1781), Spanish satirist, was born at Segovia in 1703, and became a member of the Society of Jesus, in which he distinguished himself both as a teacher and as a preacher; on the expulsion of his order from Spain in 1767 he betook himself to Bologna, where after some years of impaired health he died in 1781. His first literary experiment was the *Juventud Triunfante* ("Triumph of Youth," Salamanca, 1727), a cleverly disguised satirical account of a festival celebrated in 1727 at Salamanca in honour of two young Jesuits who had recently been canonized by Benedict XIII., in which he was assisted by a brother priest named Losada; it was followed in 1746 by his *Triunfo del Amor y de la Lealtad: Dia Grande de Navarra*, being an account of the extravagant ceremonies with which the accession of Ferdinand VI. of Castile had been celebrated in Pamplona. This was written in so delicate a vein of satire that at first the parties chiefly ridiculed felt really flattered, and expressed their gratitude to the author; ultimately, however, its true meaning was discerned, and so strong was the reaction that he had to leave the locality. The work on which Isla's claim to a place in the history of the literature of his country rests, however, is his *Historia del Famoso Predicador Fray Gerundio de Campazas*, in which in course of an imaginary biography of a preaching friar named Gerundio many of the absurdities that deformed the Spanish pulpit at that time are ably held up to ridicule. The first volume appeared at Madrid in 1758, duly approved by the ecclesiastical authorities, who probably were not unwilling that the faults then glaringly prevalent among preachers should be chastized and if possible corrected; so great was the offence given, however, to the religious orders, and especially to the Dominicans, by the causticity of *Fray Gerundio*, that the royal authority was at last called in to prohibit the book. The second volume, which therefore could only appear surreptitiously, is dated "Campazas" (i.e., Madrid), 1770, and like the first bears on the title page the name of Don Francisco Lobon de Salazar as its author. An anonymous translation by Thomas Nugent (*The History of the famous preacher Friar Gerund de Campazas, otherwise Gerund Zotes*) appeared in London, in two volumes, in 1772. Six volumes of *Sermones*, written between 1729 and 1754, and published in 1792, show that Isla's own high reputation as a preacher was not undeserved; and his *Cartas Familiares* (6 vols., Madrid, 1785-86) are written in an easy and attractive style. He is also well known in the Peninsula as the eminently successful translator of Gil Blas (*Gil Blas de Santillana vuelto á su patria*, printed at Madrid in 1787), although his strenuously asserted theory that La Sage had borrowed that popular story wholesale from a Spanish source is now entirely exploded.

ISLAMÁBÁD, a town in Kashmir state, Punjab, lies in 33° 43' N. lat., 75° 17' E. long., on the north bank of the Jhelum (Jhilam), there about 80 yards wide, and crossed by a wooden bridge. The town crowns the summit of a long low ridge, extending from the mountains eastward. Below is a reservoir containing a spring of clear water called the Anat Nág, slightly sulphurous, from which volumes of gas continually arise. The water swarms with aered fish. There are large manufactures of Kashmir shawls, also of chintzes, cotton, and woollen goods.

ISLAY, an island on the west coast of Scotland, the most southern of the Hebrides group, is situated in the county of Argyll, between 55° 30' and 55° 58' N. lat. and 6° 2' and 6° 35' W. long., 17 miles west of Cantire and 2 miles south-west of Jura. It has an area of 220 square miles, or more than 140,000 acres, and its rental is nearly £38,000. It is the richest and most productive of the group, and on that account has been called the "Queen of the Hebrides." The surface generally is regular, the highest summits being Ben Varu (1500 feet) and Ben Ronastel (1050 feet). Islay House, the ancient seat of the Campbells of Islay, stands at the head of Loch-in-daal. The island is chiefly possessed by three proprietors:—C. Morrison, 67,000 acres; J. Ramsay of Kildalton, 54,250; and K. Finlay of Dunlossit, 17,676. Formerly it was occupied by small crofters and tacksmen, but since 1831 it has been gradually rearranged into large sheep and arable farms. About two-thirds of the sheep are black-faced, the others being mostly Cheviots. Dairy farming is largely followed, and oats, barley, and the various green crops are raised. The chief difficulty in the way of reclamation of the land is the large extent occupied by peat, which has an area of 60 square miles, and is calculated at its present rate of consumption to last 1500 years. The island has long been famous for the distillation of whisky, and at present contains seven distilleries, which produce about 400,000 gallons annually. Port Ellen, the principal village, had 974 inhabitants in 1881. While the population of Islay in 1831 was 14,992, it had decreased in 1851 to 12,334, in 1871 to 8143, and in 1881 to 7512.

Islay was the ancient seat of the "Lord of the Isles," the first to adopt that title being John Macdonald of Isle of Islay, who died about 1386. See HEBRIDES.

ISMAL, a town of Roumania, at the head of a district of the same name, on the left bank of the Kilia branch of the Danube, 30 miles to the east of Galatz, with a river frontage of about 2½ miles. It is the seat of a considerable trade, mainly in grain, but also in wool, leather, and tallow. The population of the town, inclusive of Tutechkoff, was 16,000 in 1856, 31,779 in 1866, and 21,000 in 1876. In 1872 794 ships with a total burden of 81,445 tons entered, and 790 with 81,711 tons cleared.

Originally a Turkish fortified post, Ismail had by the end of the 18th century grown into a place of about 30,000 inhabitants, having 4000 dwelling-houses inside and 2500 outside the enceinte, and numbering among its public buildings four mosques, two churches for the Moldavians, one for the Armenians, and one for the Greeks (see account by a Russian officer in Bernoulli, *Sammlung kurzer Reisebeschreibungen*, Berlin, 1781). The inhabitants were mainly Turks and Tartars, but not far from the town there was a settlement of Raskolniks, who had fled from the persecution of Peter I. Ismail was occupied by the Russians in 1770, and twenty years later its capture was one of the brilliant achievements of the celebrated Suwaroff. On this occasion the garrison was 40,000 strong, and the assault cost the invaders 10,000 and the defenders 30,000 men. "Never," wrote Suwaroff to Potemkin, the Russian minister, "was a fortress stronger than Ismail, and never was a defence more desperate. But Ismail is taken." The victory was the theme of one of Derzhavin's odes. In 1809 the town was again captured by the Russians; and, when in 1812 it was assigned to them by the Bucharest peace, they chose it as the central station for the fleet of the Danube. It was about this time that the town of Tutechkoff, with which it was incorporated in 1830, grew up outside of the fortifications. These were dismantled in accordance with the treaty of Paris (1856), by which that part of Bessarabia in which Ismail was included was made over to Roumania.

On the other side of a small lake not far from the town lies the village of Matrasofka; and 4 miles to the east is another village, Old Nikrasofka, with the following inscription:—*Terminus australis arcus meridionalis 25° 20' quem inde a fluvio Danubio ad Oceanum Arcticum usque per Rossiam, Sueciam, et Norwegiam, jussu et auspiciis imperatorum augustissimorum Alexandri I. atque regis augustissimi Oscaris I. Annis MDCCCVI ad MDCCCLII continuo labore emensi sunt CCC geometræ. Latitudo 45° 20' 28"*



ISMAILIA, a town of Egypt, nearly in the centre of the isthmus of Suez, on the western shore of Lake Timsah (which is traversed by the canal), and connected with the railway which joins Zagazeg, and consequently Alexandria and Cairo, with Suez. It was laid out in 1863, and for a time had a population of about 3000, mainly engaged in the construction of the canal. The broad macadamized streets and regular squares bordered with trees give it an attractive appearance; and it has besides the advantage, a rare one in Egypt, of being surrounded on three sides by flourishing gardens. The Quai Mehemet Ali, which lies along the canal for upwards of a mile, contains the clâlet long occupied by M. de Lesseps. At the end of the quay are the works for supplying Port Said with water; and there is a bathing establishment on Lake Timsah. Ismailia is a separate *mohafza* or governorship, and has a vice-regal palace and a court of first instance. The population was returned as 3062 in 1872, and as 1897 in 1877. On the other side of the lake are the so-called Quarries of the Hyænas, from which the building material for the town was obtained.

ISMAILIA, or GONDOKORO, a famous mission-station and market-place in the territory of the Bari negroes on the right bank of the White Nile, about 330 miles, according to Baker, above the confluence with the Bahr Giraffe, and about 200 miles below the northern end of Lake Albert Nyanza, in 4° 54' 5" N. lat. and 31° 46' 9" E. long. The name Ismailia is more strictly applicable only to the military post established by Baker in 1871, and Gondokoro, as it is the more ancient, is still the more ordinary designation. In former times Gondokoro was a great centre of the ivory and slave trade; and, though the site is now almost forsaken for ten months of the year, there is still a considerable ivory market held in December and January. In connexion with the mission instituted by Pope Gregory XVI in 1846, the pro-vicar Knoblecher founded a station at Gondokoro in 1851, the principal station being at Khartum. A succession of misfortunes, including the death of Knoblecher in April 1858 and a famine in 1859, led to the final abandonment of the place. An interesting series of meteorological observations taken at Gondokoro will be found in *Atti dei Lincei*, 1860-61.

ISMID, ISKIMID, or ISNIKIMID (*i.e.*, 'Εἰς Νικομήδειαν), a town of the Turkish vilayet of Khudavendikiar in Asia Minor, in the sandjak of Scutari, situated at the head of the bay of Ismid (the ancient Sinus Astacenus), an inlet of the Sea of Marmora. It is connected by rail with Scutari, and the line is being continued eastward to Ada Bazar. As the seat not only of a pasha but also of a Greek metropolitan and an Armenian archbishop, Ismid retains somewhat of its ancient dignity, but the material condition of the town is little in keeping with its rank; and but few traces are left of the magnificence which it possessed as Nicomedia, the capital of Bithynia. The population, estimated at from 10,000 to 15,000, are engaged in silk weaving and in commerce, Ismid being a great outlet of goods from the interior. See NICOMEDIA.

ISNIK. See NICÆA.

ISOCRATES, one of the ten Attic orators, and one of the most remarkable men in the literary history of Greece, was born in 436 B.C., seven years before Plato. His father Theodorus was an Athenian citizen of the deme of Erchia,—the same in which, about 431 B.C., Xenophon was born,—and was sufficiently wealthy to have served the state as choregus. The fact that he possessed slaves skilled in the trade of flute-making perhaps lends point to a passage in which his son is mentioned by the comic poet Strattis.<sup>1</sup> Several popular "sophists" are

named as teachers of the young Isocrates. Like other sons of prosperous parents, he may have been trained in such grammatical subtleties as were taught by Protagoras or Prodicus, and initiated by Theramenes into the florid rhetoric of Gorgias, with whom at a later time (about 390 B.C.) he was in personal intercourse. He tells us that his father had been careful to provide for him the best education which Athens could afford. A fact of greater interest is disclosed by Plato's *Phædrus*. "Isocrates is still young, Phædrus," says the Socrates of that dialogue, "but I do not mind telling you what I prophesy of him. . . . It would not surprise me if, as years go on he should make all his predecessors seem like children in the kind of oratory to which he is now addressing himself, or if—supposing this should not content him—some divine impulse should lead him to greater things. My dear Phædrus, a certain philosophy is inborn in him." This conversation is dramatically supposed to take place about 410 B.C. It is unnecessary to discuss here the date at which the *Phædrus* was actually composed. From the passage just cited it is at least clear that there had been a time—while Isocrates could still be called "young"—at which Plato had formed a high estimate of his powers.

Isocrates took no active part in the public life of Athens; he was not fitted, as he tells us, for the contests of the popular assembly or of the law-courts. He lacked strength of voice,—a fatal defect in the ecclesia, when an audience of many thousands was to be addressed in the open air; he was also deficient in "boldness" (*τόλμα*). He was, in short, the physical opposite of the successful Athenian demagogue in the generation after that of Pericles; by temperament as well as taste he was more in sympathy with the sedate decorum (*εὐκοσμία*) of an older school. Two ancient biographers have, however, preserved a story which, if true, would show that this lack of voice and nerve did not involve any want of moral courage. During the rule of the Thirty Tyrants, Critias denounced Theramenes, who sprang for safety to the sacred hearth of the council chamber. Isocrates alone, it is said, dared at that moment to plead for the life of his friend.<sup>2</sup> Whatever may be the worth of the story, it would scarcely have connected itself with the name of a man to whose traditional character it was repugnant. While the Thirty were still in power, Isocrates withdrew from Athens to Chios.<sup>3</sup> He has mentioned that, in the course of the Peloponnesian War,—doubtless in the troubles which attended on its close—he lost the whole of that private fortune which had enabled his father to serve the state, and that he then adopted the profession of a teacher. The proscription of the "art of words" by the Thirty would thus have given him a special motive for withdrawing from Athens. He returned thither, apparently, either soon before or soon after the restoration of the democracy in 403 B.C.

For ten years from this date he was occupied—at least occasionally—as a writer of speeches for the Athenian law-courts. Six of these speeches are extant. The earliest (*Or.* xxi.) may be referred to 403 B.C.; the latest (*Or.* xix.) to 394-93 B.C. This was a department of his own work which Isocrates afterwards preferred to ignore. Nowhere, indeed, does he say that he had not written forensic speeches. But he frequently uses a tone from which that inference might be drawn. He loves to contrast such petty concerns as engage the forensic writer with those larger

<sup>2</sup> [Plut.] *Vit. Isocr.*, and the anonymous biographer. Dionysius does not mention the story, though he makes Isocrates a pupil of Theramenes.

<sup>3</sup> Some would refer the sojourn of Isocrates at Chios to the years 398-395 B.C., others to 393-388 B.C. The reasons which support the view given in the text will be found in Jebb's *Attic Orators*, vol. II. p. 6, note 3.

<sup>1</sup> Ἀτζαδίντη, frag. 1, Meineke, p. 292.

and nobler themes which are treated by the politician. This helps to explain what would otherwise be startling. Not long after his death it could be asserted—by his adopted son, Aphareus—that he had written nothing for the law-courts. Whether the assertion was due to false shame or merely to ignorance, Dionysius of Halicarnassus decisively disposes of it. Aristotle had, indeed, he says, exaggerated the number of forensic speeches written by Isocrates; but some of those which bore his name were unquestionably genuine, as was attested by one of the orator's own pupils, Cephisodorus. The doubt would not, indeed, have been even plausible, had not Isocrates frequently spoken of such work with the aversion of one who would gladly forget, if he could, a distasteful episode of early life,—a mere prelude to those labours of riper age in which he afterwards found his delight and his reward.

The real vocation of Isocrates was discovered from the moment that he devoted himself to the work of a teacher and a writer. The instruction which Isocrates undertook to impart was based on rhetorical composition, but it was by no means merely rhetorical. That "inborn philosophy," of which Plato recognized the germ, still shows itself. In many of his works—notably in the *Panegyricus*—we see a really remarkable power of grasping a complex subject, of articulating it distinctly, of treating it, not merely with effect, but luminously, at once in its widest bearings and in its most intricate details. Young men could learn more from Isocrates than the graces of style; nor would his success have been what it was if his skill had been confined to the art of expression.

It was about 392 B.C.—when he was forty-four—that he opened his school at Athens near the Lyceum, and to the end of his life he continued to teach as well as to write. In 339 B.C. he describes himself as revising the *Panathenæicus* with some of his pupils; he was then ninety-seven. The celebrity enjoyed by the school of Isocrates is strikingly attested by ancient writers. Cicero describes it as that school in which the eloquence of all Greece was trained and perfected; its disciples were "brilliant in pageant or in battle,"<sup>1</sup> foremost among the accomplished writers or powerful debaters of their time. The phrase of Cicero is neither vague nor exaggerated. Among the literary pupils of Isocrates might be named the historians Ephorus and Theopompus, the Attic archaeologist Androtion, and Isocrates of Apollonia, who succeeded his master in the school. Among the practical orators we have, in the forensic kind, Isæus; in the political, Leodamas of Acharnæ, Lycurgus, and Hyperides. And these are but a few names out of many. Hermippus of Smyrna (mentioned by Athenæus) wrote a monograph on the "Disciples of Isocrates." And scanty as are now the sources for such a catalogue, a modern scholar<sup>2</sup> has still been able to recover forty-one names. At the time when the school of Isocrates was in the zenith of its fame, it drew disciples, not only from the shores and islands of the Ægean, but from the cities of Sicily and the distant colonies of the Euxine. As became the image of its master's spirit, it was truly Panhellenic. When Mansolas, prince of Caria, died in 351 B.C., his widow Artemisia instituted a contest of panegyric eloquence in honour of his memory. The most accomplished rhetoricians of Greece entered the lists at Halicarnassus; but among all the competitors there was not one—if tradition may be trusted—who had not been the pupil of Isocrates.

Meanwhile the teacher who had won this great reputation had also been active as a public writer. The most interesting and most characteristic works of Isocrates are those in which he deals with the public questions of his own day.

The influence which he thus exercised throughout Hellas might be compared to that of an earnest political essayist gifted with a popular and attractive style. And Isocrates had a dominant idea which gained strength with his years, until its realization had become, we might say, the main purpose of his life. This idea was the invasion of Asia by the united forces of Greece. The Greek cities were at feud with each other, and were severally torn by intestine faction. Political morality was become a rare and a somewhat despised distinction. Men who were notoriously ready to sell their cities for their private gain were, as Demosthenes says, rather admired than otherwise.<sup>3</sup> The social condition of Greece was becoming very unhappy. The wealth of the country had ceased to grow; the gulf between rich and poor was becoming wider; party strife was constantly adding to the number of homeless paupers; and Greece was full of men who were ready to take service with any captain of mercenaries, or, failing that, with any leader of desperadoes. Isocrates draws a vivid and terrible picture of these evils. The cure for them, he firmly believed, was to unite the Greeks in a cause which would excite a generous enthusiasm. Now was the time, he thought, for that enterprise in which Xenophon's comrades had virtually succeeded, when the headlong rashness of young Cyrus threw away their reward with his own life.<sup>4</sup> The Persian empire was unsound to the core,—witness the retreat of the Ten Thousand: let united Greece attack it and it must go down at the first onset. Then new wealth would flow into Greece; and the hungry pariahs of Greek society would be drafted into fertile homes beyond the Ægean.

A bright vision; but where was the power whose spell was first to unite discordant Greece, and, having united it, to direct its strength against Asia? That was the problem. The first attempt of Isocrates to solve it is set forth in his splendid *Panegyricus* (380 B.C.). Let Athens and Sparta lay aside their jealousies. Let them assume, jointly, a leadership which might be difficult for either, but which would be assured to both. That eloquent pleading failed. The next hope was to find some one man equal to the task. Jason of Pheræ, Dionysius the First of Syracuse, Archidamus III., son of Agesilaus—each in turn rose as a possible leader of Greece before the imagination of the old man who, was still young in his enthusiastic hope, and one after another they failed him. But now a greater than any of these was appearing on the Hellenic horizon, and to this new luminary the eyes of Isocrates were turned with eager anticipation. Who could lead united Greece against Asia so fitly as the veritable representative of the Heraclidæ, the royal descendant of the Argive line,—a king of half-barbarians it is true, but by race, as in spirit, a pure Helene,—Philip of Macedon? We can still read the words in which this fond faith clothed itself; the ardent appeal of Isocrates to Philip is extant; and another letter shows that the belief of Isocrates in Philip lasted at any rate down to the eve of Chæronea.<sup>5</sup> Whether it survived that event is a doubtful point. The popular account of the orator's death ascribed it to the mental shock which he received from the news of Philip's victory. He was at Athens, in the palastra of Hippocrates, when the tidings came. He repeated three verses in which Euripides names three foreign conquerors of Greece—Danaus, Pelops, Cadmus—and four days later he died of

<sup>3</sup> *De Fals. Legat.*, § 265: οὐχ ὅπως ἀργύζοντο ἢ κολάζειν ἤξιον τοὺς ταῦτα ποιούντας, ἀλλ' ἀπέβλεπον, ἐξήταν, ἐτίμων, ἀνδρας ἡγούντο.

<sup>4</sup> ἐκεῖνος γὰρ ὁμολογεῖται . . . ἤδη ἐγκρατεῖς δοκοῦντας εἶναι τῶν πραγμάτων διὰ τὴν Κύρου προπέτειαν ἀτυχῆσαι, *Philippus* (*Or. v.*), § 90; cf. *Panegyricus*, § 149.

<sup>5</sup> *Philippus* (*Or. v.*), 346 B.C.; *Epist.* ii. end of 342 B.C. (1)

<sup>1</sup> Partim in pompa, partim in acie illustres.—*De Orat.* ii. § 94.

<sup>2</sup> Sannæz, *De Schola Isocratæ*, Halle, 1867.

Scholastic and literary life

School of Isocrates.

Political writing



voluntary starvation. Milton (perhaps thinking of Eli) seems to conceive the death of Isocrates as instantaneous—

As that dishonest victory  
At Chæroneæ, fatal to liberty,  
Killed with report that old man eloquent.

The  
third  
letter.

Now the third of the letters which bears the name of Isocrates is addressed to Philip, and appears to congratulate him on his victory at Chæroneæ, as being an event which will enable him to assume the leadership of Greece in a war against Persia. Is the letter genuine? There is no evidence, external or internal, against its authenticity, except its supposed inconsistency with the views of Isocrates and with the tradition of his suicide. As to his views, those who have studied them in his own writings will be disposed to question whether he would have regarded Philip's victory at Chæroneæ as an irreparable disaster for Greece. Undoubtedly he would have deplored the conflict between Philip and Athens; but he would have divided the blame between the combatants. And, with his old belief in Philip, he would probably have hoped, even after Chæroneæ, that the new position won by Philip would eventually prove compatible with the independence of the Greek cities, while it would certainly promote the project on which, as he was profoundly convinced, the ultimate welfare of Greece depended,—a Panhellenic expedition against Persia.

Tradi-  
tion of  
suicide.

As to the tradition of his suicide, the only rational mode of reconciling it with that letter is to suppose that Isocrates destroyed himself, not because Philip had conquered, but because, after that event, he saw Athens still resolved to resist. He might have felt that the moment was coming when duty to his native city would be in sharp conflict with his loyalty to one whom he regarded as the destined saviour of Greece; nor would he have been the only man who has deliberately preferred death to the agony of a divided allegiance. We should be rather disposed to ask how much weight is to be given to the tradition itself. The earliest authority for it—Dionysius of Halicarnassus in the age of Augustus—may have had older sources; granting, however, that these may have remounted even to the end of the 4th century B.C., that would not prove much. Ancient biography usually contained a large alloy of unsifted popular gossip; in particular it is strongly marked by a tendency to invent striking coincidences, or to adorn such as had actually occurred. Suppose that Isocrates—being then ninety-eight, and an invalid—had happened to die from natural causes a few days after the battle of Chæroneæ. Nothing could have originated more easily than a story that he killed himself from intense chagrin. Every one knew that Isocrates had believed in Philip; and most people would have thought that Chæroneæ was a crushing refutation of that belief. Once started, the legend would have been sure to live, not merely because it was picturesque, but also because it served to accentuate the contrast between the false prophet and the true,—between Isocrates and Demosthenes; and Demosthenes was very justly the national idol of the age which followed the loss of Greek independence.<sup>1</sup>

Isocrates is said to have taught his Athenian pupils gratuitously, and to have taken money only from aliens; but, as might have been expected, the fame of his school exposed him to attacks on the ground of his gains, which his enemies studiously exaggerated. After the financial reform of 378 B.C., he was one of those 1200 richest citizens who constituted the twenty unions (*συμμορίαι*) for the assessment of the war-tax (*είσφορά*). He had discharged several public services (*λειτουργίαι*); in particular, he had

<sup>1</sup> The views of several modern critics on the tradition of the suicide are brought together in the *Attic Orators*, ii. 32, note 2.

thrice served as trierarch. He married Plathane, the widow of the "sophist" Hippias of Elis, and then adopted her son Aphareus, afterwards eminent as a rhetorician and a tragic poet. In 355 B.C. he had his first and only lawsuit. A certain Megaclides challenged him to undertake the trierarchy, or exchange properties. This was the lawsuit which suggested the form of the discourse which he calls the *Antidosis* ("exchange of properties"—353 B.C.)—his defence of his professional life.

He was buried on a rising ground near the Cynosarges, —a temenos of Heracles, with a gymnasium, on the east side of Athens, outside the Diomeian gate. His tomb was surmounted by a column some 45 feet high, crowned with the figure of a siren, the symbol of persuasion and of death. A tablet of stone, near the column, represented a group of which Gorgias was the centre; his pupil Isocrates stood at his side. Aphareus erected a statue to his adopted father near the Olympieion. Timotheus, the illustrious son of Conon, dedicated another in the temple of Eleusis.

It was a wonderful century which the life of one man had thus all but spanned,—a century fuller than any other that could be named of great events both in the political and in the intellectual life of Greece. Isocrates had reached early manhood when the long struggle of the Peloponnesian War—began in his childhood—ended with the overthrow of Athens. The middle period of his career was passed under the supremacy of Sparta. His more advanced age saw that brief ascendancy which the genius of Epaminondas secured to Thebes. And he lived to urge on Philip of Macedon a greater enterprise than any which the Hellenic world could offer. His early promise had won a glowing tribute from Plato, and the rhetoric of his maturity furnished matter to the analysis of Aristotle; he had composed his imaginary picture of that Hellenic host which should move through Asia in a pageant of sacred triumph, just as Xenophon was publishing his plain narrative of the retreat of the Ten Thousand; and, in the next generation, his literary eloquence was still demonstrating the weakness of Persia when Demosthenes was striving to make men feel the deadly peril of Greece. This long life has an element of pathos not unlike that of Greek tragedy; a power above man was compelling events in a direction which Isocrates could not see; but his own agency was the ally of that power, though in a sense which he knew not; his vision was of Greece triumphant over Asia, while he was the unconscious prophet of an age in which Asia should be transformed by the diffusion of Hellenism.<sup>2</sup>

A just estimate of Isocrates demands that his character His should be viewed in both its main aspects,—the political political character.  
and the literary.

With regard to the first, two questions have to be asked:—(1) How far were the political views of Isocrates peculiar to himself, and different from those of the clearest minds contemporary with him? (2) How far were those views which he held—singly, or in common with others—falsified by the event?

1. In regard to Hellenic politics at large, Isocrates held that they must go from bad to worse, unless the wrangling and demoralized cities could be united by the spell of a national enthusiasm, under the leadership of one strong state or one strong man. This national enthusiasm would be, he believed, most certainly evoked by a war against the great Asiatic empire of Persia. Such an expedition might well abolish the miserable squabbles of state with state, if only a captain could be found.

<sup>2</sup> Isocrates, a loyal and genuine Hellenic, can yet conceive of Hellenic culture as shared by men not of Hellenic blood, *Panegyric*, § 50. He is thus, as Ernst Curtius has ably shown, a forerunner of Hellenism—analogue, in the literary province, to Epaminondas and Timotheus in the political (*History of Greece*, v. 116, 204, tr. Ward).

The whole tone of Greek thought in that age had taken a bent towards monarchy in some form. This tendency may be traced alike in the practical common sense of Xenophon and in the lofty idealism of Plato. There could be no better instance of it than a well-known passage in the *Politics* of Aristotle. He is speaking of the gifts which meet in the Greek race,—a race warlike, like the Europeans, but more subtle,—keen, like the Asiatics, but braver. Here, he says, is a race which "might rule all men, if it were brought under a single government."<sup>1</sup> It is unnecessary to suppose a special allusion to Alexander; but it is probable that Aristotle had in his mind a possible union of the Greek cities under a strong constitutional monarchy. His advice to Alexander (as reported by Plutarch) was to treat the Greeks in the spirit of a leader (*ἡγεμονικῶς*), and the barbarians in the spirit of a master (*δεσποτικῶς*).<sup>2</sup> Aristotle agreed, then, with Isocrates in holding that, if the Greek race was to have a great future, the first requisite was union under a central power. Aristotle conceived this power as political and permanent; Isocrates conceived it as, in the first place, military—having for its immediate aim the conduct of an expedition against Asia. Had Isocrates foreseen that such a command-in-chief was inseparable from a permanent monarchy, he would undoubtedly have accepted the latter; but he would have insisted, in the spirit of Aristotle's advice, on the constitutional liberty of the Greek subjects. The general views of Isocrates as to the largest good possible for the Greek race were thus substantially the same as those of Aristotle; and they were in accord with the prevailing tendency of the best Greek thought in that age.

2. How far were these views justified by the issue? The vision of the Greek race "brought under one polity" was not, indeed, fulfilled in the sense of Aristotle or of Isocrates. But the invasion of Asia by Alexander, as captain-general of Greece, became the event which actually opened new and larger destinies to the Greek race. The old political life of the Greek cities was worn out; in the new fields which were now opened, the empire of Greek civilization entered on a career of world-wide conquest, until Greece became to East and West more than all that Athens had been to Greece. Athens, Sparta, Thebes, ceased indeed to be the chief centres of Greek life; but the mission of the Greek mind could scarcely have been accomplished with such expansive and penetrating power if its influence had not radiated over the East from Pergamus, Antioch, and Alexandria.

Panhellenic politics had the foremost interest for Isocrates. But in two of his works—the oration *On the Peace* and the *Areopagiticus* (both of 355 B.C.)—he deals specially with the politics of Athens. The speech *On the Peace* relates chiefly to foreign affairs. It is an eloquent appeal to his fellow-citizens to abandon the dream of supremacy, and to treat their allies as equals, not as subjects. The fervid orator personifies that empire, that false mistress which has lured Athens, then Sparta, then Athens once more, to the verge of destruction. "Is she not worthy of detestation?" Leadership passes into empire; empire begets insolence; insolence brings ruin. The *Areopagiticus* breathes a kindred spirit in regard to home policy. Athenian life had lost its old tone. Apathy to public interests, dissolute frivolity, tawdry display and real poverty—these are the features on which Isocrates dwells. With this picture he contrasts the elder democracy of Solon and Clisthenes, and, as a first step towards reform, would restore to the Areopagus its general censor-

ship of morals. It is here, and here alone—in his comments on Athenian affairs at home and abroad—that we can distinctly recognize the man to whom the Athens of Pericles was something more than a tradition. We are carried back to the age in which his long life began. We find it difficult to realize that the voice to which we listen is the same which we hear in the letter to Philip.

Turning from the political to the literary aspect of his work, we are at once upon ground where the question of his merits will now provoke comparatively little controversy. Perhaps the most serious prejudice with which his reputation has had to contend in modern times has been due to an accident of verbal usage. He repeatedly describes that art which he professed to teach as his *φιλοσοφία*. His use of this word—joined to the fact that in a few passages he appears to allude slightly to Plato or to the Socratics—has exposed him to a groundless imputation. It cannot be too distinctly understood that, when Isocrates speaks of his *φιλοσοφία*, he means simply his theory or method of "culture"—to use the only modern term which is really equivalent in latitude to the Greek word as then current.<sup>3</sup>

The *φιλοσοφία*, or practical culture, of Isocrates was not in conflict, because it had nothing in common, with the Socratic or Platonic philosophy. The personal influence of Socrates may, indeed, be traced in his work. He constantly desires to make his teaching bear on the practical life. His maxims of homely moral wisdom frequently recall Xenophon's *Memorabilia*. But there the relation ends. Plato alludes to Isocrates in perhaps three places. The glowing prophecy in the *Phaedrus* has been quoted; in the *Gorgias* a phrase of Isocrates is wittily parodied; and in the *Euthydemus* Isocrates is probably meant by the person who dwells "on the borderland between philosophy and statesmanship."<sup>4</sup> The writings of Isocrates contain a few more or less distinct allusions to Plato's doctrines or works, to the general effect that they are barren of practical result.<sup>5</sup> But Isocrates nowhere assails Plato's philosophy as such. When he declares "knowledge" (*ἐπιστήμη*) to be unattainable, he means an exact "knowledge" of the contingencies which may arise in practical life. "Since it is impossible for human nature to acquire any science (*ἐπιστήμην*) by which we should know what to do or to say, in the next resort I deem those wise who, as a rule, can hit what is best by their opinions" (*δόξας*).<sup>6</sup>

Isocrates should be compared with the practical teachers of his day. In his essay *Against the Sophists*, and in his speech on the *Antidosis*, which belong respectively to the beginning and the close of his professional career, he has clearly marked the points which distinguish him from "the sophists of the herd" (*ἀγελαῖοι σοφισταί*). First, then, he claims, and justly, greater breadth of view. The ordinary teacher confined himself to the narrow scope of local interests,—training the young citizen to plead in the Athenian law courts, or to speak on Athenian affairs in the ecclesia. Isocrates sought to enlarge the mental horizon of his disciples by accustoming them to deal with subjects which were not merely Athenian, but, in his own phrase, Hellenic. Secondly, though he did not claim to have found a philosophical basis for morals, it has been well

<sup>3</sup> The word *φιλοσοφία* seems to have come into Athenian use not much before the time of Socrates; and, till long after the time of Isocrates, it was commonly used, not in the sense of "philosophy," but in that of "literary taste and study—culture generally." *Aristid.*, ii. 407, *φιλοκαλία τις καὶ διατριβὴ περὶ λόγου, καὶ οὐχ ὁ νῦν τρόπος οὗτος, ἀλλὰ παιδεία κοινῶς*. And so writers of the 4th century B.C. use *φιλοσοφεῖν* as simply "to study"; as, e.g., an invalid "studies" the means of relief from pain, *Lys.*, *Or.* xxiv. § 10; *cf.* *Isocr.*, *Or.* iv. § 6, &c.

<sup>4</sup> *Plat.*, *Gorg.*, p. 463; *Euthyd.*, 304-6.

<sup>5</sup> These allusions are discussed in the *Attic Orators*, vol. ii. pp. 51 f.

<sup>6</sup> *Isocr.*, *Or.* xv. § 271.

<sup>1</sup> τὸ τῶν Ἑλλήνων γένος . . . δυναμένον ἀρχεῖν πάντων, μίαν νυχθάνον πολιτείαν, *Polit.*, iv. [vii.] 7.

<sup>2</sup> *De Alex. Viri.*, i, vi.



said of him that "he reflects the human spirit always on its nobler side,"<sup>1</sup> and that, in an age of corrupt and impudent selfishness, he always strove to raise the minds of his hearers into a higher and purer air. Thirdly, his method of teaching was thorough. Technical exposition came first. The learner was then required to apply the rules in actual composition, which the master revised. The ordinary teachers of rhetoric (as Aristotle says) employed their pupils in committing model pieces to memory, but neglected to train the learner's own faculty through his own efforts. Lastly, Isocrates stands apart from most writers of that day in his steady effort to produce results of permanent value. While rhetorical skill was largely engaged in the intermittent journalism of political pamphlets, Isocrates set a higher ambition before his school. His own essays on contemporary questions received that finished form which has preserved them to this day. The impulse to solid and lasting work, communicated by the example of the master, was seen in such monuments as the *Atthis* of Androtion, the *Hellenic History* of Theopompus, and the *Philippica* of Ephorus.

Style

In one of his letters to Atticus, Cicero says that he has used "all the fragrant essences of Isocrates, and all the little stores of his disciples."<sup>2</sup> The phrase has a point of which the writer himself was perhaps scarcely conscious: the style of Isocrates had come to Cicero through the school of Rhodes; and the Rhodian imitators had more of Asiatic splendour than of Attic elegance. But, with this allowance made, the passage may serve to indicate the real place of Isocrates in the history of literary style. The old Greek critics consider him as representing what they call the "smooth" or "florid" mode of composition (*γλαφυρά, ἀσθηρὰ ἀρμονία*) as distinguished from the "harsh" (*αἰσθηρὰ*) style of Antiphon and the perfect "mean" (*μέσση*) of Demosthenes. Tried by a modern standard, the language of Isocrates is certainly not "florid." The only sense in which he merits the epithet is that (especially in his earlier work) he delights in elaborate antitheses. Isocrates is an "orator" in the larger sense of the Greek word *rhetor*; but his real distinction consists in the fact that he was the first Greek who gave an artistic finish to literary rhetoric. The practical oratory of the day had already two clearly separated branches—the forensic, represented by Iseus, and the deliberative, in which Callistratus was the forerunner of Demosthenes. Meanwhile Isocrates was giving form and rhythm to a standard literary prose. Through the influence of his school, this normal prose style was transmitted—with the addition of some florid embellishments—to the first generation of Romans who studied rhetoric in the Greek schools. The distinctive feature in the composition of Isocrates is his structure of the periodic sentence. This, with him, is no longer rigid or monotonous, as with Antiphon,—no longer terse and compact, as with Lysias,—but ample, luxuriant, unfolding itself (to use a Greek critic's image) like the soft beauties of a winding river. Isocrates was the first Greek who worked out the idea of a prose rhythm. He saw clearly both its powers and its limits; poetry has its strict rhythms and precise metres; prose has its metres and rhythms, not bound by a rigid framework, yet capable of being brought under certain general laws which a good ear can recognize, and which a speaker or writer may apply in the most various combinations. This fundamental idea of prose rhythm, or number, is that which the style of Isocrates has imparted to the style of Cicero. When Quintilian (x. 1, 108) says, somewhat hyperbolically, that Cicero has artistically reproduced (*effinxisse*) "the force of

Demosthenes, the wealth of Plato, the charm of Isocrates,"<sup>3</sup> he means principally this smooth and harmonious rhythm. Cicero himself expressly recognizes this original and distinctive merit of Isocrates.<sup>3</sup> Thus, through Rome, and especially through Cicero, the influence of Isocrates, as the founder of a literary prose, has passed into the literatures of modern Europe. It is to the eloquence of the preacher that we may perhaps look for the nearest modern analogue of that kind in which Isocrates excelled,—especially, perhaps, to that of the great French preachers. Isocrates was one of the three Greek authors, Demosthenes and Plato being the others, who contributed most to form the style of Bossuet.

The extant works of Isocrates consist of twenty-one speeches or Works, discourses, and nine letters. Among these, the six forensic speeches represent the first period of his literary life,—belonging to the years 403–393 B.C. All six concern private causes. They may be classed as follows. 1. *Action for Assault* (*δίκη αἰκίας*), Or. xx., "Against Lochites," 394 B.C. 2. *Claim to an Inheritance* (*ἐπιδικασία*), Or. xix., *Ægineticus*, end of 394 or early in 393 B.C. 3. *Actions to Recover a Deposit* :—(1) Or. xxi., "Against Euthynus," 403 B.C.; (2) Or. xvii., *Tropeziticus*, end of 394 or early in 393 B.C. 4. *Action for Damage* (*δίκη βλάβης*), Or. xvi., "Concerning the Team of Horses," 397 B.C. 5. *Special Plea* (*παράγραφη*), Or. xviii., "Against Callimachus," 402 B.C. Two of these have been regarded as spurious by G. E. Benseler, viz., Or. xxi., on account of the frequent hiatus and the short compact periods, and Or. xvii., on the first of these grounds. But we are not warranted in applying to the early work of Isocrates these canons which his mature style observed. The genuineness of the speech against Euthynus is recognized by Philostratus; while the *Tropeziticus*—thrice named without suspicion by Harpocration—is treated by Dionysius, not only as authentic, but as the typical forensic work of its author. The speech against Lochites—where "a man of the people" (*τοῦ πλάθους εἶς*) is the speaker—exhibits much rhetorical skill. The speech *περὶ τοῦ ζεύγους* ("concerning the team of horses") has a curious interest. An Athenian citizen had complained that Alcibiades had robbed him of a team of four horses, and sues the statesman's son and namesake (who is the speaker) for their value. This is not the only place in which Isocrates has marked his admiration for the genius of Alcibiades; it appears also in the *Philippus* and in the *Busiris*. But, among the forensic speeches, we must, on the whole, give the palm to the *Ægineticus*—a graphic picture of ordinary Greek life in the islands of the Ægean. Here—especially in the narrative—Isocrates makes a near approach to the best manner of Lysias.

The remaining fifteen orations or discourses do not easily lend themselves to the ordinary classification under the heads of "deliberative" and "epideictic." Both terms must be strained; and neither is strictly applicable to all the pieces which it is required to cover. The work of Isocrates travelled out of the grooves in which the rhetorical industry of the age had hitherto moved. His position among contemporary writers was determined by ideas peculiar to himself; and his compositions, besides having a style of their own, are in several instances of a new kind. The only adequate principle of classification is one which considers them in respect to their subject-matter. Thus viewed, they form two clearly separated groups—the scholastic and the political.

*Scholastic Writings.*—Under this head we have, first, three Scholastic letters or essays of a hortatory character. (1) The letter to the young Demonicus,—once a favourite subject in the schools,—contains a series of precepts neither below nor much above the average practical morality of Greece. (2) The letter to Nicocles—the young king of the Cyprian Salamis—sets forth the duty of a monarch to his subjects. (3) In the third piece, it is Nicocles who speaks, and impresses on the Salaminites their duty to their king—a piece remarkable as containing a popular plea for monarchy, composed by a citizen of Athens. These three letters may be referred to the years 374–372 B.C.

Next may be placed four pieces which are "displays" (*ἐπιδείξεις*) in the proper Greek sense. The *Busiris* (Or. xi., 390–91 B.C.) is an attempt to show how the ill-famed king of Egypt might be praised. The "Encomium on Helen" (Or. x., 370 B.C.), a piece greatly superior to the last, contains the celebrated passage on the power of beauty. These two compositions serve to illustrate their author's view that "encomia" of the hackneyed type might be elevated by combining the mythical matter with some topic of practical interest,—as, in the case of *Busiris*, with the institutions of Egypt, or, in that of Helen, with the reforms of Theseus. The *Evagoras* (Or. ix., 365 B.C. ?) is a laudatory epitaph on a really able man,—the Greek king of the Cyprian Salamis. A passage of

<sup>1</sup> Cartelier, *Le Discours d'Isocrate sur lui-même*, p. lxii.

<sup>2</sup> Totum Isocratis *μυροθήκιον* atque omnes ejus discipulorum *ecceles*, *Ad Att.*, ii. 1.

<sup>3</sup> Idque princeps Isocrates instituisse fertur, . . . ut inconditam antiquorum dicendi rationem . . . summis astringeret, *De Or.*, iii. 44, 173.

singular interest describes how, under his rule, the influences of Hellenic civilization had prevailed over the surrounding barbarism. The *Panathenaicus* (Or. xii.), intended for the great Panathenea of 342 B.C., but not completed till 339 B.C., contains a recital of the services rendered by Athens to Greece, but digresses into personal defence against critics; his last work, written in extreme old age, it bears the plainest marks of failing powers.

The third subdivision of the scholastic writings is formed by two most interesting essays on education—that entitled "Against the Sophists" (Or. xiii., 391-90 B.C.), and the "Antidosis" (Or. xv., 335 B.C.). The first of these is a manifesto put forth by Isocrates at the outset of his professional career of teaching, in which he seeks to distinguish his aims from those of other "sophists." These "sophists" are (1) the "eristics" (*οἱ περὶ τὰς ἐρίδας*), by whom he seems to intend the minor Socrates, especially Euclides; (2) the teachers of practical rhetoric, who had made exaggerated claims for the efficacy of mere instruction, independently of natural faculty or experience; (3) the writers of "arts" of rhetoric, who virtually devoted themselves (as Aristotle also complains) to the lowest, or forensic, branch of their subject. As this piece is the prelude to his career, its epilogue is the speech on the "Antidosis,"—so called because it has the form of a speech made in court in answer to a challenge to undertake the burden of the trierarchy, or else exchange properties with the challenger. The discourse "Against the Sophists" had stated what his art was *not*; this speech defines what it *is*. His own account of his φιλοσοφία—"the discipline of discourse" (*ἡ τῶν λόγων παιδεία*)—has been embodied in the sketch of it given above.

**Political.** *Political Writings.*—These, again, fall into two classes—those which concern (1) the relations of Greece with Persia, (2) the internal affairs of Greece. The first class consist of the *Panegyricus* (Or. iv., 380 B.C.) and the *Philippus* (Or. v., 346 B.C.). The *Panegyricus* takes its name from the fact that it was given to the Greek public at the time of the Olympic festivals—probably by means of copies circulated there. The orator urges that Athens and Sparta should unite in leading the Greeks against Persia. The feeling of antiquity that this noble discourse is a masterpiece of careful work finds expression in the tradition that it had occupied its author for more than ten years. Its excellence is not merely that of language, but also—and perhaps even more conspicuously—that of lucid arrangement. The *Philippus* is an appeal to the king of Macedonia to assume that initiative in the war on Persia which Isocrates had ceased to expect from any Greek city. In the view of Demosthenes, Philip was the representative barbarian; in that of Isocrates, he is the first of Hellenes, and the natural champion of their cause.

Of those discourses which concern the internal affairs of Greece, two have already been noticed,—that *On the Peace* (Or. viii.), and the *Acropagiticus* (Or. vi.)—both of 355 B.C.—as dealing respectively with the foreign and the home affairs of Athens. The *Plataicus* (Or. xiv.) is supposed to be spoken by a Plataan before the Athenian ecclesia in 373 B.C. In that year Plataea had for the second time in its history been destroyed by Thebes. The oration—in appeal to Athens to restore the unhappy town—is remarkable both for the power with which Theban cruelty is denounced, and for the genuine pathos of the peroration. The *Archidamnus* (Or. vi.) is a speech purporting to be delivered by Archidamnus III., son of Agesilaus, in a debate at Sparta on conditions of peace offered by Thebes in 366 B.C. It was demanded that Sparta should recognize the independence of Messene, which had lately been restored by Epanimondas (370 B.C.). The oration gives brilliant expression to the feeling which such a demand was calculated to excite in Spartans who knew the history of their own city. Xenophon witnesses that the attitude of Sparta on this occasion was actually such as the *Archidamnus* assumes (*Hellen.*, viii. 4, §§ 8-11).

**Letters.** *Letters.*—The first letter,—to Dionysius I.—is fragmentary; but a passage in the *Philippus* leaves no doubt as to its object. Isocrates was anxious that the ruler of Syracuse should undertake the command of Greece against Persia. The date is probably 368 B.C. Next in chronological order stands the letter "To the Children of Jason" (vi.). Jason, tyrant of Pheræ, had been assassinated in 370 B.C.; and no less than three of his successors had shared the same fate. Isocrates now urges Thebe, the daughter of Jason, and her half-brothers, to set up a popular government. The date is 359 B.C.<sup>1</sup> The letter to Archidamnus III. (ix.)—the same person who is the imaginary speaker of oration vi.—urges him to execute the writer's favourite idea,—“to deliver the Greeks from their feuds, and to crush barbarian insolence.” It is remarkable for a vivid picture of the state of Greece; the date is about 356 B.C. The letter to Timotheus (vii., 345 B.C.), ruler of Heraclea on the Euxine, introduces an Athenian friend who is coming thither, and at the same time offers some good counsels to

the benevolent despot. The letter "to the government of Mytilene" (viii., 350 B.C.) is a petition to a newly established oligarchy, begging them to permit the return of a democratic exile, a distinguished musician named Agenor. The first of the two letters to Philip of Macedonia (ii.) remonstrates with him on the personal danger to which he had recklessly exposed himself, and alludes to his beneficent intervention in the affairs of Thessaly; the date is probably the end of 342 B.C. The letter to Alexander (v.), then a boy of fourteen, is a brief greeting sent along with the last, and congratulates him on preferring "practical" to "eristic" studies—a distinction which is explained by the sketch of the author's φιλοσοφία, and of his essay "Against the Sophists," given above. It was just at this time, probably, that Alexander was beginning to receive the lessons of Aristotle (342 B.C.). The letter to Antipater (iv.) introduces a friend who wished to enter the military service of Philip. Antipater was then acting as regent in Macedonia during Philip's absence in Thrace (340-339 B.C.). The letter of the two letters to Philip (iii.) appears to be written shortly after the battle of Charonea in 338 B.C. The questions raised by it have already been discussed.

No lost work of Isocrates is known from a definite quotation, except an "Art of Rhetoric," from which some scattered precepts are cited. Quintilian, indeed, and Photius, who had seen this "Art," felt a doubt as to whether it was genuine. Only twenty-five discourses—out of an ascriptive total of some sixty—were admitted as authentic by Dionysius; Photius (*circ.* 850 A.D.) knew only the number now extant—twenty-one.

With the exception of defects at the end of Or. xiii., at the beginning of Or. xvi., and probably at the end of letters i., vi., ix., the existing text is free from serious mutilations. It is also unusually pure. The smooth and clear style of Isocrates gave few opportunities for the mistakes of copyists. On the other hand, he was a favourite author of the schools. Numerous glosses crept into his text through the comments or conjectures of rhetoricians. This was already the case before the 6th century, as is attested by the citations of Priscian and Stobæus. Jerome Wolf and Koraes successively accomplished much for the text. But a more decided advance was made by Immanuel Bekker. He used five MSS., viz., (1) Codex Urbinus 111., Γ scripta; (2) Laurentianus 87, 14, Θ (13th century); (3) Vaticanus 936, Δ; (4) Marcianus 415, E. The first three, of the same family, have Or. xv. entire; the last two are from the same original, and have Or. xv. incomplete.

Baiter and Sauppe (Zurich, 1850) follow Γ "even more constantly than Bekker." Their apparatus is enriched, however, by a MS. to which he had not access,—Ambrosianus O. 144, E, which in some cases, as they recognize, has alone preserved the true reading. The readings of this MS. were given in full by G. E. Benseler in his second edition (1854-55). The distinctive characteristic of Benseler's textual criticism was a tendency to correct the text against even the best MS., where the MS. conflicted with the usage of Isocrates as inferred from his recorded precepts or from the statements of ancient writers. Thus, on the strength of the rule ascribed to Isocrates,—*φωνήεντα μὴ συνάπτειν*,—Benseler would remove from the text every example of hiatus. Benseler's edition has been revised by F. Blass (1878-79), who amends a large number of his readings, but usually follows him in details of form and spelling.

*Recent Editions.*—In *Oratores Attici*, ed. Imm. Bekker, 1823 and 1828; ed. G. S. Dobson, 1828; ed. J. G. Baiter and Hermann Sauppe, 1850. Separately in Teubner's series, by G. E. Benseler, 2d ed. 1854-55; revised by F. Blass, 1878-79. *Ad Demonicum et Panegyricum*, ed. J. E. Sandys, 1868. Extracts from Orations iii., iv., vi., vii., viii., ix., xiii., xiv., xv., xix., and Letters iii., v., edited with revised text and commentary, in *Selections from the Attic Orators*, by the present writer (1830). (R. C. J.)

**ISOMERISM.** See CHEMISTRY, vol. v. p. 550.

**ISOTHERMS.** See METEOROLOGY.

**ISPAHÂN, or ISFAHÂN,** a city of Persia, in the province of Irak Adjemi, is situated in 32° 39' N. lat. and 51° 44' E. long. It enjoys the reputation of a very salubrious climate, except in the autumn, when fevers are prevalent. The following statistics are given by modern authorities; but the condition of the city and its environs is subject to constant change. The city walls—a mere mud curtain ruined in many places—are about 5 miles in circumference. There are some 300 villages, more or less flourishing, in the neighbourhood. In the interior of the city there are reckoned to be sixty mosques (of which about forty are in use), from eighty to a hundred baths, perhaps fifty colleges (which seems, however, far beyond the wants of the population), and twenty caravanserais in a more or less perfect state.

<sup>1</sup> This is shown by the present writer in a paper on "The Sixth Letter of Isocrates," *Journal of Philology*, vol. v. p. 266, 1874. The fact that Thebe, widow of Alexander of Pheræ, was the daughter of Jason, is incidentally noticed by Plutarch in his life of Pelopidas, c. 23. It is this fact which gives the clue to the occasion of the letter; cf. *Diod.* xvi. 14.



The public buildings of Ispahán (the best specimens of modern Oriental design and decoration to be found in Persia, or perhaps anywhere in the East) are of two distinct classes—those constructed by Shah Abbas and his successors, and those erected during the present Kajar dynasty. The two great palaces of Shah Abbas the Great are named respectively Chihil-Sutún (“the forty pillars”) and Hasht Bihisht (“the eight paradises”). They are surrounded by extensive gardens, traversed by avenues of planes and poplars, and intersected by paved canals of running water, with fountains and reservoirs sparkling in all directions, the whole area being encompassed by a mud wall which is nearly 3 miles in circumference. The buildings themselves are ornamented with gilding and mirrors in every possible variety of arabesque decoration; and large and brilliant pictures of the usual Persian type, representing scenes of Persian history, cover the walls of all the principal apartments and have been ascribed in many instances to Italian and Dutch artists, who are known to have been in the service of Shah Abbas. Attached to these palaces are separate buildings, such as the Amáret-i-Now (or “new edifice”), the Tálári-Tavleh (or “hall of the stables”), the Gul-dastab (“bunch of roses”), and several others, which have been erected in modern times by wealthy courtiers for the convenience of the sovereign, and which are also generally occupied as residences by the European ministers, and by other distinguished travellers who are provided with royal accommodation on their way to the capital. Perhaps the most agreeable residence of all is the Haft Dast (“seven courts”) in the beautiful garden of Sa’adetábád, on the southern bank of the river, and 2 or 3 miles from the heart of the city. This palace was built by Shah Tahmasp, the successor of Shah Abbas, and until lately was kept in good repair and used as a villa residence by the prince governor. Sir Gore Ouseley resided there with his suite for some months on his deputation to Persia in 1811. The garden of the Chihil-Sutún palace, where Sir Harford Jones’s mission was established in 1809, opens out through the Ali-Kápi (or “Sublime Porte”) into the great square or Mydán-i-Shah, the most remarkable feature in the city, and probably the largest square in the world, being 2000 feet in length by 700 in breadth. This square is surrounded by a double row of arcades, and formerly resembled a permanent fair; now, however, it is painfully desolate. The corners of the square face the cardinal points, and in the centre of each face is some remarkable building. On the north-west is the Ali-Kápi, forming the entrance to the royal palace. It is three stories high, and from the summit is obtained a splendid view of Ispahán and the environs. Opposite to the Ali-Kápi on the south-east side of the square is the famous Mesjid-i-Shah, or “royal mosque,” covered with glazed tiles of unusual brilliancy, and richly decorated with gold and silver ornaments, being by far the handsomest mosque in all Persia; but, as Europeans are not admitted to the interior, it has never been well described. In the centre of the north-east face of the square is the gate entrance to the great bazaar usually called the Kaiserieh, while immediately over the gate, where in Chardin’s time the great Dutch clock with its automatic figures used to excite the admiration of the Ispahánis, the Nokhára-Khána, or “trumpet house,” now blares forth its dissonant roar at sunrise and sunset, and on the remaining or south-west side is another sacred building, the mosque of Lutf Ollah, which is only inferior in grandeur and beauty to the Mesjid-i-Shah.

Among the other notable buildings of Ispahán must be reckoned its colleges and bridges. The Zindeh-rúd or “river of life” rises in Zardehkoh, about 90 miles to the west of Ispahán, where some stupendous tunnelling works are yet to be seen, the traces of Shah Abbas’s abortive

attempt to turn the Karún or Shuster stream into the eastern river bed. It flows in a well-cultivated valley through the districts of Chár-mebel and Liuján to the town of Ispahán, passing along the southern outskirts of the city from west to east, and being crossed by three principal bridges. The first, the Púl-i-Chár-bágh, or, as it is also called, the Púl-i-Julfa, connecting the suburb of Julfa to the south with the stately Chár-bágh avenue to the north, consists of a double row of 34 arches, with covered galleries on both sides, and with a roadway, battlemented and paved throughout. It was built by Ali Verdi Khán, one of Shah Abbas’s principal officers. The second bridge, the Púl-i-Khajú, is on the high road to the south, and is thus much frequented. It is also built with great solidity on a double row of arches, and is kept in excellent repair. The third bridge is smaller and less used. It is named Púl-i-Sheheristán, from a village of that name to which it leads, forming the north-eastern suburb of the city. The river flows on some 30 miles further to the west, and is there lost in the sand.

Of the colleges of Ispahán, which are said to be fifty in number, and the greater part of which are still used as educational establishments for the Mahometan priesthood, the most remarkable building is the Medresseh Shah Sultán Hussain, on the right of the avenue leading northwards from the Púl-i-Khajú. It is thus described by Mr Morier:—

“Its entrance is handsome. A lofty portico, enriched with fantastically twisted pillars, and intermixed with the beautiful marble of Tabriz, leads through a pair of brazen gates, finished with silver, and their whole surface highly carved and embossed with flowers and verses from the Koran. The gates lead to an elevated semi-dome, which opens at once into the square of the college. The right side of this court is occupied by the mosque, which is still a beautiful building, covered with a cupola and faced with two minarets. The interior of the dome is richly spread with variegated tiles, on which are invocations to the prophet and verses of the Koran in the fullest profusion. The other sides of the square are occupied, one by a lofty and beautiful portico, and the remaining two by rooms for the students, twelve in each front, arranged in two stories. These apartments are little square cells, and seem admirably calculated for study.”

Another striking feature of Ispahán is the line of covered bazaars, commencing with the Hassanábád and ending with the Kaiserieh, which extends for nearly 3 miles, and divides the city from south to north. The confluence of people in these bazaars is certainly very great, and gives an exaggerated idea of the populousness of the city, the truth being that while the inhabitants congregate for business in these streets, the rest of the city is comparatively deserted (see Morier’s lively description).

But although Ispahán thus abounds with traces of former grandeur and magnificence, although even now, when surveyed from a commanding height within the city, or in the immediate environs, the enormous extent of mingled garden and building, at least 30 miles in circumference, gives an impression of populousness and busy life, a closer scrutiny reveals that the whole scene is nothing more than a gigantic sham. With the exception of the bazaars and a few scattered hamlets, there is really no continuous inhabited area. Whole streets, whole quarters of the city have fallen into utter ruin, and are absolutely deserted, the traveller who is bent on visiting some of the remarkable sites in the north-western or north-eastern suburbs, such as the ruins of the old fire temple, the remains of the famous castle of Tabarrak, or the shaking minarets of Guladán, having to pass through miles of crumbling mud walls and roofless houses. It is believed indeed that not a twentieth part of the area of the old city is at present peopled, and that the million of inhabitants, reported in the time of Chardin, have now dwindled to about 40,000 souls.

The Armenian suburb of Julfa, at any rate, which contained a population of 30,000 souls in the 17th century,

is now tenanted by some 300 wretched families, and the Christian churches, which used to number thirteen, and were many of them maintained in great splendour, are now reduced to half a dozen edifices with bare walls and empty benches. At the same time it must be noted that some improvement has recently taken place in the education of the young, and also in their religious teaching, the wealthy Armenians of India having contributed liberally to the national schools, and a Scottish gentleman, Mr Bruce, having been engaged for some years in missionary labours among the ignorant Christian peasantry of Julfa and Feridán.

The commerce of Ispahán has also greatly fallen off from its former flourishing condition. The manufactures, it is true, for which the city has been long famous, are still to a certain extent carried on; in the bazaars are yet to be found the brocades, satins, and silks of former days, together with calicoes, chintzes, and other cotton goods; the *duld's* still hawk about the lacquered boxes, pen-cases, mirror-frames, and book-covers, beautifully painted and ornamented, which are peculiar to Ispahán, while sword-blades, damascened gunbarrels, glass, and earthenware continue here and there to be exhibited in the stalls for sale; but the imports, both from India and from the north, have greatly diminished, and this has crippled the demand for native produce. Whether the trade of former days can ever be restored is doubtful. British mercantile houses, established at Bushire, are making great efforts to push on their operations to the northward. Various schemes have been discussed for opening direct communication with the Persian Gulf, either by railway through Shiráz to Bushire, or across the mountains to Shuster on the Karún, and thence by river steamer to Mohamreh. If the Persian Government can be induced to throw open the navigation of the Karún to British enterprise, it is probable that an attempt will really be made to connect Shuster and Ispahán by rail, notwithstanding the formidable engineering difficulties to be encountered in crossing the Bakhtiáree mountains; and in that case, as the Indian trade from the south would compete both with the Russian and British trade from the north, in supplying eastern Persia, Ispahán might be expected to derive great benefit from the competition. The position indeed is so favoured by nature and is so conveniently situated in the very focus of the British Indian lines of traffic that in due course of time some improvement may be confidently looked for.

The Ispahánis have a very poor reputation in Persia either for courage or morals. They are regarded as a clever, but at the same time a dissolute and disorderly community, whose government requires a strong hand and unyielding temper. The *looties* indeed of Ispahán are proverbial as the most "rowdy" set of vagabonds in Persia. There is also a good deal of religious fanaticism and party spirit among the lower classes, the city being divided into two factions of Na'amat Ulláhi and Hyderi (so called from two famous saints of former days), who reside in the rival quarters of Jubáreh and Deridasht, and are continually coming into collision. The priesthood on the other hand are much respected for their learning and high character, and the decisions of the chief "mujtehid" of Ispahán are considered of more authority even than those of the sheikh-el-Islám at the capital. The merchants also of Ispahán are a very respectable class, occupied in extensive dealings with India, with Baghdad, and with Constantinople, and rarely, if ever, failing in their engagements. Altogether Ispahán is one of the most interesting cities in the East, exhibiting a genuine picture of active Oriental life.

The natural advantages of Ispahán—a genial climate, a fertile soil, and abundance of water for irrigation—must have always made it a place of importance. In the most ancient cuneiform docu-

ments, referring to a period between 3000 and 2000 B.C., the province of Ansan, which certainly included Ispahán, was the limit of the geographical knowledge of the Babylonians, typifying the extreme east, as Syria (or *Martu-ki*) typified the west. The two provinces of Ansan and Subarta, by which we must understand the country from Ispahán to Shuster, were ruled in those remote ages by the same king, who undoubtedly belonged to the great Turanian family; and from this first notice of Ansan down to the 7th century B.C. the region seems to have remained, more or less, dependent on the paramount power of Susa. With regard to the eastern frontier of Ansan, however, ethnic changes were probably in extensive operation during this interval of twenty centuries. The western Iranians, for instance, after separating from their eastern brethren on the Oxus, as early perhaps as 3000 B.C., must have followed the line of the Elburz mountains, and then bifurcating into two branches must have scattered, westward into Media and southward towards Persia. The first substantial settlement of the southern branch would seem then to have been at Ispahán, where *Jem*, the eponym of the Persian race, is said to have founded a famous castle, the remains of which were visible as late as the 10th century A.D. This castle is known in the Zoroastrian writings as *Jem-gird*, but its proper name was *Sarú* or *Sarúik* (given in the Bundahish as *Sruwa* or *Srobak*), and it was especially famous in early Mahometan history as the building where the ancient records and tables of the Persians were discovered which proved of so much use to *Abú-Másher* (Albumazar) and his contemporaries. A valuable tradition, proceeding from quite a different source, has also been preserved to the effect that *Jem*, who invented the original Persian character, "dwelt in Assan, a district of Shuster" (see Flügel's *Führer*, p. 12, l. 21), which exactly accords with the Assyrian notices of Assan or Ansan classed as a dependency of Elymais. Now it is well known that native legend represented the Persian race to have been held in bondage for a thousand years, after the reign of *Jem*, by the foreign usurper *Zohák* or *Biverasp*, a period which may well represent the duration of Elymean supremacy over the Aryans of Ansan. At the commencement of the 7th century B.C. Persia and Ansan are still found in the annals of Sennacherib amongst the tributaries of Elymais, confederated against Assyria; but shortly afterwards the great Susian monarchy, which had lasted for full 2000 years, crumbled away under continued pressure from the west, and the Aryans of Ansan recovered their independence, founding for the first time a national dynasty, and establishing their seat of government at Gabæ on the site of the modern city of Ispahán.

The royal city of Gabæ was known as a foundation of the Achaemenidae as late as the time of Strabo, and the inscriptions show that Achemenes and his successors did actually rule at Ansan until the great Cyrus set out on his career of western victory. Whether the *Kábi* or *Kávi* of tradition, the blacksmith of Ispahán, who is said to have headed the revolt against *Zohák*, took his name from the town of Gabæ may be open to question; but it is at any rate remarkable that the national standard of the Persian race, named after the blacksmith, and supposed to have been first unfurled at this epoch, retained the title of *Darafsh-a Káváni* (the banner of *Kávi*) to the time of the Arab conquest, and that the men of Ispahán were, moreover, throughout this long period, always especially charged with its protection. The provincial name of Ansan or Assan seems to have been disused in the country after the age of Cyrus, and to have been replaced by that of Gabene or Gabiane, which alone appears in the Greek accounts of the wars of Alexander and his successors, and in the geographical descriptions of Strabo. Gabæ or Gávi became gradually corrupted to *Jai* during the Sassanian period, and it was thus by the latter name that the old city of Ispahán was generally known at the time of the Arab invasion. Subsequently the title of *Jai* became replaced by *Sheheristán* or *Medineh*, "the city" *par excellence*, while a suburb which had been founded in the immediate vicinity, and which took the name of *Yahudieh*, or the "Jews' town," from its original Jewish inhabitants, gradually rose into notice and superseded the old capital.<sup>1</sup>

*Sheheristán* and *Yahudieh* are thus in the early ages of Islam described as independent cities, the former being the eastern and the latter the western division of the capital, each surrounded by a separate wall; but about the middle of the 10th century the famous Boide king known as the *Rukn-ed-Dowleh* united the two suburbs and many of the adjoining villages in one general enclosure which

<sup>1</sup> The name of *Yahudieh* or "Jews' town" is derived by the early Arab geographers from a colony of Jews who are said to have migrated from Babylonia to Ispahán shortly after Nebuchadnezzar's conquest of Jerusalem, but this is pure fable. The Jewish settlement really dates from the 3d century A.D., as is shown by a notice in the Armenian history of Moses of Chorene, lib. iii. cap. 35. The name *Ispahán* has been generally compared with the *Aspadana* of Ptolemy in the extreme north of Persia, and the identification is probably correct. At any rate the title is of great antiquity, being found in the Bundahish, and being derived in all likelihood from the family name of the race of *Feridán*, the *Atiriyán* of romance, who were entitled *Aspiyán* in Pehlevi, according to the phonetic rules of that language.



was about 10 miles in circumference. The city, which had now resumed its old name of Ispahan, continued to flourish till the time of Timur (1387 A. D.), when in common with so many other cities of the empire it suffered grievously at the hands of the Tartar invaders. Timur indeed is said to have erected a *Kelleh Mindar* or "skull tower" of 70,000 heads at the gate of the city, as a warning to deter other communities from resisting his arms. The place, however, owing to its natural advantages, gradually recovered from the effects of this terrible visitation, and when the Sefevæan dynasty who succeeded to power in the 16th century, transferred their place of residence to it from Casbin, it rose rapidly in populousness and wealth. It was under Shah Abbas the first, the most illustrious sovereign of this house, that Ispahan attained its greatest prosperity. This monarch adopted every possible expedient, by stimulating commerce, encouraging arts and manufactures, and introducing luxurious habits, to attract visitors to his favourite capital. He built several magnificent palaces in the richest style of Oriental decoration, planted gardens and avenues, and distributed amongst them the waters of the Zindch-rûd in an endless series of reservoirs, fountains, and cascades. The baths, the mosques, the colleges, the bazaars, and the caravanserais of the city received an equal share of his attention, and European artificers and merchants were largely encouraged to settle in his capital. Ambassadors visited his court from many of the first states of Europe, and factories were permanently established for the merchants of England, France, Holland, the Hanseatic towns, Spain, Portugal, and Moscow. The celebrated traveller Chardin, who passed a great portion of his life at Ispahan in the latter half of the 17th century, has left a detailed and most interesting account of the statistics of the city at that period. He himself estimated the population at 600,000, though in popular belief the number exceeded a million. There were 1500 flourishing villages in the immediate neighbourhood; the enceinte of the city and suburbs was reckoned at 24 miles, while the mud walls sur-

rounding the city itself, probably nearly following the lines of the Boide enclosure, measured 20,000 paces. In the interior were counted 162 mosques, 48 public colleges, 1802 caravanserais, 273 baths, and 12 cemeteries. The adjoining suburb of Julfa was also a most flourishing place. Originally founded by Shah Abbaa the Great, who transported to this locality 3400 Armenian families from the town of Julfa on the Arras, the colony increased rapidly under his fostering care, both in wealth and in numbers, the Christian population being estimated in 1685 at 30,000 souls. The first blow to the prosperity of modern Ispahan was given by the Afghan invasion at the beginning of the 18th century, since which date, although continuing for some time to be the nominal head of the empire, the city has gradually dwindled in importance, and now only ranks as a second or third rate provincial capital. When the Kajar dynasty indeed mounted the throne of Persia at the end of the last century the seat of government was at once transferred to Teheran, with a view to the support of the royal tribe, whose chief seat was in the neighbouring province of Mazenderân; and, although it has often been proposed, from considerations of state policy in reference to Russia, to re-establish the court at Ispahan, which is the true centre of Persia, the scheme has never commanded much attention. At the same time the government of Ispahan, owing to the wealth of the surrounding districts, has always been much sought after. Early in the century the post was often conferred upon some powerful minister of the court, but in later times it has been usually the apportionment of a favourite son or brother of the reigning sovereign. Feth Ali Shâh, who had a particular affection for Ispahan, died at that place in 1834, and it is still a time-honoured custom for the monarch on the throne to seek relief from the heat of Teherân by forming a summer camp at the rich pastures of Gandomân on the skirts of Zardeh-Koh, to the west of Ispahan, for the exercise of his troops and the health and amusement of his courtiers. (H. C. R.)

## I S R A E L

Relation-  
ships of  
Israel.

1. ACCORDING to the Book of Genesis, Israel was the brother of Edom, and the cousin of Moab and Ammon. These four petty peoples, which may be classed together as the Hebrew group, must at one time have formed some sort of a unity and have passed through a common history which resulted in their settlement in south-eastern Palestine. The Israelites, or rather that section of the Hebrew group which afterwards developed into Israel, appear at first to have been the immediate neighbours of Edom, and to have extended westwards towards the border of Egypt. As regards the ethnological position of the Hebrews as a whole, tradition has it that they had connexions not only with the Aramæans of Osrohoene (Nahor), but also with certain of the old half-Arab inhabitants of the Sinaitic peninsula (Kenites, Amalek, Midjan). To the Canaanites, whose language they had adopted, their relation was that of foreign conquerors and lords to a subject race (Gen. ix. 26).

Sojourn  
in Egypt.

Some fifteen centuries before our era a section of the Hebrew group left its ancient seat in the extreme south of Palestine to occupy the not distant pasture lands of Egypt (Goshen), where they carried on their old calling, that of shepherds and goatherds. Although settled within the territory of the Pharaohs, and recognizing their authority, they continued to retain all their old characteristics,—their language, their patriarchal institutions, their nomad habits of life.

But in course of time these foreign guests were subjected to changed treatment. Forced labour was exacted of them for the construction of new public works in Goshen, an exaction which was felt to be an assault upon their freedom and honour, and which in point of fact was fitted to take away all that was distinctive of their nationality. But they had no remedy at hand, and had submitted in despair, until Moses at last saw a favourable opportunity of deliverance. Reminding his oppressed brethren of the God of their fathers, and urging that their cause was His, he taught them to regard self-assertion against the Egyptians as an article of religion; and they became once more a united people in a determination to seek refuge

from oppression in the wilderness which was the dwelling place of their kindred and the seat of their God. At a time when Egypt was scourged by a grievous plague, the Hebrews broke up their settlement in Goshen one night in spring, and directed their steps towards their old home again. According to the accounts, the king had consented to the exodus, and latterly had even forced it on, but it was none the less a secret flight.

To a not very numerous pastoral people such an undertaking presented no great difficulty. Nevertheless its execution was not to be carried out unimpeded. The Hebrews, compelled to abandon the direct eastward road (Exod. xiii. 17, 18), turned towards the south-west and encamped at last on the Egyptian shore of the northern arm of the Red Sea, where they were overtaken by Pharaoh's army. The situation was a critical one: but a high wind during the night had left the shallow sea so low that it became possible to ford it. Moses eagerly accepted the suggestion, and made the venture with success. The Egyptians, rushing after, came up with them on the further shore, and a struggle ensued. But the assailants fought at a disadvantage, the ground being ill suited for their chariots and horsemen; they fell into confusion and attempted a retreat. Meanwhile the wind had changed; the waters returned, and the pursuers were annihilated.<sup>1</sup>

After turning aside to visit Sinai as related in Exodus, the emigrants settled at Kadesh, eastwards from Goshen, on the southern borders of Palestine,<sup>2</sup> where they remained

Settle-  
ment at  
Kadesh.

<sup>1</sup> Ex. xiv. 21, 24, 25, 27, 30, 31. According to the Old Testament the exodus took place 480 years before the building of Solomon's temple, and 960 years before the end of the Babylonian captivity. These figures are "systematic" or at least systematized, but even so they are certainly more trustworthy than the combinations of the Egyptologists.

<sup>2</sup> The site of Sinai (= Horeb?) hardly admits of ascertainment. The best datum would be the sanctuary of Jethro, if we could identify it with Midian (*Jakut*, iv. 451), which lies on the Arabian coast of the Red Sea obliquely facing the traditional Sinai. With regard to Kadesh, see *Quarterly Statement of Palestine Exploration Fund* (1871), pp. 20, 21.

for many years, living at the well of Kadesh their sanctuary and judgment seat only, while with their flocks they ranged over an extensive tract. In all probability their stay at Kadesh was no involuntary detention; rather was it this locality they had more immediately had in view in setting out. For a civilized community of from two to three millions such a settlement would of course have been impossible; but it was quite sufficient for the immediate requirements of the Goshen shepherds, few in number as they were, and inured to the life of the desert. That attempts may have been made by them to obtain possession of the more fertile country to the north is very likely; but that from the outset they contemplated the conquest of the whole of Palestine proper, and that it was only in expiation of a fault that they were held back at the gate of the promised land until the whole generation of the disobedient had died out, is not historically probable.

We can assign a definite reason for their final departure from Kadesh. In the district to the east of Jordan the (Canaanite) Amorites had, sometime previously, driven the Ammonites from the lower Jabbok and deprived the Moabites of all their territory to the north of the Arnon; on the plateau opposite Jericho Heshbon had become the capital of Sihon, the Amorite king. This sovereign now set himself to subdue southern Moab also, and not without success. "Fire went out from Heshbon, flame from the stronghold of Sihon, devoured the cities of Moab upon the heights of Arnon. Woe to thee, O Moab! thou art undone, O people of Chemosh!" From these straits the Moabites were rescued by their cousins, the nomads of the wilderness of Kadesh. The Israelites came forward on behalf of what was at once the common Hebrew cause and their own particular interest; they took the field against the Amorites, vanquished them in battle, and broke up the kingdom of Sihon. The consequence was that the land to the south of the Arnon remained in the undisputed possession of Moab, while the victors themselves became masters of the territory immediately to the north. Settled thus between Moab and Ammon their kinsmen, the Israelites supplied the link that was wanting in the chain of petty Hebrew nationalities established in the south of eastern Palestine.

The army that went out against the Amorites from Kadesh was certainly not exclusively composed of men who, or whose fathers, had accomplished the passage of the Red Sea. Israel was not a formed nation when it left Egypt; and throughout the whole period of its sojourn in the wilderness it continued to be in process of growth. Instead of excluding the kindred elements which offered themselves to it on its new soil, it received and assimilated them. The life they had lived together under Moses had been the first thing to awaken a feeling of solidarity among the tribes which afterwards constituted the nation; whether they had previously been a unity in any sense of the word is doubtful. On the other hand, the basis of the unification of the tribes must certainly have been laid before the conquest of Palestine proper; for with that it broke up, though the memory of it continued. At the same time it must not be supposed that all the twelve tribes already existed side by side in Kadesh. The sons of the concubines of Jacob—Dan and Naphtali, Gad and Asher—manifestly do not pertain to Israel in the same sense as do those of Leah and Rachel; probably they were late arrivals and of very mixed origin. We know, besides, that Benjamin was not born until afterwards, in Palestine. If this view be correct, Israel at first consisted of seven tribes, of which one only, that of Joseph, traced its descent to Rachel, though in point of numbers and physical strength it was the equal of all the others together, while in intellectual force it surpassed them. The remaining six were the sons of Leah:—Reuben, Simeon, Levi, Judah; Issachar,

Zebulun. They are always enumerated in this order; the fact that the last two are also invariably mentioned apart from the rest and after Joseph has its explanation in geographical considerations.

The time of Moses is invariably regarded as the properly creative period in Israel's history, and on that account also as giving the pattern and norm for the ages which followed. In point of fact the history of Israel must be held to have begun then, and the foundations of a new epoch to have been laid. The prophets who came after gave, it is true, greater distinctness to the peculiar character of the nation, but they did not make it; on the contrary, it made them. Again, it is true that the movement which resulted in the establishment of the monarchy brought together for the first time into organic unity the elements which previously had existed only in an isolated condition; but Israel's sense of national personality, was a thing of much earlier origin, which even in the time of the judges bound the various tribes and families together, and must have had a great hold on the mind of the nation, although there was no formal and binding constitution to give it support. When the Israelites settled in Palestine they found it inhabited by a population superior to themselves both in numbers and in civilization, which they did not extirpate, but on the contrary gradually subdued and absorbed. The process was favoured by affinity of race and similarity of speech; but, however far it went, it never had the effect of making Israelites Canaanites; on the contrary, it made Canaanites Israelites. Notwithstanding their inferiority, numerical and otherwise, they maintained their individuality, and that without the support of any external organization. Thus a certain inner unity actually subsisted long before it had found any outward political expression; it goes back to the time of Moses, who is to be regarded as its author.

The foundation upon which, at all periods, Israel's sense of its national unity rested was religious in its character. It was the faith which may be summed up in the formula, Jehovah is the God of Israel, and Israel is the people of Jehovah. Moses was not the first discoverer of this faith, but it was through him that it came to be the fundamental basis of the national existence and history.<sup>1</sup> The exigencies of their position severed a number of kindred clans from their customary surroundings, and drove them into his arms. He undertook the responsibilities of their leader, and the confidence of success which he manifested was justified by the result. But it was not through any merit of his that the undertaking (of which he was the soul) prospered as it did; his design was aided in a wholly unlooked-for way, by a marvellous occurrence quite beyond his control, and which no sagacity could possibly have foreseen. One whom the wind and sea obeyed had given him His aid. Behind him stood one higher than he, whose spirit wrought in him and whose arm wrought for him,—not for his personal aggrandizement indeed, but for the weal of the nation. It was Jehovah. Alike what was done by the deliberate purpose of Moses and what was done without any human contrivance by nature and by accident came to be regarded in one great totality as the doing of Jehovah for Israel. Jehovah it was who had directed each step in that process through which these so

<sup>1</sup> Jehovah is to be regarded as having originally been a family or tribal god, either of the family to which Moses belonged or of the tribe of Joseph, in the possession of which we find the ark of Jehovah, and within which occurs the earliest certain instance of a composite proper name with the word Jehovah for one of its elements (Jehoshua, Joshua). No essential distinction was felt to exist between Jehovah and El, any more than between Asshur and El; Jehovah was only a special name of El which had become current within a powerful circle, and which on that account was all the more fitted to become the designation of a national god.



diverse elements, brought together by the pressure of necessity, had been caused to pass, and in the course of which the first beginnings of a feeling of national unity had been made to grow.

This feeling Moses was the first to elicit; he it was also who maintained it in life and cherished its growth. The extraordinary set of circumstances which had first occasioned the new national movement continued to subsist, though in a less degree, throughout the sojourn of the people in the wilderness, and it was under their pressure that Israel continued to be moulded. To Moses, who had been the means of so brilliantly helping out of their first straits the Hebrews who had accompanied him out of Egypt, they naturally turned in all subsequent difficulties; before him they brought all affairs with which they were not themselves able to cope. The authority which his antecedents had secured for him made him as matter of course the great national "Kadhi" in the wilderness. Equally as matter of course did he exercise his judicial functions, neither in his own interest nor in his own name, but in the interest of the whole community and in the name of Jehovah. By connecting them with the sanctuary of Jehovah, which stood at the well of Kadesh, he made these functions independent of his person, and thus he laid a firm basis for a consuetudinary law and became the originator of the Torah in Israel. In doing this he succeeded in inspiring the national being with that which was the very life of his own soul; through the Torah he gave a definite positive expression to their sense of nationality and their idea of God. Jehovah was not merely the God of Israel; as such He was the God at once of law and of justice, the basis, the informing principle, and the implied postulate of their national consciousness.

Jehovah. The relationship was carried on in precisely the same manner as that in which it had been begun. It was most especially in the graver moments of its history that Israel awoke to full consciousness of itself and of Jehovah. Now, at that time and for centuries afterwards, the highwater marks of history were indicated by the wars it recorded. The name "Israel" means "El does battle," and Jehovah was the warrior El, after whom the nation styled itself. The camp was, so to speak, at once the cradle in which the nation was nursed and the smithy in which it was welded into unity; it was also the primitive sanctuary. There Israel was, and there was Jehovah. If in times of peace the relations between the two had become dormant, they were at once called forth into fullest activity when the alarm of danger was raised; Israel's awakening was always preceded by the awakening of Jehovah. Jehovah awakened men who under the guidance of His spirit placed themselves at the nation's head; in them His proper leadership was visibly expressed. Jehovah went forth with the host to battle, and in its enthusiasm His presence was seen (Judg. v. 13, 23). With signs and wonders from heaven Jehovah decided the struggle carried on upon earth. In it He was always upon Israel's side; on Israel was His whole interest concentrated, although His power (for He was God) reached far beyond their local limits.

Thus Jehovah was in a very real sense a living God; but the manifestations of His life in the great crises of His people's history were of necessity separated by considerable intervals of time. His activity had something abrupt and tumultuary about it, better suited for extraordinary occasions than for ordinary daily life. Traces of this feeling appear very prominently in the later stages of the development. But although the relations between Israel and Israel's God came most strongly into prominence in times of excitement, yet it did not altogether die out in the periods of comparative repose. It was in the case of Jehovah just as in the case of the human leaders of the

people, who did not in times of peace wholly lose the influence they had gained in war. Jehovah had His permanent court at the places of worship where in times of quietude men clung to Him that they might not lose Him in times of trouble. His chief, perhaps in the time of Moses His only, sanctuary was with the so-called ark of The ark the covenant. It was a standard, adapted primarily to the requirements of a wandering and warlike life; brought back from the field, it became, as symbol of Jehovah's presence, the central seat of His worship. The cultus itself was more than a mere paying of court to Jehovah, more than a mere expedient for retaining His sympathies against times of necessity; the Torah of Jehovah, the holy administration of law, was conjoined with it. This had first of all been exercised, at the instance of the priest of Midian, by Moses at the well of Kadesh; it was continued after him, at the sanctuary, within the circle of those who had attached themselves to him and were spiritually his heirs. In cases where the wisdom or the competency of the ordinary judges failed, men turned direct to the God-head, *i.e.*, to the sanctuary and those who served it. Their decisions, whether given according to their own lights or by lot (according to the character of the question), were not derived from any law, but were received direct from Jehovah.<sup>1</sup> The execution of their decisions did not lie with them; they could only advise and teach. Their authority was divine, or, as we should say, moral, in its character; it rested upon that spontaneous recognition of the idea of right which, though unexpressed, was alive and working among the tribes, upon Jehovah Himself who was the author of this generally diffused sense of right, but revealed the proper determinations on points of detail only to certain individuals. The priestly Torah was an entirely unpolitical or rather prepolitical institution; it had an existence before the state had, and it was one of the invisible foundation pillars on which the state rested.

War and the administration of justice were regarded as The theo- matters of religion before they became matters of 'obliga- cracy tion and civil order; this is all that is really meant when a theocracy is spoken of. Moses certainly organized no formal state, endowed with specific holiness, upon the basis of the proposition "Jehovah is the God of Israel"; or, at all events, if he did so, the fact had not in the slightest degree any practical consequence or historical significance. The old patriarchal system of families and clans continued as before to be the ordinary constitution, if one can apply such a word as constitution at all to an unorganized conglomeration of homogeneous elements. What there was of permanent official authority lay in the hands of the elders and heads of houses; in time of war they commanded each his own household force, and in peace they dispensed justice each within his own circle. But this obviously imperfect and inefficient form of government showed a growing tendency to break down just in proportion to the magnitude of the tasks which the nation in the course of its history was called upon to undertake. Appeal to Jehovah was always in these circumstances resorted to; His court was properly that of last resort, but the ordinary authorities were so inadequate that it had often enough to be applied to. Theocracy, if one may so say, arose as the complement of anarchy. Actual and legal existence (in the modern sense) was predicable only of each of the many clans; the unity of the nation was realized in the first instance only through its religion. It was out of the religion of Israel that the commonwealth of Israel unfolded itself,—not a *holy* state, but *the* state. And the state continued to be, consciously, rooted in religion, which prevented

<sup>1</sup> They were consulted chiefly on points of law, but also on all sorts of difficulties as to what was right and to be done, or wrong and to be avoided.

it from quitting or losing its rapport with the soil from which it had originally sprung. With the intermediate and higher stages of political organization, with the building of the upper structure, however, religion had no concern; they were too far removed from the foundation. The derivative, which did not carry immediately in itself its own title to exist, was a matter of indifference to it; what had come into being it suffered to go its own way as soon as it was capable of asserting its independence. For this reason it always turned by preference to the future, not in a utopian but in a thoroughly practical way; by a single step only did it keep ahead of the present. It prepared the way for such developments as are not derived from existing institutions, but spring immediately from the depths in which human society has its secret and mysterious roots.

The expression "Jehovah is the God of Israel," accordingly, meant that every task of the nation, internal as well as external, was conceived as holy. It certainly did not mean that the almighty Creator of heaven and earth was conceived of as having first made a covenant with this one people that by them He might be truly known and worshipped. It was not as if Jehovah had originally been regarded as the God of the universe who subsequently became the God of Israel; on the contrary, He was primarily Israel's God, and only afterwards (very long afterwards) did He come to be regarded as the God of the universe. For Moses to have given to the Israelites an "enlightened conception of God" would have been to have given them a stone instead of bread; it is in the highest degree probable that, with regard to the essential nature of Jehovah, as distinct from His relation to men, he allowed them to continue in the same way of thinking with their fathers. With theoretical truths, which were not at all in demand, he did not occupy himself, but purely with practical questions which were put and urged by the pressure of the times. The religious starting point of the history of Israel was remarkable, not for its novelty, but for its normal character. In all ancient primitive peoples the relation in which God is conceived to stand to the circumstances of the nation—in other words, religion—furnishes a motive for law and morals; in the case of none did it become so with such purity and power as in that of the Israelites. Whatever Jehovah may have been conceived to be in His essential nature—God of the thunderstorm or the like—this fell more and more into the background as mysterious and transcendental; the subject was not one for enquiry. All stress was laid upon His activity within the world of mankind, whose ends He made one with His own. Religion thus did not make men partakers in a divine life, but contrariwise it made God a partaker in the life of men; life in this way was not straitened by it, but enlarged. The so-called "particularism" of Israel's idea of God was in fact the real strength of Israel's religion; it thus escaped from barren mythologizings, and became free to apply itself to the moral tasks which are always given, and admit of being discharged, only in definite spheres. As God of the nation, Jehovah became the God of justice and of right; as God of justice and right, He came to be thought of as the highest, and at last as the only, power in heaven and earth.

In the preceding sketch the attempt has been made to exhibit Mosaism as it must be supposed to have existed on the assumption that the history of Israel commenced with it and that for centuries it continued to be the ideal root out of which that history continued to grow. This being assumed, we cannot treat the legislative portion of the Pentateuch as a source from which our knowledge of what Mosaism really was can be derived; for it cannot in any sense be regarded as the starting point of the subsequent development. If it was the work of Moses, then we must suppose it to have remained a dead letter for centuries, and only through King Josiah and Ezra the scribe to have become operative in the national history

(compare sections 3 and 10). The historical tradition which has reached us relating to the period of the judges and of the kings of Israel is the main source, though only of course in an indirect way, of our knowledge of Mosaism. But within the Pentateuch itself also the *historical* tradition about Moses (which admits of being distinguished, and must carefully be separated, from the *legislative*, although the latter often clothes itself in narrative form) is in its main features manifestly trustworthy, and can only be explained as resting on actual facts.

From the historical tradition, then, it is certain that Moses was the founder of the Torah. But the legislative tradition cannot tell us what were the positive contents of his Torah. In fact it can be shown that throughout the whole of the older period the Torah was no finished legislative code, but consisted entirely of the oral decisions and instructions of the priests; as a whole it was potential only; what actually existed were the individual sentences given by the priesthood as they were asked for. Thus Moses was not regarded as the promulgator once for all of a national constitution, but rather as the first to call into activity the national sense for law and justice, and to begin the series of oral decisions which were continued after him by the priests. He was the founder of the nation out of which the Torah and prophecy came as later growths. He laid the basis of Israel's subsequent peculiar individuality, not by any one formal act, but in virtue of his having, throughout the whole of his long life, been the people's leader, judge, and centre of union.

A correct conception of the manner in which the Torah was made by him can be derived from the narrative contained in Exod. xviii., but not from the long section which follows, relating to the Sinaitic covenant (ch. xix. *seq.*). The giving of the law at Sinai has only a formal, not to say dramatic, significance. It is the product of the poetic necessity for such a representation of the manner in which the people was constituted Jehovah's people as should appeal directly and graphically to the imagination. Only so can we justly interpret those expressions according to which Jehovah with His own mouth thundered the ten commandments down from the mountain to the people below, and afterwards for forty days held a confidential conference with Moses alone on the summit. For the sake of producing a solemn and vivid impression, that is represented as having taken place in a single thrilling moment which in reality occurred slowly and almost unobserved. Why Sinai should have been chosen as the scene admits of ready explanation. It was the Olympus of the Hebrew peoples, the earthly seat of the Godhead, and as such it continued to be regarded by the Israelites even after their settlement in Palestine (Judg. v. 4, 5). This immemorial sanctity of Sinai it was that led to its being selected as the ideal scene of the giving of the law, not conversely. If we eliminate from the historical narrative the long Sinaitic section which has but a loose connexion with it, the wilderness of Kadesh becomes the locality of the preceding and subsequent events. It was during the sojourn of many years here that the organization of the nation, in any historical sense, took place. "There he made for them statute and ordinance, and there he proved them," as we read in Ex. xv. 25 in a dislocated poetical fragment. "Judgment and trial," "Massa and Meribah," point to Kadesh as the place referred to; there at all events is the scene of the narrative immediately following (Ex. xvii.—Num. xx.), and doubtless also of Ex. xviii.

If the legislation of the Pentateuch cease as a whole to be regarded as an authentic source for our knowledge of what Mosaism really was, it becomes a somewhat precarious matter to make any exception in favour of the Decalogue. In particular, the following arguments against its authenticity must be taken into account. (1) According to Ex. xxxiv. the commandments which stood upon the two tables were quite different. (2) The prohibition of images was during the older period quite unknown; Moses himself is said to have made a brazen serpent which down to Hezekiah's time continued to be worshipped at Jerusalem as an image of Jehovah. (3) The essentially and necessarily national character of the older phases of the religion of Jehovah completely disappears in the quite universal code of morals which is given in the Decalogue as the fundamental law of Israel; but the entire series of religious personalities throughout the period of the judges and the kings—from Deborah, who praised Jael's treacherous act of murder, to David, who caused his prisoners of war to be sawn asunder and burnt—make it very difficult to believe that the religion of Israel was from the outset one of a specifically moral character. The true spirit of the old religion may be gathered much more truly from Judg. v. than from Ex. xx. (4) It is extremely doubtful whether the actual monotheism which is undoubtedly presupposed in the universal moral precepts of the Decalogue could have formed the foundation of a national religion. It was first developed out of the national religion at the downfall of the nation, and thereupon kept its hold upon the people in an artificial manner by means of the idea of a covenant formed by the God of the universe with, in the first instance, Israel alone (compare sects. 6-10).

As for the question regarding the historical presuppositions of Mosaism, there generally underlies it a misunderstanding arising

"Particularism" of Israel's religion.

Legislative and historical tradition.



Historical pre-suppositions of Mosaicism. out of theological intellectualism—an attribute found with special frequency among non-theologians. Moses gave no new idea of God to his people. The question whence he could have derived it therefore need not be raised. It could not possibly be worse answered, however, than by a reference to his relations with the priestly caste of Egypt and their wisdom. It is not to be believed that an Egyptian deity could inspire the Hebrews of Goshen with courage for the struggle against the Egyptians, or that an abstraction of esoteric speculation could become the national deity of Israel. It is not inconceivable indeed, although at the same time quite incapable of proof, that Moses was indebted to the Egyptian priests for certain advantages of personal culture, or that he borrowed from them on all hands in external details of organization or in matters of ritual. But the origin of the germ which developed into Israel is not to be sought for in Egypt, and Jehovah has nothing in common with the colourless divinity of Penta-ur or with the God-forsaken dreariness of certain modern Egyptologists. That monotheism must have been a foreign importation, because it is contrary to that sexual dualism of Godhead which is the fundamental characteristic of Semitic religion, is an untenable exaggeration which has recently become popular out of opposition to the familiar thesis about the monothestic instinct of the Semites (Noldeke, *Literar. Centralbl.*, 1877, p. 365). Moab, Ammon, and Edom, Israel's nearest kinsfolk and neighbours, were monotheists in precisely the same sense in which Israel itself was; but it would be foolish surely in their case to think of foreign importation.

Manetho's statements about the Israelites are for the most part to be regarded as malicious inventions: whether any genuine tradition underlies them at all is a point much needing to be investigated; the identity of Osarsiph and אֲרִיסֹפִי is really very questionable. The story of Exod. ii. 1 *sqq.* is a mythus of frequent recurrence elsewhere, to which no further significance is attached, for that Moses was trained in all the wisdom of the Egyptians is vouched for by no earlier authorities than Philo and the New Testament. According to the Old Testament tradition his connexion is with Jethro's priesthood or with that of the Kenites. This historical presupposition of Mosaicism has external evidence in its favour, and is inherently quite probable.

Early invasions of Palestine proper.

2. The kingdom of Sihon did not permanently suffice the Israelites, and the disintegration of the Canaanites to the west of Jordan in an endless number of kingdoms and cities invited attack. The first essay was made by Judah in conjunction with Simeon and Levi, but was far from prosperous. Simeon and Levi were annihilated; Judah also, though successful in mastering the mountain land to the west of the Dead Sea, was so only at the cost of severe losses which were not again made up until the accession of the Kenite families of the south (Caleb). As a consequence of the secession of these tribes, a new division of the nation into Israel and Judah took the place of that which had previously subsisted between the families of Leah and Rachel; under Israel were included all the tribes except Simeon, Levi, and Judah, which three are no longer mentioned in Judg. v., where all the others are carefully and exhaustively enumerated. This half-abortive first invasion of the west was followed by a second, which was stronger and attended with much better results. It was led by the tribe of Joseph, to which the others attached themselves, Reuben and Gad only remaining behind in the old settlements. The district to the north of Judah, inhabited afterwards by Benjamin, was the first to be attacked. It was not until after several towns of this district had one by one fallen into the hands of the conquerors that the Canaanites set about a united resistance. They were, however, decisively repulsed by Joshua in the neighbourhood of Gibeon; and by this victory the Israelites became masters of the whole central plateau of Palestine. The first camp, at Gilgal, near the ford of Jordan, which had been maintained until then, was now removed, and the ark of Jehovah brought further inland (perhaps by way of Bethel) to Shiloh, where henceforward the headquarters were fixed, in a position which seemed as if it had been expressly made to favour attacks upon the fertile tract lying beneath it on the north. The Ben Rachel now occupied the new territory which up to that time had been acquired,—Benjamin, in immediate contiguity with the frontier of Judah, then Ephraim, stretching

Occupation of central plateau.

to beyond Shiloh, and lastly Manassch, furthest to the north, as far as to the plain of Jezreel. The centre of gravity, so to speak, already lay in Ephraim to which belonged Joshua and the ark.

It is mentioned as the last achievement of Joshua that at the waters of Merom he defeated Jabin, king of Hazor, and the allied princes of Galilee, thereby opening up the north for Israelitish settlers. It is quite what we should expect that a great and united blow had to be struck at the Canaanites of the north before the new comers could occupy it in peace; and King Jabin, who reappears at a later date, certainly does not suit the situation described in Judg. iv., v.

The book of Joshua represents the conquest of western Palestine having been the common undertaking of all the tribes together, which, after the original inhabitants have been extirpated, are exhibited as laying the ownerless country at Joshua's feet in order that he may divide it by lot amongst them. But this is a "systematic" generalization, contradicted by the facts which we otherwise know. For we possess another account of the conquest of Palestine, that of Judg. i., which runs parallel with the book of Joshua. It is shorter indeed and more superficial, yet in its entire mode of presenting the subject more historical. According to its narrative, it appears that Joshua was the leader of Joseph and Benjamin only, with whom indeed Issachar, Zebulon, Dan, Naphtali, and Asher made common cause. But before his time the tribe of Judah had already crossed the Jordan and effected a lodgment in the territory which lay between the earlier seat of the nation in the wilderness of Kadesh and its then settlement on the plateau of Moab, forming in some degree a link of connexion between the two. It might be supposed that the tribe of Judah had not taken the longer route to the eastward of the Dead Sea at all, but had already at Kadesh broken off from the main body and thence turned its steps directly northward. But the representation actually given in Judg. i., to the effect that it was from the direction of the Jordan and not from that of the Negeb that they came to take possession of their land, finds its confirmation in the fact that the southern portion of their territory was the last to come into their possession. The tradition is unwavering that Hebron was taken not by Judah but by Caleb, a family which stood in friendly relations with Israel, but had no connexion with it by blood. It was only through the policy of David that Caleb, Othniel, Jerachmeel, and the rest of the Kenites who had their homes in the Negeb became completely incorporated with Judah, so that Hebron became at last the capital of that tribe. Its oldest seats, however, lay further to the north, in the region of Tekoa, Bethlehem, Baal Judah.

It harmonizes well with this view to suppose that Simeon and Levi must have made at the same time their attempt to effect a settlement in the hill country of Ephraim. One of their families, Dinah with Leah, met with a favourable reception in the town of Shechem, and began to mix freely with its population, and thus the way was paved for the establishment of peaceable relations between the old inhabitants of the land and the new importations. But these relations were brought to an end by the two brothers who, in concert it must be supposed with their sister, fell upon the Shechemites and massacred them. The final result proved disastrous. The Canaanites of the surrounding country united against them and completely destroyed them. There can be no doubt as to the trustworthiness of the somewhat enigmatical records of those events which are given in Gen. xlix. and xxxiv.; in no other way is it possible to explain why Simeon and Levi, which originally came upon the stage of history on an equal footing with Reuben and Judah, should have already disappeared as independent tribes at the very beginning of the period of the judges. Now, that the destruction of Shechem by the Manassite Abimelech is quite distinct from the attack made by Simeon and Levi need hardly be said. On the other hand, the occurrence cannot be regarded as pre-Mosaic, but must be assigned to a time previous to the conquest of the hill country of Ephraim by Joseph; for after Joseph's settlement there the two sons of Leah had manifestly nothing more to hope for in that locality. We are shut up, therefore, to the conclusion that they crossed the Jordan at the same time as Judah separated himself from the main body in search of a suitable territory. That Simeon accompanied Judah in the first westward attempt is expressly stated in Judg. i. The fate of Levi, again, cannot be separated from that of Simeon (Gen. xlix. 5-7); that he is not expressly mentioned in Judg. i. ought not to cause surprise, when it is considered that later generations which regarded Levi as neither more nor less than a priest would have some difficulty in representing him as a thoroughly secular tribe. Such nevertheless he must have been, for the poet in Gen. xlix. 5-7 puts him on a footing of perfect equality with Simeon, and attributes to both brothers a very secular and bloodthirsty character; he has no conception that Levi has a sacred vocation which is the reason of the dispersion of the tribe; the

Narratives of Joshua and Judges.

Simeon and Levi.

dispersion on the contrary is regarded as a curse and no blessing, an annihilation and not the means of giving permanence to its tribal individuality. The shattered remains of Simeon, and doubtless those of Levi also, became incorporated with Judah, which thenceforward was the sole representative of the three sons of Leah, who according to the genealogy had been born immediately after Reuben the first-born. Judah itself seems at the same time to have suffered severely. Of its three older branches, Er, Onan, and Shelah, one only survived, and only by the accession of foreign elements did the tribe regain its vigour,—by the fresh blood which the Kenites of the Negeb brought. For Zarah and Pharez, which took the place of Er and Onan after these had disappeared, belonged originally, not to Israel, but to Hezron or the Kenites; under this designation are included families like those of Othniel, Jerachmeel, and Caleb, and, as has been already remarked, even in David's time these were not reckoned as strictly belonging to Judah. Thus the depletion which the tribe had to suffer in the struggle with the Canaanites at the beginning of the period of the judges was the remote cause of the prominence which, according to 1 Chron. ii., the Bene Hezron afterwards attained in Judah. The survivors of Simeon also appear to have been forced back upon these Hezronites in the Negeb; the cities assigned to them in the book of Joshua all belong to that region.

Perman-  
ent  
settle-  
ment.

Even after the united resistance of the Canaanites had been broken, each individual community had still enough to do before it could take firm hold of the spot which it had searched out for itself or to which it had been assigned. The business of effecting permanent settlement was just a continuation of the former struggle, only on a diminished scale; every tribe and every family now fought for its own hand after the preliminary work had been accomplished by a united effort. Naturally therefore the conquest was at first but an incomplete one. The plain which fringed the coast was hardly touched; so also the valley of Jezreel with its girdle of fortified cities stretching from Acco to Bethshean. All that was subdued in the strict sense of that word was the mountainous land, particularly the southern hill country of "Mount Ephraim"; yet even here the Canaanites retained possession of not a few cities, such as Jebus, Shechem, Thebez. It was only after the lapse of centuries that all the lacunæ were filled up, and the Canaanite enclaves made tributary.

The Israelites had the extraordinarily disintegrated state of the enemy to thank for the ease with which they had achieved success. The first storm subsided comparatively soon, and conquerors and conquered alike learned to accommodate themselves to the new circumstances. Then the Canaanites once more collected all their energies to strike a blow for freedom. Under the hegemony of Sisera a great league was formed, and the plain of Jezreel became the centre of the reorganized power which made itself felt by its attacks both northwards and southwards. The Israelites were strangely helpless; it was as if neither shield nor spear could be found among their 40,000 fighting men. But at last there came an impulse from above, and brought life and soul to the unorganized mass; Deborah sent out the summons to the tribes, Barak came forward as their leader against the kings of Canaan who had assembled under Sisera's command by the brook Kishon. The cavalry of the enemy was unable to withstand the impetuous rush of the army of Jehovah, and Sisera himself perished in the fight. From that day the Canaanites, although many strong towns continued to be held by them, never again raised their heads.

Canaan-  
ite reac-  
tion.  
Sisera.

After these occurrences some further changes of a fundamental character took place in the relations of the tribes. The Danites proved unable to hold against the forward pressure of the Philistines their territory on the coast to the west of Benjamin and Ephraim; they accordingly sought a new settlement, which was found in the north at the foot of Hermon. In this way all the secondary tribes westward of Jordan (Asher, Naphtali, Dan) came to have their seats beside each other in the northern division of the land. Eastward of Jordan, Reuben rapidly fell from

Dan:

his old prominence, sharing the fate of his next eldest brethren Simeon and Levi. When Eglon of Moab took Jericho, and laid Benjamin under tribute, it is obvious that he must previously have made himself master of Reuben's territory. This territory became thenceforward a subject of constant dispute between Moab and Israel; the efforts to recover it, however, did not proceed from Reuben himself, but from Gad, a tribe which knew how to assert itself with vigour against the enemies by which it was surrounded. But, if the Hebrews lost ground in the south, they materially enlarged their borders in the north of the land eastward of Jordan. Various Manassite families, finding their holdings at home too small, crossed the Jordan and founded colonies in Bashan and northern Gilead. Although this colonization, on account of the rivalry of the Aramæans, who were also pressing forward in this direction, was but imperfectly successful, it nevertheless was of very great importance, inasmuch as it served to give new strength to the bonds that united the eastern with the western tribes. Not only was Gilead not lost; it even became a very vigorous member of the body politic.<sup>1</sup>

The times of agitation and insecurity which followed upon the conquest of Palestine invited attacks by the eastern nomads, and once more the Israelite peasantry showed all its old helplessness, until at last the indignation of a Manassite of good family, Gideon or Jerubbaal, roused by the Midianites, who had captured some of his brothers and put them to death. With his family, that of Abiezer, he gave pursuit, and, overtaking the enemy on the borders of the wilderness, inflicted on them such chastisement as put an end to these incursions. His heroism had consequences which reached far beyond the scope of his original purpose. He became the champion of the peasantry against the freebooters, of the cultivated land against the waste; social respect and predominance were his rewards. In his native town of Ophrah he kept up a great establishment, where also he built a temple with an image of Jehovah overlaid with the gold which he had taken from the Midianites. He transmitted to his sons an authority, which was not limited to Abiezer and Manasseh alone, but, however slightly and indirectly, extended over Ephraim as well.

On the foundations laid by Gideon Abimelech his son sought to establish a kingship over Israel, that is, over Ephraim and Manasseh. The predominance, however, which had been naturally accorded to his father in virtue of his personal merits, Abimelech looked upon as a thing seized by force and to be maintained with injustice; and in this way he soon destroyed those fair beginnings out of which even at that time a kingdom might have arisen within the house of Joseph. The one permanent fruit of his activity was that Shechem was destroyed as a Canaanite city and rebuilt for Israel.<sup>2</sup>

The most important change of the period of the judges went on gradually and in silence. The old population of the country, which, according to Deuteronomy, was to

<sup>1</sup> It is probable that Manasseh's migration to the territory eastward of Jordan took place from the west, and later than the time of Moses. The older portions of the Hexateuch speak not of two and a half but only of two trans-Jordanic tribes, and exclude Manasseh; according to them the kingdom of Sihon alone was subdued by Moses, not that of Og also, the latter indeed being a wholly legendary personage. In the song of Deborah, Machir is reckoned among the western tribes, and it was not until much later that this became the designation of the Manassites eastward of Jordan. It is also worth noticing that Jair's colonization of northern Gilead did not take place until the time of the judges (Judg. x. 3 *sqq.*), but is related also in Num. xxxii. 39-42.

<sup>2</sup> On the narrative contained in the book of Judges see Blöck, *Eint. ins Alte Testament* (4th ed.), §§ 88-98, and especially the sections on Barak and Sisera, Gideon, Jephthah, Samson, the Danite migration, and the Benjamites of Gibeah (§§ 93-98).



have been exterminated, slowly became amalgamated with the new. In this way the Israelites received a very important accession to their numbers. In Deborah's time the fighting men of Israel numbered 40,000; the tribe of Dan, when it migrated to Laish, counted 600 warriors; Gideon pursued the Midianites with 300. But in the reigns of Saul and David we find a population of from two to three millions. The rapid increase is to be accounted for by the incorporation of the Canaanites.

Appropriation of Canaanite culture. At the same time the Hebrews learned to participate in the culture of the Canaanites, and quietly entered into the enjoyment of the labours of their predecessors. From the pastoral they advanced to the agricultural stage; corn and wine, the olive and the fig, with them are habitually spoken of as the necessaries of life. It was not strange that this change in the manner of their everyday life should be attended with certain consequences in the sphere of religion also. It is inconceivable that the Israelites should have brought with them out of the desert the cultus they observed in the time of the kings (Ex. xxii., xxxiii., xxxiv.), which throughout presupposed the fields and gardens of Palestine; they borrowed it from the Canaanites.<sup>1</sup> This is confirmed by the fact that they took over from these the "Bamoth" or "high places" also, notwithstanding the prohibition in Deut. xii.

Baal. It was natural enough that the Hebrews should also appropriate the divinity worshipped by the Canaanite peasants as the giver of their corn, wine, and oil, the Baal whom the Greeks identified with Dionysus. The apostasy to Baal, on the part of the first generation which had quitted the wilderness and adopted a settled agricultural life, is attested alike by historical and prophetic tradition. Doubtless Baal, as the god of the land of Canaan, and Jehovah, as God of the nation of Israel, were in the first instance coordinated.<sup>2</sup> But it was not to be expected that the divinity of the land should permanently be different from the God of the dominant people. In proportion as Israel identified itself with the conquered territory, the divinities also were identified. Hence arose a certain syncretism between Baal and Jehovah, which had not been got over even in the time of the prophet Hosea. At the same time the functions of Baal were more frequently transferred to Jehovah than conversely. Canaan and Baal represented the female, Israel and Jehovah the male, principle in this union.

Dangers of civilization for Israel. Had the Israelites remained in the wilderness and in barbarism, the historical development they subsequently reached would hardly have been possible; their career would have been like that of Amalek, or, at best, like those of Edom, Moab, and Ammon. Their acceptance of civilization was undoubtedly a step in the forward direction; but as certainly did it also involve a peril. It involved an overloading, as it were, of the system with materials which it was incapable of assimilating at once. The material tasks imposed threatened to destroy the religious basis of the old national life. The offensive and defensive alliance among the tribes gradually dissolved under the continuance of peace; the subsequent occupation of the country dispersed those whom the camp had united. The enthusiastic *elan* with which the conquest had been achieved gave way to the petty drudgery by which the individual families, each in its own circle, had to accommodate themselves to their new surroundings. Yet under the ashes the embers were still aglow; and the

course of history ever fanned them anew into flame, bringing home to Israel the truths that man does not live by bread alone, and that there are other things of worth than those which Baal can bestow; it brought ever again into the foreground the divineness of heroic self-sacrifice of the individual for the good of the nation.

3. The Philistines were the means of arousing from their slumber Israel and Jehovah. From their settlements by the sea, on the low-lying plain which skirts the mountain of Judah on the west, they pressed northwards into the plain of Sharon, and thence into the plain of Jezree, beyond, which is connected with that of Sharon by the upland valley of Dothan. Here, having driven out the Danites, they came into direct contact with the tribe of Joseph, the chief bulwark of Israel, and a great battle took place at Aphek, where the plain of Sharon merges into the valley of Dothan. The Philistines were victorious and carried off as a trophy the Israelite standard, the ark of Jehovah. Their further conquests included, not only the plain of Jezree and the hill country bordering it on the south, but also the proper citadel of the country, "Mount Ephraim." The old sanctuary at Shiloh was destroyed by them; its temple of Jehovah thenceforward lay in ruins. Their supremacy extended as far as to Benjamin; the Philistines had a *neqib* in Gibeath.<sup>3</sup> But the assertion that they had confiscated all weapons and removed all smiths must be regarded as an unhistorical exaggeration; under their regime at all events it was possible for the messengers of a beleaguered city on the east of Jordan to summon their countrymen in the west to their relief.

The shame of the Israelites under the reproach of Philistine oppression led in the first instance to a widespread exaltation of religious feeling. Troops of ecstatic enthusiasts showed themselves here and there, and went about with musical accompaniments in processions which often took the shape of wild dances; even men of the most sedate temperament were sometimes smitten with the contagion, and drawn into the charmed circle. In such a phenomenon, occurring in the East, there was nothing intrinsically strange; among the Canaanites, such "Nebim"—for so they were styled—had long been familiar, and they continued to exist in the country after the old fashion, long after their original character, so far as Israel was concerned, had been wholly lost. The new thing at this juncture was that this spirit passed over upon Israel, and that the best members of the community were seized by it. It afforded an outlet for the suppressed excitement of the nation.

The new-kindled zeal had for its object, not the abolition of Baal worship, but resistance to the enemies of Israel. Religion and patriotism were then identical. This spirit of the times was understood by an old man, Samuel ben Elkanah, who lived at Ramah in south-western Ephraim. He was not himself one of the Nebim; on the contrary, he was a seer of that old type which had for a long time existed amongst the Hebrews much as we find it amongst the Greeks or Arabs. Raised by his foreseeing talent to a position of great prominence, he found opportunity to occupy himself with other questions besides those which he was professionally called on to answer. The national distress weighed upon his heart; the neighbouring peoples had taught him to recognize the advantages which are secured by the consolidation of families and tribes into a kingdom. But Samuel's peculiar merit lay, not in dis-

<sup>1</sup> In the earliest case where the feast of the ingathering, afterwards the chief feast of the Israelites, is mentioned, it is celebrated by Canaanites of Shechem in honour of Baal (Judg. ix. 27).

<sup>2</sup> In Judg. v. Jehovah retains his original abode in the wilderness, on Sinai, and only on occasions of necessity quits it to come to Palestine.

<sup>3</sup> *Neqib* is an Aramaic word of uncertain meaning. In the name of the town Neqibin (Nisibis) it certainly seems to mean "pillars"; according to 1 Kings iv. 5 and xxii. 48 (where it is pointed *niqab*), "governor" seems the best translation, and this is the only rendering consistent with the expression in 1 Sam. xiii. 3 ("Jonathan slew the *neqib*," &c.).

**Saul:** covering what it was that the nation needed, but in finding out the man who was capable of supplying that need. Having come to know Saul ben Kish, a Benjamite of the town of Gibeah, a man of gigantic form, and swift, enthusiastic nature, he declared to him his destiny to become king over Israel.

Saul very soon had an opportunity for showing whether Samuel had been a true seer or no. The city of Jabesh in Gilead was besieged by the Ammonites, and the inhabitants declared themselves ready to surrender should they fail in obtaining speedy succour from their countrymen. Their messengers had passed through all Israel without meeting with anything more helpful than pity, until at last tidings of their case reached Saul as he was retreating with a yoke of oxen from the field. Hewing his cattle in pieces, he caused the portions to be sent in all directions, with the threat that so should it be done with the oxen of every one who should refuse to help in relieving Jabesh. The people obeyed the summons, fell suddenly one morning upon the Ammonites, and delivered the beleaguered city.

**Patriotic struggle:** Having thus found Saul the man for their need, they refused to let him go. In Gilgal, Joshua's old camp, they anointed him king. The act was equivalent to imposing upon him the conduct of the struggle against the Philistines, and so he understood it. The first signal for the attack was given by his son Jonathan, when he slew the *agrib* of the Philistines at Gibeah. These in consequence advanced in force towards the focus of the revolt, and took up a position opposite Gibeah on the north, being divided from it only by the gorge of Michmash. Only a few hundred Benjamites ventured to remain with Saul. The struggle opened with a piece of genuine old heroic daring. While the Philistines were dispersed over the country in foraging expeditions, Jonathan, accompanied by his armour-bearer only, and without the knowledge of Saul, made an attack upon the weak posts which they had left behind at the pass of Michmash. After the first had been surprised and overmastered, the others took to flight, no doubt in the belief that the two assailants were supported. They carried their panic with them into the half-deserted camp, whence it spread among the various foraging bands. The commotion was observed from Gibeah opposite, and, without pausing to consult the priestly oracle, King Saul determined to attack the camp. The attempt was completely successful, but involved no more than the camp and its stores; the Philistines themselves effected an unmolested retreat by the difficult road of Bethhoron.

**The ktoglein:** Saul was no mere raw stripling when he ascended the throne; he already had a grown-up son at his side. Nor was he of insignificant descent, the family to which he belonged being a widespread one, and his heritage considerable. His establishment at Gibeah was throughout his entire reign the nucleus of his kingdom. The men on whom he could always reckon were his Benjamite kinsmen. He recognized as belonging to him no other public function besides that of war; the internal affairs of the country he permitted to remain as they had been before his accession. War was at once the business and the resource of the new kingdom. It was carried on against the Philistines without interruption, though for the most part not in the grand style but rather in a series of border skirmishes.

**Samuel and Saul:** As regards the position of Samuel in the theocracy and the relation in which he stood to Saul, the several narratives in the book of Samuel differ widely. The preceding account, so far as it relates to Samuel, is based upon 1 Sam. ix., x. 1-16, xi., where he appears simply as a Rech at Ramah, and has nothing to do either with the administration of the theocracy or with the Nbiim. For a fuller treatment of the subject the reader is referred to Wellhausen's *Geschichte Israels* (1878), vol. i. pp. 256, 255, from which the following paragraphs may be quoted:

"Samuel is of less importance for history itself than he is for the history of tradition, in which the treatment which his figure received supplies us with some means of judging how far it can be trusted as a whole. Four stages of the tradition can be distinctly traced. Originally (ix. 1-x. 16) he is simply a seer, but at the same time a patriotic Israelite, who is touched to the heart by the extremities to which his country has been reduced, and who uses his authority as seer in order to impress upon the man whom he has perceived to be fit for the task the conviction that he has been called to be the helper and leader of Israel. Samuel's greatness consists in the fact of his having aroused into activity one who came after him and was greater than he; after he had kindled the light which burns so brightly, he is no longer seen. But his meteoric appearance and disappearance created a wondering admiration which led to the production of the narrative of his childhood, in which he already as a boy predicts the downfall of the Israel of the pre-monarchical period (1 Sam. i.-iii.). This done, he disappears into the darkness again; in chap. iv. *sqq.* we lose sight of him completely, and it is only as an old man that we encounter him once more.

"On the other hand the circumstance that after the meeting with Saul nothing more is heard of the seer gave countenance to the belief that a rupture between them must have taken place very soon. This belief we meet with in the second stage of the tradition, which is represented by the narratives recorded in chaps. xv and xviii. Its origin is to be sought in the inconsistency involved in the fact that Jehovah does not afterwards confirm on the throne him whom he has chosen to be king, but overthrows his dynasty. Thus it becomes necessary that Samuel, who had anointed Saul, should to his sorrow have laid upon him the duty of announcing his rejection. In this stage of the tradition he is represented no longer as a simple seer, but as a prophet after the style of Elijah and Elisha, who regards the Lord's anointed as a piece of his own handiwork, and lays his commands upon him (xv. 1), though, according to x. 7, he has expressly left him to be guided by his own inspirations.

"The transition from the second to the third stage is easy. Here Samuel transfers the unction, as soon as it has been withdrawn from Saul, to David, whom he sets up against his rejected predecessor as the *de jure* king by the grace of God. The respect with which he is regarded has meanwhile increased still further; the elders tremble before him (1 Sam. xvi. 4), and he possesses a magical power over men (ix. 18 *sqq.*).

"But hitherto he has invariably been represented as intellectually the author of the monarchy. It is reserved for the last (cxilian or post-cxilian) stage in the development of the tradition (1 Sam. vii., viii., x. 17 *sqq.*, xii., xiii. 7-15) to represent him on the contrary as one who resists to the utmost of his power the desire of the people to have a king. Premonarchical Israel is represented as a hierarchy and Samuel as its head; hence the feelings which he expresses.

"The modern judgment has been prejudiced in Saul's favour by Samuel's curse, and to David's disadvantage by Samuel's blessing; the truth has suffered less by the depreciation of the one than by the exaltation of the other. By critics Saul is honoured as the antagonist and David disparaged as the creature of that craving for ecclesiastical ascendancy of which they consider Samuel to have been the incarnation. In this estimate a degree of power as over against the kingship is attributed to the prophet which he cannot possibly have possessed unless he had firm ground to stand on and an organized power of influence throughout extensive circles. But he cannot be supposed to have found such support in the Nbiim, who were only then for the first time making their appearance under the influence of an epidemic inspiration which was not as yet restricted to any exclusive circle or school; and with whom, besides, according to the old tradition, intimate relations were held by the king and not by the seer (for the historical explanation of a familiar saying given in 1 Sam. xix. 13 *sqq.* is cancelled by the admittedly older passage in 1 Sam. x. 10 *sqq.*). Nor is it possible to hold that Samuel was in conspiracy with the priests against Saul. In support of such a theory indeed reliance is placed upon 1 Sam. xxi., xxii., where Ahimelech of Nob supplies bread to David in his flight, and expiates this offence with his own death and that of the whole house of Eli. But, in the first place, these priests have no visible connexion with Samuel; in the second, there is nothing to make it probable that they were in any league with David; thirdly, it is certain, on the other side of the argument, that as against the king they represented no distinct power in the state, but rather were entirely the creatures of his smile or frown, — on a faint suspicion they actually were annihilated without a single word of remonstrance being anywhere raised. Such a view of Samuel's relation to Saul and David as that which we have been discussing proceeds upon the radically erroneous assumption that Samuel had the hierarchy to rest on in his acts of opposition to the monarchy. But the student who carries the hierarchy back to those early times has still to learn the very elements of what is necessary to a true historical appreciation of Hebrew antiquity.

It is not without significance that the warlike revival of the nation proceeded from Benjamin. By the battle of

Tradition regarding Samuel



Aphek Ephraim had lost at once the hegemony and its symbols (the camp-sanctuary at Shiloh, the ark of the covenant). The centre of Israel gravitated southward, and Benjamin became the connecting link between Ephraim and Judah. It would appear that there the tyranny of the Philistines was not so much felt. Their attacks never were made through Judah, but always came from the north; on the other hand, people fled from them southwards, as is instanced by the priests of Shiloh, who settled in Nob near Jerusalem. Through Saul Judah entered definitely into the history of Israel; it belonged to his kingdom, and it more than most others supplied him with energetic and faithful supporters. His famous expedition against the Amalekites had been undertaken purely in the interests of Judah, for it only could possibly suffer from their marauding hordes.

Rise of  
Judah.

David.

Among the men of Judah whom the war brought to Gibeah, David ben Jesse of Bethlehem took a conspicuous place; his skill on the harp brought him into close relations with the king. He became Saul's armour-bearer, afterwards the most intimate friend of his son, finally the husband of his daughter. While he was thus winning the affections of the court, he at the same time became the declared favourite of the people, the more so because unexampled good fortune attended him in all he undertook. This excited the jealousy of Saul, naturally enough in an age in which the king always required to be the best man. Its first outburst admitted of explanation as occasioned by an attack of illness; but soon it became obtrusively clear that the king's love for his son-in-law had changed into bitter hatred. Jonathan warned his friend and facilitated his flight, the priests of Nob at the same time providing him with arms and food. He went into the wilderness of Judah, and became the leader of a miscellaneous band of outlaws who had been attracted by his name to lead a roving life under his leadership. His kinsmen from Bethlehem were of their number, but also Philistines and Hittites. Out of this band David's bodyguard subsequently grew, the nucleus of his army. They reckoned also a priest among them, Abiathar ben Ahimelech ben Ahitub ben Phinehas ben Eli, the solitary survivor of the massacre of the sons of Eli at Nob which Saul had ordered on account of suspected conspiracy with David. Through him David was able to have recourse to the sacred lot before the ephod. In the end he found it impossible to hold his own in Judah against Saul's persecutions, especially as his countrymen for the most part withheld their assistance. He therefore took the desperate step of placing his services at the disposal of Achish the Philistine king of Gath, by whom he was received with open arms, the town of Ziklag being assigned him as a residence. Here with his band he continued to follow his old manner of life as an independent prince, subject only to an obligation to render military service to Achish.

Meanwhile the Philistines had once more mustered their forces and marched by the usual route against Israel. Saul did not allow them to advance upon Gibeah, but awaited their attack in the plain of Jezreel. A disastrous battle on Mount Gilboa ensued; after seeing his three eldest sons fall one after another at his side, Saul threw himself upon his sword, and was followed by his armour-bearer. The defeat seemed to have undone the work of his life. The immediate consequence at least was that the Philistines regained their lost ascendancy over the country to the west of Jordan. Beyond Jordan, however, Abner, the cousin and generalissimo of Saul, made his son Ishbaal, still a minor, king in Mahanaim, and he was successful in again establishing the dominion of the house of Jezreel, Ephraim, and Benjamin, of course in uninterrupted struggle with the Philistines.

Battle of  
Gilboa.

But he did not regain hold of Judah. David seized the opportunity to set up for himself, with the sanction of the Philistines, and, it may safely be presumed, as their vassal, a separate principality which had its centre of gravity in the south, which was inhabited, not by the tribe of Judah properly so called, but by the Calebites and Jerahmeelites. This territory Abner disputed with him in vain. In the protracted feud between the houses of Saul and David, the fortunes of war declared themselves ever increasingly for the latter. Personal causes at last brought matters to a crisis. Abner, by taking to himself a concubine of Saul's, called Rizpah, had roused Ishbaal's suspicions that he was aiming at the inheritance, and was challenged on the point. This proved too much for his patience, and forthwith he abandoned the cause of his ward (the hopelessness of which had already perhaps become apparent), and entered into negotiations with David at Hebron. When about to set out on his return he fell by the hand of Joab in the gate of Hebron, a victim of jealousy and blood-feud. His plans nevertheless were realized. His death left Israel leaderless and in great confusion; Ishbaal was personally insignificant, and the people's homage continued to be rendered to him only out of grateful fidelity to his father's memory. At this juncture he also fell by assassins' hands. As he was taking his midday rest, and even the portress had gone to sleep over her task of cleaning wheat, two Benjamite captains introduced themselves into his palace at Mahanaim and murdered him in the vain hope of earning David's thanks. The elders of Israel no longer hesitated about offering David the crown, which he accepted.

His residence was immediately transferred from Hebron to Jebus, which until then had remained in possession of the Canaanites, and first derives historical importance from him. It lay on the border between Israel and Judah,—still within the territory of Benjamin, but not far from Bethlehem; near also to Nob, the old priestly city. David made it not only the political but also the religious metropolis by transferring thither from Kirjathjearim the ark of the covenant, which he placed within his citadel on what afterwards became the temple hill.

Still the crown was far from being a merely honorary possession; it involved heavy responsibilities, and doubtless what contributed more than anything else to David's elevation to the throne was the general recognition of the fact that he was the man best fitted on the whole to undertake the labour it brought with it, viz., the prosecution of the war with the Philistines, a war which was as it were the forge in which the kingdom of Israel was welded into one. The struggle began with the transference of the seat of royalty to Jerusalem; unfortunately we possess only scanty details as to its progress, hardly anything more indeed than a few anecdotes about deeds of prowess by individual heroes. The result was in the end that David completed what Saul had begun, and broke for ever the Philistine yoke. This was undoubtedly the greatest achievement of his reign.

From the defensive against the Philistines David proceeded to aggressive war, in which he subjugated the three kinsfolk of Israel, Moab, Ammon, and Edom. He appears to have come into conflict first with the Moabites, whom he vanquished and treated with savage atrocity. Not long afterwards the king of Ammon died, and David sent an embassy of condolence to Hanun his successor. Hanun suspected in this a sinister design,—a suspicion we can readily understand if David had already, as is probable, subjugated Moab,—and with the utmost contumely sent back the messengers to their master forthwith, at the same time making preparations for war by entering into alliance with various Syrian kings, and particularly with the power-

ful king of Soba.<sup>1</sup> David took the initiative, and sent his army under command of Joab against Rabbath-Ammon. The Syrians advanced to the relief of the besieged city; but Joab divided his forces, and, leaving his brother Abishai to hold the Ammonites in the town in check, proceeded himself against the Syrians and repulsed them. On their afterwards threatening to renew the attack in increased force, David went against them in strength and defeated them at Helam "on the river." It seems that as a result of this the kingdom of Soba was broken up and made tributary to Damascus. Rabbath-Ammon could not now hold out any longer, and the Ammonites shared the fate of their Moabite brethren. Finally, Edom was about the same time coerced and depopulated; and thus was fulfilled the vision of Balaam,—the youngest of the four Hebrew nationalities trod the three elder under his feet.

**Domestic troubles.** So far as external foes were concerned, David henceforward had peace; but new dangers arose at home within his own family. At once by ill-judged leniency and equally ill-timed severity he had completely alienated his son Absalom, who, after Ammon's death, was heir-apparent to the throne. Absalom organized a revolt against his father, and to foster it availed himself of a misunderstanding which had arisen between David and the men of Judah, probably because they thought they were not treated with sufficient favour. The revolt had its focus in Hebron; Ahithophel, a man of Judah, was its soul; Amasa, also of Judah, its arm; but the rest of Israel was also drawn into the rebellion, and only the territory to the east of Jordan remained faithful. Thither David betook himself with precipitancy, for the outbreak had taken him completely by surprise. At Mahanaim, which had once before been the centre from which the kingdom was regained, he collected his faithful followers around him with his 600 Cherethites and Pelethites for a nucleus, Absalom against Ahithophel's advice allowing him time for this. In the neighbourhood of Mahanaim, in the wood of Ephraim, the decisive blow was struck. Absalom fell, and with his death the rebellion was at an end. It was Joseph that, in the first instance, penitently sent a deputation to the king to bring him back. Judah on the other hand continued to hold aloof. Ultimately a piece of finesse on the king's part had the effect of bringing Judah also to its allegiance, though at the cost of kindling such jealousy between Israel and Judah that Sheba the Benjamite raised a new revolt, this time of Israelites, which was soon, however, repressed by Joab.

**Estimate of David.** David seems to have died soon afterwards. His historical importance is very great. Judah and Jerusalem were wholly his creation, and, though the united kingdom of Israel founded by him and Saul together soon fell to pieces, the recollection of it nevertheless continued in all time to be proudly cherished by the whole body of the people. His personal character has been often treated with undue disparagement. For this we must chiefly blame his canonization by the later Jewish tradition which made a Levitical saint of him and a pious hymn-writer. It then becomes a strange inconsistency that he caused military prisoners to be sawn asunder and burnt, and the bastard sons of Saul to be hanged up before the Lord in Gibeon. But if we take him as we find him, an antique king in a barbarous age, our judgment of him will be much more favourable. The most daring courage was combined in him with tender susceptibility; even after he had ascended the throne he continued to retain the charm of a pre-eminent and at the same time childlike personality. Even his conduct in the

affair of Uriah is not by any means wholly to his discredit: not many kings can be mentioned who would have shown repentance public and deep such as he manifested at Nathan's rebuke. Least to his credit was his weakness in relation to his sons and to Joab. On the other hand, the testament attributed to him in 1 Kings ii. cannot be justly laid to his charge; it is the libel of a later hand seeking to invest him with a fictitious glory. In like manner it is unjust to hold him responsible for the deaths of Abner and Amasa, or to attribute to him any conspiracy with the hierocracy for the destruction of Saul, and thus to deprive him of the authorship of the elegy in 2 Sam. i., which certainly was not the work of a hypocrite.

Solomon had already reached the throne, some time before his father's death,—not in virtue of hereditary right, but by a palace intrigue which had the support of the body-guard of the Six Hundred.<sup>2</sup> His glory was not purchased on the battlefield. So far was he from showing military capacity that he allowed a new Syrian kingdom to arise at Damascus, a far more dangerous thing for Israel than that of Soba which had been destroyed, and which it succeeded. During this reign Edom also regained its independence, nothing but the port of Elath remaining in Solomon's hands. As regards Moab and Ammon we have no information; it is not improbable that they also revolted. But if war was not Solomon's forte he certainly took much greater pains than either of his predecessors in matters of internal administration; according to tradition, the wisdom of the ruler and the judge was his special "gift." Disregarding the tribal system, he divided his kingdom into twelve provinces, over each of which he placed a royal governor, thus making a beginning of vigorous and orderly administration.<sup>2</sup>

Judah alone he exempted from this arrangement, as if to show special favour. For his aim was less the advantage of his subjects than the benefit of his exchequer, and the same object appears in his horse traffic (1 Kings ix. 19), his Ophir trade (1 Kings x. 11), and his cession of territory to Hiram (1 Kings ix. 11). His passions were architecture, a gorgeous court, and the harem, in which he sought to rival other Oriental kings, as for example his Egyptian father-in-law. For this he required copious means—forced labour, tribute in kind, and money. He had specially at heart the extension and improvement of Jerusalem as a strong and splendid capital; the temple which he built was only a portion of his vast citadel, which included within its precincts a number of private and public buildings designed for various uses.

It is plain that new currents were introduced into the stream of the nation's development by such a king as this. As formerly, after the occupation, Canaanite culture had come in, so now, after the establishment of the kingdom, the floodgate was opened for the admission of Oriental civilization in a deeper and wider sense. Whatever the personal motives which led to it may have been, the results were very important, and by no means disadvantageous on the whole. On the basis of the former administration now introduced, stability and order could rest; Judah had no cause to regret its acceptance of this yoke. Closer intercourse with foreign lands widened the intellectual horizon of the people, and at the same time awakened it to a deeper sense of its own peculiar individuality. If Solomon imported Phœnician and Egyptian elements into the worship of Jehovah at his court temple, the rigid old Israelite indeed might naturally enough take offence (Ex. xx. 24-26), but the temple itself nevertheless ultimately acquired a great and positive importance for religion. It

<sup>1</sup> Soba appears to have been situated somewhat to the north of Damascus, and to have bordered on the west with Hamath. The Arameans were beginning even at that period to press westwards; the Hittites, Phœnicians, and Israelites had common interests against them. To the kingdom of Soba succeeded afterwards that of Damascus.

<sup>2</sup> Very possibly the Canaanites, whose complete absorption falls within this period, were an element that helped to loosen the bonds of tribal unity, and consolidate a state in its place.



need not be denied that mischievous consequences of various kinds slipped in along with the good. The king, moreover, can hardly be blamed for his conduct in erecting in the neighbourhood of Jerusalem altars to deities of Ammon and Egypt. For those altars remained undisturbed until the time of Josiah, although between Solomon and him there reigned more than one pious king who would certainly have destroyed them had he found them as offensive as did the author of Deuteronomy.

4. After the death of Solomon the discontent which had been aroused by his innovations, and especially by the rigour of his government, openly showed itself against his successor; and when Rehoboam curtly refused the demands which had been laid before him by an assembly of the elders at Shechem, they withdrew from their allegiance and summoned to be their king the Ephraimite Jeroboam ben Nebat, who already had made an abortive attempt at revolt from Solomon, and afterwards had taken refuge in Egypt. Only Judah and Jerusalem remained faithful to the house of David. Among the causes of the revolt of the ten tribes, jealousy of Judah must certainly be reckoned as one. The power of Joseph had been weakened by the Philistines, and by the establishment of the monarchy the centre of gravity had been shifted from the north where it naturally lay. But now it was restored to its old seat; for once more it was situated, not in Judah, but in Joseph. Monarchy itself, however, was not abolished by the revolting tribes, conclusively showing how unavoidable and how advantageous that institution was now felt to be; but at the same time they did not refrain from attempts to combine its advantages with those of anarchy, a folly which was ultimately the cause of their ruin. As for their departure from the Mosaic cultus observed at Jerusalem on the other hand, it was first alleged against them as a sin only by the later Jews. At the time religion put no obstacle in the way of their separation; on the contrary, it actually suggested and promoted it (Ahijah of Shiloh). The Jerusalem cultus had not yet come to be regarded as the alone legitimate; that instituted by Jeroboam at Bethel and at Dan was recognized as equally right; images of the Deity were exhibited in all three places, and indeed in every place where a house of God was found. So far as the religious and intellectual life of the nation was concerned, there was no substantial difference between the two kingdoms, except indeed in so far as new displays of vigorous initiative generally proceeded from Israel.<sup>1</sup>

Rehoboam did not readily accept the situation; he sought to reduce the revolt by force of arms, with what degree of success is shown by the fact that his rival found himself constrained to take up his residence at Peniel (near Mahanaim) on the other side of Jordan. The invasion of Shishak, however, who took Jerusalem and burnt it, gave Jeroboam at last a breathing space. The feud continued indeed, but Rehoboam could no longer dream of bringing back the ten tribes. The scale by and by turned in Israel's favour. King Baasha, who had seated himself on the throne in place of Nadab, Jeroboam's son, took the offensive, and Asa ben Rehoboam had no help for it but to call in Benhadad of Damascus against his adversary. In this way he gained his immediate purpose, it is true, but by the most dangerous of expedients.

Baasha's son Elah was supplanted by his vizier Zimri, who, however, was in his turn unable to hold his own against Omri, who had supreme command of the army.

Against Omri there arose in another part of the country a rival, Tibni ben Ginath, who succeeded in maintaining some footing until his death, when Omri became supreme. Omri must be regarded as the founder of the first dynasty, in the proper sense of that word, in Israel, and as the second founder of the kingdom itself, to which he gave a permanent capital in Samaria. The Bible has hardly anything to tell us about him, but his importance is evident from the fact that among the Assyrians "the kingdom of Omri" was the ordinary name of Israel. According to the inscription of Meaba, it was he who again subjugated Moab, which had become independent at the death of David or of Solomon. He was not so successful against the Damascenes, to whom he had to concede certain privileges in his own capital (1 Kings xx. 34).<sup>2</sup>

Ahab, who succeeded Omri his father, seems during the greater part of his reign to have in some sort acknowledged Syrian suzerainty. In no other way can we account for the fact that in the battle of Karkar against the Assyrians (854 B.C.) a contingent was contributed by him. But this very battle made the political situation so clear that he was led to break off his relations with Damascus. With this began a series of ferocious attacks on Israel by Benhadad and Hazael. They were met by Ahab with courage and success, but in the third year of that fifty years' war he fell in the battle at Ramoth Gilead (c. 851).

After the events recorded in 1 Kings xx., a forced alliance with Damascus on the part of Samaria is incredible; but the idea of a spontaneous friendly relations is also inadmissible. Schrader indeed finds support for the latter theory in 1 Kings xx. 34; but in that passage there is no word of any offensive or defensive alliance between the rival kings; all that is stated is that Ahab releases the captive Benhadad on condition (בכרית) that the latter undertakes certain obligations, particularly those of keeping the peace and restoring the cities which had been taken. By this arrangement no change was made in the previously strained relations of the two kingdoms; and, moreover, the ברית was not kept (xxii. 1 sqq.). Not much nearer the truth than the preceding is the view that the danger threatened by Assyria drove the kings of Syria and Palestine into one another's arms, and so occasioned an alliance between Ahab and Benhadad also. For if feelings of hostility existed at all between the two last named, then Ahab could not do otherwise than congratulate himself that in the person of Shalmaneser II. there had arisen against Benhadad an enemy who would be able to keep him effectually in check. That Shalmaneser might prove dangerous to himself probably did not at that time occur to him; but if it had he would still have chosen the remote in preference to the immediately threatening evil. For it was the political existence of Israel that was at stake in the struggle with Damascus; in such circumstances every ally would of course be welcome, every enemy of the enemy would be hailed as a friend, and the political wisdom which Max Duncker attributes to Ahab would have been nothing less than unpardonable folly. The state of matters was at the outset in this respect just what it continued to be throughout the subsequent course of events; the Assyrian danger grew in subsequent years, and with it grew the hostility between Damascus and Samaria. This fact admits only of one explanation,—that the Israelites utilized to the utmost of their power for their own protection against the Syrians the difficulties into which the latter were thrown by Shalmaneser II., and that these in their turn, when the Assyrians gave them respite, were all the fiercer in their revenge. On the evidence of the monuments and the Bible we may even venture to assert that it was the Assyrian attacks upon Damascus which at that time preserved Israel from becoming Aramaic,—of course only because Israel made the most of them for her political advantage.

Assuming that Ahab the Israelite (Ahabu Sirlsai) fought in the battle of Karkar (854) on the side of the king of Damascus, it was only because he could not help himself; but, if it is actually the case that he did so, the battle of Karkar must have taken place before the events recorded in 1 Kings xx.

The Moabites took advantage of an accession under such critical circumstances to shake off the yoke imposed by

<sup>2</sup> Bit Hamri, like *oikos Avaxiavov*, and similar territorial names in Syrian.

<sup>3</sup> Omri's accession is to be placed somewhere about 900 B.C. It is a date, and the first, that can be determined with some precision, if we place the battle of Karkar (854) near the end of Ahab's reign, and take the servitude of Moab, which lasted forty years and ended with Ahab's death, to begin in Omri's first decade.

<sup>1</sup> Even in the Deuteronomic redaction of the book of Kings indeed, and still more by the Chronicler, the political rebellion of Israel is regarded as having been ecclesiastical and religious in its character. The book of Chronicles regards Samaria as a beaten kingdom, and recognizes Judah alone as Israel. But, in point of fact, Judah takes up the history of Israel only after the fall of Samaria; see §§ 6, 7.

Re 460-  
ad

Re 460  
the ten  
tribes.

Omri.

Foreign  
relations  
of the  
house of  
Omri.

Omri forty years before; an accurate account of their success, obviously written while the impression of it was still fresh,<sup>1</sup> has come down to us in the famous inscription of King Mesha. Ahaziah, Ahab's immediate successor, was obliged to accept the situation; after his early death a futile attempt again to subjugate them was made by his brother Joram. Such a campaign was possible to him only in the event of the Syrians keeping quiet, and in point of fact it would appear that they were not in a position to follow up the advantage they had gained at Ramoth; doubtless they were hampered by the inroads of the Assyrians in 850 and 849. As soon as they got a little respite, however, they lost no time in attacking Joram, driving him into his capital, where they besieged him. Samaria had already been brought to the utmost extremities of famine, when suddenly the enemy raised the siege on account of a report of an invasion of their own land by the "Egyptians and Hittites." Possibly we ought to understand by these the Assyrians rather, who in 846 renewed their attacks upon Syria; to ordinary people in Israel the Assyrians were an unknown quantity, for which it would be natural in popular story to substitute something more familiar. This turn of affairs relieved Joram from his straits; it would even seem that, favoured by a change of dynasty at Damascus, he had succeeded in taking from the Syrians the fortress of Ramoth in Gilead, which had been the object of Ahab's unsuccessful endeavours, when suddenly there burst upon the house of Omri the overwhelming catastrophe for which the prophets had long been preparing.

The prophets. When the prophets first made their appearance, some time before the beginning of the Philistine war, they were a novel phenomenon in Israel; but in the interval they had become so naturalized that they now had a recognized and essential place in connexion with the religion of Jehovah. They had in the process divested themselves of much that had originally characterized them, but they still retained their habit of appearing in companies and living together in societies, and also that of wearing a peculiar distinctive dress. These societies of theirs had no ulterior aims; the rabbinical notion that they were schools and academies in which the study of the Torah and of sacred history was pursued imports later ideas into an earlier time. First-rate importance on the whole cannot be claimed for the Nebim, but occasionally there arose amongst them a man in whom the spirit which was cultivated within their circles may be said to have risen to the explosive pitch. Historical influence was exercised at no time save by these individuals, who rose above their order and even placed themselves in opposition to it, but always at the same time had their base of operations within it. The prototype of this class of exceptional prophets, whom we not unjustly have been accustomed to regard as the true, is Elijah of Thisbe, the contemporary of Ahab.

Elijah  
and /  
Ahab.

In compliment to Jezebel his wife, Ahab had set up in Samaria a temple with richly endowed religious services in honour of the Syrian Baal. In doing so he had no intention of renouncing Jehovah; Jehovah continued to be the national God after whom he named his sons Ahaziah and Jehoram. The destruction of Jehovah's altars or the persecution of His prophets was not at all proposed, or even the introduction of a foreign cultus elsewhere than in Samaria. Jehovah's sovereignty over Israel being thus only remotely if at all imperilled, the popular faith found nothing specially offensive in a course of action which had been followed a hundred years before by Solomon also. Elijah alone was strenuous in his opposition; the masses did not understand him, and were far from taking his side.

<sup>1</sup> It is obvious that Mesha's narrative is to be taken with 2 Kings i. 1, and not with 2 Kings iii.

To him only, but not to the nation, did it seem like a halting between two opinions, an irreconcilable inconsistency, that Jehovah should be worshipped as Israel's God and a chapel to Baal should at the same time be erected in Israel.

In solitary grandeur did this prophet tower conspicuously over his time; legend, and not history, could alone preserve the memory of his figure. There remains a vague impression that with him the development of Israel's conception of Jehovah entered upon a new stadium, rather than any data from which it can be ascertained wherein the contrast of the new with the old lay. After Jehovah, acting more immediately within the political sphere, had established the nation and kingdom, he now began in the spiritual sphere to operate against the foreign elements, the infusion of which previously had been permitted to go on almost unchecked.<sup>2</sup> The Rechabites, who arose at that time, protested in their zeal for Jehovah altogether against all civilization which presupposes agriculture, and in their fundamental principles aimed at a recurrence to the primitive nomadic life of Israel in the wilderness; the Nazirite abstained at least from wine, the chief symbol of Dionysiac civilization. In this indeed Elijah was not with them; had he been so, he would doubtless have been intelligible to the masses. But, comprehending as he did the spirit from which these demonstrations proceeded, he thought of Jehovah as a great principle which cannot coexist in the same heart with Baal. To him first was it revealed that we have not in the various departments of nature a variety of forces worthy of our worship, but that there exists over all but one Holy One and one Mighty One, who reveals Himself not in nature but in law and righteousness in the world of man. The indignation he displayed against the judicial murder at Jezreel was as genuine and strong as that which he manifested against the worship of Baal in Samaria; the one was as much a crime against Jehovah as the other.

Elijah  
and the  
people.

Elijah ascended to heaven before he had actually achieved much in the world. The idea which his successors took from him was that it was necessary to make a thorough clearance from Samaria of the Baal worship and of the house of Ahab as well. For this practical end Elisha made use of practical means. When Elijah, after the murder of Naboth, had suddenly appeared before Ahab and threatened him with a violent end, an officer of high command had been present, Jehu ben Nimshi, and he had never forgotten the incident. He now found himself at the head of the troops at Ramoth Gilead after the withdrawal to Jezreel of Joram ben Ahab from the field to be healed of his wound. To Elisha the moment seemed a suitable one for giving to Jehu in Jehovah's name the command now to carry out Elijah's threat against the house of Ahab. Jehu gained over the captains of the army, and carried out so well the task with which the prophet had commissioned him that not a single survivor of Ahab's dynasty or of his court was left. He next extirpated Baal and his worshippers in Samaria. From that date no worship of foreign gods seems ever to have recurred in Israel. Idolatry indeed continued to subsist, but the images, stones, and trees, even the teraphim apparently, belonged to the cultus of Jehovah, or were at least brought into relation with it.

Jehu founded the second and last dynasty of the kingdom of Samaria. His inheritance from the house of Omri included the task of defending himself against the Syrians. The forces at his disposal being insufficient for this, he resorted to the expedient of seeking to urge the Assyrians

<sup>2</sup> It is worth noticing how much more frequent from this period onwards proper names compounded with the word Jehovah became. During the period of the judges, and under the kings before Ahab in Israel and Asa in Judah, not a single instance occurs; thenceforward they become the rule.



to renew their hostilities against the Aramæans. For this end his ambassadors carried presents to Shalmaneser II.; these were not of a regular but only of an occasional character, but the vanity of the great king represents them as the tribute of a vassal. In the years 842 and 839 Assyrian campaigns against Hazael of Damascus actually took place; then they were intermitted for a long time, and the kings of Samaria, Jehu and his two successors, were left to their own resources. These were evil times for Israel. With a barbarity never intermitted the frontier war went on in Gilead, where Ammon and Moab showed themselves friendly to the Syrian cause (Amos i.); occasionally great expeditions took place, one of which brought King Hazael to the very walls of Jerusalem. It was only with the greatest difficulty that Israel's independence was maintained. Once more religion went hand in hand with the national cause; the prophet Elisha was the main stay of the kings in the struggle with the Syrians, "the chariot and horsemen of Israel." Joash ben Joahaz ben Jehu at last succeeded in inflicting upon Syria several blows which proved decisive. Thenceforward Israel had nothing to fear from that quarter. Under Joash's son, Jeroboam II., the kingdom even reached a height of external power which recalled the times of David. Moab was again subdued; southwards the frontier extended to the brook of the wilderness (Amos vi. 14), and northward to Hamath.

5. Before proceeding to consider the rise of those prophets who were the makers of the new Israel, it will not be out of place here to cast a glance backwards upon the old order of things which perished with the kingdom of Samaria. With reference to any period earlier than the century 850-750 B.C., we can hardly be said to possess any statistics. For, while the facts of history admit of being handed down with tolerable accuracy through a considerable time, a contemporary literature is indispensable for the description of standing conditions. But it was within this period that Hebrew literature first flourished—after the Syrians had been finally repulsed, it would seem. Writing of course had been practised from a much earlier period, but only in formal instruments, mainly upon stone. At an early period also the historical sense of the people developed itself in connexion with their religion; but it found its expression in songs, which in the first instance were handed down by word of mouth only. Literature began with the collection and writing out of those songs; the *Book of the Wars of the Lord* and the *Book of Jasher* were the oldest historical books. The transition was next made to the writing of prose history with the aid of legal documents and family reminiscences; a large portion of this early historiography has been preserved to us in the books of Judges, Samuel, and Kings. Contemporaneously also certain collections of laws and decisions of the priests, of which we have an example in Ex. xxi., xxii., were committed to writing. Somewhat later, perhaps, the legends about the patriarchs and primitive times, the origin of which cannot be assigned to a very-early date,<sup>1</sup> received literary shape. Specially remarkable is the rise of a written prophecy. The question why it was that Elijah and Elisha committed nothing to writing, while Amos a hundred years later is an author, hardly admits of any other answer than that in the interval a non-literary had developed into a literary age. How rapid the process was may be gathered from a comparison between the singularly broken utterances

<sup>1</sup> Even the Jehovistic narratives about the patriarchs belong to the time when Israel had already become a powerful kingdom; Moab, Ammon, and Edom had been subjugated (Gen. xxvii. 29), and vigorous frontier wars were being carried on with the Syrians about Gilead (Gen. xxxi. 52). In Gen. xxvii. 40 allusion is made to the constantly repeated subjugations of Edom by Judah, alternating with successful revolts on the part of the former; see Delitzsch on עֲדוֹם.

of the earlier oracle contained in Isa. xv., xvi. with the orations of Isaiah himself.

We begin our survey with that of the family relations. Social Polygamy was rare, monogamy the rule; but the right of life. concubinage was unlimited. While a high position was accorded both by affection and custom to the married wife, traces still existed of a state of society in which she was regarded as property that went with the inheritance. The marriage of relations was by no means prohibited; no offence was taken at the circumstance that Abraham was the husband of his sister (by a different mother). Parents had full power over their children; they had the right to sell and even to sacrifice them. In this respect, however, the prevailing usage was mild, as also in regard to slaves, who socially held a position of comparative equality with their masters, and even enjoyed some measure of legal protection. Slavery, it is plain, had not the same political importance as with the Greeks and Romans; it could have been abolished without any shock to the foundations of the state.

Throughout this period agriculture and gardening continued to be regarded as man's normal calling (Gen. iii., iv.), the laws contained in Ex. xxi.-xxiii. rest entirely upon this assumption. To dwell in peace under his vine and under his fig tree was the ideal of every genuine Israelite. Only in a few isolated districts, as in the country to the east of Jordan and in portions of Judah, did the pastoral life predominate. Art and industry were undeveloped, and were confined to the production of simple domestic necessities.

Commerce was in old time followed exclusively by the Canaanite towns, so that the word "Canaanite" (like "Jew" in German) was used in the sense of "trader." But by and by Israel began to tread in Canaan's footsteps (Hos. xii. 8, 9).<sup>2</sup> The towns grew more influential than the country; money notably increased; and the zeal of piety was quite unable to arrest the progress of the change which set in. The kings themselves, from Solomon onwards, were the first to set the bad example; they eagerly sought to acquire suitable harbours, and in company or in competition with the Syrians entered upon large commercial transactions. The extortions of the corn-market, the formation of large estates, the frequency of mortgages, all show that the small peasant proprietorship was unable to hold its own against the accumulations of wealth. The wage-receiving class increased, and cases in which free Hebrews sold themselves into slavery were not rare.

On all hands the material progress of the commonwealth made itself felt, the old simplicity of manners disappeared, and luxury increased. Buildings of hewn stone began to be used even by private individuals. The towns, especially the chief ones, were fortified; and in time of war refuge was sought in them, and not as formerly in woods and caves. Even in the time of David the Israelites always fought on foot; but now horses and chariots were regarded as indispensable. The bow came to be the principal weapon of offence, and a military class appears to have sprung up.

The monarchy retained in the kingdom of the ten tribes its military character; the commander-in-chief was the first person in the kingdom. In internal affairs its interference was slight; with systematic despotism it had little in common, although of course within its narrow sphere it united executive and legislative functions. It was little more than the greatest house in Israel. The highest official was called "master of the household." The court ultimately

<sup>2</sup> "Canaan (i.e., Ephraim Canaanized) has deceitful balances in his hand, and loves to overreach. Ephraim indeed saith, I am become rich, I have gained wealth; but all his profits will not suffice for (expiation of) the guilt which he has incurred."

His suc-  
cessors

Early  
Hebrew  
litera-  
ture.

Agriculture.

Trade

Material progress

Government

grew into a capital, the municipal offices of which were held by royal officials. The provinces had governors who, however, in time of war withdrew to the capital (1 Kings xx); the presumption is that their sole charge was collection of the revenue.

The state was not charged with affairs of internal administration; all parties were left free to maintain their own interests. Only in cases in which conflicts had emerged in consequence could the king be approached. Ruling and judging were regarded as one and the same; there was but one word for both (2 Kings xv. 5). Still, the king was not altogether the only judge; there were in fact a number of independent jurisdictions. Wherever within a particular circle the power lay, there the right of judging was also found, whether exercised by heads of families and communities or by warriors and powerful lords. It was only because the king was the most powerful that he was regarded as the judge of last resort; but it was equally permitted to apply to him from the first. Of method and rule in these things there was but little; a man was glad to find any court to receive his complaint. Of course without complaint one got no justice. The administration of justice was at best but a scanty supplement to the practice of self-help. The heir of the murdered man would not forego the right of blood revenge; but his family or the commune gave him aid, and in case of need took his place, for bloodshed had at all hazards to be atoned for.

The firm establishment of civil order was rendered all the more difficult by the continual wars and violent changes of dynasty which ever and anon made its very existence problematical. Power, which is more important than righteousness to a judicatory, was what the government was wanting in. In the simpler social conditions of the earlier time a state which was adapted merely for purposes of war might easily be found to work satisfactorily enough, but a more complex order of things had now arisen. Social problems had begun to crop up; for the poor and the proletariat the protection of a thoughtful government had come to be required, but was not forthcoming.

But these defects did not check all progress. The weakness of the government, the want of political consolidation, were insufficient to arrest intellectual advance or to corrupt the prevailing moral tone and feeling for justice; in fact it was precisely in this period (the period in which the main part of the Jehovistic history must have been written) that the intellectual and moral culture of the people stood at its highest. Even when the machinery of the monarchy had got out of order, the organization of the families and communes continued to subsist; the smaller circles of social life remained comparatively untouched by the catastrophes that shook the greater. Above all, the national religion supplied the spiritual life with an immovable basis.

The favourite illustrations of the power of religion in the Israel of that period are drawn from the instances of great prophets who raised kings out of the dust and smote them to it again. But the influence and importance of these is generally exaggerated in the accounts we have. That among them there occasionally occurred manifestations of such power as to give a new turn to history is indeed true; a figure like that of Elijah is no mere invention. But such a man as he was a prophecy of the future rather than an actual agent in shaping the present. On the whole, religion was a peaceful influence, conserving rather than assailing the existing order of things. The majority of the prophets were no revolutionists; rather in fact were they always too much inclined to prophesy in accordance with the wishes of the party in power. Besides, in ordinary circumstances their influence was inferior to that of

the priests, who were servants of royalty at the chief sanctuaries, but everywhere attached to the established order.

The Torah of Jehovah still continued to be their special charge. It was not even now a code or law in our sense of the word; Jehovah had not yet made His Testament; He still was living and active in Israel. But the Torah appears during this period to have withdrawn itself somewhat from the business of merely pronouncing legal decisions, and to have begun to move in a freer field. It now consisted in teaching the knowledge of God, in showing the right, God-given way where men were not sure of themselves. Many of the counsels of the priests had become a common stock of moral convictions, which indeed were all of them referred to Jehovah as their author, yet had ceased to be matters of direct revelation. Nevertheless the Torah had still occupation enough, the progressive life of the nation ever affording matter for new questions.

Although in truth the Torah and the moral influence of Jehovah upon the national life were things much weightier and much more genuinely Israelitic than the cultus, yet this latter held on the whole a higher place in public opinion. To the ordinary man it was not moral but liturgical acts that seemed to be truly religious. Altars of Jehovah occurred everywhere, with sacred stones and trees—the latter either artificial (Asheras) or natural—beside them; it was considered desirable also to have water in the neighbourhood (brazen sea). In cases where a temple stood before the altar it contained an ephod and teraphim, a kind of images before which the lot was cast by the priest. Of the old simplicity the cultus retained nothing; at the great sanctuaries especially (Bethel, Gilgal, Beersheba) it had become very elaborate. Its chief seasons were the agricultural festivals—the passover, the feast of weeks, and most especially the feast of the ingathering at the close of the year. These were the only occasions of public worship properly so called, at which every one was expected to attend; in other cases each worshipper sought the presence of God only in special circumstances, as for example at the beginning and at the end of particular undertakings. The cultus, as to place, time, matter, and form, belonged almost entirely to the inheritance which Israel had received from Canaan; to distinguish what belonged to the worship of Jehovah from that which belonged to Baal was no easy matter.<sup>1</sup> It was the channel through which also paganism could and did ever anew gain admittance into the worship of Jehovah. Yet that publicity of the cultus which arose out of the very nature of Jehovah, and in consequence of which the teraphim even were removed from the houses to the temples, cannot but have acted as a corrective against the most fatal excesses.

As for the substance of the national faith, it was summed up principally in the proposition that Jehovah is the God of Israel. But "God" was equivalent to "helper"; that was the meaning of the word. "Help," assistance in all occasions of life,—that was what Israel looked for from Jehovah, not "salvation" in the theological sense. The forgiveness of sins was a matter of subordinate importance; it was involved in the "help," and was a matter not of faith but of experience. The relation between the people and God was a natural one as that of son to father; it did not rest upon observance of the conditions of a pact. But it was not on that account always equally lively and hearty; Jehovah was regarded as having varieties of mood. To secure and retain His favour, sacrifices were useful; by them prayer and thanksgiving were seconded.

<sup>1</sup> The description of the cultus by the prophet Hosea shows this very clearly. It is obvious enough, however, that the object was to serve Jehovah, and not any foreign deity, by this worship.



Another main article of faith was that Jehovah judges and recompenses, not after death (then all men were thought to be alike), but upon the earth. Here, however, but little account was taken of the individual; over him the wheel of destiny remorselessly rolled; his part was resignation, and not hope. Not in the career of the individual but in the fate of families and nations did the righteousness of Jehovah find scope for its manifestation; and this is the only reason why the religion could dispense with the conceptions of heaven and hell. For the rest, it was not always easy to bring the second article into correlation with the first; in practice the latter received the superior place.

It need hardly be said that superstition of every kind also abounded. But the superstition of the Israelites had as little real religious significance as had that poetical view of nature which the Hebrews doubtless shared in greater or less degree with all the other nations of antiquity.

6. Under King Jeroboam II, two years before a great earthquake that served ever after for a date to all who had experienced it, there occurred at Bethel, the greatest and most conspicuous sanctuary of Jehovah in Israel, a scene full of significance. The multitude were assembled there with gifts and offerings for the observance of a festival, when there stepped forward a man whose grim seriousness interrupted the joy of the feast. It was a Judæan, Amos of Tekoa, a shepherd from the wilderness bordering on the Dead Sea. Into the midst of the joyful tones of the songs which with harp and tabor were being sung at the sacred banquet he brought the discordant note of the mourner's wail. For over all the joyous stir of busy life his ear caught the sounds of death: "the virgin of Israel is fallen, never more to rise; lies prostrate in her own land with no one to lift her up." He prophesied as close at hand the downfall of the kingdom which just at that moment was rejoicing most in the consciousness of power, and the deportation of the people to a far-off northern land.

There was something rotten in the state of Israel in spite of the halcyon days it enjoyed under Jeroboam II. From the indirect results of war, from changes in the tenure and in the culture of the soil, from defective administration of justice, the humbler classes had much to suffer; they found that the times were evil. But it was not this that caused Amos to foresee the end of Israel, not a mere vague foreboding of evil that forced him to leave his flocks; the dark cloud that threatened on the horizon was plain enough—the Assyrians. Once already at an earlier date they had directed their course south-westwards, without, however, on that occasion becoming a source of danger to the Israelites. But now that the bulwark against the Assyrians, Aram of Damascus, was falling into ruins, a movement of these against Lebanon in the time of Jeroboam II. opened to Israel the alarming prospect that sooner or later they would have to meet the full force of the irresistible avalanche.

What then? The common man was in no position truly to estimate the danger; and, so far as he apprehended it, he lived in the firm faith that Jehovah would not abandon His people in their straits. The governing classes prided themselves on the military resources of Israel, or otherwise tried to dismiss from their minds all thought of the gravity of the situation. But Amos heard the question distinctly enough, and did not hesitate to answer it: the downfall of Israel is imminent. It was nothing short of blasphemy to utter anything of this kind, for everything, Jehovah Himself included, depended on the existence of the nation. But the most astounding thing has yet to come; not Asshur, but Jehovah Himself, is bringing about the overthrow of Israel through Asshur it is Jehovah that is

triumphing over Israel. A paradoxical thought—as if the national God were to cut the ground from under his own feet! For the faith in Jehovah as the God of Israel was a faith that He intervenes on behalf of His people against all enemies, against the whole world; precisely in times of danger was religion shown by staying oneself upon this faith. Jehovah might indeed, of course, hide His face for a time, but not definitively; in the end He ever arose at last against all opposing powers. "The day of the Lord" was an object of hope in all times of difficulty and oppression; it was understood as self-evident that the crisis would certainly end in favour of Israel. Amos took up the popular conception of that day; but how thoroughly did he change its meaning! "Woe to them who long for the day of the Lord!—What to you is the day of the Lord? It is darkness, not light." His own opposition to the popular conception is formulated in a paradox which he prefixes as theme to the principal section of his book:—"Us alone does Jehovah know," say the Israelites, drawing from this the inference that He is on their side, and of course must take their part. "You only do I know," Amos represents Jehovah as saying, "therefore do I visit upon you all your sins."

If the question, Whereon did Jehovah's relation to Israel ultimately rest? be asked, the answer, according to the popular faith, must substantially be that it rested on the fact that Jehovah was worshipped in Israel and not among the heathen, that in Israel were His altars and His dwelling. His cultus was the bond between Him and the nation; when therefore it was desired to draw the bond still closer, the solemn services of religion were redoubled. But to the conception of Amos Jehovah is no judge capable of accepting a bribe; with the utmost indignation he repudiates the notion that it is possible to influence Him by gifts and offerings. Though Israel alone has served Him he does not on that account apply any other standard to it than to other nations (chap. i., ii.). If Israel is better known to Him, it does not follow that on that account He shuts His eyes and blindly takes a side. Neither Jehovah nor His prophet recognizes two moral standards; right is everywhere right, wrong always wrong, even though committed against Israel's worst enemies (ii. 1). What Jehovah demands is righteousness,—nothing more and nothing less; what he hates is injustice. Sin or offence to the Deity is a thing of purely moral character; with such emphasis this doctrine had never before been heard. Morality is that for the sake of which all other things exist; it is the alone essential thing in the world. It is no postulate, no idea, but at once a necessity and a fact, the most intensely living of personal powers—Jehovah the God of Hosts. In wrath, in ruin, this holy reality makes its existence known: it annihilates all that is hollow and false.

Amos calls Jehovah the God of Hosts, never the God of Israel. The nation as such is no religious conception to him; from its mere existence he cannot formulate any article of faith. Sometimes it seems as if he were denying Israel's prerogative altogether. He does not really do so, but at least the prerogative is conditional and involves a heavy responsibility. The saying in iii. 2 recalls Luke xii. 47. The proposition "Jehovah knows Israel" is it the month of Amos almost the same thing as "Israel knows Jehovah"; save only that this is not to be regarded as any merit on Israel's part, but as a manifestation of the grace of Jehovah, who has led His people by great deeds and holy men, and so made Himself known. Amos knows no other truth than that practical one which he has found among his own people and nowhere else, lying at the foundation of life and morality, and which he regards as the product of a divine providential ordering of history.

Amos.

Lines  
reflects  
ver-  
brow of  
Israel by  
Jehovah

From this point of view, so thoroughly Israelitish, he pronounces Israel's condemnation. He starts from premisses generally conceded, but he accentuates them differently and draws from them divergent conclusions.

New  
phase of  
prophecy.

Amos was the founder, and the purest type, of a new phase of prophecy. The impending conflict of Asshur with Jehovah and Israel, the ultimate downfall of Israel, is its theme. Until that date there had subsisted in Palestine and Syria a number of petty kingdoms and nationalities, which had their friendships and enmities with one another, but paid no heed to anything outside their own immediate environment, and revolved, each on its own axis, careless of the outside world, until suddenly the Assyrians burst in upon them. These commenced the work which was carried on by the Babylonians, Persians, and Greeks, and completed by the Romans. They introduced a new factor, the conception of the world,—the world of course in the historical sense of that expression. In presence of that conception the petty nationalities lost their centre of gravity, brute fact dispelled their illusions, they flung their gods to the moles and to the bats (Isa. ii.). The prophets of Israel alone did not allow themselves to be taken by surprise by what had occurred, or to be plunged in despair; they solved by anticipation the grim problem which history set before them. They absorbed into their religion that conception of the world which was destroying the religions of the nations, even before it had been fully grasped by the secular consciousness. Where others saw only the ruin of everything that is holiest, they saw the triumph of Jehovah over delusion and error. Whatever else might be overthrown, the really worthy remained unshaken. They recognized ideal powers only, right and wrong, truth and falsehood; second causes were matters of indifference to them, they were no practical politicians. But they watched the course of events attentively, nay, with passionate interest. The present, which was passing before them, became to them as it were the plot of a divine drama which they watched with an intelligence that anticipated the dénouement. Everywhere the same goal of the development, everywhere the same laws. The nations are the *dramatis personæ*, Israel the hero, Jehovah the poet of the tragedy.<sup>1</sup>

Not  
"patri-  
otic."

The canonical prophets, the series of whom begins with Amos, were separated by an essential distinction from the class which had preceded them and which still continued to be the type of the common prophet. They did not seek to kindle either the enthusiasm or the fanaticism of the multitude; they swam not with but against the stream. They were not patriotic, at least in the ordinary acceptation of that word; they prophesied not good but evil for their people (Jer. xxviii. 8). Until their time the nation had sprung up out of the conception of Jehovah; now the conception of Jehovah was casting the nation into the shade. The natural bond between the two was severed, and the relation was henceforward viewed as conditional. As God of the righteousness which is the law of the whole universe, Jehovah could be Israel's God only in so far as in Israel the right was recognized and followed. The ethical element destroyed the national character of the old religion. It still addressed itself, to be sure, more to the nation and to society at large than to the individual; it insisted less upon a pure heart than upon righteous institutions; but nevertheless the first step towards universalism had been accomplished, towards at once the general diffusion and the individualization of religion. Thus, although the prophets were far from originating a new conception of God, they none the less were the founders of what has

been called "ethical monotheism." But with them this ethical monotheism was no product of the "self-evolution of dogma," but a progressive step which had been called forth simply by the course of events. The providence of God brought it about that this call came at an opportune period, and not too suddenly. The downfall of the nation did not take place until the truths and precepts of religion were already strong enough to be able to live on alone; to the prophets belongs the merit of having recognized the independence of these, and of having secured perpetuity to Israel by refusing to allow the conception of Jehovah to be involved in the ruin of the kingdom. They saved faith by destroying illusion.

The event which Amos had foreseen was not long in coming. The Israelites flew spontaneously, like "silly doves," into the net of the Assyrians. Zechariah ben Jeroboam was overthrown after a short reign, Shallum his murderer and successor was also unable to hold his own, and was followed after the horrors of a civil war by Menahem ben Gadi (745 B.C.). But Menahem, in the presence of domestic (and perhaps also foreign) assailants,<sup>2</sup> had no other resort than to purchase by payment of a great tribute the assistance of King Tiglath-pileser II., who at that time was giving new force to the Assyrian predominance in these regions. By such means he succeeded in attaining his immediate end, but the further consequence was that the rival party in the states turned for support to Egypt, and Palestine now became the arena of conflict between the two great world-powers.

Menahem transmitted his kingdom to Pekahiah; Pekahiah was murdered about 735 B.C. by Pekah, and Pekah himself shortly afterwards was overthrown. All this happened within a few years. It would have been possible to conjecture the state of the country in these circumstances, even if we had not been informed of it by means of the prophetic book of Hosea, which dates from the time when the Assyrians had begun indeed to tamper with the country, but had not yet shown their full design. After the death of Jeroboam II. there had been wild outbursts of partisan war; none of the kings who in quick succession appeared and disappeared had real power, none established order. It was as if the danger from without, which was only too obviously threatening the existence of the kingdom, had already dissolved all internal bonds; every one was at war with his neighbour. Assyrians and Egyptians were called in to support this or that government; by such expedients the internal confusion was, naturally, only increased. Was there any other quarter in which help could yet be sought? The people, led by the priests, turned to the altars of Jehovah, and outdid itself in pious works, as if by any such illusory means, out of all relation to the practical problem in hand, the gangrene of anarchy could possibly be healed. Still more zealous than Amos against the cultus was Hosea, not merely on the ground that it had the absurd motive of forcing Jehovah's

Hosea.

<sup>2</sup> It is not inconceivable that the wars carried on by Tiglath-pileser II. against Hamath had some connexion with his interventions in favour of Menahem. The kingdom of Hamath, which may have been threatened by Jeroboam II., may have availed itself of the state of matters which followed his death to secure its own aggrandizement at Israel's expense; in correspondence with this attack from the northern side another by Judah in concert with Hamath may well have been made from the south. In this way, though not without the aid of pure hypothesis, it might be possible to fit into the general historical connexion the fragmentary Assyrian notices about Azariah of Judah and his relations to Hamath; the explanations suggested by the Assyriologists have hitherto been total failures. But in that case it would certainly be necessary to assume that the Assyrians were badly informed as to the nature of the relations between Hamath and Judah, and also as to the individual who at that time held the throne of Judah. Uzziash (= Azariah), who in his old age had become a leper, could only nominally at best have been king of Judah then.

<sup>1</sup> In very much the same way the threatened and actual political annihilation of Ionia led to the rise of Greek philosophy (Xenophanes, Heraclitus).



favour, but also because it was of heathenish character, nature-worship and idolatry. That Jehovah is the true and only helper is certainly not denied by Hosea. But His help is coupled with the condition that Israel shall undergo a complete change, and of such a change he sees no prospect. On this account the downfall of the state is in Hosea's view inevitable, but not final ruin, only such an overthrow as is necessary for the transition to a new and fair recommencement. In Hosea's prophecies the relation between Jehovah and Israel is conceived of as dissoluble, and as actually on the point of being dissolved, but it has struck its roots so deep that it must inevitably at last establish itself again.

Collision  
with  
Assyria.

The first actual collision between Israel and Assyria occurred in 734. Resin, king of Damascus, and Pekah, king of Samaria, had united in an expedition against Judah, where at that time Ahaz ben Jotham occupied the throne. But Ahaz parried the blow by placing himself under the protection of the Assyrians, who perhaps would in any case have struck in against the alliance between Aram and Israel. Tiglath-pileser made his first appearance in 734, first on the sea-coast of Palestine, and subsequently either in this or in the following year took up his quarters in the kingdom of the ten tribes. After he had ravaged Galilee and Gilead, he finally concluded a peace in Samaria the capital, conditionally on his receiving the head of King Pekah and a considerable yearly tribute. Hosea ben Elah was raised to the throne in Pekah's place, and acknowledged by the Assyrian as a vassal. For some ten years he held his position quietly, regularly paying his dues. But when at the death of Tiglath-pileser the Syro-Palestinian kingdoms rebelled *en masse*, Samaria also was seized with the delirium of patriotic fanaticism (Isa. xxviii.). Relying upon the help of Seve, king of Ethiopia and Egypt, Hosea ventured on a revolt from Assyria. But the Egyptians left him in the lurch as soon as Shalmaneser IV., Tiglath-pileser's successor, invaded his territory. Before his capital had fallen, Hosea himself fell into the hands of the Assyrians. Samaria offered a desperate resistance, and succumbed only to Sargon, Shalmaneser's successor (721). Energetic measures were adopted by the victor for the pacification of the country; he carried all the inhabitants of mark into captivity to Calachene, Gozanitis, and Armenia. A remnant indeed of the ancient kingdom was still permitted to survive under kings who were mere vassals; it continued to subsist until the days of Esarhaddon, but the Scriptural representation, according to which the history of Israel terminates in 721, is substantially the most correct. Much light is thrown upon the conditions of the national religion then and upon its subsequent development by the single fact that the exiled Israelites were absorbed by the surrounding heathenism without leaving a trace behind them, while the population of Judah, who had the benefit of a hundred years' respite, held their faith fast throughout the period of the Babylonian exile, and by means of it were able to maintain their own individuality afterwards in all the circumstances that arose. The fact that the fall of Samaria did not hinder but helped the religion of Jehovah is entirely due to the prophets. That they had foreseen the downfall of the state, and declared in the name of religion that it was inevitable, was a matter of much greater historical importance than the actual downfall itself.

Fall of  
Samaria.

King-  
dom of  
Judah.

7. Hitherto the small kingdom of Judah had stood in the background. Its political history had been determined almost exclusively by its relation to Israel. Under the dynasty of Omri the original enmity had been changed into a close but perhaps not quite voluntary friendship. Judah found itself drawn completely into the train of the more powerful neighbouring state, and seems even to have

rendered it military service. The fall of the house of Omri was an ominous event for Judah as well as Israel; Jehu, as he passed to the throne, put to death not only Ahaziah, the king but also two and forty other members of the royal house of David who had fallen into his hands; and those who still survived, children for the most part, were murdered wholesale by the regent Athaliah for reasons that are unknown. Only one little boy, Joash, was concealed from her fury, and by a successful conspiracy six years afterwards was placed upon the throne of his ancestors. At that time the Syrians were extending their incursions to Judah and Philistia, and Joash bought them off from Jerusalem with the temple treasures. Perhaps it was this disgrace that he expiated with his death; in like manner perhaps the assassination of his successor Amaziah is to be accounted for by the discredit he had incurred by a reckless and unsuccessful war against Israel. Just as Israel was beginning to recover itself after the happy termination of the Syrian wars, Judah also experienced its period of highest prosperity. What Jeroboam II. was to the northern kingdom, Uzziah was to that of the south. He appears to have obtained possession of Edom, and for a considerable time to have held that one province of David's conquests which fell to Judah; and at the trading port of Elath he revived the commerce which Solomon had created. The prosperity of his long reign was uninterrupted till in his later years he was smitten with leprosy, and found it necessary to hand over the affairs of the kingdom to his son Jotham. But Jotham appears to have died about the same time as his father,—his successor, still in very early youth (Isa. iii. 12), being Ahaz ben Jotham ben Uzziah.

If Judah could not compare with Israel in political and general historical importance, it nevertheless enjoyed more than one considerable advantage over the larger kingdom. It was much safer from foreign foes; for the Egyptians, as a rule, were not dangerous neighbours. But its chief advantage consisted in the stability of its dynasty. It was David who had elevated Judah and Jerusalem to a position of historical significance, and the prosperity of his house was most intimately connected with that of the town and territory, and even with that of religion. On two separate occasions it occurred that a king of Judah was murdered by subjects, but in both cases the "people of the land" rose up against the assassins and once more placed a member of the Davidic family upon the throne. The one actual recorded revolution was that against Athaliah, which had for its object the restoration of the throne to the legitimate heir. Under shelter of the monarchy the other institutions of the state also acquired a measure of permanency such as was not found at all in Israel, where everything depended on the character of individuals, and the existing order of things was ever liable to be subjected to fresh dispute. Life in Judah was a much more stable affair, though not so exciting or dramatic. Possibly the greater isolation of the little kingdom, its more intimate relations with the neighbouring wilderness, and the more primitive modes of life which resulted were also factors which contributed to this general result.

In the capital of course the life was not primitive, and its influence was undoubtedly greater than that of the country. Successive kings exerted themselves for its external improvement, and in this respect Hezekiah ben Ahaz was specially distinguished. Above all they manifested sincere interest in the temple, which from an early period exerted a powerful force of attraction over the entire mass of the population. They regulated the cultus according to their individual tastes, added to it or curtailed it at their pleasure, and dealt with the sacred treasures as they chose. Although the priests had in a certain sense great power—the conspiracy against Athaliah was led not by a

Stability  
of its  
dynasty

The  
temple  
cultus.

prophet but by a priest,—they were nevertheless subjects of the king, and had to act according to his orders. That the cultus of Jehovah at Jerusalem was purer than that at Bethel or at Samaria is an assertion which is contradicted by more than one well-attested fact. In this respect there was no essential difference between Israel and Judah. It was in Israel that the reaction against Baal-worship originated which afterwards passed over into Judah; the initiative in all such matters was Israel's. There the experiments were made from which Jerusalem learned the lesson. How deep was the interest felt in the affairs of the larger kingdom by the inhabitants even of one of the smaller provincial towns of Judah is shown in the instance of Amos of Tekoah.

Isaiah.

Step by step with the decline of Israel after the death of Jehoram II. did Judah rise in importance; it was already preparing to take the inheritance. The man through whom the transition of the history from Israel to Judah was effected, and who was the means of securing for the latter kingdom a period of respite which was fruitful of the best results for the consolidation of true religion, was the prophet Isaiah. The history of his activity is at the same time the history of Judah during that period.

Isaiah became conscious of his vocation in the year of King Uzziah's death; his earliest discourses date from the beginning of the reign of Ahaz. In them he contemplates the imminent downfall of Samaria, and threatens Judah also with the chastisement its political and social sins deserve. In chap. ix., and also in chaps. ii.-v., he still confines himself on the whole to generalities quite after the manner of Amos. But on the occasion of the expedition of the allied Syrians and Ephraimites against Jerusalem he interposed with bold decision in the sphere of practical politics. To the very last he endeavoured to restrain Ahaz from his purpose of summoning the Assyrians to his help; he assured him of Jehovah's countenance, and offered him a token in pledge. When the king refused this, the prophet recognized that matters had gone too far, and that the coming of the Assyrians could not be averted. He then declared that the dreaded danger would indeed be obviated by that course, but that another far more serious would be incurred. For the Egyptians would resist the westward movement of Assyria, and Judah as the field of war would be utterly laid waste; only a remnant would remain as the basis of a better future.

Policy of non-intervention.

The actual issue, however, was not yet quite so disastrous. The Egyptians did not interfere with the Assyrians, and left Samaria and Damascus to their fate. Judah became indeed tributary to Assyria, but at the same time enjoyed considerable prosperity. Henceforward the prophet's most zealous efforts were directed to the object of securing the maintenance, at any price, of this condition of affairs. He sought by every means at his command to keep Judah from any sort of intervention in the politics of the great powers, in order that it might devote itself with undivided energies to the necessities of internal affairs. He actually succeeded in maintaining the peace for many years, even at times when in the petty kingdoms around the spirit of revolt was abroad. The ill success of all attempts elsewhere to shake off the yoke confirmed him in the conviction that Assyria was the rod of chastisement wielded by Jehovah over the nations, who had no alternative but to yield to its iron sway.

Hezekiah's reforms.

While thirty years passed thus peacefully away so far as foreign relations were concerned, internal changes of all the greater importance were taking place. Hezekiah ben Ahaz undertook for the first time a thorough-going reformation in the cultus of Jehovah. "He removed the high places, and brake the pillars, and cut down the Ashera, and brake in pieces the brazen serpent that Moses had

made"; so we are told in 2 Kings xviii. 4, with a mixture of the general and the special that does not inspire much confidence. For, e.g., the "high places" which Solomon had raised on the Mount of Olives were not removed by Hezekiah, although they stood quite close to Jerusalem, and moreover were consecrated to foreign deities. But in every respect there must have been a wide difference between the objects and results of the reformations of Hezekiah and Josiah. Undoubtedly Hezekiah undertook his reforms in worship under the influence of Isaiah. Following in the footsteps of Hosea, who had been the first to take and to express offence at the use of images in the worship of Jehovah, this prophet, utilizing the impression which the destruction of Samaria had produced in Jerusalem (Isa. xvii., cf. Jer. iii.), strove to the utmost against the adoration of the work of men's hands in the holy places, against the Asheras and pillars (sun-pillars), and above all against the ephods, i.e., the idols of silver and gold, of which the land was full. But against the high places in and by themselves, against the multiplicity of the altars of Jehovah, he made no protest. "In the Messianic time) ye shall loathe and cast away as an unclean thing your graven images with silver coverings and your molten images overlaid with gold," he says (xxx. 22); and the inference is that he contemplated the purification of the high places from superstitious excesses, but by no means their abolition. To this one object<sup>1</sup> Hezekiah's reformation seems to have confined itself,—an object of much greater primary importance than the destruction of the altars themselves. Their destruction was a measure which arose simply out of despair of the possibility of cleansing them.

Sargon, king of Assyria, was succeeded in 705 by Sennacherib. The opportunity was seized by Merodach Baladan of Babylon to secure his independence; and by means of an embassy he urged Hezekiah also to throw off the yoke. The proposal was adopted, and the king of Judah was joined by other petty kingdoms, especially some of the Philistine towns. Relations with Egypt were estab- Alliance against Assyria  
lished to secure its support in case of need. Sennacherib's more immediate and pressing business in Babylon enabled Palestine to gain some time; but the issue of that revolt made self-deception impossible as to the probable result of the other movement.

This was the period at which Isaiah, already far advanced in life, wielded his greatest influence. The preparations for revolt, the negotiations with Egypt, were concealed from him,—a proof how greatly he was feared at court. When he came to know of them, it was already too late to undo what had been done. But he could at least give vent to his anger. With Jerusalem, it seemed to him, the story of Samaria was repeating itself; uninstructed by that sad lesson, the capital was giving itself up to the mad intoxication of leaders who would inevitably bring her to ruin. "Quietness and rest" had been the motto given by Jehovah to Judah, powerless as it was and much in need of a period of peace; instead of this, defiance based on ignorance and falsehood expressed the prevailing temper. But those who refused to listen to the intelligible language of Jehovah would be compelled to hear Him speak in Assyrian speech in a way that would deafen and blind them. Isaiah shows himself no less indignant against the crowd that stupidly stared at his excitement than against the God-forsaken folly of the king, with his counsellors, his priests, and his prophets. They do not suffer themselves

<sup>1</sup> That is, to the abolition of the images. Jeremiah's polemic is directed no longer against the images, but against wood and stone, i.e., Asheras and pillars. The date of the reformation under Hezekiah is uncertain; perhaps it ought to be placed after Sennacherib's withdrawal from Jerusalem.



to be shaken out of their ordinary routine by the gravity of such a crisis as this; the living work of Jehovah is to them a sealed book; their piety does not extend beyond the respect they show for certain human precepts learnt by rote.

Sennacherib.

Meanwhile Sennacherib, at the head of a great army, was advancing against Philistia and Judah along the Phœnician coast (701). Having captured Ascalon, he next laid siege to Ekron, which, after the combined Egyptian and Ethiopian army sent to its relief had been defeated at Eltheke, fell into the enemy's hand, and was severely dealt with. Simultaneously various fortresses of Judah were occupied, and the level country was devastated (Isa. i.). The consequence was that Hezekiah, in a state of panic, offered to the Assyrians his submission, which was accepted on payment of a heavy penalty, he being permitted however to retain possession of Jerusalem. He seemed to have got cheaply off from the unequal contest.

The way being thus cleared, Sennacherib pressed on southwards, for the Egyptians were collecting their forces against him. The nearer he came to the enemy the more undesirable did he find it that he should leave in his rear so important a fortress as Jerusalem in the hands of a doubtful vassal. Notwithstanding the recently ratified treaty, therefore, he demanded the surrender of the city, believing that a policy of intimidation would be enough to secure it from Hezekiah. But there was another personality in Jerusalem of whom his plans had taken no account. Isaiah had indeed regarded the revolt from Assyria as a rebellion against Jehovah Himself, and therefore as a perfectly hopeless undertaking which could only result in the utmost humiliation and sternest chastisement for Judah. But still more distinctly than those who had gone before him did he hold firm as an article of faith the conviction that the kingdom would not be utterly annihilated; all his speeches of solemn warning closed with the announcement that a remnant should return and form the kernel of a new commonwealth to be fashioned after Jehovah's own heart. For him, in contrast to Amos, the great crisis had a positive character; in contrast to Hosea, he did not expect a temporary suspension of the theocracy, to be followed by its complete reconstruction, but in the pious and God-fearing individuals who were still to be met with in this Sodom of iniquity, he saw the threads, thin indeed yet sufficient, which formed the links between the Israel of the present and its better future. Over against the vain confidence of the multitude Isaiah had hitherto brought into prominence the darker obverse of his religious belief, but now he confronted their present depression with its bright reverse; faint-heartedness was still more alien to his nature than temerity. In the name of Jehovah he bade King Hezekiah be of good courage, and urged that he should by no means surrender. The Assyrians would not be able to take the city, not even to shoot an arrow into it nor to bring up their siege train against it. "I know thy sitting, thy going, and thy standing," is Jehovah's language to the Assyrian, "and also thy rage against me. And I will put my ring in thy nose, and my bridle in thy lips, and I will turn thee back by the way by which thou comest." And thus it proved in the issue. By a still unexplained catastrophe, the main army of Sennacherib was annihilated on the frontier between Egypt and Palestine, and Jerusalem thereby freed from all danger. The Assyrian king had to save himself by a hurried retreat to Nineveh; Isaiah was triumphant. A more magnificent close of a period of influential public life can hardly be imagined.

Isaiah's attitude: his triumph.

What Sennacherib himself relates of his expedition against his rebellious vassals in Palestine (George Smith, *Assyrian Eponym Canon*, p. 67, 68, 131-136) runs parallel with 2 Kings xviii. 14-16,

but not with the rest of the Bible narrative. These three verses are Sennacherib's peculiar, and their source is different from that of the context. After Sennacherib's having captured various Phœnician cities, and received tribute from a number of kings, his first measure is forcibly to restore the Assyrian governor who had been expelled from Ascalon, and next he turns his arms against Ekron. This city had put in iron its own king Padi (who remained loyal to the suzerain), and handed him over to Hezekiah, who appears as the soul of the rebellion in these quarters. The Egyptians, who as usual have a hand in the matter, advance with an army for the relief of the beleaguered city, but are defeated near Eltheke in the immediate neighbourhood; Ekron is taken, remorselessly chastised, and forced to take Padi back again as its king. For Hezekiah in the meantime has delivered up his prisoner, and, terrified by the fall of his fortresses and the devastation of his territory, has accepted the position of a vassal once more, paying at the same time a heavy fine, inclusive of 30 talents of gold and 800 of silver. Such is the Assyrian account. If we treat the 300 talents mentioned in 2 Kings xviii. 14 as Syrian (= 800 Babylonian), it completely fills in the vague outlines given in 2 Kings xviii. 14-16, and, while confirming in their place immediately after ver. 13 these verses, unrelated as they are to the main connexion of the Biblical narrative, corrects them only in one point by making it probable that the subjection of Hezekiah (which is not equivalent to the surrender of his city) took place while Sennacherib was still before Ekron, and not at a later date when he had gone further south towards Libnah. As regards his further advance towards Egypt, and the reasons of his sudden withdrawal (related by Herodotus also from Egyptian tradition), the great king is silent, having nothing to boast of in it. The battle of Eltheke, which is to be regarded only as an episode in the siege of Ekron, being merely the repulse of the Egyptian relieving army, was not an event of great historical importance, and ought not to be brought into any connexion either with 2 Kings xix. 7 or with xix. 35; Sennacherib's inscription speaks only of the first and prosperous stage of the expedition, not of the decisive one which resulted so disastrously for him, as must be clear from the words themselves to every unprejudiced reader. The Assyriologists, in their determination to make a history, assume identifications on grounds that do not admit of proof, and in this way do even more violence to the Assyrian than to the Biblical narrative.

8. Isaiah was so completely a prophet that even his wife was called the prophetess after him. No such title could have been bestowed on the wife of either Amos or Hosea. But what distinguished him more than anything else from those predecessors was that his position was not, like theirs, apart from the government; he sat close to the helm, and took a very real part in directing the course of the vessel. He was more positive and practical than they; he wished to make his influence felt, and, when for the moment he was unsuccessful in this so far as the great whole of the state was concerned, he busied himself in gathering round him a small circle of like-minded persons on whom his hope for the future rested. Now that Israel had been destroyed, he wished at all events to save Judah. The lofty idealism of his faith (ii. 1 sqq.) did not hinder him from calling in the aid of practical means for this end. But the current of his activities was by the circumstances of the case directed into a channel in which after his death they continued to flow towards a goal which had hardly been contemplated by himself.

Practicality of Isaiah.

The political importance of the people of Jehovah was reduced to a minimum when Judah only was left. Already at an earlier period in that kingdom the sacred had come to be of more importance than the secular; much more was this the case under the suzerainty of Assyria. The circumstances of the time themselves urged that the religion of Israel should divest itself of all politico-national character; but Isaiah also did his best to further this end. It was his most zealous endeavour to hold king and people aloof from every patriotic movement; to him the true religious attitude was one of quietness and sitting still, non-intervention in political affairs, concentration on the problems of internal government. But he was compelled to leave over for the coming Messiah (xi. 1 sqq.) that reformation in legal and social matters which seemed to him so necessary; all that he could bring the secular rulers of his country to undertake was a reform in worship. This was the most easily solved of the problems alluded to above,

Influence towards making the state a church.

and it was also that which most closely corresponded to the character of the kingdom of Judah. Thus it came about that the reform of the theocracy which had been contemplated by Isaiah led to its transformation into an ecclesiastical state. No less influential in effecting a radical change in the old popular religion was Isaiah's doctrine which identified the true Israel with the holy remnant which alone should emerge from the crisis unconsumed. For that remnant was more than a mere object of hope; it actually stood before him in the persons of that little group of pious individuals gathered around him. Isaiah founded no "ecclesiola in ecclesia" indeed, but certainly an "ecclesia in civitate Dei." Now began that distinction between the true Israel and the Israel according to the flesh, that bipartite division of the nation which became so important in later times. As head and founder of the prophetic party in Judah, Isaiah was, involuntarily, the man who took the first steps towards the institution of the church.

Judah again vassal to Assyria.

The catastrophe which befel the army of Sennacherib had no very great effect upon the external affairs of Judah. Sennacherib indeed, being busy in the east, was unable to retrieve the loss he had sustained, but his son Esaraddon, who succeeded him in 681, resumed the Egyptian war with better success. He made himself master of the Nile valley, and brought the Ethiopians into submission. That the petty kingdoms of Palestine returned to the old relations of dependence is to be taken as a matter of course. Judah appears to have resumed the yoke voluntarily, but the Samaritans only after force had been applied; they were afterwards deported, whereupon the deserted country was occupied by foreign colonists, who, however, accepted the cultus of the god of the land.

Manasseh. The reaction.

That Manasseh ben Hezekiah should have again come under Assyrian suzerainty appears at that time to have made but little impression; since the time of Ahaz Judah had been accustomed to this relation. The book of Kings speaks only of internal affairs under the reign of Manasseh. According to it, he was a bad ruler, who permitted, and even caused, innocent blood to flow like water. But what was of greater consequence for the future, he took up an attitude of hostility towards the prophetic party of reform, and put himself on the side of the reaction which would fain bring back to the place of honour the old pagan conception of Jehovah, as against the pure and holy God whom the prophets worshipped. The revulsion manifested itself, as the reform had done, chiefly in matters of worship. The old idolatrous furniture of the sanctuaries was reinstated in its place, and new frippery was imported from all quarters, especially from Assyria and Babylon, to renovate the old religion; with Jehovah was now associated a "queen of heaven." Yet, as usual, the restoration did more than merely bring back the old order of things. What at an earlier period had been mere naïveté now became superstition, and could hold its ground only by having imparted to it artificially a deeper meaning which was itself borrowed from the prophetic circle of ideas. Again, earnestness superseded the old joyousness of the cultus; this now had reference principally to sin and its atonement. Value was attached to services rendered to the Deity, just in proportion to their hardness and unnaturalness; at this period it was that the old precept to sacrifice to Jehovah the male that opens the matrix was extended to children. The counter-reformation was far from being unaffected by the preceding reformation, although it understood religious earnestness in quite another sense, and sought, not to eliminate heathenism from the cultus, but to animate it with new life. On the other hand, the reaction was in the end found to have left distinct traces of its influence in the ultimate issue of the reformation.

We possess one document dating from Manasseh's time

in Micah vi. 1-vii. 6. Here, where the lawlessness and utter disregard of every moral restraint in Judah are set in a hideous light, the prophetic point of view, as contrasted with the new refinements in worship, attains also its simplest and purest expression. Perhaps to this period the Decalogue also, which is so eloquently silent in regard to cultus, is to be assigned. Jehovah demands nothing for Himself, all that He asks is only for men; this is here the fundamental law of the theocracy.

Manasseh's life was a long one, and his son Amon walked Amon in his ways. The latter died after a brief reign, and with his death a new era for Judah began. It was introduced by the great catastrophe in which the Assyrian empire came to an end. The sovereignty of the world was beginning to pass out of the hands of the Semites into those of the Aryans. Phraortes of Media indeed was unsuccessful in his attempt against the Assyrians, but Cyaxares beat them and proceeded to besiege their capital. The Scythian invasion of Media and western Asia (c. 630) at this juncture gave them another respite of six and twenty years; but even it tended to break into pieces the great, loosely-compacted monarchy. The provinces became gradually disintegrated, and the kingdom shrivelled up till it covered no more than the land of Asshur.<sup>1</sup>

Scythians.

The inroad of the Scythians aroused to energy again the voice of prophecy which had been dumb during the very sinful but not very animated period of Manasseh's reign. Zephaniah and Jeremiah threatened with the mysterious northern foe, just as Amos and Hosea had formerly done with the Assyrians. The Scythians actually did invade Palestine in 626 (the 13th year of Josiah), and penetrated as far as to Egypt; but their course lay along the shore line, and they left Judah untouched. This danger that had come so near and yet passed them by, this instance of a prophetic threatening that had come to pass and yet been mercifully averted, made a powerful impression upon the people of Judah; public opinion went through a revolution in favour of the reforming party which was able to gain for itself the support also of the young king Josiah ben Amon. The circumstances were favourable for coming forward with a comprehensive programme for a reconstruction of the theocracy. In the year 621 (the eighteenth of Josiah) Deuteronomy was discovered, accepted, and carried into effect.

Zephaniah and Jeremiah.

The Deuteronomic legislation is designed for the reformation, by no means of the cultus alone, but at least quite as much of the civil relations of life. The social interest is placed above the cultus, inasmuch as everywhere humane ends are assigned for the rites and offerings. In this it is plainly seen that Deuteronomy is the progeny of the prophetic spirit. Still more plainly does this appear in the *motifs* of the legislation; according to these, Jehovah is the only God, whose service demands the whole heart and every energy; He has entered into a covenant with Israel, but upon fundamental conditions that, as contained in the Decalogue, are purely moral and of absolute universality. Nowhere does the fundamental religious thought of prophecy find clearer expression than in Deuteronomy,—the thought that Jehovah asks nothing for Himself, but

Deuteronomy.

<sup>1</sup> Our knowledge of the events of the second half of the 7th century has remained singularly imperfect hitherto, notwithstanding the importance of the changes they wrought on the face of the ancient world. The account given above is that of Herodotus (i. 103-106), and there the matter must rest until really authentic sources shall have been brought to light. With regard to the final siege of Nineveh, our chief informant is Ctesias as quoted by Diodorus (ii. 26, 27). Whether the prophecy of Nahum relates to the last siege is doubtful (in spite of ii. 7, and the oracle given in Diodorus, *ὅτι τὴν Νίνον οὐδέ τις ἐλεῖ κατὰ κράτος ἐὰν μὴ πρότερον ὁ ποταμὸς τῆ πόλεως γένηται πολέμιος*), inasmuch as Nahum (i. 9) expressly speaks of the siege alluded to by him as the first, saying, "the trouble shall not rise up the second time."



asks it as a religious duty that man should render to man what is right, that His will lies not in any unknown height, but in the moral sphere which is known and understood by all.<sup>1</sup>

But the result of the innovation did not correspond exactly to its prophetic origin. Prophecy died when its precepts attained to the force of laws; the prophetic ideas lost their purity when they became practical. Whatever may have been contemplated, only provisional regulations actually admitted of being carried, and even these only in cooperation with the king and the priests, and with due regard to the capacity of the masses. The final outcome of the Deuteronomic reformation was principally that the cultus of Jehovah was limited to Jerusalem and abolished everywhere else,—such was the popular and practical form of prophetic monotheism. The importance of the Salomonic temple was thereby increased in the highest degree, and so also the influence of the priests of Jerusalem, the sons of Zadok, who now in point of fact got rid entirely of their rivals, the priests of the country districts.

9. Josiah lived for thirteen years after the accomplishment of his great work. It was a happy period of external and internal prosperity. The nation possessed the covenant, and kept it. It seemed as if the conditions had been attained on which, according to the prophets, the continuance of the theocracy depended; if their threatenings against Israel had been fulfilled, so now was Judah proving itself the heir of their promises. Already in Deuteronomy is the "extension of the frontier" taken into consideration, and Josiah actually put his hand to the task of seeking the attainment of this end.

Religion  
and  
patriot-  
ism.

Jehovah and Israel, religion and patriotism, once more went hand in hand. Jeremiah alone did not suffer himself to be misled by the general feeling. He was a second Amos, upon a higher platform—but, unlike his predecessor, a prophet by profession; his history, like Isaiah's, is practically the history of his time. In the work of introducing Deuteronomy he had taken an active part, and throughout his life he showed his zeal against unlawful altars and against the adoration of wood and stone (Asheras and pillars). But he was by no means satisfied with the efforts of the reformation that had been effected; nothing appeared to him more sinful or more silly than the false confidence produced by it in Jehovah and in the inviolability of His one true temple. This confidence he maintained to be delusive; Judah was not a whit better than Israel had been, Jerusalem would be destroyed one day like the temple of Shiloh. The external improvements on which the people of Judah prided themselves he held to leave this severe judgment unaffected; what was needed was a quite different sort of change, a change of heart, not very easy positively to define.

Jerem-  
iah's  
opposi-  
tion.

An opportunity for showing his opposition presented itself to the prophet at the juncture when King Josiah had fallen at Megiddo in the battle with Pharaoh Necho (608), and when the people were seeking safety and protection by cleaving to Jehovah and His holy temple. At the instance of the priests and the prophets he had almost expiated with his blood the blasphemies he had uttered against the popular belief; but he did not suffer himself to be driven from his course. Even when the times had grown quiet again, he persisted, at the risk of his life and under universal reproach and ridicule, in his work as a prophet of

<sup>1</sup> The commandments which I command thee are not unattainable for thee, neither are they far off; not in heaven so that one might say, Who can climb up into heaven and bring them down, and tell us them that we might do them! not beyond the sea, so that one might say, Who shall go over the sea, and fetch them and tell us them that we might do them!—but the matter lies very near thee, in thy mouth and in thy heart, so that thou canst do it.—Deut. xxx. 11–14.

evil. Moments of despair sometimes came to him; but that he had correctly estimated the true value of the great conversion of the nation was speedily proved by the facts. Although Deuteronomy was not formally abolished under Jehoiakim, who as the vassal of Egypt ascended the throne of his father Josiah, nevertheless it ceased to have practical weight, the battle of Megiddo having shown that in spite of the covenant with Jehovah the possibilities of non-success in war remained the same as before. Jehoiakim tended to return to the ways of Manasseh, not only as regarded idolatry, but also in his contempt for law and the private rights of his subjects;—the two things seem to stand in connexion.

The course of events at last brought upon the theocracy the visible ruin which Jeremiah had been so long expecting. After the Egyptians had, with comparative ease, subjugated Syria at a time when the Medes and Chaldæans were busied with the siege of Nineveh, Nebuchadnezzar, that task accomplished, came upon them from Babylon and routed them on the Euphrates near Carchemish (605–4). The people of Judah rejoiced at the fall of Nineveh, and also at the result of Carchemish; but they were soon undeceived when the prospect began to open on them of simply exchanging the Egyptian for the Chaldean yoke. The power of the Chaldæans had been quite unsuspected, and now it was found that in them the Assyrians had suddenly returned to life. Jeremiah was the only man who gained any credit by these events. His much ridiculed "enemy out of the north," of whom he had of old been wont to speak so much, now began to be talked of with respect, although his name was no longer "the Scythian" but "the Babylonian." It was an epoch,—the close of an account which balanced in his favour. Therefore it was that precisely at this moment he received the Divine command to commit to writing that which for twenty-three years he had been preaching, and which, ever pronounced impossible, had now showed itself so close at hand.

Nebuchad-  
nezzar.

After the victory of Carchemish the Chaldæans drove Pharaoh out of Syria, and also compelled the submission of Jehoiakim (c. 602). For three years he continued to pay his tribute, and then he withheld it; a mad passion for liberty, kindled by religious fanaticism, had begun to rage with portentous power amongst the influential classes, the grandees, the priests, and the prophets. Nebuchadnezzar satisfied himself in the first instance with raising against Judah several of the smaller nationalities around, especially the Edomites; not till 597 did he appear in person before Jerusalem. The town was compelled to yield; the more important citizens were carried into exile, amongst them the young king Jehoniah, son of Jehoiakim, who had died in the interval; Zedekiah ben Josiah was made king in his stead over the remnant left behind. The patriotic fanaticism that had led to the revolt was not broken even by this blow. Within four years afterwards new plans of liberation began to be again set on foot; but on this occasion the influence of Jeremiah proved strong enough to avert the danger. But when a definite prospect of help from Pharaoh Hophra (Apries) presented itself in 589, the craving for independence proved quite irrepressible. Revolt was declared; and in a very short time the Chaldæan army, with Nebuchadnezzar at its head, lay before Jerusalem. For a while everything seemed to move prosperously; the Egyptians came to the rescue, and the Chaldæans were compelled to raise the siege in order to cope with them. At this there was great joy in Jerusalem; but Jeremiah continued to express his gloomy views. The event proved that he was right; the Egyptians were repulsed and the siege resumed. The city was bent on obstinate resistance; in vain did Jeremiah, at continual risk of his

Deporta-  
tion of  
citizens  
of Jeru-  
salem in  
597 B.C.

Fall of Jerusalem.

life, endeavour to bring it to reason. The king, who agreed with the prophet, did not venture to assert his opinion against the dominant terrorism. The town in these circumstances was at last taken by storm, and, along with the temple, reduced to ruins. Cruel vengeance was taken on the king and grandees, and the pacification of the country was ensured by another and larger deportation of the inhabitants to Babylon. Thus terminated in 586 the kingdom of Judah.

The prophets.

The prophets had been the spiritual destroyers of the old Israel. In old times the nation had been the ideal of religion in actual realization; the prophets confronted the nation with an ideal to which it did not correspond. Then to bridge over this interval the abstract ideal was framed into a law, and to this law the nation was to be conformed. The attempt had very important consequences, inasmuch as Jehovah continued to be a living power in the law, when He was no longer realized as present in the nation; but that was not what the prophets had meant to effect. What they were unconsciously labouring towards was that religious individualism which had its historical source in the national downfall, and manifested itself not exclusively within the prophetic sphere. With such men as Amos and Hosea the moral personality based upon an inner conviction burst through the limits of mere nationality; their mistake was in supposing that they could make their way of thinking the basis of a national life. Jeremiah saw through the mistake; the true Israel was narrowed to himself. Of the truth of his conviction he never had a moment's doubt; he knew that Jehovah was on his side, that on Him depended the eternal future. But, instead of the nation, the heart and the individual conviction were to him the subject of religion. On the ruins of Jerusalem he gazed into the future filled with joyful hope, sure of this that Jehovah would one day pardon past sin and renew the relation which had been broken off—though on the basis of another covenant than that laid down in Deuteronomy. "I will put my law upon their heart, and write it on their mind; none shall say to his neighbour, 'Know the Lord,' for all shall have that knowledge within them."

Jews of the exile.

10. The exiled Jews were not scattered all over Chaldea, but were allowed to remain together in families and clans. Many of them, notwithstanding this circumstance, must have lapsed and become merged in the surrounding heathenism; but many also continued faithful to Jehovah and to Israel. They laboured under much depression and sadness, groaning under the wrath of Jehovah, who had rejected His people and cancelled His covenant. They were lying under a sort of vast interdict; they could not celebrate any sacrifice or keep any feast; they could only observe days of fasting and humiliation, and such rites as had no inseparable connexion with the holy land. The observance of the Sabbath, and the practice of the rite of circumcision, acquired much greater importance than they formerly possessed as signs of a common religion. The meetings on the Sabbath day out of which the synagogues were afterwards developed appear to have first come into use during this period; perhaps also even then it had become customary to read aloud from the prophetic writings which set forth that all had happened in the providence of God, and moreover that the days of adversity were not to last for ever.

Cyrus: how regarded.

Matters improved somewhat as Cyrus entered upon his victorious career. Was he the man in whom the Messianic prophecies had found their fulfilment? The majority were unwilling to think so. For it was out of Israel (they argued) that the Messiah was to proceed who should establish the kingdom of God upon the ruins of the kingdoms of the world; the restitution effected by means of a Persian could only be regarded as a passing incident in

the course of an historical process that had its goal entirely elsewhere. This doubt was met by more than one prophetic writer, and especially by the great anonymous author to whom we are indebted for Isa. xl.-lxvi. "Away with sorrow; deliverance is already at the door! Is it then a humiliating thing that Israel should owe its freedom to a Persian? Nay, is it not rather a proof of the world-wide sway of the God of Jacob that He should thus summon His instruments from the ends of the earth? Who else than Jehovah could have thus sent Cyrus? Surely not the false gods which He has destroyed? Jehovah alone it was who foretold and foreknew the things which are now coming to pass,—because long ago He had prearranged and predetermined them, and they are now being executed in accordance with His plan. Rejoice therefore in prospect of your near deliverance; prepare yourselves for the new era; gird yourselves for the return to your homes." It is to be observed, as characteristic in this prophecy, how the idea of Jehovah as God alone and God over all—in constantly recurring lyrical parentheses He is praised as the author of the world and of all nature—is yet placed in positive relation to Israel alone, and that upon the principle that Israel is in exclusive possession of the universal truth, which cannot perish with Israel, but must, through the instrumentality of Israel, become the common possession of the whole world. "There is no God but Jehovah, and Israel is His prophet."

For many years the Persian monarch put the patience of the Jews to the proof; Jehovah's judgment upon the Chaldeans, instead of advancing, seemed to recede. At length, however, their hopes were realized; in the year 538 Cyrus brought the empire of Babylon to an end, and gave the exiles leave to seek their fatherland once more. This permission was not made use of by all, or even by a majority. The number of those who returned is stated at 42,360; whether women and children are included in this figure is uncertain. On arriving at their destination, after the difficult march through the desert, they did not spread themselves over the whole of Judah, but settled chiefly in the neighbourhood of Jerusalem. The Calebites, for example, who previously had had their settlements in and around Hebron, now settled in Bethlehem and in the district of Ephrath. They found it necessary to concentrate themselves in face of a threatened admixture of doubtful elements. From all sides people belonging to the surrounding nations had pressed into the depopulated territory of Judah. Not only had they annexed the border territories—where, for example, the Edomites or Idumæans held the whole of the Negeb as far as to Hebron; they had effected lodgments everywhere, and—as the Ammonites, Ashdodites, and especially the Samaritans—had amalgamated with the older Jewish population, a residue of which had remained in the country in spite of all that had happened. These half-breed "pagani" (Amme haarec, ὄχλοι) gave a friendly reception to the returning exiles (Bne haggola); particularly did the Samaritans show themselves anxious to make common cause with them. But they were met with no reciprocal cordiality. The lesson of religious isolation which the children of the captivity had learned in Babylon, they did not forget on their return to their home. Here also they lived as in a strange land. Not the native of Judæa, but the man who could trace his descent from the exiles in Babylon, was reckoned as belonging to their community.

The first decennia after the return of the exiles, during which they were occupied in adjusting themselves to their new homes, were passed under a variety of adverse circumstances and by no means either in joyousness or security. Were these then the Messianic times which, it had been foretold, were to dawn at the close of their captivity?



Haggai  
and  
Zech-  
ariah  
The  
temple.

They did not at all events answer the expectations which had been formed. A settlement had been again obtained, it was true, in the fatherland; but the Persian yoke pressed now more heavily than ever the Babylonian had done. The sins of God's people seemed still unforgiven, their period of bond-service not yet at an end. A slight improvement, as is shown by the prophecies of Haggai and Zechariah, followed when in the year 520 the obstacles disappeared which until then had stood in the way of the rebuilding of the temple; the work then begun was completed in 516. Inasmuch as the Jews were now nothing more than a religious community, based upon the traditions of a national existence that had ceased, the rebuilding of the temple, naturally, was for them an event of supreme importance.

Hiero-  
cracy in-  
evitable.

The law of the new theocracy was the book of Deuteronomy; this was the foundation on which the structure was to be built. But the force of circumstances, and the spirit of the age, had even before and during the exile exerted a modifying influence upon that legislative code; and it continued to do so still. At first a "son of David" had continued to stand at the head of the Bne haggola, but this last relic of the old monarchy soon had to give way to a Persian governor who was under the control of the satrap of trans-Euphratic Syria, and whose principal business was the collection of revenue. Thenceforward the sole national chief was Joshua the high priest, on whom, accordingly, the political representation also of the community naturally devolved. In the circumstances as they then were no other arrangement was possible. The way had been paved for it long before in so far as the Assyrians had destroyed the kingdom of Israel, while in the kingdom of Judah which survived it the religious cultus had greater importance attached to it than political affairs, and also inasmuch as in point of fact the practical issue of the prophetic reformation sketched in Deuteronomy had been to make the temple the national centre still more than formerly. The hierocracy towards which Ezekiel had already opened the way was simply inevitable. It took the form of a monarchy of the high priest, he having stepped into the place formerly occupied by the theocratic King. As his peers and at his side stood the members of his clan, the Levites of the old Jerusalem, who traced their descent from Zadok (Sadduk); the common Levites held a much lower rank, so far as they had maintained their priestly rank at all and had not been degraded, in accordance with Ezekiel's law (chap. xlv.), to the position of mere temple servitors. "Levite," once the title of honour bestowed on all priests, became more and more confined to members of the second order of the clergy.

Meanwhile no improvement was taking place in the condition of the Jewish colonists. They were poor; they had incurred the hostility of their neighbours by their exclusiveness; the Persian government was suspicious; the incipient decline of the great kingdom was accompanied with specially unpleasant consequences so far as Palestine was concerned (Megabyzus). All this naturally tended to produce in the community a certain laxity and depression. To what purpose (it was asked) all this religious strictness, which led to so much that was unpleasant? Why all this zeal for Jehovah, who refused to be mollified by it? It is a significant fact that the upper ranks of the priesthood were least of all concerned to counteract this tendency. Their priesthood was less to them than the predominance which was based upon it; they looked upon the neighbouring ethnarchs as their equals, and maintained relations of friendship with them. The general community was only following their example when it also began to mingle with the Amme haareq.

The danger of Judaism merging into heathenism was

imminent. But it was averted by a new accession from without. In the year 458 Ezra the scribe, with a great number of his compatriots, set out from Babylon, for the purpose of reinforcing the Jewish element in Palestine. The Jews of Babylon were more happily situated than their Palestinian brethren, and it was comparatively easy for them to take up a separatist attitude, because they were surrounded by a heathenism not partial but entire. They were no great losers from the circumstance that they were precluded from participating directly in the life of the ecclesiastical community; the Torah had long ago become separated from the people, and was now an independent abstraction following a career of its own. Babylonia was the place where a further codification of the law had been placed alongside of Deuteronomy. Ezekiel had led the way in reducing to theory and to writing the sacred praxis of his time; in this he was followed by an entire school; in their exile the Levites turned scribes. Since then Babylon continued to be the home of the Torah; and, while in Palestine itself the practice was becoming laxer, their literary study had gradually intensified the strictness and distinctive peculiarities of Judaism. And now there came to Palestine a Babylonian scribe having the law of his God in his hand, and armed with authority from the Persian king to proceed upon the basis of this law with a reformation of the community.

Ezra did not set about introducing the new law immediately on his arrival in Judæa. In the first instance he concentrated his attention on the task of effecting a strict separation between the Bne haggola and the heathen or half-heathen inhabitants. So much he could accomplish upon the basis of Deuteronomy, but it was long before he gave publicity to the law which he himself had brought. Why he hesitated so long it is impossible to say; between the seventh and the twentieth year of Artaxerxes Longimanus (458-445 B.C.) there is a great hiatus in the narrative of the books of Ezra and Nehemiah. The main reason appears to have been that, in spite of the goodwill of the Persian king, Ezra had not the vigorous support of the local authorities. But this was indispensably necessary in order to secure recognition for a new law.

At last, in 445, it fell to the lot of a Jew, who also shared the views of Ezra, Nehemiah ben Hakkelejah,<sup>1</sup> the cupbearer and the favourite of Artaxerxes, to be sent as Persian governor to Judæa. After he had freed the community from external pressure with vigour and success, and brought it into more tolerable outward circumstances, the business of introducing the new law-book was next proceeded with; in this Ezra and Nehemiah plainly acted in concert.

On the first of Tisri—the year is unfortunately not given, but it cannot have been earlier than 444 B.C.—the promulgation of the law began at a great gathering in Jerusalem; Ezra, supported by the Levites, was present. Towards the end of the month, the concluding act took place, in which the community became solemnly bound by the contents of the law. Special prominence was given to those provisions with which the people were directly concerned, particularly those which related to the dues payable by the laity to the priests.

The covenant which hitherto had rested on Deuteronomy was thus expanded into a covenant based upon the entire Pentateuch. Substantially at least Ezra's law-book, in the form in which it became the Magna Charta of Judaism in or about the year 444, must be regarded as practically identical with our Pentateuch, although many minor

<sup>1</sup> According to the present punctuation this name is Hakaia (Hach-aljah), but such a pronunciation is inadmissible; it has no possible etymology, the language having no such word as *hatal*. The name in its correct form means "Wait upon Jehovah."

Danger of  
heathen-  
ism.  
Ezra.

Ezra.

Nehemiah

The new  
law-  
book.

amendments and very considerable additions may have been made at a later date.

Character of the priestly code.

The character of the post-Deuteronomic legislation (priestly code) is chiefly marked, in its external aspects, by the immense extension of the dues payable to the priests, and by the sharp distinction made between the descendants of Aaron and the common Levites; this last feature is to be traced historically to the circumstance that after the Deuteronomic reformation the legal equality between the Levites who until then had ministered at the "high places" and the priests of the temple at Jerusalem was not *de facto* recognized. Internally, it is mainly characterized by its ideal of Levitical holiness, the way in which it everywhere surrounds life with purificatory and propitiatory ceremonies, and its prevailing reference of sacrifice to sin. Noteworthy also is the manner in which everything is regarded from the point of view of Jerusalem, a feature which comes much more boldly into prominence here than in Deuteronomy; the nation and the temple are strictly speaking identified. That externalization towards which the prophetic movement, in order to become practical, had already been tending in Deuteronomy finally achieved its acme in the legislation of Ezra; a new artificial Israel was the result; but, after all, the old world have pleased an Amos better. At the same time it must be remembered that the kernel needed a shell. It was a necessity that Judaism should incrust itself in this manner; without those hard and ossified forms the preservation of its essential elements would have proved impossible. At a time when all nationalities, and at the same time all bonds of religion and national customs, were beginning to be broken up in the seeming cosmos and real chaos of the Græco-Roman empire the Jews stood out like a rock in the midst of the ocean. When the natural conditions of independent nationality all failed them, they nevertheless artificially maintained it with an energy truly marvellous, and thereby preserved for themselves and at the same time for the whole world an eternal good.<sup>1</sup>

Its disadvantages and advantages.

As regards the subsequent history of the Jewish community under the Persian domination, we have almost no information. The high priest in Nehemiah's time was Eliashib, son of Joiakim and grandson of Joshua, the patriarchal head of the sons of Zadok, who had returned from Babylon; he was succeeded in the direct line by Joiada, Johanan, and Jaddua (Neh. xii. 10, 11, 22); the last-named was in office at the time of Alexander the Great (Joseph., *Ant.*, xi. 8). Palestine was the province which suffered most severely of all from the storms which marked the last days of the sinking Persian empire, and it is hardly likely that the Jews escaped their force; we know definitely, however, of only one episode, in which the Persian general Bagoses interfered in a disagreeable controversy about the high-priesthood (*cir.* 375).

Subsequent history under Persian rule.

To this period also (and not, as Josephus states, to the time of Alexander) belongs the constitution of the Samaritan community on an independent footing by Manasseh, a Jewish priest of rank. He was expelled from Jerusalem by Nehemiah in 432, for refusing to separate from his alien wife. He took shelter with his father-in-law Sanballat the

Samaritan church.

Samaritan prince, who built him a temple on Mount Gerizim near Shechem, where he organized a Samaritan church and a Samaritan worship, on the Jerusalem model, and on the basis of a but slightly modified Jerusalem Pentateuch. If the Samaritans had hitherto exerted themselves to the utmost to obtain admission into the fellowship of the Jews, they henceforward were as averse to have anything to do with these as these were to have any dealings with them; the temple on Mount Gerizim was now the symbol of their independence as a distinct religious sect. For the Jews this was a great advantage, as they had no longer to dread the danger of syncretism. They could now quite confidently admit the Amme haareq into their communion, in the assurance of assimilating them without any risk of the opposite process taking place. The Judaizing process began first with the country districts immediately surrounding Jerusalem, and then extended to Galilee and many portions of Peræa. In connexion with it, the Hebrew language, which hitherto had been firmly retained by the Bne haggola, now began to yield to the Aramaic, and to hold its own only as a sacred speech.

In all probability the internal development of the Jewish community throughout this period stood in inverse proportion to the eventfulness of its external history. After the Torah had been introduced as the law for the community, the next business was to give it practical effect and secure that all the relations of life should be pervaded by it. The place for doing this was the synagogue, where it was read every Sabbath day, and illustrated from the historical and prophetic books<sup>2</sup>; from this point of view a new light was shed upon the whole of antiquity (Midrash, Chronicles). The Torah was most largely indebted to the scribes. They had codified it, and moreover the foundation of a supplementary and correcting tradition, advancing with the progressive requirements of life, was laid by them. At a very early period they formed a numerous social class, the moral influence of which exceeded that of the priests. For the public cultus, and the public affairs generally speaking presided over by the priests, were not nearly so interesting to that age as was the regulation of the concerns of private life by religious law and ceremony. But here the scribes had the lead; their avowed object was to make *βιωσις* (the expressive active noun of the prologue to Ecclesiasticus) increasingly *ἐνωμος*. Their constantly increasing prescriptions were felt not as burdens but as reliefs. Never before had the individual so keenly felt his responsibility for all that he did or left undone; but this responsibility oppressed him, and what he longed for was to be able at every moment of his life to fulfil some positive command which should raise him above all risk of mistake.<sup>3</sup>

Internal development of Judaism.

Synagogue.

Scribes.

In its individualism this tendency has relations with a deeper and freer type of piety by which to some extent prophecy was continued under the domination of the law, and which connected itself especially with Jeremiah. In the finest Psalms there has grown out of the relation of Jehovah to Israel a relation between God and the pious soul; the pure subjective sense of fellowship with God (Ps. lxxiii. 28) is the highest good, in it a man has enough even when flesh and heart fail. So intensely was the

Personal religion.

<sup>1</sup> On the age of the priestly legislation of the Pentateuch compare De Wette, *Beiträge zur Einleitung ins A. T.*, 1806-7; George, *Die jüdischen Feste*, 1835; Vatke, *Die biblische Theologie*, 1835; Graf, *Die Geschichtlichen Bücher des A. T.*, 1866; Kuenen, *Godsdiens van Israel*, vol. ii., 1870. Great concessions to the view that the priestly code is of post-exilic origin are made by Delitzsch in the *Zeitschrift für kirchliche Wissenschaft*, p. 620, Leipzig, 1880:—"I am now convinced that the processes which in their origin and progress have resulted in the final form of the Torah, as we now possess it, continued into the post-exile period, and perhaps had not ceased their activity even at the time of the formation of the Samaritan Pentateuch and the Septuagint translation."

<sup>2</sup> On the history of the canon see Bleek, *Einl. ins A. T.*, secs. 269-274 (4th ed.). That the men of the Great Synagogue, who are alleged to have formed the canon, are merely an exegetical mythus having its foundation on the narrative of Neh. vii.-x. has been shown by Kuenen ("Over de Mannen der Grootte Synagoge," in the *Proceedings of the Royal Netherl. Acad.*, 1876).

<sup>3</sup> Aristæus (Schmidt) 39, 1: *παρόθεν περιέφραξεν ἡμᾶς ἀγγέλαις καὶ διὰ βρωτῶν καὶ ποτῶν καὶ ἀφῶν καὶ ἀκοῆς καὶ δράσεως νομικῶν*. Ecclus. vi. 29: *καὶ ἕσονται σοὶ αἱ πῆλαι εἰς σκεπὴν ἰσχύος καὶ οὐ κλοῖδι αὐτῆς εἰς σφάλην βλάτης*. The aim was not to do good, but to avoid sin (Joseph., *Ant.*, xvi. 2, 4).



reality of this relation felt that it became the foundation upon which the hope of immortality was first based, although belief in the doctrine of retribution was what chiefly made it popular. This inner religiosity exercised a modifying influence upon worship even; the channel through which it was possible to import into it the expression of all kinds of feeling which were individual in their origin was the temple service of song, which was elaborated at this period, and soon reached an importance much higher than that of the sacrifices and other *opera operanda*.

As religion grew more individualistic, it also became more universal; for developed monotheism in any case its restriction to one particular nation was only casual and provisional. It is very noteworthy that in the book of Job, to which it is impossible to assign a date previous to the exile,<sup>1</sup> a religious problem is discussed between men of Uz, Aram, and Edom precisely as if they had been Jews. In the *Hokmah*, which flourished at that time in Judah as well as in Edom, religion almost entirely abandoned the ground of nationality, and became a kind of philosophy. Through the *Hokmah* doubt also began to assert a place for itself even within the sphere of religion.

The influence of Parsism upon Judaism was not so great as is usually assumed. It can hardly have affected the doctrine of the resurrection, although it may have influenced the development of angeology. Satan has some relation to old Hebrew conceptions (1 Kings xxii.), but nevertheless is essentially the product of Zoroastrian dualism.

11. Palestine fell into Alexander's possession in 332; after his death it had an ample share of the troubles arising out of the partition of his inheritance. In 320 it was seized by Ptolemy I, who on a sabbath day took Jerusalem; but in 315 he had to give way before Antigonus. Even before the battle of Ipsus, however, he recovered possession once more, and for a century thereafter southern Syria continued to belong to the Egyptian crown, although the Seleucidæ more than once sought to wrench it away.

In the priestly dynasty during the period of the Ptolemies, Onias I. ben Jaddua was succeeded by his son Simon I., after whom again came first his brothers Eleazar and Manasseh, and next his son Onias II.; the last-named was in his turn followed by his son Simon II., whose praises are sung by the son of Sirach (xlix. 14-16). At the side of the high priest stood the gerusia of the town of Jerusalem, as a council of state, including the higher ranks of the priesthood. The new sovereign power was at once stronger and juster than the Persian,—at least under the earlier Ptolemies; the power of the national government increased; and to it was entrusted the business of raising the tribute.

As a consequence of the revolutionary changes which had taken place in the conditions of the whole East, the Jewish dispersion (*diaspora*) began vigorously to spread. It dated its beginning indeed from an earlier period,—from the time when the Jews had lost their land and kingdom, but yet, thanks to their religion, could not part with their nationality. They did not by any means all return from Babylon; perhaps the majority permanently settled abroad. The successors of Alexander (*diadochi*) fully appreciated this international element, and used it as a link between their barbarian and Hellenic populations. Everywhere they encouraged the settlement

of Jews,—in Asia Minor, in Syria, and especially in Egypt. Alongside of the Palestinian there arose a Hellenistic Judaism which had its metropolis in Alexandria. Here, under Ptolemy I. and II., the Torah had already been translated into Greek, and around this sprung up a Jewish-Greek literature which soon became very extensive. At the court and in the army of the Ptolemies many Jews rose to prominent positions; everywhere they received the preference over, and everywhere they in consequence earned the hatred of, the indigenous population.

After the death of Ptolemy IV. (205) Antiochus III. attained the object towards which he and his predecessors had long been vainly striving; after a war protracted with varying success through several years, he succeeded at last in incorporating Palestine with the kingdom of the Seleucidæ. The Jews took his side, less perhaps because they had become disgusted with the really sadly degenerate Egyptian rule, than because they had foreseen the issue of the contest, and preferred to attach themselves voluntarily to the winning side. In grateful acknowledgment, Antiochus confirmed and enlarged certain privileges of the "holy camp," *i.e.*, of Jerusalem (Joseph., *Ant.*, xii. 3, 3). It soon, however, became manifest that the Jews had made but a poor bargain in this exchange. Three years after his defeat at Magnesia, Antiochus III. died (187), leaving to his son Seleucus IV. an immense burden of debt, which he had incurred by his unprosperous Roman war. Seleucus, in his straits, could not afford to be over-scrupulous in appropriating money where it was to be found; he did not need to be twice told that the wealth of the temple at Jerusalem was out of all proportion to the expenses of the sacrificial service. The sacred treasure accordingly made the narrowest possible escape from being plundered; Heliodorus, who had been charged by the king to seize it, was deterred at the last moment by a heavenly vision. But the Jews derived no permanent advantage from this.

It was a priest of rank, Simon by name, who had called the attention of the king to the temple treasure; his motive had been spite against the high priest Onias III., the son and successor of Simon II. The circumstance is one indication of a melancholy process of disintegration that was at that time going on within the hierocracy. The high-priesthood, although there were exceptional cases, such as that of Simon II., was regarded less as a sacred office than as a profitable principedom; within the ranks of the priestly nobility arose envious and jealous factions; personal advancement was sought by means of the favour of the overlord, who had something to say in the making of appointments. A collateral branch of the ruling family, that of the children of Tobias, had by means of the ill-gotten wealth of Joseph ben Tobias attained to a position of ascendancy, and competed in point of power with the high priest himself. It appears that the above-mentioned Simon, and his still more scandalous brother Menelaus, also belonged to the Tobiadæ, and, relying upon the support of their powerful party (Jos., *Ant.*, xii. 5, 1), cherished the purpose of securing the high-priesthood by the aid of the Syrian king.

The failure of the mission of Heliodorus was attributed by Simon to a piece of trickery on the part of Onias the high priest, who accordingly found himself called upon to make his own justification at court and to expose the intrigues of his adversary. Meanwhile Seleucus IV. died of poison (175), and Antiochus IV. Epiphanes did not confirm Onias in his dignity, but detained him in Antioch while he made over the office to his brother Jason, who had offered a higher rent. Possibly the Tobiadæ also had something to do with this arrangement; at all events Menelaus was at the outset the right hand of the new high

<sup>1</sup> The arguments against so early a date are such as these:—the occurrence of Satan; the occurrence of such words as קַבֵּל, קִרְבָּן, עֲנָשׂוּ, נִצַּב (=affliction), נָדָב (=Aram. נָטַב); the relation between chap. iii. and Jer. xx. 14 *sqq.* For that Jeremiah in that cry of despair should have declaimed in imitation of a poetic model is hard to believe. Job iii. is a product of art; Jer. xx. is nature. For the age of the *Hokmah* the book of Ecclesiastians is decisive; it failed to become canonical because its author continued to be known.

Universal religion.

The Seleucidæ.

The Ptolemies.

The priestly aristocracy.

The Diaspora.

priest. To secure still further the favour of the king, Jason held himself out to be an enlightened friend of the Greeks, and begged for leave to found in Jerusalem a gymnasium and an ephebeum, and to be allowed to sell to the inhabitants there the rights of citizenship in Antioch, — a request which was readily granted.

The malady which had long been incubating now reached its acute phase. Just in proportion as Hellenism showed itself friendly did it present elements of danger to Judaism. From the periphery it slowly advanced towards the centre, from the diaspora to Jerusalem, from mere matters of external fashion to matters of the most profound conviction.<sup>1</sup> Especially did the upper and cultivated classes of society begin to feel ashamed, in presence of the refined Greeks, of their Jewish singularity, and to do all in their power to tone it down and conceal it. In this the priestly nobility made itself conspicuous as the most secular section of the community, and it was the high priest who took the initiative in measures which aimed at a complete Hellenizing of the Jews. He outdid every one else in paganism. Once he sent a considerable present for offerings to the Syrian Hercules on the occasion of his festival, but his messenger, ashamed to apply the money to such a purpose, set it apart for the construction of royal ships of war.

The friendship shown by Jason for the Greek king and for all that was Hellenic did not prevent Antiochus IV. from setting pecuniary considerations before all others. Menelaus, entrusted with the mission of conveying to Antioch the annual Jewish tribute, availed himself of the opportunity to promote his own personal interests by offering a higher sum for the high priesthood, and, having otherwise ingratiated himself with the king, gained his object (171). But though nominated he did not find it quite easy to obtain possession of the post. The Tobiadæ took his side, but the body of the people stuck to Jason, who was compelled to give way only when Syrian troops had been brought upon the scene. Menelaus had immediately, however, to encounter another difficulty, for he could not at once pay the amount of tribute which he had promised. He helped himself so far indeed by robbing the temple, but this landed him in new embarrassments. Onias III, who was living out of employment at Antioch, threatened to make compromising revelations to the king; he was, however, opportunely assassinated. The rage of the people against the priestly temple-plunderer now broke out in a rising against a certain Lysimachus, who at the instance of the absent Menelaus had made further inroads upon the sacred treasury. The Jews' defence before the king (at Tyre) on account of this uproar resolved itself into a grievous complaint against the conduct of Menelaus. His case was a bad one, but money again helped him out of his straits, and the extreme penalty of the law fell upon his accusers.

The feelings of the Jews with reference to this wolfish shepherd may easily be imagined. Nothing but fear of Antiochus held them in check. Then a report gained currency that the king had perished in an expedition against Egypt (170), and Jason, who meanwhile had found refuge in Ammanitis, availed himself of the prevailing current of feeling to resume his authority with the help of one thousand men. He was not able, however, to hold the position long, partly because he showed an unwise vindictiveness against his enemies, partly (and chiefly) because the rumour of the death of Antiochus turned out to be false. The king was already in fact close at hand, on his return from Egypt, full of anger at an insurrection which he regarded as having been directed against himself. He

inflicted severe and bloody chastisement upon Jerusalem, carried off the treasures of the temple, and restored Menelaus, placing Syrian officials at his side. Jason fled from place to place, and ultimately died in misery at Lacedæmon.

The deepest despondency prevailed in Judæa; but its cup of sorrow was not yet full. Antiochus, probably soon after his last Egyptian expedition (168), sent Apollonius with an army against Jerusalem. He fell upon the unsuspecting city, disarmed the inhabitants and demolished the walls, but on the other hand fortified Acra, and garrisoned it strongly so as to make it a standing menace to the whole country. Having thus made his preparations, he proceeded to carry out his main instructions. All that was religiously distinctive of Judaism was to be removed; such was the will of the king. The Mosaic cultus was abolished, Sabbath observance and the rite of circumcision prohibited, all copies of the Torah confiscated and burnt. In the desecrated and partially destroyed temple pagan ceremonies were performed, and upon the great altar of burnt offering a small altar to Jupiter Capitolinus was erected, on which the first offering was made on 25th Kislew 168. In the country towns also heathen altars were erected, and the Jews compelled, on pain of death, publicly to adore the false gods and to eat swine's flesh that had been sacrificed to idols.

The princes and grandees of the Jews had represented to Antiochus that the people were ripe for Hellenization; and inasmuch as, apart from this, to reduce to uniformity the extremely motley constituents of his kingdom was a scheme that lay near his heart, he was very willing to believe them. That the very opposite was the case must of course have become quite evident very soon; but, the resistance of the Jews taking the form of rebellious risings against his creatures, he fell upon the hopeless plan of coercion,—hopeless, for he could attain his end only by making all Judæa one vast graveyard. There existed indeed a pagan party; the Syrian garrison of Acra was partly composed of Jews who sold themselves to be the executioners of their countrymen. Fear also influenced many to deny their convictions; but the majority adhered firmly to the religion of their fathers. Jerusalem, the centre of the process of Hellenization, was abandoned by its inhabitants, who made their escape to Egypt, or hid themselves in the country, in deserts and caves. The scribes in especial held fast by the law; and they were joined by the party of the Asidæans (*i.e.*, pious ones).

12. At first there was no thought of meeting violence with violence; as the book of Daniel shows, people consoled themselves with thoughts of the immediate intervention of God which would occur in due time. Quite casually, without either plan or concert, a warlike opposition arose. There was a certain priest Mattathias, of the family of the Hasmonæans, a man far advanced in life, whose home was in Modein, a little country town to the west of Jerusalem. Hither also the Syrian soldiers came to put the population to a positive proof of their change of faith; they insisted upon Mattathias leading the way. But he was steadfast in his refusal; and, when another Jew addressed himself before his eyes to the work of making the heathen offering, he killed him and the Syrian officer as well, and destroyed the altar. Thereupon he fled to the hill country, accompanied by his sons (Johannes Gaddi, Simon Thassi, Judas Maccabæus, Eleazar Anaran, Jonathan Apphus) and other followers. But he resolved to defend himself to the last, and not to act as some other fugitives had done who about the same time had allowed themselves to be surrounded and butchered on a sabbath day without lifting a finger. Thus he became the head of a band which defended the ancestral religion with the sword. They

<sup>1</sup> The Hellenizing fashion is amazingly exemplified in the Grecizing of the Jewish names; *e.g.*, Alcimus = Eljakim, Jason = Jesus, Joshua; Menelaus = Menahem.

Antiochus Epit. 168 B.C.

25th Kislew 168 B.C.

State of Jewish parties.

The Hasmonæans.

Hellenism.



traversed the country, demolished the altars of the false gods, circumcised the children, and persecuted the heathen and heathenishly disposed. The sect of the Asidaeans also entrusted itself to their warlike protection (1 Macc. ii. 42).

Judas  
Maccabæus.

Mattathias soon died and left his leadership to Judas Maccabæus, by whom the struggle was carried on in the first instance after the old fashion; soon, however, it assumed larger dimensions, when regular armies were sent out against the insurgents. First Apollonius, the governor of Judæa, took the field; but he was defeated and fell in battle. Next came Seron, governor of Cœlesyria, who also was routed, near Bethheron (166). Upon this Lysias, the regent to whom Antiochus IV., who was busied in the far east, had entrusted the government of Syria and the charge of his son, Antiochus Philopator, a minor, sent a strong force under the command of three generals. Approaching from the west, it was their design to advance separately upon Jerusalem, but Judas anticipated their plan and compelled them to quit the field (166). The regent now felt himself called on to interpose in person. Invading Judæa from the south, he encountered the Jews at Bethsur, who, however, offered an opposition that was not easily overcome; he was prevented from resorting to the last measures by the intelligence which reached him of the death of the king in Elymais (165).

25th  
Kislev  
165 B.C.

The withdrawal of Lysias secured the fulfilment of the desires of the defenders of the faith in so far as it now enabled them to restore the Jerusalem worship to its previous condition. They lost no time in setting about the accomplishment of this. They were not successful indeed in wresting Acra from the possession of the Syrians, but they so occupied the garrison as to prevent it from interfering with the work of restoration. On 25th Kislev 165, the very day on which, three years before, "the abomination of desolation" had been inaugurated, the first sacrifice was offered on the new altar, and in commemoration of this the feast of the dedication was thenceforth celebrated.

As it was easy to see that danger still impended, the temple was put into a state of defence, as also was the town of Bethsur, where Lysias had been checked. But the favourable moment presented by the change of sovereign was made use of for still bolder attempts. Scattered over the whole of southern Syria there were a number of Jewish localities on which the heathens now proceeded to wreak their vengeance. For the purpose of rescuing these oppressed coreligionists, and of bringing them in safety to Judæa, the Maccabees made a series of excursions, extending in some cases as far as to Lebanon and Damascus. Lysias had his hands otherwise fully occupied, and perhaps did not feel much disposed to continue the fight on behalf of the cultus of Jupiter Capitolinus. Daily gaining in boldness, the Jews now took in hand also to lay regular siege to Acra. Then at last Lysias yielded to the pressure of Syrian and Jewish deputations and determined to take serious steps (162). With a large force he entered Judæa, again from the south; and laid siege to Bethsur. Judas vainly attempted the relief of the fortress; he sustained near Bethzachariah a defeat in which his brother Eleazar perished. Bethsur was unable to hold out, being short of provisions on account of the sabbatic year. The Syrians advanced next to Jerusalem, and besieged the temple; it also was insufficiently provisioned, and would soon have been compelled to surrender had not Lysias been again called away at the critical moment by other exigencies. A certain Philip was endeavouring to oust him from the regency; as it was necessary for him to have his hands free in dealing with this new enemy, he closed a treaty with the temple garrison and the people at large, in accordance with which at once the political subjection and the

religious freedom of the Jews were to be maintained. Thus Religion the situation as it had existed before Antiochus IV. was restored. Only no attempt was made to replace Menelaus as high priest and ethnarch; this post was to be filled by Alcimus. freedom granted by Lysias

The concessions thus made by Lysias were inevitable; and even King Demetrius I., son of Seleucus IV., who towards the end of 162 ascended the throne and caused both Lysias and his ward to be put to death, had no thought of interfering with their religious freedom. But the Maccabees desired something more than the *status quo ante*; after having done their duty they were disinclined to retire in favour of Alcimus, whose sole claim lay in his descent from the old heathenishly-disposed high-priestly family. Alcimus was compelled to invoke the assistance of the king, who caused him to be installed by Bacchides. He was at once recognized by the scribes and Asidaeans, for whom, with religious liberty, everything they wished had been secured; the claims to supremacy made by the Hasmonæans were of no consequence to them. Doubtless the masses also would ultimately have quietly accepted Alcimus, who of course refrained from interference with either law or worship, had he not abused the momentary power he derived from the presence of Bacchides to take a foolish revenge. But the consequence of his action was that, as soon as Bacchides had turned his back, Alcimus was compelled to follow him. For the purpose of restoring him a Syrian army once more invaded Judæa under Nicanor (160), but first at Kapharsalama and afterwards at Bethheron was defeated by Judas and almost annihilated in the subsequent flight, Nicanor himself being among the slain (13th Adar = Nicanor's day). Judas was now at the acme of his prosperity; about this time he concluded his (profitless) treaty with the Romans. But disaster was impending. In the month of Nisan, barely a month after the defeat of Nicanor, a new Syrian army under Bacchides entered Judæa from the north; near Elasa, southward from Jerusalem, a decisive battle was fought which was lost by Judas, and in which he himself fell.

The religious war properly so called had already been brought once for all to an end by the convention of Lysias. If the struggle continued to be carried on, it was not for the faith but for the supremacy,—less in the interests of the community than in those of the Hasmonæans. After the death of Judas the secular character which the conflict had assumed ever since 162 continually became more conspicuous. Jonathan Apphus fought for his house, and in doing so used thoroughly worldly means. The high-priesthood, *i.e.*, the ethnarchy, was the goal of his ambition. So long as Alcimus lived, it was far from his reach. Confined to the rocky fastnesses beside the Dead Sea, he had nothing for it but, surrounded by his faithful followers, to wait for better times. But on the death of Alcimus (159) the Syrians refrained from appointing a successor, to obviate the necessity of always having to protect him with military force. During the interregnum of seven years which followed Jonathan again came more and more to the front, so that at last Bacchides concluded an armistice with him on the basis of the *status quo* (1 Macc. ix. 73). From his residence at Michmash Jonathan now exercised a *de facto* authority over the entire nation. War for the supremacy.

When, accordingly, Alexander Balas, a reputed son of Antiochus IV., rose against Demetrius, both rivals exerted themselves to secure the alliance of Jonathan, who did not fail to benefit by their competition. First of all, Demetrius formally recognized him as prince of Judah; in consequence of this he removed to Jerusalem, and expelled the heathen and heathenishly disposed, who continued to maintain a footing only in Acra and Bethsur. Next, Alexander Balas conferred on him the title of "high priest of the nation and

Jonathan becomes high priest. friend of the king"; in gratitude for which Jonathan went over to his side (152). He remained loyal, although Demetrius now made larger offers; he was justified by the event, for Demetrius I. had the worst of it and was slain (150). The victorious Balas heaped honours upon Jonathan, who maintained his fidelity, and fought successfully in his interests when in 147 Demetrius II., the son of Demetrius I., challenged a conflict. The high priest was unable indeed to prevent the downfall of Alexander in 145; but Demetrius II., won by presents, far from showing any hostility, confirmed him in his position in consideration of a tribute of 300 talents.

Jonathan was grateful to the king, as he showed by going with 3000 men to his aid against the insurgent Antiochenes. But when the latter drew back from his promise to withdraw the garrison from Acra, he went over to the side of Trypho, who had set up a son of Alexander Balas (Antiochus) as a rival. In the war which he now waged as Seleucid strategus against Demetrius he succeeded in subduing almost the whole of Palestine. Meanwhile his brother Simon remained behind in Judæa, mastered the fortress of Bethsur, and resumed with great energy the siege of Acra. All this was done in the names of Antiochus and Trypho, but really of course in the interests of the Jews themselves. There were concluded also treaties with the Romans and Lacedæmonians, certainly not to the advantage of the Syrians.

Trypho sought now to get rid of the man whom he himself had made so powerful. He treacherously seized and imprisoned Jonathan in Ptolemais, and meditated an attack upon the leaderless country. But on the frontier Simon, the last remaining son of Mattathias, met him in force. All Trypho's efforts to break through proved futile; after skirting all Judæa from west to south, without being able to get clear of Simon, he at last withdrew to Peræa without having accomplished anything. On the person of Jonathan, whom he caused to be executed, he vented the spleen he felt on the discovery that the cause for which that prince had fought was able to gain the victory even when deprived of his help. Simon in point of fact was Jonathan's equal as a soldier and his superior as a ruler. He secured his frontier by means of fortresses, made himself master of Acra (141), and understood how to enable the people in time of peace to reap the advantages that result from successful war; agriculture, industry, and commerce (from the haven of Joppa) began to flourish vigorously. In grateful recognition of his services the high-priesthood and the ethnarchy were bestowed upon him as hereditary possessions by a solemn assembly of the people, "until a trustworthy prophet should arise."

13. Nominally the Seleucids still continued to possess the suzerainty. Simon naturally had detached himself from Trypho and turned to Demetrius II., who confirmed him in his position, remitted all arrears of tribute, and waived his rights for the future (142). The friendship of Demetrius II. and of his successor Antiochus Sidetes with Simon, however, lasted only as long as Trypho still remained in the way. But, he once removed, Sidetes altered his policy. He demanded of Simon the surrender of Joppa, Gazara, and other towns, besides the citadel of Jerusalem, as well as payment of all tribute resting due. The refusal of these demands led to war, which in its earlier stages was carried on with success, but the scales were turned after the murder of Simon when Sidetes in person took the field against John Hyrcanus, Simon's son and successor. Jerusalem capitulated; in the negotiations for peace the surrender of all the external possessions of the Jews was insisted upon; the suzerainty of the Syrians became once more a reality (135). But in 130 the powerful Antiochus Sidetes fell in an expedition against the

Parthians, and the complications anew arising in reference to the succession to the Syrian throne placed Hyrcanus to a position to recover what he had lost and to make new acquisitions. He subjugated Samaria and Idumæa, compelling the inhabitants of the latter to accept circumcision. Like his predecessors he too sought to secure the favour of the Romans, but derived no greater benefit from the effort than they had done. After a prosperous reign of thirty years he died in 105. By Josephus he is represented as a pattern of all that a pious prince ought to be; by the rabbins as representing a splendid high-priesthood. The darkness of the succeeding age lent a brighter colour to his image.

The external splendour of the Hasmonæan kingdom did not at once die away,—the downfall of the Seleucids, which was its negative condition, being also a slow affair. Judah Aristobulus, the son of Hyrcanus, who reigned for only one year, was the first to assume the Greek title of royalty; Ituræa was subdued by him, and circumcision forced upon the inhabitants. His brother Jonathan (Jannæus) Alexander (104-79), in a series of continual wars, which were never very prosperous, nevertheless succeeded in adding the whole coast of Philistia (Gaza) as well as a great portion of Peræa to his hereditary dominions.<sup>1</sup> But the external enlargement of the structure was secured at the cost of its internal consistency.

From the time when Jonathan, the son of Mattathias, began to carry on the struggle, no longer for the cause of God but for his own interests, the scribes and the Asidæans, as we have seen, had withdrawn themselves from the party of the Maccabees. There can be no doubt that from their legal standpoint they were perfectly right in contenting themselves, as they did, with the attainment of religious liberty, and in accepting Alcimus. The Hasmonæans had no hereditary right to the high-priesthood, and their politics, which aimed at the establishment of a national monarchy, were contrary to the whole spirit and essence of the second theocracy. The presupposition of that theocracy was foreign domination; in no other way could its sacred—i.e., clerical—character be maintained. God and the law could not but be forced into the background if a warlike kingdom, retaining indeed the forms of a hierocracy, but really violating its spirit at every point, should ever grow out of a mere pious community. Above all, how could the scribes hope to retain their importance if temple and synagogue were cast into the shade by politics and clash of arms? But under the first great Hasmonæans the zealots for the law were unable to force their way to the front; the enthusiasm of the people was too strong for them; they had nothing for it but to keep themselves out of the current and refuse to be swept along by it. Even under Hyrcanus, however, they gained more prominence, and under Jannæus their influence upon popular opinion was paramount. For under the last-named the secularization of the hierocracy no longer presented any attractive aspects; it was wholly repellent. It was looked upon as a revolting anomaly that the king, who was usually in the field with his army, should once and again assume the sacred mantle in order to perform the sacrifice on some high festival, and that his officers, profane persons as they were, should at the same time be holders of the highest spiritual offices. The danger which in all this threatened "the idea of Judaism" could not in these circumstances escape the observation of even the common people; for this idea was God and the law, not any earthly fatherland. The masses accordingly ranged themselves with ever-growing unanimity on the side of the

<sup>1</sup> A number of half-independent towns and communes lay as tempting subjects of dispute between the Seleucids, the Nabathæans or Arabs of Petra, and the Jews. The background was occupied by the Parthians and the Romans.

Jonathan becomes high priest.

Succeeded by Simon.

Hyrcanus.

Alexander Jannæus.

Pharisees and Sadducees.



Pharisees (*i.e.*, the party of the scribes) as against the Sadducees (*i.e.*, the Hasmonæan party).<sup>1</sup>

Rebellion of the Pharisees. On one occasion, when Alexander Jannæus had returned to Jerusalem at the feast of tabernacles, and was standing in his priestly vestments before the altar to sacrifice, he was pelted by the assembled crowd of worshippers with citrons from the green branches they carried. By the cruelty with which he punished this insult he excited the populace to the highest pitch, and, when he lost his army in the disaster of Gadara, rebellion broke out. The Pharisees summoned the Syrian king Demetrius Eucærus; Jannæus was worsted and fled into the desert. But, as he wandered in helplessness there, the patriotism of the people and sympathy for the heir of the Maccabees suddenly awoke; nature proved itself stronger than that consistency which in the cause of the Divine honour had not shrunk from treason. The insurgents for the most part went over to the side of the fugitive king; the others he ultimately overpowered after a struggle which lasted through several years, Demetrius having withdrawn his intervention. The vengeance which he took on the Pharisees was a bloody one; their only escape was by voluntary exile. Thenceforward he had peace so far as they were concerned. His last years were occupied with the reacquisition of the conquests which he had been compelled to yield to the Arabs during the civil war. He died in the field at the siege of Ragaba in Peræa (79).

Salome. Under Queen Salome, his widow, matters were as if they had been specially arranged for the satisfaction of the Pharisees. The high-priesthood passed to Salome's son Hyrcanus II.; she herself was only queen. In the management of external affairs her authority was absolute (*Ant.*, xiii. 16, 6); in home policy she permitted the scribes to wield a paramount influence. The common assertion indeed that the synedrium was at that time practically composed of scribes is inconsistent with the known facts of the case, the synedrium at that time was a political and not a scholastic authority.<sup>2</sup> In its origin it was the municipal council of Jerusalem (so also the councils of provincial towns are called synedria, Mark. xiii. 9), but its authority extended over the entire Jewish community; alongside of the elders of the city the ruling priests were those who had the greatest number of seats and votes. John Hyrcanus appears to have been the first to introduce some scribes into its composition; it is possible that Salome may have increased their number, but even so this high court was far from being changed into a college of scribes like that at Jannia. If the domination of the Pharisees at this time is spoken of, the expression cannot be understood as meaning that they already held all the public offices, but only at most that the holders of those offices found it necessary to administer and to judge in their spirit and according to their fundamental principles.

Insurrection of the Sadducees. The party of the Sadducees (consisting of the old Hasmonæan officers and officials, who were of priestly family indeed, but attached only slight importance to their priestly functions) at length lost all patience. Led by Aristobulus, the second son of Jannæus, the leaders of the party came to the palace, and begged the queen to dismiss them from the court and to send them into the provinces.

<sup>1</sup> פרוץ means "separated," and refers perhaps to the attitude of isolation taken by the zealots for the law during the interval between 162 and 105. פרוץ (Σαδδουκαϊός) comes from פרוץ (Σαδδούκ, LXX.), the ancestor of the higher priesthood of Jerusalem (1 Kings ii. 35; 1 Sam. ii. 35; Ezek. xlv. 15), and designates the governing nobility. The original character of the opposition, as it appeared under Jannæus, changed entirely with the lapse of time, on account of the Sadducees' gradual loss of political power, till they fell at last to the condition of a sort of "fronde."

<sup>2</sup> Kuenen, "Over de Samenstelling van het Sanhedrin," in *Proceedings of Royal Netherl. Acad.*, 1866.

There they were successful in securing possession of several fortresses<sup>3</sup> in preparation for insurrection, a favourable opportunity for which they were watching. Such an opportunity occurred, it seemed to Aristobulus, as his mother lay on her death-bed. The commandants of the fortresses were at his orders, and by their assistance an army also, with which he accordingly advanced upon Jerusalem, and, on the death of Salome, made himself master of the situation (69). Hyrcanus was compelled to resign office. With this event the good understanding between the civil government and the Pharisees came to an end; the old antagonisms became active once more, and now began to operate for the advantage of a third party, the Idumæan Antipater, Hyrcanus's confidential friend. Antipater. After the latter, aided by Antipater, had at length with great difficulty got himself into a position for asserting his rights against Aristobulus, the Pharisees could not do otherwise than rank themselves upon his side, and the masses joined them against the usurper. With the help of the Nabatæan monarch the effort to restore the elder brother to the supreme authority would doubtless have succeeded had not the Romans procured relief for Aristobulus, besieged as he was in Jerusalem (65), though without thereby recognizing his claims. Pompey continued to delay a decision on the controversy in 64 also when the rival claimants presented themselves before him at Damascus; he wished first to have the Nabatæans disposed of, and to have free access to them through Judæa. This hesitation roused the suspicions of Aristobulus; still he did not venture to take decisive action upon them. He closed the passes (to Mount Ephraim) against the Romans, but afterwards gave them up; he prepared Jerusalem for war, and then went in person to the Roman camp at Jericho, where he promised to open the gates of the city and also to pay a sum of money. But the Roman ambassadors found the gates barred, and had to return empty-handed. Aristobulus thereupon was arrested, and siege was laid to Jerusalem. The party of Hyrcanus, as soon as it had gained the upper hand, surrendered the town; but the supporters of Aristobulus took their stand in the temple, and defended it obstinately. In June 63 the place was carried by storm; Pompey personally inspected the Holy of Holies, but otherwise spared the religions feelings of the Jews. But he caused the chief promoters of the war to be executed, and carried Aristobulus and his family into captivity. He abolished the kingship, but restored the high-priestly dignity to Hyrcanus. The territory was materially reduced in area, and made tributary to the Romans; the city was occupied by a Roman garrison.

14. Henceforward Roman intervention forms a constant disturbing factor in Jewish history. The struggle between the Pharisees and the Sadducees continued indeed to be carried on, but only because the momentum of their old feud was not yet exhausted. The Pharisees in a sense had been victorious. While the two brothers were pleading their rival claims before Pompey, ambassadors from the Pharisees had made their appearance in Damascus to petition for the abolition of the kingship; this object had now to some extent been gained. Less ambiguous than the victory of the Pharisees was the fall of the Sadducees, who in losing the sovereignty of the Jewish state lost all real importance. But the intervention of the foreign element exercised its most powerful influence upon the temper of the lower classes. Though in times of peace the masses still continued to accept the guidance of the rabbins, their patriotism instantly burst into flame as soon as a pretender to the throne, belonging to the family of

<sup>3</sup> Alexandria, Cores (whence, according to Tuch, Ish-Karioth, Iscariot), and similar citadels which were at that time of great importance for Palestine and Syria.

Aristobulus, appeared in Palestine. During the decennia which immediately followed, Jewish history was practically absorbed in vain attempts to restore the old Hasmonæan kingdom. Insurrections of steadily increasing dimensions were made in favour of Aristobulus, the representative of the national cause. For Hyrcanus was not regarded as a Hasmonæan at all, but merely as the creature of Antipater and the Romans. First, in the year 57, Alexander the son of Aristobulus broke into rebellion, then in 56 Aristobulus himself and his son Antigonus, and in 55 Alexander again. Antipater was never able to hold his own; Roman intervention was in every case necessary. The division of the Hasmonæan state into five "aristocracies" by Gabinius had no effect in diminishing the feeling of national unity cherished by the Jews of Palestine. Once again, after the battle of Carthæ, a rising took place, which Cassius speedily repressed.

In 49 the great Roman civil war broke out; Cæsar instigated Aristobulus against Antipater, who in common with the whole East had espoused the cause of Pompey. But Aristobulus was poisoned by the opposite party while yet in Italy, and about the same time his son Alexander was also put to death at Antioch; thus the danger to Antipater passed away. After the battle of Pharsalus he went over to Cæsar's side, and soon after rendered him an important service by helping him out of his difficulties at Alexandria. By this means he earned the good will of Cæsar towards the whole body of the Jews, and secured for himself (or Hyrcanus) a great extension of power and of territory. The five "synedria" or "aristocracies" of Gabinius were superseded, the most important conquests of the Hasmonæans restored, the walls of Jerusalem, which Pompey had razed, rebuilt.

However indisputable the advantages conferred by the rule of Antipater, the Jews could not forget that the Idumæan, in name of Hyrcanus the rightful heir of the Hasmonæans, was in truth setting up an authority of his own. The Sadducean aristocracy in particular, which formerly in the synedrium had shared the supreme power with the high priest, endeavoured to restore reality once more to the nominal ascendancy which still continued to be attributed to the ethnarch and the synedrium. "When the authorities (*οἱ ἐν τέλει*) of the Jews saw how the power of Antipater and his sons was growing, their disposition towards him became hostile" (*Jos., Ant.*, xiv. 9, 3). They were specially jealous of the youthful Herod, to whom Galilee had been entrusted by his father. On account of the arbitrary execution of a robber chief Pzeelias, who perhaps had originally been a Hasmonæan partisan, they summoned him before the synedrium, under the impression that it was not yet too late to remind him that he was after all but a servant. But the defiant demeanour of the culprit, and a threatening missive which at the same time arrived from Sextus Cæsar demanding his acquittal, rendered his judges speechless, nor did they regain their courage until they had heard the stinging reproaches of Samæas the scribe. Yet the aged Hyrcanus, who did not comprehend the danger that was threatening himself, postponed judgment upon Herod, and gave him opportunity to withdraw. Having been appointed strategus of Colesyria by Sextus Cæsar in the meanwhile, he soon afterwards appeared before Jerusalem at the head of an army, and the authorities were compelled to address themselves in a conciliatory manner to his father and to Phasaël his brother in order to secure his withdrawal.

The attempt to crush the serpent which had thus effected a lodgment in the Hasmonæan house came too late. The result of it simply was that the Herodians had now the advantage of being able to distinguish between Hyrcanus and his "evil counsellors." From that moment

the downfall of the Sadducean notables was certain. It was of no avail to them that after the battle of Philippi (42) they accused Herod and Phasaël (Antipater having been murdered in 43) before Antony of having been helpful in every possible way to Cassius; Antony declared himself in the most decisive manner for the two brothers. In their despair, for properly speaking they were not national fanatics but only egoistic politicians,—they ultimately made common cause with Antigonus the son of Aristobulus, and threw themselves into the arms of the Parthians, perceiving the interests of the Romans and of Herod to be inseparable (40). Fortune at first seemed to have declared in favour of the pretender. The masses unanimously took his side; Phasaël committed suicide in prison; with a single blow Herod was stripped of all his following and made a helpless fugitive. He took refuge in Rome, however, where he was named king of Judæa by the senate, and after a somewhat protracted war he finally, with the help of the legions of Sosius, made himself master of Jerusalem (37). The captive Antigonus was beheaded at Antioch.

King Herod began his reign by reorganizing the synedrium; he ordered the execution of forty-five of its noblest members, his most zealous opponents. These were the Sadducean notables who long had headed the struggle against the Idumæan interlopers. Having thus made away with the leaders of the Jerusalem aristocracy, he directed his efforts to the business of corrupting the rest. He appointed to the most important posts obscure individuals, of priestly descent, from Babylon and Alexandria, and thus replaced with creatures of his own the old aristocracy. Nor did he rest content with this; in order to preclude the possibility of any independent authority ever arising alongside of his own, he abolished the life tenure of the high-priestly office, and brought it completely under the control of the secular power. By this means he succeeded in relegating the Sadducees to utter insignificance. They were driven out of their native sphere—the political—into the region of theoretical and ecclesiastical discussion, where they continued, but on quite unequal terms, their old dispute with the Pharisees.

It was during the period of Herod's activity that the Pharisees, strictly speaking, enjoyed their greatest prosperity (Samæas and Abtalion, Hillel and Shammai); in the synedrium they became so numerous as almost to equal the priests and elders. Quite consistently with their principles they had abstained from taking any part in the life and death struggle for the existence of the national state. Their leaders had even counselled the fanatical defenders of Jerusalem to open the gates to the enemy; for this service they were treated with the highest honour by Herod. He made it part of his general policy to favour the Pharisees (as also the sect of the Essenes, insignificant though it was), it being his purpose to restrict the national life again within those purely ecclesiastical channels of activity which it had abandoned since the Maccabæan wars. However reckless his conduct in other respects, he was always scrupulously careful to avoid wounding religious susceptibilities (*Ant.*, xiv. 16, 3). But although the Pharisees might be quite pleased that the high-priesthood and the kingship were no longer united in one and the same person, and that interest in the law again overshadowed interest in politics, the populace for their part could never forgive Herod for overthrowing the old dynasty. That he himself, at least in religious profession, was a Jew did not improve his position, but rather made it worse. It was not easy for him to stifle the national feeling after it had once been revived among the Jews; they could not forget the recent past, and objected to being thrust back into the time when foreign domination



was endured by them as a matter of course. The Romans were regarded in quite a different light from that in which the Persians and the Greeks had been viewed, and Herod was only the client of the Romans.

Herod's home and foreign policy. His greatest danger seemed to arise from the still surviving members of the Hasmonæan family, to whom, as is easily understood, the national hopes clung. In the course of the earlier years of his reign he removed every one of them from his path, beginning with his youthful brother-in-law Aristobulus (35), after whom came his old patron Hyrcanus II. (30), then Mariamne his wife (29), and finally his stepmother Alexandra (28), the daughter of Hyrcanus and the widow of Alexander Aristobuli. Subsequently, in 25, he caused Costobarus and the sons of Babas to be executed. While thus occupied with domestic affairs, Herod had constant trouble also in his external relations, and each new phase in his political position immediately made itself felt at home. In the first instance he had much to suffer from Cleopatra, who would willingly have seen Palestine reduced under Egyptian domination once more, and who actually succeeded in inducing Antony to take from Herod several fair and valuable provinces of his realm. Next, his whole position was imperilled by the result of the battle of Actium; he had once more ranged himself upon the wrong side. But his tact did not fail him in winning Octavianus, as before it had made Antony his friend. In fact he reaped nothing but advantage from the great overturn which took place in Roman affairs; it rid him of Cleopatra, a dangerous enemy, and gave him in the new emperor a much better master than before.

Close of his reign. During the following years he had leisure to carry out those splendid works of peace by which it was his aim to ingratiate himself with the emperor. He founded cities and harbours (Antipatris, Cæsarea), constructed roads, theatres, and temples, and subsidized far beyond his frontier all works of public utility. He taxed the Jews heavily, but in compensation promoted their material interests with energy and discretion, and built for them, from 20 or 19 B.C. onwards, the temple at Jerusalem. To gain their sympathies he well knew to be impossible. Apart from the Roman legions at his back his authority had its main supports in his fortresses and in his system of espionage.

But just as the acme of his splendour had been reached, he himself became the instrument of a terrible vengeance for the crimes by which his previous years had been stained; as executioner of all the Hasmonæans, he was now constrained to be the executioner of his own children also. His suspicious temper had been aroused against his now grown-up sons by Mariamne, whose claim through their mother to the throne were superior to his own; his brother Pheroras and his sister Salome made it their special business to fan his jealousy into flame. To show the two somewhat arrogant youths that the succession was not so absolutely secure in their favour as they were supposing, the father summoned to his court Antipater, the exiled son of a former marriage. Antipater, under the mask of friendship, immediately began to carry on infamous intrigues against his half brothers, in which Pheroras and Salome unconsciously played into his hands. For years he persevered alike in favouring and unfavouring circumstances with his part, until at last, by the machinations of a Lacedæmonian Eurycles, who had been bribed, Herod was induced to condemn the sons of Mariamne at Berytus, and cause them to be strangled (Samaria, 7-6 B.C.). Not long afterwards a difference between Antipater and Salome led to the exposure of the former. Herod was compelled to drain the cup to the dregs; he was not spared the knowledge that he had murdered his children without a cause. His remorse threw him into a serious illness, in which his

strong constitution wrestled long with death. While he lay at Jericho near his end he gave orders for the execution of Antipater also; and to embitter the joy of the Jews at his removal he caused their elders to be shut up together in the hippodrome at Jericho with the injunction to butcher them as soon as he breathed his last, that so there might be sorrow throughout the land. The latter order, however, was not carried out.

His death (4 B.C.) gave the signal for an insurrection of small beginnings which gradually spread until it ultimately infected all the people; it was repressed by Varus with great cruelty. Meanwhile Herod's connexions were at Rome disputing about the inheritance. The deceased king (his will) (who was survived by several children of various marriages) had made a will, which was substantially confirmed by Augustus. By it his son Philip received the northern portion of the territory on the east of the Jordan along with the district of Paneas (Cæsarea Philippi); his thirty seven years' reign over this region was happy. Another son, Herod Antipas, obtained Galilee and Peræa; he beautified his domains with architectural works (Sepphoris, Tiberias; Livias, Machærus), and succeeded by his fox-like policy in ingratiating himself with the emperors, particularly with Tiberius, for that very cause, however, becoming odious to the Roman provincial officials. The principal heir was Archelaus, to whom Idumæa, Judæa, and Samaritis were allotted; Augustus at first refused him the title of king. Archelaus had experienced the greatest difficulty in carrying through his claims before the emperor in face of the manifold oppositions of his enemies; the vengeance which he wreaked upon his subjects was so severe that in 6 A.D. a Jewish and Samaritan embassy besought the emperor for his deposition. Augustus assented, banishing Archelaus to Vienne, and putting in his place a Roman procurator. Thenceforward Judæa continued under procurators, with the exception of a brief interval (41-44 A.D.) during which Herod Agrippa I. united under his sway all the dominions of his grandfather.<sup>1</sup>

Advantage to the Sadducees. 15. The termination of the vassal kingship resulted in manifest advantage to the Sadducees. The high priest and synedrium again acquired political importance; they were the responsible representatives of the nation in presence of the suzerain power, and conceived themselves to be in some sort lords of land and people (John xi. 48). For the Pharisees the new state of affairs appears to have been less satisfactory. That the Romans were much less oppressive to the Jews than the rulers of the house of Herod was a consideration of less importance to them than the fact that the heathen first unintentionally and then deliberately were guilty of the rudest outrages upon the law, outrages against which those sly half-Jews had well understood how to be on their guard. It was among the lower ranks of the people, however, that hatred to the Romans had its proper seat. On the basis of the views and tendencies which had long prevailed there, a new party was now formed, that of the Zealots, which did not, like the Pharisees, aim merely at the fulfilment of all righteousness, *i.e.*, of the law, and leave everything else in the hands of God, but was determined to take an active part in bring-

<sup>1</sup> Agrippa was the grandson of Mariamne through Aristobulus. Caligula, whose friendship he had secured in Rome, bestowed upon him in 37 the dominions of Philip with the title of king, and afterwards the tetrarchy of Antipas, whom he deposed and banished to Lugdunum (39). Claudius added the possessions of Archelaus. But the kingdom was again taken away from his son Agrippa II. (44), who, however, after the death of his uncle, Herod of Chalcis, obtained that principality for which at a later period (52) the tetrarchy of Philip was substituted. His sister Berenice is known as the mistress of Titus; another sister Drusilla was the wife of the procurator Felix. The descendants of Mariamne through Alexander held for some time an Armenian principality.

ing about the realization of the kingdom of God (Jos., *Ant.*, xviii. 1, 1).

As the transition to the new order of things was going on, the census of Quirinius took place (6-7 A.D.); it occasioned an immense excitement, which, however, was successfully allayed. On the withdrawal of Quirinius, Coponius remained behind as procurator of Judæa; he was followed, under Augustus, by Marcus Ambivius and Annius Rufus; under Tiberius, by Valerius Gratus (15-26 A.D.) and Pontius Pilatus (26-36 A.D.); under Caligula, by Marcellus (36-37) and Marullus (37-41 A.D.). The procurators were subordinate to the imperial legati of Syria; they resided in Caesarea, and visited Jerusalem on special occasions only. They had command of the military, and their chief business was the maintenance of the peace and the care of the revenue. They interested themselves in affairs of religion only in so far as these had a political side; the temple citadel Antonia was constantly garrisoned with a cohort. The administration of justice appears to have been left to a very considerable extent in the hands of the syndrium, but it was not allowed to give effect to any capital sentence. At the head of the native authorities stood at this time not so much the actual high priest as the college of the chief priests. The actual office of high priest had lost its political importance in consequence of the frequency with which its holders were changed; thus, for example, Annas had more influence than Caiaphas.

The principle of interfering as little as possible with the religious liberty of the Jews was rudely assailed by the emperor Caius, who, like a second Antiochus, after various minor vexations, gave orders that his image should be set up in the temple of Jerusalem as in others elsewhere. It was entirely through the courage and tact of the Syrian governor P. Petronius that the execution of these orders was temporarily postponed until the emperor was induced by Agrippa I. to withdraw them. Caius soon afterwards died, and under the rule of Agrippa I., to whom the government of the entire kingdom of his grandfather was committed by Claudius, the Jews enjoyed much prosperity; in every respect the king was all they could wish. This very prosperity seems, however, to have caused them fresh danger. For it made them feel the government by procurators, which was resumed after the death of Agrippa I., to be particularly hard to bear, whatever the individual characters of these might be. They were Cuspius Fadus (from 44, under whom Theudas), Tiberius Alexander (the Romanized nephew of Philo, till 48), Cumanus (48-52, under whom the volcano already began to give dangerous signs of activity), and Felix (52-60). Felix, who has the honour to be pilloried in the pages of Tacitus, contrived to make the dispeace permanent. The influence of the two older parties, both of which were equally interested in the maintenance of the existing order, and in that interest were being drawn nearer to each other, diminished day by day. The masses broke loose completely from the authority of the scribes; the ruling nobility adapted itself better to the times; under the circumstances which then prevailed, it is not surprising that they became thoroughly secular and did not shrink from the employment of directly immoral means for the attainment of their ends. The zealots became the dominant party. It was a combination of noble and base elements; superstitious enthusiasts (Acts xxi. 38) and political assassins, the so-called sicarii, were conjoined with honest but fanatical patriots. Felix favoured the sicarii in order that he might utilize them; against the others his hostility raged with indiscriminating cruelty, yet without being able to check them. The anarchy which he left behind him as a legacy was beyond the control of his able successor Porcius Festus (60-62), and the last two procurators, Albinus (62-64) and Gessius Florus, acted as

if it had been their special business to encourage and promote it. All the bonds of social order were dissolved; no property was secure; the assassins alone prospered, and the procurators went shares with them in the profits.

It was inevitable that deep resentment against the Romans should be felt in every honest heart. At last it found expression. During his visit to Jerusalem in May 66 Florus laid hands upon the temple treasure; the Jews allowed themselves to go so far as to make a joke about it, which he avenged by giving over a portion of the city to be plundered, and crucifying a number of the inhabitants. He next insisted upon their kissing the rod, ordering that a body of troops which was approaching should be met and welcomed. At the persuasion of their leaders the Jews forced themselves even to this; but a constant succession of fresh insults and cruelties followed, till patience was quite exhausted at last, and in a violent street fight the Romans were so handled that the procurator withdrew from the town, leaving only the cohort in Antonia. Once again was an attempt at pacification made by Agrippa II., who hastened from Alexandria with this purpose, but the Jews could not bring themselves to make submission to Gessius Florus. It so happened that at this juncture the fortress of Masada on the Dead Sea fell into the hands of the Zealots; the courage of the party of action rose, and at the instance of the hot-headed Eleazar the son of Ananias, a man, still young, of highest priestly family, the sacrifice on behalf of the emperor was discontinued, i.e., revolt was declared. But the native authorities continued opposed to a war. At their request King Agrippa sent soldiers to Jerusalem; at first they appeared to have some effect, but ultimately they were glad to make their escape in safety from the city. The cohort in Antonia was in like manner unable to hold its own; freedom was given it to withdraw; but, contrary to the terms of capitulation, it was put to the sword. The war party now signalized its triumph over all elements of opposition from within by the murder of the high priest Ananias.

A triumph was gained also over the outer foe. The Syrian legate, Cestius Gallus, appeared before Jerusalem in the autumn of 66, but after a short period raised the siege; his deliberate withdrawal was changed into a precipitate flight in an attack made by the Jews at Bethoron. The revolt now spread irresistibly through all ranks and classes of the population, and the aristocracy found it expedient itself to assume the leadership. An autonomous government was organized, with the noblest members of the community at its head; of these the most important was the high priest Ananus.

Meanwhile Nero entrusted the conduct of the Jewish war to Vespasian, his best general. In the spring of 67 he began his task in Galilee, where the historian Josephus had command of the insurgents. The Jews entirely distrusted him and he them; in a short time the Romans were masters of Galilee, only a few strong places holding out against them. Josephus was besieged in Jotapata, Galilee and taken prisoner; the other places also were unable to hold out long. Such of the champions of freedom in Galilee as escaped betook themselves to Jerusalem; amongst these was the Zealot leader John of Giscala. There they told the story of their misfortunes, of which they laid the blame upon Josephus, and upon the aristocratic government as having no heart for the common cause and having in treachery for their motto. The Zealots now openly aimed at the overthrow of the existing government, but Ananus bravely withstood them, and pressed so hard on them that they summoned the Idumeans into the city to their aid. These honourable fanatics indeed withdrew again as soon as they had discovered that they were being used for sinister designs; but in the meanwhile they had

Dissatis-  
faction  
with  
their  
govern-  
ment.

Revolt.

Agrippa I.

Procu-  
rators re-  
stored.

Affairs in  
Galilee  
Jerusa-  
lem.



accomplished the work of the Zealots. The old magistracy of Jerusalem was destroyed, Ananus with the heads of the aristocracy and very many other respectable citizens put to death. The radicals, for the most part not natives of the city, came into power; John of Giscala at their head tyrannized over the inhabitants.

While these events were taking place in Jerusalem, Vespasian had subdued the whole country, with the exception of one or two fortresses. But as he was setting about the siege of the capital, tidings arrived of the death of Nero, and the offensive was discontinued. For almost two years (June 68 to April 70), with a short break, war was suspended. When Vespasian at the end of this period became emperor, he entrusted to Titus the task of reducing Jerusalem. There in the interval the internal struggle had been going on, even after the radicals had gained the mastery. As a counterpoise to John of Giscala the citizens had received the guerilla captain Simon bar Giora into the city; the two were now at feud with each other, but were alike in their rapacity towards the citizens. John occupied the temple, Simon the upper city lying over against it on the west. For a short time a third entered into competition with the two rivals, a certain Eleazar who had separated from John and established himself in the inner temple. But just as Titus was beginning the siege (Easter, 70) John contrived to get rid of this interloper.

Titus attacked from the north. After the lower city had fallen into his hands, he raised banks with a view to the storm of the temple and the upper city. But the defenders, who were now united in a common cause, taught him by their vigorous resistance that his object was not to be so quickly gained. He therefore determined to reduce them by famine, and for this end completely surrounded the city with a strong wall. In the beginning of July he renewed the attack, which he directed in the first instance against the temple. The tower of Antonia fell on the 5th, but the temple continued to be held notwithstanding; until the 17th the daily sacrifice continued to be offered. The Romans succeeded in gaining the outer court in August only. To drive them out, the Jews in the night of August 10-11 made a sortie, but were compelled to retire, the enemy forcing their way behind them into the inner court. A legionary flung a firebrand into an annexe of the temple, and soon the whole structure was in flames. A terrible slaughter of the defenders ensued, but John with a determined band succeeded in cutting his way out, and by means of the bridge over the Tyropœon valley made his escape into the upper city.

No attack had as yet been directed against this quarter; but famine was working terrible ravages among the crowded population. Those in command, however, refused to capitulate unless freedom to withdraw along with their wives and children were granted. These terms being withheld, a storm, after the usual preparations on the part of the Romans, took place. The resistance was feeble; the strong towers were hardly defended at all; Simon bar Giora and John of Giscala now thought only of their personal safety. In the unprotected city the Roman soldiers spread fire and slaughter unchecked (September 7, 70).

Of those who survived also some were put to death; the rest were sold or carried off to the mines and amphitheatres. The city was levelled with the ground; the tenth legion was left behind in charge. Titus took with him to Rome for his triumphal procession Simon bar Giora and John of Giscala, along with seven hundred other prisoners, also the sacred booty taken from the temple, the candlestick, the golden table, and a copy of the Torah. He was slightly premature with his triumph; for some time elapsed, and more than one bloody battle was necessary, before the

rebellion was completely stifled. It did not come wholly to an end until the fall of Masada (April 73).

16. Even now Palestine continued for a while to be the centre of Jewish life, but only in order to prepare the way for its transition into thoroughly cosmopolitan forms. The development of thought sustained no break on account of the sad events which had taken place, but was only directed once more in a consistent manner towards these objects which had been set before it from the time of the Babylonian exile. On the ruins of the city and of the temple the Pharisaic Judaism which rests upon the law and the school celebrated its triumph. National fanaticism indeed was not yet extinguished, but it burnt itself completely out in the vigorous insurrection led by Simeon bar Koziba (Bar Cochebas, 132-135). That a conspicuous rabbin, Akiba, should have taken part in it, and have recognized in Simeon the Messiah, was an inconsistency on his part which redounds to his honour.

Inasmuch as the power of the rabbins did not depend upon the political or hierarchical forms of the old commonwealth, it survived the fall of the latter. Out of what hitherto had been a purely moral influence something of an official position now grew. They formed themselves into a college which regarded itself as a continuation of the old synedrium, and which carried forward its name. At first its seat was at Jamnia, but it soon removed to Galilee, and remained longest at Tiberias. The presidency was hereditary in the family of Hillel, with the last descendants of whom the court itself came to an end.<sup>1</sup> The respect in which the synedrial president was held rapidly increased; like Christian patriarchs under Mahometan rule, he was also recognized by the imperial government as the municipal head of the Jews of Palestine, and bore the secular title of the old high priests (nasi, ethnarch, patriarch). Under him the Palestinian Jews continued to form a kind of state within a state until the 5th century. From the non-Palestinian Jews he received offerings of money. (Comp. Göthofredus on *Cod. Theod.*, xvi, 8, "De Judæis"; and Morinus, *Exer. Bibl.*, ii., exerc. 3, 4.)

The task of the rabbins was so to reorganize Judaism under the new circumstances that it could continue to assert its distinctive character. What of external consistency had been lost through the extinction of the ancient commonwealth required to be compensated for by an inner centralization proportionally stronger. The separation from everything heathenish became more pronounced than before; the use of the Greek language was of necessity still permitted, but at least the Septuagint was set aside by Aquila (*Cod. Justinian.*, Nov. 146) inasmuch as it had now become the Christian Bible. For to this period also belongs the definitive separation between the synagogue and the church; henceforward Christianity could no longer figure as a Jewish sect. Intensified exclusiveness was accompanied by increased internal stringency. What at an earlier period had still remained to some extent fluid now became rigidly fixed; for example, an authentic text of the canon was now established, and at the same time the distinction between canon and apocrypha sharply drawn. The old tendency of the scribes to leave as little as possible free to the individual conscience, but to bring everything within the scope of positive ordinance, now celebrated its greatest triumphs. It was only an apparent movement in the direction of liberty, if regulations which had become quite impossible were now modified or cancelled. The most influential of the rabbins were indeed the least solicitous about the maintenance of what was old, and had no hesita-

<sup>1</sup> The following is the genealogy of the first Nasi:—Gamaliel ben Simeon (Jos., *Vit.*, 38) ben Gamaliel (Acts v. 34, xxii. 3) ben Simeon ben Hillel. The name Gamaliel was that which occurred most frequently among the patriarchs; see *Cod. Theod.*, xvi, 8, 22.

Titus.

Fall of  
Jerusa-  
lem.

tion in introducing numerous and thorough-going innovations; but the conservatives R. Eliezer ben Hyrcanus and R. Ishmael ben Elisha were in truth more liberal-minded than the leaders of the party of progress, notably than R. Akiba. Even the Ultramontanes have never hesitated at departures from the usage of the ancient and mediæval church; and the Pharisaic rabbins were guided in their innovations by liberal principles no more than they. The object of the new determinations was simply to widen the domain of the law in a consistent manner, to bring the individual entirely under the iron rule of system. But the Jewish communities gave willing obedience to the hierarchy of the rabbins; Judaism had to be maintained, cost what it might. That the means employed were well adapted to the purpose of maintaining the Jews as a firmly compacted religious community even after all bonds of nationality had fallen away cannot be doubted. But whether the attainment of this purpose by incredible exertion was a real blessing to themselves and the world may very well be disputed.

Mishna  
and  
Talmud.

One consequence of the process of intellectual isolation and of the effort to shape everything in accordance with hard and fast rules and doctrines was the systematization and codification of juristic and ritual tradition, a work with which a beginning was made in the century following the destruction of Jerusalem. Towards the end of the 2d century the Pharisaic doctrine of Hillel as it had been further matured by Akiba was codified and elevated to the position of statute law by the patriarch Rabban Judah the Holy (Mishna).<sup>1</sup> But this was only the first stage in the process of systematizing and fixing tradition. The Mishna became itself the object of rabbinical comment and supplement; the Tannaim, whose work was registered in the Mathnetha (Mishna, *δευτέρωσις* = doctrine), were followed by the Amoraim, whose work in turn took permanent shape in the Gemara (= doctrine). The Palestinian Gemara was reduced to writing in perhaps the 4th or 5th century; unfortunately it has been preserved to us only in part, but appears to have reached the Middle Ages in a perfect state (comp. Schiller-Szinessy in the *Academy*, 1878, p. 170 *sqq.*). Even thus the process which issued in the production of the Talmud was not yet completed; the Babylonian Amoraim carried it forward for some time longer, until at last at the rise of Islam the Babylonian Gemara was also written down.

Jewish  
schools  
in Baby-  
lonia.

In the 5th century Palestine ceased to be the centre of Judaism. Several circumstances conspired to bring this about. The position of the Jews in the Roman empire had changed for the worse with the elevation of Christianity to be the religion of the state; the large autonomy which until then they had enjoyed in Palestine was now restricted; above all, the family of the patriarchs, which had come to form a veritable dynasty, became extinct.<sup>2</sup> But this did not make an end of what may be called the Jewish church-state; henceforward it had its home in Babylonia. From the period of the exile, a numerous and coherent body of Jews had continued to subsist there; the Parthians and Sassanidæ granted them self-government; at their head was a native prince (Resh Galutha,—can be clearly traced from 2d century A.D. onwards) who, when the Palestinian patriarchate came to an end, was left without a rival. This

<sup>1</sup> The Mishna succeeded almost, but not quite, in completely doing away with all conflicting tendencies. At first the heterodox tradition of that time was also committed to writing (R. Ishmael ben Elisha) and so handed down,—in various forms (collection of the Baraitas, that is, of old precepts which had not been received into the Mishna, in the Tosephta). Nor did the active opposition altogether die out even at a later period; under favouring circumstances it awoke to new life in Karaism, the founder of which, Anan ben David, lived in Babylonia in the middle of the 8th century.

<sup>2</sup> Comp. Gothofrédus on *Cod. Theod.*, xvi. 8, 29, ad voc. "post excessum patriarcharum."

remarkable relic of a Jewish commonwealth continued to exist until the time of the Abassides.<sup>3</sup> Even as early as the beginning of the 3d century A.D. certain rabbins, at their head Abba Areka (Rab) had migrated from Palestine and founded a settlement for learning in the law in Babylonia. The schools there (at Pumbeditha, Sora, Nahardea) prospered greatly, vied with those of Palestine, and continued to exist after the cessation of the latter, when the patriarchate became extinct; thus they had the last word in the settlement of doctrine.

Alongside of the settlement of tradition went another task, that of fixing the letters of the consonantal text of the Bible (by the Massora), its vowel pronunciation (by Massora, the punctuation), and its translation into the Aramaic vernacular (Targum). Here also the Babylonians came Targums after the Palestinian, yet of this sort of erudition Palestine continued to be the headquarters even after the 5th century.

With this task,—that of attaining to the greatest possible conformity to the letter and of continuing therein,—the inner development of Jewish thought came to an end.<sup>4</sup> The later Hebrew literature, which does not fall to be considered here, contributed very few new elements; in so far as an intellectual life existed at all among the Jews of the Middle Ages, it was not a growth of native soil but proceeded from the Mahometan or Latin culture of individuals. The Kabbâla at most, and even it hardly with justice, can be regarded as having been a genuine product of Judaism. It originated in Palestine, and subsequently flourished chiefly in the later Middle Ages in Spain, and, like all other methodized nonsense, had strong attractions for Christian scholars.

17. Something still remains to be said with reference to the diaspora. We have seen how it began; in spite of Josephus (*Ant.*, xi. 5, 2), it is to be carried back not to the Assyrian but merely to the Babylonian captivity; it was not composed of Israelites, but solely of citizens of the southern kingdom. It received its greatest impulse from Alexander, and then afterwards from Cæsar. In the Græco-Roman period Jerusalem at the time of the great festival presented the appearance of a veritable Babel (Acts ii. 9-11); with the Jews themselves were mingled the proselytes (Acts ii. 11), for even already that religion was gaining considerable conquests among the heathen; as King Agrippa I. writes to the emperor Caius (Philo, *Legat. ad Caium*, sec. 36), "Jerusalem is the metropolis not only of Judæa but of very many lands, on account of the colonies which on various occasions (*ἐπὶ καιρῶν*) it has sent out into the adjoining countries of Egypt, Phœnicia, Syria, and Cœlesyria, and into the more remote Pamphylia, Cilicia, the greater part of Asia Minor as far as to Bithyria and the remotest parts of Pontus; likewise into Europe,—Thessaly, Bœotia, Macedonia, Ætolia, Attica, Argos, Corinth, most parts (and these the fairest) of the Peloponnesus. Nor are the Jewish settlements confined to the mainland only; they are found also in the more important islands, Eubœa, Cyprus, Crete. I do not insist on the countries beyond the Euphrates, for with few exceptions all of them, Babylon and the fertile regions around it, have Jewish inhabitants." In the west of Europe also they were not wanting; many thousands of them lived in Rome. In those cities where they were at all numerous they during the imperial period formed separate communities. Josephus has preserved a great variety of documents in which the Roman authorities recognize their rights and liberties (especially as regards the Sabbath rest and the observance of festivals). Of greatest importance was the

<sup>3</sup> See Nöldeke, *Tabari*, 68, 118, and Kremer, *Culturgeschichte des Orients unter den Chalifen*, i. 183, ii. 176.

<sup>4</sup> Comp. F. Weber, *System der altjüdischen palästinischen Theologie*, Leipzig, 1880.



community in Alexandria; according to Philo a million of Jews had their residence there, under an ethnarch for whom a gerusia was afterwards substituted by Augustus (*In Flac.*, secs. 6, 10). The extent to which this diaspora was helpful in the diffusion of Christianity, the manner in which the mission of the apostles everywhere attached itself to the synagogues and proseuchai, is well known from the New Testament. That the Christians of the 1st century had much to suffer along with the Jews is also a familiar fact. For at this period, in other respects more favourable to them than any other had previously been, the Jews had occasionally to endure persecution. The emperors, taking umbrage at their intrusiveness, more than once banished them from Rome (Acts xviii. 2). The good will of the native population they never secured; they were most hated in Egypt and Syria, where they were strongest.<sup>1</sup>

The position of the Jews in the Roman empire was naturally not improved by the great risings under Nero, Trajan (in Cyrene, Cyprus, Mesopotamia), and Hadrian. The East, strictly so called, became more and more their proper home. The Christianization of the empire helped still further in a very special way to detach them from the Western world.<sup>2</sup> They sided with the Persians against the Byzantines; in the year 614 they were even put in possession of Jerusalem by Chosroes, but were not long able to hold their own against Heraclius.<sup>3</sup> With Islam also they found themselves in greater sympathy than with Christianity, although they were cruelly treated by Mahomet in Arabia, and driven by Omar out of the Hejaz, and notwithstanding the facts that they were as matter of course excluded from citizenship, and that they were held by Moslems as a whole in greater contempt than the Christians.<sup>4</sup> They thrive especially well on what may be called the bridge between East and West, in Mauretania and Spain, where they were the intellectual intermediaries between the Arab and the Latin culture. In the Sephardim and Ashkenazim the distinction between the subtler Oriental and the more conservative Western Jews has maintained itself in Europe also. From the 8th century onwards Judaism put forth a remarkable side shoot in the Khazars on the Volga; if legend is to be believed, but little was required at one time to have induced the Russians to accept the Jewish rather than the Christian faith.

In the West the equal civil rights which Caracalla had

<sup>1</sup> Comp. Schürer, *Neuest. Zeitgeschichte* (1874), sec. 31. The place taken by the Jewish element in the world of that time is brilliantly set forth by Mommsen in his *History of Rome* (bk. v. ch. ii.; Eng. tr. iv. p. 538 sqq., 1866):—"How numerous even in Rome the Jewish population was already before Cæsar's time, and how closely at the same time the Jews even then kept together as fellow-countrymen, is shown by the remark of an author of this period, that it was dangerous for a governor to offend the Jews in his province, because he might then certainly reckon on being hissed after his return, by the populace of the capital. Even at this time the predominant business of the Jews was trade. . . . At this period too we encounter the peculiar antipathy of the Occidentals towards this so thoroughly Oriental race and their foreign opinions and customs. This Judaism, although not the most pleasing feature in the nowhere pleasing picture of the mixture of nations which then prevailed, was nevertheless an historical element developing itself in the natural course of things, . . . which Cæsar just like his predecessor Alexander fostered as far as possible. . . . They did not of course contemplate placing the Jewish nationality on an equal footing with the Hellenic or Italo-Hellenic. But the Jew who has not, like the Occidental, received the Pandora's gift of political organization, and stands substantially in a relation of indifference to the state, who moreover is as reluctant to give up the essence of his national idiosyncrasy as he is ready to clothe it with any nationality at pleasure and to adapt himself up to a certain degree to foreign habits—the Jew was for this very reason as it were made for a state which was to be built on the ruins of a hundred living polities, and to be endowed with a somewhat abstract and, from the outset, weakened nationality. In the ancient world also Judaism was an effective leaven of cosmopolitanism and of national decomposition."

<sup>2</sup> For a brief time only were they again favoured by Julian the Advocate: comp. Gibbon chap. xxiii. <sup>3</sup> Gibbon, chap. xlvi.

conferred on all free inhabitants of the empire came to an end, so far as the Jews were concerned, in the time of Constantine. The state then became the secular arm of the church, and took action, though with less severity, against Jews just as against heretics and pagans. As early as the year 315, Constantine made conversion from Christianity to Judaism a penal offence, and prohibited Jews, on pain of death, from circumcising their Christian slaves. These laws were re-enacted and made more severe by Constantius, who attached the penalty of death to marriages between Jews and Christians. Theodosius I. and Honorius, indeed, by strictly prohibiting the destruction of synagogues, and by maintaining the old regulation that a Jew was not to be summoned before a court of justice on the Sabbath day, put a check upon the militant zeal of the church by which even Chrysostom, for example, allowed himself to be carried away at Antioch. But Honorius rendered them ineligible for civil or military service, leaving open to them only the bar and the decurionate, the latter being a *privilegium odiosum*. Their liberty to try cases by their own law was curtailed; cases between Jews and Christians were to be tried by Christian judges only. Theodosius II. prohibited them from building new synagogues, and anew enforced their disability for all state employments. Most hostile of all was the orthodox Justinian, who, however, was still more severe against Pagans and Samaritans.<sup>4</sup> He harassed the Jews with a law enjoining them to observe Easter on the same day as the Christians, a law which it was of course found impossible to carry out.<sup>5</sup>

In the Germanic states which arose upon the ruins of the Roman empire, the Jews did not fare badly on the whole. It was only in cases where the state was dominated by the Catholic Church, as, for example, among the Spanish Visigoths, that they were cruelly oppressed; among the Arian Ostrogoths, on the other hand, they had nothing to complain of. One thing in their favour was the Germanic principle that the law to be applied depended not on the land but on the nationality, as now in the east Europeans are judged by the consuls according to the law of their respective nations. The autonomy of the Jewish communities, which had been curtailed by the later emperors, was now enlarged once more under the laxer political and legal conditions. The Jews fared remarkably well under the Frankish monarchy; the Carolingians helped them in every possible way, making no account of the complaints of the bishops. They were allowed to hold property in land, but showed no eagerness for it; leaving agriculture to the Germans, they devoted themselves to trade. The market was completely in their hands; as a specially lucrative branch of commerce they still carried on the traffic in slaves which had engaged them even in ancient times.<sup>6</sup>

Meanwhile the church was not remiss in seeking constantly repeated re-enactments of the old imperial laws, in the framing of which she had had paramount influence, and which she now incorporated with her own canon law.<sup>7</sup> Gradually she succeeded in attaining her object. In the later Middle Ages the position of the Jews in the Christian society deteriorated. Intercourse with them was shunned;

<sup>4</sup> *Cod. Theod.*, xvi. 8: "De Judæis, Cœlicolis, et Samaritanis"; *Cod. Just.*, i. 9: "De Judæis et Cœlicolis." With regard to these cœlicolæ, see Gothofredus on *Cod. Theod.*, xvi. 8, 9, and also J. Bernays "Ueber die Gottesfürchtigen bei Juvenal," in the *Comm. Philol. in hon. Th. Mommsen*, 1877, p. 163. <sup>5</sup> Gibbon, ch. xlvi.

<sup>6</sup> Agobardus Lugdunensis, *De Insolentia Judæorum, De Judæis superstitionibus*. Agobard was no superstitious fanatic, but one of the weightiest and most enlightened ecclesiastics of the Middle Ages. <sup>7</sup> Compare Decret. i., dist. 45, c. 3; Decret. ii., caus. 23, quest. 8, c. 9, caus. 28, qu. 1, c. 10-12; Decret. iii., de consecr., dist. 4, c. 93; Decretal. Greg. 5, 6 ("De Judæis, Sarracenis, et eorum servis"), 5, 19, 19; Extrav. commun. 5, 2.

their isolation from being voluntary became compulsory; from the 13th century onwards they were obliged to wear, as a distinctive mark (more necessary in the East than in the West), a round or square yellow badge on their breast.<sup>1</sup> The difference of religion elicited a well-marked religious hate with oft repeated deadly outbreaks, especially during the period of the crusades, and afterwards when the Black Death was raging (1348-50). Practical consequences like these the church of course did not countenance; the popes set themselves against persecutions of the Jews,<sup>2</sup> but with imperfect success. The popular aversion rested by no means exclusively on religious considerations; worldly motives were also present. The Jews of that period had in a still higher degree than now the control of financial affairs in their hands; and they used it without scruple. The church herself had unintentionally given them a monopoly of the money market, by forbidding Christians to take interest.<sup>3</sup> In this way the Jews became rich indeed, but at the same time made themselves still more repugnant to the Christian population than they previously were by reason of their religion.

Having, according to the later mediæval system, no rights in the Christian state, the Jews were tolerated only in those territories where the sovereign in the exercise of free favour accorded them protection. This protection was granted them in many quarters, but never for nothing; numerous and various taxes, which could be raised or changed in a perfectly arbitrary way, were exacted in exchange. But in countries where the feeling of nationality attained to a vigorous development, the spirit of toleration was speedily exhausted; the Jews were expelled by the act of the state. England was the first kingdom in which this occurred (1290); France followed in 1395, Spain and Portugal in 1492 and 1495. In this way it came about that the Holy Roman Empire,—Germany, Italy, and adjoining districts,—became the chief abode of the Jews.<sup>4</sup> In the anarchy which here prevailed they could best maintain their separate attitude, and if they were expelled from one locality they readily found refuge in some other. The emperor had indeed the right of extirpating them altogether (with the exception of a small number to be left as a memorial); but, in the first place, he had in various ways given up this right to the states of the empire, and, moreover, his pecuniary resources were so small that he could not afford to want the tax which the Jews as his "aervi camerae" paid him for protecting their persons and property. In spite of many savage persecutions the Jews maintained their ground, especially in those parts of Germany where the political confusion was greatest. They even succeeded in

maintaining a kind of autonomy by means of an arrangement in virtue of which civil processes which they had against each other were decided by their own rabbins in accordance with the law of the Talmud.<sup>5</sup>

The Jews, through their having on the one hand separated themselves and on the other hand been excluded on religious grounds from the Gentiles, gained an internal solidarity and solidity which has hitherto enabled them to survive all the attacks of time. The hostility of the Middle Ages involved them in no danger; the greatest peril has been brought upon them by modern times, along with permission and increasing inducements to abandon their separate position. It is worth while to recall on this point the opinion of Spinoza, who was well able to form a competent judgment (*Tract. Theol. polit.*, c. 4, *ad fin.*):—"That the Jews have maintained themselves so long in spite of their dispersed and disorganized condition is not at all to be wondered at, when it is considered how they separated themselves from all other nationalities in such a way as to bring upon themselves the hatred of all, and that not only by external rites contrary to those of other nations, but also by the sign of circumcision which they maintain most religiously. Experience shows that their conservation is due in a great degree to the very hatred which they have incurred. When the king of Spain compelled the Jews either to accept the national religion or to go into banishment, very many of them accepted the Roman Catholic faith, and in virtue of this received all the privileges of Spanish subjects, and were declared eligible for every honour; the consequence was that a process of absorption began immediately, and in a short time neither trace nor memory of them survived. Quite different was the history of those whom the king of Portugal compelled to accept the creed of his nation; although converted, they continued to live apart from the rest of their fellow subjects, having been declared unfit for any dignity. So great importance do I attach to the sign of circumcision also in this connexion that I am persuaded that it is sufficient by itself to maintain the separate existence of the nation for ever." The persistency of the race may of course prove a harder thing to overcome than Spinoza has supposed, but nevertheless he will be found to have spoken truly in declaring that the so-called emancipation of the Jews must inevitably lead to the extinction of Judaism wherever the process is extended beyond the political to the social sphere. For the accomplishment of this centuries may be required. See JEWS.

*Historical Sources.*—For all that precedes the time of Alexander the Old Testament is the only native authority. Among foreign sources, besides the stone of Mesha, the Assyrian inscriptions hold the first rank; for the chronology they are of decisive importance. The Egyptian inscriptions on the other hand are of slight value. Besides these, mention must be made of the notices contained in the *Chronicon* of Eusebius, and in the *Contra Apionem* of Josephus (Manetho and Berossus). For the period between Alexander and the destruction of Jerusalem by the Romans we have Daniel, with the commentary of Jerome, the Apocrypha, the Pseudepigraphic writers, and the New Testament, besides Philo and Josephus,—in other words, the entire body of the Grecian Jewish literature that has reached us. Hebrew or Aramaic literature of this period we have none; the writings of the rabbins are to be used only with the greatest caution as sources for the history of past times, and always only as supplementary to the Grecian authorities. The foreign sources which require to be consulted for the Hellenistic and Roman periods are brought together in Clinton's *Fasts*; recently there have been added a great variety of coins and very numerous inscriptions (Le Bas and Waddington). For the period of the Palestinian patriarchate there are the church fathers,—Origen, Eusebius, Jerome, and Epiphanius—besides the law-books. But here the first place belongs to the rabbinical authorities, although it is an arduous task to extract from such a chaos the data of historical value which it contains. Genuinely historical works are the Megillath Taanith, the Seder Olam Rabba, and the Seder Olam Zutra. For the history of the Jews in the diaspora there are of course no special sources. (J. W. E.)

<sup>1</sup> Comp. Du Cange, a. v. "Judæi"; also Reuter, *Gesch. d. Aufklärung im Mittelalter*, i. 154 sqq. In spite of all the legal restrictions laid upon them, the Jews still continued to have great influence with the princes, and more especially with the popes, of the Middle Ages.

<sup>2</sup> Decr., ii. 23, 8, 9. Alexander II. omnibus episcopis Hispania: Dispar . . . est Judæorum et Sarracæorum causa; in illos enim, qui Christianos persequuntur et ex urbis et propriis sedibus pellunt, juste pugnatur, hi vero obique servare parati sunt.

<sup>3</sup> Decretal. Greg. v. 19, 18. Innocent III. in name of the Lateran Council: Quisnto amplius Christiana religio ab exactione conspescitur usurarum, tanto gravius aufer his Judæorum perfidia insolescit, ita quod brevi tempore Christianorum exhauriant facultates. Volentes igitur in hac parte prospicere Christianis, ne a Judæis immaniter aggrediantur, synodali decreto statumus, ut, si de cætero quocunque prætextu Judæi a Christianis graves immoderate usuras extorserint, Christianorum eis participium auferatur, donec de immoderato gravamine satisfecerint competenter. . . . Principibus autem injungimus, ut propter hoc non sicut Christianis infesti, sed potius a tanto gravamine studeant cohibere Judæos.

<sup>4</sup> The Polish Jews are German Jews who migrated in the Middle Ages to Poland, but have maintained to the present day their German speech, a mediæval south-Frankish dialect, of course greatly corrupted. In Russian "German" and "Jew" mean the same thing.

<sup>5</sup> Stobbe. *Die Juden in Deutschl. währ. d. Mittelalt.* Brunsw 1860.



*Literature.*—Among older books still worthy of notice for their historical influence or intrinsic merit, J. J. Scaliger's *Thesaurus Temporum* (Leyden, 1606) and Archbishop Ussher's *Annales Vetus et Novi Testamenti* (London, 1650-54), with the English translation *Annals of the World* (London, 1658), hold a chief place. To these may be added H. Prideaux, *The Old and New Testament connected in the History of the Jews*, &c., London, 1716, 10th ed., 1749; S. Shuckford, *The Sacred and Profane History of the World*, &c., London, 1728-37-54; Basnage, *Histoire des Juifs*, 1706, English translation by Taylor, 1708. The modern treatment of the subject begins with De Wette, whose *Beiträge zur Einleitung* (1806) brought the higher criticism, which in the hands of Eichhorn had still been purely literary, into close connexion with the historical problems. But a just conception of the order of Israel's historical development, placing the Levitical law at the close not at the outset, was first unfolded in Vatke's *Biblische Theologie* (1835), a book which produced no lasting impression. The next work of first-rata importance was Ewald's *Geschichte des V. Israel*, 1843-49, 3d ed. 1864-69 (English translation of vols. i.-iv., by Martineau, 1867-71; of vol. v., by Glover, 1865; of the *Antiquities*, by Solly, 1876). In English, Ewald's view of the history has gained currency mainly through Dean Stanley's *Lectures on the History of the Jewish Church*, 3 vols., 1863-76, and his *Sinai and Palestine*, 1856. The influence of De Wette and Ewald continued paramount among critics in spite of Reuss, Lagarde, and Graf (*Die Geschichtlichen Bücher des A. T.*, 1866; "Zur Gesch. d. Stammes Levi," in *Merx's Archiv*, 1870, &c.), till the publication of Kuenen's *Gods-dienst van Israel* (2 vols., 1869-70; English translation, 1874-75); while in Germany the so-called Grafian theory, really Vatke's,

remained unpopular up to the publication of J. Wellhausen's *Geschichte Israels*, vol. i., 1878, in which the currents starting from Ewald and Vatke may be said to meet. Among other books which deal with the Biblical period of the history the following may be named:—Milman's *History of the Jews*, 1829-30; Newman's *History of the Hebrew Monarchy*, 1847; Lengerke's *Kenaan*, 1844; Weber and Holtzmann's *Gesch. des V. Isr.*, 1867; Hitzig's *Geschichte*, 1869, full of paradoxes; Reuss's *Histoire des Israélites*, 1877; W. R. Smith's *Old Testament in the Jewish Church*, 1881. See also Duncker's *Gesch. des Alterthums*. From a conservative or apologetical standpoint the subject is treated by Kurtz, *Gesch. des A. B.*, 1848-55, and Hengstenberg, *Gesch. des Reiches Gottes u. d. A. B.*, 1870-71, both translated in Clark's series, and in Koehler's *Lehrbuch der Gesch. d. A. T.*, 1875-77-81, to the death of Ishbosheth. For the New Testament period, as well as that of the connexion between the Old and New Testaments, Schürer's *Lehrbuch der NTlichen Zeitgeschichte* (1874) gives an admirable summary and an exhaustive view of relevant literature. Of works of Jewish scholars the following may be noted: Herzfeld, *Gesch. des v. Israels von Vollendung des 2ten Tempels*, 1847 sq.; Jost, *Geschichte der Israeliten seit des Makkabäern*, 1820-47, and *Gesch. des Judenthums und seiner Sekten*, 1857-59; Graetz, *Geschichte der Juden*, 1863-77; and especially Derenbourg, *Essai sur l'histoire . . . de la Palestine*, 1877.

Monographs and books elucidating particular features of the subject are too numerous to be cited in detail. For the Biblical chronology see especially G. Smith, *Assyrian Eponym Canon*, 1875; Wellhausen in *Jahrb. f. Deut. Theol.*, 1875, p. 607 sq.; Oppert, *Salomon et ses Successeurs*, 1877; Noldeke, "Chronologie der Richterzeit," in his *Untersuchungen*, 1867.

ISSACHAR (יִשָּׂשכָר, "there is a hire, or reward"; Ἰσσαχάρ), Jacob's ninth son,\* his fifth by Leah. Slightly differing explanations of the reference in the name are given in Gen. xxx. 16 and xxx. 18. The territory of the tribe (Josh. xix. 17-23) included the whole of the great plain of Esdraelon, and the hills to the east of it, the boundary in that direction extending from Tabor to the Jordan, apparently along the deep gorge of Wady Bireh. Of the sixteen cities enumerated, the greater number has been successfully identified. (See Conder, *Handbook to the Bible*, p. 266, 1879, and De Saulcy in *Bull. de la Soc. Géogr. de Paris*, i. 209 sq., 1879.) In the rich territory of Issachar, traversed by the great commercial highway from the Mediterranean to Bethshean, were several important Canaanitish towns which had preserved their independence; and, although the tribe is mentioned as having taken some part in the war of freedom under Deborah (Judg. v. \*15), it is impossible to misunderstand the reference to its tributary condition in the blessing of Jacob (Gen. xlix. 14, 15), or the fact that the name of this tribe is omitted from the list given in Judg. i. of those who bestirred themselves against the earlier inhabitants of the country. In the "blessing upon Zebulun and Issachar" in Dent. xxxiii. 18, 19, reference is made to Carmel, their sacred mountain, and to the trading and other advantages afforded by their seaboard.

ISSIK-KUL, a large lake of Central Asia, lying in a deep basin between the Trans-Ili Ala-tau and the Tian Shan mountains, and extending from 76° 10' to 78° 20' E. long. The greatest length from west-south-west to east-north-east is 120 or 125 miles, and the greatest breadth 33 miles, the area being estimated at not less than 2260 square miles. The name Issik-Kul is Kirghiz for "warm lake," and, like the Chinese synonym Zhe-hai, has reference to the fact that the lake is never entirely frozen over. The surface is variously stated at 4475 (Semenoff) and 5300 (Golubeff) feet above the sea. Towards the east the valley strikes well in among the mountains in the direction of the Santash Pass (6650 feet), and it is traversed by two parallel streams, the Tub and the Jirgalan, which form the most important affluents of the lake. On the south the Tian Shan mountains, or, as that part of the system is locally called, the Terskei Ala-tau, do not come

down so close to the shore as the mountains on the north (the Kungei Ala-tau), but leave a strip 5 to 13 miles broad. The water is too salt to be fit for drinking. Fish are remarkably abundant, especially in the bays, the principal species being carps (*Cyprinus*, *Oreinus*, and *Schizothorax*).

Issik-Kul begins to appear in history in the end of the 2d century. It was by this route that the tribes driven from China by the Huns found their way into the Aralo-Caspian basin. The Usuns settled on the lake and built the town of Teli-gu, probably at the mouth of the Tub, where remains of stone buildings are said to exist below the water. Peculiar remains of the Usun sculptures quite distinct from those of the Calmucks or the Kirghiz, and articles of household furniture, such as copper kettles of great size, are sometimes found. The town of Teli-gu still existed in the 5th century, but after that there is no mention of it in the Chinese historians. It is to Hwen T'sang, the Buddhist pilgrim, that we are indebted for the first account of Issik-Kul based on personal observation. In the beginning of the 14th century Nestorian Christians reached the lake and founded a monastery on the northern shore, indicated in the Catalan map of 1374. Timur skirted the southern shore in the beginning of the 15th century. It was not till 1856 that the Russians made acquaintance with the district.

See Petermann, *Mittheilungen*, 1858; Semenoff's valuable article in his *Stor. Russ. Imp.*, which is largely based on his own original materials; Sewerzoff's *Erforschung des Thian Schan Gebirgs-System*, 1867 (Gotha, 1875).

ISSOIRE, chief town of an arrondissement in the department of Puy-de-Dôme, France, situated on the Couze, near its junction with the Allier, 20 miles S.E. of Clermont. It contains a tribunal of the first instance, a tribunal of commerce, and the usual offices appropriate to the capital of a district. The streets in the older part of the town are narrow, crooked, and dirty, but in the newer part there are several fine tree-shaded promenades, while a handsome boulevard encircles the town. The communal college, a good primary school, several religious institutions, an ancient bridge, the granite town-house, and the church of St Paul are among the most interesting buildings. The last, built on the site of an older chapel raised over the tomb of St Austremonie (Stremonius), who introduced Christianity into Issoire in the 3d century, dates from the 10th century, and affords an excellent specimen of the Romanesque style of early Auvergnese architecture. Issoire has manufactures of agricultural implements, millstones, woollens, and shoes, and trade in cattle, walnut-oil, hemp, apples, and wine. The population in 1876 was 6089.

Issoire, whose name occurs in the Latin forms *Icciodurum* and *Issiodurum*, is said to have been founded by the Arverni, and is

Roman times rose to some reputation for its school.<sup>7</sup> In the 5th century the Christian community established there by Stremionius was overthrown by the fury of the Vandals. During the religious wars of the Reformation, Issoire suffered very severely. Merle, the leader of the Protestants, captured the town in 1574, and treated the inhabitants with great cruelty. The Roman Catholics retook it in 1577, and the ferocity of their retaliation may be inferred from the inscription  *Ici fut Issoire*, carved on a pillar which was raised on the site of the town. In the contest of the Leaguers and Henry IV. Issoire, hardly recovered, sustained further sieges, and has never wholly regained its early prosperity.

ISSOUDUN, chief town of an arrondissement in the department of Indre, France, is situated on the Théols, 17 miles N.E. of Châteauroux, and 145 miles S. of Paris. It is the seat of the usual Government and public offices; and there are also chambers of agriculture and of arts and manufactures, a communal college, a public library, a departmental prison, a hospital, an orphanage, and several religious and benevolent institutions. Among the interesting buildings are the church of St Cyr, combining various architectural styles, with a fine porch and window, the Hôtel de la Préfecture, the chapel of the Hôtel Dieu, and the Palais de Justice, begun in 1856. Of the fortifications with which the town was formerly surrounded the White Tower, a massive cylindrical building of the 13th century, alone remains. Issoudun has quarries of lithographic stone, tanaeries, grana, woollen, and saw mills, and manufactures of liss, linen, parchment, steam-engines and machinery, cutlery, and cloth. It carries on trade in lithographic stones, grain, wine, iron, cattle, and horses. The population in 1876 was 11,293.

Issoudun, in Latin *Auzellodunum*, *Exoldunum*, or *Isoldunum*, existed in Roman times. It has suffered severely from conflagrations; a very destructive one in 1651 was the result of an attack on the city in the war of the Fronde. Louis XIV. rewarded the staunch fidelity of the city to him by several privileges.

ISTALIF. See AFGHANISTAN, vol. i. p. 230.

ISTHMIAN GAMES, one of the four great Panhellenic festivals, were held on the Isthmus of Corinth. An ancient ceremony of the worship of Melicertes or Melkarth, introduced by the Phœnician traders who frequented the isthmus from the earliest time, was afterwards modified by the Old Ionic worship of Poseidon; and at the festival the heroes Neleus and Sisyphus received honour along with the two deities. About 582 B.C., the festival was arranged after the analogy of the Olympian and Pythian games, but was celebrated every two years. The festival was managed by the Corinthians; and after the city was destroyed by Mummius (146 B.C.) the presidency passed to the Sicyonians until Julius Cæsar restored Corinth. The Athenians were closely connected with the festival, and had the privilege of *proedria*, the foremost seat at the games, while the Eleans were absolutely excluded from participation. The games included gymnastic, equestrian, and musical contests; and the prize was a crown made at one time of parsley, at a later period of pine.

ISTIB or ISHTIB, a town of European Turkey, in the eyalet of Nish (Macedonia), a few miles south-east of Uskub, situated at a height of 590 feet on a small stream of its own name, which joins the Bregalnitz, a tributary of the Vardar. It is estimated to contain from 15,000 to 20,000 houses, and possesses several fine mosques, a number of fountains, and a large bazaar. A small syenitic knoll to the north-west is crowned by the ruins of an old castle. Istib is the ancient Istibon.

ISTRIA (anciently also *Ilistria*, in German *Istrien*, and formerly *Histerreich*), a margraviate of Austria, forming the southern part of the Küstenland crownland, is contained in the peninsula which, bounded on the north by the districts of Trieste, Görz, and Carniola, stretches southwards into the Adriatic Sea, between the Gulf of Trieste (*Sinus Tergetinus*), and the Gulf of Quarnero (*Sinus Flanaticus*).

The area of the official district, which includes Veglia, Cherso, Lussino, and other smaller islands on the south-east coast, is 1908 square miles, of which 1545 belong to the peninsula itself. The surface is mountainous, especially in the north and east regions, which are occupied by offshoots from the Julian Alps. Monte Maggiore (4573 feet) in the north-east is the highest summit. The Quieto in the west and the Arsa in the east, neither of which is navigable, are the principal streams. The west coast abounds in convenient bays and harbours, of which Pola, an imperial naval station, is the chief; but the steep and rocky east-coast is beset with shallows and islets, and is much exposed to the prevailing winds, the *Sirocco* from the south-south-east and the *Bora* from the north-east. The climate of Istria, although it varies with the varieties of surface, is on the whole warm and dry. The soil is not unfertile, but its resources are far from being fully developed. About one half of the total area is occupied with scanty grass and pasture land, while timber and the various annual crops divide the remainder in different proportions. Wheat, oats, potatoes, and rye are grown in the north, and in the south wheat, maize, rye, olives, vines, and melons. The harvest of 1872 yielded 46,410 bushels of wheat, 157,385 of rye, 165,800 of oats, and 158,200 of maize; and the value of the total agricultural produce was £950,000. Beech and oak timber (good for shipbuilding), gall-nuts, oak-bark, and cork are also produced. The minerals include coal, alum, quartz, and good building stone. Many of the inhabitants are engaged in a seafaring life, in fishing, and in preparing salt for fish-curing. Shipbuilding, sheep and cattle rearing, and the manufacture of oil, wine, and bricks are also noteworthy industries. The best sorts of wine are made near Capo d'Istria, Muggia, Isola, Parenzo, and Dignano; and the oil of Istria was famous even in Roman times. The trade of the peninsula is unimportant. The roads are fairly numerous, and a railway, lately opened, with a branch to Rovigno, connects Pola with Trieste. Istria is divided into the six government districts of Capo d'Istria, Parenzo, Pisino, Pola, Volosca, and, for the islands, Lussino. The estates of Istria, which meet at Parenzo, consist of 3 bishops, 5 representatives of the landed proprietors, 8 representatives of the towns, 12 representatives of the other and rural communities, and 2 representatives of the chamber of commerce at Rovigno. Two-thirds of the people are Slavs, although among these there are many differences of dress and dialect. The remaining third, on the coast and in the towns, is almost entirely Italian. The population in 1869 was 254,905, of whom 35,917 belonged to the islands: 278,218 was the official estimate at the end of 1879.

The modern Istria occupies the same position as the ancient Istria or Histria, known to the Romans as the abode of a fierce tribe of Illyrian pirates. It owed its name to an old belief that the Danube (Ister, in Greek) discharged some of its water by an arm entering the Adriatic in that region. The Istrians, protected by the difficult navigation of their rocky coasts, were only subdued by the Romans in 177 B.C. after two wars. Under Augustus the greater part of the peninsula was added to Italy, and, when the seat of empire was removed to Ravenna, Istria reaped many benefits from the proximity of the capital. After the fall of the Western empire it was pillaged by the Longobardi and the Goths; it was annexed to the Frankish kingdom by Pippin in 789; and about the middle of the 10th century it fell into the hands of the dukes of Carinthia. Fortune after that, however, led it successively through the hands of the dukes of Meran, the duke of Bavaria, and the patriarch of Aquileia, to the republic of Venice. Under this rule it remained till the peace of Campo Formio in 1797, when Austria acquired it, and added it to the north-eastern part which had fallen to her share so early as 1374. By the peace of Pressburg, Austria was in 1805 compelled to cede Istria to France, and the department of Istria was formed; but in 1813 Austria again seized it, and has retained it ever since. *Saggio di bibliografia Istriana* (Capodistria, 1864) contains a classified bibliography of the province.



## I T A L Y

## PART I.—GEOGRAPHY AND STATISTICS.

*Topography.*

**I**TALY, or more correctly *ITALIA*, is the name that has been applied both in ancient and modern times to the great peninsula that projects from the mass of central Europe far to the south into the Mediterranean Sea, where the great island of Sicily may be considered as in fact a mere continuation or appendage of the continental promontory. Confining ourselves, however, to Italy itself, its natural boundaries are marked with a distinctness that is quite exceptional. The portion of the Mediterranean commonly termed by geographers the Tyrrhenian Sea forms its limit on the W. and S., and the Adriatic on the E.; while to the north, where it joins the main continent of Europe, it is separated from the adjacent regions by the mighty chain of the Alps, which sweeps round in a vast semicircle from the head of the Adriatic to the shores of Nice and Monaco, presenting throughout an almost unbroken mountain barrier.

The land thus circumscribed extends between the parallels of  $46^{\circ} 40'$  and  $37^{\circ} 55'$  N. lat. and between  $6^{\circ} 35'$  and  $18^{\circ} 35'$  E. long. Its greatest length is from north-west to south-east, in which direction it measures 620 geographical miles or 718 English miles in a direct line from the boundary near Courmayeur to the Cape Sta Maria di Leuca, south of Otranto, but the great mountain peninsula of Calabria extends about two degrees farther south to Cape Spartivento in lat.  $37^{\circ} 55'$ . Its breadth is, owing to its configuration, very irregular. The northern portion, measured from the Alps at the Monte Viso to the mouth of the Po, has a breadth of about 230 geographical or 270 English miles, and from the Monte Viso to the head of the Adriatic near the mouth of the Isonzo it measures 290 geographical or 340 English miles. But the peninsula of Italy, which forms the largest portion of the country, nowhere exceeds 130 geographical miles in breadth, while it does not generally measure more than from 90 to 100 miles across. Its southern extremity, now called Calabria, forms a complete peninsula, being united to the mass of Lucania or the Basilicata by an isthmus of only 35 English miles in width, while that between the Gulfs of Sta Eufemia and Squillace, which connects the two portions of the province, does not exceed 20 miles. The area of the present kingdom of Italy, exclusive of the large islands, is computed at 93,640 square miles. Savoy, which until the treaty of 1860 was commonly considered as included in Italy, on account of its being comprised in the kingdom of Sardinia, as a matter of physical geography unquestionably belongs to France (to which it is now politically united), being separated from the Italian province of Piedmont by the main chain of the Alps.

But, though that great range forms throughout the northern boundary of Italy, the exact limits of the country at the two extremities of the Alpine chain are not very clearly marked, and have been subject to considerable fluctuations both in ancient and modern times. Ancient geographers appear to have generally regarded the remarkable headland which descends from the Maritime Alps to the sea between Nice and Monaco as the limit of Italy in that direction, and in a purely geographical point of view it is probably the best point that could be selected. But Augustus, who was the first to give to Italy a definite political organization, carried the frontier to the river Varus or Var, a few miles west of Nice, and this river continued in modern times to be generally recognized as

the boundary between France and Italy. It was only in 1860 that the annexation of Nice and the adjoining territory to France carried the political frontier farther east, to a point between Mentone and Ventimiglia, which certainly constitutes no natural limit.

Towards the north-east also the line of demarcation is not clearly characterized. The point where the range of the Julian Alps approaches almost close to the sea-shore (just at the sources of the little stream so celebrated in ancient times as the Timavus) would seem to constitute the best natural limit. But in the constitution of Italy by Augustus the frontier was carried farther east so as to include Tergeste (Trieste), and the little river Formio (Risano) was in the first instance chosen as the limit, but this was subsequently transferred to the river Arsia (the Arsa), which flows into the Gulf of Quarnero, so as to include almost all Istria; and the circumstance that the coast of Istria was throughout the Middle Ages held by the powerful republic of Venice tended to perpetuate this arrangement, so that Istria was generally regarded as belonging to Italy, though certainly not forming any natural portion of that country.

The only other part of the northern frontier of Italy where the boundary is not clearly marked by nature is Tyrol or the valley of the Adige. Here the main chain of the Alps (as marked by the watershed) recedes so far to the north that it has never constituted, as it has done throughout the greater part of its extent, the national limit between populations of different race and language. In ancient times the upper valleys of the Adige and its tributaries were inhabited by Rhetian tribes and included in the province of Rætia; and the line of demarcation between that province and Italy was purely arbitrary, as it remains to this day. Tridentum or Trent was in the time of Pliny included in the tenth region of Italy or Venetia, but he tells us that the inhabitants were a Rhetian tribe. At the present day the frontier between Austria and the kingdom of Italy crosses the Adige about 30 miles below Trent,—that city and its territory, which previous to the treaty of Lunéville in 1802 was governed by sovereign archbishops of its own, subject only to the German emperors, being now included in the Austrian empire. While the Alps thus constitute the northern boundary of Italy, its configuration and internal geography are determined almost entirely by the great chain of the Apennines, which branches off from the Maritime Alps between Nice and Genoa, and, after stretching in the first instance in an unbroken line across from the Gulf of Genoa to the Adriatic, then turns more to the south, and is continued throughout the whole of Central and Southern Italy, of which it forms as it were the backbone, until it ends in the southernmost extremity of Calabria at Cape Spartivento. The great spur or promontory projecting towards the east to Brindisi and Otranto, which figures in the older maps of Italy as if it were constituted by a branch from the main range of the Apennines, is not in reality so formed, and has no direct connexion with the central chain.

One chief result of the manner in which the Apennines thus traverse the whole of Italy from the Mediterranean to the Adriatic is the marked division between Northern Italy, including the region north of the Apennines and extending thence to the foot of the Alps, and the central and more southerly portions of the peninsula. No such line of separation exists farther south, and the terms

Central and Southern Italy, though in general use among geographers, and convenient for descriptive purposes, do not correspond to any natural divisions of the great Italian peninsula.

1. *Northern Italy.*—By far the larger portion of Northern Italy is occupied by the basin of the Po, which comprises the whole of the broad plain extending from the foot of the Apennines to that of the Alps, together with the valleys and slopes on both sides of it. Throughout its whole course indeed, from its source in Monte Viso to its outflow into the Adriatic—a distance of more than 5 degrees of longitude, or 220 miles in a direct line—the Po receives all the waters that flow from the Apennines northwards, and all those that descend from the Alps towards the south, till one comes to the Adige, which, after pursuing a parallel course with the Po for a considerable distance, enters the Adriatic by a separate mouth.

There is no other instance in Europe of a basin of similar extent equally clearly characterized,—the perfectly level character of the plain being as striking as the boldness with which the lower slopes of the mountain ranges begin to rise on each side of it. This is most clearly marked on the side of the Apennines, where the great Emilian Way, which has been the high road from the time of the Romans to our own, preserves an unbroken straight line from Rimini to Piacenza, a distance of more than 150 miles, during which the underfalls of the mountains continually approach it on the left, without once crossing the line of road. On the side of the Alps the boundary is more varied and broken, the great projecting masses of those mountains being intersected by large rivers, which produce valleys of considerable extent running far up into the mountains. But still, from whatever point the traveller approaches the Alps, he will be struck by the manner in which the unbroken alluvial plain extends quite up to the foot of the actual mountains or their immediate offshoots,—presenting in this respect a striking contrast with the broken, hilly country which is found on the north side of the Alps both in Switzerland and in Austria.

The only exception to this uniform level occurs in the Monferrat region, which consists principally of hills of moderate elevation and of Tertiary formation, projecting to the north from the Ligurian Apennines, and occupying a breadth of about 50 miles from the neighbourhood of Turin to that of Alessandria, around which the Po is compelled to form a great bend between Turin and Valenza, leaving, however, a broad strip of plain (from 15 to 30 miles across) between its north bank and the foot of the Alps. The detached group of the Euganean hills, within sight of the Adriatic, though separated from the nearest Alps by a very narrow strip of plain, is wholly independent of that great chain, and forms a separate and isolated mass of volcanic origin.

The geography of Northern Italy will be best described by following the course of the Po. That mighty stream has its origin as a mountain torrent descending from two little dark lakes on the north flank of Monte Viso, at a height of more than 6000 feet above the sea; and after a course of less than 20 miles it enters the plain at Saluzzo, between which and Turin, a distance of only 30 miles, it receives three considerable tributaries,—the Clusone on its left bank, bringing down the waters from the valley of Fenestrelle, and the Varaita and Maira on the south, contributing those of two valleys of the Alps immediately south of that of the Po itself. Between Turin and Valenza it receives no affluent of importance on its right bank, but a few miles below the latter town it is joined by the Tanaro, a large stream, which brings with it the united waters of the Stura, the Bormida, and several minor rivers. All these have their sources on the northern flank or reverse

of the Maritime Alps, where the chain bends round towards Savona, and being fed by the snows of those lofty mountains are greatly superior in volume to the rivers that descend from the Apennines farther east.

But far more important are the great rivers that descend from the main chain of the Graian and Pennine Alps, and join the Po on its left bank. Of these the Dora (called for distinction's sake Dora Riparia), which unites with the greater river just below Turin, has its source in the Mont Genevre, and flows past Susa at the foot of the Mont Cenis. Next comes the Stura, which rises in the glaciers of the Roche Melon; then the Orco, flowing through the Val di Locana; and then the Dora Baltea, one of the greatest of all the Alpine tributaries of the Po, which has its source in the glaciers of Mont Blanc, above Courmayeur, and thence descends through the Val d'Aosta for about 70 miles till it enters the plain at Ivrea, and after flowing about 20 miles more joins the Po a few miles below Chivasso. This great valley—one of the most considerable on the southern side of the Alps—has attracted more especial attention, in ancient as well as modern times, from its leading to two of the most frequented passes across the great mountain chain,—the Great and the Little St Bernard, the former diverging at Aosta, and crossing the main ridges to the north into the valley of the Rhone, the other following a more westerly direction into Savoy. In its course below Aosta also the Dora Baltea receives several considerable tributaries, which descend from the range of glaciers between Mont Blanc and Monte Rosa.

About 25 miles below its confluence with the Dora, the Po receives the waters of the Sesia, also a large river, which has its source above Alagna at the southern foot of Monte Rosa, and after flowing by Varallo and Vercelli falls into the Po about 14 miles below the latter city. About 30 miles east of this confluence,—in the course of which the Po makes a great bend south to Valenza, and then returns again to the northward,—it is joined by the Ticino, a large and rapid river, which brings with it the outflow of the great lake called the Lago Maggiore, and all the accumulated waters that flow into it. Of these the Ticino itself has its source about 10 miles above Airolo at the foot of the St Gotthard and after flowing above 36 miles through the Val Leventina to Bellinzona, where it is joined by the Moesa bringing down the waters of the Val Misocco, enters the lake through a marshy plain at Magadino, about 10 miles distant. On the west side of the lake the Toccia or Tosa descends from the pass of the Gries nearly due south to Domo d'Ossola, where it receives the waters of the Doveria from the Simplon, and a few miles lower down those of the Val Anzasca from the foot of Monte Rosa, and 12 miles farther has its outlet into the lake between Baveno and Pallanza. Besides these two great streams the Lago Maggiore is the receptacle of the waters of two minor but considerable lakes—the Lago di Lugano on the east and the Lago d'Orta on the west. The Ticino has a course of above 50 miles from Sesto Calende, where it issues from the lake, through the level plain, till it joins the Po just below the city of Pavia.

The next great affluent of the Po, the Adda, forms in like manner the outflow of a great lake—the Lake of Como, and has also its sources far away in the Alps, above Bormio, from whence it flows through the broad and fertile valley of the Val Tellina for a distance of more than 65 miles till it enters the lake near Colico. The Adda in this part of its course has a direction almost due east to west; but at the same point where it reaches the lake, another river, the Lira, descends the valley of S. Giacomo, which runs nearly north and south from the pass of the Splügen, thus affording one of the most direct lines of communication across the Alps. The Adda flows out of



the lake at its south-eastern extremity at Lecco, and has thence a course through the plain of above 70 miles till it enters the Po between Piacenza and Cremona. In this part of its course it flows by Lodi and Pizzighettone, and receives the waters of two minor but considerable streams, the Brembo, descending from the Val Brembana, and the Serio from the Val Seriana above Bergamo. The Oglio, a more considerable stream than either of the last two, rises in the Monte Tonale above Edolo, and descends through the Val Camonica to Lovere, where it expands into a large lake, called the Lake of Iseo from the town of that name on its southern shore. Issuing from thence at its south-west extremity, the Oglio has a long and winding course through the plain before it finally reaches the Po a few miles above Borgoforte. In this lower part of its course it receives the smaller streams of the Mella, which flows by Brescia, and the Chiese, which proceeds from a small lake called the Lago d'Ildro, between the Lake of Iseo and that of Garda.

The last of the great tributaries of the Po is the Mincio, which flows from the Lago di Garda, the largest of all the Italian lakes, and has a course of about 40 miles from Peschiera, where it issues from the lake at its south-eastern angle, till it joins the Po. About 12 miles above the confluence it passes under the walls of Mantua, and expands into a broad lake-like reach so as entirely to encircle that city. Notwithstanding its extent, the Lake of Garda is not fed, like those of Como and Maggiore, by the snows of the high Alps, nor is the stream which enters it at its northern extremity (at Riva) commonly known as the Mincio, though in reality forming the main source of that river, but is termed the Sarca; it rises at the foot of the Monte Tonale.

The Adige, which is formed by the junction of two streams—the Etsch or Adige proper and the Eisach, both of which belong to Tyrol rather than to Italy—descends as far as Verona, where it enters the great plain, with a course from north to south nearly parallel to the rivers last described, and would seem likely in like manner to discharge its waters into those of the Po, but below Legnago it turns to the eastward and pursues a course parallel to that of the Po itself for a space of about 40 miles, till it enters the Adriatic by an independent mouth about 8 miles from the northern outlet of the greater stream. The waters of the two rivers have, however, been made to communicate by artificial cuts and canals in more than one place.

The Po itself, which is here a very large stream, with an average width of from 400 to 600 yards, continues to flow with an undivided mass of waters as far as a place called Sta Maria di Ariano, where it parts into two arms, known as the Po della Macestra and Po di Goro, and these again are subdivided into several other branches, forming an extensive delta above 20 miles in width from north to south. The point of bifurcation is at present about 25 miles from the sea, but was formerly much farther inland, more than 10 miles west of Ferrara, where a small arm of the river, still called the Po di Ferrara, branches off from the main stream. Previous to the year 1154 this channel was the main stream, and the two small branches into which it subdivides, called the Po di Volano and Po di Primaro, were in early times the two main outlets of the great river. The southernmost of these, the Po di Primaro, enters the Adriatic only about 12 miles north of Ravenna, so that if these two arms be included, the whole delta of the Po extends through a space of about 36 miles from south to north. The whole course of the river, including its windings, is estimated at about 450 miles.

Besides the delta of the Po and the large marshy tracts which it forms, there exist on both sides of it extensive lagoons of salt water, generally separated from the Adriatic

by narrow strips of sand or embankments, partly natural partly artificial, but having openings from distance to distance through these barriers, which admit of the influx and efflux of the sea-water, and serve as ports for communication with the mainland. The best known and the most extensive of these lagoons is that in which Venice is situated, and which extends from Torcello in the north to Chioggia and Brondolo in the south, a distance of above 40 miles; but they were formerly much more extensive, and afforded a continuous means of internal navigation, by what were called "the Seven Seas" (Septem Maria), from Ravenna to Altinum, a few miles north of Torcello. That city, like Ravenna, originally stood in the midst of a lagoon; and the coast to the east of it, the whole way to near Monfalcone, where it meets the mountains, is occupied by similar expanses of water, which are, however, continually drying up and becoming gradually converted into dry land. The changes in the coast-line have consequently been considerable throughout this extent.

The tract in the interior, adjoining this long line of lagoons, is, like the basin of the Po, a broad, expanse of perfectly level alluvial plain, extending from the Adige eastwards to the Carnic Alps, where they approach close to the Adriatic between Aquileia and Trieste, and northwards to the foot of the great chain, which here sweeps round in a semicircle from the neighbourhood of Vicenza to that of Aquileia. The space thus included was known in ancient times as Venetia, a name applied in the Middle Ages to the well-known city; the eastern portion of it became known in the Middle Ages as the Frioul or Friuli. It is traversed by a number of rivers, descending from the Alpine chain; but these are for the most part nothing more than mountain torrents, bringing down vast masses of stones and shingle to the plain below. Beginning from the Adige and proceeding from west to east the streams worthy of notice are—(1) the Brenta, a navigable stream of a different character from the rest, which descends from the Val Sugana, and passes within a few miles of Padua; (2) the Piave, flowing by Belluno; (3) the Tagliamento, which descends from the Carnic Alps above Tolmezzo, and though a large stream has a very torrent-like character; (4) the Isonzo, a deep and rapid river, which has its sources in the highest group of the Julian Alps, at the foot of Mont Terglou, and brings with it the waters of the Natissone, also a considerable stream.

Returning to the south of the Po, the tributaries of that river on its right bank below the Tanaro are very inferior in volume and importance to those from the north. Flowing from the Ligurian Apennines, which are of no great elevation and never attain to the limit of perpetual snow, they have no continuous supply through the year, and in summer generally dwindle into insignificant streams flowing through dry beds of shingle. Beginning from the Tanaro, the principal of them are—(1) the Scrivia, a small but rapid stream flowing from the Apennines at the back of Genoa; (2) the Trebbia, a much larger river, though of the same torrent-like character, which rises near Torrighia within 20 miles of Genoa, flows by Bobbio, and joins the Po a few miles above Piacenza; (3) the Nure, a few miles east of the preceding; (4) the Taro, a more considerable stream; (5) the Parma, flowing by the city of the same name; (6) the Enza; (7) the Secchia, which flows by Modena; (8) the Panaro, a few miles to the east of that city; (9) the Reno, which flows by Bologna, but instead of holding its course till it discharges its waters into the Po, is turned aside by an artificial channel into the Po di Primaro. The other small streams east of this—of which the most considerable are the Solaro, the Santerno, flowing by Imola, the Lamone by Faenza, the Montone by Forlì—all have their outlet in like manner into the Po di

Primaro, or by artificial mouths into the Adriatic between Ravenna and Rimini. The river Marecchia, which enters the sea immediately north of Rimini, may be considered as the natural limit of Northern Italy. It was adopted by Augustus as the boundary of Gallia Cispadana; the far-famed Rubicon was a trifling stream a few miles farther north, now called Fiumicino.

The narrow strip of coast-land between the Maritime Alps, the Apennines, and the sea—called in ancient times Liguria, and now known as the Riviera of Genoa—though belonging in respect of latitude to Northern Italy, is in other respects quite distinct from the region included under that name. Throughout its whole extent, from Nice to Genoa on the one side, and again from Genoa to Spezia on the other, it is almost wholly mountainous, being occupied by the branches and offshoots of the mountain ranges at the back, which separate it throughout from the great plain to the north, while they send down their lateral ridges close to the water's edge, leaving only in places a few square miles of level plains at the mouths of the rivers and openings of the valleys. Rugged as it is, the district thus bounded is by no means devoid of fertility, the steep slopes facing the south enjoying so fine a climate as to render them very favourable for the growth of fruit trees, especially the olive, which is cultivated in terraces to a considerable height up the face of the mountains, while the openings of the valleys are generally occupied by towns or villages.

From the proximity of the mountains to the sea none of the rivers in this part of Italy have any long course, and they are generally mere mountain torrents, rapid and swollen in winter and spring, and almost dry in summer. The largest and most important are those which descend from the Maritime Alps between Nice and Albenga. Beginning from the Var, which as already stated is now included in France, the most considerable of them are—the Roja, which rises in the Col di Tenda, and descends to Ventimiglia; the Taggia, between San Remo and Oneglia; and the Centa, which enters the sea at Albenga. The other streams, which flow from the range of the Apennines to the sea between Savona and Genoa, are of very little importance, from the proximity of the watershed and its small elevation. The same remark applies to the Riviera east of Genoa, where the Lavagna, which enters the sea at Chiavari, is the only stream of any importance between Genoa and the Gulf of Spezia. But immediately east of that inlet (a remarkable instance of a deep land-locked gulf with no river flowing into it) the Magra, which descends from Pontremoli down the valley known as the Lunigiana, is a large stream, and brings with it the waters of another considerable stream, the Vara. The Magra (Macra) was in ancient times the boundary between Liguria and Etruria, and may be considered as constituting on this side the limit of Northern Italy.

The Apennines, as has been already mentioned, here traverse the whole breadth of Italy, cutting off the peninsula properly so termed from the broader mass of Northern Italy by a continuous barrier of considerable breadth, though of far inferior elevation to that of the Alps. The Ligurian Apennines, which may be considered as taking their rise in the neighbourhood of Savona, where a pass of very moderate elevation connects them with the Maritime Alps, of which they are in fact only a continuation, are among the least lofty portions of that long range. From the neighbourhood of Savona to that of Genoa they do not rise to more than 3000 to 4000 feet, and are traversed by passes of less than 2000 feet. As they extend towards the east they increase in elevation: thus Monte Penna, at the sources of the Taro, rises to 5704 feet; Monte Molinedigo, at the head of the valley of

Pontremoli, to 5100; and the Alpe di Succisa, near the pass which is crossed by the road from Sarzana to Reggio, to 6600; while the Monte Cimone, a little farther east, attains to the height of 7088 feet. This is the highest point in the northern Apennines, and belongs to a group of summits of nearly equal altitude; the range which from thence is continued between Tuscany and what are now known as the Emilian provinces has a very uniform character both in elevation and direction, and presents a continuous ridge from the mountains at the head of the Val di Mugello (due north of Florence) to the point where they are traversed by the celebrated Furlo Pass. The highest point in this part of the range is the Monte Falterona, above the sources of the Arno, which attains to a height of 5408 feet. Throughout this tract the Apennines are generally covered with extensive forests of chestnut, oak, and beech; while their upper slopes afford admirable pasturage. But few towns of any importance are found either on their northern or southern declivity, and the former region especially, though occupying a broad tract of from 30 to 40 miles in width, between the crest of the Apennines and the plain of the Po, is one of the least known and at the same time least interesting portions of Italy.

2. *Central Italy.*—It has already been observed that this term is merely one used by geographers as a matter of convenience, and does not correspond to any natural division of the peninsula. Nor does it correspond with any received political division, for though the kingdom of Naples, which so long constituted a separate government, might be considered as representing Southern Italy, its three northern provinces, known as the Abruzzi, certainly belong rather to the central portion of the peninsula, with which they correspond in physical characters as well as in latitude and position. Writers on ancient geography generally include Campania and Samnium also in Central Italy, a division rendered convenient by the close relations existing between those countries and Latium, the political centre of Italy in those days. But as a mere geographical division it seems more convenient to include all the provinces that formed part of the kingdom of Naples, with the exception of the three Abruzzi, in Southern Italy.

The geography of Central Italy is almost wholly determined by the great range of the Apennines, which traverse its whole extent in a direction from about north-north-east to south-south-west, almost precisely parallel to that of the coast of the Adriatic from Rimini to Pescara. The line of the highest summits and of the watershed ranges at a distance of about 30 to 40 miles from the Adriatic, while it is separated by about double that distance from the Tyrrhenian Sea on the west. It is in this part of the range that almost all the highest points of the Apennines are found. Beginning from the group called the Alpi della Luna near the sources of the Tiber, which attain only to a height of 4435 feet, they are continued by the Monte Nerone (5014 feet), Monte Catria (5590), and Monte Maggio to the Monte Penino near Nocera (5169 feet), and thence to the Monte della Sibilla, at the source of the Nar or Nera, which attains an elevation of 7663 feet. Proceeding from thence southwards, we find in succession the Monte Vettore (8134 feet), the Pizzo di Sevo (7945 feet), and the two great mountain masses of the Monte Corno, commonly called the Gran Sasso d'Italia, the most lofty of all the Apennines, attaining to a height of 9522 feet, and the Monte della Majella, but little inferior to its highest summit measuring 9084 feet. Farther south than this the range decreases in altitude, and no very lofty summits are found till we come to the group of Monte Matese, in Samnium (6660 feet), which according to the division here adopted belongs to Southern Italy. But



besides the lofty central masses above enumerated, two other peaks deserve mention which, though outliers from the main range, and separated from it by valleys of considerable extent, rise to a height exceeding that of all but a few of the points already cited. These are the Monte l'ermellino, near Leonessa (7278 feet), and the Monte Velino near the Lake Fucino, rising to 8192 feet, both of which are covered with snow from November till May, and being within sight of Rome are familiar objects to most visitors to Italy. But though the Apennines of Central Italy, viewed in the mass, may be considered as thus constituting a continuous range, they are far from having the definite arrangement which characterizes their northern extension from the neighbourhood of Genoa to the Adriatic. Instead of presenting, like the Alps and the northern Apennines, a definite central ridge, with transverse valleys leading down from it on both sides, the central Apennines in reality constitute a mountain mass of very considerable breadth, composed of a number of minor ranges and groups of mountains, which though very broken and irregular preserve a generally parallel direction, and are separated by upland valleys, some of them of considerable extent as well as considerable elevation above the sea. Such is the basin of the Lake Fucino, situated in the very centre of the whole mass, and almost exactly midway between the two seas, but at an elevation of 2180 feet above them; while the upper valley of the Aterno, in which Aquila is situated, is not less than 2380 feet above the level of the sea. Still more elevated is the valley of the Gizio (a tributary of the Aterno), of which Sulmona is the chief town, and which communicates with the upper valley of the Sangro by a level plain called the Piano di Cinqua Miglia, at an elevation of not less than 4298 feet, regarded as the most wintry spot in Italy. Nor do the highest summits ever form a continuous ridge of great altitude for any considerable distance; they are rather a series of groups separated by intervals of very inferior elevation forming natural passes across the range, and broken in some places (as is the case in almost all limestone countries) by the waters from the upland valleys turning suddenly at right angles, and breaking through the mountain ranges which bound them. Thus the two loftiest groups of all, the Gran Sasso and the Majella, are separated by the deep valley of the Aterno, while the Tronto, in like manner, breaks through the range between Monte Vettore and the Pizzo di Sevo. This constitution of the great mass of the central Apennines has in all ages exercised an important influence upon the character of this portion of Italy, which may be considered as divided by nature into two great regions, a cold and barren upland country, bordered on both sides by rich and fertile tracts, enjoying a warm but temperate climate.

The district west of the Apennines, extending from the foot of the mountains to the sea, which constitutes a region of great beauty and fertility, though inferior in productiveness to northern Italy, may be considered as coinciding in a general way with the countries so familiar to all students of ancient history as Etruria and Latium. In modern times (until the recent union of all Italy) they were comprised in Tuscany and the southern Papal States. The northern part of Tuscany is indeed occupied to a considerable extent by the underfalls and offshoots of the Apennines, which, besides the ordinary slopes and spurs of the main range that constitutes its northern frontier towards the plain of the Po, throw off several outlying ranges or groups, which attain to a very considerable elevation. Of these the most remarkable is the group between the valleys of the Serchio and the Magra, commonly known as the mountains of Carrara, from the celebrated marble quarries in the vicinity of that city. Two of the summits of this group, the Pizzo

d'Uccello and the Pania della Croce, attain to 6155 and 6100 feet. Another lateral range, the Prato Magno, which branches off from the central chain at the Monte Falterona, and separates the upper valley of the Arno from its second basin, rises to 5188 feet; while a similar branch, called the Alpe della Catenaja, of inferior elevation, divides the upper course of the Arno from that of the Tiber.

The rest of this tract is for the most part a hilly, broken country, but does not in general rise into anything like mountains, with the exception of the Monte Amiata, near Radicofani, a lofty isolated mass of volcanic origin, which attains to a height of 5650 feet. South of this the country between the frontier of Tuscany and the Tiber is in great part of volcanic origin, forming hills of no great elevation, with distinct crater-shaped basins, in several instances occupied by small lakes (the Lake of Bolsena, Lake of Vico, and Lake of Bracciano); and this volcanic tract extends across the Campagna of Rome, till it rises again in the lofty group of the Alban hills, the highest summit of which, the Monte Cavo, is 3160 feet above the sea. In this part the Apennines are separated from the sea by a space of only about 30 miles in width, occupied by the undulating volcanic plain of the Roman Campagna, from which the mountains rise in a wall-like barrier, of which the highest point, the Monte Genaro, attains to a height of 4165 feet. South of Palestrina again, the main mass of the Apennines throws off another lateral mass, known in ancient times as the Volscian mountains (now called the Monti Lepini), separated from the central ranges by the broad valley of the Sacco, a tributary of the Liris or Garigliano, and forming a large and rugged mountain mass, nearly 5000 feet in height, which descends to the sea at Terracina, and between that point and the mouth of the Liris throws out several rugged mountain headlands, which may be considered as constituting the natural boundary between Latium and Campania, and consequently the natural limit of Central Italy. But besides these offshoots of the Apennines there are in this part of Central Italy several detached mountains, rising almost like islands on the sea-shore, of which the two most remarkable are the Monte Argentaro on the coast of Tuscany near Orbetello (2087 feet high) and the Monte Circello (1771 feet) at the angle of the Pontine Marshes, by the whole breadth of which it is separated from the Volscian Apennines.

The two valleys of the Arno and the Tiber (called in Italian *Tevere*) may be considered as furnishing the key to the geography of all this portion of Italy west of the Apennines. The Arno, which has its source in the Monte Falterona, one of the most elevated summits of the main chain of the Tuscan Apennines, flows at first nearly south till in the neighbourhood of Arezzo it turns abruptly to the north-west, and pursues that course as far as Pontassieve, where it again makes a sudden bend to the west, and pursues a westerly course from thence to the sea, passing through the two celebrated cities of Florence and Pisa. Its principal tributary is the Sieve, which joins it at Pontassieve, bringing down the waters of the Val di Mugello. The Elza and the Era, which join it on its right bank, descending from the hills near Siena and Volterra, are inconsiderable streams; and the Serchio, which flows from the territory of Lucca and the Alpi Apuani, and formerly joined the Arno a few miles from its mouth, now enters the sea by a separate channel. The most considerable rivers of Tuscany south of the Arno are the Cecina, which flows through the plain below Volterra, and the Ombrone, which rises in the hills near Siena, and enters the sea about 12 miles below Grosseto.

The Tiber, a much more important river than the Arno, and the largest in Italy with the exception of the Po, rises in the Apennines, about 20 miles east of the source of

the Arno, and flows nearly south by Borgo S. Sepolcro and Città di Castello, then between Perugia and Todi to Orte, just below which it receives the waters of the Nera. Its tributaries in the upper part of its course are of little importance, but the Nera, which rises in the lofty group of the Monte della Sibilla, is a very considerable stream, and brings with it the waters of the Velino (with its tributaries the Turano and the Salto), which joins it a few miles below its celebrated waterfall at Terni. The Teverone or Anio, which enters the Tiber a few miles above Rome, is a very inferior stream to the Nera, but brings down a considerable body of water from the mountains above Subiaco. It is a singular fact in the geography of Central Italy that the valley of the Tiber and that of the Arno are in some measure connected by that of the Chiana, a level and marshy tract, the waters from which flow partly into the Arno and partly into the Tiber.

The eastern declivity of the central Apennines towards the Adriatic is far less interesting and varied than the western. The central range here approaches (as has been already pointed out) much nearer to the sea, and hence, with few exceptions, the rivers that flow from it have but short courses and are of comparatively little importance. They may be briefly enumerated, proceeding from Rimini southwards:—(1) the Foglia; (2) the Metauro, of historical celebrity, and affording access to one of the most frequented passes of the Apennines; (3) the Esino; (4) the Potenza; (5) the Chienti; (6) the Aso; (7) the Tronto; (8) the Vomano; (9) the Aterno; (10) the Sangro; (11) the Trigno, which forms the boundary of the southernmost province of the Abruzzi, and may therefore be taken as the limit of Central Italy. Much the most considerable of these rivers is the Aterno (called also the Pescara, from the city of that name at its mouth); this has its sources in the Apennines above Aquila, and flows through a broad upland valley in a south-east direction for above 40 miles till it approaches Popoli, when it turns abruptly to the north-east, and cuts directly through the main chain of the Apennines between the range of the Gran Sasso and that of the Majella, descending with a very rapid course till it enters the sea at Pescara.

The whole of this portion of Central Italy, between the Apennines and the sea, is a hilly country, much broken and cut up by the torrents from the mountains, but fertile, especially in fruit-trees, olives, and vines; and hence it has been, both in ancient and modern times, a populous district, containing many small towns though no great cities. Its chief disadvantage is the absence of ports, the coast preserving an almost unbroken straight line, with the single exception of Ancona, which has in all ages been the only port worthy of the name on the eastern coast of Central Italy.

3. *Southern Italy.*—The great central mass of the Apennines, which has held its course throughout Central Italy, with a general direction from north-west to south-east, may be considered as continued in the same direction for about 100 miles farther, from the basin-shaped group of the Monti del Matese (which rises to the height of 6660 feet) to the neighbourhood of Potenza, in the heart of the province of Basilicata, corresponding nearly to the ancient Lucania. The whole of the district known in ancient times as Sannio (a part of which still retains the name of Sannio, though now officially designated as the province of Molise) is occupied by an irregular mass of mountains, of much inferior height to those of Central Italy, and having still less of the character of a regular range, being broken up into a number of groups or masses, intersected by rivers, which have for the most part a very tortuous course. This mountainous tract, which has an average breadth of from 50 to 60 miles, is bounded on the west

by the plain of Campania, now called the Terra di Lavoro, and on the east by the much broader and more extensive tract of Apulia or Puglia, composed partly of level plains, but for the most part of undulating downs of very slight elevation, and contrasting strongly with the mountain ranges of the Apennines, which rise abruptly above them. The central mass of the mountains, however, throws out two outlying ranges, the one to the west, which separates the Bay of Naples from that of Salerno, and culminates in the Monte St Angelo above Castellamare (4720 feet), while the detached volcanic cone of Vesuvius, which rises to near 4000 feet, is isolated from the neighbouring mountains by an intervening strip of plain. On the east side in like manner the Monte Gargano, a detached limestone mass which rises to the height of 5120 feet, and projects in a bold spur-like promontory into the Adriatic, forming the only break in the otherwise uniform coast-line of Italy on that sea, though separated from the great body of the Apennines by a considerable interval of low country, may be considered as merely an outlier from the central mass.

From the neighbourhood of Potenza, the main ridge of the Apennines is continued by the Monti della Maddalena in a direction nearly due south, so that it approaches within a short distance of the Gulf of Policastro, from whence it is carried on as far as the Monte Pollino, the last of the lofty summits of the Apennine chain, which exceeds 7000 feet in height. The range is, however, continued through the whole of the province now called Calabria, to the southern extremity or "toe" of Italy, but presents in this part a very much altered character, the broken limestone range which is the true continuation of the chain as far as the neighbourhood of Nicastro and Catanzaro, and keeps close to the west coast, being flanked on the east by a great mass of granitic mountains, rising to a height of about 6000 feet, and covered with vast forests, from which it derives the name of La Sila. A similar mass, but separated from the preceding by a low neck of Tertiary hills, fills up the whole of the peninsular extremity of Italy from Squillace to Reggio. Its highest point, called Aspromonte, attains to a height of 4300 feet.

While the rugged and mountainous district of Calabria, extending nearly due south for a distance of more than 150 miles, thus derives its character and configuration almost wholly from the range of the Apennines, by which it is traversed from end to end, the case is wholly different with the long spur-like promontory which projects towards the east to Brindisi and Otranto. The older maps of Italy, indeed, with one accord represent the Apennines as bifurcating somewhere in the neighbourhood of Venosa, and sending off an arm of the main range through this eastern district, similar to that which traverses Calabria. But this is entirely erroneous; the whole of the district in question is merely a continuation of the low tract of Apulia, consisting of undulating downs and low bare hills of very moderate elevation, with a dry calcareous soil of Tertiary origin. The Monte Voltore, which rises in the neighbourhood of Melfi and Venosa to a height of 4357 feet, is of volcanic origin, and in great measure detached from the adjoining mass of the Apennines. But eastward from this nothing like a mountain is to be found, the ranges of low bare hills called the Murgie of Gravina and Altamura gradually sinking into the still more moderate level of those which constitute the peninsular tract that extends between Brindisi and Taranto as far as the Cape of Sta Maria di Leuca, the south-east extremity of Italy. It is this projecting tract, which may be termed the "heel" or "spur" of Southern Italy, that, in conjunction with the great promontory of Calabria, forms the deep bay called the Gulf of Taranto, about 70 miles in width, and somewhat greater.



depth, which receives a number of streams that descend from the central mass of the Apennines.

The rivers of Southern Italy are none of them of any great importance. The Liris or Garigliano, which has its source in the central Apennines above Sora, not far from the Lake Fucino, and enters the Gulf of Gaeta about 10 miles east of the city of that name, brings down a considerable body of water; as does also the Volturno, which rises in the mountains between Castel di Sangro and Agnone, flows past Isernia, Venafro, and Capua, and enters the sea about 15 miles from the mouth of the Garigliano. About 16 miles above Capua it receives the Calore, which flows by Benevento, and is a tributary of some importance. The Silarus or Sele, which enters the Gulf of Salerno a few miles below the ruins of Paestum, is the only other river of consideration on the western coast of Southern Italy. Below this the watershed of the Apennines is too near to the sea on that side to allow of the formation of any streams of importance. Hence the rivers that flow in the opposite direction into the Adriatic and the Gulf of Taranto have much longer courses, and are of more considerable volume and magnitude, though all of them partaking of the character of mountain torrents, rushing down with great violence in winter and after storms, but dwindling into scanty streams in the summer, which hold a winding and sluggish course through the great plains of Apulia. Proceeding south from the Trigno, which has been already mentioned as constituting the limit of Central Italy, we find (1) the Biferno and (2) the Fortore, both of them rising in the mountains of Samnium, and flowing into the Adriatic west of Monte Gargano; (3) the Cervaro, south of the great promontory; and (4) the Ofanto, familiar to all scholars as the Aufidus of Horace, whose description of it is characteristic of almost all the rivers of southern Italy, of which it may be taken as the typical representative. It rises about 15 miles west of Conza, and only about 25 miles from the Gulf of Salerno, so that it is frequently (though erroneously) described as traversing the whole range of the Apennines. In its lower course it flows near Canosa and traverses the celebrated battlefield of Cannæ. (5) The Bradano, which rises near Venosa, almost at the foot of Monte Voltore, flows towards the south-east into the Gulf of Taranto, as do the Basento, the Agri, and the Sinnò, all of which descend from the central chain of the Apennines south of Potenza, and water the extensive plains between the mountains and the shores of the gulf. The Crati, which flows from Cosenza northwards, and then turns abruptly eastward to enter the same gulf, is the only stream worthy of notice in the rugged peninsula of Calabria; while the long extent of arid limestone hills projecting eastwards to Capo di Leuca does not give rise to anything more than a mere streamlet, from the mouth of the Ofanto to the south eastern extremity of Italy.

*Lakes.*—The only important lakes in Italy are those at the foot of the Alps, formed by the expansion of the tributaries of the Po, which, after descending from the mountain valleys in which they are at first confined, spread out into considerable sheets of water before traversing the extensive plain of Northern Italy. They have been already noticed in connexion with the rivers by which they are formed, but may be again enumerated in order of succession. They are, proceeding from west to east, (1) the Lago d'Orta, (2) the Lago Maggiore, (3) the Lago di Lugano, (4) the Lago di Como, (5) the Lago d'Iseo, (6) the Lago d'Idro, and (7) the Lago di Garda. Of these the last named is considerably the largest, covering a superficial area of about 140 English square miles. It is about 38 miles long by 12 broad at its southern extremity; while the Lago Maggiore, notwithstanding its name, though considerably exceeding it in length (42 miles), falls

materially below it in superficial extent. They are all of great depth,—the Lago Maggiore having in one part a depth of 2600 feet, while that of Como attains to 1925 feet. Of a wholly different character is the Lago di Varese, between the Lago Maggiore and that of Lugano, which is a mere shallow expanse of water, surrounded by hills of very moderate elevation. Two other small lakes in the same neighbourhood, as well as those of Erba and Pusiano, between Como and Lecco, are of a similar character, and scarcely worthy of notice.

The lakes of Central Italy, which are comparatively of trifling dimensions, belong to a wholly different class. The most important of these, the Lacus Fucinus of the ancients, now called the Lago di Celano, which is situated almost exactly in the centre of the peninsula, occupies (as has been already pointed out) a basin of considerable extent, surrounded on all sides by mountains, and without any natural outlet, at an elevation of more than 2000 feet above the sea. Its waters have of late years been in great part carried off by an artificial channel, and more than half its surface laid bare. Next in size is the Lago Trasimeno, often called the Lago di Perugia, so celebrated in Roman history; it is a broad expanse of shallow waters, surrounded only by low hills, but about 30 miles in circumference. The neighbouring lake of Chiusi is of similar character, but much smaller dimensions. All the other lakes of Central Italy, which are scattered through the volcanic districts west of the Apennines, are of a wholly different formation, and occupy deep cup-shaped hollows, which have undoubtedly at one time formed the craters of extinct volcanoes. Such is the Lago di Bolsena, near the city of the same name, which is an extensive sheet of water, as well as the much smaller Lago di Vico (the Cimianian lake of ancient writers) and the Lago di Bracciano, nearer Rome, while again to the south of Rome the well known lakes of Albano and Nemi have a similar origin.

The only lake properly so called in Southern Italy is the Lago del Matese, in the heart of the mountain group of the same name, of very trifling extent. The so-called lakes on the coast of the Adriatic north and south of the promontory of Gargano are in fact mere brackish lagoons communicating with the sea.

*Islands.*—The three great islands of Sicily, Sardinia, and Corsica are so closely connected with Italy, both by geographical position and community of language, that they are frequently spoken of as the Italian Islands, but they will best be considered separately, and we shall here confine our attention to the smaller islands that lie scattered in the Mediterranean within sight of the coasts of Italy. Of these by much the most considerable is that of Elba, situated on the west coast of Central Italy, about 50 miles south of Leghorn, and separated from the mainland at Piombino by a strait of only about 6 miles in width. North of this, and just about midway between Corsica and Tuscany, is the small island of Capraja, steep and rocky, and only  $4\frac{1}{2}$  miles long, but with a secure port; Gorgona, about 25 miles farther north, is still smaller, and is a mere rock, inhabited only by a few fishermen. South of Elba are the equally insignificant islets of Pianosa and Monte Cristo, while the more considerable island of Giglio lies much nearer the mainland, immediately opposite the remarkable mountain promontory of Monte Argentario, itself almost an island. Of a wholly different character are the islands that are found farther south in the Tyrrhenian Sea. Of these Ischia and Procida, both of them situated almost close to the northern headland of the Bay of Naples, are entirely of volcanic origin, as is the case also with the more distant group of the Ponza Islands. These are three in number—Ponza, Palmaruola, and Zannone; while Vandotena (also of volcanic formation) is





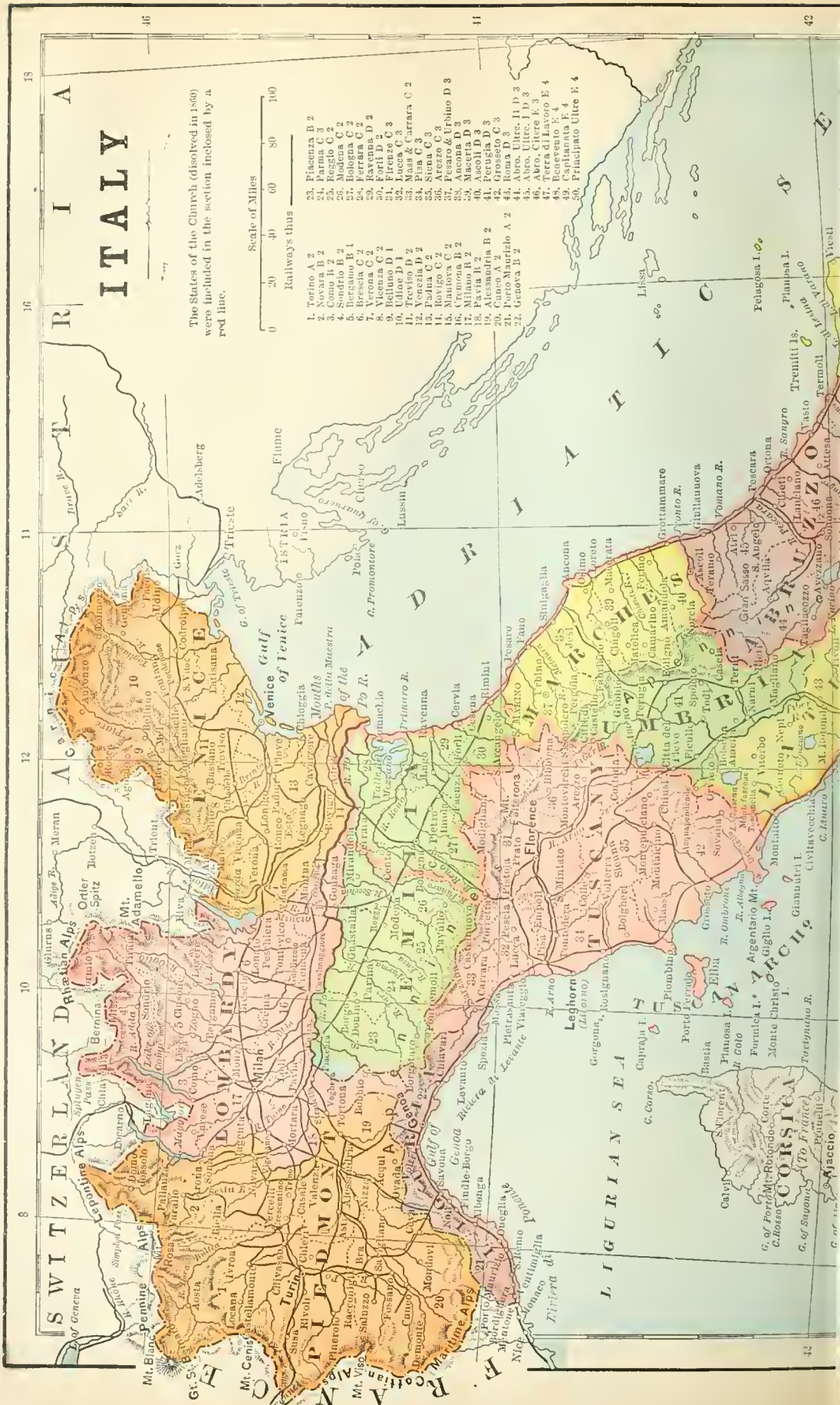

# I T A L Y

The States of the Church (dissolved in 1860) were included in the section enclosed by a red line.

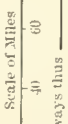

1. Torino A 2
2. Piacenza B 2
3. Como B 2
4. Sondrio B 2
5. Bergamo B 1
6. Brescia C 2
7. Ferrara C 2
8. Vicenza C 2
9. Belluno D 1
10. Udine D 1
11. Treviso D 2
12. Gorizia C 2
13. Padua C 2
14. Mantova C 2
15. Verona C 2
16. Cremona B 2
17. Pavia C 2
18. Milano B 2
19. Alessandria B 2
20. Cuneo A 2
21. Porto Maurizio A 2
22. Genova B 2
23. Piacenza B 2
24. Parma B 2
25. Modena C 2
26. Bologna C 2
27. Ferrara C 2
28. Mantova C 2
29. Pavia C 2
30. Pavia D 2
31. Firenze C 3
32. Lucca C 3
33. Massa Carrara C 2
34. Livorno C 2
35. Siena C 3
36. Arezzo C 3
37. Pesaro & Urbino D 3
38. Ancona D 3
39. Macerata D 3
40. Ascoli D 3
41. Perugia D 3
42. Grosseto C 3
43. Roma D 3
44. Avellino D 3
45. Ugento D 3
46. Abri. C. F. 3
47. Terra di Lavoro E 4
48. Benevento E 4
49. Capitanata E 4
50. Principato Ultra E 4







about midway between Ponza and Ischia. The island of Capri, on the other hand, which is just opposite to the southern promontory of the Bay of Naples, is a precipitous limestone rock. The Æolian or Lipari Islands, a remarkable volcanic group, belong rather to Sicily than to Italy, though Stromboli, the most easterly of them, is about equidistant from Sicily and from the mainland. The islands to the south of Sicily—Malta and Gozo, and Pantelleria—in like manner do not fall within the scope of the present article. Malta indeed has very little natural connexion with Sicily, and none with the continent of Italy.

The Italian coast of the Adriatic presents a great contrast to its opposite shores, for while the coast of Dalmatia is bordered by a succession of islands, great and small, the long and uniform coast-line of Italy from Otranto to Rimini presents not a single adjacent island; and the small outlying group of the Tremiti Islands (north of the Monte Gargano and about 15 miles from the mainland) alone breaks the monotony of this part of the Adriatic.

#### *Climate and Natural Productions.*

The geographical position of Italy, extending from about 46° to 38° N. lat., naturally renders it one of the hottest countries in Europe. But the effect of its southern latitude is to a great extent tempered by its peninsular character, bounded as it is on both sides by seas of considerable extent, as well as by the great range of the Alps with its snows and glaciers to the north. Great differences also exist with regard to climate between Northern and Southern Italy, due in great part to other circumstances as well as to difference of latitude. Thus the great plain of Northern Italy is chilled by the cold winds from the Alps, while the damp warm winds from the Mediterranean are to a great extent intercepted by the Ligurian Apennines. Hence this part of the country has a cold winter climate, so that the thermometer descends as low as 10° Fahr., and the mean winter temperature of Turin is actually lower than that of Copenhagen. Throughout the region north of the Apennines no plants will thrive which cannot stand occasional severe frosts in winter, so that not only oranges and lemons but even the olive tree cannot be grown, except in specially favoured situations. On the other hand the strip of coast between the Apennines and the sea, known as the Riviera of Genoa, is not only extremely favourable to the growth of olives, but produces oranges and lemons in abundance, while even the aloe, the cactus, and the palm flourish in many places. Indeed, the vegetation of parts of this favoured district has a more southern character than is met with again till below Terracina towards the south. The great plain of Lombardy, however, produces rice in large quantities, as well as Indian corn, millet, and wheat; while the mountain slopes both of the Alps and Apennines are covered with vast forests of chestnuts, and the lower hills are clothed with vineyards, which furnish abundance of wines, many of them of excellent quality. Silk is also an important article of produce both in the north of Italy and in Tuscany, and mulberries are largely planted with a view to its production.

Central Italy also presents striking differences of climate and temperature according to the greater or less proximity to the mountains. Thus the greater part of Tuscany, and the provinces from thence to Rome, enjoy a mild winter climate, and are well adapted to the growth of mulberries and olives as well as vines, but it is not till after passing Terracina, in proceeding along the western coast towards the south, that the vegetation of Southern Italy develops itself in its full luxuriance. Even in the central parts of Tuscany, however, the climate is very much affected by the neighbouring mountains, and the increasing elevation of the Apennines as they proceed south naturally produces

a corresponding effect upon the temperature. But it is when we reach the central range of the Apennines that we find the coldest districts of Italy. In all the upland valleys of the Abruzzi and of Sannio, snow begins to fall early in November, and heavy storms occur often as late as May; whole communities are shut out for months from any intercourse with their neighbours, and some villages are so long buried in snow that regular passages are made between the different houses for the sake of communication among the inhabitants. The district extending from the south-east of Lake Fucino to the Piano di Cinquemiglia, and enclosing the upper basin of the Sangro and the small lake of Scanno, is the coldest and most bleak part of Italy south of the Alps. Heavy falls of snow in June are not uncommon, and it is only for a short time towards the end of July that the nights are totally exempt from light frosts. Yet less than 40 miles east of this district, and even more to the north, we find the olive, the fig-tree, and the orange thriving luxuriantly on the shores of the Adriatic from Ortona to Vasto. In the same way, whilst in the plains and hills round Naples snow is rarely seen, and never remains long, and the thermometer seldom descends to the freezing point, 20 miles east from it in the fertile valley of Avellino, of no great elevation, but encircled by high mountains, light frosts are not uncommon as late as June; and 18 miles farther east, in the elevated region of S. Angelo de' Lombardi and Bisaccia, the inhabitants are always warmly clad, and vines grow with difficulty and only in sheltered places. But nowhere are these contrasts so striking as in Calabria. The shores, especially on the Tyrrhenian Sea, present almost a continued grove of olive, orange, lemon, and citron trees, which attain a size unknown in the north of Italy. The sugar-cane flourishes, the cotton-plant ripens to perfection, date-trees are seen in the gardens, the rocks are clothed with the prickly-pear or Indian fig, the enclosures of the fields are formed by aloes and sometimes pomegranates, the liquorice-root grows wild, and the mastic, the myrtle, and many varieties of oleander and cistus form the underwood of the natural forests of arbutus and evergreen oak. If we turn inland but 5 or 6 miles from the shore, and often even less, the scene changes. High districts covered with oaks and chestnuts succeed to this almost tropical vegetation; a little higher up and we reach the elevated regions of the Pollino and the Sila, covered with firs and pines, and affording rich pastures even in the midst of summer, when heavy dews and light frosts succeed each other in July and August, and snow begins to appear at the end of September or early in October. Along the shores of the Adriatic, which are exposed to the north-east winds, blowing coldly from over the Albanian mountains, delicate plants do not thrive so well in general as under the same latitude along the shores of the Tyrrhenian Sea.

Southern Italy indeed has in general a very different climate from the northern portion of the kingdom; and, though large tracts are still occupied by rugged mountains of sufficient elevation to retain the snow for a considerable part of the year, the districts adjoining the sea enjoy a climate similar to that of Greece and the southern provinces of Spain. Unfortunately several of these fertile tracts suffer severely from malaria, and especially the great plain adjoining the Gulf of Tarentum, which in the early ages of history was surrounded by a girdle of Greek cities,—some of which attained to almost unexampled prosperity,—has for centuries past been given up to almost complete desolation.

It is remarkable that, of the vegetable productions of Italy, many of those which are at the present day among the first to attract the attention of the visitor, and might be thought characteristic of the country, are of compara-



tively late introduction, and were wholly unknown in ancient times. The olive indeed in all ages clothed the hills of a large part of the country; but the orange and lemon, which now constitute so prominent a feature in the warmer districts of the peninsula, are a late importation from the East, while the cactus or Indian fig and the aloe, both of them so conspicuous on the shores of southern Italy, as well as of the Riviera of Genoa, are of Mexican origin, and consequently could not have been introduced earlier than the 16th century. The same remark applies to the maize or Indian corn, which is now so extensively cultivated in every part of Italy. Many botanists are even of opinion that the sweet chestnut, which now constitutes so large a part of the forests that clothe the sides both of the Alps and the Apennines, and in some districts supplies the chief food of the inhabitants, is not originally of Italian growth; it is certain at least that it had not attained in ancient times to anything like the extension and importance which it possesses at the present day.

It may have been gathered from the preceding sketch of the physical conformation and the climate of Italy that it is difficult to take a general view of the state of its agriculture. The cultivation of Lombardy differs from that of Calabria as much as that of Massachusetts does from that of Carolina. All that can be done therefore in this general description is to notice those results of agriculture which yield food, drink, or clothing to its inhabitants, or which form the basis of manufacturing industry or the rudiments of foreign commerce. The cereals form, as elsewhere in Europe, the chief aliment of the inhabitants; in Italy, however, the lower classes in many parts subsist much on maize and beans, which require little preparation to render them fit for food. In some of the southern provinces wheat is made use of by the same class, both in the form of bread and as macaroni, which is manipulated with great facility. Wheat and maize are, on the average of years, about equal to the consumption, but little can be spared for exportation; and in many of the ports depôts of foreign wheat are kept to meet the variations of seasons, or to be used as articles of commerce with other countries.

As Italy produces abundance of wine, and consequently needs neither beer nor grain-spirits, no barley is needed for these drinks, and scarcely any is cultivated. Oats are but little grown, but beans of various kinds are produced in abundance. Rye, the common bread-corn of the far greater portion of Europe, is only raised in a few spots in the very northernmost parts of Italy, where it is made into bread for the poor; whilst those of the higher classes there, as well as throughout the whole peninsula in the cities, make use of wheaten bread. Rice grows in many parts, in fact wherever there is a sufficiency of water to insure a good produce, at such a distance from towns as not to be injurious to the health of the inhabitants. A great variety of lupines are used as food, especially in the soups. In some parts of the mountainous regions chestnuts are a substitute for corn, and even form the principal food of the population. Fruits are plentifully used, particularly figs, grapes, and melons, as food; whilst the cheapness of onions, garlic, tomatoes or love-apples, and capsicums renders them valuable as condiments. The potato, which is in such common use in other parts of Europe, has been but partially introduced into Italy; and, where it is cultivated, it occupies a very small proportion of the soil. Lettuces, asparagus, endive, artichokes, and several kinds of turnips and of carrots are grown everywhere.

Animal food is far from being extensively used. The oxen yield in some parts excellent in others very indifferent meat. The mutton is neither good nor abundant, but has been much improved of late years. Swine furnish a

plentiful supply during the winter months; they are also prepared as bacon or hams, and above all as sausages, the fame of which has reached England under the name of the city of Bologna, where they were early and extensively prepared. The large dairy farms in Lombardy also furnish great quantities of cheese of very superior quality, especially that known by the name of Parmesan.

The fisheries contribute largely to the supply of food in Italy, though, from the number of fasts countenanced by the Catholic Church, not enough for the consumption; and the deficiency is procured by commerce with the English, French, and Americans, who convey to the seaports salted cod-fish from the banks of Newfoundland. The native fisheries on the coast give much occupation; the most considerable are those for the tunny, a very large fish, and for the anchovy, a very small one. These are conducted upon a large scale by joint-stock companies. The lakes and the rivers also yield some, though not a great proportion, of that kind of food which ecclesiastical restrictions render indispensable.

The sugar-cane is not cultivated in the south of Italy, as it is found that in point of strength, as well as of cost, the sugar made from it does not succeed in competition with that imported from the West Indies.

The products of agriculture are sufficient for the clothing of all its inhabitants; for, though wool is in general neither good nor plentiful, hemp and flax are grown everywhere, and are manufactured at home; and, from the nature of the climate, linen can be substituted for woollen dress during most of the months of the year. Some cotton is grown in the southern divisions of Italy, but not sufficient to furnish materials for their inconsiderable manufactures of that article.

The chief product of Italian agriculture is silk. It is produced in every part, and much of it is converted into articles of dress or of furniture, where it is collected; but the chief production of it is in the Neapolitan provinces and Lombardy, whence the looms of England, Austria, Russia, and Germany are supplied. The value of this commodity exceeds that of all the other productions of Italy which are exported to foreign countries. The manufacture has of late years made great progress, which it is still steadily maintaining, and the great increase which has taken place in the propagation of the mulberry tree has, within the last fifty years, increased the quantity of raw silk to an extent that had never before been dreamed of.

Another very important Italian product, which is partly used as food, partly employed in home manufactures, and extensively exported as an article of foreign commerce, is the oil of the olive tree. It is used as a substitute for butter in the south, and even to a great degree supplies the place of milk, which is comparatively little used in the peninsula. It is exported to England for use with various fabrics, and as a table luxury. The planting and watching costs but little labour or expense, and in a few years the income more than repays the labour. The best olive oil is produced near Genoa, in Lucca, in Tuscany, and in Calabria; but it is plentiful throughout the whole of Italy, except in Lombardy and in Piedmont.

The wines of Italy are not very highly valued in other countries, and almost the whole that is produced is consumed at home. Yet there is little doubt that with more care in the culture and preparation they might rival those of the best parts of Europe. The vines are not so much grown in vineyards as in the hedge-rows,—a system which doubtless injures the quality of the wine. In the southern parts, however, where the vines are grown in low vineyards as in France, the wines are of higher quality.

The mineral productions of Italy are of comparatively small value; but the copper mines of Tuscany, which were

extensively wrought in ancient times, are still worked to a considerable extent. The iron of Elba, so celebrated in antiquity, still bears a high character for its excellent quality, but the quantity produced is limited. Many marbles of superior quality are found in different parts of the Apennines, of which the white statuary marble of Carrara is the most celebrated. Alabaster also abounds in Tuscany. Coal is wanting in all parts of the peninsula, which must ever be a great drawback to the prosperity of Italy.

The geology of Italy is mainly dependent upon that of the APENNINES (*q.v.*). On each side of that great chain, which, as has been already stated, with its ramifications and underfalls, fills up the greater part of the peninsula, are found extensive Tertiary deposits, sometimes, as in Tuscany, the Monferrat, &c., forming a broken, hilly country, at others spreading into broad plains or undulating downs, such as the Tavoliere of Puglia, and the tract that forms the spur of Italy from Bari to Otranto.

But besides these, and leaving out of account the islands, the Italian peninsula presents four distinct volcanic districts. In three of them the volcanoes are entirely extinct, while the fourth is still in great activity.

(1) The Euganean hills form a small group extending for about 10 miles from the neighbourhood of Padua to Este, and separated from the lower offshoots of the Alps by a portion of the wide plain of the Padovano. Monte Venda, their highest peak, is 1806 feet high.

(2) The Roman district, the largest of the four, extends from the hills of Albano to the frontier of Tuscany, and from the lower slopes of the Apennines to the Tyrrhenian Sea. It may be divided into three groups:—the Monti Albani, the highest of which, Monte Cavo, 3160 feet, is the ancient Mons Albanus, on the summit of which stood the temple of Jupiter Latiaris, where the assemblies of the cities forming the Latin confederation were held; the Monti Cimini, which extend from the valley of the Tiber to the neighbourhood of Civita Vecchia, and attain at their culminating point an elevation of more than 3000 feet; and the mountains of Radicofani and Monte Amiata, the latter of which is 5650 feet high. The lakes of Bolsena (*Vulsiniensis*), of Bracciano (*Sabatinus*), of Vico (*Ciminus*), of Albano (*Albanus*), of Nemi (*Nemorensis*), and other smaller ones belong to this district; while between its south-west extremity and Monte Circello the Pontine Marshes form a broad strip of alluvial soil infested by malaria.

(3) The volcanic region of Terra di Lavoro is separated by the Volscian mountains from the Roman district. It may be also divided into three groups. Of Roccamonfina, at the north-north-west end of the Campanian Plain, the highest cone, called Montagna di Santa Croce, is 3200 feet. The Phlegrean Fields embrace all the country round Baia and Pozzuoli and the adjoining islands. Monte Barbaro (*Gaurus*), north-east of the site of Cumæ, Monte S. Nicola (*Epomens*), 2610 feet, in Ischia, and Camaldoli, 1488 feet, west of Naples, are the highest cones. The lakes Averno (*Avernus*), Lucrino (*Lucrinus*), Fusaro (*Palus Acherusia*), and Agnano are within this group, which has shown activity in historical times. A stream of lava issued in 1198 from the crater of the Solfatara, which still continues to exhale steam and noxious gases; the Lava dell' Arso came out of the north-east flank of Monte Epomco in 1302; and Monte Nuovo, north-west of Pozzuoli, 440 feet high, was thrown up in three days in September 1538. Since its first historical eruption in 79 A.D., Vesuvius or Somma, which forms the third group, has been in constant activity, and repeated eruptions have taken place within the last few years. The Punta del Nasone, the highest point of Somma, is 3747 feet high, while the Punta del Palo, the

highest point of the brim of the crater of Vesuvius, varies materially with successive eruptions from 3856 to 4235 feet.

(4) The Apulian volcanic formation consists of the great mass of Monte Voltore, which rises at the west end of the plains of Apulia, on the frontier of Basilicata, and is surrounded by the Apennines on its south-west and north-west sides. Its highest peak, the Pizzuto di Melfi, attains an elevation of 4357 feet. Within the highest crater there are the two small lakes of Monticchio and S. Michele.

In connexion with the volcanic districts we may mention *Le Mofete*, the Pools of Amsanctus (*Amsancti Vallis*), lying in a wooded valley south-east of Frigento, in the centre of Principato Ultra and described by Virgil (*Æneid*, vii. 563–71). The largest of the two is not more than 160 feet in circumference, and 7 feet deep. These pools emit noxious gases which, when wafted from the pools by the wind, endanger animal life in the open air.

#### *Ethnography and Ancient Geography.*

The ethnography of ancient Italy is a very complicated and difficult subject, and notwithstanding the researches of modern scholars is still involved in much obscurity. The great beauty and fertility of the country, as well as the charm of its climate, undoubtedly attracted from the earliest ages successive swarms of invaders from the north, who sometimes drove out the previous occupants of the most favoured districts, at others reduced them to a state of serfdom, or settled down in the midst of them, until the two races gradually coalesced into one. Ancient writers all agreed in regard to the fact of the composite character of the population of Italy, and the diversity of races that were found within the limits of the peninsula. But unfortunately the traditions they have transmitted to us are very various and conflicting, and probably in many instances founded on inadequate information, while the only safe test of the affinities of nations, derived from the comparison of their languages, is to a great extent deficient, from the fact that, with the single exception of Latin, all the idioms that prevailed in Italy in the earliest ages have disappeared, or are preserved only in a few scanty and fragmentary inscriptions. Imperfect as are the means thus afforded to the philological student, they have been of late years diligently turned to account, especially by German scholars, and, when combined with the notices derived from ancient writers, may be considered as having furnished some results that may be relied on with reasonable certainty.

Leaving aside for the present the populations of Northern Italy, which belong to a wholly different stock, the inhabitants of the peninsula may be regarded as belonging to three principal divisions. Of these the Messapians or Iapygians in the south may be considered as constituting one; while the different nations of Central Italy, the Umbrians, Oscans, Sabines, and Latins, may also be classed as belonging to one great family; and on the other hand the Etruscans in the west undoubtedly formed a nation apart, distinct from all others within the confines of Italy.

1. *The Iapygians and Enotrians.*—It is certain that when the first Greek colonies in the 8th and 9th centuries B.C. established themselves in the extreme south of Italy, they found the country in the possession of a people to whom they gave the name of Enotrians,—a name which appears to have been somewhat vaguely applied by different writers so as to include a wider area or be restricted within narrower limits. But the peninsula which stretches eastward towards Greece was inhabited by a people termed by the Greeks Messapians or Iapygians, whose relations to the Enotrians are not very clearly intimated. It is unfortunately in this part of the country almost exclusively that



the extant remains of the language have been found, and these consist of inscriptions of so brief and fragmentary a character as to afford a very imperfect basis for philological inferences. Such as they are, however, they seem to lead to the conclusion that the language spoken in this part of Italy was essentially distinct from the Oscan and Sabellian dialects of Central Italy; while at the same time they present sufficient analogies with the Latin on the one hand and the Greek on the other to show that they belonged to the same family with those two well-known languages. The results, therefore, of the recent examination of these long neglected documents appear distinctly to confirm the statements of ancient authors, according to which the inhabitants of the southern portion of the peninsula were a Pelasgic race,—a term used by them in a very vague and general manner, but usually employed to designate the most ancient inhabitants both of Greece and Italy, who probably belonged to the same branch of the great Aryan race. The Pelasgic origin of the Enoetrians is not only asserted by the concurrent testimony of many ancient authors, but we are told that the native population of Southern Italy, who had been reduced to a state of serfdom analogous to that of the Penestæ in Thessaly and the Helots in Laconia were still called Pelasgi. The evidence as to the Pelasgic origin of the Messapians or Iapygians is less definite; but the mythical genealogies in which the earliest Greek authors embodied the received traditions concerning the relations of different tribes and nations all point to the same conclusion; and they certainly regarded the neighbouring tribes of the Peucetians and Daunians, who occupied a part of the country subsequently known as Apulia, as derived from the same stock. A strong confirmation of this view is found in the facility with which the inhabitants of these countries assimilated Greek customs and manners, though the actual Greek colonies founded among them in historical times were comparatively few.

It must be observed that the name of Italians was at one time confined to the Enoetrians; indeed, according to Antiochus of Syracuse, the name of Italy was at first still more limited, being applied only to the southern portion of the peninsula now known as Calabria. But in the time of that historian, as well as of Thucydides, the names of Enoetria and Italia, which appear to have been at that period regarded as synonymous, had come to be extended so as to include the shore of the Tarentine Gulf as far as Metapontum and from thence across to the Gulfs of Laus and Posidonia on the Tyrrhenian Sea. It thus still comprised only the two provinces subsequently known as Lucania and Bruttium.

2. The tribes of Central Italy, from the Umbrians in the north to the Campanians in the south, are known by existing remains of their languages to have spoken cognate dialects, presenting unquestionable affinities with each other, as well as with the earlier forms of the well-known language of the Latins. The differences, however, are still very considerable, and confirm the testimony of historical tradition, as preserved to us by ancient writers, in leading us to divide them into five separate groups, viz., the Umbrians, Sabines, Latins, Volscians, and Oscans, or as they are sometimes termed Sabellians, including the Samnites and Campanians, and the tribes (such as the Lucanians, Frentani, &c.) who are distinctly recorded to have emanated from the Samnites.

(1) The *Umbrians*, who occupied in historical times the eastern portion of the peninsula between Etruria and the Adriatic, were at an earlier period a much more powerful nation, and not only occupied the extensive tract subsequently wrested from them by the Gauls, but, extended their dominion from sea to sea, and held the greater part,

if not the whole, of the territory afterwards possessed by the Etruscans, which is said to have been wrested by that people foot by foot from the Umbrians. The concurrent voice of the traditions preserved to us from antiquity points to the Umbrians as one of the most ancient nations of Italy; and this is confirmed by the still extant remains of their language as shown in the celebrated inscriptions known as the EUGUBINE TABLES (*q.v.*), by far the most important monument of any of the early Italian languages that has been transmitted to our time. The elaborate examination of this valuable record in recent times may be considered as establishing clearly, on the one hand, the distinctness of the language from that of the neighbouring Etruscans, and, on the other, its close affinity with the Oscan, as spoken by the Sabellian tribes, and with the old Latin. The same researches tend to prove that the Umbrian dialect is the most ancient of these cognate tongues, and probably represents most nearly the original form of this branch of the great Indo-Tentonic family. They may be taken also as distinctly negating the theory put forth by some ancient writers, and maintained by several modern inquirers, that the Umbrians were a Celtic race.

Before the time when the Umbrians came into contact with the advancing power of Rome, their importance had greatly declined. The Etruscans had conquered from them the whole territory west of the Apennines, from the foot of the mountains to the Tyrrhenian Sea, while the Senonian Gauls, who invaded the north of Italy in the 4th century B.C., permanently established themselves in possession of the fertile district between the Apennines and the Adriatic, extending from the neighbourhood of Ravenna to that of Ancona, which continued to be known until long afterwards as the "Ager Gallicus."

(2) The *Sabines* are a people of whom, familiar as is their name to the student of Roman history, we know very little. Their language is totally lost; not a single inscription has been preserved to us, and it appears to have fallen into disuse at a comparatively early period. But even from the few scattered notices of Sabine words preserved by Roman grammarians it is evident that it possessed strong affinities with the Oscan and Umbrian; and the facility with which it passed into those of the neighbouring races is a strong reason against there being any marked diversity between them. The traditions recorded by ancient writers, untrustworthy as they are in detail, all concur in pointing to the same result,—that the Sabines were a very ancient people, who, at the earliest period of which any memory was preserved, were settled in the lofty mountain districts about the sources of the Aternus and the Velinus, from which they subsequently descended into the more fertile valleys about Reate, and at one time extended their dominion to within a few miles of Rome,—Cures, which was universally reckoned a Sabine city, being only 24 miles from the capital, while Nomentum and Eretum, still nearer Rome, are included by several writers as Sabine towns.

That a people inhabiting so ragged and inclement a district as that which is represented as the original abode of the Sabines should have spread themselves into the neighbouring regions, and established offshoots in somewhat more favoured lands, is entirely in accordance with probability, and hence we can have no difficulty in accepting the tradition that the Picentes, or inhabitants of Picenum,—the fertile district along the coast of the Adriatic between that sea and the main ridge of the Apennines, from beyond Ancona to the river Matrino,—were of Sabine origin. The same thing is expressly asserted by Ovid (himself a native of the district) of the Peligni, a tribe who occupied the upland valley of the Gizio, of which Sulmo was the capital; and there can be little doubt that the



same remark applied to three other tribes which were contiguous to them, and always appear in the Roman history in close political union with them:—the Marsi, who held the basin of the Lake Fucino and the surrounding mountains, and the Vestini and Marrucini, who extended from the confines of the Marsi and Peligni down to the Adriatic, each people occupying but a narrow strip on the north and south sides respectively of the Ateranus.

(3) The *Latins*, who were destined in the end to become the rulers of all Italy, were in the first instance a comparatively insignificant people, surrounded on all sides by more powerful nations. When we first become acquainted with their history they occupied only the tract extending from the Tiber on the north to the Volscian mountains and the Pontine Marshes on the south, and from the sea to the underfalls of the Apennines about Tibur (Tivoli) and Præneste (Palestrina). It was not till a much later period that the name of Latium was extended so as to include the land of the Volscians and the Aurunci to the borders of Campania.

The ethnical relations of the Latins have been peculiarly confused by the conflicting statements of ancient authors, who endeavoured to connect them on the one hand with the vast floating mass of Greek traditions, and on the other to add dignity to their origin by tracing them back to indigenous heroes or deities. Of their real origin as a people, or of the period when they first settled in the fertile district where we find them established at the dawn of historical record, we have no trustworthy information. But from the manifold traditions preserved to us by Dionysius and other authors we may perhaps gather two facts. The statement that the Latins were derived (in part at least) from a people who dwelt originally in the lofty mountains of the central Apennines, from whence they descended into the comparatively fertile region between the mountains and the sea, probably represents in a general way correctly the course of their immigration; while the idea involved in several of these traditions, that the population of ancient Latium was in part derived from a Pelasgic origin, is confirmed by philological investigation of the Latin language, which may be considered as establishing the conclusion that it contained a considerable Pelasgic or old Greek element, together with another portion which was common to the languages of the adjacent nations of Central Italy, the Umbrians, Oscans, &c., whom we are now considering. The co-existence of these two diverse elements in Latin was long ago pointed out by Niebuhr, who attributed it to the conquest of one race by another at a period anterior to all historical record. It may perhaps be more safely ascribed to the branching off of the Latin race from the parent stock at an earlier period than the other languages of Central Italy, while the differences that separated them from those of the early inhabitants of Greece were less marked than they afterwards became.

(4) The *Volscians*, who ultimately became merged in the more progressive Latin race, are undoubtedly represented to us in the early Roman history as a distinct people, not only politically separate from the Latin league, but having a distinct language of their own, which was neither Latin nor Oscan. The very scanty remains of it that have been preserved to us by inscriptions, while they confirm this statement, show at the same time remarkable analogies with the Umbrian, and thus tend to prove that the Volscians had occupied from a very early period the rugged mountain district where we find them established in historical times, and had retained their dialect with less change than their Sabellian and Oscan neighbours.

Of the *Æquians*, who held a mountainous district adjoining that of the Volscians, we cannot be said to know anything beyond the fact that the two nations appear

constantly in Roman history in alliance against the rising republic, from which, however, we are hardly entitled to argue their common descent. But it is certain that both the *Æquians* and the petty tribe of the *Hernicæans* are in early ages uniformly represented as distinct from the Latins, though their territory was included in Latium, in the more extended sense of the term, while the native population had in the days of Livy almost wholly disappeared.

(5) The *Oscans*, or as the Greeks wrote the name *Opicæans* (the native form was *Opseans*), were the possessors of the greater part of Central Italy, as well as the southern part of the peninsula, at the time that the Romans were carrying on their long protracted struggle for its dominion. At the same time it must be observed that it was never used in ancient times as a proper ethnic appellation. No tribe or nation of the name appears among those with which Rome was engaged in hostilities; and, though the term Oscan is frequently used by ancient writers as applied to the language of Campania, there is no proof that it was ever employed by them in the more general sense adopted by modern scholars. It is, however, as a matter of convenience, a useful term to designate the nation or group of tribes composed of the Samnites, together with their descendants or offshoots, the Campanians, Lucanians, and Bruttians. The name Sabellians, used by the Roman poets, has been employed by some modern writers in much the same signification.

Of the nations comprised under this general appellation, much the most powerful were the *Samnites*, who occupied, not merely the small mountain district known in modern days as Sannio, but the whole region of the central Apennines from the upper valley of the Sagrus (Sangro) on the north to that of the Aufidus on the south, while towards the west they held the valleys of the Volturnus and its various tributaries down to the point where they emerged into the fertile plain of Campania. The territory thus defined was, like that of the Sabines, a wholly inland district, but the Samnites were not long content with these narrow limits, and at an early period we find them carrying their arms and extending their settlements to the sea on both sides. The *Frentani*, who separated them from the Adriatic to the north, are distinctly termed by Strabo a Samnite people, and distinguished by him as such from the adjoining tribes of the Vestini and Marrucini. A more important extension was that towards the west, where they conquered the whole of the rich province of Campania, with the exception of the districts on the coast still retained by the Greek colonies. This conquest appears to have taken place as late as the 5th century B.C., but the same causes continued in operation, and during the course of the next half century the Samnites spread themselves through the whole of Lucania, and even carried their arms to the extremity of the southern peninsula. The Lucanians therefore, when they first became known to the Romans, were a Samnite people, though possessing a separate political organization. They at this time ruled over the whole country called by the Greeks *Cænotria*, down to the Sicilian Strait, and had reduced the previous inhabitants to a state of serfdom. Hence not long afterwards there arose in the southernmost part of the peninsula (the modern Calabria) an insurrection, represented as a mere casual outbreak of outlaws and fugitive slaves, but probably in reality a revolt of the native population who, under the name of Bruttians, established their independence, and retained possession of the whole of this wild and mountainous country, till they passed, together with the Lucanians, under the all-absorbing dominion of Rome.

It is more difficult to determine to what extent the Apulians had received an admixture of the Samnite



element, but there seems no doubt that the northern part of the province known to the Romans under that name had been occupied by a Samnite population, while the tribes south of Mount Garganus—the Daunians and Peucetians—probably retained their nationality, though brought under subjection by the Samnites.

The monuments of the Oscan language, though not numerous, are more considerable than those of any other of the early Italian languages, except the Umbrian, and can for the most part be interpreted with reasonable certainty by the assistance of Latin. The most important of them are—(1) The Tabula Bantina, a bronze tablet found in the neighbourhood of Bantia (Banzi), on the borders of Apulia and Lucania, which relates to the municipal affairs of that town; (2) the Cippus Abellanus, so called from its having been found near Abella in Campania, containing a treaty or agreement between the two neighbouring cities of Nola and Abella; and (3) a bronze tablet more recently discovered in the neighbourhood of Agnone in northern Samnium, recording the dedication of various sacred offerings. It is interesting to observe that these three specimens of the ancient dialect have been found in nearly the most distant quarters of the Oscan territory. None have as yet been found in Lucania or Bruttium, but we know from Festus that the Bruttians spoke Oscan. The language was thus at one time spoken through the whole of the southern peninsula. It doubtless ceased to be employed officially after the defeat of the Samnites and their allies in the Social War (90–88 B.C.); but the numerous minor inscriptions found rudely scratched or painted on the walls of Pompeii show that it continued in vernacular use until a much later period.

3. *The Etruscans.*—The obscure question of the origin and affinities of this remarkable people, and the attempts that have been made to interpret their language, have been fully discussed in the article ETRURIA. For the present we must be content to acquiesce in the conclusion, which is in accordance with all the statements of ancient authors, that they were a people wholly distinct from all others in Italy, while the researches of modern writers have been able to throw but very little light upon their language or ethnical affinities.

*Northern Italy.*—The ethnography of Northern Italy is much more simple than that of the central regions of the peninsula. At the time when the Romans first became acquainted with this part of Italy, the whole country was divided among three nations—the Gauls, the Ligurians, and the Veneti or Venetians.

(1) Of these the *Gauls*, who occupied the extensive plains in the valley of the Po and its tributaries, and had extended their dominion from the Alps to the Apennines and the Adriatic, were unquestionably intruders or immigrants, who had crossed the Alps at a comparatively late period. The last emigration was that in which the Senones or Senonian Gauls established themselves, as has been already mentioned, in the coast land of Umbria between the Apennines and the Adriatic; and this invasion was, according to the Roman historians, directly connected with the capture of Rome in 390 B.C. But the migration of the great mass of the Gauls who occupied the plains of Northern Italy undoubtedly took place at a much earlier period, and is assigned by Livy, our only authority on the subject, and who unfortunately does not mention the sources from which he derived his information, to the reign of the elder Tarquin at Rome (616–578 B.C.). Who were the people that inhabited this country previous to their irruption we do not know with certainty, but the districts adjoining the foot of the Alps on the west were undoubtedly in the hands of Ligurian tribes, and those in the south at the foot of the Apennines had probably been at one time

occupied by the Umbrians, who had, however, previous to the Gaulish invasion been either driven out or reduced to subjection by the Etruscans. Of the character and extent of the Etruscan settlements in the region north of the Apennines we have very little information; but the statements of ancient authors that they had at one time extended their dominion over a considerable part of Northern Italy, and founded large cities—among which Felsina (afterwards called Bononia) and Mantua are especially mentioned—have been confirmed of late years by the discovery of undoubted Etruscan remains at Bologna and other places north of the Apennines (see ETRURIA). But it may well be doubted whether they ever formed the population of these countries; it appears more probable that they were merely a race of more civilized settlers in the midst of the native tribes.

Of the Gaulish tribes whose names are known to us as established in the north of Italy at the time when they first came into collision with the Roman arms, the most important were the Insubres and Cenomani to the north of the Po, and the Boii and Lingones to the south of that river. Immediately west of the Ticinus, the *Lævi* are expressly called by Livy a Ligurian tribe, while beyond the Adige to the east began the Veneti and Euganei, so that the territory thus occupied by the Gauls was far from comprising the whole tract subsequently known as Gallia Cisalpina.

(2) The *Ligurians* or *Ligures*—the Greek form of the name is *Ligyēs*—are a people of whose origin and affinities we know absolutely nothing, but whom we find from the earliest times in possession of the rugged mountainous tract with which their name is inseparably connected. They were, when we first hear of them, considerably more extensively spread than at a later period,—the south coast of Gaul, subsequently included in the Roman province of that name, having been originally occupied by Ligurian tribes. Thus the *Sallyes* or *Salluvii*, in whose territory the Greek colony of Massilia was founded (about 600 B.C.), are distinctly described as a Ligurian tribe, and it may be considered certain that they held the whole country from the Maritime Alps to the Rhone, while *Scylax* represents them as intermixed with Iberian tribes in the tract from the mouths of the Rhone to the foot of the Pyrenees. But all authorities agree that they were a separate nationality, distinct alike from the Iberians and from the Gauls. No trace of their language has been preserved and all theories as to their origin must be purely conjectural.

At the time when they first came in contact with the Roman arms, the Ligurians not only occupied the coast of the Mediterranean and underfalls of the Maritime Alps and Apennines from the Var to the Magra, but the much more extensive tract comprising the northern slopes of these mountains towards the valley of the Po! As has been already mentioned, it is probable that they were still more extensively spread in this direction prior to the irruption of the Gauls, but even in the historical period we find it distinctly stated that the *Lævi* and *Libici*, tribes immediately west of the Ticinus, were of Ligurian race. The same thing is told us both by Strabo and Pliny of the *Taurini*, and was probably true also of their neighbours the *Salassi*. But the tribes who appear in history as the indomitable foes of Rome, against whom they waged for nearly a century and a half (237–109 B.C.) a war much resembling that of the Circassians against Russia in modern times, were those on the two flanks of the Apennines, and the southern slopes of the Maritime Alps. Here the *Inganni* and *Intemelii* in the western Riviera, and the *Statielli* on the reverse of the mountains were the most conspicuous tribes; while towards the east the *Apnani*, who held the *Lunigiana* and the rugged mountain group above Carrara,

and the Friniates, who extended along the crest of the Apennines from thence to the neighbourhood of Florence, were the subjects of repeated triumphs, and gave the Romans more real trouble than their more brilliant conquests in Macedonia and Asia.

(3) The *Veneti* or *Vendicians*, who held the north-eastern portion of the great plain of Northern Italy, from the Adige to the Alps of the Frioul, were, according to the concurrent statements of ancient authors, a distinct people from their neighbours the Gauls. Attempts were made by some Greek writers to connect them with the Eneti or Heneti, mentioned by Homer, as a people of Paphlagonia, and several modern authors have sought to identify them with the Vendice or Weuds on the shores of the Baltic. But all such theories, based as they are solely on resemblances of name, are of little value. On the other hand it is distinctly stated by Herodotus that they were an Illyrian tribe; and, though this may very likely be a mere inference from their juxtaposition, it is not improbable in itself that they were of the same race with their neighbours the Istrians and Liburnians.

But, besides the Veneti properly so called, two other tribes were found in historical times within the limits of the province as constituted by Augustus. (1) The *Lugunians*, though they had at this period dwindled into an insignificant tribe, had at one time been a powerful people, and according to the statement of Livy (himself a native of this country) had originally occupied the whole tract between the Alps and the sea, from which they had been expelled by the Veneti. And this tradition is confirmed by the fact, that remnants of them still lingered in the Italian valleys of the Alps as late as the time of Pliny, and that their name remained inseparably attached, both in ancient and modern times, to the little group of volcanic hills between Padua and Verona, which are still known as the Euganean hills. (2) The *Carui*, who occupied the northern part of the Frioul, at the foot of the Alps, together with the adjoining mountains, appear to have been certainly a tribe of Celtic or Gaulish origin, and distinct from the Venetians, though included in the province of that name.

*Consolidation of Italy.*—We have seen that the name of Italy was originally applied only to the southernmost part of the peninsula, and was only gradually extended so as to comprise the central regions, such as Latium and Campania, which were designated by writers as late as Thucydides and Aristotle as in *Opicia*. The progress of this change cannot be followed in detail, but there can be little doubt that the extension of the Roman arms, and the gradual union of the nations of the peninsula under one dominant power, would contribute to the introduction, or rather would make the necessity felt, for the use of one general appellation. At first indeed the term was apparently confined to the regions of the central and southern districts, exclusive of Cisalpine Gaul and the whole tract north of the Apennines, and this continued to be the official or definite signification of the name down to the end of the republic. But the natural limits of Italy are so clearly marked that the name came to be generally employed as a geographical term at a much earlier period. Thus we already find Polybius repeatedly applying it to this wider signification to the whole country, as far as the foot of the Alps; and it is evident from many passages in the Latin writers that this was the familiar use of the term in the days of Cicero and Cæsar. The official distinction was, however, still retained. Cisalpine Gaul, including the whole of Northern Italy, still constituted a "province," an appellation never applied to Italy itself. As such it was assigned to Julius Cæsar, together with Transalpine Gaul, and it was not till he crossed the Rubicon that he entered Italy in the strict sense of the term.

Augustus was the first who gave a definite administrative organization to Italy, as a whole, and at the same time gave official sanction to that wider acceptation of the name, which had already established itself in familiar usage, and which has continued to prevail ever since.

The division of Italy into eleven regions (Plate V.), instituted by Augustus for administrative purposes, which continued in official use till the reign of Constantine, was based mainly on the territorial divisions previously existing, and preserved with few exceptions the ancient limits.

The first region comprised Latium (in the more extended sense of the term, as including the land of the Volscians, Hernicans, and Anrnuncans), together with Campania and the district of the Picentini. It thus extended from the mouth of the Tiber to that of the Stura.

The second region included Apulia and Calabria (the name by which the Romans usually designated the district known to the Greeks as Messapia or Calabria), together with the land of the Hirpini, which had usually been considered as a part of Samnium.

The third region contained Lucania and Bruttium; it was bounded on the west coast by the Silarus, on the east by the Bradanus.

The fourth region comprised all the Samnites (except the Hirpini), together with the Sabines and the cognate tribes of the Frentani, Marrucini, Marsi, Peligni, Vestini, and Æquiculi. It was separated from Apulia on the south by the river Tifernus, and from Picenum on the north by the Matrinas.

The fifth region was composed solely of Picenum, extending along the coast of the Adriatic from the mouth of the Matrinas to that of the Æsis, beyond Ancona.

The sixth region was formed by Umbria, in the more extended sense of the term, as including the Ager Galliana, along the coast of the Adriatic from the Æsis to the Ariminus, and separated from Etruria on the west by the Tiber.

The seventh region consisted of Etruria, which preserved its ancient limits, extending from the Tiber to the Tyrrhenian Sea, and separated from Liguria on the north by the river Macra.

The eighth region, termed Gallia Cispadana, comprised the southern portion of Cisalpine Gaul, and was bounded on the north (as its name implied) by the river Padus or Po, from above Placentia to its mouth. It was separated from Etruria and Umbria by the main chain of the Apennines; and the river Ariminus was substituted for the far-famed Rubicon as its limit on the Adriatic.

The ninth region comprised Liguria, extending along the sea-coast from the Varus to the Macra, and inland as far as the river Padus, which constituted its northern boundary from its source in Mount Vesulus to its confluence with the Trebia just above Placentia.

The tenth region included Venetia from the Padus and Adriatic to the Alps, to which was annexed the neighbouring peninsula of Istria, and to the west the territory of the Cenomani, a Gaulish tribe, extending from the Athesis to the Addua, which had previously been regarded as a part of Gallia Cisalpina.

The eleventh region, known as Gallia Transpadana, included all the rest of Cisalpine Gaul from the Padus on the south and the Addua on the east to the foot of the Alps.

The arrangements thus established by Augustus continued almost unchanged till the time of Constantine, and formed the basis of all subsequent administrative divisions until the fall of the Western empire. It is not worth while to follow in detail the changes introduced during the 4th century. It was the invasion of the Lombards that first broke up the general system of the Roman administration, and prepared the way for the redistribution of Italy in the Middle Ages on a wholly different basis. (E. H. B.)



STATISTICS.

The preceding sections have dealt with Italy the country as a permanent physical unity; here it is proposed to consider Italy the kingdom as a modern political and social unity. In dealing with the various aspects of the subject we shall be continually reminded of the fact that Italy is one of the very youngest of the greater nations of Europe. In attempting to trace back the movement of any department of social activity, the investigator here finds his retrospect soon interrupted and closed; instead of the statistics of the kingdom of Italy he has only the statistics, fragmentary and incapable of comparison, of the several states by whose incorporation it has been formed.

*Extent.*—Of the Italian frontier 294 miles coincide with that of France, 355 with that of Switzerland, and 269 with that of Austria. Owing mainly to natural causes, but partly also to political traditions, the line is a very irregular one; and at various points it has been subjected to rectifications on a small scale since the consolidation of the kingdom. The limits towards France are determined by the convention signed at Turin in 1861. The same year saw the revision of the line between Lombardy and Ticino on the basis of the treaty of Varese, 1752. In 1863 the boundary of the Grisons was slightly modified, and the Lei valley assigned to Italy; in 1873 the frontier was fixed between Teramo and Brusio and at the Alpe di Cravairola; and in 1875 a district of 4324 acres, or nearly 7 square miles, which had been in dispute was assigned to Italy by the arbitration of the United States, and incorporated with the province of Novara. On the surrender of the Austrian provinces of Italy to the new kingdom in 1867, it was decided that the frontier between the two states should be that of the actual administration of the Lombardo-Venetian kingdom.

The total area of the kingdom of Italy is given officially as 296,322.91 square kilometres or 114,380.64 square miles; but the estimate confessedly rests on data that are to a considerable extent provisional. It was published by Maestri, the head of the general direction of statistics in the census returns for 1861, and the investigations of the minister of public works in 1871 tended to confirm its general accuracy. But that it should be more than a very fair approximation to the truth is impossible in the defective state of the Italian surveys. Though various parts of the country were carefully gone over for cadastral purposes by commissions appointed by several of the independent states of the peninsula, the methods employed in the different cases were so heterogeneous that the results, even if complete, could not readily and correctly be combined into a whole. Many of the communes are destitute of any authentic demarcation of their territorial limits.

*Territorial Divisions.*—The kingdom is divided into the following sixteen compartimenti (Table I.) :—

1. *Piedmont*: Alessandria, Cuneo, Novara, Turin.
2. *Liguria*: Genoa, Porto Maurizio.
3. *Lombardy*: Bergamo, Brescia, Como, Cremona, Mantua, Milan, Pavia, Sondrio.
4. *Venice*: Belluno, Padua, Rovigo, Treviso, Udine, Venice, Verona, Vicenza.
5. *Emilia*: Bologna, Ferrara, Forlì, Modena, Parma, Piacenza, Ravenna, Reggio.
6. *Umbria*: Perugia.
7. *Marches*: Ancona, Ascoli Piceno, Macerata, Pesaro-Urbino.
8. *Tuscany*: Arezzo, Florence, Grosseto, Leghorn, Lucca, Massa-Carrara, Pisa, Siena.
9. *Lazio*: Rome.
10. *Abruzzi and Molise*: Aquila, Campobasso, Chieti, Teramo.
11. *Campania*: Avellino, Benevento, Caserta, Naples, Salerno.
12. *Apulia*: Bari, Foggia, Lecce.
13. *Basilicata*: Potenza.
14. *Calabrias*: Catanzaro, Cosenza, Reggio.
15. *Sicily*: Caltanissetta, Catania, Girgenti, Messina, Palermo, Syracuse, Trapani.
16. *Sardinia*: Cagliari, Sassari.

Of these Abruzzi and Molise, Campania, Apulia, Basilicata, and the Calabrias are not unfrequently grouped together in statistical tables under the name of the Neapolitan territory (Napoleitano). The provinces which formed the Sardinian kingdom are often spoken of as the Ancient Provinces.

These compartimenti, however, are not true administrative divisions, but rather conventional groupings of a number of provinces. It is the province which forms the true administrative unit. According to modern nomenclature it always takes its name from the capoluogo (chef-lieu or administrative centre), which is the seat of the prefect. The provinces are subdivided into so many circles or districts (the name *circondario* being employed in all parts of the kingdom except the Veneto, where the old established word

*distretto* is still in use). The division known as the *mandamento* has to do with the legal administration only. It must be noted that formerly many of the provinces had special designations other than those of their chief towns, and that some of these are still of not infrequent occurrence especially outside of Italy. Thus *Igoggio* corresponds to Calabria Ulteriore Prima, Catanzaro to Calabria Ulteriore Seconda, Cosenza to Calabria Citeriore, Teramo to Abruzzo Ulteriore Primo, Aquila to Abruzzo Ulteriore Secondo, Chieti to Abruzzo Citeriore, Campobasso to Molise, Foggia to Capitanata, Lecce to Terra d'Otranto, Bari to Terra di Bari, Avellino to Principato Ulteriore, Salerno to Principato Citeriore, Caserta to Terra di Lavoro, Potenza to Basilicata.

The following table (II.) gives the provinces, with their respective areas, according to Professor Baccarini in the *Annuario Statistico Italiano* 1881, pp. 82-9, and the populations ascertained by the census of 1861 and that of December 31, 1871. The figures in this table give a total of 114,403 square miles, slightly differing from the Maestri estimate.

No.	Provinces.	Area.		Population.	
		sq. kil.	sq. miles.	1861.	1871.
1	Messandria.....	5,954	1,951	645,007	681,361
2	Ancona.....	1,907	736	234,849	262,349
3	Aquila.....	6,500	2,509	309,451	292,784
4	Arezzo.....	3,300	1,277	249,559	236,445
5	Ascoli Piceno.....	2,095	809	196,030	203,004
6	Avellino.....	1,409	541	325,631	375,021
7	Bari.....	5,936	2,292	554,402	608,540
8	Belluno.....	3,201	1,231	?	175,282
9	Benevento.....	1,782	683	220,506	232,008
10	Bergamo.....	2,816	1,087	347,235	368,152
11	Bologna.....	3,691	1,390	407,452	439,232
12	Brescia.....	4,257	1,644	486,383	495,023
13	Cagliari.....	13,615	5,257	327,697	393,208
14	Caltanissetta.....	3,768	1,455	223,178	230,066
15	Campobasso.....	4,603	1,777	346,007	361,208
16	Caserta.....	5,974	2,307	653,464	697,403
17	Catania.....	5,102	1,970	430,400	495,415
18	Catanzaro.....	5,975	2,307	384,159	412,236
19	Chieti.....	2,861	1,105	327,316	339,986
20	Como.....	2,719	1,050	457,434	477,642
21	Cosenza.....	7,358	2,841	431,691	440,468
22	Cremona.....	1,647	632	339,641	306,595
23	Cunco.....	7,155	2,755	597,279	614,232
24	Ferrara.....	2,616	1,010	199,158	215,569
25	Florence (Firenze).....	5,873	2,267	696,214	766,624
26	Foggia.....	7,648	2,953	312,865	322,758
27	Forlì.....	1,824	719	224,461	235,000
28	Genoa (Genova).....	4,114	1,588	650,143	716,759
29	Girgenti.....	3,861	1,491	263,850	280,018
30	Grosseto.....	4,420	1,706	169,626	170,457
31	Lecce.....	8,529	3,293	447,982	493,594
32	Livorno (Leghorn).....	326	126	116,811	118,651
33	Lucca.....	1,493	576	256,161	280,399
34	Macerata.....	2,736	1,056	229,626	236,994
35	Mantova (Mantua).....	2,490	961	?	286,942
36	Massa and Carrara.....	1,779	687	140,733	161,944
37	Messina.....	4,579	1,769	395,139	420,649
38	Milano (Milan).....	2,992	1,155	948,320	1,009,234
39	Modena.....	2,501	966	200,591	233,231
40	Napoli (Naples).....	1,065	411	867,983	907,732
41	Novara.....	6,543	2,526	579,385	624,985
42	Padova (Padua).....	1,555	755	?	364,430
43	Palermo.....	5,086	1,964	587,163	617,678
44	Parma.....	3,239	1,250	256,629	264,381
45	Pavia.....	3,345	1,291	419,785	448,435
46	Perugia.....	9,633	3,719	515,619	548,801
47	Pesaro and Urbino.....	2,964	1,144	202,508	216,072
48	Pisa.....	2,409	925	216,569	235,000
49	Pistoia.....	3,056	1,185	243,028	255,775
50	Potenza.....	1,209	467	121,330	127,053
51	Potenza.....	10,675	4,122	492,959	601,643
52	Ravenna.....	1,922	742	209,518	221,115
53	Reggio Calabria.....	3,923	1,515	324,546	353,008
54	Reggio Emilia.....	2,271	877	220,054	240,625
55	Roma (Rome).....	11,917	4,601	—	836,704
56	Rovigo.....	1,686	651	?	200,833
57	Salerno.....	5,505	2,126	528,226	541,738
58	Sassari.....	10,726	4,141	245,907	249,632
59	Siena.....	3,784	1,465	198,935	206,446
60	Siracusa (Syracuse).....	3,697	1,437	259,613	294,885
61	Sondrio.....	2,267	1,261	106,040	111,241
62	Teramo.....	3,324	1,283	220,061	246,004
63	Torino (Turin).....	10,594	4,067	941,932	236,288
64	Trapani.....	3,145	1,214	214,981	252,538
65	Treviso.....	2,437	941	?	972,386
66	Udine.....	6,514	2,515	?	481,789
67	Venezia (Venice).....	2,198	848	?	337,538
68	Verona.....	2,747	1,060	?	361,437
69	Vicenza.....	2,652	1,016	?	363,101
		296,305	114,403	25,016,801	26,801,154

<sup>1</sup> In the ancient Piedmont provinces a cadastral survey was undertaken as early as 1677, but it was not finished till 1729; in the Modenesi provinces that of Garfagnana goes back to 1533, that of Rola to 1785, that of the "plain and hill" to 1791; in the Tuscan provinces the cadastre was compiled between 1822 and 1834; and the Lombardo-Venetian provinces have a double cadastre, the first dating from 1718, the second commenced in 1829. See *Atti del primo congresso degli ingegneri ed architetti italiani*, Milan, 1875, pp. 420-463. A large map of Italy, in 227 sections, corresponding to that of the English Ordnance Survey, is in course of publication, under the supervision of the *Istituto topografico militare* (formerly of the *Stato maggiore*); and a Government commission, which has issued a *Bollettino geologico* since 1870, is engaged in the preparation of a large geological map. See Giordano in *Atti dei Lincei*, 1872.

*ital Statistics.*—Previous to 1871 we have no census for the whole kingdom of Italy, seeing that at the previous census of 1861 the Roman territory was not yet incorporated. Approximate totals are obtainable for earlier dates by summing up the returns for the Sardinian kingdom, the Lombardo-Venetian kingdom, &c., not indeed belonging to the same year, but separated from each other by comparatively slight intervals. It is thus estimated that the growth of the population of the territory now forming the kingdom

is represented with some approach to accuracy in the following table (III.) :—

1770 .....	14,689,317	1838 .....	21,975,205
1785 .....	16,256,974	1843 .....	23,617,153
1800 .....	17,393,421	1848 .....	24,857,417
1816 .....	18,360,495	1851 .....	25,016,801
1825 .....	19,726,977		

At this last date (1861) the population of the kingdom exclusive of the province of Rome was 21,777,334. The census of 1871 showed for the whole kingdom a total of 26,801,154; and it is estimated that this had increased by 1875 to 27,482,174, and by 1879 to 28,437,091. The census of 1861 gave 10,897,236 males and 10,880,098 females, that of 1871 13,472,213 males and 13,328,892 females. At the latter date 36 per cent. of the population were married, and 6 per cent. in a state of widowhood.

The 1871 census shows that the males are in distinct excess of the females for the first fifteen years of life, that after that age the excess is on the side of the females, and becomes very strong between nineteen and twenty-one, and that between thirty-one and seventy-one the advantage is for the most part on the side of the males. (See Luigi Rerami's elaborate study in *Annali di Statistica*, series 2, vol. x., 1879.)

In spite of the fact that the great mass of the Italian population is engaged in agricultural pursuits, an unusual proportion of the inhabitants are congregated in towns. The Italian, to quote the words of Gallenga,<sup>1</sup> is no lover of the country; he dreads of all things an isolated dwelling. If he cannot live in the capital, then in a provincial city; if not, in a country town; then in a village;—only not in a country house. Landowners (what in England would be known as county families), farmers, and most of the labourers huddle together in their squalid boroughs and hamlets; and the peasants have often a journey of several miles before they reach the fields entrusted to their care,—though this tendency is indeed now less marked than formerly. At the same time the number of very large cities is comparatively small. At the census of

TABLE IV.—Communal Population of Towns in 1879.

	Com- mune.	Town.		Com- mune.	Town.
Naples.....	1879.	1871.	Treviso.....	1879.	1871.
Milan.....	452,839	415,549	Calanisotta.....	28,297	16,824
Palermo.....	261,016	199,009	Calligarisone.....	23,317	21,466
Rome.....	234,166	186,145	Chiaigione.....	26,298	22,639
Florence.....	372,959	219,608	Chioleggia.....	28,090	19,827
Genoa.....	314,572	192,443	Favina.....	27,493	27,855
Venice.....	167,714	167,093	Cortona.....	27,229	2,973
Messina.....	169,579	130,269	Castel Monferrato.....	27,117	27,104
Biologna.....	124,765	128,094	Spezia.....	26,944	10,647
Catania.....	121,856	70,307	Cetignola.....	26,824	21,739
Lecce.....	111,773	89,104	Lugo.....	26,662	8,664
Cagliari.....	98,302	80,914	Savona.....	26,659	16,030
Lugano.....	91,417	83,496	Vercelli.....	26,648	20,140
Ferrara.....	74,424	28,500	Carrara.....	26,577	7,602
Verona.....	68,819	21,286	Monza.....	26,564	15,450
Padua.....	64,151	61,607	Torino.....	26,490	24,226
Verona.....	63,502	60,049	Bitonto.....	26,442	22,993
Ravenna.....	60,877	11,935	Torre del Greco.....	26,242	16,950
Alessandria.....	59,657	28,059	Catanzaro.....	26,463	16,711
Modena.....	56,320	30,854	Lodi.....	25,451	18,537
Bari.....	55,513	49,421	Cremona.....	25,020	28,679
Pistoia.....	53,966	12,866	Lecco.....	24,620	18,460
Reggio (E.).....	50,808	19,131	Mantua.....	24,564	26,687
Fisa.....	50,374	23,906	Citta di Castello.....	24,360	6,210
Perugia.....	49,105	16,708	Como.....	24,217	19,931
Capannon.....	47,279	2,437	Cyrcago.....	24,132	18,293
Ancona.....	46,865	28,031	Chiati.....	24,122	14,321
Prato.....	42,882	12,897	Gubbio.....	24,086	5,343
Parma.....	40,725	44,915	Ragusa.....	23,970	21,494
Forli.....	39,589	15,324	Alcamo.....	23,745	20,886
Arezzo.....	39,463	11,154	Bisceglia.....	23,387	19,007
Foggia.....	39,314	34,381	Ascoli Piceno.....	22,937	11,357
Andria.....	38,414	32,676	Foligno.....	22,638	8,471
Acireale.....	38,332	20,514	Senegaglia.....	22,524	4,854
Cesena.....	38,144	7,472	Siena.....	22,450	22,905
Marsala.....	38,015	14,103	Terni.....	22,320	19,560
Reggio (C.).....	38,008	19,083	Gianicelli.....	22,027	20,908
Trapani.....	37,778	26,914	Girgenti.....	22,027	18,502
Vicenza.....	37,133	26,944	Cuneo.....	21,914	11,423
Faenza.....	36,655	14,280	Barcellona.....	21,890	12,917
Modica.....	36,276	30,032	Casina.....	21,792	1,971
Rimini.....	36,187	8,747	Cava de' Tirreni.....	21,702	5,725
Impergo.....	35,283	22,639	Avellino.....	21,665	14,399
Sassari.....	34,805	39,542	Castelvetrano.....	21,589	19,499
Cagliari.....	34,269	29,895	Partinico.....	21,447	19,828
Asti.....	33,983	17,203	Salerno.....	21,348	17,785
Brescia.....	33,344	38,906	Benevento.....	21,338	17,370
Salerno.....	31,297	19,905	Monopoli.....	21,144	18,800
Barietta.....	31,230	27,444	Sessa Aurunca.....	21,124	5,517
Novara.....	31,128	15,227	Fano.....	21,001	6,439
Piacenza.....	31,094	34,298	Aversa.....	20,883	19,734
Caserta.....	30,874	12,784	Spoletto.....	20,791	7,053
Coppato.....	29,105	5,568	Viterbo.....	20,668	16,326
Taranto.....	29,717	20,547	Taranto.....	20,600	6,829
Corato.....	29,687	26,018	Cenfa.....	20,526	5,223
Molfetta.....	29,579	26,516	Francavilla.....	20,444	16,997
Castellamare.....	28,661	18,306	Rocaneri.....	20,377	4,345
Udine.....	28,437	22,004	Bagni Sao Giuliano.....	20,385	1,028
Imola.....	28,421	9,355	Macerata.....	20,331	11,134

<sup>1</sup> Country Life in Piedmont.

<sup>2</sup> Rome at the end of 1880 had 306,400.

1871 Naples ranked first with a communal population of 448,335; and there were twenty-two other towns whose inhabitants numbered about 50,000 or upwards. With the exception of four belonging to Sicily, the greater number of these were situated in the north. Table IV. indicates the communal population of all the towns that exceed 20,000 according to the municipal bulletins for 1879. The figures differ from those of the *Movimento dello Stat. Civile*, as the latter takes into account only births and deaths and not migrations.

The official reports divide the communes into urban, those with an agglomerate population of 6000 inhabitants; mixed, those in which there is a centre of 6000, but a greater number in the country districts; and rural, comprising all the others. Of the urban there were 373 in 1875, of the mixed 39, and of the rural 7873.

The following table (V.) shows the number and distribution of the greater centres of population throughout the kingdom :—

Centres.	Piedmont.	Liguria.	Lombardy.	Veneto.	Emilia.	Umbria.	Marches.	Tuscany.	Rome.	Napolianno.	Sicily.	Sardinia.
Upwards of 100,000 inhabitants.....	1	1	1	1	...	...	...	1	1	1	1	...
From 60,000 to 100,000.....	...	...	...	1	1	...	...	1	...	...	2	...
" 40,000 " 60,000.....	...	...	...	1	1	...	...	...	...	...	...	...
" 20,000 " 40,000.....	2	...	5	2	3	...	...	1	3	...	9	8
" 12,000 " 20,000.....	3	2	3	3	1	...	...	3	2	45	26	...
" 8,000 " 12,000.....	10	6	6	4	2	...	...	3	2	46	43	1
" 6,000 " 8,000.....	7	4	6	4	2	...	...	3	9	68	34	4
Total above 6000.....	23	9	20	12	14	7	8	14	14	170	115	7

In 1877 it was found that 238 of the 8295 communes of the kingdom had no register of population, and that the aggregate population in December 1876 of the communes which were thus situated or did not keep their registers up to date was no less than 7,002,456, or more than one-fourth of the population of the country (*Annali di Stat.*, vol. v., 1879). The statistics of the growth of the population are consequently attended with a degree of uncertainty; but the following table (VI.) exhibits the general facts since the completion of the kingdom :—

	Marriages.	Births.	Still-Births.	Deaths.	Population.
1872	202,361	1,020,682	29,546	827,498	26,994,338
1873	214,966	965,188	28,351	813,973	27,165,553
1874	207,997	951,658	26,891	827,253	27,289,958
1875	230,486	1,035,377	29,830	848,161	27,482,174
1876	225,453	1,084,721	33,069	796,420	27,769,475
1877	214,972	1,029,037	31,406	757,817	28,010,695
1878	199,885	1,012,475	31,305	813,550	28,269,039
1879	213,096	1,064,153	33,825	836,682	28,437,091

During the fifteen years 1855-70 the marriages averaged 7.48 annually in every 1000 inhabitants, the births 37.1 (104 males to 100 females), and the deaths 30.4. The average number of children (births and still-births) per marriage was 4.68. There is very little difference in the percentage of the marriages in the urban and the rural communes; but in the matter of births and still more in deaths the urban communes stand higher than the rural. The following table (VII.) gives the numbers per 100 of the population :—

	Marriages.		Births.		Deaths.	
	Urban.	Rural.	Urban.	Rural.	Urban.	Rural.
1872	0.76	0.74	3.79	3.78	3.22	3.90
1873	0.78	0.60	3.65	3.62	3.22	2.89
1874	0.74	0.77	3.83	3.47	3.34	2.89
1875	0.80	0.86	3.77	3.76	3.33	2.95
1876	0.80	0.81	3.86	3.93	3.02	2.79
1877	0.77	0.77	3.89	3.66	3.07	2.70
1878	0.73	0.70	3.81	3.58	3.16	2.76
1879	0.78	0.70	3.75	3.70	3.13	2.82

Out of 412,981 women married in the years 1878 and 1879, 184 were under fifteen, 3183 were between fifteen and sixteen, 6610 between sixteen and seventeen, 12,067 between seventeen and eighteen, 20,546 between eighteen and nineteen, and 29,391 between nineteen and twenty; so that altogether 71,981 were married under twenty years of age. Of the men 27.28 per cent. were married before reaching their twenty-fifth year, and 80.99 per cent. before reaching their thirty-fifth year. Although marriages between uncle and niece and aunt and nephew are forbidden by the civil code, about 127 of this class of marriages are contracted annually under special licence.

The following tables (VIII., IX.) show the number of legitimate and illegitimate births in 1873 and 1879, as well as of those placed in the *ruota*<sup>3</sup> or exposed, and whose parentage is unknown :—

<sup>3</sup> The *ruota* or foundling-wheel still exists in 1222 of the communes being frequent in the Neapolitan provinces and Sicily, rare in upper and middle Italy. It has been abolished in 400 communes during the last twenty years. Nor has the abolition been attended with that increase of infanticide which is observed in France, the Italian law being much less rigid than the French in regard to illegitimate parentage.



Town Communes.	1878.			1879.		
	Total.	Male.	Female.	Total.	Male.	Female.
Legitimate .....	285,643	145,905	137,738	296,450	152,198	144,292
Illegitimate .....	15,259	8,070	7,189	15,803	8,330	7,473
Exposed .....	18,348	9,122	9,221	19,100	9,519	9,581
Total .....	317,245	163,097	154,148	331,353	170,047	161,506

Country Communes.	1878.			1879.		
	Total.	Male.	Female.	Total.	Male.	Female.
Legitimate .....	656,379	338,838	317,541	690,439	356,855	333,584
Illegitimate .....	29,474	15,325	14,149	32,153	16,859	15,294
Exposed .....	9,377	4,685	4,692	20,208	5,198	5,010
Total .....	695,230	358,848	336,382	732,800	378,912	353,888

It appears from these last figures (1879) that 10·57 per cent. of the children born in the towns, and 5·65 per cent. of those in the country, are either illegitimate or unacknowledged by their parents, and that, while the proportion of males to females is overhead 106 or 107 to 100, the proportion in the case of the illegitimate is 112 in the towns. The province of Rome, the Marches, Umbria, Emilia, and Sardinia are the regions in which illegitimacy most prevails,—17, 13, 12, 10, and 9 per cent. being their respective figures for 1878, while little more than 1 per cent. is shown for Campania and Apulia. It is a painful fact that in the space of ten years 305,105 children have been abandoned by their parents. The rate of infant mortality, also, speaks of ignorance and neglect: in 1877, for example, 214,093 children (*i.e.*, nearly 21 per cent.) died in the first year of existence, and other 196,844 perished before they completed their tenth year.<sup>1</sup>

In the matter of emigration proper, it is calculated that out of every 100,000 of its population 82 leave Italy annually. The corresponding number for the United Kingdom is 350, for Belgium 230, for Denmark 110,—Italy coming next. According to the *Statistica della Emigrazione Italiana all' Estero*, the total number of emigrants in the twelve years 1869–1880 is 1,407,723. Taking the figures for 1876–80 it would appear that about 37,000 Italians go every year to France, 19,000 to Austria-Hungary, 14,000 to Switzerland, 7000 to Germany, about 3000 to the other states of Europe, 20,000 to America (about a third of them to the La Plata republics), and from 2000 to 3000 to the other parts of the world. A large proportion of this body of people, however, return to their native country after a longer or shorter period of absence; and the actual loss of population by this means is reduced to about 25,000 or 30,000 per annum. The compartimenti which contribute most to the total of the permanent emigration are Piedmont, Liguria, Lombardy, and the Veneto; Emilia, Tuscany, Umbria, the Marches, Latium, Sicily, and Sardinia have only a very small share.

The proportion of women and children to the total number of emigrants is thus indicated (Table X.) :—

	Emigrants proper.			Emigrants proper and temporary.		
	Males.	Females.	Under Fourteen.	Males.	Females.	Under Fourteen.
1878	12,399	6,137	4,281	82,510	13,758	9,761
1879	28,632	12,192	7,896	100,172	19,659	13,329
1880	26,285	11,649	7,286	100,726	19,175	11,989

The greater number—55 per cent.—of the emigrants proper are connected with agricultural pursuits; 16 per cent. are artisans and operatives. Genoa is by far the most important emigration port, and next, though at a great interval, comes Naples.

According to the census of 1871 the population was grouped by occupation as follows:—no fewer than 8,738,565 were engaged in the production of raw materials, 3,287,188 in industrial operations, 199,901 in commerce, and 271,003 in transport; 765,099 were supported by their property; 145,304 were engaged in the defence of the country, and 136,929 in public administration; 148,883 were connected with religion, 25,936 with justice, 54,409 with health, 52,577 with education, 41,151 with the fine arts, and 14,145 with literature and science, while no fewer than 11,773,208 are registered as without profession or as dependent on others.

*Agriculture.*—In the wide sense of the word, Italy is emphatically an agricultural country, and the products of its agriculture are of a very varied order. If the ratio of its grain production to the number of its population, however, be compared with the same ratio in other countries, it is surpassed by Roumania, Denmark, Russia, Prussia, France, Hungary, &c., and in fact is only a little better than Switzerland.<sup>2</sup> It is calculated that about 11,545,594 acres are devoted to the cultivation of wheat, and that the annual return is about 142,402,513 bushels. The average per acre is thus very low,

only 12 bushels, while England obtains about 31 bushels per acre. Next in importance to wheat comes maize (*grainwheat*, or Turkish corn), the most recently introduced of the cereals; it occupies 4,192,083 acres, and yields 85,506,660 bushels. That the cultivation of rice is less widely distributed is the natural result of the fact that it requires about 107,000 gallons of water per annum for every acre, and that its cultivation is found in many places to be extremely prejudicial to the healthiness of the locality;<sup>3</sup> in certain favourable regions, however, it forms the predominant crop. The chief seat of this cereal is Novara, and more particularly the circondario of Verelli, which alone yields about 6,875,000 bushels of rice in a year. The total acreage is 573,925 acres, with a total production of 26,998,915 bushels. Neither barley nor rye is of great importance, the 1,148,470 acres devoted to their cultivation giving 18,417,542 bushels as an average crop. More than a fourth of the acreage, and nearly a third of the produce, belong to Sicily. Oats occupy about 984,917 acres, and the return is 19,369,000 bushels. The best crops are obtained in the provinces of Caserta, Pisa, Benevento, Milan, and Foggia. Millet (*Panicum miliaceum*), panic (*Panicum italicum*), and sorghum (*Holcus saccharatus*) are mainly employed as forage,—the first of the three, which was formerly of importance as an article of human food, having been in that regard displaced by maize. Buckwheat (the *grano Saraceno* of the popular language) is hardly grown outside of the provinces of Cuneo, Como, Belluno, and Treviso. The manufacture of macaroni and similar foodstuff is well known as a characteristic Italian industry. It is pretty extensively distributed, and is often carried on in very primitive fashion. The extent of the industry may be judged from the fact that, while the Italians themselves consume enormous quantities, they are at the same time able to export from 50,000 to 70,000 quintals of "pastes."

Beans are a very common crop—those belonging to the genera *Phascolus* and *Dolichos* being known as *fagioli*, and those of the genus *Faba* as *fave*. Of the former no fewer than thirty-five varieties were exhibited by the board of agriculture at the Paris exhibition in 1878. Those most commonly cultivated are the white haricots. In many places a crop of beans is obtained from the field just cleared of the wheat. Lentils are grown in most parts of the country,—a small sort being that most in favour. Pease hold a less important place than that assigned to them in more northern lands. The total area under beans (*fagioli*—the *fave* are not included in this estimate), pease, and lentils is calculated at 773,100 acres, and the produce at 6,664,500 bushels. Lupines are extensively cultivated both for winter forage and to serve as a manure. *Lupinus albus* is the variety most usual in Central and Northern Italy. *Lupinus varius*—which does not do so well for green fodder—is most usual in the south. *Lathyrus sativus*, a congener of the sweet pea of English gardens, is sown as food for pigs,—its use as an article of human consumption gradually diminishing as it has been recently proved that, as Hippocrates long ago asserted, it has a tendency to bring on paralysis of the limbs.

The potato is now found as a common object of cultivation in nearly every region of Italy except the provinces of Mantua, Gironi, and Trapani. For field cultivation the variety still almost universally in vogue is that introduced by the grand-dukes of Tuscany at the beginning of the 17th century. It is calculated that the total crop of potatoes may average 19,387,000 bushels. Turnips are pretty largely grown, more especially in the central districts of the peninsula, for use as winter fodder for the cattle. Many attempts have been made to introduce the cultivation of beet, but the plant does not succeed to much satisfaction.

Gardening is seldom carried on in Italy on a large or expensive scale, except in the neighbourhood of such places as Milan, Genoa, Florence, Palermo, Catania, and Naples. Some of the market-gardens in the outskirts of this last city, however, are said to bring in about £32 per acre, and to be let for £14 or £15. Forcing is seldom resorted to. Among the plants most largely cultivated in the ordinary gardens are various kinds of cabbage, lettuces, fennel, asparagus, spinach, beet, garlic and onions, gourds, melons and cucumbers, and tomatoes. The fennel is eaten both raw and cooked,—often instead of fruit after dinner. The asparagus is seldom bleached.

With the exception of rape, colza, and linseed, few of the oil seeds are grown to any considerable extent. The sun-flower is cultivated on a small scale in the Veneto, and the ground nut (*Arachis hypogaea*) in a few places in Lombardy. The annual crop of the castor-oil plant (which has become wild in Sicily and in Verona) is estimated at 6,000,000 lb of seed. Sesamum, formerly common in the Bologna and Lucca districts, is now almost confined to Sicily. Madder used to be largely cultivated in the provinces of Naples and Caserta (in the former 27,000 acres were devoted to it as late as 1863), but in Italy as elsewhere the dye plants are becoming of less importance. The collecting of saffron is also less common than it used to be. In

<sup>1</sup> E. Rasini, "I Fanciulli illegittimi e gli esposti in Italia" in *Arch. di Stat.*, 1881.  
<sup>2</sup> See *Some observations bearing on the Production of the several Countries entering into the Grain Market of the World*, Richmond, Virginia, 1877.

<sup>3</sup> A contest, for instance, between the rice-growers of the territory of Casale and the other inhabitants of the district, which was carried from court to court, and finally became the subject of a Government inquiry, was terminated by a decree (1879) forbidding the cultivation of the cereal in a large district where it was proving a remunerative investment. See *Giorn. della Soc. Ital. d'Igiene*, 1879.



southern Tuscany (at Piacenza, Montepulciano, and Siena) it was formerly an important industry; now it chiefly flourishes in the province of Aquila and other parts of the Neapolitan, and in the island of Sicily. Aniseed is abundantly grown in the Romagna and the Abruzzi; the province of Aquila produces about 800 quintals per annum. Liquorice grows wild in all the southern part of the peninsula, and in some portions of Sicily is considered a vile weed; but in certain localities, as in the province of Teramo, it is the object of regular cultivation.

The vine is cultivated throughout the length and breadth of Italy, but in not a few of the provinces its relative importance is slight. While in some of the districts of the south and the centre the vine occupies from 10 to 20 per cent. of the cultivated area, in some of the northern provinces, such as Sondrio, Belluno, Grosseto, &c., the average is only about 1 or 2 per cent. The methods of cultivation are sufficiently varied; but the planting of the vines by themselves in long rows of insignificant bushes is decidedly the exception. In Lombardy, Emilia, Romagna, Tuscany, the Marches, Umbria, the Terra di Lavoro, and other southern provinces, they are trained to trees which are either left in their natural state or subjected to pruning and pollarding. In Campania and Terra di Lavoro the vines are allowed to climb freely to the tops of the poplars such as they would do in their native woods; but the wines obtained by this system of cultivation are said to be of inferior quality. In the rest of Italy the elm and the maple are the trees mainly employed as supports. Artificial props of several kinds—wires, cane work, trellis work, &c.—are also in use in many districts, and in some the plant is simply permitted to trail along the ground. The vintage takes place, according to locality and climate, from the beginning of September to the beginning of November. Table XI. gives details for the different districts:—

	Acres.	Gallons.		Acres.	Gallons.
Piedmont .....	289,853	59,536,312	Latium .....	108,714	18,390,326
Lombardy .....	347,882	41,690,644	Adriatic pro- vinces of the south .....	660,634	77,768,472
Veneto .....	600,420	77,208,878	Mediterranean do.	604,048	80,792,688
Liguria .....	109,529	13,163,480	Sicily .....	622,502	93,420,096
Emilia .....	418,269	43,783,642	Sardinia .....	59,763	9,918,194
Marches and Umbria .....	359,204	42,181,612	Total .....	12,621,039	597,000,748
Tuscany .....	542,216	59,143,612			

Next to the cereals and the vine the most important object of cultivation in Italy is the olive. In Sicily and the provinces of Reggio, Catanzaro, Cosenza, and Lecce this tree flourishes freely and without shelter; as far north as Rome, Aquila, and Teramo it requires only the slightest protection; in the rest of the peninsula it runs the risk of damage by frost every ten years or so. The proportion of ground under olives is no less than from 20 to 36 per cent. at Porto Maurizio, and in Reggio, Lecce, Bari, Chieti, and Leghorn it averages from 10 to 19 per cent. Throughout Piedmont, Lombardy, the Veneto, and the greater part of Emilia, the tree is of little importance, though in a number of the provinces it is cultivated on a small scale. In the olive there is great variety of kinds, and the methods of cultivation differ greatly in different districts; in Bari, Chieti, and Lecce, for instance, there are regular woods of nothing but olive-trees, while in middle Italy we have olive-orchards with the interspaces occupied by crops of various kinds. The Tuscan oils from Lucca, Calci, and Buti are considered the best in the world; and those of Bari, Umbria, and western Liguria rank next. The following table (XII.) indicates more particularly the distribution of the cultivation:—

	Acres.	Gallons.		Acres.	Gallons.
Piedmont .....			Latium .....	102,959	2,108,348
Lombardy .....	11,344	138,996	Adriatic pro- vinces of the south .....	667,392	18,568,278
Veneto .....	8,737	205,062	Mediterranean do.	344,205	14,003,880
Liguria .....	209,864	7,651,868	Sicily .....	257,905	16,065,236
Emilia .....	11,598	324,654	Sardinia .....	127,458	4,642,110
Marches and Umbria .....	188,465	4,304,498	Total .....	2,224,662	74,483,002
Tuscany .....	294,735	6,270,132			

The cultivation of oranges, lemons, and their congeners (collectively designated in Italian by the term *agrumi*) is of somewhat modern date, the introduction of the *Citrus Bigaradia* being probably due to the Arabs; but it has received so great a development in certain parts of the country as to be highly characteristic. Sicily stands *facile princeps* in this respect,—the area occupied by the *agrumi* or lemon and orange orchards in the province of Palermo alone having increased from 11,525 acres in 1854 to 54,340 in 1874. Reggio, Calabria, Catanzaro, Cosenza, Lecce, Salerno, Naples, and Caserta are the continental provinces which come next after Sicily. In Sardinia the cultivation is extensive, but receives little attention. Crude lime-juice is exported from Italy to the amount of about 10,000 quintals annually, and concentrated lime-juice to the amount of from 11,000 to 17,000 quintals. Essential oils are extracted from the rind of the *agrumi*, more particularly from that of the lemon and the bergamot; the latter, however, is almost confined to the

province of Reggio Calabria, where the average production amounts to 220,000 lb.—an enormous quantity when it is remembered that 1000 bergamots are required for every lb. A perfume called *acqua nanfa*, or *lanfa*, is obtained from the distillation of the orange-flowers, and the petals are also made into a conserve at Syracuse. Of the *agrumi* in their natural state the exportation has increased from 832,410 quintals (value 24,139,890 lire) in 1873 to 1,007,585 (value 36,022,575 lire) in 1877. In Southern Italy almonds, carob-trees, and figs are cultivated on a very extensive scale. The value of the almonds exported in 1876 (a favourable year) amounted to 13,570,000 lire. Walnuts are mainly grown in Piedmont, and particularly in the province of Cuneo; hazels, on the contrary, have their greatest diffusion in the south, and particularly in the island of Sicily and the province of Avellino.<sup>2</sup> The value of the export of walnuts and hazels amounts to between 3,000,000 and 4,000,000 lire per annum. Pistachio culture is confined to the province of Caltanissetta.

The great variety in physical and social conditions which exists throughout the peninsula gives corresponding variety to the methods of agriculture. In the matter for instance of rotation of crops there is an amazing diversity—shifts of two years, three years, four years, six years, and in many cases whatever order strikes the fancy of the farmer. The fields of Tuscany for the most part bear wheat one year and maize the next, in perpetual interchanges, relieved to some extent by green crops. A similar method prevails in the Abruzzi, and in the provinces of Salerno, Benevento, and Avellino. In the plains of Lombardy a six year shift is common:—either wheat, clover, maize, rice, rice (the last year manured with lupines), or maize, wheat followed by clover, clover, clover ploughed in and rice, rice, and rice manured with lupines. The Emilian region is one where regular rotations are best observed,—a common shift being grain, maize, clover, beans and vetches, &c., grain, which has the disadvantage of the grain crops succeeding each other. In the province of Naples, Caserta, &c., the method of fallows is widely adopted, the ground often being left in this state for fifteen or twenty years; and in some parts of Sicily there is a regular interchange of fallow and crop year by year. The following scheme indicates a common Sicilian method of a type which has many varieties:—fallow, grain, grain, pasture, pasture—other two divisions of the area following the same order, but commencing respectively with the two years of grain and the two of pasture.

In the matter of implements the Italian agriculturist is far behind. The old Roman plough, for instance, as it is described by Virgil and Columella, may still be seen in use in various parts of the country; in Sardinia the plough that figures on the ancient monuments of the island might have been copied from that at work in the fields. Great improvements, however, have taken place in the more progressive regions; iron has replaced wood, and coulter and share have been increased in massiveness. But even in the Veneto the heavy plough drawn by as many it may be as six pair of oxen cuts the furrow no deeper than 9 inches. As we proceed southwards the fashion becomes more simple and antique. The spade or *ranga* is a favourite implement, and in some parts, as in Emilia for instance, it is used to deepen the furrow made by the plough. Sowing and reaping machines have been successfully introduced in the lowland regions, but a large proportion of the country is little fitted for their employment.<sup>3</sup> Thrashing machines even in the remoter districts have largely displaced the flail and the floor; and straw cutters, corn-shellers, and similar inventions have begun to make their way. Manuring even of a very ordinary kind is but little attended to in a great part of the country; though it has been a custom from time immemorial to grow a crop of lupines for the sole purpose of returning them to the soil as a stimulus.

Though Italy is so distinctively an agricultural country, and has been subject so long to regular process of cultivation, a large proportion of its arable land is still in a state of utter neglect. It is calculated that the aggregate of the more important districts ready to give abundant increase in return for the labour of reclamation amounts to 571,000 acres; and more than twice that quantity might be utilized. The most important works undertaken in this direction since the formation of the kingdom are the draining of Lago Fucino and Lago Trasimeno, and the great scheme for the improvement of the "Agro Romano" decreed by parliament on 11th December 1878.

The breed of cattle most widely distributed throughout Italy is that known as the Podolian, usually with white or grey coat and enormous horns. Of the numerous sub-varieties, the finest is said to be that of the Val di Chiana, where the animals are stall-fed all the year round; and next to this is ranked the so-called Valle Tiberina type. The wilder and ruder varieties are those which roam in vast herds over the Tuscan and Roman *maremmas*, and the corresponding districts in Apulia and other regions. In the Alpine

<sup>1</sup> The Italian lira corresponds in value to the franc. 25 lire = £1 sterling.

<sup>2</sup> The hazel has its specific name, *Corylus avellana*, from the fact here mentioned.

<sup>3</sup> A suggestive table of the proportion of mountainous and lowland country in the several provinces will be found in the *Statisti* published by the Geographical Society in 1875. It is reprinted in the *Annuario Stat.* for 1881. According to this, the mountainous area is considerably in excess of the lowland.



districts there is a stock quite distinct from the Podolian, generally called *razza montana*. These animals are much smaller in stature and more regular in form than their Podolian cousins; and they are mainly kept for dairy purposes. Another stock, with no close allies nearer than the south of France, is found in the plain of Racconigi and Carmagnola; the mouse-coloured Swiss breed occurs in the neighbourhood of Milan; the Tyrolean breed stretches south to Padua and Modena; and a red-coated breed named Reggio or Friuli, is familiar both in what were the duchies of Parma and Modena, and in the provinces of Udine and Treviso. Other less important types exist in the southern parts of the peninsula; in Sicily the so-called Modica race is of note; and in Sardinia there is a very distinct stock which seldom exceeds the weight of 700 lb. Buffaloes are kept in several districts, more particularly of Southern Italy. Their total number is estimated at 15,190.

Sheep are not reared in any considerable numbers by the agriculturists of Italy; but enormous flocks are possessed by professional sheep-farmers, who pasture them in the mountains in the summer, and bring them down to the plains in the winter. The breeds vary from region to region. At Seluzzo in Piedmont there is a stock with hanging ears, arched face, and tall stature, kept for its dairy qualities; and in the Biellese the merico breed is maintained by some of the larger proprietors. In the upper valleys of the Alps there are many local varieties, one of which at Ossola is like the Scotch blackface. Liguria is not much adapted for sheep-farming on a large scale; but a number of small flocks come down to the plain of Tuscany in the winter. With the exception of a few sub-Alpine districts near Bergamo and Brescia, the great Lombard plain is decidedly unpastoral. The Bergamo sheep is the largest breed in the country; and that of Cadore and Belluno approaches it in size. In the Venetian districts the farmers often have small stationary flocks. Throughout the Roman province, and Umbria, Apulia, the Capitanata, and the Calabria, we find in its full development a remarkable system of pastoral migration which has been in existence from the most ancient times, and which has attracted attention as much by its picturesqueness as by its industrial importance. Merino sheep have been acclimatized in the Abruzzi, the Capitanata, and the Basilicata. The total number of sheep in the kingdom is estimated at nearly 7,000,000, and that of goats at more than 1,500,000. According to returns for 1876 (the figures of which are almost certainly below the mark) the cattle amount to 3,489,125, the horses to 657,544, the asses to 498,766, the mules to 293,863, and the pigs to 1,553,582.<sup>1</sup>

The north of Italy has long been known for its great dairy districts. Parmesan cheese, otherwise called Lodigiano (from Lodi) or grana, was presented to King Louis XII. as early as 1509. In 1878 there were in the province of Parma alone one hundred and sixty-seven caselli or dairies, manufacturing about 1,830,554 gallons of milk, and manufacturing 26,091 Parmesan cheeses of aggregate weight of 927,315 lb, besides 6963 lb of the variety of Stracchino, 2318 lb of Gorgonzola, 324,062 lb of butter, and 497,442 of ricotta<sup>2</sup> (compare *Annali di Agricoltura*, No. 9). Between 1864 and 1873 the value of the cheese increased from 1'66 lire to 2'75 lire per lb. Parmesan is not confined to the province from which it derives its name; it is manufactured in all that part of Emilia which is in the neighbourhood of the Po, and in the provinces of Brescia, Bergamo, Pavia, Novara, and Alessandria. Gorgonzola, which takes its name from a town in the province, has become general throughout the whole of Lombardy, in the eastern parts of the "ancient provinces," and in the province of Cuneo. The cheese known as the caccio-cavallo, which when two or three years old is worth three or four lire the kilogramme, is produced in regions extending from 37° to 43° N. lat. Gruyère, so extensively manufactured in Switzerland and France, is also produced in Italy in the Alpine regions and in Sicily. With the exception of Parmesan, Gorgonzola, La Fontina, and Gruyère, most of the Italian cheese is consumed in the locality of its production. It is estimated that in 1879 England imported upwards of 3000 Parmesans and 5000 Gorgonzolas. The institution known as the *latteria sociale* or co-operative dairy-farm has been in use in Parma for centuries, and is a familiar arrangement in many districts. For further details on this interesting industry the reader may consult Cantoni's *L'industria del latte*, and the account of the *esposizione di caseificio*, held at Portici in 1877, in the *Annali di Agricoltura*, 1879. The extent of the butter exportation is seen from Table XXII., p. 456. France is the great market for the fresh butter; but it appears that England is rapidly becoming a customer of some importance; instead of 10 tons, as in 1875, it received 500 tons in 1879-80.

Among the various methods by which the relation of the landholder to the tiller of the soil is regulated, the more noteworthy are the mezzadria (mezzeria or metayer) system, the boaria or schiaven-

deria, the economia, and the affittanza or affittamento. This last is practically the same as the ordinary renting system in England and Scotland, the rent sometimes being paid in money (*affitto a danari*), sometimes in kind (*affitto a grano*), sometimes partly in money and partly in kind, and the periods varying from one year to leases of six or nine years. In the typical mezzadria the owner receives frequently one half of the produce of the soil, and the mezzadro or farmer the other; but of course there are many minor modifications in the terms of the contract.<sup>3</sup> The live-stock is usually the property of the mezzadro, who pays a fixed rent for the use of the pasturage. By the *terzeria* system, on the other hand, the animals and plant are the property of the landholder, or two-thirds his and one-third the tenant's. Under the *schiauderia* or boaria system, the boario (so called from his care of the cattle) receives such a quantity of the produce of the soil or of money as pays for his labour, and the landholder remains practically his own farmer. The live stock of course is the landlord's property, but the boario has a right to certain perquisites connected with this department of his labour. Economia is the name given to a system by which "the holder of the land, whether landlord or tenant, pays certain families who perform under his direction, with his capital and at his risk, the various labours of cultivation." The peculiar conditions of certain parts of the country produce peculiar arrangements: the Roman Campagna, for example, which could not be permanently inhabited owing to the malaria, used to be cultivated in the following fashion. Companies of peasants from the Abruzzi, the Marches, &c., under the direction of chiefs or "corporals," performed the work of sowing the fields in the autumn, and returned in June to gather in the harvest,—the tenants of the farms usually making considerable profits from the undertaking. For further details on this subject the reader may consult the *Reports respecting the Tenure of Land in the several Countries of Europe* (1869-1870) presented to the English parliament in 1870, and the *Monografie agricole*, published by Professor Luigi Bodio, whose name has so frequently to be mentioned with honour in connexion with the statistics of his country. Table XIII., which is collected from the reports on the *Contratti agrari* in

TABLE XIII.—Varieties of Land Tenure.

Province.	Circondario.	Tenure.
Turin.....	Turin and Pinerolo	Mezzadria, <i>terzeria</i> , affittanza, boaria.
	Ivrea	Mezzadria.
	Aosta	Affittanza.
Cuneo.....	Cuneo	Mezzadria (for smaller holdings), affittanza (for larger).
Alessandria.....	Asti	Peasant-proprietorship, boaria, mezzadria.
	Acqui	Peasant-proprietorship.
	Casale	Affittanza, mezzadria (rare), boaria.
	Biella	Colonia, mezzadria.
	Vercelli	Affittanza (almost exclusively).
Porto Maurizio.....	Taggia (territory)	Affittanza.
	Albenga	Affittanza (for fields), mezzadria (for olive grounds).
	Savona	Mezzadria, affittanza.
Como.....	Monticello (comune)	Affittanza (to kind).
Milan.....	Abbiategrosso (Cuggiono)	Colonia.
Pavia.....	Lomellina	Affittanza (mezzadria has almost disappeared).
	Bobbio	Mezzadria (few cases of affittanza).
Sondrio.....	Sondrio	Peasant-proprietorship, mezzadria.
Bergamo.....	Bergamo	Mezzadria.
Brescia.....	Bieno	Peasant-proprietorship, affittanza, mezzadria.
	Radiano (territory).	Quartirolo.
	Verolanova	Affittanza.
Cremona, Mantua		Affittanza.
Verona.....	Legnago	Affittanza.
Vicenza.....	Valdagno	Peasant-proprietorship (two-thirds of area), mezzadria, affittanza.
	Thiene	Peasant-proprietorship, affittanza.
	Marostica	Affittanza (almost no peasant-proprietorship).
	Arzignano	Affittanza.
Venice.....	Vicenza	Affittanza (mezzadria disappearing), affittanza (to kind).
Reggio.....		Affittanza (for large farms), mezzadria (for lesser).
Modena.....		Mezzadria and boaria.
Ferrara.....		Boaria.
Bologna, Ravenna, Perugia, Ancona.....		Mezzadria.
Aquila.....		Affittanza (four, six, or eight years).
Caserta, Avellino, Basilicata		Affittanza.

<sup>1</sup> Caruso, for instance, in his work on *Sistemi d'amministrazione*, describes a variety to use at Gallico, in Reggio Calabria. In order to establish new *agrumeti*, or orange orchards, advantage is taken of the following arrangements. The peasant undertakes to dig the holes, to furnish and place the cuttings, and to watch and take care of the plants up to the seventh year. The *maglioli*, of interpaces between the rows, he cultivates as a garden, and pays for this a rent of about 229 lire per hectare. The produce of the orchard is divided equally between contadino and landlord, and at the end of the seventh year, the value of the garden being estimated, the former receives a third of the amount, and the landlord remains in full possession of the rest.

<sup>2</sup> Most of the facts in this survey of Italian agriculture are borrowed from *L'Italia agraria e forestale*, prepared by the Italian Board of Agriculture for the Paris Exhibition, 1878.

<sup>3</sup> Ricotta means "recooked." It is the residue of cream separated from butter-milk by boiling.

the last work, indicates very strikingly the great irregularity of the distribution of the various forms of contracts. The rent system would appear to be gaining ground, and the mezzadria and similar methods to be losing in importance.<sup>1</sup>

**Manufactures.**—Though Italy is pre-eminently an agricultural country, its manufacturing industries are of considerable importance, and some of them have a long and varied history. Of chief note is the silk trade,—though it has suffered greatly from the silkworm disease which broke out in 1854. According to De Vecchi (*Arch. di Stat.*, 1876) the total annual production of raw silk in Italy previously amounted to 7,612,000 lb; in 1865 it was reduced

to 3,876,400 lb, but it has since considerably recovered its ground. The average, indeed, for the ten years 1868–1877 is given by the same authority as 5,753,880 lb, and according to the report of Luigi Maccia to the Milan chamber of commerce in 1881 the cocoon harvest amounted in 1878 to 81,843,740 lb, in 1879 to 41,648,200 lb, and in 1880 to 79,546,280 lb, which would represent in round numbers 5,500,000 lb of raw silk for the first year, 2,798,000 lb for the second, and 5,345,000 for the third.

The following table (XIV.) from the same report indicates, with approximate accuracy, the contributions of the different regions to these totals:—

	Quantity in lb.			Value in lire.		
	1878.	1879.	1880.	1878.	1879.	1880.
Piedmont.....	16,905,768	9,142,359	12,209,784	31,640,711	20,674,341	22,247,904
Liguria.....	...	121,000	193,600	...	297,000	398,000
Lombardy.....	31,022,110	13,015,649	33,177,509	51,647,796	31,732,077	50,247,949
Veneto.....	17,533,998	7,832,974	19,146,399	30,426,995	19,834,645	30,276,210
Emilia.....	4,054,207	3,235,513	4,045,973	8,001,707	8,581,781	7,488,170
Tuscany.....	4,040,333	1,343,236	2,881,507	9,736,425	3,819,036	5,540,179
Marches, Umbria, and Com- arca.....	2,299,079	2,578,769	3,371,471	5,026,410	6,995,717	5,914,461
Neapolitan Provinces.....	5,270,991	3,110,305	4,139,625	6,748,745	5,802,564	5,990,060
Sardinia.....	...	...	66,000	...	...	10,000
Sicily.....	717,200	368,500	374,000	1,180,120	703,500	510,000
<b>Total.....</b>	<b>81,843,746</b>	<b>41,648,307</b>	<b>79,546,471</b>	<b>144,108,909</b>	<b>98,440,611</b>	<b>128,620,933</b>

As a silk-producing country in fact Italy ranks second only to China, and leaves all its other competitors far behind. The culture is carried on in at least 5300 communes, and in 1877 it was calculated that 4339 men, 81,165 women, and 25,373 children were employed in the unwinding of the cocoons—an operation which was formerly effected for the most part by the growers themselves, but has now passed into the hands of those who can bring better appliances and more modern methods to bear. The district in which the unwinding is most extensively carried on is Lombardy, and it is there too that improvements in the process are most widely adopted; while in the Veneto, for example, there are 10,031 of the old-fashioned ovens to 4698 of the modern steam apparatuses, in Lombardy the latter number 29,576 and the former only 9305. If we turn to what is more distinctively the manufacture of the silk, we find the pre-eminence of Lombardy more strongly emphasized. The position it occupies is evident from the following table (XV.) :—

Next in importance to the silk industry stands the cotton manufacture. During the American war the cultivation of cotton in Italy received a remarkable but temporary stimulus. In 1864 it occupied about 227,645 acres, and the produce amounted to 622,896 quintals, but the corresponding figures for 1873 were only 55,422 and 180,230 quintals. In 1877 Italy had only about 850,000 cotton spindles, or rather more than Belgium; and these consumed about 264,000 quintals of the fibre. Liguria and Piedmont contain the greatest number of spinning mills. In the number of its cotton looms, however, Lombardy stands highest, and Liguria, Piedmont, and Campania follow. The total number for the country is stated at more than 13,000. Of the cotton goods the great proportion consists in the coarser fabrics,—muslins, tulles, &c., being obtained almost exclusively from abroad. The average importation of cotton yarn for the ten years 1870–1879 amounted to 109,000 quintals, and that of cotton fabrics during the same period to 116,000 quintals.

As has been already seen, Italy is a great wool-growing country; and while it exports about 1,760,000 lb of the native produce, it imports, mainly from South America, a quantity varying from 10,882,680 lb in 1870 to 18,983,600 lb in 1879. The following table (XVI.) indicates the extent of the industry, which, unlike that of cotton, has a long and in parts brilliant history in the country :—

	Employed in silk-throwing.				Spindles.		
	Men.	Women.	Child- dren.	Total.	Active.	Inactive.	Total.
Piedmont.....	1,270	7,183	2,414	10,867	273,332	83,706	357,038
Liguria.....	57	371	121	549	8,139	4,510	12,650
Lombardy.....	4,016	21,814	33,051	58,881	1,484,592	153,659	1,637,961
Veneto.....	172	1,865	415	5,452	42,581	11,486	54,067
Emilia.....	23	477	110	610	3,070	352	3,422
Umbria.....	...	...	...	...	...	...	...
Marches.....	39	184	77	300	4,000	2,264	6,264
Tuscany.....	12	46	...	58	2,460	...	2,460
Rompe.....	...	2	2	4	12	...	12
Abruzzi and Molise.....	...	...	...	...	...	...	...
Campania.....	32	359	100	591	5,839	2,461	8,299
Calabria.....	3	10	20	33	150	...	150
Sicily.....	19	13	5	37	818	23	841
<b>Total.....</b>	<b>5,618</b>	<b>32,364</b>	<b>36,345</b>	<b>74,332</b>	<b>1,824,707</b>	<b>258,461</b>	<b>2,083,168</b>

The raw material for these silk-throwing factories is partly obtained from abroad, in spite of the large home supply already indicated; for a considerable proportion of this—though much less than was formerly the case—is exported for manufacture at Lyons and elsewhere. According to Signor Fuzier in his Paris exhibition report, 44,000,000 lb of silk from other European countries, and 176,000,000 lb from Asia, are worked up by the Italian spinners. The special department of *cascami* employs about 27,000 spindles in Jesi, Novara, Meina, and Zuniglio.

In silk-weaving Italy stands comparatively low. Signor Ellena, general director of the customs,<sup>2</sup> estimates the number of looms at from 10,000 to 12,000, of which only 665 were power-looms—very meagre totals in comparison with those even of the Swiss canton of Zurich, which numbers about 1000 power-looms and 40,000 hand-looms. Lombardy (especially the town of Como) is again the principal seat of the industry, Campania ranking second, and Piedmont third.

	No. of Factories.								
	Horse-Power.		Workers in Spinning.			Workers in Weaving.			
	Steam.	Hydraulic.	Men.	Women.	Children.	Men.	Women.	Children.	
Piedmont.....	152	74	2103	2138	1455	794	2700	1702	548
Liguria.....	10	150	87	115	179	58	182	128	16
Lombardy.....	65	12	283	257	139	115	358	438	48
Veneto.....	51	588	1600	989	376	557	1949	356	187
Emilia.....	8	24	83	40	36	18	70	19	12
Umbria.....	10	10	244	145	12	33	219	169	62
Marches.....	1	...	...	109	...	...	20	...	...
Tuscany.....	1	42	629	742	17	333	723	159	467
Rome.....	34	15	89	237	15	70	141	170	93
Abruzzi and Molise.....	2	...	...	14	...	25	1	14	...
Campania.....	91	161	816	652	429	514	650	362	368
Calabria.....	9	...	...	23	8	12	...	10	3
Sardinia.....	2	4	...	...	...	...	2	21	...
<b>Total.....</b>	<b>540</b>	<b>1060</b>	<b>6184</b>	<b>5351</b>	<b>2696</b>	<b>2520</b>	<b>6985</b>	<b>4201</b>	<b>1804</b>

More than 8000 hands are further employed in the shoddy trade. With few exceptions, the Italian factories receive the wool in its raw state from the grower, and perform in succession all the various operations of washing, scouring, carding, dyeing, weaving, and dressing. They manage to supply a large part of the home demand, and also export a small quantity of goods.

The flax and hemp industries have been prosecuted in Italy for centuries; but a large proportion of the manufacture is still carried on by hand-loom weavers working in their own houses—to the number probably of more than 68,000. The following table (XVII.) indicates the distribution of the factories :—

<sup>1</sup> On the mezzadria system, see also A. Rabbano, *Sulla mezzadria nei suoi rapporti*, 1874.  
<sup>2</sup> A large proportion of the facts mentioned in this section on the manufactures are borrowed from V. Ellena's paper in *Arch. di Stat.*, 1880.



	No. of Factories	Horse-Power.		Spinners.			Weavers.		
		Steam.	Water.	Men.	Women.	Children.	Men.	Women.	Children.
Piedmont .....	71	10	18	45	61	20	694	329	51
Liguria .....	5	25	64	14	36	19	215	87	39
Lombardy .....	56	114	1781	765	1240	958	789	941	314
Veneto .....	18	8	90	48	248	53	142	206	48
Emilia .....	22	120	505	202	234	47	395	694	91
Umbria .....	4	...	...	...	20	...	112	54	...
Marches .....	1	...	...	...	...	...	73	...	...
Tuscany .....	22	...	...	...	...	...	263	481	230
Abruzzi and Molise	1	...	...	...	...	...	73	...	...
Campania .....	21	226	190	431	726	130	183	565	211
Apulia .....	2	...	...	...	...	...	6	12	...
Sicily .....	17	...	...	...	...	...	104	34	45
Sardinia .....	1	...	...	...	...	...	3	...	...
Total .....	241	503	2451	1525	2565	1227	3053	3994	1029

The manufacture of jute is quite insignificant:—two weaving factories in Lombardy and Liguria, and spinning mills at Crema, Poirino, and Grugliasco. It is estimated that about 8400 hands are employed in the making of ropes and cordage; and of the produce in this department there is a very considerable export, varying in the ten years 1870–79 from a minimum of 20,797 quintals in 1870 to a maximum of 36,908 in 1873. The factories that produce mixed fabrics are 210 in number, and upwards of 5000 hands are employed in them.

The extent to which weaving is carried on in the simple domestic fashion has been indicated in connexion with the linen trade; it also maintains its ground in several of the other departments, and the popular prejudice—it prejudice it be—in favour of the firm-wrought fabrics that are thus produced will long keep the clack of the solitary loom familiar to the inhabitants of many a town and village. It is said that there are at least 230,000 of them at work throughout the country.

The making of felt hats, which gives employment to nearly 5000 hands, is mainly carried on in Piedmont, and particularly in the circondario of Biella and at Intra. The produce is for the most part of a coarse quality, but finds a market not only in Italy but also in France, Austria and Switzerland, the Argentine Confederation, and Tunis. The trade in straw hats is rapidly growing in importance: while in 1867 the number exported was only 7661, it rose in 1877 to 4,526,000.

Owing to the abundance of the raw material, Italy has long been successful in the manufacture of paper from linen rags according to the old-fashioned processes; and the development of the more modern methods has been fostered by the ready availability of water power, though on the other hand the outlays for chemicals, machinery, and fuel are serious drawbacks. The supply of home-made paper is far in excess of the demand, and there is a corresponding excess of export over import, more especially in blotting and packing papers. The imported paper is almost exclusively of the finer qualities. According to Signor Avondo, the annual quantity of rags obtained in Italy is 88,000,000 lb. There was formerly a great export of rags to America in the shape of picking material for marble-blocks.

In the manufacture of leather and skins Italy has long been successfully engaged; and though the industry has now to compete with the new enterprise of India and America, the annual production is valued at £4,000,000. The staple article is shoe leather; in the finer departments—such as kid skins—foreign competition is too strong for the full development of the native industry. It is estimated that there are upwards of 1300 works in the country, employing more than 10,000 hands.

A private company, established in 1868 under the name of Regia Cointeressata, secured for fifteen years the exclusive privilege of manufacturing and selling tobacco in continental Italy and Sardinia, on condition of paying to the state an annual rent and a certain proportion of the gains after the rent was deducted. In the period 1869–1870 the rent was to be 66,894,811 lire, in the second period (1871–74) 72,293,032, in the third (1875–1878) 79,484,891, and for the fourth (1879–1884) 93,000,000. Up to 1875 the Government share in the ultimate profit was fixed at 40 per cent., and from 1875 at 50 per cent. The results of this arrangement have not been equal to the anticipations formed in regard to them. In 1877, however, the Regia extended its control to the island of Sicily.

According to the regulation of 1879 the cultivation of tobacco for exportation is permitted in any part of the country on payment of a licence, while the cultivation for the inland monopoly is restricted to certain regions annually determined, and within these regions no cultivation for export can be carried on. The rules are of a very rigid description. The provinces in which the monopoly cultivation has usually been located are Vicenza, Ancona, Perugia, Rome, Benevento, Salerno, Lecce, Sassari, Catania, and Messina. The total area of the ground so occupied was only 4500 hectares (11,120 acres)

in 1877; to satisfy the national demand from internal sources would require from 18,000 to 20,000 hectares (44,480 to 49,420 acres). On an average it is calculated that every inhabitant of Italy uses about 5 oz. of snuff, 10 oz. of cut tobacco, and 9½ oz. of cigars annually—the total expense being 5-518 lire or 4s. 6d. per head.

The manufacture of oils is among the most flourishing of the minor industries, and the demand which it makes on foreign countries for supplies of raw material is rapidly increasing. The amount of oil-seeds imported in 1870 was 27,000 quintals, in 1879 211,400 quintals. And at the same time the consumption of the oils within the country exceeds the quantity manufactured, so that the excess of the import over the export of oil in 1879, for instance, was 135,660 quintals. There are 437 oil works in the kingdom (198 in Lombardy), and they employ nearly 2000 hands. Rape, linseed, ricinus, ground-nuts, and sesamum, are all made use of, especially the first and last. Soap works are said to number as many as 537 (151 in Sicily alone, and 87 in Apulia), and to engage 1770 men, 135 women, and 179 children; and the exportation of soap, which was less than a third of the importation in 1870, has increased till the excess is strongly in its favour. The 10 stearine-candle factories employ upwards of 500 hands, and form the nucleus of what may be a large industry.

The sugar manufacture is of limited extent. During the Austrian rule it was carried on in Lombardy and Venice with the support of the state; but the political changes proved fatal to its existence, and it was not till 1872 that the first sugar refinery of the kingdom of Italy was established at Sampierdarena. This, however, proved a flourishing business, and supplied about one quarter of the entire consumption of Italy, which was estimated at 176,000,000 lb; in 1876 it employed 500 hands, and carried on distilling operations. Beet-root sugar has been manufactured since 1869 at Anagni, where the factory was formerly protected and privileged by the Papal Government; and there are other factories at Riiti, Cesa (in the Val di Chiana), &c. (English Parliamentary Papers:—*Reports on Sugar Industries in Foreign Countries*, 1876.)

In 1877 there were 9583 distilleries in the country, and 370 manufactories of aerated waters. The brewing establishments amounted to 145, and manufactured 2,488,838 gallons. Both barley and hops are largely imported from abroad, the hops mainly from Austria and Germany. In the following table (XVIII.) the first column indicates the quantity of beer annually imported, the second the quantity annually made in the country:—

	Gallons.	Gallons.		Gallons.	Gallons.
1871	577,150	1,667,292	1875	811,908	2,634,082
1872	660,286	1,915,251	1876	922,768	2,729,892
1873	752,378	2,077,416	1877	889,108	2,488,838
1874	916,564	2,380,970	1878	905,102	...

The iron manufacture has increased in importance in Italy during the last decade. In 1872 the production of wrought iron and steel was estimated at 48,909 tons; in 1877 it was 73,000 tons, and 12,000 hands were employed in the works. Liguria has the credit of nearly half of the total amount. The works at Savona, Voltri, and Pra, at Vobarno near Lake Garda, and at Val d'Elsa deserve mention. Some of these have furnaces of the Siemens type.

Considerable progress has also been made in the manufacture of machinery; the number of men employed in this department (the Government factories being omitted) increased from less than 12,000 in 1872 to 15,000 in 1877. The Italian mechanics do not seek to compete with foreigners in the production of large steam engines and hydraulic motors, but devote their attention to the minor kinds of machinery for wool and cotton factories, dye works, railways, &c.

The principal chemical works are those of sulphuric acid at Milan, Turin, Naples, and Genoa, of hydrochloric acid at Milan, of nitric acid at Milan and Avigliana near Turin, of carbon disulphide at Bari, Pisa, San Giuliano, and of quinine at Milan and Genoa. This last manufacture, though it only dates from 1870, exceeds that of any other European country. The quinine is partly exported to Russia. Tartaric acid, as a matter of course in a wine-growing country, is produced in abundance. Glue-making is also a widely diffused industry, and the manufacture of artificial manures, which was carried on in 32 factories in 1878, is increasing in importance. India-rubber works exist at Milan.

In the various ceramic arts Italy was at one time unrivalled, but the ancient tradition has long lost its primeval impulse; and even where the industry remains the art has for the most part perished. The works at Vinovo, which had fame in the 18th century, came to an untimely end in 1820; those of Castelli (in Abruzzo Ult. I.) were supplanted by Charles III.'s establishment at Capo-

<sup>1</sup> A curious instance of the tenacity of popular art tradition in the country is furnished by the fact that some of the long-lost processes of Etruscan pottery have been found in use at St Angelo in Vado, a remote corner of the Marches. See Aless. Castellani in *Amer. Ass. for Adv. of Science*, 1878

Limonte, 1750 which after producing articles of surprising execution was closed before the end of the century. The first place now belongs to the Della Doccia works at Florence. Founded in 1735 by the marquis Carlo Ginori, they maintained a reputation of the very highest kind down to about 1860; but since then they have not kept pace with their younger rivals in other lands. They still, however, are commercially successful, producing to the value of 700,000 or 800,000 lire, and employing 600 workers. Other cities where the ceramic industries keep their ground are Pesaro, Gubbio, Faenza (whose name long ago became the distinctive term for the finer kind of potter's work in France, *faïence*), Savona and Albissola, Turin, Mondovì, Cuneo, Castellamonte (more than 30 establishments, 500 workmen), Milan, Brescia, Sassuolo, Imola, Rimini, Perugia, Castelli, &c. It is estimated that the total production of the finer wares amounts on the average to 10,000,000 lire per annum. The ruder branches of the art—the making of tiles and common wares—is pretty generally diffused. (For further details see Giuseppe Corona's *Report on the French Exhibition of 1878*, Class XX., "Ceramica," Rome, 1880.)

The jeweller's art as a matter of course received large encouragement in a country which had so many independent courts; but nowhere has it attained a fuller development than at Rome. A vast variety of trinkets—in coral, glass, lava, &c.—is exported from Italy, or carried away by the annual host of tourists. In 1877, for example, while 388 quintals of raw coral were imported, 563 quintals of wrought coral were exported, and in the same year no less than 22,891 quintals of imitation jewellery in glass. The copying of the paintings of the old masters is becoming an art industry of no small mercantile importance in some of the larger cities.<sup>1</sup>

The production of mosaics is an art industry still carried on with much success in Italy, which indeed ranks exceedingly high in the department. The great works of the Vatican are especially famous (more than 17,000 distinct tints are employed in their productions), and there are many other establishments in Rome. The Florentine mosaics are perhaps better known abroad; they are composed of larger pieces than the Roman. Those of the Venetian artists are remarkable for the boldness of their colouring.

The small amount of capital accumulated in the country, the heavy expenses involved in the importation of much of the machinery necessary for the larger industries, the comparative inexperience of the mass of the operatives, and the difficulty consequent upon these and other circumstances of competing with foreign manufacturers who can produce at a cheaper rate—these are some of the reasons of the backward state of Italian manufacturing industry. The inexperience of the operatives—due to lack of experience and of education—is the more noteworthy because it counteracts the advantage to be derived from the cheapness of labour. The principle of the division of labour has comparatively limited application. From the same factory, for instance, may be obtained ploughshares and theodolites.

**Fisheries.**—As the coast-line of Italy extends to about 3937 miles (of which 1045 belong to the islands), the prosecution of the fisheries in the neighbouring seas is carried on from a great many points. The following table (XIX.) gives the principal statistics of date 1879, for the various "compartimenti" or districts into which the coast is usually divided:—

Districts.	Total number of Boats.		For Fisheries proper.		For Coral.	
	No.	Men.	No.	Men.	No.	Men.
Genoa .....	62	439	62	439	...	...
Spezia .....	113	536	113	536	...	...
Leghorn .....	40	253	37	262	3	21
Porto Ferraro .....	56	303	56	303	...	...
Gaeta .....	5	24	5	24	...	...
Naples .....	493	4,114	55	321	378	3,793
Bari .....	123	1,137	123	1,137	...	...
Rimini .....	4	25	4	25	...	...
Venice .....	290	1,301	290	1,301	...	...
Cagliari .....	16	84	1	5	15	79
La Maddalena .....	6	54	2	9	4	45
Porto Empedocle .....	5	37	...	...	5	37
Trapani .....	63	699	37	195	5	33
	1,221	9,038	785	4,559	410	4,003

To complete the total for Trapani, it is necessary to add 26 boats with 471 hands, which are employed in the sponge fishery off Tunis. For Italy, as for the other Mediterranean nations, the tunny fishing is of considerable moment. The more important stations are those in Sicily, Sardinia, and Elba. Apart from local consumption the annual value of the Sardinian fishery is estimated at 4,000,000 lire, and that of Sicily at about half as much.

The anchovy and sardine fisheries are carried on by Italian boats, not only on the Ligurian and Tuscan coasts, but on those of France, Spain, Barbary, Dalmatia, and Istria. Among the stations which take an active share in this department are Sestri and Riva,

Cecina and Castiglione, Porto Ercole, Porto Longone in Elba, Ancona, and Chioggia. The success of the fishermen is now seldom so great as it was before 1863; and 2 lire per day is the most that can be gained in the best months at the better stations. The annual value of the sardines brought to Terracina is stated at 6300 lire, and that of the anchovies at 7000; and the corresponding figures for Porto d'Anzio and Palermo are respectively 93,000 and 32,000 lire, 200,000 and 400,000. Civita Vecchia has a total for the two kinds of 15,000 lire.

Sword-fish (*Xiphias gladius*) are not only constantly caught in the nets of the tunny-fishers, but from time immemorial have been the object of special pursuit, the weapon mainly used against them being a species of harpoon or *draffineria*. As many as fifty fish may be caught in a single day off the coast of Sicily, and twenty off the coasts of Calabria. Each fish weighs on an average from 220 to 440 lb; and the quantity captured in the season in the two districts indicated may amount to 308,000 lb.

Coral is obtained in various parts of the Italian waters, more especially in the neighbourhood of the island of Elba and the Gulf of Naples, and the Italian coral fishers extend their voyages to the African coast and the islands of Cape Verd. In 1869 it was stated that upwards of 400 vessels, of 2712 tons total burden, were employed in the department, by far the greater proportion of them belonging to Torre del Greco. The statistics given in Table XIX. show but little change. The hardships endured by the more adventurous fishers are extremely severe, and the gain is comparatively slight. (Compare Green's *Stray Studies*, 1879, for a description of the coral fishers of Capri.)

Of special importance are the lagoon fisheries of Orbetello, of the Mare Piccolo of Taranto, the Lago Verzimino or Salpi, and the Lago di Varano, and more particularly of Comacchio. Eels, soles, mullets, and various other kinds of fish are there obtained in enormous quantities.<sup>2</sup>

**Condition of the Lower Classes.**—Though mitigated to some degree by the mildness of the climate and the cheapness of certain articles of food, pauperism in its most painful forms is a widespread evil in Italy. At Venice, out of a total population of 130,000, 36,000 are regular recipients of official charity. The slums of Naples are foul and overcrowded as the slums of London. Nor is the destitution confined to the cities. The condition of the agricultural labourers is in many cases deplorable. In the districts of Como, Milan, Pavia, and Lodi, the food of the contadino, according to F. Cardani and F. Massara, consists of maize bread, badly cooked, heavy and rancid, and thin soup composed of rice or "pasta" of inferior quality and vegetables often old and spoiled. In Southern Italy, says Villari, the peasants live in miserable houses, with a sack of straw for their bed, and black bread for their sole sustenance. Maize is the general food stuff in the northern and central provinces, but begins to be rarer in Tuscany and Rome; it is again widely diffused in the upper provinces of Naples; but in Calabria and Apulia it forms the principal nutriment of scarcely a fourth of the communes, and in Sicily it disappears almost completely. In Piedmont, Lombardy, and the Veneto it is used mainly in the form of polenta, but also in the form of bread, and in the Neapolitano in the form of a finer kind of polenta. Lombardy, the Veneto, Emilia, and the Marches are the regions where wheat bread is least employed by the peasants. Barley is mainly consumed in Apulia and Calabria, rye in Sicily and Lombardy. In certain communes of the Marches and the Abruzzi acorns constitute the ordinary diet of the poor. Wheat and pasta are most extensively employed by the people in Liguria, Sicily, and the upper Neapolitan provinces. Animal food holds but little place in the dietary of the poor; and even in the house of the well-to-do peasant butcher meat appears but seldom. According to Dr Rascri, who has investigated the point by means of the customs returns and similar statistics, Sardinia is the region where animal food is most largely employed, and Sicily that where it is least.

Wine is naturally the prevailing drink throughout the country; but the extent of the consumption varies greatly from region to region, the average in the Roman province, Umbria, and Sardinia much exceeding that in the provinces of Naples and in Sicily. The use of alcohol is greatest in the Lombardo-Venetian cities; and it is there only that beer is of importance as a beverage. Cases of accidental death and of insanity attributable to the misuse of stimulants are much more frequent in the north than in the south or centre, and in both respects Liguria has an unenviable pre-eminence.

An idea of the extent to which even the peasantry are oppressed by penury may be obtained from the investigations made by the Government into the spread of the terrible disease known as the *pellagra*. First clearly described as an Italian disease by Frapolli in 1771, the *pellagra* has within the present century gradually become more common and severe. In 1839 it was estimated that the number of *pellagra* patients was 20,252 in the "compartimento" of Lombardy, and in 1856 it had increased to 38,777. According to

<sup>2</sup> See Friedländer, *La Pesca nelle lagune di Comacchio*, 1872, and compare the article *Comacchio*. For full details on the whole question of the Italian fisheries see *Espos. intern. di Pesca in Berlino*, 1880, *Sezione Italiana*, Florence, 1880.

<sup>1</sup> See, for example, the notice of Venice in *British Consular Reports*, 1879.



returns for 1879 it appears that there were 97,855 patients in the kingdom—by far the greater proportion being in Lombardy, the Veneto, and Emilia, where they actually formed 31.70, 30.52, and 23.66 per thousand of the agricultural population. The disease has many forms, and not unfrequently ends in insanity. And to what are its ravages to be ascribed? To insufficient and unwholesome food, and more particularly to the use of maize in a state unfit for human consumption.<sup>1</sup> When such a state of matters exists among the rural population of some of the most prosperous regions of the country, there is little wonder that the number of conscripts who have to be rejected on the score of physical incapacity is a large one—20 per cent. in Lombardy and 18 per cent. in the Veneto in 1878.<sup>2</sup>

The interest of the Italians is gradually being aroused in the sanitary condition of their cities and towns. Many of the provincial capitals and cathedral cities are portentously filthy. Drainage and sewage works, however, are becoming matters of concern to a number of the more important communes; and such cities more especially as Naples and Catania are bestowing much attention on the subject. A society of public health, *Società Italiana d'igiene*, was established at Milan, one of the most advanced of Italian cities, in 1877; it publishes a valuable journal.<sup>3</sup> In Milan, Bologna, Genoa, Rome, and some other cities attention is being paid to the question of cheap houses for the working classes. On the general health conditions of Italy compare the elaborate study by Giuseppe Sorman, *Geografia nosologica dell'Italia*, Rome, 1881.

*Commerce.*—The extent of its coast and the number and excellence of its ports and harbours, the relation which it holds to the other countries of the Mediterranean seaboard, and the railway communication which it now possesses with the Transalpine lands combine to give Italy an important place as a trading-country,—a place which would have been more important if all departments of activity had not fallen into so sad a state during the long period of its political decadence. In a country with a population comparatively so dense, and with so large a number of considerable cities as we have seen Italy to possess, it is evident on the face of it that the internal trade must amount to no small aggregate; but the simple agricultural life which is led by a large proportion of the inhabitants, the capacity which many regions possess of satisfying the demands of local consumption, limited at once in volume and variety, and the lack in many cases of free and frequent means of communication tend to restrain the scope and complexity of this interchange. That both the internal

trade and the foreign commerce of Italy are in process of rapid development it is impossible to doubt. Of the former movement some idea may be obtained from the railway statistics, which, however, owing to the incompleteness of the system, furnish a less accurate representation of the facts than similar statistics in the case of older nations. That the foreign commerce is on the increase is shown by the following statement of the exports, imports, and transit trade from 1871 to 1880 (Table XX.) :—

	Imports.	Exports.	Transit Trade.
	lire.	lire.	lire.
1871	963,698,441	1,085,459,667	128,359,140
1872	1,186,811,328	1,187,201,119	121,172,403
1873	1,279,044,840	1,162,159,012	174,551,904
1874	1,276,208,782	988,456,532	215,277,535
1875	1,201,363,663	1,033,681,104	76,228,104
1876	1,313,841,068	1,216,844,813	102,547,875
1877	1,151,222,784	973,162,785	92,182,012
1878	1,070,637,230	1,045,301,362	80,950,387
1879	1,261,651,423	1,106,919,278	96,988,244
1880	1,225,644,170	1,132,289,192	...

"In 1873," says Dr A. Bruniati, the author of "Le grandi vie del commercio internazionale," published in *Studi sulla Geografia dell'Italia* (Florence, 1875), issued by the Italian Geographical Society, "Italy, with a total of 2,400,000,000 lire, was eighth in the list of commercial nations of Europe, being exceeded by Great Britain (17,000,000,000 lire), Germany, France, Russia, Belgium, Austria, and Holland, though Belgium is less than one-tenth of Italy in area, and has not more than one-fifth of its population, and Holland is not much bigger than Belgium, and has one-third less of a population." In 1877 it was still eighth on the list, and some of the smaller countries had made greater advance. The Italian trade with France and with Switzerland has enormously increased since the unification of the kingdom; and the same may be said of the trade with Russia. Since the opening of the Suez Canal advantage has been taken of the new opportunities of trade with the East.

Table XXI. gives the geographical distribution of the Italian trade during 1869, 1873, and 1879. In 1880 the whole value of the imports (excluding transit trade) was 1,225,644,170 lire, and the corresponding number for the exports 1,132,289,192.

The Italian exports, as a natural consequence of the undeveloped state of the industries and the preponderance of its agriculture, mainly consist of such products as wine, oil, fruit, cattle, &c.

TABLE XXI.—Exports and Imports, 1869, 1873, and 1879.

Exports from Italy.				Imports to Italy.			
Countries.	1869.	1873.	1879.	Countries.	1869.	1873.	1879.
	lire.	lire.	lire.		lire.	lire.	lire.
America, except United States...	26,162,000	57,414,000	31,308,000	America, except United States...	24,637,000	52,658,000	28,652,000
Austria.....	105,933,000	221,840,000	206,778,000	Austria.....	156,619,000	229,271,000	194,250,000
Belgium.....	5,545,000	4,866,000	6,616,000	Belgium.....	10,090,000	14,457,000	14,195,000
Egypt.....	5,559,000	19,827,000	10,265,000	Egypt.....	3,702,000	18,137,000	31,551,000
France and Algeria.....	166,979,000	447,649,000	473,067,000	France and Algeria.....	264,424,000	386,862,000	301,098,000
Germany.....	3,621,000	12,815,000	23,800,000	Germany.....	10,107,000	23,710,000	45,618,000
Greece.....	3,809,000	17,481,000	14,164,000	Greece.....	7,712,000	6,222,000	10,154,000
England.....	116,995,000	110,553,000	96,513,000	England.....	232,269,000	802,306,000	256,696,000
Holland.....	13,096,000	15,077,000	5,635,000	Holland.....	35,277,000	44,889,000	11,442,000
Russia.....	58,232,000	16,637,000	24,702,000	Russia.....	30,448,000	48,502,000	102,249,000
Spain and Portugal.....	5,120,000	7,949,000	11,090,000	Spain and Portugal.....	3,850,000	9,535,000	10,510,000
United States.....	29,223,000	29,024,000	61,396,000	United States.....	37,392,000	49,726,000	71,829,000
Sweden, Norway, and Denmark.....	3,916,000	1,578,000	2,345,000	Sweden, Norway, and Denmark.....	4,607,000	2,112,000	5,186,000
Switzerland.....	121,771,000	159,677,000	107,409,000	Switzerland.....	49,442,000	40,977,000	32,436,000
Tunis and Tripoli.....	5,079,000	3,806,000	4,094,000	Tunis and Tripoli.....	8,941,000	18,666,000	4,502,000
Turkey.....	12,424,000	6,733,000	17,937,000	Turkey.....	47,604,000	43,623,000	66,076,000
British Possessions in Asia.....	...	...	6,833,000	British Possessions in Asia.....	...	...	52,645,000

TABLE XXII.—Exports of Sundry Important Articles, 1865-79.

Years.	Wine in Barrels.	Olive Oil.	Butter, Fresh and Salt.	Fresh Meat and Fowls.	Eggs.	Gloves.	Marble.	Suphur.	Cattle, Horses, and Asses.	Sheep, Goats, and Pigs.
1865	5,819,274	657,132	6,603	4,481	13,844	3,488	5,671,779	1,453,160	31,019	56,881
1866	7,663,139	647,980	4,874	15,225	32,583	3,580	7,405,313	1,795,445	55,079	159,227
1867	6,291,472	877,911	5,293	26,093	49,148	5,296	6,819,573	3,925,928	123,800	199,262
1868	5,635,832	629,808	7,138	29,476	41,461	8,835	7,005,187	1,764,256	85,264	214,290
1869	6,011,016	776,180	6,071	30,659	65,695	10,941	28,657,408	1,705,304	62,987	162,904
1870	4,947,514	678,347	9,076	26,574	48,768	8,931	10,237,029	1,743,180	76,237	169,047
1871	5,010,852	841,106	10,039	25,349	46,130	13,451	9,573,133	1,724,170	164,382	359,314
1872	12,805,068	673,593	11,505	21,007	45,064	19,715	10,111,905	1,826,550	127,212	284,863
1873	6,386,440	602,605	9,998	25,258	54,770	9,545	11,999,943	2,030,510	77,263	213,778
1874	5,908,604	476,832	14,036	27,424	87,239	6,977	13,190,327	1,745,620	49,792	182,455
1875	7,748,290	826,673	12,433	30,681	90,710	14,985	13,480,335	2,156,750	60,146	286,246
1876	10,960,664	812,897	16,082	39,530	247,070	26,263	14,883,673	3,032,800	96,388	313,376
1877	7,803,708	669,304	21,677	44,267	210,340	25,214	12,341,436	2,101,177	159,732	355,490
1878	11,551,234	514,127	23,703	44,792	228,022	26,270	15,215,430	2,183,254	170,141	464,431
1879	23,388,568	886,555	29,067	56,324	231,857	15,886	20,696,428	2,422,706	129,780	397,727

<sup>1</sup> See *Annali di Agricoltura*, No. 18, "La Pellagra in Italia, 1879" (Rome, 1880). The statistics of the hospital of St Clements at Venice, for example, are sufficiently startling, as indicating the extent of what the Italians graphically call *il delirio della miseria*. The first column gives the number of the lunatics received in each year, the second column those whose mental condition is the result of the pellagra, that is, of poverty.

1874 ..... 558 158 | 1876 ..... 666 175 | 1878 ..... 859 294  
 1875 ..... 595 153 | 1877 ..... 802 215 | 1879 ..... 924 337

The total number of pellagra lunatics in Italy, which in 1874 was 945, had increased by 1877 to 1348.

<sup>2</sup> Compare Larciccy, *L'Italie agricole*, Lond., 1880.  
<sup>3</sup> Compare the accounts given by Gallenga in his *Italy Revisited*.

Table XXII. shows the great increase that has taken place in the amounts exported in the case of several important articles.

Among the chief imports is coal, the demand for which, in 1865 only 456,039 tons,<sup>1</sup> has gradually increased to 1,523,676 in 1879, and to 1,737,746 in 1880—more than threefold. The importation of mineral oils has in the same space increased in value from 83,984 quintals to 586,323. Whereas the excess of importation over exportation in the case of raw wool was 4,249,135 kilogrammes in 1865, in 1880 it was 5,574,700 kilogrammes; in the case of cotton the corresponding figures were 3,745,009 for 1865 and 29,158,500 for 1880.

According to the *Relazione sui Servizi idraulici pel biennio 1877-78* (Rome, 1880), the number of ports in the kingdom is 307, of which 10 are of the first class, 20 of the second, 27 of the third, and 250 of the fourth. Those belonging to the first category are Ancona, Cagliari, Naples, Palermo, Venice, Genoa, Leghorn, Messina, Civita Vecchia, and Brindisi; and those of the second include Portofino, Porto Venere, Porto Ferrajo, Porto Ercole, Marciano, Porto d'Anzio, Gaeta, Ponza, Baià, Manfredonia, Tortoli, Milazzo, Cotrone, Syracuse, Longoue, Nisida. In extent of commerce *Genoa is facile princeps*, as is evident from the following table (XXIII.) of tonnage, according to the official *Movimento della Navigazione* (Rome, 1880):—

	Foreign Trade.		Coasting Trade.	
	1861.	1879.	1861.	1879.
Genoa.....	968,648	2,078,973	967,916	1,490,192
Leghorn.....	980,357	459,884	692,862	1,891,490
Messina.....	401,097	572,254	708,494	1,683,896
Naples.....	730,145	693,762	873,780	2,042,889
Palermo.....	288,101	607,640	341,183	1,379,683
Venice.....	660,047	878,335	78,760	400,865

Of the foreign nations that are engaged in the shipping trade of the Italian ports Great Britain has by far the most important share (7669 vessels, of 5,950,279 tons burden); next comes France (4256 vessels, 2,061,973 tons); third, but at an enormous distance, is Austria, and fourth Greece. It is calculated that in the vessels, native and foreign, that visited the Italian ports in 1879, no less than 1,748,717 men were engaged as seamen.

The Government undertakes the engineering works necessary for the improvement and maintenance of the harbours of the first three classes, and it further subsidizes the communes which have to maintain the harbours of the fourth class. In 1878 there were 60 light-houses on the Italian coast, of which 16 are of the first class, exclusive of the international light at Cape Spartivento. The whole cost of harbour and lighthouse maintenance is thus indicated (in lire) for 1877 and 1878 (Table XXIV.):—

	1877.	1878.
Works executed.....	5,786,050	7,409,090
Sums placed in balance.....	16,945,522	20,431,168
Sums paid to next year.....	5,714,769	8,824,311
Sums carried to next year.....	11,159,866	11,992,179
Sums funded.....	71,185	4,676

The Italian seaboard is officially divided into 23 maritime districts (*compartimenti*):—Porto Maurizio (from Ventimiglia to Allassio), Savona (onwards to Arenzano), Genoa (to Rapallo), Spezia (to Avenza), Leghorn (to Graticciare), Porto Ferrajo (island of Elba), Civita Vecchia (from Graticciare to Torre Gregoriana), Gaeta (to Lago di Patria), Naples (to Torre del Greco), Castellamare di Stabia (to Sapri), Pizzo (to Bagnara), Taranto (from Melito to Fasano), Bari (to Viesti), Ancona (to mouth of Cesano), Rimini (to Po di Goro), Venice (to the Austrian boundary), Cagliari (from Oristano to Terranova Pausania), La Maddalena (to Oristano), Messina (continental Italy from Bagnara to Melito, the Lipari Islands, and Sicily from the river Pollina to Alcantara), Catania (to Pachino), Porto Empedocle (to river Belici), Trapani (to Castellamare),

TABLE XXV.—Sailing Merchant Vessels, 1879.

	No. of Sailing Ships.		Tons.		
	No. of Sailing Ships.	Tons.	No. of Sailing Ships.	Tons.	
Porto Maurizio.....	90	5,355	Bari delle Puglie.....	441	10,454
Savona.....	153	48,082	Ancona.....	148	7,569
Genoa.....	1,180	477,773	Rimini.....	217	5,192
Spezia.....	449	63,657	Venice.....	623	30,768
Leghorn.....	494	29,418	Cagliari.....	62	3,363
Porto Ferrajo.....	272	18,149	La Maddalena.....	19	420
Civita Vecchia.....	27	2,216	Messina.....	424	15,129
Gaeta.....	162	13,701	Catania.....	269	14,134
Naples.....	1,108	68,585	Porto Empedocle.....	189	8,236
Castellamare.....	527	86,372	Trapani.....	443	12,661
Pizzo.....	109	1,588	Palermo.....	244	14,647
Taranto.....	35	896			
			Total.....	7,910	922,506

<sup>1</sup> 1 ton (tonnellata) = 2200 lb.,—40 lb. less than the English ton.

Palermo (to river Pollina). Thus 15 of the districts are continental and 8 insular.

Table XXV. gives the sailing vessels in the mercantile marine in 1879, the last year for which statistics are available.

The marine showed a total strength of 167,282 men,—8 being captains of the class technically called "superior," 4122 captains of "long course," and 2504 captains of the higher coasting class.

Of the 7910 vessels none exceeded 1500 tons burden, 2 were more than 1200, and 18 others more than 1000. The steamers belonging to the country at the close of 1879 were 351 in number (aggregate burden 72,666 tons), of which 70 were Genoese, 11 Neapolitan, and 51 Palermitan. Of the total, 128 were screw-steamers and 23 paddle-steamers. Boats adapted for fishing were registered at the same date as 15,411, of which no fewer than 1953 belonged to the Naples district, and 1399 to that of Messina. Ship-building was carried on in 50 ship yards in 1879; and they produced 269 vessels, with a total burden of 21,213 tons.

*Shipbuilding.*—The district which showed the greatest activity in shipbuilding and produced the greatest number of large vessels was that of Genoa. This industry continued to increase in importance in Italy from the foundation of the kingdom till 1869 (683 vessels, 96,010 tons); in the next three years there was a decline; by 1875 the figures of 1869 were again almost reached, but since then there has been a very notable decrease. The number of workmen engaged in 1879 was 14,179, of whom 182 were ship-builders of the first and 70 of the second class.

*Railways.*—The first railway opened in Italy was a line of 26 kilometres, constructed in 1840, between Naples and Castellamare. By 1842 there were 54 kilometres in existence; by 1845, 157; by 1848, 360; by 1858, 1707; by 1868, 5079; and by 1879, 8340. The system is considered as consisting of the following sections (Table XXVI.):—

	Length.	Cost of Construction.		Average per kilo.
		lire.	lire	lire.
1. Railways formerly worked by the Company of Upper Italy (Alta Italia).....	3,472	1,032,317,000	125,532,000	359,481
Lines purchased by convention of Basel, of which the state is co-proprietor	2,389	689,145,000	...	...
Liguro-Tuscan lines, &c.	1,983	343,172,000	...	...
2. Railways worked by the Company of the Roman Lines.....	1,561	479,237,000	36,576,000	231,574
3. Railways worked by the Company of the Southern Lines.....	1,439	396,400,000	36,318,000	250,767
Lines belonging to the company.....	1,148	314,537,000	22,600,000	293,847
Calabro-Sicilian lines (state property).....	229	57,836,000	1,721,000	262,073
4. Sardinian railways.....	278	29,959,200	3,699,000	...
5. Miscellaneous.....				
Total.....	8,230	2,292,486,200	226,446,900	308,730

Thus the total cost may be stated at £100,800,000. At the end of 1879 the rolling stock consisted of 1365 locomotives, 4301 carriages, and 23,483 waggons. The total expenditure of the railways for the year 1879 was 101,088,901 lire, and the total receipts 164,672,340.

Except in the northern part of the country the Italian railway system is still far from complete. With the French system it is connected by the coast-line from Genoa to Nice, and by the line from Turin to Geneva, which passes through the Mont Cenis tunnel. With the Austrian system there is connexion by the line which runs up the valley of the Adige from Verona to Botzen and by the lines which cross the eastern frontiers at Pontebba and Cormons respectively. From Milan to Piacenza, from Piacenza to Bologna, from Bologna to Ancona, and from Ancona to Brindisi, there is free route from the north right along the eastern coast; but the lines on the western coast take the traveller no farther south than a little beyond Salerno, and to reach Reggio from Naples involves a tremendous circuit. By the law of July 29, 1879, a great number of new lines received parliamentary sanction, the effect of which will be to complete the western coast-line, to increase the number of routes from the western to the eastern seaboard, and to furnish railway communication to numerous cities and districts which are now without it.

*Roads and Canals.*—It was found that on 31st December 1877 there existed in the kingdom 5151 miles of national roads, 15,596 of provincial roads, and 48,295 of communal roads—all very unequally distributed throughout the country. The navigable canals have an aggregate length of about 663 miles, and the navigable portions of the rivers an aggregate length of 1100.

*Postal and Telegraphic System.*—The rate of development attained by the postal system is shown by the following figures. From 1862 to 1879 (both inclusive) the number of offices has increased from 2220 to 3272, the number of letters from 71,502,779 per annum to 143,587,709, the yearly expenditure from 21,740,226 lire to





also over dioceses administered by suffragan bishops. Their position is indicated in the following table (XXXII.):—

Metropolitans.	Suffragans.
Acerenza-Matera	Angiano-Tursi, Potenza, Tricarico, Venosa.
Barl.	Conversano, Iuvo-Bionto.
Benevento	S. Agata de' Goti, Alise, Ariano, Ascoli-Cerignola, Avellino, Bojano, Bovino, Larino, Lucera, S. Severo, Teleso (Cerro), Termoli.
Bologna	Faenza, Imola.
Brindisi	Ostuni.
Cagliari	Galluri-Nuoro, Iglesias, Ugliastru.
Capua	Caiazzo, Calvi-Teano, Caserta, Isernia-Venafro, Sessa.
Chieti	Vasto.
Cosenza	S. Angelo de' Lombardi-Bisaccia, Campagna, Lacedonia, Muro Lucano.
Fermo	Macerata-Tolentino, Montalto, Ripatransone, S. Severino.
Florence	Borgo S. Sepolcro, Colle di Val d'Elsa, Fiesole, S. Miniato, Medigliana, Pistoia-Prato.
Genoa	Albenga, Bobbio, Brugnato, Luni-Sarzana, Sarona-Noli, Tortona, Ventimiglia.
Lanciano	Ortona.
Manfredonia	Vicini.
Messina	Lipari, Nicosia, Patti.
Milan	Beigamo, Brescia, Como, Crema, Cremona, Lodi, Mantua, Pavia.
Modena	Carpi, Guastalla, Massa-Carrara, Reggio.
Monreale	Caltanissetta, Girgenti.
Naples	Aversa, Ischia, Nola, Pozzuoli.
Ostia	Alce-Terralba.
Otranto	Gallipoli, Lecce, Ugento.
Palermo	Cefalù, Mazza, Trapani.
Pisa	Leghorn, Pescia, Pontremoli, Volterra.
Ravenna	Bertinoro, Cervia, Cesena, Comacchio, Forlì, Rimini, Sarsina.
Reggio Calabria	Bozza, Cassano, Cutaranzo, Cotrone, Gerace, Nicastro, Oppido, Nicotera-Tropea, Squillace.
Sassari	Acerca, Cagnano-Vallo, Diana, Marsico-Novo (Potenza), Saccà dei Fugani, Nuvo, Policastro.
Sassaro	Alghero, Ampurias (Castel Sardo) Tempio, Bisarcia. Bosa, S. Saverino.
Siena	Chiusi-Pienza, Grosseto, Massa Maritima, Sovana (Soana)-Pitigliano.
Syracuse	Caltagirone, Nola, Piazza.
Sorrento	Castellamare.
Taranto	Castellaneta, Oria.
Trani-Nazareth-Barletta	Andria, Bisceglie.
Turin	Acqui, Alba, Aosta, Asti, Cuneo, Fossano, Ivrea, Mondovì, Pinerolo, Saluzzo, Susa.
Urbino	S. Angelo in Vada-Urbina, Cagli-Pergola, Fossombrone, Montefeltro, Pesaro, Sinigaglia.
Venice	Adria, Belluno-Feltre, Ceneda (Vittorio), Chioggia, Concordia-Portogruaro, Padua, Treviso, Verona, Vicenza.
Vercelli	Alessandria della Paglia, Biella, Casale, Novara, Vigevano.

Eleven archbishops and sixty-three bishops are independent of all metropolitan supervision, and hold directly of the Holy See. The archbishops are those of Amalfi, Aquila, Camerino, Catania, Cosenza, Ferrara, Gaeta, Lucca, Rossano, Spoleto, and Udine, and the bishops those of Acireale, Acquafredda, Alatri, Amelia, Anagni, Ancona-Umana, Aquino-Sora-Pontecorvo, Arezzo, Ascoli, Assisi, Aversa, Bagnorea, Borgo San Donnino, Cava-Sarno, Città di Castello, Città della Pieve, Civitella-Castellana-Orte-Gallese, Corneto-Civita Vecchia, Cortona, Fabriano-Matelica, Fano, Ferentino, Foggia, Foligno, Gravina-Montepeloso, Gubbio, Jesi, Luni-Sarzana, S. Marco-Visignano, Marsi (Pescina), Melfi-Rapolla, Mileto, Molitetta-Terlizzi-Giovenazzo, Monopoli, Montalcino, Montefascone, Montepulciano, Nardo, Narni, Nocera in Umbria, Norcia, Orvieto, Osimo-Cingoli, Parma, Penne-Atri, Perugia, Piacenza, Poggio Mirteto, Recanati-Loretto, Rieti, Segni, Sutri-Nepi, Teramo, Terni, Terracina-Piperno-Sezze, Tivoli, Todi, Treia (Camerino), Trivento, Troia, Valva-Sulmona, Veroli, Viterbo-Toscanello.

There are 24,980 parishes in the kingdom, and the parish priest has a considerable influence in the country districts, though since 1866 he can no longer act as a state official. About 800,000 lire are spent annually by the Fondo pel Culto in augmentation of the parochial stipends. The parishes vary greatly both in size and population, some having as many as 14,000 inhabitants, and others less than 100. The priest in the country has a glebe or *padere* which he cultivates like any of the lesser landholders of his district; and he is thus interested in the state of the markets, the character of the harvest, and the general condition of affairs.

As in every diocese there is a seminary or diocesan school, the number of such institutions exceeds that of the royal, provincial, and communal lycæms (*licei*) and gymnasiums (*ginnasi*). In so far as they concern themselves with secular education, they are subject to the supervision of the minister of instruction. At the time of the inspection of 1877-78 they were found to have 17,478 pupils, of whom only 3547 were studying theology.

The only Protestant denomination with a true historical position in Italy is that of the Waldensians, which has taken advantage of the religious liberty of the new kingdom to come down from the mountain fastnesses. Besides the sixteen churches (with 11,958 members in 1879) which it possessed at the time of its recognition by law in the kingdom of Sardinia in 1848, it numbers thirty-nine churches and thirty-two mission stations scattered throughout the country as far south as Sicily; and it maintains between twenty and thirty elementary schools. The "Free Italian Church," founded in 1870 by twenty churches which declared themselves independent of

the Waldensian organization, consisted in 1879 of thirty-six churches and thirty-five stations; and since 1876 it has a theological college in Rome. In a number of the larger cities of Northern and Central Italy there are considerable congregations of the "Free Christian Church," a community or "brotherhood" which believes that stated ministers and church statistics are both un-Christian. The Wesleyan Methodist Church, having carried on evangelizing operations in Italy since 1861, has forty-three churches and stations with about 1300 communicants, and in its elementary schools 776 scholars. Of less extent are the more modern attainments of the American Episcopal Methodists, the American Baptists, and the English Baptists. Several orphanages, refuges, and schools of special purpose owe their existence to Protestant benevolence. Compare Giorgio Curcio, "Programma per una statistica dei culti in Italia," in *Annali di Stat.*, 1880.

*Religious Foundations.*—As far back as 1855 an Act was passed in the Sardinian states for the disestablishment of all houses of the religious orders not engaged in preaching, teaching, or the care of the sick, of all chapters of collegiate churches not having a cure of souls or existing in towns of less than 20,000 inhabitants, and of all private benefices for which no service was paid by the holders. The property and money thus obtained were used to form an ecclesiastical fund (*Cassa Ecclesiastica*) distinct from the finances of the state. This Act resulted in the suppression of 274 monasteries with 3733 friars, of 61 nunneries with 1756 nuns, and of 2722 chapters and benefices. In 1860 and 1861 the royal commissioners (even before the constitution of the new kingdom of Italy had been formally declared) issued decrees by which there were abolished—(1) in Umbria, 197 monasteries and 102 convents with 1809 male and 2393 female associates, and 836 chapters or benefices; (2) in the Marches, 292 monasteries and 127 convents with 2950 male and 2728 female associates; (3) in the Neapolitan provinces, 747 monasteries and 275 convents with 8787 male and 7493 female associates. There were thus disestablished in the space of seven or eight years 2075 houses of the regular clergy occupied by 31,649 persons; and the confiscated property yielded a revenue of 9,957,457 lire, or £398,298. And at the same time there had been suppressed 11,889 chapters and benefices of the secular clergy, which yielded an annual income of 4,978,728 lire, or £199,140. The value of the capital thus potentially freed from the dead hand was estimated at £12,000,000; though hitherto the ecclesiastical possessions in Lombardy, Emilia, Tuscany, and Sicily had been left untouched. As yet the Cassa Ecclesiastica had no right to dispose of the property thus entrusted to it; but in 1862 an Act was passed by which it transferred all its real property (*beni stabili* or *immobili*) to the national domain, and was credited with a corresponding amount by the exchequer. The property could now be disposed of like the other property of the domain; and except in Sicily, where the system of emphyteusis was adopted, the church lands began to be sold by auction. In order to encourage the poorer classes of the people to become landholders, it was decided that the lots offered for sale should be small, and that the purchaser should be allowed to pay by five or ten yearly instalments. By a new Act in 1866 the process of secularization was extended to the whole kingdom. All the members of the suppressed communities received full exercise of all the ordinary political and civil rights of laymen; and annuities were granted to all those who had taken permanent religious vows prior to 18th January 1864. To priests and choristers, for example, of the proprietary or endowed orders were assigned 600 lire per annum if they were upwards of sixty years of age, 400 if upwards of 40, and 360 if younger. The Cassa Ecclesiastica was abolished, and in its stead was instituted a *Fondo pel Culto*, or public worship fund, attached to the department of grace and justice, and administered by a director and a council consisting of three senators, three deputies, and three nominees of the king. From the general confiscation were exempted the buildings actually used for public worship, as episcopal residences or seminaries, &c., or which had been appropriated to the use of schools, poorhouses, hospitals, &c., by the communes and provinces in keeping with the acts of 1861 and 1864; as well as the buildings, appurtenances, and movable property of the abbey of Monte Casino, Della Cava dei Tirreni, San Martino della Scala, Monreale, Certosa near Pavia, and other establishments of the same kind of importance as architectural or historical monuments. An annuity equal to the ascertained revenue of the suppressed institutions was placed to the credit of the fund in the Government 5 per cent. consols. A fourth of this sum was to be handed over to the communes to be employed on works of beneficence or education as soon as a surplus was obtained from that part of the annuity assigned for the payment of monastic pensions; and in Sicily, indeed, 209 communes entered on their privileges as soon as the patrimony was liquidated. Another Act following on August 15, 1867, decreed the suppression of certain foundations which had escaped the action of previous measures, put an extraordinary tax of 30 per cent. on the whole of the patrimony of the church, and granted the Government the right of issuing 5 per cent. bonds sufficient to bring into the treasury 40,000,000 lire, which were to be accepted at their nominal value as purchase



money for the alienated property. The result of the whole legislation from 1855 to 1867 was the abrogation of nearly 50,000 ecclesiastical foundations which were rendering almost no service to the country beyond that of supporting an idle population of more than 60,000 souls. The following figures (Table XXXIII.) summarize the chief facts of the suppression:—

	No. of Religious Houses suppressed.		No. of Individuals pensioned.		No. of Foundations of Secular Clergy suppressed.	No. of Ecclesiastics deprived.
	For Males.	For Females.	Males.	Females.		
By law of 1856.....	1,322	585	10,658	8,286	...	...
By law of 1867.....	...	...	...	...	34,349	23,873
By law of 1873 for province of Rome.....	15	57	1,826	1,943	...	...
By preceding laws.....	1,510	565	17,279	14,570	11,880	9,600
Total.....	3,037	1,597	29,803	23,999	46,227	33,478

The total of the real property taken over by the domain up to 31st December 1877 may be estimated as yielding an aggregate revenue of 30,969,465 lire or £1,238,778 and possessing a capital value of 839,776,076 lire or £33,910,430. Of the latter sum 530,649,932 lire represent the property disposed of for the benefit of the state, 75,542,813 the property granted in emphyteusis, &c., 8,098,294 the property handed over to Government for administrative purposes, 125,191,797 the property transferred to lawful claimants, and 100,293,200 the property not yet alienated. The Fondo pel Culto derives its income from four different sources:—(1) as already indicated, from the public funds; (2) from the buildings still occupied by the ex-monks, &c., and other property not transferred to the domain; (3) from rents, ground-annuities, livelli, tithes, and other annual dues; (4) from contributions exacted from the revenues of ecclesiastical foundations still maintained. The third source is especially valuable, yielding in 1876, for example, 13,984,000 lire, and being capable of considerable augmentation under judicious management. The total expenditure of the fund during the ten years from the institution of the same to the close of 1876 amounted to 278,309,592 lire or £11,135,983, distributed as follows (Table XXXIV.):—

	Lire.	Per cent. of total.
1. Pensions to clergy, regular and secular.....	179,969,287	61.41
2. Patrimonial burdens.....	17,764,290	6.38
3. Taxes.....	23,918,912	10.74
4. Expenses of administration.....	9,158,028	3.29
5. Expenses of contracts and lawsuits.....	3,774,923	1.36
6. Other miscellaneous expenses.....	1,322,868	0.48
7. Restoration and maintenance of churches, &c.....	3,224,807	1.15
8. Assigned to communes.....	4,907,972	1.75
9. Paid to the state for expenses incurred for public worship.....	28,782,955	9.61
10. Cost of re-employment of recovered capital.....	10,621,546	3.82
Total.....	278,309,592	100

The heaviest of these items is one that is gradually diminishing, and will finally become extinct, by the dying out of the pensioners. On the 31st of December 1876 the deficit of the fund was 48,312,686 lire or £1,932,507,—650,180 lire having been the deficit taken over from the Cassa Ecclesiastica. By 1879 the debt was reduced to 1,688,719 lire.

Hitherto only a passing allusion has been made to the legislation relating to the Roman territory acquired after the passing of the Acts above indicated. In the province as distinguished from the

city the only thing requisite was to make the existing measures applicable, but in the case of the city and the suburban districts special enactments had to be provided. According to the census of 1871 there were in the city and province of Rome 474 monastic establishments (311 for monks, 163 for nuns), occupied by 4326 monks and 3825 nuns, and possessing a gross revenue of 4,780,891 lire. Of these, 126 monasteries and 90 convents were situated in the city, 51 monasteries and 22 convents in the "suburbicariates." The action of the law of June 19th 1873 has left untouched 23 of the monasteries and 49 of the convents, which had either the character of private institutions, or were supported by foreign funds. In the city alone 2977 individuals became recipients of pensions from the fund to the aggregate value of 1,319,832 lire.

Table XXXV. furnishes details regarding the suppression and modification of ecclesiastical foundations.

For further information, see G. C. Bertozzi, "Notizie storiche e statistiche sul riordinamento dell'asse ecclesiastico nel regno d'Italia," in *Annali di Stat.*, 1879; and the summary of the same by Bellini in the *Archivio di Stat.*, 1880.

**Education.**—In the matter of education the kingdom of Italy at the time of its formation might almost be described as a desert, broken every here and there by an oasis of matchless fertility and luxuriance. The learning of the learned was high, and the ignorance of the ignorant profound. As late as the census of 1861 it was found that in a population of 21,777,331 there were no less than 16,999,701 "analphabets," or persons absolutely destitute of instruction, absolutely unable to read. Of children between five and twelve as many as 82 per cent. were in this condition; of those between twelve and nineteen 71 per cent. And, as was natural, the ignorance was greater in the female sex than in the male: while 59 per cent. of the men married in 1866 were obliged to make their mark, 78 per cent. of the women were in like case. In certain parts of the country matters were even worse. M. Natoli found, e.g., that in the Basilicata the illiterate class comprised 912 out of every 1000 inhabitants. It was thus no light task that presented itself to the department of education; and the progress that has been attained does honour to its activity: in 1879 only 48 per cent. of the bridegrooms and 70 per cent. of the brides were unable to sign their names.

The administration of the education department is not so strictly centralized as it is in France. The minister of public instruction is assisted by a permanent council of fourteen ordinary and seven extraordinary members nominated by the king and chosen from the upper ranks of the educational profession. And this council has no mere nominal existence; it meets regularly thrice a week, though it often contains men of European celebrity. Five of its members, selected by the king, constitute a fine arts commission. Another general council—the *Proveditorato Centrale*—established in 1867, has special control of secondary and primary instruction. In each of the sixty-nine provinces there is a *consiglio scolastico* or school board, under the presidency of the prefect, which has the right of supervision in regard to the sanitary and moral state of the provincial schools, private as well as public. By the law of 1859 (known as the Casati Act) every commune of 4000 inhabitants is bound to maintain a primary school; but as a matter of fact some of the communes are too small and poor to have a school of their own, and are permitted to send their children to the schools of neighbouring communes. Elementary instruction is gratuitous, and by the law of 15th July 1877 the compulsory principle was brought into operation as far as the condition of the communes allows—or, in other words, in all communes of less than 5000 inhabitants provided with one teacher for every 1000, in all communes of from 1000 to 12,000 inhabitants provided with a teacher for every 1200, and in all the larger communes with one for every 1500. According to the report published

TABLE XXXV.

	Religious Corporations suppressed.			Other Foundations suppressed.			Ecclesiastical Foundations preserved and subjected to conversion of real property.		
	No. of Corporations.	Income of Real Property.	Income of Movable Property.	No. of Foundations.	Income of Real Property.	Income of Movable Property.	No. of Foundations.	Income of Real Property.	Income of Movable Property.
Piedmont.....	58	lire 253,719	101,061	2,877	lire 574,073	lire 476,290	3,165	lire 1,788,069	787,890
Liguria.....	39	39,943	74,288	1,472	168,926	123,584	1,221	234,317	142,013
Sardinia.....	9	50,117	14,811	1,472	232,919	136,398	511	423,694	203,267
Marches.....	6	13,456	8,289	43	1,978	7,136	611	577,485	133,614
Abruzzi and Molise.....	13	68,471	18,310	161	33,776	34,070	389	868,282	298,062
Campania.....	3	6,620	7,136	749	247,433	294,643	818	408,733	219,591
Apulia.....	120	415,155	340,279	871	1,624,029	598,693	665	1,722,408	554,875
Basilicata.....	15	60,002	21,332	589	963,913	254,943	624	1,882,568	350,048
Calabria.....	2	5,159	441	184	466,334	229,546	80	416,035	191,577
Sicily.....	1,053	20,125	441	595	225,240	514,098	417	798,157	140,234
Lombardy.....	33	3,319,841	4,906,672	7,443	953,579	367,242	536	680,554	1,122,896
Tuscany.....	268	189,003	31,440	4,766	614,098	1,728,003	483	1,844,581	2,083,153
Emilia.....	201	1,186,561	787,203	6,545	1,467,614	555,287	1,184	717,091	826,283
Veneto.....	79	489,125	595,427	5,485	1,592,266	249,522	2,419	1,647,395	563,168
Lazio.....	254	611,795	711,550	1,114	218,204	188,290	480	946,518	1,302,210
Total.....	2,179	6,861,898	7,700,628	34,852	8,847,946	7,767,139	16,121	15,259,924	9,183,683

in 1878 by the minister of public instruction on the effects of the law, Northern Italy was in the most favourable condition, having a much greater proportion of communes than either Central or Southern Italy. While in the north only 383,916 inhabitants—scattered in little groups through the mountainous districts—were unable to make use of the existing means of instruction, in Central Italy this was found to be the case with 1,230,599 (out of a total population of 6½ millions); and matters were still worse in the south. In the central regions 498 of the 1235 communes were unable to enforce the law through lack of the legal number of teachers, and in the southern provinces it would have been requisite to increase the teaching staff by 1536. The following statistics indicate the extent of the organization for primary instruction in 1879:—

(1) *Asylums for children* (infant schools)<sup>2</sup>—pupils, 183,809 (92,905 boys, 90,904 girls); teachers, 3752. (2) *Elementary schools*: public 35,171 (890,080 boys, 708,227 girls); private 6476 (53,479 boys, 80,416 girls). (3) *Evening Classes for adults*: 11,161 for men, 472 for women; pupils—439,624 males, 16,063 females. (4) *Sunday schools* (*scuole festive*): 592 for men, 5979 for women; pupils—5977 males, 21,194 females.

Most of the institutions known as *asili infantili*, or infant asylums, are after the Ajortti method—*forse*, says an Italian critic, *un poco troppo scuola e troppo poco asilo*; but a certain number are conducted on Froebel's kindergarten system, which was introduced among the Italians by the baroness Marienheltz-Bulow and George P. Marsh the American minister. The principal institutions for secondary education are the gymnasiums and the lyceums. The former have a course of five years, and the instruction comprises Greek, Latin, Italian, history, geography, and arithmetic; the latter, with a three years course, add to those subjects philosophy, mathematics, physics, chemistry, and natural history. There are seven masters or "professors" in each lyceum. The pupils entering the lyceum are usually from fourteen to fifteen years of age; they are only admitted on presenting a satisfactory gymnasial certificate. According to a pleasant custom, the lyceum usually bears the name of some person of national and at the same time local celebrity—as the Leopardi lyceum at Macerata. As the gymnasiums and lyceums are too exclusively devoted to what is known as classical education satisfactorily to subserve the necessities of modern life, they have been supplemented by a very considerable number of technical schools, the earliest of which in Italy dates as far back as 1848. No fewer than 43 trade schools were subsidized by the minister of instruction in 1878-79. Most of the secondary education institutions were intended for boys. In 1861 the municipality of Milan founded a "high school" for girls, and their example has met with very commendable imitation. A variety of establishments for female education were of course in existence throughout the country at a much earlier date, but they were organized on the basis for the most part of old-fashioned ideas in regard to what was appropriate for women. Such are the so-called *conservatori* of Tuscany—which were originally purely religious foundations, and only partially secularized by Leopold I.—and the St Mary colleges of Sicily, which have occasioned so much controversy as to whether they are educational or charitable institutions. The Government lyceums and gymnasiums had 18,021 pupils in 1879, the other public lyceums and gymnasiums 11,779, lyceums and gymnasiums attached to the seminaries 11,650, and private lyceums and gymnasiums 7139—making a total of 46,589.

For the higher education Italy possesses no fewer than seventeen national universities. They are all of more or less ancient date, except that of Rome, which was opened in 1870, and it is a respect for this antiquity which is in some cases the chief cause of their preservation. That several of them are of comparatively small importance is shown by the following figures, exhibiting the number of students or bearers of lectures for the year 1879:—Naples had 2817, Turin 1509, Padua 948, Pavia 672, Rome 648, Pisa 586, Bologna 569, Genoa 480, Palermo 449, Modena 195, Parma 194, Siena 181, Catania 168, Messina 128, Cagliari 95, Sassari 93, Macerata 82. Besides the seventeen establishments there are four free universities, those of Perugia and Ferrara with three faculties each, and those of Camerino and Urbino with two faculties. They are all small,—the students for 1879 numbering 65 in Perugia, 60 in Urbino, 46 in Ferrara, and 43 in Camerino. Theology has ceased to be a subject of instruction in the national universities. In 1876-77 there were 3314 students in the faculty of jurisprudence, 2842 in that of medicine, 1257 in that of the mathematical sciences, and 212 in that of philosophy and letters. The university teaching staff consists of ordinary professors, extraordinary professors, and free professors, the last corresponding to the "Privat-docenten" of Germany. A certificate of attendance at a lyceum is requisite for admission as a university student, and candidates are further subjected to a preliminary examination.

Among the institutions which cooperate with the universities it is sufficient to mention the institute for the higher studies and the school of the social sciences at Florence, the scientific and literary

acadeiny of Milan, the upper technical institute of Milan, the engineering schools at Naples, Rome, and Turin, the veterinary colleges at Milan, Naples, and Turin, the royal school of commerce at Venice, the royal school of medicine and surgery at Naples. As an indication of the extent to which such a list might be carried, we may take the department of agricultural training. Here we have agrarian institutes and farming colleges at Rome (1872), Castelletti near Signi (1864), Motrone in the province of Lucca (1874), Macerata (1868), Cosenza (1870), Grumello del Monte near Bergamo, Brescia (1876), Brusegnane near Padua (1872), Pesaro (1876), Palermo (1819), Caltagirone (1868), Brindisi (1872), Lecce (refounded 1879), &c.; and many of these establishments have considerable pieces of land for the purpose of practical training. The Middle Calabria school of agriculture (1876) is also a school of *pastorizia* or shepherd craft. An *Istituto forestale* was started at Vallombrosa in 1869, and in the eight years (1872-1879) it has sent out eighty-three licentiates of forestry. The school of "viticulture and enology," or vine-growing and wine-making, at Conegliano dates from 1876; it publishes a *Rivista di Viticoltura*. A school of zootechnia and caseificio, or the principles of cattle-breeding and cheese-making, exists at Reggio Emilia; and at Palermo there is a special school for the art of sulphur-mining.

In 1879 about 2,000,000 lire were devoted by the Government to the encouragement of art. Art schools exist at Bologna, Carrara, Florence, Lucca, Massa, Milan, Modena, Naples, Parma, Ravenna, Rome, Reggio Emilia, Turin, Urbino, Venice; and the number of pupils has increased from about 3000 in 1862 to 5000 in 1879. Besides these fifteen official establishments, of which that of Milan—with a maximum of 1491 pupils—is by far the largest, there are academies at Genoa, Bergamo, Verona, Siena, Pisa, and Perugia. A *Musco Tiberino* has been established by the commission charged to superintend the exploration of the Tiber. Five musical conservatories are supported by Government at Florence, Milan, Naples, Palermo, and Parma.

Next to the difficulty of arousing the interest of the mass of the people in matters of education, so as to secure the realization of the legal enactments, the greatest difficulty perhaps with which the administration has had to contend has been that of obtaining a sufficient supply of teachers competent for their task. In the normal and "magistral" schools training is provided at the national expense for candidates, whether male or female, for the teaching profession. The age for entrance is fixed at sixteen for male and fifteen for female students, and the course of study lasts for three years. In 1877-78 there were 35 normal and "magistral" schools for male and 67 for female teachers. The number of pupils was 7854 (1447 males and 6407 females).

For further information on this section see Hippeau, *L'Instruction publique en Italie*, Paris, 1875, and Pécaut, *Deux mois de mission en Italie*, Paris, 1880.

The great Italian public libraries are those of Turin, Milan, Naples, Florence. Florence receives a copyright copy of all new books and new editions. The Pavia library is especially rich in works in natural science, the legacy left by Professor Frank enabling it to purchase from 1500 to 1600 new works per annum. The total number of new books added to all the state libraries, which now number 33, was in 1872 about 14,000. The readers numbered 853,901, besides 9008 teachers who got books home with them. More recent statistics show comparatively little change.

Among the philanthropic educational institutions those for the tuition of deaf-mutes deserve particular mention. It was in Italy that some of the earlier attempts were made to give instruction to this class of unfortunates; and two of its most important establishments, the royal institute of deaf-mutes at Genoa and the corresponding institute at Milan, date respectively from 1801 and 1805. From a report (Rome, 1880) which was compiled for the instruction of the second international congress of deaf-mute teachers (Milan, 1881) it appears that there are thirty-five establishments of this class, with 1491 pupils in 1880, the largest being at Milan, Bologna, Naples, Turin, and Genoa. The total number of deaf-mutes in the kingdom is estimated at nearly 12,000; and hence it is calculated that the number of pupils would require to be about 7000. The oral method is very generally employed in the Italian institutions,—the rich vowel-system of the Italian language giving a favourable basis of operations.

From the *Strenna-Album of the Associazione della Stampa* (Rome, 1881) we learn that the number of periodicals published in Italy in 1880 was 1454, or about one to every 8000 of the reading population,—a statement that compares favourably with corresponding statistics of other countries. One paper, *Gazzetta Nazionale Genovese*, dates its origin as far back as 1797; all the others belong to the present century, 162 having appeared for the first time in 1876, 227 in 1877, 240 in 1878, and 246 in 1879. The total number published in 1836 was only 185, in 1857 it amounted to 311, in 1864 to 450, in 1871 to 765, and in 1875 to 914. According to the statistics of 1875, more than the half of the total number of 494 were published at Milan (104), Florence (82), Turin (68), Rome, Naples, Bologna, Palermo, and Venice. See *Archivio di Statistica*, 1876, fasc. 1.

<sup>1</sup> In the Italian statistics *scuola* means rather *class than school*.

<sup>2</sup> There is no statement of the number of these asylums or schools.



*Beneficence.*—A first attempt to form an idea of the number and nature of the beneficent institutions of Italy was made by the Government in 1862, and the result was published in 1864 in the *Calendario generale del Regno*. A fuller inquiry was undertaken in 1863 by the board of statistics under the direction of Pietro Maestri, and the information was communicated to the public in 15 large volumes published between 1868 and 1872. According to this inquiry, usually called of 1861, because the data refer to the state of the institutions in that year, the total number of benevolent institutions (exclusive of the province of Rome) was 20,123 (of which 3666 were purely religious foundations), and their property was valued at 1,100,932,000 lire. The amount of money annually expended by these institutions was about 86,000,000; and on an average 6,305,000, or about a fourth of the population, were recipients of their bounty in one form or other. In 1862 a law was passed by which the control of all public institutions of a charitable nature was placed in the hands of the communal authorities, and these have to appoint a charity committee to superintend the department and balance the accounts. In the case of all institutions subsidized by the state, the accounts must be presented to the minister of the interior; and to this functionary is assigned the right of dissolving or reorganizing any institution which the communal authorities report as misdirected or defective. Every institution is obliged to have a regular treasurer, with surety. During the eighteen years that the law has been in force, it has greatly improved the state of matters; but that there is much room for further improvement appears from the fact that nearly the half of their gross income is of no avail for the special purposes for which they exist.

The following details, derived from an admirable report presented by Signor Bodio to the international congress of beneficence in Milan, August 1880,<sup>1</sup> show the present extent of the *opere pie*, or works of piety. In 1878 there existed in the kingdom 3668 eleemosynary charities, 13 charities for prisoners, 2694 dowry charities, 15 *ballatici* (charities for poor nursing mothers), 239 asylums for shelter, 16 labour charities (*case di lavoro*), 1028 foundations for the assistance of the sick in their own homes, 41 for the assistance of women in childbed in their own homes, 1139 hospitals for the sick, hospitals for chronic patients, 18 maternity hospitals, 15 lunatic asylums, 10 seaside hospitals, 508 school charities, 340 infants' asylums, 397 *collegi e retiri*, 463 orphanages, 17 deaf-mute institutions, 9 blind asylums, 695 *monti di pietà*, 1965 *monti frumentari* (offices for furnishing grain to poor peasants in return for pledges), 30 agrarian loan funds, 102 nursing and fondling institutions, 2633 "congregations of charity," and 1553 foundations of miscellaneous scope.<sup>2</sup> These 17,870 institutions being distributed among 5951 communes, 2431 communes have none of their own; but the advantages of the institutions are seldom confined to the special communes in which they are situated.

The following table (XXXVI.) indicates the gross and the net revenues enjoyed by the *opere pie* of each of the compartments:—

	Gross Revenue.	Per head of pop.	Net Revenue.	Per head of pop.
	lire.	lire	lire.	lire.
Piedmont.....	13,410,514	4.66	7,911,155	2.73
Liguria.....	4,202,580	6.11	2,037,642	2.43
Lombardy.....	20,685,493	6.94	10,634,986	3.67
Veneto.....	6,989,415	2.43	3,301,209	1.25
Emilia.....	8,690,459	2.83	4,361,439	2.06
Tuscany.....	5,835,091	2.11	3,027,174	1.41
Marches.....	2,485,702	2.72	1,349,887	1.47
Umbria.....	1,662,248	3.02	896,341	1.63
Lazio.....	6,180,813	7.33	3,348,049	4.00
Abruzzi and Molise ..	1,742,927	1.04	616,252	0.48
Campania.....	9,725,328	3.53	4,828,396	1.75
Apulia.....	2,254,387	1.58	1,138,304	0.80
Basilicata.....	447,583	0.87	219,443	0.42
Calabria.....	548,855	0.45	281,391	0.23
Sicily.....	5,476,835	2.12	2,829,034	1.10
Sardinia.....	513,395	0.81	314,486	0.49
Total.....	90,859,521	3.39	47,110,206	1.75

Classifying the institutions, the following results appear, the amounts being stated in thousands of lire (Table XXXVII.):—

Institutions	Parliamentary.	Gross Revenue	Parliamentary burdens, &c.	Taxes.	Cost of administration.	Revenue available
Eleemosynary.....	394,421	22,189	3,559	3,129	3,672	11,537
Hospital.....	560,378	30,454	4,258	3,553	4,472	16,170
Credit.....	128,443	8,180	3,590	822	2,396	4,575
Educational.....	376,198	20,793	2,072	3,373	3,087	12,261
Miscellaneous.....	167,923	9,231	921	1,305	1,432	5,674
Total.....	1,626,363	90,859	14,202	14,484	15,062	47,110

The following table (XXXVIII.) gives the returns for 1877 for the lunatic asylums of Italy:—

	Asylums or Hospitals.	Males.	Females.	Total.	Proportion per 100,000.
Piedmont.....	6	1,033	861	1,894	62.02
Liguria.....	2	323	273	596	67.05
Lombardy.....	15	1,370	1,366	2,736	75.52
Veneto.....	10	729	966	1,695	60.75
Emilia.....	6	1,167	1,198	2,370	103.84
Umbria.....	1	164	96	257	45.05
Marches.....	4	497	595	892	94.76
Tuscany.....	5	951	1,007	1,958	88.62
Rome.....	1	387	428	715	84.67
Napoletano.....	5	949	+60	1,409	18.85
Sicily.....	1	245	264	429	22.71
Sardinia.....	1	78	44	122	18.39
Total.....	57	8,010	7,163	15,173	64.17

It appears that the number of asylums is deficient in the Napoletano and in Sicily and Sardinia, while of all the regions Emilia and the Marches are the best supplied. Of the institutions included in the table, some are maintained by the provinces, such as those of Cuneo, Alessandria, Bergamo, &c., others by the municipalities, others again by private individuals. Among the larger establishments are the public asylums of Genoa (*Manicomio pubblico*), Milan, Aversa (819 inmates), Rome (715), Siena (791), Florence (712). Venice has separate establishments for its male and female lunatics.

The idea of establishing seaside hospitals to which patients could be taken from the inland districts for change of air has been carried into effect more extensively in Italy than in most other countries. Such institutions exist at Viareggio (since 1856), Voltri (1862), Fano (1863), Leghorn (1864), Sestri Levante (1867), Porto d'Anzio (1868), Venice (1868), Porto S. Stefano (1870), Rimini (1870), Riccione (1871), Lanzo (1871), Celle (1872), Grado (1873), Palermo (1874), Pisa (Bocca d'Arno, 1876), Cagliari (1879). In many cases a very considerable number of communes have the right of sending their patients to a given hospital; that of Lomo for instance receives from thirty-four communes which have committees of transmission. See Dr Gaetano Pini, "Gli ospizi marini e le scuole per rachitici in Italia" in *Atti del VI. Congresso dell'Associazione medica italiana*, Turin, 1877.

*Administration of Justice.*—Though, in the opinion of the most competent judges, Italy is still in the main free from that curse of civilized countries, a distinctly differentiated criminal class, there is hardly a country of Europe which presents from year to year such appalling tables of criminality. Leaving out of view the question of brigandage—which is of moment only in the southern provinces, where through long inertness the arm of the law had become comparatively powerless—crimes of violence are exceptionally frequent, and (to take the statistics of 1875) the number of persons undergoing punishment in a given year is in the ratio of 175.51 for every 100,000 inhabitants. In proportion to population there are four times as many persons condemned to death or penal servitude for life as in France, twice as many to hard labour, five times as many to solitary confinement. And it cannot be said that that part of the administration whose duty it is to deal with this multitude of law-breakers is in a state of competent efficiency. Trial by jury is in force, but there seems good reason to question the fitness of a large part of the population for the exercise of the functions thus devolved upon them. "Not guilty with extenuating circumstances" is an amusing but suggestive verdict. Though according to the law of 1865 there is only to be one court of cassation in the country, as an actual fact there are five, as follows (Table XXXIX.):—

Courts of Cassation.	Courts of Appeal.
Turin.....	Turin, Brescia, Casale, Genoa, Milan, Parma and Modena.
Florence.....	Florence, Lucca, Venice.
Naples.....	Naples and Potenza, Aquila, Catanzaro, Trani.
Palermo.....	Palermo, Catania, Messina.
Rome.....	Rome, Ancona-Macerata, Bologna, Cagliari, Perugia.

The Roman court of cassation was instituted only in 1876,—the Roman court of appeal having previously been dependent on Florence, and those of Ancona-Macerata, Bologna, and Cagliari on Turin. The number of courts of assize varies from year to year, according to royal decree: in 1874 there were 86, in 1876, 92. Of civil and correctional tribunals there are 162, and of "pretors" 1813. The pretors are both civil and criminal judges; in the civil department they can decide in all cases involving less than 1500 lire. It is considered part of their duty to endeavour to bring litigants to terms without proceeding to formal trial; and, that this desirable object may be more frequently secured, a special class of judges or arbitrators, known as conciliatori—of ancient establishment in the Neapolitan provinces—was rendered common to all Italy at the legislative unification of 1865. At the request of parties in dispute, they may deal with cases involving any amount, but their decisions are final only as far as 30 lire, and they have no control—any more than the pretors—of questions affecting the taxes. The value of this class of functionaries is evident from the fact that in 1875, for example, about 25 per cent. of the cases pre-

<sup>1</sup> Printed in *Archivio di Statistica*, 1880, fasc. iv.

<sup>2</sup> It is to be observed that this list does not include those institutions which are still, like the great Cottolengo Hospital at Turin, under the direct control of their founders.

sented to the conciliators or to the pretors exercising conciliatorial functions were settled by compromise, and out of 769,533 cases 580,066 received definitive sentence.

The "establishments of detention" are of three kinds:—those of preventive detention, or judiciary prisons; those of penal detention, for culprits of full age; and those of correction, or reformatories for prisoners under age. The following table (XL.) gives details for 1879 (the third column of figures giving the number of prisoners for whom there is sleeping accommodation):—

	No.	Area in Acres.	Prisoner Accommodation.	"Sequestra- tion" Cells.	"Punish- ment" Cells.
Bagni piccoli, or convict establish- ments for men.....	26	17,193	17,654	257	352
Houses of correction for men.....	36	1,011	12,068	17	427
Do. do. women.....	6	10	1,243	48	22
Penal colonies for men.....	3	4,955	1,500	19	28
Prisons (judiciary).....	237	186	37,237	588	524
Houses of detention for men.....	6	35	1,088	16	113
Total.....	314	24,420	70,830	1,345	1,416

Of the total number of establishments 51 belong to the Lombardo-Venetian provinces, 42 to the ancient continental provinces, 31 to the Tuscan provinces, 15 to the Parma and Modena provinces, 55 to the Roman, 80 to the Neapolitan, and 40 to the Sicilian and Sardinian. The Government report indicates that of the convict establishments (central and secondary) 12 were neither healthy nor secure; the same was the case with several of the houses of correction; and no fewer than 87 of the prisons are condemned for the latter defect and 51 for the former.

In the convict establishments there were 17,576 prisoners in December 1879. The mean for 1870 was 13,663, and every succeeding year has seen an increase. In the ten years from 1870 to 1879 the total admissions have been 31,470. During that period 4846 received remission of their sentence, and 5176 died in prison. The following are the convict establishments, arranged in order of importance—Porto Longone, Civita Vecchia, Nisida, Palermo, Ancona, Cagliari, Orbetello, Genoa, Procida, Brindisi, Finalborgo, Gaeta, Pozzuoli, S. Stefano (Naples), Alghero, Castiada, Favignana, Palermo, Pesaro, Piombino, Porto Ferrajo, Portici, Ponza, Porto d'Anzio, Terracina, and Trapani. The establishment at Varignano was made a lazaretto in 1871. See *Stat. decennale delle carceri* (1870-79), Civita Vecchia, 1880.

According to the confession of Italian investigators, the state of the judiciary prisons is often deplorable in the extreme. "When I see," writes Beltrami Scaglia, "the enormous number of 44,415 individuals existing in the judiciary prisons in the beginning of 1875 (and the differences are not very great in the different years), the number of persons committed to prison amounting in the year to 356,511, and the number of those discharged to 257,854, when I see that, while 127,837 are liberated on the termination of their punishment or through act of clemency, no less than 81,087 owe their liberation to the fact that they have not been found guilty of the crimes laid to their charge, and when I consider the unhappy condition of most of our establishments of preventive detention, my heart aches to think what a hotbed of corruption they constitute, and what a current of moral pestilence must find issue from them."

Capital punishment was in 1875, after much debate, adopted as the supreme penalty for the whole kingdom (inclusive of Tuscany, where it had not previously been in force); but in November 1877 the chambers voted by a large majority for the exclusion of the death-penalty from the new code. Between 1867 and 1876 inclusive 392 persons were condemned to death, but 351 received commutation of sentence, and only 34 were executed. In the same period 222 cases were subjected to a second trial, with the result that 20 of the accused parties were completely acquitted of the charge on which they had been previously condemned to death, and the whole of the remainder had their sentences commuted to penal servitude for life or some minor penalty. See *Notizie sulle Condanni alla pena di morte* (Rome, 1878), epitomized in *Arch. di Stat.*, 1878.

*Political Administration.*—The constitution of the kingdom of Italy is based upon that presented to the Sardinians by King Charles Albert, 4th March 1848. The crown is hereditary in the male line of the house of Savoy. The king—whose majority is attained at the close of his eighteenth year—cannot exercise his legislative functions except in agreement with the voice of the national parliament, and on his accession to the throne he is bound to take an oath in the presence of both chambers that he will obey the constitution. By the law of 17th March 1861 his title is "by God's grace and through the will of the nation king of Italy." His executive functions are exercised by means of responsible ministers, nine in number—(1) the minister of foreign affairs, (2) of the interior, (3)

of public instruction, (4) of finance and the treasury, (5) of war, (6) of marine, (7) of grace, justice, and worship, (8) of public works, (9) of agriculture, industry, and commerce. These departments are to all intents the same as those which under slightly different designations existed in the kingdom of Sardinia in 1860, just before the title of king of Italy was assumed by Victor Emmanuel. The ministry of agriculture, however, which was instituted by Cavour in July of that year, was abolished in 1873, but it was restored in 1879. A permanent hydrographic commission was instituted in 1866, a council of meteorology in 1876, and an independent board of statistics (*Direzione della Statistica*) in 1878. There was a meteorological department in connexion with the ministry of agriculture as early as 1865, and a statistical department as early as 1861.

The Italian parliament consists of two houses or chambers—a senate and a chamber of deputies. The senate consists of the princes of the royal family (who are admitted to the sittings at the age of twenty-one, but cannot vote till they have completed their twenty-fifth year) and an unlimited number of persons, forty years of age or upwards, chosen by the king from the ranks of the archbishops and bishops, ministers of the crown and high administrative functionaries, admirals and generals, members of the provincial councils and of the Turin academy, persons who have rendered special services to their country, or who for three years have paid 3000 lire of direct taxation. Since the removal to Rome the parliament is accommodated in the palace at Monte Citorio. Neither senators nor deputies are paid for their services, but they have the right to a free pass over the whole railway system of the country. All measures must be carried by an absolute majority, or one half of the members and one. The parliamentary oath does not contain the name of God; the member simply says, "I swear to be faithful to the king and loyally to observe the statutes and laws of the land." According to the law there must be a new election every five years; the actual duration of parliaments, however, has hitherto been on an average two and a half.

The registered electors for 1879 amounted to 627,838, out of a population estimated at 28,437,091, or 2·21 per cent.; in other words, Italy has 7·77 electors in every 100 males above twenty-one years of age. The highest proportions were in Porto Maurizio 5·06 per cent., Genoa 3·63, Leghorn 3·67, and Alessandria 3·32 per cent. The lowest of all was Syracuse 0·07 per cent. Thirty-five provinces besides those mentioned had upwards of 2 per cent., and all the rest had upwards of 1 and less than 2. Of the total electorate 489,044 had their place on the roll through the payment of not less than 40 lire of direct Government taxes and provincial "super-imposta"; 5922 in virtue of the value of their factories, workshops, or warehouses; 1412 as sea-captains or employers of at least 30 operatives; 1502 as holders of Government stock of the annual worth of 600 lire; 2934 in virtue of the amount of their house-rent,—making an aggregate of 15,158 whose right was due to their wealth. On the other hand there were 550 members of scientific academies, chambers of commerce, and directors of agrarian commissions; 5631 professors, ex-professors, and teachers in the higher institutions; 43,045 functionaries and employes, civil and military; 1452 persons decorated with the national orders of knighthood; 33,936 holders of university degrees (laureati); 27,522 solicitors, accountants, geometicians, chemists, &c.; 570 money agents and brokers,—making a total of 112,906 whose right depended on education and social influence.

According to the law of 1860, in force in 1880, there are 508 electoral colleges, or as they would be called in England parliamentary constituencies, the largest of which are the third college of Palermo with 84,767 inhabitants, and the third of Turin with 76,634, and the smallest S. Sepolcro with 30,463, and Benevento with 25,460.

The following table (XLI.) indicates the chief statistics of the eight elections which have taken place in Italy. They are interesting as showing an increase of political activity among the people. As is well known, the watchword of the ultramontane party has been "neither electors nor elected"; their abstention helps partly to explain the small percentage of the electors who have voted.<sup>2</sup>

Years of General Elections.	Population.	Number of Electoral Bodies and Deputies.	Electors.		Voters at the Definitive Elections.		
			Number.	Per Cent.	Number.	In 100 Inhabitants.	In 100 Electors.
1861	21,777,354 <sup>3</sup>	443	418,696	1·92	243,912	1·12	58
1867			594,263	2·08	286,900	1·18	57
1867	24,278,776 <sup>4</sup>	495	498,208	2·05	281,701	1·16	57
1870			550,018	1·98	266,814	0·99	50
1874			571,523	2·13	329,523	1·23	58
1876	26,801,154	508	605,097	2·26	368,750	1·35	61
1880			621,896	2·32	386,593	1·44	62

<sup>2</sup> A electoral map of Italy and a valuable analysis of the distribution of parties in 1880 will be found in *Arch. di Stat.*, 1880, fasc. iii.

<sup>3</sup> Without the Venetian provinces, Mantua, and Rome.

<sup>4</sup> Without the province of Rome.

<sup>1</sup> Author of *La Riforma penitenziaria in Italia*, and founder of the *Rivista di disciplina carceraria* 1871.



*Internal Administration.*—It was not till 1865 that the administrative unity of Italy was realized. Up to that year some of the regions of the kingdom, such as Tuscany, continued to have a kind of autonomy; but by the laws of 20th March the whole country was divided into 69 provinces and 8545 communes. The extent to which communal independence had been maintained in Italy through all the centuries of its political disintegration was strongly in its favour. By the new law the communal council was to consist of 80 members if the commune had more than 250,000 inhabitants, of 60 members if more than 60,000, of 40 if more than 30,000, of 30 if more than 10,000, of 20 if more than 3000, and in all other cases of 15. It was found by the census of 1861 that the first category was represented by only 1 commune, the second by 12, the third by 34, the fourth by 265, the fifth by 1762, and the sixth by 6471. As many of the communes, especially in the north, were found to have a very small population, a considerable number of them have been wisely incorporated with others. The syndic (*sindaco*) or chief magistrate of the commune is appointed by the king for three years, and he is assisted by a "municipal junta" consisting of ten assessors and four substitutes for the communes of the first category, and of 8+4, 6+2, 4+2, and 2+2 respectively in those of the others. The communal council meets in ordinary course twice a year. Eligibility for office as a councillor is determined very much by the same considerations as affect the political suffrage, the main criterion being the amount of direct taxes paid. All those in receipt of communal salaries are excluded, and, if a sufficient number can be obtained without them, all who are unable to read.

The provincial councils consist of 60, 50, 40, or 20 members, according as the population exceeds 600,000, 400,000, or 200,000, or falls below this last number. Each council elects its own president; its sessions, which in regular course occur once a year, are opened and closed by the prefect or his substitute in the king's name. The term of office for the provincial council is five years. A "provincial deputation" or standing committee, appointed by the council, acts under the presidency of the prefect as the representative of the same throughout the year.

The various sections of the local government—municipal, communal, and provincial councils—are left remarkably free from interference on the part of the central authorities. There is a prefect in every province, but, to quote Gallenga's words, he is little more than the head of the provincial police. In point of local influence the syndic, who in the large cities is usually a nobleman or distinguished statesman, is the more important functionary.

The principal law regulative of communal taxation is that of July 3, 1864. By this the communes were allowed, not only to impose independently of the state an additional tax or super-impost (*sovrimposta*) on the articles already subjected to the national octroi, but also to charge a local customs duty on other articles of meat and drink, on forage, fuel, building materials, soaps, fatty matters, and other objects of the same class. Italy thus took rank, says Alessio, as one of the European countries in which the greatest liberty of taxation was granted to the local corporations. Further licence has been since conceded, in 1869, 1870, &c. In 1877 the total income of the communes amounted to 228,733,014 lire or nearly £9,115,000, and of this sum 38.71 per cent. was furnished by the communal octroi proper (*dazio consumo*), 31.24 by the super-impost on the land, 8.10 per cent. by the hearth-money or *fucalcio*, 3.27 by the tax on cattle and horses, and the remainder by a variety of taxes on public and private conveyances, dogs, domestics, riding a. l. carriage horses, &c. A tax on photographs and *insigne*, first rendered legal in 1875, and only adopted by a few of the communes, is the least valuable on the list. Foreigners, except when they really take up permanent residence in a commune, are for the most part exempted from the local taxation. The effect of many of the taxes, especially as applied by the short-sighted local policy, has proved highly prejudicial to the development of industries. The tax, for instance, on wood and coal tells against the glass-works of Venice, the potteries of Florence, the gold and silver work of Milan. At Voltri taxes are paid on nearly all the raw materials of the cotton industry, on the coal, the petroleum, the oil, the very flour needed for the dressing of the stuffs, &c. Paper is taxed in many towns (at Bologna as much as 7 per cent.), at Genoa not only paper but printed matter, at Reggio Emilia types and printing machines. There is often a most extraordinary difference in the amount imposed on the same article: every quintal of wax for stearine candles, for example, pays 5 lire in one city, 10 in another, 40 in a third. In many cases, as at Bergamo, Como, Parma, &c., the result is that the factories show a tendency to locate themselves outside of the communal limits.<sup>1</sup>

And in spite of this superabundant taxation the debts of the communes are unusually numerous, and in some instances give rise to grave concern. Italy has the honour of being the first of European nations to furnish regular returns in regard to the whole department of provincial and communal debts; and the light thrown by these on the state of the local finances is very instructive. At the inquiry

<sup>1</sup> See G. Alessio, "L'imposta del dazio consumo in Italia," in *Annali di Stati*, 1860.

in 1873 it was found that the total of the debts of the communes amounted to 545,129,128 lire, and that of the provinces to 54,401,390. By 1877 these figures had increased to 707,551,255 for the communes, and 90,073,603 for the provinces. Nearly the half of the communal increase of 162 millions was due to the two cities of Florence and Naples, the former being responsible for 36,933,905 lire of the increase, and the latter for 36,726,188 lire. The state of the Florentine finances is particularly noteworthy. It is estimated that the *dazio consumo* cost every inhabitant 30.11 lire in 1877, and 31.58 in 1878 (the only other chief cities with similar amounts being Genoa, with respectively 33 and 27½ lire, and Rome with 28½ and 29½), and the total communal taxation is stated at 64 lire per head. On March 18, 1878, Florence suspended payment of the capital and three months later of the interest on its debts, which amounted to about 160,000,000 lire. A royal commission was appointed in June 1879 for the liquidation of the debt, and it put into operation a scheme by which the debt will be cleared off by 1939. Full details will be found in the *Report of the British Consul for Florence*, 1880, or in Mr Anthony Trollope's interesting survey in the *British and Foreign Quarterly Review*, 1879. The other cities where the local customs press heaviest on the citizens are Palermo and Catania (20 lire), Leghorn (nearly 20), Siena (19), Pavia (18), Milan (17), Turin (16). Among those that suffer least are Belluno, Arezzo, and Sondrio. At the close of 1878 it was calculated that the quota of the communal debt for every individual would amount to 913.62 lire at Florence, to 309.60 at Pisa, to 274 at Genoa, to 248.52 at Naples, and that on an average of all the *capoluoghi* or provincial chief towns the quota would be 140.96 lire. See *Statistica dei debiti comunali al 1° Gennaio 1879* (Rome, 1880).

*Finance.*—It is not every Government even in a country of exceptional wealth like England that is able to keep the balance on the right side of the national account; in Italy it long seemed as if no Government could do so. To attain the *pareggio*, or in familiar phrase to make both ends meet, was the dream and the despair of minister after minister. Money was wanted for so many things; taxes of any considerable value could be imposed on so few. The various parts of the national organization had to be put with all possible speed into a condition not altogether unworthy of the prestige and the promise of the kingdom. What in other countries had been the growth of generations, Italy was called upon to produce at once by "forcing." To attain her nominal or political unity she had to submit to many sacrifices; to make the unity something better than a musical word, she had to submit to many more. That she should have spent so much on her army, her fortifications, and her fleet, is matter of regret in spite of the secondary purposes which such things subserve; that at the same time she has aimed high, and acted liberally in respect of more useful if less ostentatious departments, is worthy of admiration, and, in judging of what she has attained, it must never be forgotten what an inheritance of debt and disorganization passed over to her from the states which she supplanted.

The following table (XLII.) of debt, revenue, and expenditure (given in millions of lire = £40,000), shows that on the whole the financial condition of the country, considered in itself and apart from the causes to which it is due, is an improving if not a satisfactory one. It must be noted that in the columns of revenue and expenditure no account is taken of the movement of the capitals, of the expenses connected with the railway system, or of the debts and payments of one part of the administration to another.

Years.	Debt.	Revenue.	Expenditure.	Deficit or Surplus.
1866	6,930	617	1,338	- 721
1867	7,415	714	929	- 215
1868	7,679	768	1,014	- 346
1869	6,081	671	1,019	- 148
1870	8,815	866	1,081	- 215
1871	8,951	967	1,041	- 74
1872	9,622	1,014	1,098	- 84
1873	9,760	1,017	1,136	- 89
1874	9,788	1,077	1,690	- 13
1875	9,953	1,096	1,682	+ 14
1876	10,769	1,123	1,763	+ 20
1877	11,292	1,181	1,758	+ 23
1878	11,289	1,192	1,777	+ 15
1879	11,276	1,228	1,786	+ 42

If the items excluded from the above comparison be taken into consideration, the revenue and expenditure will stand for the later years as follows (Table XLIII.):—

	Revenue.	Expenditure.		Revenue.	Expenditure.
1874	1334	1397	1877	1487	1474
1875	1447	1415	1878	1487	1448
1876	1370	1399	1879	1463	1547

The most noticeable facts indicated by Table XLII. are (1) the rapid increase of the national debt, which at the declaration of the kingdom of Italy in 1861 amounted to only 3,131,053,610 lire, so that it more than doubled itself in seven years and more than trebled

itself in twelve, and (2) the attainment during five consecutive years of a very considerable surplus. The following table (XLI.V. gives the official report on the items of the national debt in 1879:—

	Per cent	Annuities, &c.	Year of Extinction.
<b>I. Consolidated Debt.</b>			
Five per cents.....	5	373,193,087	...
Three per cents.....	3	6,408,080	...
II. Sum due to the Holy See.....		3,225,000	...
<b>III. Debts entered separately.</b>			
Debito feudale of 1871.....	5	2,823,775	168,975 1894
(Loan of 1849.....)	4	248,000	156,420 1885
" 1850.....)	4	267,680	129,060 1887
Sardinia.....	5	5,125	6,325 1881
" (English, 1859).....)	3	1,008,072	29,101 1902
Tuscany.....	5	4,812,248	...
" 1861.....)	5	2,201,750	2,050 1959
Lombardy and Modena.....	5	1,185,185	148,148 1886
(Loan of 1859.....)			
Venice.....	3	13,962	...
(Loan of 1827.....)			
Parma.....	5	80,116	8,231 1883
(Loan of 1837.....)			
Erodi loan, 1846.....)	5	21,250	22,500 1886
Rothschild loan, 1847.....)	5	5,038,800	219,600 1898
Loans of 1860 and 1864.....)	5	2,046,690	59,947 1907
Loan of 1866.....)	5	2,341,709	5,725 1946
National loan, 1866.....)	5	2,104,595	4,217,553 1880
Loan guaranteed by church property, 1867 and 1870.....)	5	9,823,665	1,084,445 ...
Novara.....)		225,280	1,888 1917
Cuneo.....)		421,523	2,665 1848
Vitt. Emanuele.....)	3	3,894,000	9,645 1961
Turin-Asti.....)		243,465	915 1964
Genoa-Voltri.....)		56,983	962 1900
Udine-Pontebba.....)	5	1,597,800	775 ...
Cavour Canal loan.....)	5	3,765,900	130,000 1915
Tiber obligations.....)		625,000	...
Debits entered separately.....		42,148,211	6,409,928 ...
IV. Miscellaneous debts <sup>1</sup> .....		47,605,291	1,604,986 ...
V. Floating debt.....		17,268,629	...
Total of debt.....		494,848,296	6,014,914 ...

The figures, it must be noted, represent the interest, not the capital. A large proportion of the Italian consols are held in small amounts, for the most part by French investors, and the greatest holder after France appears to be England. In the Bourse of Paris in 1879, for instance, 11,912,000 lire of the stock were presented for certification, in the Exchange of London 8,319,000 lire; and after these places comes Berlin with only 1,453,000 lire. The value of the 5 per cent. stock at Paris, which was as low as 39.40 in the course of 1866, has risen rapidly nearly every year, especially since 1875, and in the course of 1880 was as high as 87.60. A similar advance was observable in the Italian exchanges; for from 43.52 in 1866 the value rose to 94.20 in 1880.

In the matter of taxation the Italian statesmen have mainly followed in the footsteps of the French; and the revenue is eked out by several imposts of the most questionable character. Mr Gallenga even goes so far as to say that "there is hardly an unwise, inhuman, unpopular, or even immoral tax to which the Government has not been compelled to resort." It is a small matter that the *aurum lustrale* of ancient Rome should again figure in the Italian budget; but it is a serious thing when the salt monopoly, the lottery, a grist-tax, and an octroi are among the most important of its items. The grist-tax, which pressed heavily on the very means of life, and aggravated the already aggravated misery of the poorer classes, has happily been reduced in 1880 from 2 lire to 1.50 per hectolitre, and is destined to disappear altogether in 1884. Against the octroi, which, as shown in the paragraph dealing with the communal administration, tells severely on the prosperity of several important industries, an intelligent opposition is beginning to gather head; and the law in this respect will probably be amended or abrogated before long. The following table (XLV.) gives the actual revenue of the Government for 1878 and 1879, the actual expenditure for 1878, and the estimated expenditure for 1879, all in lire:—

I. Revenue.

	1878.	1879.
Receipts.....	1,197,196,796	1,215,173,076
Movement of capital.....	78,013,334	82,010,298
Construction of railways.....	60,412,428	51,515,710
Compensations.....	101,681,349	111,121,575
Total.....	1,437,303,907	1,459,820,659

<sup>1</sup> The chief miscellaneous debts are—the annuities due to the South Austrian and Upper Italian Railway Company, in terms of the convention of November 1875 (33,160,215 lire, date of extinction 1869), tobacco monopoly obligations (4,500,000 lire), advance in gold made by the national bank at 5.75 per cent. (2,992,610), and obligation issued in favour of the company for the sale of the state property (2,060,561).

II. Expenditure.

	Real Expenses.	Transformation of Capital.	Compensations.
<b>1878.</b>			
Ministry of treasury and finance.....	735,290,059	84,620,455	92,508,419
grace and justice.....	27,954,811	...	257,750
foreign affairs.....	6,120,220	...	87,083
public instruction.....	24,917,244	368,362	762,319
the interior.....	55,420,560	386,895	1,360,447
public works.....	69,541,357	64,743,628	370,207
war.....	206,343,102	2,239,146	4,064,688
marine.....	45,107,243	200,508	2,241,850
Total.....	1,189,596,996	152,620,774	101,662,263
<b>1879.</b>			
Ministry of treasury and finance.....	765,747,254	78,416,401	103,296,080
grace and justice.....	28,823,991	...	114,146
foreign affairs.....	6,277,894	6,000	72,500
public instruction.....	30,305,398	...	788,426
the interior.....	60,067,476	...	1,143,947
public works.....	108,502,483	69,642,511	273,718
war.....	223,147,403	...	4,088,254
marine.....	47,424,797	...	2,337,648
Total.....	1,279,942,680	148,066,912	112,125,200

The relative importance of the various sources of revenue may be seen from the following figures in millions of lire (= £40,000), showing the totals for the ten years 1871-1880 (Table XLVI.):<sup>2</sup>—

Land tax.....	1854	Octroi.....	661
Tax on personal property.....	1711	Tobacco.....	563
Customs.....	1042	Registration.....	507
Salt monopoly.....	784	Stamp duty.....	568
Lottery.....	731	Post-office.....	248
Succession duty.....	713	Railway.....	112
Grist-tax.....	693	Telegraphs.....	82

Banks.—By the law of April 30th 1874, the right of issuing bank notes was limited to six banks—the National Bank of the Kingdom of Italy founded by the Sardinian law of 1850, the National Tuscan Bank founded by the grand-duke in 1857, the Roman Bank constituted by papal authority in 1850, the Tuscan Bank of Credit for industry and commerce established by the provisional Tuscan Government in 1860, the Bank of Naples dating from 1816, and the Bank of Sicily due to a decree of 1843. The two Tuscan banks and the Roman and the National Bank are joint-stock companies, with their capital subscribed in shares. The capital of the four joint-stock banks amounted in the aggregate to 255,000,000 lire, of which 200,000,000 belonged to the National Bank, 30,000,000 to the National Tuscan, 15,000,000 to the Roman, and 10,000,000 to the Tuscan Credit. By the law of 1874 the Bank of Naples was authorized to carry its capital by 1885 to 48,750,000 lire, and the Bank of Sicily to 12,000,000; the actual amounts in 1877 were 39,000,000 in the one case, and 9,200,000 in the other. The law just mentioned united the six banks into a *consorzio* or union, bound if required to furnish to the national exchequer bank-notes to the value of 1,000,000,000 lire manufactured and renewed at their common expense; but by the law of 7th April 1881 (mentioned in detail further on) the consorzio ceased on the 30th June 1881. The following table (XLVII.) indicates the position of the issue of bank notes both by the consortium and by the individual banks on their own account on the 30th September 1880.

Notes.	Consortial.	Bank-proper.	Notes.	Consortial.	Bank-proper.
50 cent.	11,074,171	289,947	20 lire	50,323,000	494,400
1 lire	38,984,381	101,528	25-50 "	...	130,633,945
2 "	63,679,518	49,684	100-500 "	146,439,750	463,412,500
5 "	201,866,850	204,535	1000 "	184,099,900	129,585,000
10 "	243,593,839	106,670			

The total aggregate amounts to nearly 1,665,000,000 lire. The following table (XLVIII.) gives details (the amounts in millions of lire) as to the working of the institutions in 1879:—

Banks	Debts at sight.	Reserve per 100 lire for D-bis at sight.	Paper dis-counted.	Advances.	Special Guarantee Fund.
National Bank.....	489.11	83.58	167.66	114.69	443.77
Bank of Naples.....	216.65	38.20	57.03	57.08	196.87
National Tuscan Bank.....	46.72	38.20	19.74	.61	3.20
Roman Bank.....	44.91	37.84	29.49	3.69	50.17
Sicily Bank.....	60.61	34.56	15.65	6.86	43.45
Tuscan Bank of Credit.....	14.16	35.84	6.29	6.96	17.73
Total.....	863.16	35.32	295.86	189.49	790.19

The total amount of the circulation and deposits of all the six banks thus amounted to 863,160,000 lire, while that of the Bank of England alone at the same date was 1,657,234,000.

The following table (XLIX.) indicates the number of the various joint-stock credit institutions at the close of 1878:—

<sup>2</sup> See Marpurgo, *Sulla finanza nazionale*, Rome, 1874.



	No.	Capital.
		lire.
Banks of issue .....	4	255,000,000
People's banks .....	124	41,187,220
Ordinary credit societies.....	102	334,393,371
" Agrarian " banks.....	10	9,000,000
Insurance companies.....	37	41,015,000
Railway companies.....	23	420,358,500
Mining companies.....	23	43,228,316
Companies of other kinds.....	232	328,546,231
Foreign insurance companies ..	33	373,922,000
" miscellaneous companies.....	22	80,950,000
	615	1,882,601,238

In 1869 the corresponding list comprised 352 institutions, with a total capital of 1,576,834,299 lire. The agrarian banks were instituted by the Act of June 21, 1869, and in 1870 they were three in number, with a capital of 6,450,000 lire. The twelve existing in 1879 were situated at Alessandria, Asti, Bologna, Oristano (in Sardinia), Cagliari (in Sardinia), Arborea and Casanuga, Florence, Mantua, Terraquova Pausania, Sisaia, and Cologne Veneta.

The minister of agriculture published in 1880 an account of the friendly societies in the kingdom (*Statistica delle Società di mutuo Soccorso, anno 1878*), from which it appears they are rapidly on the increase. In the following table (L.) the second column gives the population of the country, the third the number of societies known to exist, the fourth the number of the societies which gave information of their strength to the Government, and the fifth the number of the members:—

Year	Population	Societies	Informing Govt.	Members
1862	21,929,176	443	417	111,608
1873	27,165,553	1,447	1,146	218,622
1878	28,209,520	2,091	1,981	331,548

It appears that 50 of these societies existed before 1850, and that 186 were commenced between that year and 1861. How rapid the increase has been is shown by the fact that in 1876, 1877, and 1878 there were nearly as many new societies started annually as in that decade. Piedmont, Lombardy, Tuscany, and Sicily are the districts where the number is greatest. For the most part the societies are open to operatives in any trade or industry, but at least 391 are exclusively intended for some particular class—e.g., doctors, employes, teachers, &c. Of the 2091 indicated, 1537 are for men only, 70 for women only, and 484 for either.

*Banche popolari*, or people's banks, corresponding to the *Creditgenossenschaften* of Germany, have increased in number from 40 in 1869 to 123 in 1878. From a paper by Luzzati, the enthusiastic and laborious president of the association of the people's banks, we find that 84 of these institutions which furnished him with details of their working had at the close of 1877 a capital of 34,941,593 lire, divided into 710,869 shares, and a reserve fund of 10,436,143 lire. The greater number of these banks are in Lombardy, Venice, Piedmont, and Liguria. Societies of ordinary credit increased from 19 in 1869 to 143 in 1873, but by 1878 the number had again sunk to 102, owing to the monetary crises through which the country had passed.

*Currency.*—Italy is a member of the Latin monetary league founded in 1865. By this the coining of pieces worth 2 lire or less was limited to 6 lire per inhabitant, so that the amount of such coins permissible before the incorporation of Venice was 141,000,000, and after that date 156,000,000. By the convention of 1875 the coining of silver coins of 5 lire was limited to 50,000,000, and this amount was reduced to 30,000,000 by the convention of 1876. The actual value coined from 1862 to 1875 has been—gold, 236,167,200 lire; silver—5 lire pieces, 281,637,025, and pieces of minor value (1 lire, 2 lire, 20 centesimi, and 50 centesimi), all coined between 1862 and 1868 inclusive, 156,000,000; bronze, 76,190,442 lire. By the conventions of 1878 and 1879 it was agreed that the minor silver coinage of Italy should not be received in the public exchequer of the other states of the league until an end was put to the forced paper currency; and France, Belgium, Greece, and Switzerland have undertaken to withdraw it from circulation in their respective territories, and to

collect it at Paris, the Italian Government agreeing to exchange it for gold or silver scudi.

The Italian Government has been put to much expense in the matter of the unification of the coinage, and the process of withdrawing the coins of the separate ex-Governments is still going on. Table LI. indicates the value in lire of the coins withdrawn from circulation between 1862 and 1871.

From 1872 to 1879 the value of the gold withdrawn was 6,080,295 lire, and that of the silver 143,130,871; of the total (149,211,166 lire) the greater proportion (129,898,338) belonged to the Two Sicilies and 16,815,207 to Rome. In 1866 the Government felt itself constrained to establish a forced paper currency; the proposals made from time to time for its abrogation remained mere proposals till 1881. The parliament of that year, however, passed an Act (7th April), on the basis of a bill presented by the ministers Magliani and Miceli, of which the chief features are as follows:—The forced currency is to be brought to an end by the close of 1883,—644,000,000 lire of metallic money (400,000,000 of the amount in gold being obtained by a foreign loan); of these, 44,000,000 lire to be given to the National Bank as repayment of the loan in gold made to the state in 1875, which, according to the contract, was to be repaid three months before the cessation of the forced currency; the remaining 600,000,000 to be employed in withdrawing from circulation that amount of the "consortial" or union notes, of which 940,000,000 lire are in circulation,—the 340,000,000 to become regular Government notes payable at sight in the principal Government treasuries; all the small notes of 50 centesimi, 1, 2, and 5 lire, the circulation of which in September 1879 amounted to 315,500,000 lire, to be got rid of, as well as 284,000,000 in notes of 1000, 250, and 100 lire,—so that the 340,000,000 lire in regular notes left in existence should all be of the value of 10 and 20 lire, with the exception of 46,500,000 in larger amounts. The consortium of the banks came to a close on the 30th June 1881, and the "consortial" notes actually current are formed into a direct national debt.

*Titles of Honour.*—The recent existence of so many separate sovereignties and "fountains of honour" as a matter of course gave rise to a great many hereditary titles of nobility. There are 400 princes, 458 dukes, 985 marquises, 1679 counts, 353 barons, and 5 viscounts in the country; as well as 1234 persons of "patrician" rank, 2273 with a right to the designation *nobile*, 318 distinctively *signori*, and 64 hereditary knights or cavalieri in the kingdom. In the "Golden Book of the Capitol" (*Libro d'Oro del Campidoglio*) are inscribed 321 patrician families, and of these 28 have the title of prince and 8 that of duke, while the others are marquises, counts, or simply patricians. Five orders of knighthood are recognized:—the order of the Annunciation (*Ordine Supremo dell' Annunziata*), which dates from 1362, the order of St Maurice and St Lazarus (1434), the military order of Savoy (1815), the civil order of Savoy (1833), and the order of the Crown of Italy, instituted in 1868. The king's brother is duke of Aosta, his eldest son is prince of Naples, and his cousin is duke of Genoa.

*Bibliography.*—The most elaborate work on Italy is *L'Italia sotto l'aspetto fisico, storico, &c.*, published by Vallardi of Milan, and comprising (1) *Dizionario Geografico*, edited by Amato Amati, 9 vols. Imp. 8vo., of upwards of 2100 pages each; (2) *Geologia d'Italia*, by Stoppani and Negri; (3) *Oro-idrografia*, by De Bartolomeis; (4) *Acque minerali*, by Marletti; (5) *Compendio della flora italiana*, by Cesati, Passerini, and Ghiselli; (6) *Fauna d'Italia*, by Cornalia, Canestrini, Salvadori, and De-Betta; (7) a series of historical studies—*Storia antica e I Barbari*, by Bertolini; *I Comuni*, by Lanzano, &c. Some of these divisions are only in course of publication (1881), but the *Dizionario Geografico* and several other important sections are either complete or approaching completion. Work in its own department to rank with this great work is Giacomo Cantoni's *Enciclopedia agraria italiana*, which contains voluminous articles on the various subjects and methods of agriculture in the country, on its climate, soils, irrigation systems, and the like. The chief agricultural periodicals are the *Government Annali di Agricoltura*, edited by Tagliani-Tozzetti, and the *L'Agricoltura Italiana*, formerly *Rivista di Agricoltura*. The publications of the Government board of statistics, frequently referred to in the foregoing pages, are numerous and various. The *Annuario Statistico* (vol. II., 1881) contains an epitome of the various official reports. Questions both of national and international scope are discussed in the *Annali di Statistica* (new series dating from 1878), and in the *Archivio di Statistica*, founded by Professor Bodio and a company of statisticians in 1871. Of non-Government statistical publications there is no lack. It is sufficient to mention *Annuario del commercio ed industria del regno d'Italia*, Florence, 1868, &c.; *Annuario statistico delle provincie italiane*, Florence, 1872; *Annuario storico italiano*, Milan, 1870, &c.; *Guida generale del commercio e dell'industria italiana*, Milan, 1880; *Annuario industriale italiano*, Naples, 1880; *Parola, Saggio di etimologia e di geografia nosologica dell'Italia*, Turin, 1881. Gazetteers of less scope than Amati's *Dizionario* are Muzzi, *Vocabolario geografico-storico-statistico*, Bologna, 1873-74; Altavilla, *Il Regno d'Italia*, Turin, 1875; and Silvieri, *Geogr. e statistica comm. del regno d'Italia*, Venice, 1879. Contributions to Italian geography and sociology naturally appear from time to time in the *Bollettino* of the Italian Geogr. Soc., Rome, 1870; in Guido Cora's *Cosmos*, Turin, 1872, &c.; the *Rivista Europea*, Florence; and the *Nuova Antologia*, Florence; but to mention the periodical publications of scientific societies so well known as the *Accademia dei Lincei*, &c. The literature issued in foreign countries in regard to Italy is very extensive, but too frequently the works are slight and "occasional." A bibliography of German contributions to the subject was compiled by Gregorovius, whose own works make no small addition to the list. Recent English works are Wordsworth, *Italy: Journal of a Tour*, London, 1863; W. W. Story, *Roba di Roma*, London, 1863, and *Graffiti d'Italia*, 1868; Elliot, *Diary in Italy*, London, new ed., 1871; Beckwith, *Roba d'Italia*, London, 1875; Gallenga, *Italy Revisited*, London, 1875; Bare, *Italian Cities*, London, 1876; Arthur, *Italy in Transition*, London, 1877.

TABLE LI.—Value (in lire) of Coins withdrawn from circulation from 1862 to 1871.

	Gold.	Silver.	Copper.
Two Sicilies .....	1,507,779	205,276,668	16,205,485
Lombardy .....	101,503	7,080,850	950,037
Modena.....	...	454,589	1,552
Farma and Piacenza .....	368,025	795,327	45,781
Rome.....	429	9,086,898	4,922,251
Marches and Umbria.....	18,782,331	84,684,646	1,876,720
Sardinia .....	6,361,980	17,981,385	2,752,801
Tuscany.....	48,473	84,899,880	814,748
Venice.....	31,055	11,959,083	771,165
900 Milesimi Coins.....	...	10,924,860	...
Foreign .....	89,957	18,644,666	...
	27,29	396,268,967	28,340,644

\* Much interesting matter on the whole commercial condition of Italy is to be found in this Act.

(H. A. W.)

## PART II.—HISTORY.

The difficulty of Italian history lies in this that until our own time the Italians have had no political unity, no independence, no organized existence as a nation. Split up into numerous and mutually hostile communities, they never, through the fourteen centuries which have elapsed since the end of the old Western empire, shook off the yoke of foreigners completely; they never until lately learned to merge their local and conflicting interests in the common good of undivided Italy. Their history is therefore not the history of a single people, centralizing and absorbing its constituent elements by a process of continued evolution, but of a group of cognate populations, exemplifying divers types of constitutional development.

Without attaching undue importance to the date 476 as marking the boundary between ancient and modern history, there is no doubt that this year opened a new age for the Italian people. Odovakar, a chief of the Herulians, deposed Romulus, the last Augustus of the West, and placed the peninsula beneath the titular sway of the Byzantine emperors. At Pavia the barbarian conquerors of Italy proclaimed him king, and he received from Zeno the dignity of Roman patrician. Thus began that system of mixed government, Teutonic and Roman, which, in the absence of a national monarch, impressed the institutions of new Italy from the earliest date with dualism. The same revolution vested supreme authority in a non-resident and inefficient autocrat, whose title gave him the right to interfere in Italian affairs, but who lacked the power and will to rule the people for his own or their advantage. Odovakar inaugurated that long series of foreign rulers—Greeks, Franks, Germans, Spaniards, and Austrians—who have successively contributed to the misgovernment of Italy from distant seats of empire.

*Gothic and Lombard Kingdoms.*

In 488 Theodoric, king of the East Goths, received commission from the Greek emperor, Zeno, to undertake the affairs of Italy. He defeated Odovakar, drove him to Ravenna, besieged him there, and in 493 completed the conquest of the country by murdering the Herulian chief with his own hand. Theodoric respected the Roman institutions which he found in Italy, held the Eternal City sacred, and governed by ministers chosen from the Roman population. He settled at Ravenna, which had been the capital of Italy since the days of Honorius, and which still testifies by its monuments to the Gothic chieftain's Romanizing policy. Those who believe that the Italians would have gained strength by unification in a single monarchy must regret that this Gothic kingdom lacked the elements of stability. The Goths, except in the valley of the Po, resembled an army of occupation rather than a people numerous enough to blend with the Italic stock. Though their rule was favourable to the Romans, they were Arians; and religious differences, combined with the pride and jealousies of a nation accustomed to imperial honours, rendered the inhabitants of Italy eager to throw off their yoke. When, therefore, Justinian undertook the reconquest of Italy, his generals, Belisarius and Narses, were supported by the south. The struggle of the Greeks and the Goths was carried on for fourteen years, between 539 and 553, when Teia, the last Gothic king, was finally defeated in a bloody battle near Vesuvius. At its close the provinces of Italy were placed beneath Greek dukes, controlled by a governor-general, entitled exarch, who ruled in the Byzantine emperor's name at Ravenna.

This new settlement lasted but a few years. Narses had

employed Lombard auxiliaries in his campaigns against the Goths; and when he was recalled by an insulting message from the empress in 565, he is said to have invited this fiercest and rudest of the Teutonic clans to seize the spoils of Italy. Be this as it may, the Lombards, their ranks swelled by the Gepidæ, whom they had lately conquered, and by the wrecks of other barbarian tribes, passed southward under their king Alboin in 568. The Herulian invaders had been but a band of adventurers; the Goths were an army; the Lombards, far more formidable, were a nation in movement. Pavia offered stubborn resistance; but after a three years' siege it was taken, and Alboin made it the capital of his new kingdom.

In order to understand the future history of Italy, it is necessary to form a clear conception of the method pursued by the Lombards in their conquest. Penetrating the peninsula, and advancing like a glacier or half-liquid stream of mud, they occupied the valley of the Po, and moved slowly downward through the centre of the country. Numerous as they were compared with their Gothic predecessors, they had not strength or multitude enough to occupy the whole peninsula. Venice, which since the days of Attila had offered an asylum to Roman refugees from the northern cities, was left untouched. So was Genoa with its Riviera. Ravenna, entrenched within her lagoons, remained a Greek city. Rome, protected by invincible prestige, escaped. The sea-coast cities of the south, and the islands, Sicily, Sardinia, and Corsica, preserved their independence. Thus the Lombards neither occupied the extremities nor subjugated the brain-centre of the country. The strength of Alboin's kingdom was in the north; his capital, Pavia. As his people pressed southward, they omitted to possess themselves of the coasts; and what was worse for the future of these conquerors, the original impetus of the invasion was checked by the untimely murder of Alboin in 573. After this event, the semi-independent chiefs of the Lombard tribe, who borrowed the title of dukes from their Roman predecessors, seem to have been contented with consolidating their power in the districts each had occupied. The duchies of Spoleto in the centre, and of Benevento in the south, inserted wedge-like into the middle of the peninsula, and enclosing independent Rome, were but loosely united to the kingdom at Pavia. Italy was broken up into districts, each offering points for attack from without, and fostering the seeds of internal revolution. Three separate capitals must be discriminated—Pavia, the seat of the new Lombard kingdom; Ravenna, the garrison city of the Byzantine emperor; and Rome, the rallying point of the old nation, where the successor of St Peter was already beginning to assume that national protectorate which proved so influential in the future.

It is not necessary to write the history of the Lombard kingdom in detail. Suffice it to say that the rule of the Lombards proved at first far more oppressive to the native population, and was less intelligent of their old customs, than that of the Goths had been. Wherever the Lombards had the upper hand, they placed the country under military rule, resembling in its general character what we now know as the feudal system. Though there is reason to suppose that the Roman laws were still administered within the cities, yet the Lombard code was that of the kingdom; and the Lombards being Arians, they added the oppression of religious intolerance to that of martial despotism and barbarous cupidity. The Italians were reduced to the last extremity when Gregory the Great

The Lombards in Italy.



(590-604), having strengthened his position by diplomatic relations with the duchy of Spoleto, and brought about the conversion of the Lombards to orthodoxy, raised the cause of the remaining Roman population throughout Italy. The fruit of his policy, which made of Rome a counterpoise against the effete empire of the Greeks upon the one hand and against the pressure of the feudal kingdom on the other, was seen in the succeeding century. When Leo the Isaurian published his decrees against the worship of images in 726, Gregory II. allied himself with Liudprand, the Lombard king, threw off allegiance to Byzantium, and established the autonomy of Rome. This pope initiated the dangerous policy of playing one hostile force off against another with a view to securing independence. He used the Lombards in his struggle with the Greeks, leaving to his successors the duty of checking these unnatural allies. This was accomplished by calling the Franks in against the Lombards. Liudprand pressed hard, not only upon the Greek dominions of the exarchate, but also upon Rome. His successors, Rachis and Astolf, attempted to follow the same game of conquest. But the popes, Gregory III., Zachary, and Stephen II., determining at any cost to espouse the national cause and to aggrandize their own office, continued to rely upon the Franks. Pippin twice crossed the Alps, and forced Astolf to relinquish his acquisitions, including Ravenna, Pentapolis, the coast towns of Romagna, and some cities in the duchy of Spoleto. These he handed over to the pope of Rome. This donation of Pippin in 756 confirmed the papal see in the protectorate of the Italic party, and conferred upon it sovereign rights. The virtual outcome of the contest carried on by Rome since the year 726 with Byzantium and Pavia was to place the popes in the position held by the Greek exarch, and to confirm the limitation of the Lombard kingdom. We must, however, be cautious to remember that the south of Italy was comparatively unaffected. The dukes of the Greek empire and the Lombard dukes of Benevento, together with a few autonomous commercial cities, still divided Italy below the Campagna of Rome.

*Frankish Emperors.*

Charles the Great and the Carolingians. The Franko-Papal alliance, which conferred a crown on Pippin and sovereign rights upon the see of Rome, held within itself that ideal of mutually supporting papacy and empire which exercised so powerful an influence in mediæval history. When Charles the Great (Charlemagne) deposed his father-in-law Desiderius, the last Lombard king, in 774, and when he received the circlet of the empire from Leo III. at Rome in 800, he did but complete and ratify the compact offered to his grandfather, Charles Martel, by Gregory III. The relations between the new emperor and the pope were ill defined; and this proved the source of infinite disasters to Italy and Europe in the sequel. But for the moment each seemed necessary to the other; and that sufficed. Charles took possession of the kingdom of Italy, as limited by Pippin's settlement. The pope was confirmed in his rectorship of the cities ceded by Astolf, with the further understanding, tacit rather than expressed, that, even as he had wrung these provinces for the Italic people from both Greeks and Lombards, so in the future he might claim the protectorate of such portions of Italy, external to the kingdom, as he should be able to acquire. This, at any rate, seems to be the meaning of that obscure re-settlement of the peninsula which Charles effected. The kingdom of Italy, transmitted on his death by Charles the Great, and afterwards confirmed to his grandson Lothar by the peace of Verdun in 843, stretched from the Alps to Terracina. The duchy of Benevento remained tributary, but independent. The cities of Gaeta and Naples, Sicily, and the so-called Theme of Lombardy in

South Apulia and Calabria, still recognized the Byzantine emperor. Venice stood aloof, professing a nominal allegiance to the East. The parcels into which the Lombards had divided the peninsula remained thus virtually unaltered, except for the new authority acquired by the see of Rome.

Internally Charles left the affairs of the Italian kingdom much as he found them, except that he appears to have pursued the policy of breaking up the larger fiefs of the Lombards, substituting counts for their dukes, and adding to the privileges of the bishops. We may reckon these measures among the earliest advantages extended to the cities, which still contained the bulk of the old Roman population, and which were destined to intervene with decisive effect two centuries later in Italian history. It should also here be noticed that the changes introduced into the holding of the fiefs, whether by altering their boundaries or substituting Frankish for Lombard vassals, were chief among the causes why the feudal system took no permanent hold in Italy. Feudalism was not at any time a national institution. The hierarchy of dukes and marquises and counts consisted of foreign soldiers imposed on the indigenous inhabitants; and the rapid succession of conquerors, Lombards, Franks, and Germans following each other at no long interval, and each endeavouring to weaken the remaining strength of his predecessor, prevented this alien hierarchy from acquiring fixity by permanence of tenure. Among the many miseries inflicted upon Italy by the frequent changes of her northern rulers, this at least may be reckoned a blessing.

The Italians acknowledged eight kings of the house of Frankish and Italian kings. Charles the Great, ending in Charles the Fat, who was deposed in 888. After them followed ten sovereigns, some of whom have been misnamed Italians by writers too eager to catch at any resemblance of national glory for a people passive in the hands of foreign masters. The truth is that no period in Italian history was less really glorious than that which came to a close in 961 by Berengar II.'s cession of his rights to Otto the Great. It was a period marked in the first place by the conquests of the Saracens, who began to occupy Sicily early in the 9th century, overran Calabria and Apulia, took Bari, and threatened Rome. In the second place it was marked by a restoration of the Greeks to power. In 890 they established themselves again at Bari, and ruled the Theme of Lombardy by means of an officer entitled *Catapan*. In the third place it was marked by a decline of good government in Rome. Early in the 10th century the papacy fell into the hands of a noble family, known eventually as the counts of Tusculum, who almost succeeded in rendering the office hereditary, and in uniting the civil and ecclesiastical functions of the city under a single member of their house. It is not necessary to relate the scandals of Marozia's and Theodora's female reign, the infamies of John XII., or the intrigues which tended to convert Rome into a duchy. The most important fact for the historian of Italy to notice is that during this time the popes abandoned, not only their high duties as chiefs of Christendom, but also their protectorate of Italian liberties. A fourth humiliating episode in this period was the invasion of the Magyar barbarians, who overran the north of Italy, and reduced its fairest provinces to the condition of a wilderness. Anarchy and misery are indeed the main features of that long space of time which elapsed between the death of Charles the Great and the descent of Otto. Through the almost impenetrable darkness and confusion we only discern this much, that Italy was powerless to constitute herself a nation.

The discords which followed on the break-up of the Carolingian power, and the weakness of the so-called Italian emperors, who were unable to control the feudatories

marquises of Ivrea and Tuscany, dukes of Friuli and Spoleto), from whose ranks they sprang, exposed Italy to ever-increasing misrule. The country by this time, had become thickly covered over with castles, the seats of greater or lesser nobles, all of whom were eager to detach themselves from strict allegiance to the "Regno." The cities, exposed to pillage by Huns in the north and Saracens in the south, and ravaged on the coast by Norse pirates, asserted their right to enclose themselves with walls, and taught their burghers the use of arms. Within the circuit of their ramparts, the bishops already began to exercise authority in rivalry with the counts, to whom, since the days of Theodoric, had been entrusted the government of the Italian burghs. Agreeably to feudal customs, these nobles, as they grew in power, retired from the town, and built themselves fortresses on points of vantage in the neighbourhood. Thus the titular king of Italy found himself simultaneously at war with those great vassals who had chosen him from their own class, with the turbulent factions of the Roman aristocracy, with unruly bishops in the growing cities, and with the multitude of minor counts and barons who occupied the open lands, and who changed sides according to the interests of the moment. The last king of the quasi-Italian succession, Berengar II., marquis of Ivrea (951-961), made a vigorous effort to restore the authority of the regno; and had he succeeded, it is not impossible that now at the last moment Italy might have become an independent nation. But this attempt at unification was reckoned to Berengar for a crime. He only won the hatred of all classes, and was represented by the obscure annalists of that period as an oppressor of the church and a remorseless tyrant. In Italy, divided between feudal nobles and almost hereditary ecclesiastics, of foreign blood and alien sympathies, there was no national feeling. Berengar stood alone against a multitude, unanimous in their intolerance of discipline. His predecessor in the kingdom, Lothar, had left a young and beautiful widow, Adelheid. Berengar imprisoned her upon the Lake of Como, and threatened her with a forced marriage to his son Adalbert. She escaped to the castle of Canossa, where the great count of Tuscany espoused her cause, and appealed in her behalf to Otto the Saxon. The king of Germany descended into Italy, and took Adelheid in marriage. After this episode Berengar was more discredited and impotent than ever. In the extremity of his fortunes he had recourse himself to Otto, making a formal cession of the Italian kingdom, in his own name and that of his son Adalbert, to the Saxon as his overlord. By this slender tie the crown of Italy was joined to that of Germany; and the formal right of the elected king of Germany to be considered king of Italy and emperor may be held to have accrued from this epoch.

#### *The German Emperors.*

Berengar gained nothing by his act of obedience to Otto. The great Italian nobles, in their turn, appealed to Germany. Otto entered Lombardy in 961, deposed Berengar, assumed the crown in St Ambrogio at Milan, and in 962 was proclaimed emperor by John XII. at Rome. Henceforward Italy changed masters according as one or other of the German families assumed supremacy beyond the Alps. It is one of the strongest instances furnished by history of the fascination exercised by an idea that the Italians themselves should have grown to glory in this dependence of their nation upon Cæsars who had nothing but a name in common with the Roman Emperor of the past.

The first thing we have to notice in this revolution which placed Otto the Great upon the imperial throne is that the Italian kingdom, founded by the Lombards, recognized by

the Franks, and recently claimed by eminent Italian feudatories, virtually ceased to exist. It was merged in the German kingdom; and, since for the German princes Germany was of necessity their first care, Italy from this time forward began to be left more and more to herself. The central authority of Pavia had always been weak; the regno had proved insufficient to combine the nation. But now even that shadow of union disappeared, and the Italians were abandoned to the slowly working influences which tended to divide them into separate states. The most brilliant period of their chequered history, the period which includes the rise of communes, the exchange of municipal liberty for despotism, and the gradual discrimination of the five great powers (Milan, Venice, Florence, the Papacy, and the kingdom of Naples), now begins. Among the centrifugal forces which determined the future of the Italian race must be reckoned, first and foremost, the new spirit of municipal independence. We have seen how the cities enclosed themselves with walls, and how the bishops defined their authority against that of the counts. Otto encouraged this revolution by placing the enclosures of the chief burghs beyond the jurisdiction of the counts. Within those precincts the bishops and the citizens were independent of all feudal masters but the emperor. He further broke the power of the great vassals by redvisions of their feuds, and by the creation of new marches which he assigned to his German followers. In this way, owing to the dislocation of the ancient aristocracy, to the enlarged jurisdiction of a power so democratic as the episcopate, and to the increased privileges of the burghs, feudalism received a powerful check in Italy. The Italian people, that people which gave to the world the commerce and the arts of Florence, was not indeed as yet apparent. But the conditions under which it could arise, casting from itself all foreign and feudal trammels, recognizing its true past in ancient Rome, and reconstructing a civility out of the ruins of those glorious memories, were now at last granted. The nobles from this time forward retired into the country and the mountains, fortified themselves in strong places outside the cities, and gave their best attention to fostering the rural population. Within the cities and upon the open lands the Italians, in this and the next century, doubled, trebled, and quadrupled their numbers. A race was formed strong enough to keep the empire itself in check, strong enough, except for its own internecine contests, to have formed a nation equal to its happier neighbours.

The recent scandals of the papacy induced Otto to deprive the Romans of their right to elect popes. But when he died in 973, his son Otto II. (married to Theophano of the imperial Byzantine house) and his grandson, Otto III., who descended into Italy in 996, found that the affairs of Rome and of the southern provinces were more than even their imperial powers could cope with. The faction of the counts of Tusculum raised its head from time to time in the Eternal City, and Rome still claimed to be a commonwealth. Otto III.'s untimely death in 1002 introduced new discords. Rome fell once more into the hands of her nobles. The Lombards chose Ardoin, marquis of Ivrea, for king, and Pavia supported his claims against those of Henry of Bavaria, who had been elected in Germany. Milan sided with Henry; and this is perhaps the first eminent instance of cities being reckoned powerful allies in the Italian disputes of sovereigns. It is also the first instance of that bitter feud between the two great capitals of Lombardy, a feud rooted in ancient antipathies between the Roman population of Mediolanum and the Lombard garrison of Alboin's successors, which proved so disastrous to the national cause. Ardoin retired to a monastery, where he died in 1015. Henry nearly destroyed Pavia, was crowned in Rome, and died in 1024. After this event



Heribert, the archbishop of Milan, invited Conrad, the Franconian king of Germany, into Italy, and crowned him with the iron crown of the kingdom.

Heribert  
and the  
Lombard  
burghs.

The intervention of this man, Heribert, compels us to turn a closer glance upon the cities of North Italy. It is here, at the present epoch and for the next two centuries, that the pith and nerve of the Italian nation must be sought; and among the burghs of Lombardy, Milan, the eldest daughter of ancient Rome, assumes the lead. In Milan we hear for the first time the word *Comune*. In Milan the citizens first form themselves into a *Parlamento*. In Milan the archbishop organizes the hitherto voiceless, defenceless population into a community capable of expressing its needs, and an army ready to maintain its rights. To Heribert is attributed the invention of the *Carroccio*, which played so singular and important a part in the warfare of Italian cities. A huge car drawn by oxen, bearing the standard of the burgh, and carrying an altar with the host, this carroccio, like the ark of the Israelites, formed a rallying point in battle, and reminded the armed artisans that they had a city and a church to fight for. That Heribert's device proved effectual in raising the spirit of his burghers, and consolidating them into a formidable band of warriors, is shown by the fact that it was speedily adopted in all the free cities. It must not, however, be supposed that at this epoch the liberties of the burghs were fully developed. The mass of the people remained unrepresented in the government; and even if the consuls existed in the days of Heribert, they were but humble legal officers, transacting business for their constituents in the courts of the bishop and his viscount. It still needed nearly a century of struggle to render the burghers independent of lordship, with a fully organized commune, self-governed in its several assemblies. While making these reservations, it is at the same time right to observe that certain Italian communities were more advanced upon the path of independence than others. This is specially the case with the maritime ports. Not to mention Venice, which has not yet entered the Italian community, and remains a Greek free city, Genoa and Pisa were rapidly rising into ill-defined autonomy. Their command of fleets gave them incontestable advantages, as when, for instance, Otto II. employed the Pisans in 980 against the Greeks in Lower Italy, and the Pisans and Genoese together attacked the Saracens of Sardinia in 1017. Still, speaking generally, the age of independence for the burghs had only begun when Heribert from Milan undertook the earliest organization of a force that was to become paramount in peace and war.

Rome.

Next to Milan, and from the point of view of general politics even more than Milan, Rome now claims attention. The destinies of Italy depended upon the character which the see of St Peter should assume. Even the liberties of her republics in the north hung on the issue of a contest which in the 11th and 12th centuries shook Europe to its furthest boundaries. So fatally were the internal affairs of that magnificent but unhappy country bound up with concerns which brought the forces of the civilized world into play. Her ancient prestige, her geographical position, and the intellectual primacy of her most noble children rendered Italy the battleground of principles that set all Christendom in motion, and by the clash of which she found herself for ever afterwards divided. During the reign of Conrad II., the party of the counts of Tusculum revived in Rome; and Crescentius, claiming the title of consul in the imperial city, sought once more to control the election of the popes. When Henry III., the son of Conrad, entered Italy in 1046, he found three popes in Rome. These he abolished, and, taking the appointment into his own hands, gave German bishops to the see. The policy

thus initiated upon the precedent laid down by Otto the Great was a remedy for pressing evils. It saved Rome from becoming a duchy in the hands of the Tuscan house. But it neither raised the prestige of the papacy, nor could it satisfy the Italians, who rightly regarded the Roman see as theirs. These German popes were short-lived and inefficient. Their appointment, according to notions which defined themselves within the church at this epoch, was simoniacal; and during the long minority of Henry IV., who succeeded his father in 1056, the terrible Tuscan monk, Hildebrand of Soana, forged weapons which he used with deadly effect against the presumption of the empire. The condition of the church seemed desperate, unless it could be purged of crying scandals—of the subjection of the papacy to the great Roman nobles, of its subordination to the German emperor, and of its internal demoralization. It was Hildebrand's policy throughout three papacies, during which he controlled the counsels of the Vatican, and before he himself assumed the tiara, to prepare the mind of Italy and Europe for a mighty change. His programme included these three points:—(1) the celibacy of the clergy; (2) the abolition of ecclesiastical appointments made by the secular authority; (3) the vesting of the papal election in the hands of the Roman clergy and people, presided over by the curia of cardinals. How Hildebrand paved the way for these reforms during the pontificates of Nicholas II. and Alexander II., how he succeeded in raising the papal office from the depths of degradation and subjection to illimitable sway over the minds of men in Europe, and how his warfare with the empire established on a solid basis the still doubtful independence of the Italian burghs, renewing the long neglected protectorate of the Italian race, and bequeathing to his successors a national policy which had been forgotten by the popes since his great predecessor Gregory II., forms a chapter in European history which must now be interrupted. We have to follow the fortunes of unexpected allies, upon whom in no small measure his success depended.

In order to maintain some thread of continuity through the perplexed and tangled vicissitudes of the Italian race, it has been necessary to disregard those provinces which did not immediately contribute to the formation of its history. For this reason we have left the whole of the south up to the present point unnoticed. Sicily in the hands of the Mussulmans, the Theme of Lombardy abandoned to the weak suzerainty of the Greek catapans, the Lombard duchy of Benevento slowly falling to pieces, and the maritime republics of Naples, Gaeta, and Amalfi extending their influence by commerce in the Mediterranean, were in effect detached from the Italian regno, beyond the jurisdiction of Rome, included in no parcel of Italy proper. But now the moment had arrived when this vast group of provinces, forming the future kingdom of the Two Sicilies, was about to enter definitely and decisively within the bounds of the Italian community. Some Norman adventurers, on pilgrimage to St Michael's shrine on Monte Gargano, lent their swords in 1017 to the Lombard cities of Apulia against the Greeks. Twelve years later we find the Normans settled at Aversa under their Count Rainulf. From this station as a centre the little band of adventurers, playing the Greeks off against the Lombards, and the Lombards against the Greeks, spread their power in all directions, until they made themselves the most considerable force in southern Italy. William of Hauteville was proclaimed count of Apulia. His half-brother, Robert Wiskard or Guiscard, after defeating the papal troops at Civitella in 1053, received from Leo IX. the investiture of all present and future conquests in Apulia, Calabria, and Sicily, which he agreed to hold as fiefs of the Holy See. Nicholas II. ratified this grant, and confirmed the title of

Norman  
conquest  
of the  
Two  
Sicilies.

count. Having consolidated their possessions on the mainland, the Normans, under Robert Guiscard's brother, the great Count Roger, undertook the conquest of Sicily in 1060. After a prolonged struggle of thirty years, they wrested the whole island from the Saracens; and Roger, dying in 1101, bequeathed to his son Roger a kingdom in Calabria and Sicily second to none in Europe for wealth and magnificence. This while, the elder branch of the Hauteville family still held the title and domains of the Apulian duchy; but in 1127, upon the death of his cousin Duke William, Roger united the whole of the future realm. In 1130 he assumed the style of king of Sicily, inscribing upon his sword the famous hexameter—

*Appulus et Calaber Siculus mihi servit et Afer.*

This Norman conquest of the two Sicilies forms the most romantic episode in mediæval Italian history. By the consolidation of Apulia, Calabria, and Sicily into a powerful kingdom, by checking the growth of the maritime republics, and by recognizing the over-lordship of the papal see, the house of Hauteville influenced the destinies of Italy with more effect than any of the princes who had previously dealt with any portion of the peninsula. Their kingdom, though Naples was from time to time separated from Sicily, never quite lost the cohesion they had given it; and all the disturbances of equilibrium in Italy were due in after days to papal manipulation of the rights acquired by Robert Guiscard's act of homage. The southern regno, in the hands of the popes, proved an insurmountable obstacle to the unification of Italy, led to French interference in Italian affairs, introduced the Spaniard, and maintained in those rich southern provinces the reality of feudal sovereignty long after this alien element had been eliminated from the rest of Italy.

For the sake of clearness, we have anticipated the course of events by nearly a century. We must now return to the date of Hildebrand's elevation to the papacy in 1073, when he chose the memorable name of Gregory VII. In the next year after his election Hildebrand convened a council, and passed measures enforcing the celibacy of the clergy. In 1075 he caused the investiture of ecclesiastical dignitaries by secular potentates of any degree to be condemned. These two reforms, striking at the most cherished privileges and most deeply-rooted self-indulgences of the aristocratic caste in Europe, inflamed the bitterest hostility. Henry IV., king of Germany, but not crowned emperor, convened a diet in the following year at Worms, where Gregory was deposed and excommunicated. The pope followed with a counter excommunication, far more formidable, releasing the king's subjects from their oaths of allegiance. War was thus declared between the two chiefs of Western Christendom, that war of investitures which outlasted the lives of both Gregory and Henry, and was not terminated till the year 1122. The dramatic episodes of this struggle are too well known to be enlarged upon. In his single-handed duel with the strength of Germany, Gregory received material assistance from the Countess Matilda of Tuscany. She was the last heiress of the great house of Canossa, whose fiefs stretched from Mantua across Lombardy, passed the Apennines, included the Tuscan plains, and embraced a portion of the duchy of Spoleto. It was in her castle of Canossa that Henry IV. performed his three days' penance in the winter of 1077; and there she made the cession of her vast domains to the church. That cession, renewed after the death of Gregory to his successors, conferred upon the popes indefinite rights, of which they afterwards availed themselves in the consolidation of their temporal power. Matilda died in the year 1115. Gregory had passed before her from the scene of his contest, an exile at Salerno, whither Robert Wiscard

carried him in 1084 from the anarchy of rebellious Rome. With unbroken spirit, though the objects of his life were unattained, though Italy and Europe had been thrown into confusion, and the issue of the conflict was still doubtful, Gregory expired in 1085 with these words on his lips: "I loved justice, I hated iniquity, therefore in banishment I die."

The greatest of the popes thus breathed his last; but the new spirit he had communicated to the papacy was not destined to expire with him. Gregory's immediate successors, Victor III., Urban II., and Paschal II., carried on his struggle with Henry IV. and his imperial anti-popes, encouraging the emperor's son to rebel against him, and stirring up Europe for the first crusade. When Henry IV. died, his own son's prisoner, in 1106, Henry V. crossed the Alps, entered Rome, wrung the imperial coronation from Paschal II., and compelled the pope to grant his claims on the investitures. Scarcely had he returned to Germany when the Lateran disavowed all that the pope had done, on the score that it had been extorted by force. France sided with the church. Germany rejected the bull of investiture. A new descent into Italy, a new seizure of Rome, proved of no avail. The emperor's real weakness was in Germany, where his subjects openly expressed their discontent. He at last abandoned the contest which had distracted Europe. By the concordat of Worms, 1122, the emperor surrendered the right of investiture by ring and staff, and granted the right of election to the clergy. The popes were henceforth to be chosen by the cardinals, the bishops by the chapters subject to the pope's approval. On the other hand the pope ceded to the emperor the right of investiture by the sceptre. But the main issue of the struggle was not in these details of ecclesiastical government; principles had been at stake far deeper and more widely reaching. The respective relations of pope and emperor, ill-defined in the compact between Charles the Great and Leo III., were brought in question, and the two chief potentates of Christendom, no longer tacitly concordant, stood against each other in irreconcilable rivalry. Upon this point, though the battle seemed to be a drawn one, the popes were really victors. They remained independent of the emperor, but the emperor had still to seek the crown at their hands. The pretensions of Otto the Great and Henry III. to make popes were gone for ever.

#### *Age of the Communes.*

The final gainers, by the war of investitures <sup>else of free cities.)</sup> were the Italians. In the first place, from this time forward, owing to the election of popes by the Roman curia, the Holy See remained in the hands of Italians; and this, though it was by no means an unmixed good, was a great glory to the nation. In the next place, the antagonism of the popes to the emperors, which became hereditary in the Holy College, forced the former to assume the protectorate of the national cause. But by far the greatest profit the Italians reaped was the emancipation of their burghs. During the forty-seven years' war, when pope and emperor were respectively bidding for their alliance, and offering concessions to secure their support, the communes grew in self-reliance, strength, and liberty. As the bishops had helped to free them from subservience to their feudal masters, so the war of investitures relieved them of dependence on their bishops. The age of real autonomy, signalized by the supremacy of consuls in the cities, had arrived.

In the republics, as we begin to know them after the war of investitures, government was carried on by officers called consuls, varying in number according to custom and according to the division of the town into districts. These magistrates, as we have already seen, were originally appointed to control and protect the humbler classes. But,



in proportion as the people gained more power in the field the consuls rose into importance, superseded the bishops, and began to represent the city in transactions with its neighbours. Popes and emperors, who needed the assistance of a city, had to seek it from the consuls, and thus these officers gradually converted an obscure and indefinite authority into what resembles the presidency of a commonwealth. They were supported by a deliberative assembly, called *credenza*, chosen from the more distinguished citizens. In addition to this privy council, we find a *gran consiglio*, consisting of the burghers who had established the right to interfere immediately in public affairs, and a still larger assembly called *parlamento*, which included the whole adult population. Though the institutions of the communes varied in different localities, this is the type to which they all approximated. It will be perceived that the type was rather oligarchical than strictly democratic. Between the *parlamento* and the consuls with their privy council, or *credenza*, was interposed the *gran consiglio* of privileged burghers. These formed the aristocracy of the town, who by their wealth and birth held its affairs within their custody. There is good reason to believe that, when the term *popolo* occurs, it refers to this body and not to the whole mass of the population. The *comune* included the entire city—bishop, consuls, oligarchy, councils, handicraftsmen, proletariat. The *popolo* was the governing or upper class. It was almost inevitable in the transition from feudalism to democracy that this intermediate ground should be traversed; and the peculiar Italian phrases, *primo popolo*, *secondo popolo*, *terzo popolo*, and so forth, indicate successive changes, whereby the oligarchy passed from one stage to another in its progress toward absorption in democracy or tyranny.

Under their consuls the Italian burghs rose to a great height of prosperity and splendour. Pisa built her Duomo. Milan undertook the irrigation works which enriched the soil of Lombardy for ever. Massive walls, substantial edifices, commodious seaports, good roads, were the benefits conferred by this new government on Italy. It is also to be noticed that the people now began to be conscious of their past. They recognized the fact that their blood was Latin as distinguished from Teutonic, and that they must look to ancient Rome for those memories which constitute a people's nationality. At this epoch the study of Roman law received a new impulse, and this is the real meaning of the legend that Pisa, glorious through her consuls, brought the pandects in a single codex from Amalfi. The very name consul, no less than the Romanizing character of the best architecture of the time, points to the same revival of antiquity.

Republic in Rome. The rise of the Lombard communes produced a sympathetic revolution in Rome, which deserves to be mentioned in this place. A monk, named Arnold of Brescia, animated with the spirit of the Milanese, stirred up the Romans to shake off the temporal sway of their bishop. He attempted, in fact, upon a grand scale what was being slowly and quietly effected in the northern cities. Rome, ever mindful of her antique past, listened to Arnold's preaching. A senate was established, and the republic was proclaimed. The title of patrician was revived and offered to Conrad, king of Italy, but not crowned emperor. Conrad refused it, and the Romans conferred it upon one of their own nobles. Though these institutions borrowed high-sounding titles from antiquity, they were in reality imitations of the Lombard civic system. The patrician stood for the consuls. The senate, composed of nobles, represented the *credenza* and the *gran consiglio*. The pope was unable to check this revolution, which is now chiefly interesting as further proof of the insurgence of the Latin as against the feudal elements in Italy at this period.

Though the communes gained so much by the war of *Monici-* investitures, the division of the country between the pope's *pal warrs*, and emperor's parties was no small price to pay for independence. It inflicted upon Italy the ineradicable curse of party-warfare, setting city against city, house against house, and rendering concordant action for a national end impossible. No sooner had the compromise of the investitures been concluded than it was manifest that the burghers of the now enfranchised communes were resolved to turn their arms against each other. We seek in vain an obvious motive for each separate quarrel. All we know for certain is that, at this epoch, Rome attempts to ruin Tivoli, and Venice Pisa; Milan fights with Cremona, Cremona with Crema, Pavia with Verona, Verona with Padua, Piacenza with Parma, Modena and Reggio with Bologna, Bologna and Faenza with Ravenna and Imola, Florence and Pisa with Lucca and Siena, and so on through the whole list of cities. The nearer the neighbours, the more rancorous and internecine is the strife; and, as in all cases where animosity is deadly and no grave local causes of dispute are apparent, we are bound to conclude that some deeply-seated permanent uneasiness goaded these fast growing communities into rivalry. Italy was, in fact, too small for her children. As the towns expanded, they perceived that they must mutually exclude each other. They fought for bare existence, for primacy in commerce, for the command of seaports, for the keys of mountain passes, for rivers, roads, and all the avenues of wealth and plenty. The pope's cause and the emperor's cause were of comparatively little moment to Italian burghers; and the names of Guelph and Ghibelline, which before long began to be heard in every street, on every market-place, had no meaning for them. These watchwords are said to have arisen in Germany during the disputed succession of the empire between 1135 and 1152, when the Welfs of Bavaria opposed the Swabian princes of Waiblingen origin. But in Italy, although they were severally identified with the papal and imperial parties, they really served as symbols for jealousies which altered in complexion from time to time and place to place, expressing more than antagonistic political principles, and involving differences vital enough to split the social fabric to its foundation.

Under the imperial rule of Lothar the Saxon (1125–1137) *Swabian* and Conrad the Swabian (1138–1152), these civil wars *empe-* increased in violence owing to the absence of authority. *rots.* Neither Lothar nor Conrad was strong at home; the former had no influence in Italy, and the latter never entered Italy at all. But when Conrad died, the electors chose his nephew Frederick, surnamed Barbarossa, who united the rival *Frederick* honours of Welf and Waiblingen, to succeed him; and it was soon obvious that the empire had a master powerful of *Bar-* brain and firm of will. Frederick immediately determined *barossa* and the *Lombard* to reassert the imperial rights in his southern provinces, *ci. ies.* and to check the warfare of the burghs. When he first crossed the Alps in 1154, Lombardy was, roughly speaking, divided between two parties, the one headed by Pavia professing loyalty to the empire, the other headed by Milan ready to oppose its claims. The municipal animosities of the last quarter of a century gave substance to these factions; yet neither the imperial nor the anti-imperial party had any real community of interest with Frederick. He came to supersede self-government by consuls, to deprive the cities of the privilege of making war on their own account, and to extort his regalian rights of forage, food, and lodging for his armies. It was only the habit of inter-urban jealousy which prevented the communes from at once combining to resist demands which threatened their liberty of action, and would leave them passive at the pleasure of a foreign master. The diet was opened at Roncaglia near Piacenza, where Frederick listened to the

complaints of Como and Lodi against Milan, of Pavia against Tortona, and of the marquis of Montferrat against Asti and Chieri. The plaintiffs in each case were imperialists; and Frederick's first action was to redress their supposed grievances. He laid waste Chieri, Asti, and Tortona, then took the Lombard crown at Pavia, and, reserving Milan for a future day, passed southward to Rome. Outside the gates of Rome he was met by a deputation from the senate he had come to supersede, who addressed him in words memorable for expressing the republican spirit of new Italy face to face with autocratic feudalism: "Thou wast a stranger, I have made thee a citizen;" it is Rome who speaks: "Thou camest as an alien from beyond the Alps, I have conferred on thee the principality." Moved only to scorn and indignation by the rhetoric of these presumptuous enthusiasts, Frederick marched into the Leonine city, and took the imperial crown from the hands of Hadrian IV. In return for this compliance, the emperor delivered over to the pope his troublesome rival Arnold of Brescia, who was burned alive by Nicholas Breakspear, the only English successor of St Peter. The gates of Rome itself were shut against Frederick; and even on this first occasion his good understanding with Hadrian began to suffer. The points of dispute between them related mainly to Matilda's bequest, and to the kingdom of Sicily, which the pope had rendered independent of the empire by renewing its investiture in the name of the Holy See. In truth, the papacy and the empire had become irreconcilable. Each claimed illimitable authority, and neither was content to abide within such limits as would have secured a mutual tolerance. Having obtained his coronation, Frederick withdrew to Germany, while Milan prepared herself against the storm which threatened. In the ensuing struggle with the empire, that great city rose to the altitude of patriotic heroism. By their sufferings no less than by their deeds of daring, her citizens showed themselves to be sublime, devoted, and disinterested, winning the purest laurels which give lustre to Italian story. Almost within Frederick's presence, they rebuilt Tortona, punished Pavia, Lodi, Cremona, and the marquis of Montferrat. Then they fortified the Adda and Ticino, and waited for the emperor's next descent. He came in 1158 with a large army, overran Lombardy, raised his imperial allies, and sat down before the walls of Milan. Famine forced the burghers to partial obedience, and Frederick held a victorious diet at Roncaglia. Here the jurists of Bologna appeared, armed with their new lore of Roman law, and expounded Justinian's code in the interests of the German empire. It was now seen how the absolutist doctrines of autocracy developed in Justinian's age at Byzantium would bear fruits in the development of an imperial idea, which was destined to be the fatal mirage of mediæval Italy. Frederick placed judges of his own appointment, with the title of podesta, in all the Lombard communes; and this stretch of his authority, while it exacerbated his foes, forced even his friends to join their ranks against him. The war, meanwhile, dragged on. Crema yielded after an heroic siege in 1160, and was abandoned to the cruelty of its fierce rival Cremona. Milan was invested in 1161, starved into capitulation after nine months' resistance, and given up to total destruction by the Italian imperialists of Frederick's army. So stained and tarnished with the vindictive passions of municipal rivalry was even this, the one great glorious strife of Italian annals! Having ruined his rebellious city, but not tamed her spirit, Frederick withdrew across the Alps. But, in the interval between his second and third visit, a league was formed against him in north-eastern Lombardy. Verona, Vicenza, Padua, Treviso, Venice entered into a compact to defend their liberties; and when he came again

in 1163 with a brilliant staff of German knights, the imperial cities refused to join his standards. This was the first and ominous sign of a coming change.

Meanwhile the election of Alexander III. to the papacy in 1159 added a powerful ally to the republican party. Opposed by an anti-pope whom the emperor favoured, Alexander found it was his truest policy to rely for support upon the anti-imperialist communes. They in return gladly accepted a champion who lent them the prestige and influence of the church. When Frederick once more crossed the Alps in 1166, he advanced on Rome, and besieged Alexander in the Coliseum. But the affairs of Lombardy left him no leisure to persecute a recalcitrant pontiff. In April 1167 a new league was formed between Cremona, Bergamo, Brescia, Mantua, and Ferrara. In December of the same year this league allied itself with the elder Veronese league, and received the addition of Milan, Lodi, Piacenza, Parma, Modena, and Bologna. The famous league of Lombard cities, styled Concordia in its acts of settlement, was now established. Novara, Vercelli, Como, Asti, and Tortona swelled its ranks; only Pavia and Montferrat remained imperialist between the Alps and Apennines. Frederick fled for his life by the Mont Cenis, and in 1168 the town of Alessandria was erected to keep Pavia and the marquisate in check. In the emperor's absence, Ravenna, Rimini, Imola, and Forlì joined the league, which now called itself the "Society of Venice, Lombardy, the March, Romagna, and Alessandria." For the fifth time, in 1174, Frederick entered his rebellious dominions. The fortress town of Alessandria stopped his progress with those mud walls contemptuously named "of straw," while the forces of the league assembled at Modena, and obliged him to raise the siege. In the spring of 1176 Frederick threatened Milan. His army found itself a little to the north of the town near the village of Legnano, when the troops of the city, assisted only by a few allies from Piacenza, Verona, Brescia, Novara, and Vercelli, met and overwhelmed it. The victory was complete. Frederick escaped alone to Pavia, whence he opened negotiations with Alexander. In consequence of these transactions, he was suffered to betake himself unharmed to Venice. Here, as upon neutral ground, the emperor met the pope, and a truce for six years was concluded with the Lombard burghs. Looking back from the vantage-ground of history upon the issue of this long struggle, we are struck with the small results which satisfied the Lombard communes. They had humbled and utterly defeated their foreign lord. They had proved their strength in combination. Yet neither the acts by which their league was ratified nor the terms negotiated for them by their patron Alexander evince the smallest desire of what we now understand as national independence. The name of Italy is never mentioned. The supremacy of the emperor is not called in question. The conception of a permanent confederation, bound together in offensive and defensive alliance for common objects, has not occurred to these hard fighters and stubborn asserters of their civic privileges. All they claim is municipal autonomy; the right to manage their own affairs within the city walls, to fight their battles as they choose, and to follow their several ends unchecked. It is vain to lament that, when they might have now established Italian independence upon a secure basis, they chose local and municipal privileges. Their mutual jealousies, combined with the prestige of the empire, and possibly with the selfishness of the pope, who had secured his own position, and was not likely to foster a national spirit that would have threatened the ecclesiastical supremacy, deprived the Italians of the only great opportunity they ever had of forming themselves into a powerful nation.

When the truce expired in 1183, a permanent peace.



Peace of Constance. was ratified at Constance. The intervening years had been spent by the Lombards, not in consolidating their union, but in attempting to secure special privileges for their several cities. Alessandria della Paglia, glorious by her resistance to the emperor in 1174, had even changed her name to Cesarea! The signatories of the peace of Constance were divided between leaguers and imperialists. On the one side we find Vercelli, Novara, Milan, Lodi, Bergamo, Brescia, Mantua, Verona, Vicenza, Padua, Treviso, Bologna, Faenza, Modena, Reggio, Parma, Piacenza; on the other, Pavia, Genoa, Alba, Cremona, Como, Tortona, Asti, Cesarea. Venice, who had not yet entered the Italian community, is conspicuous by her absence. According to the terms of this treaty, the communes were confirmed in their right of self-government by consuls, and their right of warfare. The emperor retained the supreme courts of appeal within the cities, and his claim for sustenance at their expense when he came into Italy.

War of cities against nobles.

The privileges confirmed to the Lombard cities by the peace of Constance were extended to Tuscany, where Florence, having ruined Fiesole, had begun her career of freedom and prosperity. The next great chapter in the history of Italian evolution is the war of the burghs against the nobles. The consular cities were everywhere surrounded by castles; and, though the feudal lords had been weakened by the events of the preceding centuries, they continued to be formidable enemies. It was, for instance, necessary to the well-being of the towns that they should possess territory round their walls, and this had to be wrested from the nobles. We cannot linger over the details of this warfare. It must suffice to say that, partly by mortgaging their property to rich burghers, partly by entering the service of the cities as condottieri, partly by espousing the cause of one town against another, and partly by forced submission after the siege of their strong places, the counts were gradually brought into connexion of dependence on the communes. These, in their turn, forced the nobles to leave their castles, and to reside for at least a portion of each year within the walls. By these measures the counts became citizens, the rural population ceased to rank as serfs, and the Italo-Roman population of the towns absorbed into itself the remnants of Franks, Germans, and other foreign stocks. It would be impossible to exaggerate the importance of this revolution, which ended by destroying the last vestige of feudality, and prepared that common Italian people which afterwards distinguished itself by the creation of European culture. But, like all the vicissitudes of the Italian race, while it was a decided step forward in one direction, it introduced a new source of discord. The associated nobles proved ill neighbours to the peaceable citizens. They fortified their houses, retained their military habits, defied the consuls, and carried on feuds in the streets and squares. The war against the castles became a war against the palaces; and the system of government by consuls proved inefficient to control the clashing elements within the state. This led to the establishment of podestà, who represented a compromise between two radically hostile parties in the city, and whose business it was to arbitrate and keep the peace between them. Invariably a foreigner, elected for a year with power of life and death and control of the armed force, but subject to a strict account at the expiration of his office, the podestà might be compared to a dictator invested with limited authority. His title was derived from that of Frederick Barbarossa's judges; but he had no dependence on the empire. The citizens chose him, and voluntarily submitted to his rule. The podestà marks an essentially transitional state in civil government, and his intervention paved the way for despotism.

The thirty years which elapsed between Frederick

Barbarossa's death in 1190 and the coronation of his grandson Frederick II. in 1220 form one of the most momentous epochs in Italian history. Barbarossa, perceiving the advantage that would accrue to his house if he could join the crown of Sicily to that of Germany, and thus deprive the popes of their allies in Lower Italy, procured the marriage of his son Henry VI. to Constance, daughter of King Roger, and heiress of the Hauteville dynasty. When William II., the last monarch of the Norman race, died, Henry VI. claimed that kingdom in his wife's right, and was recognized in 1194. Three years afterwards he died, leaving a son, Frederick, to the care of Constance, who in her turn died in 1198, bequeathing the young prince, already crowned king of Germany, to the guardianship of Innocent III. It was bold policy to confide Frederick to his greatest enemy and rival; but the pope honourably discharged his duty, until his ward outgrew the years of tutelage, and became a fair mark for ecclesiastical hostility. Frederick's long minority was occupied by Innocent's pontificate. Among the principal events of that reign must be reckoned the foundation of the two orders, Franciscan and Dominican, who were destined to form a militia for the Holy See in conflict with the empire and the heretics of Lombardy. A second great event was the fourth crusade, undertaken in 1198, which established the naval and commercial supremacy of the Italians in the Mediterranean. The Venetians, who contracted for the transport of the crusaders, and whose blind doge Dandolo was first to land in Constantinople, received one-half and one-fourth of the divided Greek empire for their spoils. The Venetian ascendancy in the Levant dates from this epoch; for, though the republic had no power to occupy all the domains ceded to it, Candia was taken, together with several small islands and stations on the mainland. The formation of a Latin empire in the East increased the pope's prestige; while at home it was his policy to organize Countess Matilda's heritage by the formation of Guelf leagues, over which he presided. This is the meaning of the three leagues, in the March, in the duchy of Spoleto, and in Tuscany, which now combined the chief cities of the papal territory into allies of the Holy See. From the Tuscan league Pisa, consistently Ghibelline, stood aloof. Rome itself again at this epoch established a republic, with which Innocent would not or could not interfere. The thirteen districts in their council nominated four *caporioni*, who acted in concert with a *senator*, appointed, like the podestà of other cities, for supreme judicial functions. Meanwhile the Guelf and Ghibelline factions were beginning to divide Italy into minute parcels. Not only did commune range itself against commune under the two rival flags, but party rose up against party within the city walls. The introduction of the factions into Florence in 1215, owing to a private quarrel between the Buondelmonti, Amidei, and Donati, is a celebrated instance of what was happening in every burgh.

Frederick II. was left without a rival for the imperial throne in 1218 by the death of Otto IV., and on the 22d of November 1220 Honorius III., Innocent's successor, crowned him in Rome. It was impossible for any section of the Italians to mistake the gravity of his access to power. In his single person he combined the prestige of empire with the crowns of Italy, Sicily, Sardinia, Germany, and Burgundy; and in 1225, by marriage with Yolande de Brienne, he added that of Jerusalem. There was no prince greater or more formidable in the habitable globe. The communes, no less than the popes, felt that they must prepare themselves for contest to the death with a power which threatened their existence. Already in 1218 the Guelfs of Lombardy had resuscitated their old

Pontificate of Innocent III.

Frederick II. emperor.

league, and had been defeated by the Ghibellines in a battle near Ghibello. Italy seemed to lie prostrate before the emperor, who commanded her for the first time from the south as well as from the north. In 1227 Frederick, who had promised to lead a crusade, was excommunicated by Gregory IX. because he was obliged by illness to defer his undertaking; and thus the spiritual power declared war upon its rival. The Guelf towns of Lombardy again raised their levies. Frederick enlisted his Saracen troops at Nocera and Luceria, and appointed the terrible Ezzelino da Romano his vicar in the Marches of Verona to quell their insurrection. It was 1236, however, before he was able to take the field himself against the Lombards. Having established Ezzelino in Verona, Vicenza, and Padua, he defeated the Milanese and their allies at Cortenuova in 1237, and sent their carroccio as a trophy of his victory to Rome. Gregory IX. feared lest the Guelf party would be ruined by this check. He therefore made alliance with Venice and Genoa, fulminated a new excommunication against Frederick, and convoked a council at Rome to ratify his ban in 1241. The Genoese undertook to bring the French bishops to this council. Their fleet was attacked at Meloria by the Pisans, and utterly defeated. The French prelates went in silver chains to prison in the Ghibelline capital of Tuscany. So far Frederick had been successful at all points. In 1243 a new pope, Innocent IV., was elected, who prosecuted the war with still bitterer spirit. Forced to fly to France, he there, at Lyons, in 1245, convened a council, which enforced his condemnation of the emperor. Frederick's subjects were freed from their allegiance, and he was declared dethroned and deprived of all rights. Five times king and emperor as he was, Frederick, placed under the ban of the church, led henceforth a doomed existence. The mendicant monks stirred up the populace to acts of fanatical enmity. To plot against him, to attempt his life by poison or the sword, was accounted virtuous. His secretary, Piero delle Vigne, conspired against him. The crimes of his vicar Ezzelino, who laid whole provinces waste and murdered men by thousands in his Paduan prisons, increased the horror with which he was regarded. Parma revolted from him, and he spent months in 1247-8 vainly trying to reduce this one time faithful city. The only gleam of success which shone on his ill fortune was the revolution which placed Florence in the hands of the Ghibellines in 1248. Next year Bologna rose against him, defeated his troops, and took his son Enzo, king of Sardinia, prisoner at Fossalta. Hunted to the ground and broken-hearted, Frederick expired at the end of 1250 in his Apulian castle of Fiorentino. It is difficult to judge his career with fairness. The only prince who could, with any probability of success, have established the German rule in Italy, his ruin proved the impossibility of that long-cherished scheme. The nation had outgrown dependence upon foreigners, and after his death no German emperor interfered with anything but miserable failure in Italian affairs. Yet from many points of view it might be regretted that Frederick was not suffered to rule Italy. By birth and breeding an Italian, highly gifted and widely cultivated, liberal in his opinions, a patron of literature, a founder of universities, he anticipated the spirit of the Renaissance. At his court Italian started into being as a language. His laws were wise. He was capable of giving to Italy a large and noble culture. But the commanding greatness of his position proved his ruin. Emperor and king of Sicily, he was the natural enemy of popes, who could not tolerate so overwhelming a rival.

After Frederick's death, the popes carried on their war for eighteen years against his descendants. The cause of his son Conrad was sustained in Lower Italy by Manfred,

one of Frederick's many natural children; and, when Conrad died in 1254, Manfred still acted as vicegerent for the Swabians, who were now represented by a boy Conrad. Innocent IV. and Alexander IV. continued to make head against the Ghibelline party. The most dramatic incident in this struggle was the crusade preached against Ezzelino. This tyrant had made himself justly odious; and when he was hunted to death in 1259, the triumph was less for the Guelf cause than for humanity outraged by the iniquities of such a monster. The battle between Guelf and Ghibelline raged with unintermitting fury. While the former faction gained in Lombardy by the massacre of Ezzelino, the latter revived in Tuscany after the battle of Montaperti, which in 1260 placed Florence at the discretion of the Ghibellines. Manfred, now called king of Sicily, headed the Ghibellines, and there was no strong counterpoise against him. In this necessity Urban IV. and Clement IV. invited Charles of Anjou to enter Italy and take the Guelf command. They made him senator of Rome, and vicar of Tuscany, and promised him the investiture of the regno provided he stipulated that it should not be held in combination with the empire. Charles accepted these terms, and was welcomed by the Guelf party as their chief throughout Italy. He defeated Manfred in a battle at Grandella near Benevento in 1266. Manfred was killed; and, when Conradin, a lad of sixteen, descended from Germany to make good his claims to the kingdom, he too was defeated at Tagliacozzo in 1267. Less lucky than his uncle, Conradin escaped with his life, to die upon a scaffold at Naples. His glove was carried to his cousin Constance, wife of Peter of Aragon, the last of the great Norman-Swabian family. Enzo died in his prison four years later. The popes had been successful; but they had purchased their bloody victory at a great cost. This first invitation to French princes brought with it incalculable evils.

Charles of Anjou, supported by Rome, and recognized as chief in Tuscany, was by far the most formidable of the Italian potentates. In his turn he now excited the jealousy of the popes, who began, though cautiously, to cast their weight into the Ghibelline scale. Gregory initiated the policy of establishing an equilibrium between the parties, which was carried out by his successor Nicholas III. Charles was forced to resign the senatorship of Rome and the signoria of Lombardy and Tuscany. In 1282 he received a more decided check, when Sicily rose against him in the famous rebellion of the Vespers. He lost the island, which gave itself to Aragon; and thus the kingdom of Sicily was severed from that of Naples, the dynasty in the one being Spanish and Ghibelline, in the other French and Guelf. Meanwhile a new emperor had been elected, the prudent Rudolf of Hapsburg, who abstained from interference with Italy, and who confirmed the territorial pretensions of the popes by solemn charter in 1278. Henceforth Emilia, Romagna, the March of Ancona, the patrimony of St Peter, and the Campagna of Rome held of the Holy See, and not of the empire. The imperial chancery, without inquiring closely into the deeds furnished by the papal curia, made a deed of gift, which placed the pope in the position of a temporal sovereign. While Nicholas III. thus bettered the position of the church in Italy, the Guelf party grew stronger than ever, through the crushing defeat of the Pisans by the Genoese at Meloria in 1284. Pisa, who had ruined Amalfi, was now ruined by Genoa. She never held her head so high again after this victory, which sent her best and bravest citizens to die in the Ligurian dungeons. The Mediterranean was left to be fought for by Genoa and Venice, while Guelf Florence grew still more powerful in Tuscany. Not long after the battle of Meloria Charles of Anjou died, and was succeeded by his son Charles II. of Naples, who played no prominent

Papal war against Frederick's successors.

Civil wars of the Guelfs and Ghibellines.



part in Italian affairs. The Guelf party was held together with a less tight hand even in cities so consistent as Florence. Here in the year 1300 new factions, subdividing the old Guelfs and Ghibellines under the names of Neri and Bianchi, had acquired such force that Boniface VIII., a violently Guelf pope, called in Charles of Valois to pacify the republic and undertake the charge of Italian affairs. Boniface was a passionate and unwise man. After quarrelling with the French king, Philip le Bel, he fell into the hands of the Colonna family at Anagni, and died, either of the violence he there received or of mortification, in October 1303.

Trans-  
lation  
of the  
papacy  
to  
Avignon.

After the short papacy of Benedict XI. a Frenchman, Clement V., was elected, and the seat of the papacy was transferred to Avignon. Thus began that Babylonian exile of the popes which placed them in subjection to the French crown, and ruined their prestige in Italy. Lasting seventy years, and joining on to the sixty years of the Great Schism, this enfeeblement of the papal authority, coinciding as it did with the practical elimination of the empire from Italian affairs, gave a long period of comparative independence to the nation. Nor must it be forgotten that this exile was due to the policy which induced the pontiffs, in their detestation of Ghibellinism, to rely successively upon the houses of Anjou and of Valois. This policy it was which justified Dante's fierce epigram—the *mutaneggiar co regi*.

The period we have briefly traversed was immortalized by Dante in an epic which from one point of view might be called the poem of the Guelfs and Ghibellines. From the foregoing bare narration of events it is impossible to estimate the importance of these parties, or to understand their bearing on subsequent Italian history. We are therefore forced to pause awhile, and probe beneath the surface. The civil wars may be regarded as a continuation of the previous municipal struggle, intensified by recent hostilities between the burghers and the nobles. The quarrels of the church and empire lend pretexts and furnish war-cries; but the real question at issue is not the supremacy of pope or emperor. The conflict is a social one, between civic and feudal institutions, between commercial and military interests, between progress and conservatism. Guelf democracy and industry idealize the pope. The banner of the church waves above the camp of those who aim at positive prosperity and republican equality. Ghibelline aristocracy and immobility idealize the emperor. The prestige of the empire, based upon Roman law and feudal tradition, attracts imaginative patriots and systematic thinkers. The two ideals are counterposed and mutually exclusive. No city calls itself either Guelf or Ghibelline till it has expelled one-half of its inhabitants; for each party is resolved to constitute the state according to its own conception, and the affirmation of the one programme is the negation of the other. The Ghibelline honestly believes that the Guelfs will reduce society to chaos. The Guelf is persuaded that the Ghibellines will annihilate freedom and strangle commerce. The struggle is waged by two sets of men who equally love their city, but who would fain rule it upon diametrically opposite principles, and who fight to the death for its possession. This contradiction enters into the minutest details of life:—armorial bearings, clothes, habits at table, symbolize and accentuate the difference. Meanwhile each party forms its own organization of chiefs, finance-officers, and registrars at home, and sends ambassadors to foreign cities of the same complexion. A network of party policy embraces and dominates the burghs of Italy, bringing the most distant centres into relation, and by the very division of the country augmenting the sense of nationality. The Italians learn through their discords at this epoch that

they form one community. The victory in the conflict practically falls to the hitherto unenfranchised plebeians. The elder noble families die out or lose their preponderance. In some cities, as notably in Florence after the date 1292, it becomes criminal to be *scioperato*, or unemployed in industry. New houses rise into importance; a new commercial aristocracy is formed. Burghers of all denominations are enrolled in one or other of the arts or guilds, and these trading companies furnish the material from which the government or signoria of the city is composed. Plebeian handicrafts assert their right to be represented on an equality with learned professions and wealthy corporations. The ancient classes are confounded and obliterated in a population more homogeneous, more adapted for democracy and despotism.

In addition to the parliament and the councils which New con-  
stitution  
of the  
free  
cities have been already enumerated, we now find a *council of the party* established within the city. This body tends to become a little state within the state, and, by controlling the victorious majority, disposes of the government as it thinks best. The consuls are merged in *quercioni* or *priors*, chosen from the arts. A new magistrate, the *gonfaloniere of justice*, appears in some of the Guelf cities, with the special duty of keeping the insolence of the nobility in check. Meanwhile the *podestà* still subsists; but he is no longer equal to the task of maintaining an equilibrium of forces. He sinks more and more into a judge, loses more and more the character of dictator. His ancient place is now occupied by a new functionary, no longer acting as arbiter, but concentrating the forces of the triumphant party. The *captain of the people*, acting as head of the ascendant Guelfs or Ghibellines, undertakes the responsibility of proscriptions, decides on questions of policy, forms alliances, declares war. Like all officers created to meet an emergency, the limitations to his power are ill-defined, and he is often little better than an autocrat.

#### Age of the Despots.

Thus the Italians, during the heat of the civil wars, Origin  
of ty-  
rannies. were ostensibly divided between partisans of the empire and partisans of the church. After the death of Frederick II. their affairs were managed by Manfred and by Charles of Anjou, the supreme captains of the parties, under whose orders acted the captains of the people in each city. The contest being carried on by warfare, it followed that these captains in the burghs were chosen on account of military skill; and, since the nobles were men of arms by profession, members of ancient houses took the lead again in towns where they had been absorbed into the bourgeoisie. In this way, after the downfall of the Ezzelini of Romano, the Della Scala dynasty arose in Verona, and the Carraresi in Padua. The Estensi made themselves lords of Ferrara; the Torriani headed the Guelfs of Milan. At Ravenna we find the Polenta family, at Rimini the Malatestas, at Parma the Rossi, at Piacenza the Scotti, at Faenza the Manfredi. There is not a burgh of northern Italy but can trace the rise of a dynastic house to the vicissitudes of this period. In Tuscany, where the Guelf party was very strongly organized, and the commercial constitution of Florence kept the nobility in check, the communes remained as yet free from hereditary masters. Yet generals from time to time arose, the Conte Ugolino della Gheradesca at Pisa, Ugucione della Faggiuola at Lucca, the Conte Guido di Montefeltro at Florence, who threatened the liberties of Tuscan cities with military despotism.

Left to themselves by absentee emperors and exiled popes, the Italians pursued their own course of development unchecked. After the commencement of the 14th century, the civil wars decreased in fury, and at the same time it was perceived that their effect had been to confirm

tyrants in their grasp upon free cities. Growing up out of the captain of the people or signore of the commune, the tyrant annihilated both parties for his own profit and for the peace of the state. He used the dictatorial powers with which he was invested, to place himself above the law, resuming in his person the state-machinery which had preceded him. In him, for the first time, the city attained self-consciousness; the blindly working forces of previous revolutions were combined in the will of a ruler. The tyrant's general policy was to favour the multitude at the expense of his own caste. He won favour by these means, and completed the levelling down of classes, which had been proceeding ever since the emergence of the communes.

Decline  
of civil  
wars.  
Advent  
of the  
bour-  
geois.

In 1309 Robert, grandson of Charles, the first Angevine sovereign, succeeded to the throne of Naples, and became the leader of the Guelfs in Italy. In the next year Henry VII. of Luxembourg crossed the Alps soon after his election to the empire, and raised the hopes of the Ghibellines. Dante from his mountain solitudes passionately called upon him to play the part of a Messiah. But it was now impossible for any German to control the "Garden of the Empire." Italy had entered on a new phase of her existence, and the great poet's *De Monarchia* represented a dream of the past which could not be realized. Henry established imperial vicars in the Lombard towns, confirming the tyrants, but gaining nothing for the empire in exchange for the titles he conferred. After receiving the crown in Rome, he died at Buonconvento, a little walled town south of Siena, on his backward journey in 1313. The profits of his inroad were reaped by despots, who used the Ghibelline prestige for the consolidation of their own power. It is from this epoch that the supremacy of the Visconti, hitherto the unsuccessful rivals of the Guelphic Torriani for the signory of Milan, dates. The Scaligers in Verona and the Carraresi in Padua were strengthened; and in Tuscany Castruccio Castracane, Uguccione's successor at Lucca, became formidable. In 1325 he defeated the Florentines at Alto Paschio, and carried home their carroccio as a trophy of his victory over the Guelphs. Louis of Bavaria, the next emperor, made a similar excursion in the year 1327, with even greater loss of imperial prestige. He deposed Galeazzo Visconti on his downward journey, and offered Milan for a sum of money to his son Azzo upon his return. Castruccio Castracane was nominated by him duke of Lucca; and this is the first instance of a dynastic title conferred upon an Italian adventurer by the emperor. Castruccio dominated Tuscany, where the Guelph cause, in the weakness of King Robert, languished. But the adventurer's death in 1328 saved the stronghold of republican institutions, and Florence breathed freely for a while again. Can Grande della Scala's death in the next year inflicted on the Lombard Ghibellines a loss hardly inferior to that of Castruccio's on their Tuscan allies. Equally contemptible in its political results and void of historical interest was the brief visit of John of Bohemia, son of Henry VII., whom the Ghibellines next invited to assume their leadership. He sold a few privileges, conferred a few titles, and recrossed the Alps in 1333. It is clear that at this time the fury of the civil wars was spent. In spite of repeated efforts on the part of the Ghibellines, in spite of King Robert's supine incapacity, the imperialists gained no permanent advantage. The Italians were tired of fighting, and the leaders of both factions looked exclusively to their own interests. Each city which had been the cradle of freedom thankfully accepted a master, to quench the conflagration of party strife, encourage trade, and make the handicraftsmen comfortable. Even the Florentines in 1342 submitted for a few months to the despotism of the duke of Athens. They conferred the signory upon him

for life; and, had he not mismanaged matters, no might have held the city in his grasp. Italy was settling down and turning her attention to home comforts, arts, and literature. Boccaccio, the contented bourgeois, succeeded to Dante, the fierce aristocrat.

The most marked proof of the change which came over Italy towards the middle of the 14th century is furnished by the companies of adventure. It was with their own militia that the burghers won freedom in the war of independence, subdued the nobles, and fought the battles of the parties. But from this time forward they laid down their arms, and played the game of warfare by the aid of mercenaries. Ecclesiastical overlords, interfering from a distance in Italian politics; prosperous republics, with plenty of money to spend but no leisure or inclination for camp-life; cautious tyrants, glad of every pretext to emasculate their subjects, and courting popularity by exchanging conscription for taxation,—all combined to favour the new system. Mercenary troops are said to have been first levied from disbanded Germans, together with Breton and English adventurers, whom the Visconti and Castruccio took into their pay. They soon appeared under their own captains, who hired them out to the highest bidder, or marched them on marauding expeditions up and down the less protected districts. The names of some of these earliest captains of adventure, Fra Moriale, Count Lando, and Duke Werner, who styled himself the "Enemy of God and Mercy," have been preserved to us. As the companies grew in size and improved their discipline, it was seen by the Italian nobles that this kind of service offered a good career for men of spirit, who had learned the use of arms. To leave so powerful and profitable a calling in the hands of foreigners seemed both dangerous and uneconomical. Therefore, after the middle of the century, this profession fell into the hands of natives. The first Italian who formed an exclusively Italian company was Alberico da Barbiano, a nobleman of Romagna, and founder of the Milanese house of Belgiojoso. In his school the great condottieri Braccio da Montone and Sforza Attendolo were formed; and henceforth the battles of Italy were fought by Italian generals commanding native troops. This was better in some respects than if the mercenaries had been foreigners. Yet it must not be forgotten that the new companies of adventure, who decided Italian affairs for the next century, were in no sense patriotic. They sold themselves for money, irrespective of the cause which they upheld; and, while changing masters, they had no care for any interests but their own. The name condottiero, derived from *condotta*, a paid contract to supply so many fighting men in serviceable order, sufficiently indicates the nature of the business. In the hands of able captains, like Francesco Sforza or Piccinino, these mercenary troops became moving despotisms, draining the country of its wealth, and always eager to fasten and found tyrannies upon the provinces they had been summoned to defend. Their generals substituted heavy-armed cavalry for the old militia, and introduced systems of campaigning which reduced the art of war to a game of skill. Battles became all but bloodless; diplomacy and tactics superseded feats of arms and hard blows in pitched fields. In this way the Italians lost their military vigour, and wars were waged by despots from their cabinets, who pulled the strings of puppet captains in their pay. Nor were the people only enfeebled for resistance to a real foe; the whole political spirit of the race was demoralized. The purely selfish bond between condottieri and their employers, whether princes or republics, involved intrigues and treachery, checks and counterchecks, secret terror on the one hand and treasonable practice on the other, which ended by making statecraft in Italy synonymous with perfidy.

Com-  
panies of  
advent-  
ure.



Change  
in type  
of des-  
potism.

It must further be noticed that the rise of mercenaries was synchronous with a change in the nature of Italian despotism. The tyrants, as we have already seen, established themselves as captains of the people, vicars of the empire, vicars for the church, leaders of the Guelph and Ghibelline parties. They were accepted by a population eager for repose, who had merged old class distinctions in the conflicts of preceding centuries. They rested in large measure on the favour of the multitude, and pursued a policy of sacrificing to their interests the nobles. It was natural that these self-made princes should seek to secure the peace which they had promised in their cities, by freeing the people from military service and disarming the aristocracy. As their tenure of power grew firmer, they advanced dynastic claims, assumed titles, and took the style of petty sovereigns. Their government became paternal; and, though there was no limit to their cruelty when stung by terror, they used the purse rather than the sword, bribery at home and treasonable intrigue abroad in preference to coercive measures or open war. Thus was elaborated the type of despot which attained completeness in Gian Galeazzo Visconti and Lorenzo de' Medici. No longer a tyrant of Ezzelino's stamp, he reigned by intelligence and terrorism masked beneath a smile. He substituted cunning and corruption for violence. The lesser people tolerated him because he extended the power of their city and made it beautiful with public buildings. The bourgeoisie, protected in their trade, found it convenient to support him. The nobles, turned into courtiers, placemen, diplomatists, and men of affairs, ended by preferring his authority to the alternative of democratic institutions. A lethargy of well-being, broken only by the pinch of taxation for war-costs, or by outbursts of frantic ferocity and lust in the less calculating tyrants, descended on the population of cities which had boasted of their freedom. Only Florence and Venice, at the close of the period upon which we are now entering, maintained their republican independence. And Venice was ruled by a close oligarchy; Florence was passing from the hands of her oligarchs into the power of the Medicean merchants.

Discrimi-  
nation of  
the five  
great  
powers.

Between the year 1305, when Clement V. settled at Avignon, and the year 1447, when Nicholas V. re-established the papacy upon a solid basis at Rome, the Italians approximated more nearly to self-government than at any other epoch of their history. The conditions which have been described, of despotism, mercenary warfare, and bourgeois prosperity, determined the character of this epoch, which was also the period when the great achievements of the Renaissance were prepared. At the end of this century and a half, five principal powers divided the peninsula; and their confederated action during the next forty-five years (1447-1492) secured for Italy a season of peace and brilliant prosperity. These five powers were the kingdom of Naples, the duchy of Milan, the republic of Florence, the republic of Venice, and the papacy. The subsequent events of Italian history will be rendered most intelligible if at this point we trace the development of these five constituents of Italian greatness separately.

The Two  
Sicilies.

When Robert of Anjou died in 1343, he was succeeded by his grand-daughter Joan, the childless wife of four successive husbands, Andrew of Hungary, Louis of Taranto, James of Aragon, and Otto of Brunswick. Charles of Durazzo, the last male scion of the Angevine house in Lower Italy, murdered Joan in 1382, and held the kingdom for five years. Dying in 1387, he transmitted Naples to his son Ladislaus, who had no children, and was followed in 1414 by his sister Joan II. She too, though twice married, died without issue, having at one time adopted Louis III. of Provence and his brother René, at another Alfonso V. of Aragon, who inherited the crown of Sicily.

After her death in February 1435, the kingdom was fought for between René of Anjou and Alfonso, surnamed the Magnanimous. René found supporters among the Italian princes, especially the Milanese Visconti, who helped him to assert his claims with arms. During the war of succession which ensued, Alfonso was taken prisoner by the Genoese fleet in August 1435, and was sent a prisoner to Filippo Maria at Milan. Here he pleaded his own cause so powerfully, and proved so incontestably the advantage which might ensue to the Visconti from his alliance, if he held the regno, that he obtained his release and recognition as king. From the end of the year 1435 Alfonso reigned alone and undisturbed in Lower Italy, combining for the first time since the year 1282 the crowns of Sicily and Naples. The former he held by inheritance, together with that of Aragon. The latter he considered to be his by conquest. Therefore, when he died in 1458, he bequeathed Naples to his natural son Ferdinand, while Sicily and Aragon passed together to his brother John, and so on to Ferdinand the Catholic. The twenty-three years of Alfonso's reign were the most prosperous and splendid period of South Italian history. He became an Italian in taste and sympathy, entering with enthusiasm into the humanistic ardour of the earlier Renaissance, encouraging men of letters at his court, administering his kingdom on the principles of an enlightened despotism, and lending his authority to establish that equilibrium in the peninsula upon which the politicians of his age believed, not without reason, that Italian independence might be secured.

The last member of the Visconti family of whom we had occasion to speak was Azzo, who bought the city in Milan. 1328 from Louis of Bavaria. His uncle Lucchino succeeded, but was murdered in 1349 by a wife against whose life he had been plotting. Lucchino's brother John, archbishop of Milan, now assumed the lordship of the city, and extended the power of the Visconti over Genoa and the whole of North Italy, with the exception of Piedmont, Verona, Mantua, Ferrara, and Venice. The greatness of the family dates from the reign of this masterful prelate. He died in 1354, and his heritage was divided between three members of his house, Matteo, Bernabo, and Galeazzo. In the next year Matteo, being judged incompetent to rule, was assassinated by order of his brothers, who made an equal partition of their subject cities,—Bernabo residing in Milan, Galeazzo in Pavia. Galeazzo was the wealthiest and most magnificent Italian of his epoch. He married his daughter Violante to our duke of Clarence, and his son Gian Galeazzo to a daughter of King John of France. When he died in 1378, this son resolved to reunite the domains of the Visconti; and, with this object in view, he plotted and executed the murder of his uncle Bernabo. Gian Galeazzo thus became by one stroke the most formidable of Italian despots. Inmured in his castle at Pavia, accumulating wealth by systematic taxation and methodical economy, he organized the mercenary troops who eagerly took service under so good a paymaster; and, by directing their operations from his cabinet, he threatened the whole of Italy with conquest. The last scions of the Della Scala family still reigned in Verona, the last Carraresi in Padua; the Estensi were powerful in Ferrara, the Gonzaghi in Mantua. Gian Galeazzo, partly by force and partly by intrigue, discredited these minor despots, pushed his dominion to the very verge of Venice, and, having subjected Lombardy to his sway, proceeded to attack Tuscany. Pisa and Perugia were threatened with extinction, and Florence dreaded the advance of the Visconti arms, when the plague suddenly cut short his career of treachery and conquest in the year 1402. Seven years before his death Gian Galeazzo bought the title of duke of Milan and count of Pavia from

the emperor Wenceslaus, and there is no doubt that he was aiming at the sovereignty of Italy. But no sooner was he dead than the essential weakness of an artificial state, built up by cunning and perfidious policy, with the aid of bought troops, dignified by no dynastic title, and consolidated by no sense of loyalty, became apparent. Gian Galeazzo's duchy was a masterpiece of mechanical contrivance, the creation of a scheming intellect and lawless will. When the mind which had planned it was withdrawn, it fell to pieces, and the very hands which had been used to build it helped to scatter its fragments. The Visconti's own generals, Facino Cane, Pandolfo Malatesta, Jacopo dal Verme, Gabriuo Fondulo, Ottobon Terzo, seized upon the tyranny of several Lombard cities. In others the petty tyrants whom the Visconti had uprooted reappeared. The Estensi recovered their grasp upon Ferrara, and the Gonzaghi upon Mantua. Venice strengthened herself between the Adriatic and the Alps. Florence reassumed her Tuscan hegemony. Other communes which still preserved the shadow of independence, like Perugia and Bologna, began once more to dream of republican freedom under their own leading families. Meanwhile Gian Galeazzo had left two sons, Giovanni Maria and Filippo Maria. Giovanni, a monster of cruelty and lust, was assassinated by some Milanese nobles in 1412; and now Filippo set about rebuilding his father's duchy. Herein he was aided by the troops of Facino Cane, who, dying opportunely at this period, left considerable wealth, a well-trained band of mercenaries, and a widow, Beatrice di Tenda. Filippo married and then beheaded Beatrice after a mock trial for adultery, having used her money, and her influence in reuniting several subject cities to the crown of Milan. He subsequently spent a long, suspicious, secret, and incomprehensible career in the attempt to piece together Gian Galeazzo's Lombard state, and to carry out his schemes of Italian conquest. In this endeavour he met with vigorous opponents. Venice and Florence, strong in the strength of their resentful oligarchies, offered a determined resistance; nor was Filippo equal in ability to his father. His infernal cunning often defeated its own aims, checkmating him at the point of achievement by suggestions of duplicity or terror. In the course of Filippo's wars with Florence and Venice, the greatest generals of this age were formed—Francesco Carmagnola, who was beheaded between the columns at Venice in 1432; Niccolò Piccinino, who died at Milan in 1444; and Francesco Sforza, who survived to seize his master's heritage in 1450. Son of Attendolo Sforza, this Francesco received the hand of Filippo's natural daughter, Bianca, as a reward for past service and a pledge of future support. When the Visconti dynasty ended by the duke's death in 1447, he pretended to espouse the cause of the Milanese republic, which was then reestablished; but he played his cards so subtly as to make himself, by the help of Cosimo de' Medici in Florence, duke *de facto* if not *de jure*. Francesco Sforza was the only condottiero among many aspiring to be tyrants who planted himself firmly on a throne of first-rate importance. Once seated in the dūchy of Milan, he displayed rare qualities as a ruler; for he not only entered into the spirit of the age, which required humanity and culture from a despot, but he also knew how to curb his desire for territory. The conception of confederated Italy found in him a vigorous supporter. Thus the limitation of the Milanese duchy under Filippo Maria Visconti, and its consolidation under Francesco Sforza, were equally effectual in preparing the balance of power to which Italian politics now tended.

This balance could not have been established without the concurrent aid of Florence. After the expulsion of the duke of Athens in 1343, and the great plague of 1348,

the Florentine proletariat rose up against the merchant princes. This insurgence of the artisans, in a republic which had been remodelled upon economical principles by Giano della Bella's constitution of 1292, reached a climax in 1378, when the Ciompi rebellion placed the city for a few years in the hands of the Lesser Arts. The revolution was but temporary, and was rather a symptom of democratic tendencies in the state than the sign of any capacity for government on the part of the working classes. The necessities of war and foreign affairs soon placed Florence in the power of an oligarchy headed by the great Albizzi family. They fought the battles of the republic with success against the Visconti, and widely extended the Florentine domain over the Tuscan cities. During their season of ascendancy Pisa was enslaved, and Florence gained the access to the sea. But throughout this period a powerful opposition was gathering strength. It was led by the Medici, who sided with the common people, and increased their political importance by the accumulation and wise employment of vast commercial wealth. In 1433 the Albizzi and the Medici came to open strife. Cosimo de' Medici, the chief of the opposition, was exiled to Venice. In the next year he returned, assumed the presidency of the democratic party, and by a system of corruption and popularity-hunting, combined with the patronage of arts and letters, established himself as the real but unacknowledged dictator of the commonwealth. Cosimo abandoned the policy of his predecessors. Instead of opposing Francesco Sforza in Milan, he lent him his prestige and influence, foreseeing that the dynastic future of his own family and the pacification of Italy might be secured by a balance of power in which Florence should rank on equal terms with Milan and Naples.

The republic of Venice differed essentially from any Venice. other state in Italy; and her history was so separate that, up to this point, it would have been needless to interrupt the narrative by tracing it. Venice, however, in the 14th century took her place at last as an Italian power on an equality at least with the very greatest. The constitution of the commonwealth had slowly matured itself through a series of revolutions, which confirmed and defined a type of singular stability. During the earlier days of the republic the doge had been a prince elected by the people, and answerable only to the popular assemblies. In 1032 he was obliged to act in concert with a senate, called *pregadi*; and in 1172 the grand council, which became the real sovereign of the state, was formed. The several steps whereby the members of the grand council succeeded in eliminating the people from a share in the government, and reducing the doge to the position of their ornamental representative, cannot here be described. It must suffice to say that these changes culminated in 1297, when an act was passed for closing the grand council, or in other words for confining it to a fixed number of privileged families, in whom the government was henceforth vested by hereditary right. This ratification of the oligarchical principle, together with the establishment in 1311 of the Council of Ten, completed that famous constitution which endured till the extinction of the republic in 1797. Meanwhile, throughout the Middle Ages, it had been the policy of Venice to refrain from conquests on the Italian mainland, and to confine her energies to commerce in the East. The first entry of any moment made by the Venetians into strictly Italian affairs was in 1336, when the republics of Florence and St Mark allied themselves against Mastino della Scala, and the latter took possession of Treviso. After this, for thirty years, between 1352 and 1381, Venice and Genoa contested the supremacy of the Mediterranean. Pisa's maritime power having been extinguished in the battle of Meloria (1284), the two



surviving republics had no rivals. They fought their duel out upon the Bosphorus, off Sardinia, and in the Morea, with various success. From the first great encounter, in 1355, Venice retired well-nigh exhausted, and Genoa was so crippled that she placed herself under the protection of the Visconti. The second and decisive battle was fought upon the Adriatic. The Genoese fleet under Luciano Doria defeated the Venetians off Pola in 1379, and sailed without opposition to Chioggia, which was stormed and taken. Thus the Venetians found themselves blockaded in their own lagoons. Meanwhile a fleet was raised for their relief by Carlo Zeno in the Levant, and the admiral Vittore Pisani, who had been imprisoned after the defeat at Pola, was released to lead their forlorn hope from the city side. The Genoese in their turn were now blockaded in Chioggia, and forced by famine to surrender. The losses of men and money which the war of Chioggia, as it was called, entailed, though they did not immediately depress the spirit of the Genoese republic, signed her naval ruin. During this second struggle to the death with Genoa, the Venetians had been also at strife with the Carraresi of Padua and the Scaligers of Verona. In 1406, after the extinction of these princely houses they added Verona, Vicenza, and Padua to the territories they claimed on *terra firma*. Their career of conquest, and their new policy of forming Italian alliances and entering into the management of Italian affairs, were confirmed by the long dogeship of Francesco Foscari (1423-1457), who must rank with Alfonso, Cosimo de' Medici, Francesco Sforza, and Nicholas V., as a joint-founder of confederated Italy. When Constantinople fell in 1453, the old ties between Venice and the Eastern empire were broken, and she now entered on a wholly new phase of her history. Ranking as one of the five Italian powers, she was also destined to defend Western Christendom against the encroachments of the Turk in Europe.

By their settlement in Avignon, the popes relinquished their protectorate of Italian liberties, and lost their position as Italian potentates. Rienzi's revolution in Rome (1347-1354), and his establishment of a republic upon a fantastic basis, half classical half feudal, proved the temper of the times; while the rise of dynastic families in the cities of the church, claiming the title of papal vicars, but acting in their own interests, weakened the authority of the Holy See. The predatory expeditions of Bertrand du Poict and Robert of Geneva were as ineffective as the descents of the emperors; and, though the cardinal Albornoz conquered Romagna and the March in 1364, the legates who resided in those districts were not long able to hold them against their despots. At last Gregory XI. returned to Rome; and Urban VI., elected in 1378 put a final end to the Avignonian exile. Still the Great Schism, which now distracted Western Christendom, so enfeebled the papacy, and kept the Roman pontiffs so engaged in ecclesiastical disputes, that they had neither power nor leisure to occupy themselves seriously with their temporal affairs. The threatening presence of the two princely houses of Orsini and Colonna, alike dangerous as friends or foes, rendered Rome an unsafe residence. Even when the schism was nominally terminated in 1415 by the council of Constance, the next two popes held but a precarious grasp upon their Italian domains. Martin V. (1417-1431) resided principally at Florence. Eugenius IV. (1431-1447) followed his example. And what Martin managed to regain Eugenius lost. At the same time, the change which had now come over Italian politics, the desire on all sides for a settlement, and the growing conviction that a federation was necessary, proved advantageous to the popes as sovereigns. They gradually entered into the spirit of their age, assumed the style of despots, and made use of the human-

istic movement, then at its height, to place themselves in a new relation to Italy. The election of Nicholas V. in 1447 determined this revolution in the papacy, and opened a period of temporal splendour, which ended with the establishment of the popes as sovereigns. Thomas of Sarzana was a distinguished humanist. Humbly born, he had been tutor in the house of the Albizzi, and afterwards librarian of the Medici at Florence, where he imbibed the politics together with the culture of the Renaissance. Soon after assuming the tiara, he found himself without a rival in the church; for the schism ended by Felix V.'s resignation in 1449. Nicholas fixed his residence in Rome, which he began to rebuild and to fortify, determining to render the Eternal City once more a capital worthy of its high place in Europe. The Romans were flattered; and, though his reign was disturbed by republican conspiracy, Nicholas V. was able before his death in 1455 to secure the modern status of the pontiff as a splendid patron and a wealthy temporal potentate.

Italy was now for a brief space independent. The humanistic movement had created a common culture, a common language, and sense of common nationality. The five great powers, with their satellites—dukes of Savoy and Urbino, marquises of Ferrara and Mantua, republics of Bologna, Perugia, Siena—were constituted. All political institutions tended toward despotism. The Medici became yearly more indispensable to Florence, the Bentivogli more autocratic in Bologna, the Baglioni in Perugia; and even Siena was ruled by the Pezrucci. But this despotism was of a mild type. The princes were Italians; they shared the common enthusiasms of the nation for art, learning, literature, and science; they studied how to mask their tyranny with arts agreeable to the multitude. When Italy had reached this point, Constantinople was taken by the Turks. On all sides it was felt that the Italian alliance must be tightened; and one of the last, best acts of Nicholas V.'s pontificate was the appeal in 1453 to the five great powers in federation. As regards their common opposition to the Turk, this appeal led to nothing; but it marked the growth of a new Italian consciousness.

Between 1453 and 1492 Italy continued to be prosperous and tranquil. Nearly all wars during this period were undertaken either to check the growing power of Venice or to further the ambition of the papacy. Having become despots, the popes sought to establish their relatives in principalities. The word nepotism acquired new significance in the reigns of Sixtus IV. and Innocent VIII. Though the country was convulsed by no great struggle, these forty years witnessed a truly appalling increase of political crime. To be a prince was tantamount to being the mark of secret conspiracy and assassination. Among the most noteworthy examples of such attempts may be mentioned the revolt of the barons against Ferdinand I. of Naples (1464), the murder of Galeazzo Maria Sforza at Milan (1476), and the plot of the Pazzi to destroy the Medici (1478). After Cosimo de' Medici's death in 1464, the presidency of the Florentine republic passed to his son Piero, who left it in 1469 to his sons Lorenzo and Giuliano. These youths assumed the style of princes, and it was against their lives that the Pazzi, with the sanction of Sixtus IV., aimed their blow. Giuliano was murdered. Lorenzo escaped, to tighten his grasp upon the city, which now loved him and was proud of him. During the following fourteen years of his brilliant career, he made himself absolute master of Florence, and so modified her institutions that the Medici were henceforth necessary to the state. Apprehending the importance of Italian federation, Lorenzo, by his personal tact and prudent leadership of the republic, secured peace and a common intelligence between the five powers. His own family was fortified by the

Confederated  
Italy

marriage of his daughter to a son of Innocent VIII., which procured his son Giovanni's elevation to the cardinalate, and involved two Medicean papacies and the future dependence of Florence upon Rome.

*Age of Invasions.*

Invasion  
of  
Charles  
VIII.

The year 1492 opened a new age for Italy. In this year Lorenzo died, and was succeeded by his son, the vain and weak Piero; France passed beneath the personal control of the inexperienced Charles VIII.; the fall of Granada freed Spain from her embarrassments; Columbus discovered America, destroying the commercial supremacy of Venice; last, but not least, Roderigo Borgia assumed the tiara with the famous title of Alexander VI. In this year the short-lived federation of the five powers was shaken, and Italy was once more drawn into the vortex of European affairs. The events which led to this disaster may be briefly told. After Galeazzo Maria's assassination, his crown passed to a boy, Gian Galeazzo, who was in due course married to a grand-daughter of Ferdinand I. of Naples. But the government of Milan remained in the hands of this youth's uncle, Lodovico, surnamed Il Moro. Lodovico resolved to become duke of Milan. The king of Naples was his natural enemy, and he had cause to suspect that Piero de' Medici might abandon his alliance. Feeling himself alone, with no right to the title he was bent on seizing, he had recourse to Charles VIII. of France, whom he urged to make good his claim to the kingdom of Naples. This claim, it may be said in passing, rested on the will of King René of Anjou. After some hesitation, Charles agreed to invade Italy. He crossed the Alps in 1494, passed through Lombardy, entered Tuscany, freed Pisa from the yoke of Florence, witnessed the expulsion of the Medici, marched to Naples, and was crowned there,—all this without striking a blow. Meanwhile Lodovico procured his nephew's death, and raised a league against the French in Lombardy. Charles hurried back from Naples, and narrowly escaped destruction at Fornovo in the passes of the Apennines. He made good his retreat, however, and returned to France in 1495. Little remained to him of his light acquisitions; but he had convulsed Italy by this invasion, destroyed her equilibrium, exposed her military weakness and political disunion, and revealed her wealth to greedy and more powerful nations.

Louis  
XII.

The princes of the house of Aragon, now represented by Frederick, a son of Ferdinand I., returned to Naples. Florence made herself a republic, adopting a form of constitution analogous to that of Venice. At this crisis she was ruled by the monk Girolamo Savonarola, who inspired the people with a thirst for freedom, preached the necessity of reformation, and placed himself in direct antagonism to Rome. After a short but eventful career, the influence of which was long effective, he lost his hold upon the citizens. Alexander VI. procured a mock trial, and his enemies burned him upon the Piazza in 1498. In this year Louis XII. succeeded Charles VIII. upon the throne of France. As duke of Orleans he had certain claims to Milan through his grandmother Valentina, daughter of Gian Galeazzo, the first duke. They were not valid, for the investiture of the duchy had been granted only to male heirs. But they served as a sufficient pretext, and in 1499 Louis entered and subdued the Milanese. Lodovico escaped to Germany, returned the next year, was betrayed by his Swiss mercenaries, and sent to die at Loches in France. In 1501 Louis made the blunder of calling Ferdinand the Catholic to help him in the conquest of Naples. By a treaty signed at Granada, the French and Spanish kings were to divide the spoil. The conquest was easy; but, when it came to a partition, Ferdinand played his ally false. He made himself supreme over the Two Sicilies, which he now reunited under a single

crown. Three years later, unlessoned by this experience, Louis signed the treaty of Blois (1504), whereby he invited the emperor Maximilian to aid him in the subjugation of Venice. No policy could have been less far-sighted; for Charles V., joint heir to Austria, Burgundy, Castile, and Aragon, the future overwhelming rival of France, was already born.

Duel of  
France  
and  
Spain.

The stage was now prepared, and all the actors who were destined to accomplish the ruin of Italy trod it with their armies. Spain, France, Germany, with their Swiss auxiliaries, had been summoned upon various pretexts to partake her provinces. Then, too late, patriots like Machiavelli perceived the suicidal self-indulgence of the past, which, by substituting mercenary troops for national militias, left the Italians at the absolute discretion of their neighbours. Whatever parts the Italians themselves played in the succeeding quarter of a century, the game was in the hands of French, Spanish, and German invaders. Meanwhile, no scheme for combination against common foes arose in the peninsula. Each petty potentate strove for his own private advantage in the confusion; and at this epoch the chief gains accrued to the papacy. Aided by his terrible son, Cesare Borgia, Alexander VI. chastised the Roman nobles, subdued Romagna and the March, threatened Tuscany, and seemed to be upon the point of creating a Central Italian state in favour of his progeny, when he died suddenly in 1503. His conquests reverted to the Holy See. Julius II., his bitterest enemy and powerful successor, continued Alexander's policy, but no longer in the interest of his own relatives. It became the nobler ambition of Julius to aggrandize the church, and to reassume the protectorate of the Italian people. With this object, he secured Emilia, carried his victorious arms against Ferrara, and curbed the tyranny of the Baglioni in Perugia. Julius II. played a perilous game; but the stakes were high, and he fancied himself strong enough to guide the tempest he evoked. Quarrelling with the Venetians in 1508, he combined the forces of all Europe by the league of Cambray against them; and, when he had succeeded in his first purpose of humbling them even to the dust, he turned round in 1510, uttered his famous resolve to expel the barbarians from Italy, and pitted the Spaniards against the French. It was with the Swiss that he hoped to effect this revolution; but the Swiss, now interfering for the first time as principals in Italian affairs, were incapable of more than adding to the already maddening distractions of the people. Formed for mercenary warfare, they proved a perilous instrument in the hands of those who used them, and were hardly less injurious to their friends than to their foes. In 1512 the battle of Ravenna between the French troops and the allies of Julius,—Spaniards, Venetians, and Swiss,—was fought. Gaston de Foix bought a doubtful victory dearly with his death; and the allies, though beaten on the banks of the Ronco, immediately afterwards expelled the French from Lombardy. Yet Julius II. had failed, as might have been foreseen. He only exchanged one set of foreign masters for another, and taught a new barbarian race how pleasant were the plains of Italy. As a consequence of the battle of Ravenna, the Medici returned in 1512 to Florence.

When Leo X. was elected in 1513, Rome and Florence rejoiced; but Italy had no repose. Louis XII. had lost of the game, and the Spaniards were triumphant. But new actors appeared upon the scene, and the same old struggle was resumed with fiercer energy. By the victory of Marignano in 1515 Francis I., having now succeeded to the throne of France, regained the Milanese, and broke the power of the Swiss, who held it for Massimiliano Sforza, the titular duke. Leo for a while relied on Francis; for the vast power of Charles V., who succeeded to the empire



in 1519, as in 1516 he had succeeded to the crowns of Spain and Lower Italy, threatened the whole of Europe. It was Leo's nature, however, to be inconstant. In 1521 he changed sides, allied himself to Charles, and died after hearing that the imperial troops had again expelled the French from Milan. During the next four years the Franco-Spanish war dragged on in Lombardy until the decisive battle of Pavia in 1525, when Francis was taken prisoner, and Italy lay open to the Spanish armies. Meanwhile Leo X. had been followed by Adrian VI., and Adrian by Clement VII., of the house of Medici, who had long ruled Florence. In the reign of this pope Francis was released from his prison in Madrid (1526), and Clement hoped that he might still be used in the Italian interest as a counterpoise to Charles. It is impossible in this place to follow the tangled intrigues of that period. The year 1527 was signalized by the famous sack of Rome. An army of mixed German and Spanish troops, pretending to act for the emperor, but which may rather be regarded as a vast marauding party, entered Italy under their leader Frundsberg. After his death, the Constable de Bourbon took command of them; they marched slowly down, aided by the marquis of Ferrara, and unopposed by the duke of Urbino, reached Rome, and took it by assault. The constable was killed in the first onslaught; Clement was imprisoned in the castle of St Angelo; Rome was abandoned to the rage of 30,000 ruffians. As an immediate result of this catastrophe, Florence shook off the Medici, and established a republic. But Clement, having made peace with the emperor, turned the remnants of the army which had sacked Rome against his native city. After a desperate resistance, Florence fell in 1530. Alessandro de' Medici was placed there with the title of duke of Civit  di Penna; and, on his murder in 1537, Cosimo de' Medici, of the younger branch of the ruling house, was made duke. Acting as lieutenant for the Spaniards, he subsequently (1555) subdued Siena, and bequeathed to his descendants the grand-duchy of Tuscany.

#### *Spanish-Austrian Ascendency.*

It was high time, after the sack of Rome in 1527, that Charles V. should undertake Italian affairs. The country was exposed to anarchy, of which this had been the last and most disgraceful example. The Turks were threatening Western Europe, and Luther was inflaming Germany. By the treaty of Barcelona in 1529 the pope and emperor made terms. By that of Cambray in the same year France relinquished Italy to Spain. Charles then entered the port of Geneva, and on the 5th of November met Clement VII. at Bologna. He there received the imperial crown, and summoned the Italian princes for a settlement of all disputed claims. Francesco Sforza, the last and childless heir of the ducal house, was left in Milan till his death, which happened in 1535. The republic of Venice was respected in her liberties and Lombard territories. The Este family received a confirmation of their duchy of Modena and Reggio, and were invested in their fief of Ferrara by the pope. The marquisate of Mantua was made a duchy; and Florence was secured, as we have seen, to the Medici. The great gainer by this settlement was the papacy, which held the most substantial Italian province, together with a prestige that raised it far above all rivalry. The rest of Italy, however parcelled, henceforth became but a dependence upon Spain. Charles V., it must be remembered, achieved his conquest and confirmed his authority far less as emperor than as the heir of Castile and Aragon. A Spanish viceroy in Milan and another in Naples, supported by Rome and by the minor princes who followed the policy dictated to them from Madrid, were sufficient to preserve the whole peninsula in a state of somnolent inglorious servitude.

From 1530 until 1796, that is, for a period of nearly three centuries, the Italians had no history of their own. Their annals are filled with records of dynastic changes and redistributions of territory, consequent upon treaties signed by foreign powers, in the settlement of quarrels which no wise concerned the people. Italy only too often became the theatre of desolating and distracting wars. But these wars were fought for the most part by alien armies; the points at issue were decided beyond the Alps; the gains accrued to royal families whose names were unpronounceable by southern tongues. The affairs of Europe during the years when Hapsburg and Bourbon fought their domestic battles with the blood of noble races may teach grave lessons to all thoughtful men of our days, but none bitterer, none fraught with more insulting recollections, than to the Italian people, who were haggled over like dumb driven cattle in the mart of chaffering kings. We cannot wholly acquit the Italians of their share of blame. When they might have won national independence, after their warfare with the Swabian emperors, they let the golden opportunity slip. Pampered with commercial prosperity, eaten to the core with inter-urban rivalries, they submitted to despots, renounced the use of arms, and offered themselves, in the hour of need, defenceless and disunited to the shock of puissant nations. That they had created modern civilization for Europe availed them nothing. Italy, intellectually first among the peoples, was now politically and practically last; and nothing to her historian is more heart-rending than to watch the gradual extinction of her spirit in this age of slavery.

In 1534 Alessandro Farnese, who owed his elevation to his sister Giulia, one of Alexander VI.'s mistresses, took the tiara with the title of Paul III. It was his ambition to create a duchy for his family; and with this object he gave Parma and Piacenza to his son Pier Luigi. After much wrangling between the French and Spanish parties, the duchy was confirmed in 1586 to Ottaviano Farnese and his son Alessandro, better known as Philip II.'s general, the prince of Parma. Alessandro's descendants reigned in Parma and Piacenza till the year 1731. Paul III.'s pontificate was further marked by important changes in the church, all of which confirmed the spiritual autocracy of Rome. In 1540 this pope approved of Leyola's foundation, and secured the powerful militia of the Jesuit order. The Inquisition was established with almost unlimited powers in Italy, and the press was placed under its jurisdiction. Thus free thought received a check, by which not only ecclesiastical but political tyrants knew how to profit. Henceforth it was impossible to publish or to utter a word which might offend the despots of church or state; and the Italians had to amuse their leisure with the polite triflings of academics. In 1545 a council was opened at Trent for the reformation of church discipline and the promulgation of orthodox doctrine. The decrees of this council defined Roman Catholicism against the Reformation; and, while failing to regenerate morality, they enforced a hypocritical observance of public decency. Italy to outer view put forth blossoms of hectic and hysterical piety, though at the core her clergy and her aristocracy were more corrupt than ever.

In 1556 Philip II., by the abdication of his father Charles V., became king of Spain. He already wore the crown of the Two Sicilies, and ruled the duchy of Milan. In the next year Ferdinand, brother of Charles, was elected emperor. The French, meanwhile, had not entirely abandoned their claims on Italy. Gian Pietro Caraffa, who was made pope in 1555 with the name of Paul IV., endeavoured to revive the ancient papal policy of leaning upon France. He encouraged the duke of Guise to undertake the conquest of Naples, as Charles of Anjou had been

Settle-  
ment of  
Italy by  
Spain.

Foreign  
dominion  
Paul III.

Reign of  
Philip  
II.

summoned by his predecessors. But such schemes were now obsolete and anachronistic. They led to a languid lingering Italian campaign, which was settled far beyond the Alps by Philip's victories over the French at St Quentin and Gravelines. The peace of Câteau Cambresis, signed in 1559, left the Spanish monarch undisputed lord of Italy. Of free commonwealths there now survived only Venice, which, together with Spain, achieved for Europe the victory of Lepanto in 1573; Genoa, which, after the ineffectual Fieschi revolution in 1547, abode beneath the rule of the great Doria family, and held a feeble sway in Corsica; and the two insignificant republics of Lucca and San Marino.

The future hope of Italy, however, was growing in a remote and hitherto neglected corner. A clause in the treaty of Câteau Cambresis recognized the right of Emmanuele Filiberto, duke of Savoy, to Piedmont. He owed this recognition, as Alessandro owed his duchy of Parma, to the fact that he was one of Philip's bravest generals. Yet Emmanuele Filiberto represented the oldest and not the least illustrious reigning house in Europe, and his descendants were destined to achieve for Italy the independence which no other power or prince had given her since the fall of ancient Rome. It is therefore needful at this point to trace the history of the counts of Savoy from the date of their first emergence on the stage of Italian politics.

The  
house of  
Savoy.

In the 10th century the founders of the house of Savoy were masters over Burgundy and Western Lombardy. Their provinces stretched beyond what is now called Savoy on the west and north, and southward touched the Mediterranean at Savona. In the course of the next two centuries the family divided. Its elder branch ruled Savoy and the northern shores of Lake Geneva. The younger line held Piedmont with the city of Turin for capital. The former were frequently at war with the dauphins of Vienna and the house of Hapsburg, seeking to extend their domains in the direction of Switzerland and Provence. The latter proved but ill neighbours to the marquises of Montferrat and Saluzzo. When the first league of the Swiss was formed, the counts of Savoy were vigorously driven back within their northern borders. At the same time the powers of France repelled them from Provence. Entrenched within their mountains, they now looked towards Italy for expansion. This southward growth of a state which had hitherto been undefined between its cisalpine and transalpine provinces was further determined by the union of the two branches of the family in the person of Amadeus VIII. Succeeding to the honours of the elder line in 1391, he joined Piedmont to Savoy in 1418, and received the title of duke from the emperor Sigismund. During his lifetime he annexed Saluzzo, took Chivasso from Montferrat, and received Vercelli from Filippo Maria Visconti. Nice had already joined itself to Savoy in 1388. The duchy of Savoy, checked in its development upon the further side of the Alpine barrier, gained in solidity and extent upon the south, and took rank definitely from this time forward as a considerable Italian power. Amadeus was one of the most remarkable personages of his day. Having built up the fortunes of his house by diplomatic ability in an age of policy and intrigue, he abdicated in 1434, and went into cloistral retirement at Ripaille. Hence he emerged in 1440 to receive the papal tiara from the council of Basel. He took the name of Felix V., but resigned in 1449, leaving Nicholas V. sole pope. When he died in 1451, he had reigned for sixty-one years as count, duke, prior of a hermit convent, anti-pope, and dean of the Holy College. The immediate successors of Amadeus VIII. undid a great deal of his work. They entered into unprofitable warfare with Geneva, Freiburg, Bern, and Vaud, and were still further shorn of territory

and prestige upon the side of Switzerland. The French invaded Savoy, and their Lombard domains became the theatre of the Franco-Spanish wars. When Emmanuele Filiberto succeeded to his father Charles III. in 1553, he was a duke without a duchy. But the princes of the house of Savoy were a race of warriors; and what Emmanuele Filiberto lost as sovereign he regained as captain of adventure in the service of his cousin Philip II. The treaty of Câteau Cambresis in 1559, and the evacuation of the Piedmontese cities held by French and Spanish troops in 1574, restored his state. By removing the capital from Chambéry to Turin, he completed the transformation of the dukes of Savoy from Burgundian into Italian sovereigns. They still owned Savoy beyond the Alps, the plains of Bresse, and the maritime province of Nice.

Emmanuele Filiberto was succeeded by his son Carlo Emmanuele I., who married Catherine, a daughter of Philip II. He seized the first opportunity of annexing Saluzzo, which had been lost to Savoy in the last two reigns, and renewed the disastrous policy of his grandfather Charles III. by invading Geneva and threatening Provence. Henry IV. of France forced him in 1601 to relinquish Bresse and his Burgundian possessions. In return he was allowed to keep Saluzzo. All hopes of conquest on the transalpine side were now quenched; but the keys of Italy had been given to the dukes of Savoy; and their attention was still further concentrated upon Lombard conquests. Carlo Emmanuele now attempted the acquisition of Montferrat, which was soon to become vacant by the death of Francesco Gonzaga, who held it together with Mantua. In order to secure this territory, he went to war with Philip III. of Spain, and allied himself with Venice and the Grisons to expel the Spaniards from the Valtelline. When the male line of the Gonzaga family expired in 1627, Charles, duke of Nevers, claimed Mantua and Montferrat in right of his wife, the only daughter of the last duke. Carlo Emmanuele was now checkmated by France, as he had formerly been by Spain. The total gains of all his strenuous endeavours amounted to the acquisition of a few places on the borders of Montferrat.

Not only the Gonzagas, but several other ancient ducal families, died out about the date which we have reached. The legitimate line of the Estensi ended in 1597 by the death of Alfonso II., the last duke of Ferrara. He left his domains to a natural relative, Cesare d'Este, who would in earlier days have inherited without dispute, for bastardy had been no bar on more than one occasion in the Este pedigree. Urban VIII., however, put in a claim to Ferrara, which, it will be remembered, had been recognized a papal fief in 1530. Cesare d'Esté had to content himself with Modena and Reggio, where his descendants reigned as dukes till 1794. Under the same pontiff, the Holy See absorbed the duchy of Urbino on the death of Francesco Maria II., the last representative of Montefeltro and Della Rovere. The popes were now masters of a fine and compact territory, embracing no inconsiderable portion of Countess Matilda's legacy, in addition to Pippin's donation and the patrimony of St Peter. Meanwhile Spanish fanaticism, the suppression of the Huguenots in France, and the Catholic policy of Austria combined to strengthen their authority as pontiffs. Urban's predecessor, Paul V., advanced so far as to extend his spiritual jurisdiction over Venice, which, up to the date of his election (1605), had resisted all encroachments of the Holy See. Venice offered the single instance in Italy of a national church. The republic managed the tithes, and the clergy acknowledged no chief above their own patriarch. Paul V. now forced the Venetians to admit his ecclesiastical supremacy; but they refused to readmit the Jesuits, who had been expelled in 1606. This, if we do not count the proclamation of

Extinction  
of  
old ducal  
families.



James I. of England (1604), was the earliest instance of the order's banishment from a state where it had proved disloyal to the commonwealth.

Decline  
of Venice  
and  
Spain.

Venice rapidly declined throughout the 17th century. The loss of trade consequent upon the closing of Egypt and the Levant, together with the discovery of America and the sea-route to the Indies, had dried up her chief source of wealth. Prolonged warfare with the Ottomans, who forced her to abandon Candia in 1669, as they had robbed her of Cyprus in 1570, still further crippled her resources. Yet she kept the Adriatic free of pirates, notably by suppressing the sea-robbers called *Uscocchi* (1601-1617), maintained herself in the Ionian Islands, and in 1684 added one more to the series of victorious episodes which render her annals so romantic. In that year Francesco Morosini, upon whose tomb we still may read the title *Peloponnesiacus*, wrested the whole of the Morea from the Turks. But after his death in 1715 the republic relaxed her hold upon his conquests. The Venetian nobles abandoned themselves to indolence and vice. Many of them fell into the slough of pauperism, and were saved from starvation by public doles. Though the signory still made a brave show upon occasions of parade, it was clear that the state was rotten to the core, and sinking into the decrepitude of dotage. The Spanish monarchy at the same epoch dwindled with apparently less reason. Philip's Austrian successors reduced it to the rank of a secondary European power. This decline of vigour was felt, with the customary effects of discord and bad government, in Lower Italy. The revolt of Masaniello in Naples (1647), followed by rebellions at Palermo and Messina, which placed Sicily for a while in the hands of Louis XIV. (1676-1678), were symptoms of progressive anarchy. The population, ground down by preposterous taxes, ill-used as only the subjects of Spaniards, Turks, or Bourbons are handled, rose in blind exasperation against their oppressors. It is impossible to attach political importance to these revolutions; nor did they bring the people any appreciable good. The destinies of Italy were decided in the cabinets and on the battlefields of Northern Europe. A Bourbon at Versailles, a Hapsburg at Vienna, or a thick-lipped Lorrainer, with a stroke of his pen, wrote off province against province, regarding not the populations who had bled for him or thrown themselves upon his mercy.

Wars of  
succes-  
sion.

This inglorious and passive chapter of Italian history is continued to the date of the French Revolution with the records of three dynastic wars, the war of the Spanish succession, the war of the Polish succession, the war of the Austrian succession, followed by three European treaties, which brought them respectively to diplomatic terminations. Italy, handled and rehandled, settled and resettled, upon each of these occasions, changed masters without caring or knowing what befel the principals in any one of the disputes. Humiliating to human nature in general as are the annals of the 18th century campaigns in Europe, there is no point of view from which they appear in a light so tragi-comic as from that afforded by Italian history. The system of setting nations by the ears with the view of settling the quarrels of a few reigning houses was reduced to absurdity when the people, as in these cases, came to be partitioned and exchanged without the assertion or negation of a single principle affecting their interests or rousing their emotions.

Spanish  
succes-  
sion.

In 1700 Charles II. died, and with him ended the Austrian family in Spain. Louis XIV. claimed the throne for Philip, duke of Anjou. Charles, archduke of Austria, opposed him. The dispute was fought out in Flanders; but Lombardy felt the shock, as usual, of the French and Austrian dynasties. The French armies were more than once defeated by Prince Eugene of Savoy, who drove them

out of Italy in 1707. Therefore, in the peace of Utrecht (1713), the services of the house of Savoy had to be duly recognized. Vittorio Amedeo II. received Sicily with the title of king. Montferrat and Alessandria were added to his northern provinces, and his state was recognized as independent. Charles of Austria, now emperor, took Milan, Mantua, Naples, and Sardinia for his portion of the Italian spoil. Philip founded the Bourbon line of Spanish kings, renouncing in Italy all that his Hapsburg predecessors had gained. Discontented with this diminution of the Spanish heritage, Philip V. married Elisabetta Farnese, heiress to the last duke of Parma, in 1714. He hoped to secure this duchy for his son, Don Carlos; and Elisabetta further brought with her a claim to the grand-duchy of Tuscany, which would soon become vacant by the death of Gian Gastone de' Medici. After this marriage Philip broke the peace of Europe by invading Sardinia. The Quadruple Alliance was formed, and the new king of Sicily was punished for his supposed adherence to Philip V. by the forced exchange of Sicily for the island of Sardinia. It was thus that in 1720 the house of Savoy assumed the regal title which it bore until the declaration of the Italian kingdom in this century. Vittorio Amedeo II.'s reign was of great importance in the history of his state. Though a despot, as all monarchs were obliged to be at that date, he reigned with prudence, probity, and zeal for the welfare of his subjects. He took public education out of the hands of the Jesuits, which, for the future development of manliness in his dominions, was a measure of incalculable value. The duchy of Savoy in his days became a kingdom, and Sardinia, though it seemed a poor exchange for Sicily, was a far less perilous possession than the larger and wealthier island would have been. In 1730 Vittorio Amedeo abdicated in favour of his son Carlo Emmanuele III. Repenting of this step, he subsequently attempted to regain Turin, but was imprisoned in the castle of Rivoli, where he ended his days in 1732.

The war of the Polish succession which now disturbed Europe is only important in Italian history because the treaty of Vienna in 1738 settled the disputed affairs of the duchies of Parma and Tuscany. The duke Antonio Farnese died in 1731; the grand-duke Gian Gastone de' Medici died in 1737. In the duchy of Parma Don Carlos had already been proclaimed. But he was now transferred to the Two Sicilies, while Francis of Lorraine, the husband of Maria Theresa, took Tuscany and Parma. Milan and Mantua remained in the hands of the Austrians. On this occasion Carlo Emmanuele acquired Tortona and Novara.

Worse complications ensued for the Italians when the Austrian emperor Charles VI., father of Maria Theresa, died in 1740. The three branches of the Bourbon house, ruling in France, Spain, and the Sicilies, joined with Prussia, Bavaria, and the kingdom of Sardinia to despoil Maria Theresa of her heritage. Lombardy was made the seat of war; and here the king of Sardinia acted as in some sense the arbiter of the situation. After war broke out, he changed sides and supported the Hapsburg-Lorraine party. At first, in 1745, the Sardinians were defeated by the French and Spanish troops. But Francis of Lorraine, elected emperor in that year, sent an army to the king's support, which in 1746 obtained a signal victory over the Bourbons at Piacenza. Carlo Emmanuele now threatened Genoa. The Austrian soldiers already held the town. But the citizens expelled them, and the republic kept her independence. In 1748 the treaty of Aix-la-Chapelle, which put an end to the war of the Austrian succession, once more redivided Italy. Parma, Piacenza, and Guastalla were formed into a duchy for Don Philip, brother of Charles III. of the Two Sicilies, and son of Philip V. of Spain. Charles III. was confirmed in his kingdom of the

Two Sicilies. The Austrians kept Milan and Tuscany. The duchy of Modena was placed under the protection of the French. So was Genoa, which in 1755, after Paoli's insurrection against the misgovernment of the republic, ceded her old domain of Corsica to France.

From the date of this settlement until 1792, Italy enjoyed a period of repose and internal amelioration under her numerous paternal despots. It became the fashion during these forty-four years of peace to encourage the industrial population and to experimentalize in economical reforms. The emperor Francis I. ruled the grand-duchy of Tuscany by lieutenants until his death in 1765, when it was given, as an independent state, to his third son, Peter Leopold. The reign of this duke was long remembered as a period of internal prosperity, wise legislation, and important public enterprise. Leopold, among other useful works, drained the Val di Chiana, and restored those fertile upland plains to agriculture. In 1790 he succeeded to the empire, and left Tuscany to his son Ferdinand. The kingdom of Sardinia was administered upon similar principles, but with less geniality. Carlo Emanuele made his will law, and erased the remnants of free institutions from his state. At the same time he wisely followed his father's policy with regard to education and the church. This is perhaps the best that can be said of a king who incarnated the stolid absolutism of the period. From this date, however, we are able to trace the revival of independent thought among the Italians. The European ferment of ideas which preceded the French Revolution expressed itself in men like Alfieri, the fierce denouncer of tyrants, Beccaria, the philosopher of criminal jurisprudence, Volta, the physicist, and numerous political economists of Tuscany. Moved partly by external influences and partly by a slow internal reawakening, the people was preparing for the efforts of the present century. The papacy, during this period, had to reconsider the question of the Jesuits, who made themselves universally odious, not only in Italy, but also in France and Spain. In the pontificate of Clement XIII. they ruled the Vatican, and almost succeeded in embroiling the pope with the concerted Bourbon potentates of Europe. His successor, Clement XIV., suppressed the order altogether by a brief of 1773. For the divisions of Italy at this time see Plate VI.

#### *Achievement of Independence.*

The malarious tranquillity of Italy beneath her Austrian and Bourbon despots was rudely shaken by the French Revolution. This is not the place to describe Napoleon's campaign of 1796. But the treaty of Campo Formio, which resettled Italy in 1797, has to be described. Northern and Central Italy was redivided into four republics,—the Cisalpine, with its capital in Milan; the Ligurian, with Genoa for capital; the Cispadane, with Bologna; the Tiberine, with Rome. Venice (where the last doge, Luigi Manini, had dissolved the republic of St Mark amid the execrations of the populace in the month of May) was flung, together with her territory between the Adige and the Adriatic, as a compensation for other losses, to the Austrian empire. In the next year, 1798, Lower Italy became the Parthenopean republic, with Naples for its capital. Carlo Emanuele IV., now king of Sardinia, resigned his dominions. Pius VI. fled from Rome, and died in France in 1799. The whole of the old order of the peninsula was thus destroyed at a blow. Yet the people, at first, gained little but an exchange of masters, increased taxes, and a participation in the doubtful glories of the French republic. While Bonaparte was absent in Egypt, his recent settlement of Italian affairs was upset, and the French were everywhere driven out of the peninsula by force of arms. He returned, and Marengo (1800) made

him once more master of Italy. Four years later, having proclaimed himself emperor, he took the Lombard crown in St Ambrogio at Milan. Italy now ranked as his kingdom, and a new settlement of her provinces had to be effected. The pope was left in Rome, and Ferdinand in Naples. Tuscany was rechristened the kingdom of Etruria, and given to the Bourbons: The Ligurian and Cisalpine republics were placed under the viceroy Eugene Beauharnais. After Ansterlitz, Venice was added to this North Italian kingdom; and in 1806 Bonaparte made the Bourbons yield Naples to his brother Joseph. When Joseph went in 1808 to Madrid, Joachim Murat succeeded him as king in Naples. Sicily remained in the hands of Ferdinand. In 1809 Pius VII. was deposed, and sent to France, and Rome was declared a part of the French empire. The gingerbread kingdom of Etruria was abolished, and Bonaparte's sister, Eliza, wife of a Colonel Bacciocchi, was made duchess of Tuscany, with the titles of duchess of Lucca and princess of Piombino. Ephemeral as were Bonaparte's successive divisions and redvisions of Italy into provinces for his generals and relatives, they exercised no little influence. From the period of the French rule we may date a new sense of nationality among Italians, generated by the military service of recruits drawn together from all districts in Napoleon's armies, by the temporary obliteration of most ancient boundaries, by the dethronement of alien and unloved princes, by the equal administration of one code of laws, and by the spirit of the revolution which animated all French institutions. Italy began to feel herself a nation, and though it was long before Europe suffered her to win national rights, the demand for them, which in our own days became too imperious to be resisted, was created in her people at this epoch.

The congress of Vienna in 1815 took down from the theatre of Italy all Bonaparte's decorations, and set up the old scenery in very nearly the old places. Vittorio Emanuele I. received back his kingdom of Sardinia, with the addition of Genoa. Venice and Milan were formed into the province of Lombardo-Venezia for Francis II., emperor of Austria. The old duchy of Parma was given for her lifetime to Maria Louisa, who, though the wife of Bonaparte, was still an Austrian princess. Upon her death it was to be restored to its former Bourbon prince, who received in the meanwhile Lucca as an equivalent. The Austrian Ferdinand III. was once again grand-duke of Tuscany, with the reversion of Lucca after Maria Louisa's decease. Francis, son of the Austrian archduke Ferdinand and Beatrice d'Este, became duke of Modena, with the reversion of Lunigiana on the same event. Pius VII. got back all the states of the church, and on his re-entry into Rome restored the Jesuits, who had proved their indispensability to tyrants. The Bourbon Ferdinand I. again joined Naples to his crown of Sicily. We have been careful to label these Ferdinands and Francis with their respective names of Austrian or Bourbon, in order that the partition of Italy between the two dynasties, and the large preponderance of Austrian over Bourbon influence, might be apparent. One significant detail has been omitted. The congress of Vienna recognized the independent republic of San Marino. On the top of a little mountain at the outskirts of the Apennines which overlook the sea by Rimini, sat Liberty, the queen of a few hundred citizens, surveying the muddy ocean of Franco-Spanish, Italo-Teutonic despotism which drowned Italy through all her length and breadth.

The Italian sovereigns, on returning to their respective states, proved that exile and the revolution had terrorized them into more determined tyranny. The civil and political reforms which had been instituted at the end of the last century were abandoned. The Jesuits were re-

Forty-four years' peace.

Plate VI.

Napoleonic government of Italy.

Restoration of Austrian and Bourbon princes.



stored; many suppressed monasteries were re-established; and the mortmain laws were repealed. Elementary education was narrowed in its limits, and thrown into the hands of the clergy. Professors suspected of liberal views were expelled from the universities, and the press was placed under the most rigid supervision. All persons who had taken part in the Napoleonic governments, or who were known to entertain patriotic opinions, found themselves harassed, watched, spied upon, and reported. The cities swarmed with police agents and informers. The passport system was made more stringent, and men were frequently refused even a few days' leave of absence from their homes. The Code Napoléon was withdrawn from those provinces which had formed part of the Italian kingdom, while, in the papal states, the administration was placed again in the hands of ecclesiastics.

(Austrian preponderance. This political and spiritual reign of terror, which had for its object the crushing of Italian liberalism, was sanctioned and supported by Austria. Each petty potentate bound himself to receive orders from Vienna, and, in return for this obedience, the emperor guaranteed him in the possession of his throne. The Lombardo-Venetian kingdom, powerfully defended and connected with Austria by land and sea, became one huge fortress, garrisoned with armed men, in perpetual menace of the country. Under these conditions the Italians were half maddened, and thousands of otherwise quiet citizens, either in the hope of finding redress and protection, or only from a feeling of revenge, joined secret revolutionary societies; for it must not be supposed that the revolution had left the Italians as passive as it found them. A new spirit was astir, which was not likely to be checked by the arrangements of the European congress—the spirit of national independence. During the convulsions caused by Napoleon's conquest of Italy, the allied powers had themselves fostered this spirit, in order to oppose French rule. The Austrians, the English, and Murat, in turn, had publicly invited the Italians to fight for their national independence. And now the people, who relied upon these proclamations and expected the fulfilment of so many promises, found themselves by the consent of Europe delivered over, tied and gagged, to a foreign oppressor. To take but one example: Ferdinand, when he quitted Naples in May 1815, addressed a proclamation to his subjects, solemnly engaging to respect the laws that should in his absence be decreed by a constitution. In June he pledged himself at Vienna to introduce into his kingdom no institutions irreconcilable with those which Austria might establish in her own dependencies. Accordingly in 1816 he put an end to the Sicilian constitution of 1812.

Revolutionary struggles. Tyranny was met by conspiracy; and in a short while, the Carbonari societies, with Sanfedisti and many other revolutionary associations, had extended their organization through the length and breadth of the peninsula. The discontent of the Italians smouldered for five years; but in 1820 it broke into open flame. On the 1st of January in that year the Spaniards proclaimed their constitution of the Cortes, which was modelled on the type furnished by the earlier French Revolution. Moved by this example, the royal army mutinied at Naples in July, and a few days afterwards Palermo rushed to arms. Ferdinand was so surprised by the sudden outbreak of this revolt that he hastily granted the constitution, named his son Francis vicar-general of his kingdom, and betook himself to Austria. The Austrians marched 80,000 men into Lombardy, and Great Britain and France sent their fleets down to the Bay of Naples. At a congress held in the spring of 1821 at Laybach, the allied powers authorized Austria to crush the revolution in Lower Italy. Austrian troops entered Naples on the 23d of March; and, when Ferdinand followed

them, he had nothing to do but to execute vengeance, by mock trials, on his insurgent subjects.

While these events were taking place, another military insurrection broke out in Piedmont, where the Spanish constitution was proclaimed. The king felt himself bound by the congress of Laybach, and refused to make any concessions. Therefore, on the 13th of March, he abdicated; and in the absence of his brother and heir, Carlo Felice, his distant cousin, Carlo Alberto, prince of Carignano, was appointed regent. Carlo Alberto represented a branch of the reigning house which had been separated nearly two centuries from the throne. Educated, during the French occupation, more like a private citizen than like a prince, he grew up with liberal inclinations, and there is no doubt that his concessions to the insurrectionists in Piedmont at this moment were actuated by sympathy rather than by any vulgar desire to gain power. When, however, Carlo Felice returned and declared that his brother's abdication had been forced and therefore illegal, Carlo Alberto's sense of loyalty to the dynasty overcame his liberal instincts. He submitted to the new king's authority, and the old regime was re-established in Piedmont on as absolute a basis as before.

These movements were followed by state trials and executions, and the terrorism of the tyrannies augmented. Silvio Pellico, at the close of an inefficient disturbance at Milan, was sent to life-imprisonment at Spielberg. In the papal states Leo XII. adopted a coercive policy still more grinding and humiliating. For nine years the despots and the conspirators confronted each other, until the July revolution of Paris in 1830 gave new hope and energy to the latter. On this occasion the conflagration burst out at Modena, where the duke Francesco IV. had been for some time past in secret negotiation with the patriotic party, headed by Ciro Menotti. It appears that the secret object of this autocrat was to employ the revolution against his neighbours, and to make himself sovereign of Upper Italy, by the help of the conspirators. But when the revolution declared itself, and spread to Parma, Bologna, and the Romagna, Francesco turned upon his friend Menotti, and succeeded in putting him to death. It took but little time or trouble to check this revolt, which was unsupported by armed force. Austrian troops moved into Emilia and Romagna, restored the old order, and marched on to Rome, which they occupied. Louis Philippe, now king of the French, being jealous of the Austrians at Rome, occupied Ancona for the French in 1832; but the cause of Italian liberty received no support from the bourgeois king, who strove to keep on good terms with established authorities.

From 1831 until 1846 Italy remained discontentedly and uneasily tranquil. The infamous misgovernment of Rome and Naples continued; and in Lower Italy numerous petty insurrections, caused by the misery of the people, and the cholera which raged in 1837, were easily suppressed. Yet it was clear to all competent observers that this state of things could not last. The Italian sovereigns were seated over a volcano, which vibrated to the least stir in its neighbour, France, and which was slowly accumulating explosive material. Among the most powerful instruments now invented by the party of independence must be reckoned the scientific congress. This body, ostensibly formed for the study of science, assembled every year in some Italian city. Its meetings really served to propagate liberal opinions and to establish relations between the patriots of different districts. Meanwhile the great men who were destined to achieve the future union of Italy had appeared upon the stage, and were busy through this period with their pen and voice. Giuseppe Mazzini, born in 1808 at Genoa, made himself the recognized head of a party called by the name of Young Italy. It was his aim

Revolution in absence?

to organize the forces of the revolution, and to establish the one and indivisible republic in Europe. Though he strove in the cause of Italy, his scheme for the regeneration of society far exceeded the limits of that country. He declared war upon established order in its ancient forms all over the world, and was willing to use conspiracy, if not assassination, in order to achieve his ends. Thus, though the spirit infused into the Italians by Mazzini's splendid eloquence aroused the people to a sense of their high destinies and duties, though he was the first to believe firmly that Italy could and would be one free nation, yet the means he sanctioned for securing this result, and the policy which was inseparable from his opinions, proved obstacles to statesmen of more practical and sober views. It was the misfortune of Italy at this epoch that she had not only to fight for independence, but also to decide upon the form of government which the nation should elect when it was constituted. All right-thinking and patriotic men agreed in their desire to free the country from foreign rule, and to establish national self-government. But should they aim at a republic or a constitutional monarchy? Should they be satisfied with the hegemony of Piedmont? Should they attempt a confederation, and if so, how should the papacy take rank, and should the petty sovereigns be regarded as sufficiently Italian to hold their thrones? These and many other hypothetical problems distracted the Italian patriots. It was impossible for them, in the circumstances, first to form the nation and then to decide upon its government; for the methods to be employed in fighting for independence already implied some political principle. Mazzini's manipulation of conspiracy, for instance, was revolutionary and republican; while those who adhered to constitutional order, and relied upon the arms of Piedmont, had virtually voted for Sardinian hegemony. The unanimous desire for independence existed in a vague and nebulous condition. It needed to be condensed into workable hypotheses; but this process could not be carried on without the growth of sects perilous to common action.

The party of Young Italy, championed by Mazzini, was the first to detach itself, and to control the blindly working forces of the Carbonari movement by a settled plan of action. It was the programme of Young Italy to establish a republic by the aid of volunteers recruited from all parts of the peninsula. When Carlo Alberto came to the throne, Mazzini addressed him a letter, as equal unto equal, calling upon the king to defy Austria and rely upon God and the people. Because Carlo Alberto (who, in spite of his fervent patriotism and genuine liberality of soul, was a man of mixed opinions, scrupulous in his sense of constitutional obligation, melancholy by temperament, and superstitiously religious), found himself unwilling or unable to take this step, the Mazzinisti denounced him as a traitor to 1821 and a retrogressive autocrat. In his exile at Geneva, Mazzini now organized an armed attempt on Savoy. He collected a few hundred refugees of all nations, and crossed the frontier in 1833. But this feeble attack produced no result beyond convincing Carlo Alberto that he could not trust the republicans. Subsequent attempts on the king's life roused a new sense of loyalty in Piedmont, and defined a counter-body of opinion to Mazzini's. The patriots of a more practical type, who may be called moderate liberals, began, in one form or another, to aim at achieving the independence of Italy constitutionally by the help of the Sardinian kingdom. What rank Sardinia would take in the new Italy remained an open question. The publication of Vincenzo Gioberti's treatise, *Il Primato morale e civile degli Italiani*, in 1843, considerably aided the growth of definite opinion. His utopia was a confederation of Italian powers, under the spiritual presidency

of the papacy, and with the army of Piedmont for sword and shield. This book had an immense success. It made timid thinkers feel that they could join the liberals without sacrificing their religious or constitutional opinions. At the same date Cesare Balbo's *Speranze d'Italia* exercised a somewhat similar influence, through its sound and unobversive principles. In its pages Balbo made one shrewd guess, that the Eastern Question would decide Italian independence. Massimo d'Azeglio, who also was a Piedmontese; the poet Giusti, the Baron Ricasoli, and the Marchese Gino Capponi in Tuscany; together with Alessandro Manzoni at Milan, and many other writers scattered through the provinces of Italy, gave their weight to the formation of this moderate liberal party. These men united in condemning the extreme democracy of the Mazzinisti, and did not believe that Italy could be regenerated by merely manipulating the insurrectionary force of the revolution. On political and religious questions they were much divided in detail, suffering in this respect from the weakness inherent in liberalism. Yet we are already justified in regarding this party as a sufficient counterpoise to the republicans; and the man who was destined to give it coherence, and to win the great prize of Italian independence by consolidating and working out its principles in practice, was already there. The count Camillo Benso di Cavour had been born in 1810, two years later than Mazzini. He had not yet entered upon his ministerial career, but was writing articles for the *Risorgimento*, which at Turin opposed the Mazzinistic journal *Concordia*, and was devoting himself to political and economical studies. It is impossible to speak of Mazzini and Cavour without remembering the third great regenerator of Italy, Giuseppe Garibaldi. At this date he was in exile; but a few years later he returned, and began his career of popular deliverance in Lombardy. Mazzini, the prophet, Garibaldi, the knight-errant, and Cavour, the statesman, of Italian independence, were all natives of the kingdom of Sardinia. But their several positions in it were so different as to account in no small measure for the very divergent parts they played in the coming drama. Mazzini was a native of Genoa, which ill tolerated the enforced rule of Turin. Garibaldi came from Nice, and was a child of the people. Cavour was born in the midst of that stiff aristocratical society of old Piedmont which has been described so vividly by D'Azeglio in his *Ricordi*. The Piedmontese nobles had the virtues and the defects of English country squires in the last century. Loyal, truthful, brave, hard-headed, tough in resistance, obstinately prejudiced, they made excellent soldiers, and were devoted servants of the crown. Moreover, they hid beneath their stolid exterior greater political capacity than the more genial and brilliant inhabitants of Southern and Central Italy. Cavour came of this race, and understood it. But he was a man of exceptional quality. He had the genius of statesmanship,—a practical sense of what could be done, combined with rare dexterity in doing it, fine diplomatic and parliamentary tact, and noble courage in the hour of need. Without the enthusiasm, amounting to the passion of a new religion, which Mazzini inspired, without Garibaldi's brilliant achievements, and the idolatry excited by this pure-hearted hero in the breasts of all who fought with him and felt his sacred fire, there is little doubt that Cavour would not have found the creation of United Italy possible. But if Cavour had not been there to win the confidence, support, and sympathy of Europe, if he had not been recognized by the body of the nation as a man whose work was solid and whose sense was just in all emergencies, Mazzini's efforts would have run to waste in questionable insurrections, and Garibaldi's feats of arms must have added but one chapter more to the history of unproductive patriotism. While, therefore, we



recognize the part played by each of these great men in the liberation of their country, and while we willingly ignore their differences and disputes, it is Cavour whom we must honour with the title of the Maker of United Italy.

Constitutional  
reform.

From this digression, which was necessary in order to make the next acts in the drama clear, we now return to the year 1846. Misrule had reached its climax in Rome, and the people were well-nigh maddened, when Gregory XVI. died, and Pius IX. was elected in his stead. It seemed as though an age of gold had dawned; for the greatest of all miracles had happened. The new pope declared himself a liberal, proclaimed a general amnesty to political offenders, and in due course granted a national guard, and began to form a constitution. The Neo-Guelph school of Gioberti believed that their master's utopia was about to be realized. Italy went wild with joy and demonstrations. The pope's example proved contagious. Constitutions were granted in Tuscany, Piedmont, and Rome in 1847. The duke of Lucca fled, and his domain was joined to Tuscany. Only Austria and Naples declared that their states needed no reforms. On the 2d of January 1848 a liberal demonstration at Milan served the Austrians for pretext to massacre defenceless persons in the streets. These Milanese victims were hailed as martyrs all over Italy, and funeral ceremonies, partaking of the same patriotic character as the rejoicings of the previous year, kept up the popular agitation. On the 12th of January Palermo rose against King Ferdinand II., and Naples followed her example on the 27th. The king was forced in February to grant the constitution of 1812, to which his subjects were so ardently attached.

Revolution of  
1848.

While Italy was thus engaged in making terms with her own sovereigns, the French revolution broke out. Louis Philippe fled to England, and the republic was declared. This altered affairs in Italy, and threw a temporary power into the hands of the Mazzinisti. Sicily pronounced herself independent of the Bourbons, and called the duke of Genoa to the throne. In Naples, the moderate liberal government, of which Poerio had been a member, yielded to a more radical administration. The patriots and the king's troops came to blows, ending in Ferdinand's victory and the remodelling of the constitution. Lombardy rose in insurrection. The Austrians were expelled from Milan, and the governor of Venice capitulated. Provisional republican governments were formed, at Milan under the presidency of Casati, at Venice under that of Daniele Manin. Impelled by the overwhelming enthusiasm which prevailed in Upper Italy, Carlo Alberto declared war on Austria in March. On the 8th of April he pushed his troops beyond the Mincio; while Piacenza, Parma, Modena, and the Lombardo-Venetian kingdom voted their union to Sardinia by universal suffrage. But the Austrian general, Radetzky, though he lost a battle at Goito, and was forced to witness the capitulation of Peschiera in May, had not given up the game. The pope's troops were established at Vicenza to support the Sardinians. These Radetzky compelled to surrender in June; he then attacked Carlo Alberto's army, who were engaged in the investment of Mantua. A complete victory upon the 25th of July at Custoza enabled Radetzky to re-enter Milan. Carlo Alberto had to retire beyond the Ticinò and to beg for an armistice. News of this Austrian victory reached Naples, and gave Ferdinand the heart to quell the Sicilian revolt. On the 30th August Messina was bombarded, and such atrocities were perpetrated in the miserable city that the admirals of the French and English fleets had to interfere and extort an armistice from the conquerors. In the meanwhile, affairs had begun to change in Rome. The pope, frightened at the revolution which had already out-run his control, pronounced against the Austrian war and

Italian alliance. This roused republican hostility. His minister, the excellent Count Pellegrini Rossi, was murdered in November, and anarchy seemed to threaten the city. Pius escaped in disguise to Gaeta, where he was received by Ferdinand, whom not long since he had denounced as a rogne. From Gaeta he opened the new year, 1849, with a threat of excommunication to his subjects. The Romans were so irritated that the moderate liberal party had to yield to the ultra-radicals: and on the 9th of February Rome was declared a republic. The government was entrusted to three dictators, of whom Mazzini was the head. Tuscany, meanwhile, had lost her grand-duke. After opening parliament in January with a declaration that he intended to prosecute the war against Austria, he escaped in February on the English war-steamer "Bulldog" to Gaeta. A provisional government was established in Florence, and Mazzini did his best to render Tuscany a part of the new Roman republic. At this epoch two important personages appeared upon the scene—Gino Capponi, who led the moderate liberals, and Urbano Rattazzi, who headed the democratic party. The Florentines were not at bottom out of sympathy with their duke. Therefore they rejected Mazzini's overtures, and recalled Leopold upon the understanding that he would respect their free institutions. Still at Gaeta, the grand-duke mistrusted these advances, begged for Austrian troops, and, when they had arrived, re-entered Tuscany and suppressed the constitution. Such acts of perfidy as these, repeatedly committed by all the petty sovereigns of Italy with the exception of the house of Savoy, forced the people to abandon the theory of federation under existing governments, and to look for their salvation to Piedmont.

This growing confidence in the Sardinian monarchy was not shaken by the disastrous campaign of March 1849, which baptized the cause of Italian independence with the best blood of Piedmont, gave it a royal martyr, and pledged the dynasty of Savoy to a progressive policy from which it never afterwards for a single moment deviated. Pushed by the ultra-radicals, and burning with the purest zeal to liberate Italy, Carlo Alberto took the field again in March 1849 against the Austrians. On the 24th, after some preliminary movements, proving a want of good generalship and discipline in the Piedmontese army, Radetzky obtained a complete victory at Novara. The king of Sardinia abdicated on the field, in favour of his son, the duke of Savoy, Vittorio Emanuele II. Carlo Alberto, who had lived through times so troublous and perplexing, who had exposed himself to misunderstanding and misinterpretation, but in whom the devotion to Italy had become a religion, now took refuge at Oporto, where he died, broken-hearted, after a few months of illness. The pathos of this death checked the snarling of discordant parties; and, when the king's body was brought home to be buried on the heights of the Superga, the heart of Italy recognized his worth. Carlo Alberto, though still anathematized by the republican faction, became the saint of Italy. Hundreds of pilgrims flocked to his tomb. The loyalty of his subjects redoubled; and it was felt that, by serving Italy, they would glorify his memory. More than ever, by the disasters of Novara, were the dynasty and aristocracy and people of Sardinia pledged to that national policy which Carlo Alberto's son triumphantly accomplished. In the cottage homes of Piedmont and Lombardy travellers may still behold the old king's agony depicted side by side with the portraits of Cavour and Garibaldi and Vittorio Emanuele.

The intrigues of which Gaeta had been a centre provoked a crusade of the Catholic powers against republican and anti-papal Rome. A French expedition, under General Oudinot, landed at Civita Vecchia on the 25th of April, and on the 29th reached the walls of the city. The Neapolitan

army took up a position at the base of the Alban hills. Spaniards arrived at Fiumicino, and Austrians entered the Legations. The French professed to come as friends but the triumvirs of the Roman republic refused them entrance, and General Oudinot established his camp on the Janiculum. Garibaldi, who was guarding the frontier of the Abruzzi, returned and defeated the Neapolitans at Palestrina on the 11th of May. Still his assistance did not suffice to avert the French attack, and on July 2, after a siege of four weeks, the city capitulated. Mazzini and Garibaldi made good their escape. The French troops entered and held Rome for the pope. It was not until April 1850, however, that Pius IX. ventured to return. When he arrived in his capital, he began the reactionary reign, supported by his French garrison and Jesuit advisers, which only ended with the semi-forcible entry of the Italians in 1870.

Suppression of the revolution.

With the fall of Rome the hopes of the revolutionary party ended. Austrian troops replaced their ducal puppets in Parma, Modena, and Tuscany. King Ferdinand, rightly now named Bomba, terrorized his subjects into silence by the aid of Swiss mercenaries, artillery, and dungeons too loathsome to be described. Only Venice still held out, blockaded in the Adriatic and bombarded from the land, through all the horrors of famine, conflagration, and cholera, until the month of August. Few episodes in the history of that noble city are more glorious than this last desperate and patient struggle; and few names upon her muster-roll of heroes are equally illustrious with that of the lion-hearted and blameless Daniele Manin.

Reorganization of Sardinian kingdom.

In the disastrous year 1849 it seemed as though the fate of Italy was sealed. The republicans had done their best and failed at Milan, Rome, and Venice. The power of Piedmont was broken at Novara. And yet we have good cause to say that the miseries of this epoch wrought the future salvation of the race. The former vain trust in the Italian sentiment of petty courts, the Neo-Guelphic mysticism of Gioberti's party, the utopian confidence in papal liberalism, the vague schemes of confederation which had assumed many visionary forms, were all dissipated for ever. To rightly thinking men it became clear that the regeneration of Italy must be entrusted to Piedmont. When Vittorio Emmanuele entered Turin in silence after Novara, with a demoralized army and a ruined exchequer, the spirit of his people was cast down, but not extinguished. They had assumed responsibility, and were not going to abandon it. "The house of Savoy cannot retreat" became the watchword of the throne. D'Azeglio's *Nous recommencerons* expressed the determination of the ruling classes. It is true that at this crisis they had to combat the hostility and bitter jealousy of the republicans. Mazzini's party stirred up Genoa to revolution, and La Marmora received the ignoble task of restoring that intractable city to a sense of duty. "Better Italy enslaved than delivered over to the son of the traitor Carlo Alberto," exclaimed the prophet of democracy, whom no reverses could persuade that in such politics as those of Italy the half is better than the whole. But Mazzini was no longer a power of the first magnitude. The work which he had done for Italy was solid and abiding. Still he had failed to carry the bulk of the nation with him. Men of more sober aspirations saw that to aim at national independence and European reconstruction at one leap was utopian. Italy must first be made; and the only power capable of calling her into existence was Piedmont, still free and puissant among a crowd of feeble and anarchical despotisms. The experience of '49 proved that the armies of Piedmont, in the hour of need, could rely on volunteers of pith and nerve, in cities so downtrodden even as were Rome and Venice; for it must not be forgotten that the

republicans who sustained both sieges were members of the bourgeoisie and proletariat. This consolidation of opinion after the events of 1849 was proved by Gioberti's recantation of his earlier mysticism. In 1851 he published a new treatise the *Rinnovamento*, which distinctly indicated Piedmont as the substantial basis of Italian independence. Daniele Manin, now an exile in Paris, declared his adhesion to the same doctrine. The constitutional party was further strengthened by the adhesion of the leading republicans, Pallavicino and La Farina; and in 1857 the main point of unanimity was secured by the formation of the *Società Nazionale*, which kept sectarian jealousies in the background. Garibaldi, at this time less republican than he afterwards became, was himself a president of this political association. Henceforward the genuine Mazzinisti formed a permanent minority. They could do little more than to impede without perplexing or baffling the policy of the Piedmontese statesmen, who felt themselves to be supported by the instincts of the race at large.

Vittorio Emmanuele began his reign with Massimo d'Azeglio for minister. He steadily refused all Austrian advances, though enforced by his own wife and mother, both of whom were Austrian archduchesses. The house of Savoy had pledged itself to Italy, and the house had never broken faith. The first cares of the new ministry were devoted to internal reforms, to the organization of the army by La Marmora, and to financial measures. In 1850 they passed the so-called Siccardi law, which abolished ecclesiastical courts. This was followed by a law of civil marriage; and in 1854 the ecclesiastical reforms were completed by Rattazzi's bill for restricting religious corporations and placing church property under state control. The necessity of these measures is demonstrated by the fact that the little kingdom of Sardinia counted 41 bishops, 1417 canonries, about 18,000 persons vowed to a monastic life, and one ecclesiastic to every 214 inhabitants. Their importance will be understood when we reflect that these laws were extended to Italy after the union.

Meanwhile Cavour had joined the government in 1850, as minister of commerce. Not least among his great qualities was a thorough understanding of parliamentary tactics; and, though his first attempts at public speaking were unsuccessful, he soon remedied this defect. Mastery of facts and moral force gave weight to his eloquence far above rhetoric. Meanwhile his study of English politics, and admiration for men like Pitt and Peel, developed what in him was an innate instinct for parliamentary leadership. This sound sense of the conditions of representative government induced him to form a coalition with Rattazzi, the leader of the democrats, in 1852. D'Azeglio and the king were frightened by so bold a step. But Cavour's preponderance in the chambers was irresistible; and in November 1853 he superseded D'Azeglio as prime minister. From this date the fortunes of Italy were in his hands, and Cavour became one of the foremost men in Europe. It was by his advice that the Sardinian troops under General La Marmora took part with France and England in the Crimean war, where they distinguished themselves in the battle of the Tchernaya. The nation by this step secured powerful allies, forced itself upon the notice of Europe, and accustomed its army to service on a grand scale. At the congress of Paris in 1856 Cavour represented Sardinia, and laid the grievances of Italy before the allied powers. Both France and England remonstrated, but vainly, with Ferdinand II. for his misgovernment.

Cavour's administration.

Cavour had travelled both in England and France, and had observed that, though the English sympathized with Italy and were horrified by what they heard of Neapolitan atrocities, he was not likely to get more than moral support and non-interference from Great Britain. Yet he could



not work Italian independence without the help of one of the great powers against Austria. He therefore determined to rely on Louis Napoleon Bonaparte, who had expressed his willingness to afford substantial assistance at the proper moment. Between the years 1856 and 1859 it was Cavour's one endeavour to maintain the French emperor in this resolve, and at the same time to drive the Austrians into a reasonable declaration of war.

The situation was delicate and dangerous in the extreme; and in January 1858 the minister's combinations were seriously imperilled by Felice Orsini's attempt on Napoleon's life. It was only by passing a bill which defined the crime of political assassination that he regained the emperor's confidence. Later in the year, Cavour met Napoleon at Plombières, where the preliminaries to a Franco-Italian alliance for war against Austria were settled.

Lombard  
campaign of  
1859

The cabinet of Vienna, harassed by repeated memorials on the subject of their tyranny in Lombardy, complained to Europe that Piedmont was a standing menace to Italian peace, withdrew its minister from Turin, and demanded the disarmament of the Sardinian kingdom. Louis Napoleon now prepared himself for war. On the 1st of January 1859 Vittorio Emanuele opened parliament with a speech which declared the coming struggle: "We are not insensible to the cry of suffering that rises to us from so many parts of Italy." The words *Grido di dolore* were understood to be the watchword of the war. In the early summer of 1859 the French crossed the Alps. The puppets of Parma, Tuscany, and Modena fled, as usual, before the gathering storm,—this time never to return. The battles of Magenta (June 4) and Solferino (June 24) opened Lombardy to the French and Sardinian troops, as far as the Quadrilateral of fortresses protecting Venice. There Louis Napoleon sheathed his sword. He met the emperor Francis Joseph at Villa Franca, and, without consulting his allies, agreed to an armistice. At Plombières he had declared that he meant to free Italy from the Alps to the Adriatic. But now he agreed upon the Mincio as the future boundary between Sardinia and Austria. Venice was not to be liberated. Terrible was the disappointment of the Piedmontese, who had made vast sacrifices for this campaign, and who felt that their king had been insulted. Yet Louis Napoleon was incapable of more. He knew himself to be no general, and he had good reason to be certain that, if he pushed Austria too far, Prussia would take up arms and carry war to France upon the Rhine. Moreover, the gain to Italy proved greater than at first appeared. Tuscany, Modena, Parma, and Romagna declared their determination to join the kingdom. In March 1860 the annexation of Central Italy to Sardinia was effected, and approved by the French emperor. It now appeared that, according to a hitherto secret understanding with Cavour, Louis Napoleon was to take Savoy and Nice as the price of his assistance. This sacrifice of their ancient home, the cradle of their dynasty, the house of Savoy made to the Italian cause. But it was long before the Italians forgave Cavour. He had to bear reproaches from all quarters, especially from Garibaldi, who was never tired of repeating, "That man has made me a foreigner in my own house."

Gari-  
baldi's  
libera-  
tion of  
Lower  
Italy.

The same month which witnessed the annexation of Central Italy saw the outburst of a revolution in the south. Bomba was dead; but his son Francis II., by continued acts of cruelty to state prisoners, and by cowardly oppression of his subjects, had merited the nickname of Bombino. Refugees from Naples spread the tale of Bourbon tyranny all over Europe. Even London trampled with rage at Pœrio's sufferings. The insurrection broke out at Palermo, Messina, and Catania. Garibaldi determined to support it. On the 5th of May he set out from Genoa with his

volunteers, the famous Mille, each of whom became for Italy a hero. Cavour knew of the expedition and secretly favoured it, though he openly expressed the regret of the Sardinian Government to Europe. It was his policy to wait and see what happened, trusting that the gain of the venture would accrue to the new kingdom. Garibaldi landed at Marsala, and proclaimed himself dictator in the name of Vittorio Emanuele, king of Italy. The conquest of Sicily was the matter of a few days. In August the general crossed to Spartivento, defeated the royal army, drove Francis II. to Gaeta, and entered Naples on the 7th of September. There Mazzini joined him, and the difficulties of the situation began to disclose themselves. Garibaldi had no capacity for administration; yet he was unwilling to resign his dictatorship. He had proclaimed Vittorio Emanuele; yet he lent an ear to the republicans, who hated Piedmont. Moreover, he hardly concealed his intention of marching on Rome. Had he taken this step, success would have involved reactionary interference on the part of Europe, while failure might have involved the loss of Lower Italy. Meanwhile the natives of the Two Sicilies were slow to accept annexation. They dispensed with the Bourbons gladly; but they were ready to fulfil the prophecy of Bomba, that "whosoever turned the Bourbons out would have enough to do in Lower Italy for the next century." Anarchy began to reign, and the Bourbon party lifted up its head again at Gaeta. In these circumstances, Cavour, after ascertaining that he had the sanction of Napoleon, resolved on sending troops into the papal states. This seemed the only means of preventing Garibaldi's march on Rome, and securing his acquisitions for United Italy. General Cialdini accordingly occupied Urbino and Perugia, defeated the pope's general, Lamoricière, at Castelfidardo, joined Garibaldi, and helped him to gain a victory over the Bourbon troops on the Volturno. On the 2d of October Cavour defined the situation for the parliament at Turin: "Garibaldi wishes to perpetuate the revolution; we wish to terminate it." Soon after this, Vittorio Emanuele himself entered the Abruzzi. Garibaldi, with the loyalty which never deserted him, resigned his dictatorship, and returned to Caprera. In November Cavour was able to write to Berlin: "We are Italy; we write in her name; but at the same time it is our policy to moderate the national movement and maintain the monarchical principle."

In February 1861 Gaeta fell, after a resistance ennobled by the courage of Francesco's German consort. The kingdom was annexed by plebiscite, and Vittorio Emanuele was proclaimed king of Italy at Turin. Europe tacitly assented to Italian independence. Only Rome and Venice remained to be liberated. The difficulties under which new Italy laboured were enormously increased by the annexation of the Two Sicilies. Ever since the Norman Conquest they had formed a province apart. Temperament, custom, and tradition separated the inhabitants, as far as it was possible, from the sober people of the north. The national parliament had to contend with brigandage encouraged by the clergy, with deeply-rooted antipathies of race, with the discontent of disbanded officials, and with the multitudinous obstacles which a demoralized society offers to strict government. Upper Italy alone was educated for political existence. Elsewhere the bad government of centuries had made the people permanently hostile to the state, while corruption rendered them untrustworthy as agents. Therefore the business of the country had to be conducted by the Piedmontese. Yet this important fact was neglected in the composition of the parliament, where a due preponderance had not been secured for the colleges of Northern Italy. It was impossible not to own that the work of emancipation and annexation had progressed too quickly. To add

Procla-  
mation of  
Italian  
kingdom.

to the difficulty, Italy lost her greatest statesman at this juncture. On the 5th of June 1861, Cavour died with the words "A free church in a free state" upon his lips. The last months of his life had been given to planning the peaceable acquisition of Rome by treaty with the pope and Louis Napoleon.

Comple-  
tion of  
Italian  
independ-  
ence.

What remains of Italian history between 1861 and 1870 may be briefly told. Ricasoli formed a conservative Government after Cavour's death, and Rattazzi led the opposition. Garibaldi, who vowed never to rest till Rome and Venice had been liberated, headed the party of action. In 1862 he raised a volunteer army and invaded Sicily. Louis Napoleon regarded this as a menace to Rome, and ordered Rattazzi, who was now in power, to check his progress. Cialdini marched to Reggio, where the royal troops were defeated by the volunteers on the 23th of September 1862. Next day Garibaldi was attacked and beaten at Aspromonte by General Pallavicini. He retired, wounded, to Caprera, whence he published his defence. The blame was seen to lie with Rattazzi, who had thought to follow Cavour's policy of masterly inaction without first settling with France. The sympathy of Europe with Italy was so great after this disaster that in September 1864 Louis Napoleon agreed to a gradual withdrawal of French troops from Rome, provided Italy respected what remained of the pope's temporal power. By the same convention Florence became the capital. This was a good step in advance towards the annexation of Rome. In 1866 the Austro-Prussian war gave a new opportunity to the Italians. They entered into alliance with Prussia, and marched an army across the Mincio. The defeats of Custozza, Monte Suello, and Lissa deprived the Italian troops of any claim to military or naval glory in this war. But the Prussian victory of Königgratz secured the main objects for which they fought. Venice, with the Quadrilateral, was joined to the Italian kingdom, while Austria kept her Istrian and Dalmatian provinces.

In accordance with the September convention, Louis Napoleon withdrew his garrison from Rome in 1866. This event inflamed the party of action. Mazzini called upon the people to seize the Eternal City; and Garibaldi in 1867 declared his resolve to take Rome or die. Rattazzi, who was again in power, once more attempted the policy which had failed him in 1862. He ignored the obligation which bound Vittorio Emanuele to defend the papal frontiers, and he hoped that France would tolerate a volunteer invasion. He was mistaken. Louis Napoleon interfered, and the Italian cabinet was forced to discountenance the further proceedings of the volunteers. Disturbances occurred in

Rome, and Garibaldi gained a victory at Monte Rotondo. Meanwhile the king appealed to the Italians to preserve his honour, and the emperor sent a new garrison to Rome. Garibaldi's volunteers surrendered at Mentana, on the 4th of November, to the French and papal troops; and, while the general was retiring to Caprera, he was arrested by order of the Italian Government at Figline. But the end was now not distant.

When the victory of Sedan overthrew the French empire in September 1870, Jules Favre declared the September convention to be at an end; Vittorio Emanuele was released from his obligations, and on the 20th he entered Rome, which now became his capital. Pius IX. was allowed to retain the Vatican with its dependencies, the church of Sta Maria Maggiore, and Castel Gandolfo on the Alban hill. The state voted him a munificent income, and he was left in peace to play the part of a persecuted prisoner. Thus ended the emancipation of Italy; nor did the events of the following ten years alter the situation created by the king's occupation of Rome in 1870. Vittorio Emanuele died and was succeeded by his son Umberto in 1878. Pius IX. died the same year, and was succeeded by Leo XIII. The history of Italy during this period has been confined to internal affairs.

Vittorio  
Emanuele  
enters  
Rome.

*Bibliography.*—It is difficult to indicate in a short space the most important sources of Italian as distinguished from imperial or ecclesiastical history. Muratori's great collection of *Rerum Italicarum Scriptores*, in combination with his *Dissertationes*, the chronicles and other historical material published in the *Archivio Storico Italiano*, and the works of those detached annalists of whom the *Villani* are the most notable take the first rank. Next may be mentioned Muratori's *Annali d'Italia*, together with Guicciardini's *Storia d'Italia*, and its continuation by Carlootta. Troya's *Storia d'Italia del Medio Evo* and Sismondi's *Républiques Italiennes* form perhaps the most valuable modern contributions to the history of the whole peninsula. Ferrari's *Rivoluzioni d'Italia* deserves special notice, as a work of singular vigour, though of less scientific value; and Cesare Balbo's *Sommario* presents the main outlines of the subject with brevity and clearness. With regard to the history of separate provinces, it may suffice to notice the *Storia Fiorentina* of Machiavelli and Corio's *Storia di Milano*, Capponi's *Storia della Repubblica di Firenze*, Colletta's *History of Naples*, Romania's *History of Venice*, Amari's *Musulmani di Sicilia*, and the *Stadt Rom* of Gregorovius. From the point of view of papal history, Von Ranke's *History of the Popes* is distinguished for exact insight into one epoch of Italian development. From the point of view of biography, Von Reumont's *Lorenzo de' Medici* and Villari's *Savonarola* and *Machiavelli* are equally instructive. From the point of view of general culture Burckhardt's *Cultur der Renaissance in Italien*, Quinet's *Révolutions d'Italie*, and J. A. Symonds's *Renaissance in Italy*, 5 vols., may prove of service. No comprehensive work can be indicated for the history of Italy during the present century, though Reuchlin's *Geschichte Italiens*, Treitschke's *Essay on Cavour*, and Massari's *Life of Cavour* supply important materials. (J. A. S.)

### PART III.—LANGUAGE.

The Italian language is the language of culture in the whole of the present kingdom of Italy, in some parts of Switzerland (the canton of Ticino and part of the Grisons), in some parts of the Austrian territory (the districts of Trent and Görz, Istria along with Trieste, and the Dalmatian coast), and in the islands of Corsica and Malta. In the Ionian Islands, likewise, in the maritime cities of the Levant, in Egypt, and more particularly in Tunis, this literary language is extensively maintained through the numerous Italian colonies and the ancient traditions of trade.

The Italian language has its native seat and living source in Middle Italy, or more precisely Tuscany and indeed Florence. For real linguistic unity is far from existing in Italy: in some respects the variety is less in others more observable than in other countries which equally boast a political and literary unity. Thus, for

example, Italy affords no linguistic contrast so violent as that presented by Great Britain with its English dialects alongside of the Celtic dialects of Ireland, Scotland, and Wales, or by France with the French dialects alongside of the Celtic dialects of Brittany, not to speak of the Basque of the Pyrenees and other heterogeneous elements. The presence of not a few Slavs stretching into the district of Udine (Friuli), of Albanian, Greek, and Slav settlers in the southern provinces, with the Catalans of Alghero (Sardinia), a few Germans at Monte Rosa, and a remnant or two of other comparatively modern immigrations is not sufficient to produce any such strong contrast in the conditions of the national speech. But, on the other hand, the Neo-Latin dialects which live on side by side in Italy differ from each other much more markedly than, for example, the English dialects or the Spanish; and it must be added that, in Upper Italy especially, the familiar use



of the dialects is tenaciously retained even by the most cultivated classes of the population.

In the present rapid sketch of the forms of speech which occur in modern Italy, before considering the Tuscan or Italian *par excellence*, the language which has come to be the noble organ of modern national culture, it will be convenient to discuss (A) dialects connected in a greater or less degree with Neo-Latin systems that are not peculiar to Italy; (B) dialects which are detached from the true and proper Italian system, but form no integral part of any foreign Neo-Latin system; and (C) dialects which diverge more or less from the true Italian and Tuscan type, but which at the same time can be conjoined with the Tuscan as forming part of a special system of Neo-Latin dialects.

A. *Dialects which depend in a greater or less degree on Neo-Latin systems not peculiar to Italy.*

1. *Franco-Provençal Dialects* (see *Archivio Glottologico*, iii. 61-120).<sup>1</sup>—These occupy at the present time very limited areas at the extreme north-west of the kingdom of Italy. The system stretches from the borders of Savoy and Valais into the upper basin of the Dora Baltea and into the head-valleys of the Orco, of the northern Stura, and of the Dora Riparia. As this portion is cut off by the Alps from the rest of the system, the type is badly preserved; in the valleys of the Stura and the Dora Riparia, indeed, it is passing away and everywhere yielding to the Piedmontese.—The most salient characteristic of the Franco-Provençal is the phonetic phenomenon by which the Latin *a*, whether as an accented or as an unaccented final, is reduced to a thin vowel (*e*, *i*) when it follows a sound which is or has been palatal, but on the contrary is kept intact when it follows a sound of another sort. The following are examples from the Italian versant of these Alps:—AOSTA: *travajji*, Fr. travailler; *zaré*, Fr. chercher; *enterajji*, Fr. interroger; *zeva*, Fr. chèvre; *zir*, Fr. cher; *gluicé*, Fr. glace; *vace*, Fr. vache; alongside of *sa*, Fr. sel; *macé*, Fr. main; *épousea*, Fr. épouse; *erba*, Fr. herbe. VAL SOANA: *taljér*, Fr. tailleur; *coci-see*, Fr. se coucher; *ciù*, Fr. clien; *ciura*, Fr. chèvre; *vaci*, Fr. vache; *manji*, Fr. manche; alongside of *alér*, Fr. aller; *portá*, Fr. porté; *amira*, Fr. amère; *neva*, Fr. neuve. CHIAMORIO (Val di Lanzo): *la sprausá d'la vendeta*, speranza de illa vindeta. VIU: *pansci*, panca. USSEGLIO: *la murajji*, muraille.—A morphological characteristic is the preservation of that paradigm which is legitimately traced back to the Latin pluperfect indicative, although possibly it may arise from a fusion of this pluperfect with the imperfect subjunctive (*amaran*, *amarem*, alongside of *habueram*, *haberem*), having in Franco-Provençal as well as in Provençal and in the continental Italian dialects in which it will be met with further on C. 3, *h*; cf. B. 2) the function of the conditional. VAL SOANA: *portava*, *portáve*, *portávet*; *portávent*; AOSTA: *avre*=Prov. *agra*, haberet (see *Arch.*, iii. 31 *n*). The final *l* in the third persons of this paradigm in the Val Soana dialect is, or was, constant in the whole conjugation, and becomes in its turn a particular characteristic in this section of the Franco-Provençal. VAL SOANA: *éret*, Lat. *erat*; *sej*, *si*; *habét*, *portávet*; *portont*, *portávent*; CHIAMORIO: *jéret*, *erat*; *ant d'it*, *habent* dictum; *éssount féit*, *habuissent factum*, VIU: *che s'mángel*, Ital. *che si mangi*; GRAVERE (Val di Susa): *at pensá*, *ha pensato*; *avét*, *habebat*; GIAGLIONE (sources of the Dora Riparia): *maciávent*, *mangiavano*.—From the valleys, where, as has just been said, the type is disappearing, a few examples of what is still genuine Franco-Provençal may be subjoined.—*Civvère* (the name of a mountain between the Stura and the Dora Riparia), which, according to the regular course of evolution, presupposes a Latin *Capraria* (cf. *maneri*, *maniera*, even in the Chiamorio dialect); *caravati* (*civvasti*), *crestina*, in the Viu dialect; and *émbit*, *cantare*, in that of Usseglio. From CHIAMORIO, *li téns*, *i témp*, and *clerjches birbes*, *alcune* (*qualche*) *birbe*, are worthy of mention on account of the final *s*.

Further south, but still in the same western extremity of Piedmont, phenomena continuous with those of the Maritime Alps supply the means of passing from the Franco-Provençal to the Provençal proper, precisely as the same transition takes place beyond the Cottian Alps in Dauphiné almost in the same latitude. On the Italian side of the Cottian and the Maritime Alps the Franco-Provençal and the Provençal are connected with each other by the continuity of the phenomenon *é* (a pure explosive) from the Latin *e* before *a*. At ORTIX (sources of the Dora Riparia), which seems, however, to have a rather mixed dialect, there also occurs the important Franco-Provençal phenomenon of the sord interdental (English *th* in *chief*) instead of the sord sibilant (for example *thi*=Fr. *ici*). At the same time *avú*=*avuto*, takes us to the Provençal. At FENESTRELLA (upper basin of the Susone): *agi*, *venú*; at OXCINO (sources of the Po): *arestio*, *l'ero* an *compagno*, with the Provençal

o for the final unaccented *a*; at SAMPEYRE (basin of the Varaita): *agi*, *venú*, *volgü*, *voluto*; *unu viestio in plus pressiaso*; and finally at VINADIO (basin of the southern Stura): *tuécio*, *tocca*; *los buónos*, *le buone*, where even the diphthong is Provençal.

2. *Ladin Dialects*.—The purest of the Ladin dialects occur on the northern versant of the Alps in the Grisons (Switzerland), and they form the western section of the system. To this section also belongs both politically and in the matter of dialect the valley of Munster (Monastero); it sends its waters to the Adige, and might indeed consequently be geographically considered Italian, but it slopes towards the north. In the central section of the Ladin zone there are two other valleys which likewise drain into tributaries of the Adige, but are also turned towards the north,—the valleys of the Gardena and the Gadera, in which occurs the purest Ladin now extant in the central section. The valleys of Munster, the Gardena, and the Gadera may thus be regarded as inter-Alpine, and the question may be left open whether or not they should be included even geographically in Italy. There remain, however, within what are strictly Italian limits, the valleys of the Noce, the Avisio, the Cordevole, and the Boite, and the upper basin of the Piave (Comelico), in which are preserved Ladin dialects, more or less pure, belonging to the central section of the Ladin zone or belt. To Italy belongs, further, the whole eastern section of the zone composed of the Friulian territories. It is by far the most populous, containing about 500,000 inhabitants. The Friulian region is bounded on the north by the Carvic Alps, south by the Adriatic, and west by the eastern rim of the upper basin of the Piave and the Livenza; while on the east it stretches into the eastern versant of the basin of the Isonzo.—The Ladin element is further found in greater or less degree throughout an altogether Cis-Alpine "amphizone," and more particularly in the head valley of the Ticino and the head valley of the Mera on the Lombardy versant, and in the Val Fiorentina and central Cadore on the Venetian versant. The valleys of Bormio present a special and conspicuous phase of Ladin-Lombard connexions, and the Ladin element is clearly observable in the most ancient examples of the dialects of the Venetian estuary (*Arch.*, i. 448-473).—The main characteristics by which the Ladin type is determined may be summarized as follows:—(1) the guttural of the formulæ *e+a* and *g+a* passes into a palatal; (2) the *l* of the formulæ *pl*, *cl*, &c., is preserved; (3) the *s* of the ancient terminations is preserved; (4) the accented *e* in position breaks into a diphthong; (5) the accented *o* in position breaks into a diphthong; (6) the form of the diphthong which comes from short accented *o* or from the *o* of position is *ue* (whence *üe*, *ö*); (7) long accented *e* and short accented *i* break into a diphthong, the purest form of which is sounded *ei*; (8) the accented *a* tends, within certain limits, to change into *e*, especially if preceded by a palatal sound; (9) the long accented *a* is represented by *ä*. These characteristics are all foreign to true and genuine Italian. *Carne*, *carne*; *spetunäca*, *spelunca*; *cléfs*, *claves*; *fuormas*, *forme*; *infern*, *inferno*; *ördi*, *hordeo*; *mäd*, *modo*; *pläin*, *pleno*; *paül*, *pilo*; *quäl*, *quale*; *pür*, *puro*—may be taken as examples from the Upper Engadine (western section of the zone). The following are examples from the central and eastern sections on the Italian versant:—

a. *Central Section*.—BASIN OF THE NOCE: examples of the dialect of Fondo: *carél*, *capillo*; *pesádör*, *pisicatore*; *plüevia*, *pluvia* (*plovina*); *pluma* (*dial.* of Val de Rumo: *ploria*, *plümo*); *véla*, *vetula*; *éantes*, *cantas*. The dialects of this basin are disappearing.—BASIN OF THE AVISIO: examples of the dialect of the Val di Fassa: *carne*, *carne*; *céler*, *cadere* (*cad-jere*); *vácä*, *vacea*; *fórcä*, *furca*; *glézia* (*gèzia*), *ecclesia*; *dylje* (*ojc*), *oculi*; *canis*, *canes*; *räms*, *rami*; *teila*, *tela*; *néif*, *nive*; *cassa*, *coxa*. The dialects of this basin which are further west than Fassa are gradually being merged in the Veneto-Tridentine dialects.—BASIN OF THE CORDEVOLE: here the district of Livinal-Lungo (Buchenstein) is Austrian politically, and that of Rocca d'Agordo and Laste is Italian. Examples of the dialect of Livinal-Lungo: *carie*, *Ital.* *caricare*; *canté*, *cantatus*; *göle*, *oculo*; *canis*, *canes*; *caréis*, *capilli*; *viém*, *verme*; *fäbe*, *foco*; *avét*, *habere*; *néi*, *nive*.—BASIN OF THE BOITE: here the district of Ampezzo (Heiden) is politically Austrian, that of Oltreichina Italian. Examples of the dialect of Ampezzo are *éasa*, *casa*; *cändéra*, *candela*; *fórcés*, *furca*, *pl*; *séntes*, *sentis*. It is a decadent form.—UPPER BASIN OF THE PIAVE: dialect of the Comelico: *éasa*, *casa*; *can* (*can*), *canes*; *caljé*, *caligario*; *bos*, *boves*; *novo*, *novo*; *lago*, *loco*.

b. *Eastern Section or Friulian Region*.—Here there still exists a flourishing "Ladinity," but at the same time it tends towards Italian, particularly in the want both of the *e* from *ä* and of the *ü* (and consequently of the *ö*). Examples of the Udine variety: *carr*, *carro*; *carül*, *caballo*; *castiél*, *castello*; *fórcé*, *furca*; *clar*, *claro*; *glac*, *glacie*; *plan*, *plano*; *colörs*, *colores*; *lungis*, *longi*, *pl*; *déris*, *debés*; *vidiél*, *vitello*; *fiéste*, *festa*; *puéss*, *possum*; *cuéit*, *cocto*; *üárdi*, *hordeo*.—The most ancient specimens of the Friulian dialect belong to the 14th century (see *Arch.*, iv. 188 *sqq.*).

B. *Dialects which are detached from the true and proper Italian system, but form no integral part of any foreign Neo-Latin system*

<sup>1</sup> References to this journal (*Arch.*) without author's name are to papers by Professor Ascoli.

1. Here first of all is the extensive system of the dialects usually called *Gallo-Italian*, although that designation cannot be considered sufficiently distinctive, since it would be equally applicable to the Franco-Provençal (A. 1) and the Ladin (A. 2). The system is subdivided into four great groups,—(a) the *Ligurian*, (b) the *Piedmontese*, (c) the *Lombard*, and (d) the *Emilian*,—the names furnishing on the whole sufficient indication of the localization and limits.—These groups, considered more particularly in their more pronounced varieties, differ greatly from each other; and, in regard to the Ligurian, it was even denied until very recently that it belongs to this system at all (see *Arch.*, ii. 111 *sqq.*).—Characteristic of the Piedmontese, the Lombard, and the Emilian is the continual elision of the unaccented final vowels except *a* (e.g., Turinese *ij*, oculo; Milanese *egg*, voce; Faenzan *red*, rete), but the Ligurian does not keep them company (e.g., Genovese *uffu*, oculo; *voçe*, voce). In the Piedmontese and Emilian there is further a tendency to eliminate the protonic vowels—a tendency much more pronounced in the second of these groups than in the first (e.g., Pied. *danè*, danaro; *vèin*, vicino; Faenzan *fiocè*, fuoco; *dsprazion*). This phenomenon involves in large measure that of the prothesis of *a*; as, e.g., in Turinese and Faenzan *armor*, rumore; Faenzan *alvé*, levare; &c. *U* for the long accented Latin *u* and *o* for the short accented Latin *o* (and even within certain limits the Latin *o* of position) are common to the Piedmontese, the Ligurian, and the Lombard: e.g., Turinese and Milanese *dür*, and Genovese *dür*, duro; Turinese and Genovese, *möve*, and Milanese *möve*, movere; Piedmontese *dörm*, dormo; Milanese *völla*, volta. *Ei* for the long accented Latin *e* and for the short accented Latin *i* is common to the Piedmontese and the Ligurian, and even extends over a large part of Emilia: e.g., Turinese and Genovese, *arèi*, habere, Bolognese, *arèin*; Turinese and Genovese, *beive*, bibere, Bolognese, *beir*. In Emilia *ei* occurs also in the formulae *du*, *cul*, *emp*; e.g., Bolognese and Modenese *bein*, *splamèint*. The system shows a repugnance throughout to *ie* for the short accented Latin *e* (as it occurs in Italian *pièd*, &c.); in other words, this diphthong has died out, but in various fashions. Piedmontese and Lombard *deç*, dieci; Genovese *dèç*; Faenzan *dèp*. The greater part of the phenomena indicated above have "Gallic" counterparts too evident to require to be specially pointed out. One of the most important traces of Gallic or Celtic reaction is the reduction of the Latin accented *a* into *e* (*a*, &c.), of which phenomenon, however, no certain indications have as yet been found in the Ligurian group. On the other hand it remains, in the case of very many of the Piedmontese dialects, in the *e* of the infinitives of the first conjugation; *porté*, portare, &c.; and numerous vestiges of it are still found in Lombardy (e.g., in Bassa Brianza: *andé*, andato; *guardé*, guardato; *sé*, sale; see *Arch.* i. 296–298, 536). Emilia also preserves it in a very extensive use: Modenese *andér*, andare; *arivèda*, arrivata; *pacé*, pace; Faenzan *parlé*, parlare and *parlato*; *parléda*, parlata; *ches*, caso; &c. The phenomenon, in company with other Gallo-Italian and more specially Emilian characteristics, extends to the valley of the Metauro, and even passes to the opposite side of the Apennines, spreading on both banks of the head stream of the Tiber and through the valley of the Chiane: hence the types *arvèrin*, ritrovare, *portato*, portato, &c., of the Perugian and Arretine dialects (see *infra* C. 3, b). In the phenomenon of *a* passing into *e* (as indeed, the Gallo-Italic evolution of other Latin vowels) special distinctions would require to be drawn between bases in which *a* (not standing in position) precedes a non-nasal consonant (e.g., *amido*), and those which have *a* before a nasal: and in the latter case there would be a non-positional subdivision (e.g., *fiamé*, *pane*) and a positional one (e.g., *quáto*, *amído*, *cámpo*); see *Arch.* i. 293 *sqq.* This leads us to the nasals, a category of sounds comprising other Gallo-Italic characteristics. There occurs more or less widely, throughout all the sections of the system, and in different gradations, that "velar" nasal in the end of a syllable (*pañ*, *mañ*; *cáita*, *moit*) which may be weakened into a simple nasalizing of a vowel (*pā*, &c.) or even grow completely inaudible (Bergamese *pa*, *pane*; *padrū*, padrone; *lep*, tempo; *mel*, mente; *mut*, monte; *pal*, panto; *pića*, punta, i.e., "puncta"), where Celtic and especially Irish analogies and even the frequent use of *t* for *n*, &c., in ancient Umbrian orthography occur to the mind. Then we have the faucal *n* by which the Ligurian and the Piedmontese (*lañra*, *liñra*, &c.) are connected with the group which we call Franco-Provençal (A. 1).—We pass on to the "Gallic" resolution of the nexus *cl* (e.g., *facto*, *fajto*, *fajta*, *fajl*, *fai*; *lecto*, *teito*, *tejtta*, *teit*, *teç*) which invariably occurs in the Piedmontese, the Ligurian, and the Lombard; Pied. *fajl*, Lig. *fajtu*, *fajtu*, Lombard *fai*; Pied. *teit*, Lig. *teitu*, Lom. *teç*; &c. Here it is to be observed that besides the Celtic analogy the Umbrian also helps us (*advèitu* = ad-recto; &c.), and it is further most noteworthy that the Celtic and Umbrian analogies lead us to that fusion of the *cl* series with the *pl* series (Irish *socht*, Welsh *soith*, septem; Umbrian, *serchto*, *serchitro*, scriptum, scripti) by which is explained the *scriç*, *scripto*, of the ancient Milanese, *scriçàra*, scriptura, of the modern; just as also Provençal *bascriçich* (i.e., *escriç*).—The Piedmontese and Ligurian come close to each other, more especially by the regular dropping of the *d* both

primary and secondary, a phenomenon common in French (as Piedmontese and Ligurian *ric*, ridere; Piedmontese *puç*, potare; Genovese *næghè* = *næighe*, *næiche*, &c.). The Lombard type, or more correctly the type which has become the dominant one in Lombardy (*Arch.*, i. 305–6, 310–11), is more sparing in this respect; and still more so is the Emilian. In the Piedmontese is also found that other purely Gallic resolution of the guttural between two vowels by which we have the types *brija*, *mánia*, over against the Ligurian *bráya*, *manega*, *braca*, *manica*.—Among the phonetic phenomena peculiar to the Ligurian is a continual reduction of *l* into *r* and the subsequent dropping of this *r* between vowels and at the end of words in the modern Genovese; just as happens also with the primary *r*: thus *dū* = *durū* = *dolore*, &c. Characteristic of the Ligurian, but not without analogies in Upper Italy even (*Arch.*, ii. 157–8), is the resolution of *bj*, *lj* into *ç*, *ç*; *çū*, *piū*, plus; *rájffa*, *rabbia*, *rabies*; *çá*, *forte*. Finally, the sounds *š* and *z* have a very wide range in Ligurian (*Arch.*, ii. 158–59). The reduction of *s* into *h* occurs in the Bergamo dialects: *hira*, sera; *groh*, grosso; *cahtel*, castello (see also B. 2).—A general phenomenon in Gallo-Italic phonetics which also comes to have an inflexional importance is that by which the unaccented final *i* has an influence on the accented vowel. This enters into a series of phenomena which even extends into southern Italy; but in the Gallo-Italic there are particular resolutions which agree well with the general connexions of this system. The following plural forms may be quoted: Genovese *báin*, from *bón-i*; *tráin* from *tron-i*, tuoni; Milanese *quist*, from *quist-i* (sing. *quist*), *questi*; *mis* from *mcs-i*, mesi (sing. *mcs*), Bolognese *riñ*, from *reñ-i*, regni (sing. *reñ*); *çf*. *Arch.*, i. 540–41.—Among morphological peculiarities the first place may be given to the Bolognese *sipa* (*scippa*), because, thanks to Dante and others, it has acquired great literary celebrity. It really signifies "sia" (sim, sit), and is an analogical form fashioned on *apa*, a legitimate continuation of the corresponding forms of the other auxiliary (habeam, habeat), which is still heard in *ch'ne aya parté*, *ch'lu aya parté*, *ch'io abbia partato*, *ch'egli abbia partato*. Next may be noted the third person singular in *-p* of the perfect of *esse* and of the first conjugation in the Forlì dialect (*sep*, in; *mandep*, mandò; &c.). This also must be analogical, and due to a legitimate *ep*, *ebbe* (see *Arch.*, ii. 401, and compare *jóbbe*, *fu*, in the dialect of Camerino, in the province of Macerata, as well as the Spanish analogy of *tuve estuve* formed after *hubo*). Lastly, in the domain of syntax, may be added the tendency to repeat the pronoun (e.g., *ti te cantel* of the Milanese, which really is *tu te cantas-tu*; equivalent merely to "cantas"), a tendency at work in the Emilian and Lombard, but more particularly pronounced in the Piedmontese. With this the corresponding tendency of the Celtic languages has been more than once and with justice compared; here it may be added that the Milanese *vün*, apparently a simple form for "noi," is really a compound or reduplication in the manner of the *ni-ni*, its exact counterpart in the Celtic tongues.—The literary documents of this system go back as far as the end of the 13th century in the Milanese poems of Fra Bonvicino da Liva and the *Rime Genovesi* (*Arch.*, ii. 161–312).

2. *Sardinian Dialects*.—These are three—the Logudorese or central, the Campidanese or southern, and the Gallurese or northern. The third certainly indicates a Sardinian basis, but is strangely disturbed by the intrusion of other elements, among which the Southern Corsican (Sartene) is by far the most copious. The other two are homogeneous, and have great affinity with each other; the Logudorese comes more particularly under consideration here.—The pure Sardinian vocalism has this peculiarity that each accented vowel of the Latin appears to be retained without alteration. Consequently there are no diphthongs representing simple Latin vowels; nor does the rule hold good which is true for so great a proportion of the Romance languages that the representatives of the *è* and the *i* on the one hand and those of the *é* and the *è* on the other are normally coincident. Hence *pleuru* (*è*); *deghè*, *deem* (*è*); *biçes*, vino (*i*); *più* (*i*); *fiore* (*ò*); *rotta*, *rota* (*ò*); *duru* (*ù*); *nughe*, *nuce* (*ù*). The unaccented vowels keep their ground well, as has already been seen in the case of the finals by the examples adduced.—The *s* and *l* of the ancient termination *ae* preserved, though not constantly: *tres*, *onis*, *passados annos*, *plantas*, *fayhes*, *facis*, *tenemus*; *mulghè*, *mulghenl*.—The formulae *ce*, *ci*, *ge*, *gi* may be represented by *che* (*ke*), &c.; but this appearance of special antiquity is really illusory (see *Arch.*, ii. 143–4). The nexus *cl*, &c., may be maintained in the beginning of words (*claru*, plus); but if they are in the body of the word they usually undergo resolutions which, closely related though they be to those of Italian, sometimes bring about very singular results (e.g. *usare*, which by the intermediate forms *usare*, *usjare* leads back to *usclare* = *ustulare* = *ustularc*). *Aç* is the representative of *vj* (*testimòntu* &c.); and *lj* is reduced to *ç* alone (e.g., *mèçus*, melius; Campidanese *mellus*). For *ll* a frequent substitute is *dè*: *massidda*, maxilla, &c. Quite characteristic is the continual labialization of the formulae *gua*, *qua*, *cu*, *qu*, &c.; e.g., *ebba*, equa; *sambene*, sanguine (see *Arch.*, ii. 143). The dropping of the primary *d* (*roere*, roiere, &c.) but not of the secondary (*finidu*, *samidade*, *mularu*) is frequent. Characteristic also is the Logudorese prothesis of *r* before



the initial *s* followed by a consonant (*iscannu, istella, spada*), like the prothesis of *c* in Spain and in France (see *Arch.*, iii. 447 sqq.).—In the order of the present discussion it is in connexion with this territory that we are for the first time led to consider those phonetic changes in words of which the cause is merely syntactical or transitory, and chiefly those passing accidents which occur to the initial consonant through the historically legitimate or the merely analogical action of the final sound that precedes it. The general explanation of such phenomena reduces itself to this that, given the intimate syntactical relation of two words, the initial consonant of the second retains or modifies its character as it would retain or modify it if the two words were one. The Celtic languages are especially distinguished by this peculiarity; and among the dialects of Upper Italy the Bergamasco offers a clear example. This dialect is accustomed to drop the *r*, whether primary or secondary, between vowels in the individual vocables (*caù, cavare; faia, fava, &c.*), but to preserve it if it is preceded by a consonant (*scrava, &c.*).—And similarly in syntactic combination we have, for example, *de i, di vino*; but *ol vi, il vino*. Insular, southern, and central Italy furnishes large number of such phenomena; for Sardinia we shall simply cite a single class, which is at once obvious and easily explained, viz., that represented by *su oc, il bove, alongside of sos boes, i buoi* (cf. *biero, bibere; crba*).—The article is derived from *ipse* instead of from *ille*: *su sos, sa sas*,—again a geographical anticipation of Spain, which in the Catalan of the Balearic islands still preserves the article from *ipse*.—A special connexion with Spain exists besides in the *stomine* type of inflexion, which is constant among the Sardinians (Spanish *nomme, &c.*, whence *nombre, &c.*), *nomma, nome, namine*, aeramine, *tegmene, &c.* (see *Arch.*, ii. 429 sqq.).—Especially noteworthy in the conjugation of the verb is the paradigm *cantere, cantères, &c.*, *timere, timères, &c.*, precisely in the sense of the imperfect subjunctive (cf. A. 1; cf. C. 3 b). Next comes the analogical and almost corrupt diffusion of the *-si* of the ancient strong perfects (such as *posi, rosi*), by which *cantesi, timesti* (*cantavi, timui*), *dalfesi, dolui*, are reached. Proof of the use and even the abuse of the strong perfects is afforded, however, by the participles and the infinitives of the category to which belong the following examples: *tennudu, tenuto; pàrdidu, parso; balfidu, valso; lènnere, balere, &c.* (*Arch.*, ii. 432-33). The future, finally, shows the unagglutinated periphrasis: *happo a mandigare* (ho a mangiare=manger-ò); as indeed the unagglutinated forms of the future and the conditional occur in ancient vernacular texts of other Italian districts.—There are documents of the Sardinian dialect going back as far as the middle of the 12th century.

C. *Dialects which diverge more or less from the genuine Italian or Tuscan type, but which at the same time can be conjoined with the Tuscan as forming part of a special system of Neo-Latin dialects.*

1. *Venetian*.—Between "Venetian" and "Venetic" several distinctions must be drawn (*Arch.*, i. 391 sqq.). At the present day the population of the Venetian cities is "Venetian" in language, but the country districts are in various ways Venetic.<sup>1</sup> The ancient language of Venice itself and of its estuary was not a little different from that of the present time; and the Latin vein was particularly evident (see A. 2). A more purely Italian vein—the historical explanation of which presents an attractive problem—has ultimately gained the mastery and determined the "Venetian" type which has since diffused itself so vigorously.—In the Venetian, then, we do not find the most distinctive characteristics of the dialects of Upper Italy comprised under the denomination Gallo-Italic (see B. 1),—neither the *ū* nor the *ā*, nor the velar and faucal nasals, nor the Gallic resolution of the *cl*, nor the frequent elision of unaccented vowels, nor the great redundancy of pronouns. On the contrary, the pure Italian diphthong of *ō* (e.g., *cvōr*) is heard, and the diphthong of *ē* is in full currency (*diēc, dicei, &c.*). Nevertheless the Venetian approaches the type of Northern Italy, or diverges notably from that of Central Italy, by the following phonetic phenomena:—the ready elision of primary or secondary *d* (*crudo, crudo; sea, seta, &c.*); the regular reduction of the sord into the sonant guttural (e.g., *cuogo, Ital. cuoco, coquus*); the pure *ē* in the resolution of *cl* (e.g., *clave, clava; orēia, auricula*); the *z* for *g* (*zōvone, Ital. giovance*); *ç* for *ß* and *ē* (*pēce, Ital. pesce; ciēl, Ital. cielo*). *Lj* preceded by any vowel, primary or secondary, except *i, gives ç; jamēga, familia*. No Italian dialect is more averse than the Venetian to the doubling of consonants.—In the morphology the use of the 3d singular for the 3d plural also, and the analogical participle in *esto* (*l'atesto, Ital. taciuto, &c.*; see *Arch.*, iv. 393 sqq.) are particularly noteworthy. A curious double relic of Latin influence is the interrogative type represented by the example *crēdis-tu, credis tu*,—where apart from the interrogation (*ti credi*) would be used.—The texts of the Venetian vernacular take us back to the first half of the 13th century. To the beginning of the 14th belongs the *Trattato "de regimīne rec-*

*toris"* of Fra Paolino, and also in the Venetian dialect. For other ancient sources relating to Venice, the estuary of Venice, Verona, and Padua, see *Arch.*, i. 448, 465, 421-22; iii. 245-47.

2. *Corsican*.—If the "Venetian," in spite of its peculiar "anomaly," has naturally special points of contact with the other dialects of Upper Italy (B. 1), the Corsican in like manner, particularly in its southern varieties; has special points of contact with Sardinian proper (B. 2). Thus for example, in *voglio leche lu bunnetru* (*voglio lasciar la gonella*) from a song of Fiumorban Corsican there is a phonetic phenomenon (*bu* from *gu*) which reveals a connexion with Sardinian proper, as well as a morphological phenomenon which implies the same relation, since *leche* must be a verb of the first conjugation (*lugare* in Upper Italy; see, for example, *Arch.*, i. 546) conformed to the analogy of strong verbs as found in Sardinian in the case of *narrere, narrare*, or, for a verb of the fourth conjugation, in Corsican *vene, Sardinian benere*=venire.—In general, it is in the southern section of the island, which, geographically even, is farthest removed from Tuscany, that the most characteristic forms of speech are found. The unaccented vowels are undisturbed; but *u* for the Tuscan *o* is common to almost all the island,—an insular phenomenon *par excellence* which connects Corsica with Sardinia and with Sicily, and indeed with Liguria also. So also *i* for the Tuscan *e* (*latti, latte; li cateni, le catene*), which prevails chiefly in the southern section, is also found in Southern Sardinian, and is common to Sicily. It is needless to add that this tendency to *u* and *i* manifests itself, more or less decidedly, also within the words. Corsican, too, avoids the diphthongs of *ē* and *ō* (*pe, ori; cori, fora*); but, unlike Sardinian, it treats *l* and *ll* in the Italian fashion: *beju, bibo; pèvera, piper; pesci; noci, nuccs*.—It is one of its characteristics to reduce *a* to *e* in the formula *ar* + a consonant (*chèrne, bēba, &c.*), which should be compared particularly with the Emilian examples of the same phenomenon (*Arch.*, ii. 133, 144-50). But the *g* found in *-endu* of the first conjugation (*turnendu, lagrimendu, &c.*) must on the contrary be considered as a phenomenon of analogy, as it is especially recognized in the Sardinian dialects, to all of which it is common (see *Arch.*, ii. 133). And the same is most probably the case with forms of the present participle like *mercante, mercante*, in spite of *enzi* and *innenzi* (*anzi, innanzi*), in which latter forms there may probably be traced the effect of the Neo-Latin *i* which availed to reduce the *l* of the Latin *ante*; alongside of them we find also *anzi* and *nantu*.—In Southern Corsican *dr* for *ll* is conspicuous—a phenomenon which also connects Corsica with Sardinia, Sicily, and a good part of Southern Italy (see C. 2; and *Arch.*, ii. 135, &c.). An acute observer (Falcucci) has asserted that even the phenomena of *rn* and *nd* both changing into *mn* are found in certain veins of Southern Corsican; but he has given no examples. The former of these would connect Corsican with Sardinian (*cornu, cernu; carne, &c.*); the latter more especially with Sicily, &c., though it is not unknown even in Sardinia (*Arch.*, ii. 142, 143).—As to phonetic phenomena connected with syntax, already noticed in B. 2, space admits the following examples only: *Cois, na vella, una bella, e bella* (*ebbella, et bella*); *lu jattu, lo gallo, gran ghiattu*; cf. *Arch.*, ii. 136 (135, 150). As Tommaseo has already noted, *-one* is for the Corsicans not less than for the French a termination of diminution: e.g., *fratellronu, fratellino*.—In the first person of the conditional the *b* is maintained (e.g., *farebe, farei*), as even at Rome and elsewhere. Lastly, the series of Corsican verbs of the derivative order which run alongside of the Italian series of the original order, and may be represented by the example *dissipoghja, dissipa* (Falcucci), is to be compared with the Sicilian series represented by *cuadiari, riscaldare, curpiari, colpire* (*Arch.*, ii. 151).

3. *Dialects of Sicily and of the Neapolitan Provinces*.—Here the territories on both sides of the Strait of Messina will first be treated together, chiefly with the view of noting their common linguistic peculiarities.—Characteristic then of these parts, as compared with Upper Italy and even with Sardinia, is, generally speaking, the tenacity of the explosive elements of the Latin bases, (cf. *Arch.*, ii. 154, &c.). Not that these consonants are constantly preserved uninjured; their degradations, and especially the Neapolitan degradation of the sord into the sonant, are even more frequent than is shown by the dialect as written, but their disappearance is comparatively rather rare; and even the degradations, whether regard be had to the conjunctures in which they occur or to their specific quality, are very different from those of the dialects of Upper Italy. Thus, the *l* between vowels ordinarily remains intact in Sicilian and Neapolitan (e.g., Sicil. *sita, Neap. sola, seta*, where in the dialects of Upper Italy we should have *sola, sea*); and in the Neapolitan dialects it is reduced to *d* when it is preceded by *n* or *r* (e.g., *viend, vento*), which is precisely a collocation in which the *l* would be maintained intact in Upper Italy. The *d*, on the other hand, is not resolved by elision, but by its reduction to *r* (e.g., Sicil. *virire, Neap. dialets verè, vedere*), a phenomenon which has been frequently compared, perhaps with too little caution, with the *d* passing into *rs* (*d*) in the Umbrian inscriptions. The Neapolitan reduction of *nt* into *nd* has its analogies in the reduction of *nc* (*nk*) into *ng*, and of *mp* into *mb*, which is also a feature of the Neapolitan dialects, and in that of *ns* into *nz*; and here and there

<sup>1</sup> On this point see the chapter, "La terra ferma veneta considerata in ispecie nei suoi rapporti con la sezione centrale della zona ladina," in *Arch.*, i. 406-47.

we even find a reduction of *uf* into *mb* (*uf*, *ur*, *no*, *mb*), both in Sicilian and Neapolitan (e.g., at Castelcivita in Sicily 'mbiurnu, inferno, and in the Abuzzi *cumbonu*, 'mbonu), confondere, infondere). Here we find ourselves in a series of phenomena to which it may seem that some special contributions were furnished by Oscan and Umbrian (*ut*, *up*, *ne* into *nd*, &c.), but for which more secure and general, and so to say "i othormal," analogies are found in modern Greek and Albanian. The Sicilian does not appear to fit in here as far as the formulae *nt* and *mp* are concerned; it rather agrees with the Neapolitan through *nt* passing into *rd*; and it may even be said to go counter to this tendency by reducing *uf* to *né* (e.g., *pànciri*, pungere). Nay, even in the passing of the sonant into the sibil, the Neapolitan dialects would yield special and important contributions (nor is even the Sicilian limited to the case just specified), among which we will only mention the change of *d* between vowels into *t* in the last syllable of proproxytones (e.g., *ummeto*, umido). From these series of sonants changing into sibilants comes a peculiar feature of the southern dialects.—A pretty common characteristic is the regular progressive assimilation by which *nd* is reduced to *nr*, *mb* to *mr*, and even *no* also to *mr* (*nr*, *mb*, *no*, e.g., Sicil. *stauri*, Neap. *staurere*, secudere; Sicil. *chiunnu*, Neap. *chiunne*, piombo; Sicil. and Neap. 'mvidia, invisida). As belonging to this class of phenomena the Palaeo-Italic analogy (*nd* into *nr*, *n*), of which the Umbrian furnishes special evidence, readily suggests itself.—Another important common characteristic is the reduction of *ij*, *ij*, *ff*, to *é* (*ky*), *é*, *é* (cf. the Genoese; B. 1), whence, e.g., Sicil. *chianu*, Neap. *chiane*, piano (plano, pljano, pjano); Sicil. *sivà*, Neap. *scàta*, sepia; Sicil. *vugà*, Neap. *arraggiu*, rahlia; Sicil. *surì* (*surì*), Neap. *sure*, fiore.—Further is to be noted the tendency to the sibilant of *ce*, *ci* for which Sicil. *jazzu*, ghiaccio, and Neap. *licete*, lecito, may serve as examples (*Arch.*, ii. 149).—A tendency more particularly betrayed in Upper Italy.—There is a common inclination also to elide the initial unaccented palatal vowel, and to prefix *a*, especially before *r* (this second tendency is found likewise in Southern Sardinian, &c.; see *Arch.*, ii. 138); e.g., Sicil. 'ntènniri, Neap. 'ntènnere, intendere; Sicil. *arricanniri*, Neap. *arriganare*, ricannare (see *Arch.*, ii. 150).—In complete contrast to the tendency to get rid of double consonants which has been particularly noted in Venetian (C. 1), we here come to the great division of Italy where the tendency grows strong to gemination (or the doubling of consonants); and the Neapolitan in this respect goes farther than the Sicilian (e.g., Sicil. *doppu*, dopo; 'uscunnu, insiene, in-simul; Neap. *dillectato*, dilicato; 'ummeto, umido; *dèbbete*).—As to the phonetic phenomena connected with the syntax (see B. 2), it is sufficient to cite such Sicilian examples as *nisuna rouna*, nessuna donna, alongside of *c'è donni*, *c'è donne*; *cinqu jorna*, cinque giorni, alongside of *chìu ghiorra*, più giorni; and the Neapolitan *la bocca*, la bocca, alongside of *a bocca a bocca*, ad buccam, &c.

We now proceed to the special consideration, first, of the Sicilian and, secondly, of the dialects of the mainland.

a. *Sicilian*.—The Sicilian vocalism is conspicuously etymological. Though differing in colour from the Tuscan, it is not less noble, and between the two there are remarkable points of contact. The dominant variety ignores the diphthongs *é* and *é*, as it has been seen that they are ignored in Sardinia (B. 2), and here also the *é* and the *é* appear intact; but the *é* and the *é* are fittingly represented by *é* and *u*; and with equal symmetry unaccented *a* and *o* are reproduced by *é* and *u*. Examples: *tèni*, tiene; *nòvu*, nuovo; *pilu*, pelo; *jugu*, giogo; *criddiri*, erodere; *sira*, sera; *vina*, vena; *sidi*, il sole; *ura*, ora. The *é* and *é* of position are represented by *r* and *o* (*vermi*, verme; *novèddu*, novello; *morti*, la morte; *cornu*), and thus normally they correspond to the open *e* and *o* of the Tuscan. And if in some cases the Sicilian appears to be exceptional (*stidda*, stella; *rituniri*, vendere; *juvna*, &c.), it usually corresponds even in this with the Tuscan, where also we find the same apparent exception of the closed instead of the open vowel (*stella*, *scudere*, *forma*, &c., *Arch.*, ii. 146).—In the evolution of the consonants it is enough to add here the change of *lj* into *ghj* (e.g., *figghiu*, figlio) and of *ll* into *dd* (e.g., *gaddu*, gallo).

b. *Dialects of the Neapolitan Mainland*.—The Calabrian (by which is to be understood more particularly the vernacular group of the two Further Calabrias) may be fairly considered as a continuation of the Sicilian type, as is seen from the following examples:—*cori*, cuore; *petra*; *fimmina*, femina; *vuci*, voce; *onuri*, onore; *figghiu*, figlio; *spaddle*, spalle; *trizza*, treccia (here the *d* of the nexus *nd*, however, is not subject to the assimilation which is common to Sicilian and Neapolitan in general: e.g., *quandu*, *congendu*, piangendo). Even the *h* for *é=ff*, as in *huri* (Sicil. *surì*, fiore), which is characteristic of the Sicilian, has its forerunners in the island (see *Arch.*, ii. 456). Along the coast of the extreme south of Italy, when once we have passed the interruptions caused by the Basilisco type (so called from the Basilicata), the Sicilian vocalism again presents itself in the Otrantine, especially in the seaboard of Capo di Leuca. In the Lecce variety of the Otrantine the vocalism which has just been described as Sicilian also keeps its ground in the main (cf. Morosi, *Arch.*, iv.): *sira*, sera; *lellu*, oliveto; *pilu*; *ura*, ora; *dulure*.

Nay more, the Sicilian phenomenon of *lj* into *ghj* (*figghiu*, figlio, &c.) is well marked in Terra d'Otranto and also in Terra di Bari, and even extends through the Capitanata and the Basilicata (cf. D'Ovidio, *Arch.*, iv. 159-60). As strongly marked in the Terra d'Otranto is the insular phenomenon of *ll* into *dd* (*dr*), which is also very widely distributed through the Neapolitan territories on the eastern side of the Apennines, sending overshoots even to the Abruzzo. But in Terra d'Otranto we are already in the midst of the diphthongs of *é* and *é*, both non-positional and positional, the development or permanence of which is determined by the quality of the unaccented final vowel,—as generally happens in the dialects of the south. The diphthongal product of the *é*, and hence also of the *é* of position, is here *uc*. The following are examples from the Lecce variety of the dialect: *core*, pl. *cueri*; *netu*, *mieti*, *mete*, *mieto*, *mieti*, *miete* (Lat. *mētere*); *scutu*, *sienti*, *scute*; *olu*, *vili*, *olu*, *voli*, *vola*; *mortu*, *maedi*, *morde*. The recalls the fundamental reduction which belongs to the Gallic (not to speak of the Spanish) regions, and stretches through the Terra di Bari, where there are other diphthongs curiously suggestive of the Gallic: e.g., at Bitonto alongside of *lucche*, *lugo*, *suonne*, *sonno*, we have the *oi* and the *ai* from *i* or *é* of the previous phase (*viciu*, vicino), and the *au* from *o* of the previous phase (*anaru*, onore), besides a diphthongal disturbance of the *d*. Here also occurs the change of *i* into an *e* more or less pure (thus, at Cisternino, *scansullèr*, consolata; at Canosa di Puglia, *arruete*, *arrivata*; *n'ghèpe*, "io capa," that is, in capo); to which may be added the continual weakening or elision of the unaccented vowels not only at the end but in the body of the word (thus, at Bitonto, *vendell*, *sprenz*). A similar type meets us as we cross into Capitanata (Cerignola: *faciute*, *facera*; *affèss*, *offese*; *sfaziunne*, *soddisfaziunne*; *n'ghèpe*, in capo; *n'zullèr*, *insultata*; *arraggèr*, *arrabbiato*); such forms being apparently the outposts of the Abruzzian, which, however, is only reached through the Molise—a district not very populous even now, and still more thinly peopled in bygone days—whose prevailing forms of speech in some measure interrupt the historical continuity of the dialects of the Adriatic versant, presenting, as it were, an irruption from the other side of the Apennines. In the head valley of the Molise, at Agnone, the legitimate precursors of the Abruzzian vernaculars reappear (*fateica*, *fatica*; *perdoiva*, *perdeva*; *voire*, *vero*; *paina*, *pena*; *scupicura*; *cheurè*; *scelleriet*, *scellerati*, where, however, the disturbance of the *a* is only occasional, i.e., is dependent on the *é* formerly heard in the end of the word; cf. *maltrattata*, *spèrta*, &c.). The following are pure Abruzzian examples. (1) From Fucchinico (Abruzzo Citeriore): *voire*, *vivo*; *vrajè*, *re*; *allaure*, *allora*; *craune*, *corona*; *circhè*, *cercare*; *mèlè*, *male*; *gènnè*, *grande*; *quèvne*; but *n'zullèr*, *insultata*; *strade*, *strada* (where again it is seen that the reduction of the *a* depends on the quality of the final unaccented vowel, and that it is not produced exclusively by *i*, which would give rise to a further reduction: *scillarite*, *scellerati*; *ampire*, *impàn*). (2) From Pratola Peligna (Abruzzo Ulteriore II.): *vrajè*, *mia*; *naure*, *onore*; *n'juriet*, *ingurata*; *desperète*, *disperata* (alongside of *venneca*, *vendicare*). It almost appears that a continuity with Emilian ought to be established across the Marches (where another irruption of greater "Italianness" has taken place; a third of more dubious origin has been indicated for Venice, C. 1); see *Arch.*, ii. 445. A negative characteristic for Abruzzian is the absence of *é=ij* and of *é=ff*; and the reason seems evident. Here the *ij* and *ff* themselves appear to be modern or of recent reduction,—the ancient formulae sometimes occurring intact (as in the Bergamasque for Upper Italy), e.g., *plànje* and *prànje* alongside of *piànje*, *pragnè*.<sup>1</sup> To the south of the Abruzzi begins and in the Abruzzi grows prominent that contrast in regard to the formulae *all* *ald* (resolved in the Neapolitan and Sicilian into *aut*, &c., just as in the Piedmontese, &c.) by which the types *aldare*, *altare*, and *calle*, *caldò*, are reached.—For the rest, when the condition and connexion of the vowel system still retained by so large a proportion of the dialects of the eastern versant of the Neapolitan Apennines, and the difference which exists in regard to the preservation of the unaccented vowels between the Liguurian and the Gallo-Italic forms of speech on the other versant of the northern Apennines, are considered, one cannot fail to see how much justice there is in the longitudinal or Apenninian partition of the Italian dialects indicated by Dante.—But, to continue, in the Basilicata, which drains into the Gulf of Taranto, and may be said to lie within the Apennines, not only is the elision of final unaccented vowels a prevailing characteristic; there are also frequent elisions of the unaccented vowels within the word. Thus at Matera: *sintenn la femn chessa còs*, sentendo la femina questa cosa; *dispràt*, disperata; at Saponara di Grumento: *womni scilrati*, uomini scellerati; *muetta*, vendetta.—But even if we return to the Mediterranean versant and, leaving the Sicilian type of the Calabrias, retrace our steps till we pass into the Neapolitan pure and simple, we find that even in Naples the unaccented final vowels behave badly, the labial turning to *é* (*biellè*, bello) and even the *a* (*bellà*) being greatly weakened. And here

<sup>1</sup> So again even still *pleune* and *prore*, *piove*, which suggests a fine Latinism of another sort still retained,—*nenque*, *nigunere*; so that in the most ancient chronicle of Aquila (str. 437) the reading *se pioveva o nenquera* is truly dialectic.



occurs a Palæo-Italic instance which is worth mention: while Latin was accustomed to drop the *u* of its nominative only in presence of *r* (*gener* from \**gener-u-s*, *vir* from \**vir-u-s*; cf. the Tuscan or Italian apocopated forms *vèner* = *vènere*, *venner* = *vennero*, &c.), Oscan and Umbrian go much further: Oscan, *burz* = \**hort-u-s*, Lat. *hortus*; Umbr. *pihaz*, *piatus*; *empz*, *emptus*, &c. In Umbrian inscriptions we find *u* alternating with the *a* of the nom. sing. fem. and plur. neut. In complete contrast with the Sicilian vocalism is the Neapolitan *e* for unaccented and particularly final *i* of the Latin and Neo-Latin or Italian phrases (e.g., *viene*, *vienei*; cf. *infra*), to say nothing further of the regular diphthongization, within certain limits, of accented *e* or *o* in position (*apierc*, *aperto*, fem. *aperta*; *moritc*, *morto*, fem. *morta*, &c.).—Characteristic also of the Neapolitan are certain insertions of vowels to obviate certain collocations: hence *dàcijo* for *odio*, or more curiously *àvotrè*, *altro* (i.e., *aultro*, *autro*, as in Upper Italy, hence *dòtro*, *av-g-trò*) or *cubèrc*, *colto* (i.e., *cuolto*, *cuòto*, *cuòv-g-to*). In the quasi-morphological domain it is to be noted how the Siculo-Calabrian *u* for the ancient *δ* and *ῥ*, and the Siculo-Calabrian *i* for the ancient *ε*, *ι*, are also still found in the Neapolitan, and, in particular, that they alternate with *o* and *e* in a manner that is determined by the difference of termination. Thus *cosetore*, *caicitore*, pl. *coseturc* (i.e., *costuri*, the *i* passing into *e* in keeping with the Neapolitan characteristic already mentioned); *sposc*, *sposo*, pl. *spusc*; *noce*, *noce*, pl. *nucè*: *credc*, *io credc*; *eride* (\**eridi*), *tu credi*; *crede*, *egli crede*; *nigrè*, but *negra*.

Passing now to a cursory mention of purely morphological phenomena, we begin with that form which is referred to the Latin pluperfect (see A. 1, B. 2), but which here too performs the functions of the conditional. Examples from the living dialects of (1) Calabria Citeriore are *faccru*, *farei* (Castrovillari); *tu te la collerra*, *tu te l'accollesti* (Cosenza); *Vaccettèra*, *l'acettterebbe* (Crimaldi); and from those of (2) the Abruzzi, *vulèr*, *vorrei* (Castelli); *dèrè*, *darei* (Atessa); *candèrè*, *canterei*. For the dialects of the Abruzzi, we can check our observations by examples from the oldest chronicle of Aquila, as *non habèru lassato*, *non avrebbe lasciato* (str. 180). There are some interesting remains (more or less corrupted both in form and usage) of ancient consonantal terminations which have not yet been sufficiently studied: *s'incaricaviti*, *s'incaricava*, -abat (Basilicata, Senise); *ebbiti*, *ebbe* (*ib.*); *avtadi*, *aveva* (Calabria, Grimaldi); *arriavadi*, *arrivò* (*ib.*). The last example also gives the -an of the 3d pers. sing. perf. of the first conjugation, which still occurs in Sicily and between the horns of the Neapolitan mainland. In the Abruzzi (and in the Ascolan district) the 3d person of the plural is in process of disappearing (the -no having fallen away and the preceding vowel being obscured), and its function is assumed by the 3d person singular; cf. C. 1. The explanation of the Neapolitan forms *songhè*, *io sono*, *essi sono*, *donghè*, *io do*, *stozghè*, *io sto*, as also of the enclitic of the 2d person plural which exists, e.g., in the Sicil. *avissivv*, Neap. *avistevv*, *aveste*, has been correctly given more than once. It may be remarked in conclusion that this Neo-Latin region keeps company with the Roumanian in maintaining in large use the -ora derived from the ancient neuter plurals of the type *tempora*: Sicil. *jùcuvra*, *giuochi*; Calabr. *niduvra*, Abruzz. *nidvrc*, *nidi*. As for literary documents, if mere fragments and dubious instances are left out of account, Sicilian poetry goes back as far as to the first half of the 13th century, to which century also the chronicles written in Sicilian extend; but either the copies which we possess are not contemporary or the palæographic key of the readings preserved to us is wanting. In the library of Naples, some MSS. of the 14th century contain poetical translations of which the dialect would seem to belong to the Mediterranean versant of the southern provinces. The old rhymed chronicle of Aquila, which has been referred to more than once above, belongs to the 14th century.

4. *Dialects of Umbria, the Marches, and the Province of Rome.*—The Ascolan dialect (basin of the Tronto) still depends on the Abruzzan system; and, speaking generally, several conspicuous southern phenomena are widely distributed through the region now under review. Thus the *ll* = *ld* extends from the Abruzzi (Nocera: *callu*, *caldo*; Rome: *ariscalla*, *riscalda*); the phenomenon, however, occurs also in Corsica; and the assimilation of *nd* into *nn*, and of *mb* into *mm* stretches through Umbria, the Marches, and Rome, and even crosses 'rom the Roman province into southern Tuscany (Rieti: *quanno*, *quande*; Spoleto: *comannava*, *comandava*; Assisi: *piagnanno*, *piagnando*; Sanseverino Marches: *piagnenne*, *mnnee*, *invece* (imbec); Fabriano: *venneccasse*, *vendicarsi*; Osimo: *monno*, *mondo*; Rome: *fronna*, *fronda*; *pianno*, *piabbo*; Pitigliano (Tuscany): *quanno*, *piagnanno*). Even the diphthongs of the *e* and the *o* in position are largely represented. Examples are—at Nocera: *tiempi*, *uoochi*, *stuorti*; Assisi and Fabriano: *tiempo*; Orvieto: *tiempo*, *tierra*, *le tuorte*, *li torti*, and even *duonna*. The change of *l* into *r*, so frequent throughout this region, and particularly characteristic of Rome, is a phenomenon common to the Aquilan dialect. Similar facts might be adduced in abundance. And it is to be noted that the features common to Umbro-Roman and the Neapolitan dialects must have been more numerous in the past, as this was the region where the Tuscan current met the southern, and by reason of its

superior culture gradually gained the ascendancy.<sup>1</sup>—The phonological connexions between the Northern Umbrian, the Aretine, and the Gallo-Italic type have already been indicated (B. 2). In what relates to morphology, the -orno of the 3d pers. plur. of the perfect of the first conjugation has been pointed out as an essential peculiarity of the Umbro-Roman territory; but even this it shares with the Aquila vernaculars, which, moreover, extend it to the other paradigms: *antorno*, *timorono*, &c. Further, this termination is found also in the Tuscan dialects.—In a large part of Umbria an *u* or *t* is prefixed to the sign of the dative: *tu lu*, *a lui*; *mal ve, al re*; which must be the remains of the auxiliary prepositions *in(us) ad(m)ud*, cf. Prov. *aub, am*, (cf. *Arch.*, ii. 444-46).—By means of the series of Perugian texts this group of dialects may be traced back with confidence to the 13th century; and to this region should also belong a "Confession," half Latin half vernacular, dating from about the 11th century, elided and annotated by Flechia (*Arch.*, vii. 121 *sqq.*). The "chronicle" of Monaldeschi has been already mentioned. A collection of ancient dialectal texts of Perugia and the neighbouring districts is to be published by Monaldi in the *Archivio Glottologico*.

#### D. Tuscan, and the literary language of the Italians.

We have now only to deal with the Tuscan territory. It is bounded on the W. by the sea. To the north it terminates with the Apennines; for Romagna Toscana, the strip of country on the Adriatic versant which belongs to it administratively, is assigned to Emilia as regards dialect. In the north-west also the Emilian presses on the Tuscan, extending as it does down the Mediterranean slope of the Apennines in Lunigiana and Garfagnana. Intrusions which may be called Emilian have also been noted to the west of the Apennines in the district where the Arno and the Tiber take their rise (Aretine dialects); and it has been seen how thence to the sea the Umbrian and Roman dialects surround the Tuscan. Such are the narrow limits of the "promised land" of the language which has succeeded and was worthy to succeed Latin in the history of Italian culture and civilization,—the land which comprises Florence, Siena, Lucca, and Pisa.—The Tuscan type may be best described by the negative method. There do not exist in it, on the one hand, any of those phenomena by which the other dialectal types of Italy mainly differ from the Latin base (such as *ü* = *û*; frequent elision of unaccented vowels; *ba* = *gna*; *š* = *ř*; *nn* = *nd*, &c.), nor, on the other hand, is there any series of alterations of the Latin base peculiar to the Tuscan. This twofold negative description may further serve for the Tuscan or literary Italian as contrasted with all the other Neo-Latin languages; indeed, even where the Tuscan has a tendency to alterations common to other types of the family, it shows itself more sober and self-denying,—as may be seen in the reduction of the *t* between vowels into *d* or of *c* (*k*) between vowels into *g*, which in Italian affects only a small part of the lexical series, while in Provençal or Spanish it may be said to pervade the whole (e.g., Prov. and Span. *mudar*, Ital. *mutare*; Prov. *segur*, Span. *seguro*, Ital. *sicuro*). It may consequently be affirmed without any partiality that, in respect to historical nobility, the Italian not only holds the first rank among Neo-Latin languages, but almost constitutes an intermediate grade between the ancient or Latin and the modern or Romance.—What has just been said about the Tuscan, as compared with the other dialectal types of Italy, does not, however, preclude the fact that in the various Tuscan veins, and especially in the plebeian forms of speech, there occur particular instances of phonetic decay; but these must of necessity be ignored in

<sup>1</sup> There is therefore nothing surprising in the fact that, for example, the chronicle of Monaldeschi of Orvieto (14th century) should indicate a form of speech of which Muratori remarks: "Romanis tunc familiaris, vimirum que in nonnullis aredebat ad Neapolitanam seu vobibus seu pronunciationem." The *alt* into *ait*, &c. (*astro*, *moito*), which occur in the well known *Vita di Cola di Rienzo*, also shows Abruzzan affinity.

<sup>2</sup> This second prefix is common to the opposite valley of the Metauro, and appears farther south in the form of *me*,—Camerino: *me lu pettu*, nel petto, *me lu Sepurguru*, al Sepolcro.

so brief a sketch as the present. We shall confine ourselves to noting—what has a wide territorial diffusion—the reduction of *c* (*k*) between vowels to a mere breathing (e.g., *jūilo*, fuoco, but *porco*), or even its complete elision; the same phenomenon occurs also between word and word (e.g., *la casa*, but *in casa*), thus illustrating anew that syntactic class of phonetic alterations, either qualitative or quantitative, conspicuous in this region also, which has been already discussed for insular and southern Italy (B. 2; C. 2, 3), and could be exemplified for the Roman region as well (C. 4). As regards one or two individual phenomena, it must also be confessed that the Tuscan or literary Italian is not so well preserved as some other Neo-Latin tongues. Thus, French always keeps in the beginning of words the Latin formulæ *cl*, *pl*, *pl* (*cléf*, *plaisir*, *fleur*, in contrast with the Italian *chiave*, *piacere*, *fiore*); but the Italian makes up for this by the greater vigour with which it is wont to resolve the same formula within the words, and by the greater symmetry thus produced between the two series (in opposition to the French *cléf*, *clave*, we have, for example, the French *ail*, *oclo*; whereas, in the Italian, *chiave* and *occhio* correspond to each other). The Italian as well as the Roumanian has lost the ancient sibilant at the end (*-s* of the plurals, of the nominative singular, of the 2d persons, &c.) which throughout the rest of the Romance area has been preserved more or less tenaciously; and consequently it stands lower than old Provençal and old French, as far as true declension or, more precisely, the functional distinction between the forms of the *casus rectus* and the *casus obliquus* is concerned. But even in this respect the superiority of French and Provençal has proved merely transitory, and in their modern condition all the Neo-Latin forms of speech are generally surpassed by Italian even as regards the pure grammatical consistency of the noun. In conjugation Tuscan has lost that tense which for the sake of brevity we shall continue to call the pluperfect indicative: though it still survives outside of Italy and in other dialectal types of Italy itself (C. 3 b; cf. B. 2). It has also lost the *futurum exactum*, or perfect subjunctive, which is found in Spanish and Roumanian. But no one would on that account maintain that the Italian conjugation is less truly Latin than the Spanish, the Roumanian, or that of any other Neo-Latin language. It is, on the contrary, by far the most distinctively Latin as regards the tradition both of form and function, although many effects of the principle of analogy are to be observed, sometimes common to Italian with the other Neo-Latin languages, and sometimes peculiar to itself.

Those who find it hard to believe in the ethnological explanation of linguistic varieties ought to be convinced by any example so clear as that which Italy presents in the difference between the Tuscan or purely Italian type on the one side and the Gallo-Italic on the other. The names in this instance correspond exactly to the facts of the case. For the Gallo-Italic on either side of the Alps is evidently nothing else than a modification—varying in degree, but always very great—of the vulgar Latin, due to the reaction of the language or rather the oral tendencies of the Celts who succumbed to the Roman civilization. In other words, the case is one of new ethnic individualities arising from the fusion of two national entities, one of which, numerically more or less weak, is so far victorious that its speech is adopted, while the other succeeds in adapting that speech to its own habits of utterance. Genuine Italian, on the other hand, is not the result of the combination or conflict of the vulgar Latin with other tongues, but is the pure development of this alone. In other words, the case is that of an ancient national fusion in which vulgar Latin itself originated. Here that is native which in the other case was intrusive.—This greater

purity of constitution gives the language a persistence, which approaches permanent stability. There is no Old Italian to oppose to Modern Italian in the same sense as we have an Old French to oppose to a Modern French. It is true that in the old French writers, and even in the writers who used the dialects of Upper Italy, there was a tendency to bring back the popular forms to their ancient dignity; and it is true also that the Tuscan or literary Italian has suffered from the changes of centuries; but nevertheless it remains undoubted that in the former cases we have to deal with general transformations between old and new, while in the latter it is evident that the language of Dante continues to be the Italian of modern speech and literature. This character of invariability has thus been in direct proportion to the purity of its Latin origin, while, on the contrary, where popular Latin has been adopted by peoples of foreign speech, the elaboration which it has undergone along the lines of their oral tendencies becomes always the greater the farther we get away from the point at which the Latin reached them,—in proportion, that is, to the time and space through which it has been transmitted in these foreign mouths.<sup>1</sup>

As for the primitive seat of the literary language of Italy, not only must it be regarded as confined within the limits of that narrower Tuscany already described; strictly speaking, it must be identified with the city of Florence alone. Leaving out of account, therefore, a small number of words borrowed from other Italian dialects, as a certain number have naturally been borrowed from foreign tongues, it may be said that all that was not Tuscan was eliminated from the literary form of speech. If we go back to the time of Dante we find, throughout almost all the dialects of the mainland with the exception of Tuscan, the change of vowels between singular and plural seen in *pace*, *paissi*; *quello*, *quilli*; *amore*, *amuri* (see B. 1; C. 3 b); but the literary language knows nothing at all of such a phenomenon, because it was unknown to the Tuscan region. But in Tuscan itself there were differences between Florentine and non-Florentine; in Florentine, e.g., it was and is usual to say *dipignere* and *pugnere*, while the non-Florentine had it *dipegnere* and *pognere* (Lat. *pingere*, *pungere*). Now, it is precisely the Florentine forms which alone have currency in the literary language.

In the ancient compositions in the vulgar tongue, especially in poetry, non-Tuscan authors on the one hand accommodated their own dialect to the analogy of that which they felt to be the purest representative of the language of ancient Roman culture, while the Tuscan authors in their turn did not refuse to adopt the forms which had received the rights of citizenship from the literary celebrities of other parts of Italy. It was this state of matters which gave rise, in past times, to the numerous disputes about the true fatherland and origin of the literary language of the Italians. But these have been deprived of all right to exist by the scientific investigation of the history of that language. If the older Italian poetry assumed or maintained forms alien to Tuscan speech, these forms were afterwards gradually eliminated, and the field was left to those which were purely Tuscan and indeed purely Florentine. And thus it remains absolutely true that, so far as phonetics, morphology, rudimental syntax, and in short the whole character and material of words and sentences are concerned, there is no literary language of Europe that is more

<sup>1</sup> A complete analogy is afforded by the history of the Aryan or Sanskrit language in India, which in space and time shows always more and more strongly the reaction of the oral tendencies of the aboriginal races on whom it has been imposed. Thus the Pali presents the ancient Aryan organism in a condition analogous to that of the oldest French, and the Prakrit or the Dramas, on the other hand, in a condition like that of modern French.



thoroughly characterized by homogeneity and oneness, as if it had come forth in a single cast from the furnace, than the Italian.

But on the other hand it remains equally true that, so far as concerns a living confidence and uniformity in the use and style of the literary language—that is, of this Tuscan or Florentine material called to nourish the civilization and culture of all the Italians—the case is not a little altered, and the Italian nation appears to enjoy less fortunate conditions than other nations of Europe. Modern Italy had no glowing centre for the life of the whole nation into which and out of which the collective thought and language could be poured in ceaseless current for all and by all. Florence has not been Paris. Territorial contiguity and the little difference of the local dialect facilitated in the modern Rome the elevation of the language of conversation to a level with the literary language that came from Tuscany. A form of speech was thus produced which, though certainly destitute of the grace and the abundant flexibility of the Florentine, gives a good idea of what the dialect of a city becomes when it makes itself the language of a nation that is ripening its civilization in many and dissimilar centres. In such a case the dialect loses its slang and petty localisms, and at the same time also somewhat of its freshness; but it learns to express with more conscious sobriety and with more assured dignity the thought and the feeling of the various peoples which are fused in one national life. But what took place readily in Rome could not with equal ease happen in districts whose dialects were far removed from the Tuscan. In Piedmont, for example, or in Lombardy, the language of conversation did not correspond with the language of books, and the latter accordingly became artificial and laboured. Poetry was least affected by these unfortunate conditions; for poetry may work well with a multiform language, where the need and the stimulus of the author's individuality assert themselves more strongly. But prose suffered immensely, and the Italians had good cause to envy the spontaneity and confidence of foreign literatures—of the French more particularly. In this reasonable envy lay the justification and the strength of the Manzoni school, which aimed at that absolute naturalness of the literary language, that absolute identity between the language of conversation and that of books, which the bulk of the Italians could reach and maintain only by naturalizing themselves in the living speech of modern Florence. The revolt of Manzoni against

artificiality and mannerism in language and style was worthy of his genius, and has been largely fruitful. But the historical difference between the case of France (with the colloquial language of Paris) and that of Italy (with the colloquial language of Florence) implies more than one difficulty of principle; in the latter case there is sought to be produced by deliberate effort of the *litterati* what in the former has been and remains the necessary and spontaneous product of the entire civilization. Manzoni's theories too easily lent themselves to deplorable exaggerations; men fell into a new artificiality, a manner of writing which might be called vulgar and almost slangy. The remedy for this must lie in the regulating power of the labour of the now regenerate Italian intellect,—a labour ever growing wider in its scope, more assiduous, and more thoroughly united.

*Literature.*—Fornow in the third volume of his *Römische Studien* (Zurich, 1806-8) gave a good survey of the dialects of Italy. The dawn of rigorously scientific methods had not then appeared; but Fornow's view is wide and genial. Similar praise is due to Biondelli's work *Sui dialetti gallo-italici* (Milan, 1853), which, however, is still ignorant of Diez. Fuchs, between Fornow and Biondelli, had made himself so far acquainted with the new methods; but his exploration (*Ueber die sogenannten unregelmässigen Zeitwörter in den Romanischen Sprachen, nebst Andeutungen über die wichtigsten romanischen Mundarten*, Berlin, 1840), though certainly of utility, was not very successful. Nor can the rapid survey of the Italian dialects given by Diez be ranked among the happiest portions of his great masterpiece. Among the followers of Diez who distinguished themselves in this department the first outside of Italy were certainly Mussafia, a cautious and clear continuator of the master, and the singularly acute Schuchardt. Next came the *Archivio glottologico italiano* (Rome, from 1873).—In historical study applied specially to the literary language Nannucci prepared the way with much sagacity and breadth of view; it is enough to mention his *Analisi critica dei verbi italiani* (Flor., 1844). Among the works of the disciples of the modern method may here be noted Canello, "*Gli allotropi italiani*" (*Arch.*, iii, 285-419) and Caix, *Origini della lingua poetica italiana* (Florence, 1880), which resolves itself into an accurate historical examination of the dialectal forms that occur in the old poetry.—For almost a quarter of a century a matchless investigator, Giovanni Flechia, has devoted assiduous, keen, and genial labour to the history and description both of the dialects and of the literary language (see *Arch.*, ii, 396, iii, 176).—Biondelli's book is of no small service also for the numerous translations which it contains of the Prodigal Son into Lombard, Piedmontese, and Emilian dialects. A dialogue translated into the vernaculars of all parts of Italy will be found in Zuccagni Orlandini's *Raccolta di dialetti italiani con illustrazioni etnologiche* (Florence, 1864). And every dialectal division is abundantly represented in a series of versions of a short novel of Boccaccio's, which Papanti has published under the title *I parlari italiani in Certaldo*, &c. (Leghorn, 1875). (G. I. A.)

#### PART IV.—LITERATURE.

1. *Origins.*—There is one characteristic fact that distinguishes the Italy of the Middle Ages with regard to its intellectual conditions, and that is the tenacity with which the Latin tradition clung to life. At the end of the 5th century the northern conquerors invaded Italy. The Roman world crumbled to pieces. A new kingdom arose at Ravenna under Theodoric, and there learning was not extinguished. The liberal arts flourished, the very Gothic kings surrounded themselves with masters of rhetoric and of grammar. The names of Cassiodorus, of Boetius, of Symmachus, are enough to show how Latin thought maintained its power amidst the political effacement of the Roman empire. And this thought held its ground throughout the subsequent ages and events. Thus, while elsewhere all culture had died out, there still remained in Italy some schools of laymen,<sup>1</sup> and some really extraordinary men were educated in them, such as Ennodius, a poet more

pagan than Christian, Arator, Fortunatus, Venantius, Jovannicus, Felix the grammarian, Peter of Pisa, Paulinus of Aquileia, and many others, in all of whom we notice a contrast between the barbarous age they lived in and their aspiration towards a culture that should reunite them to the classical literature of Rome. The Italians never had much love for theological studies, and those who were addicted to them preferred Paris to Italy. It was something more practical, more positive, that had attraction for the Italians, and especially the study of Roman law. This zeal for the study of jurisprudence furthered the establishment of the mediæval universities of Bologna, Padua, Vicenza, Naples, Salerno, Modena, and Parma; and these, in their turn, helped to spread culture, and to prepare the ground in which the new vernacular literature was afterwards to be developed. The tenacity of classical traditions, the affection for the memories of Rome, the preoccupation with political interests, particularly shown in the wars of the Lombard communes against the empire of the Hohenstaufens, a spirit more naturally inclined to practice

<sup>1</sup> See Giesebrecht, *De Litterarum Studiis apud Italos primis Mediævi Sæculis*, Berlin, 1845.

than to theory—all this had a powerful influence on the fate of Italian literature. Italy was wanting in that combination of conditions from which the spontaneous life of a people springs. This was chiefly owing to the fact that the history of the Italians never underwent interruption,—no foreign nation having come in to change them and make them young again. That childlike state of mind and heart, which in other Latin races, as well as in the Germanic, was such a deep source of poetic inspiration, was almost utterly wanting in the Italians, who were always much drawn to history and very little to nature; so, while legends, tales, epic poems, satires, were appearing and spreading on all sides, Italy was either quite a stranger to this movement, or took a peculiar part in it. We know, for example, what the Trojan traditions were in the Middle Ages; and we should have thought that in Italy—in the country of Rome, retaining the memory of *Aeneas* and *Virgil*—they would have been specially developed, for it was from *Virgil* that the mediæval sympathy for the conquered of *Troy* was derived. In fact, however, it was not so. A strange book made its appearance in Europe, no one quite knows when, the *Historia de excidio Troje*, which purported to have been written by a certain *Dares the Phrygian*, an eye-witness of the Trojan war. In the Middle Ages this book was the basis of many literary labours. *Benoit de Sainte-More* composed an interminable French poem founded on it, which afterwards in its turn became a source for other poets to draw from, such as *Herbert of Fritzlar* and *Conrad of Würzburg*. Now for the curious phenomenon displayed by Italy. Whilst *Benoit de Sainte-More* wrote his poem in French, taking his material from a Latin history, whilst the two German writers, from a French source, made an almost original work in their own language,—an Italian, on the other hand, taking *Benoit* for his model, composed in Latin the *Historia destructionis Troje*; and this Italian was *Guido delle Colonne* of *Messina*, one of the vernacular poets of the Sicilian school, who must accordingly have known well how to use his own language. *Guido* was an imitator of the Provençals; he understood French, and yet wrote his own book in Latin, nay, changed the romance of the Troubadour into serious history. Much the same thing occurred with the other great legends. That of *Alexander the Great* gave rise to many French, German, and Spanish poems,—in Italy, only to the Latin distichs of *Qualichino of Arezzo*. The whole of Europe was full of the legend of *Arthur*. The Italians contented themselves with translating and with abridging the French romances, without adding anything of their own. The Italian writer could neither appropriate the legend nor colour it with his own tints. Even religious legend, so widely spread in the Middle Ages, and springing up so naturally as it did from the heart of that society, only put out a few roots in Italy. *Jacopo di Veragine*, while collecting his lives of the saints, remained only an historian, a man of learning, almost a critic who seemed doubtful about the things he related. Italy had none of those books in which the Middle Age, whether in its ascetic or its chivalrous character, is so strangely depicted. The intellectual life of Italy showed itself in an altogether special, positive, almost scientific form, in the study of Roman law, in the chronicles of *Farfa*, of *Marsicano*, and of many others, in translations from *Aristotle*, in the precepts of the school of *Silerno*, in the travels of *Marco Polo*,—in short, in a long series of facts which seem to detach themselves from the surroundings of the Middle Age, and to be united on the one side with classical Rome and on the other with the Renaissance.

The necessary consequence of all this was that the Latin language was most tenacious in Italy, and that the elaboration of the new vulgar tongue was very slow,—being

in fact preceded by two periods of Italian literature Provençal and French preparatory periods. in foreign languages. That is to say, there were many Italians who wrote Provençal poems, such as the *Marchese Alberto Malaspina* (12th century), *Maestro Ferrari* of *Ferrara*, *Cigala* of *Genoa*, *Zorzi* of *Venice*, *Sordello* of *Mantua*, *Buvello* of *Bologna*, *Nicoletto* of *Turin*, and others, who sang of love and of war, who haunted the courts, or lived in the midst of the people, accustoming them to new sounds and new harmonies. At the same time there was other poetry of an epic kind, written in a mixed language, of which French was the basis, but in which forms and words belonging to the Italian dialects were continually mingling. We find in it hybrid words exhibiting a treatment of sounds according to the rules of both languages,—French words with Italian terminations, a system of vocalization within the words approaching the Italo-Latin usage,—in short, something belonging at once to both tongues, as it were an attempt at interpenetration, at fusion. Such were the *Chanson de Geste*, *Maçaire*, the *Entrée en Espagne* written by *Niccola* of *Padua*, the *Prise de Pampelune*, and some others. All this preceded the appearance of a purely Italian literature.

In the Franco-Italian poems there was, as it were, a clashing, a struggle between the two languages, the French, however, gaining the upper hand. This supremacy became gradually less and less. As the struggle continued between French and Italian, the former by degrees lost as much as the latter gained. The hybridism recurred, but it no longer predominated. In the *Bovo d'Antona* and the *Ruinaro e Lesegrino* the Venetian dialect makes itself clearly felt, although the language is influenced by French forms. Thus these writings, which *Ascoli* has called "miste" (mixed), immediately preceded the appearance of purely Italian works.

It is now an established historical fact that there existed no writing in Italian before the 13th century. It was in the course of that century, and especially from 1250 onwards, that the new literature largely unfolded and developed itself. This development was simultaneous in the whole peninsula, only there was a difference in the subject-matter of the art. In the north, the poems of *Giacomino* of *Verona* and *Bonvecino* of *Riva* were specially religious, and were intended to be recited to the people. They were written in a dialect partaking of the Milanese and the Venetian; and in their style they strongly bore the mark of the influence of French narrative poetry. They may be considered as belonging to the popular kind of poetry, taking the word, however, in a broad sense. Perhaps this sort of composition was encouraged by the old custom in the north of Italy of listening in the piazzas and on the highways to the songs of the jongleurs. To the very same crowds who had been delighted with the stories of romance, and who had listened to the story of the wickedness of *Maçaire* and the misfortunes of *Blumçillon*, another jongleur would sing of the terrors of the *Babilonia Infernale* and the blessedness of the *Gerusalemme celeste*, and the singers of religious poetry vied with those of the *Chansons de Geste*.

In the south of Italy, on the other hand, the love-song prevailed, of which we have an interesting specimen in the *Contrasto* attributed to *Ciullo d'Alcamo*, about which modern Italian critics have much exercised themselves. This "contrasto" (dispute) between a man and a woman in Sicilian dialect certainly must not be considered as the most ancient or as the only southern poem of a popular kind. It belongs without doubt to the time of the emperor *Frederick II.*, and is important as a proof that there existed a popular poetry independent of literary poetry. The *Contrasto* of *Ciullo d'Alcamo* is the most remarkable relic of a kind of poetry that has perished or which perhaps



was smothered by the ancient Sicilian literature. Its distinguishing point was its possessing all the opposite qualities to the poetry of the rhymers of what we shall call the Sicilian school. Vigorous in the expression of feelings, it seems to come from a real sentiment. The conceits, which are sometimes most bold and very coarse, show that it proceeded from the lowest grades of society. Everything is original in Cinullo's *Contrasto*. Conventionality has no place in it. It is marked by the sensuality characteristic of the people of the South.

Siculo-Provençal school.

The reverse of all this happened in the Siculo-Provençal school, at the head of which was Frederick II. Imitation was the fundamental characteristic of this school, to which belonged Enzo, king of Sardinia, Pier delle Vigne, Inghilfredi, Guido and Odo delle Colonne, Jacopo d'Aquino, Rugieri Pugliese, Giacomo da Lentino, Arrigo Testa, and others. These rhymers never moved a step beyond the ideas of chivalry; they had no originality; they did not sing of what they felt in their heart; they abhorred the true and the real. They only aimed at copying as closely as they could the poetry of the Provençal troubadours.<sup>1</sup> The art of the Siculo-Provençal school was born decrepit, and there were many reasons for this,—first, because the chivalrous spirit, from which the poetry of the troubadours was derived, was now old and on its death-bed; next, because the Provençal art itself, which the Sicilians took as their model, was in its decadence. It may seem strange, but it is true, that when the emperor Frederick II., a philosopher, a statesman, a very original legislator, took to writing poetry, he could only copy and amuse himself with absolute puerilities. His art, like that of all the other poets of his court, was wholly conventional, mechanical, affected. It was completely wanting in what constitutes poetry,—ideality, feeling, sentiment, inspiration. The Italians have had great disputes among themselves about the original form of the poems of the Sicilian school, that is to say, whether they were written in Sicilian dialect, or in that language which Dante called "volgare, illustre, anlico, cortigiano"; and the question is not yet settled. But now the critics of most authority hold that the primitive form of these poems was the Sicilian dialect, modified for literary purposes with the help of Provençal and Latin; the theory of the "lingua illustre" has been almost entirely rejected, since we cannot say on what rules it could have been founded, when literature was in its infancy, trying its feet, and lisping its first words. The Sicilian certainly, in accordance with a tendency common to all dialects, in passing from the spoken to the written form, must have gained in dignity; but this was not enough to create the so-called "lingua illustre," which was upheld by Peticari and others on grounds rather political than literary.

Religious lyric poetry in Umbria.

In the 13th century a mighty religious movement took place in Italy, of which the rise of the two great orders of Saint Francis and Saint Dominic was at once the cause and the effect. Around Francis of Assisi a legend has grown up in which naturally the imaginative element prevails. Yet from some points in it we seem to be able to infer that its hero had a strong feeling for nature, and a heart open to the most lively impressions. Many poems are attributed to him. The legend relates that in the eighteenth year of his penance, when almost rapt in ecstasy, he dictated the *Cantico del Sole*. Even if this hymn be really his, it cannot be considered as a poetical work, being written in a kind of prose simply marked by assonances. As for the other poems, which for a long time were believed to be by Saint Francis, their spuriousness is now generally recognized. The true poet

<sup>1</sup> See Gaspari, *Die Sicilianische Dichterschule des 13ten Jahrhunderts*, Berlin, 1878.

who represented in all its strength and breadth the religious feeling that had made special progress in Umbria was Jacopo dei Benedetti of Todi, known as Jacopone. The story is that sorrow at the sudden death of his wife had disordered his mind, and that, having sold all he possessed and given it to the poor, he covered himself with rags, and took pleasure in being laughed at, and followed by a crowd of people who mocked him and called after him "Jacopone, Jacopone." We do not know whether this be true. What we do know is that a vehement passion must have stirred his heart and maintained a despotie hold over him, the passion of divine love. Under its influence Jacopone went on raving for years and years, subjecting himself to the severest sufferings, and giving vent to his religious intoxication in his poems. There is no art in him, there is not the slightest indication of deliberate effort; there is only feeling, a feeling that absorbed him, fascinated him, penetrated him through and through. His poetry was all inside him, and burst out, not so much in words as in sighs, in groans, in cries that often seem really to come from a monomaniac. But Jacopone was a mystic, who from his hermit's cell looked out into the world and specially watched the papacy, scourging with his words Celestine V. and Boniface VIII. He was put in prison and taken with chains, but his spirit lifted itself up to God, and that was enough for him. The same feeling that prompted him to pour out in song ecstasies of divine love, and to despise and trample on himself, moved him to reprove those who forsook the heavenly road, whether they were popes, prelates, or monks. In Jacopone there was a strong originality, and in the period of the origins of Italian literature he was one of the most characteristic writers.

The religious movement in Umbria was followed by another literary phenomenon, that of the religious drama. In 1258 an old hermit, Raniero Fasani, leaving the cavern in which he had lived for many years, suddenly appeared at Perugia. These were very sad times for Italy. The quarrels in the cities, the factions of the Ghibellines and the Guelphs, the interdicts and excommunications issued by the popes, the reprisals of the imperial party, the cruelty and tyranny of the nobles, the plagues and famines, kept the people in constant agitation, and spread abroad mysterious fears. The commotion was increased in Perugia by Fasani, who represented himself as sent by God to disclose mysterious visions, and to announce to the world terrible visitations. Under the influence of fear there were formed "Compagnie di Disciplinanti," who, for a penance, scourged themselves till they drew blood, and sang "Laudi" in dialogue in their confraternities. These "Laudi," closely connected with the liturgy, were the first example of the drama in the vulgar tongue of Italy. They were written in the Umbrian dialect, in verses of eight syllables, and of course they have not any artistic value. Their development, however, was rapid. As early as the end of the same 13th century we have the *Devozioni del Giovanni e Venerdì Santo*, which have some dramatic elements in them, though they are still connected with the liturgical office. Then we have the representation *di un Monaco che andò al servizio di Dio* ("of a monk who entered the service of God"), in which there is already an approach to the definite form which this kind of literary work assumed in the following centuries.

In the 13th century Tuscany was peculiarly circumstanced both as regards its literary condition and its political life. The Tuscans spoke a dialect which most closely resembled the mother-tongue, Latin,—one which afterwards became almost exclusively the language of literature, and which was already regarded at the end of the 13th century as surpassing the others; "Lingua Tusca magis apta est

nd literam sive literaturam": thus writes Antonio da Tempo of Padua, born about 1275. Being very little or not at all affected by the Germanic invasion, Tuscany was never subjected to the feudal system. It had fierce internal struggles, but they did not weaken its life; on the contrary, they rather gave it fresh vigour and strengthened it, and (especially after the final fall of the Hohenstaufens at the battle of Benevento in 1266) made it the first province of Italy. From 1266 onwards Florence was in a position to begin that movement of political reform which in 1282 resulted in the appointment of the Priori delle Arti, and the establishment of the Arti Minori. This was afterwards copied by Siena with the *Magistato dei Nove*, by Lucca, by Pistoia, and by other Guelph cities in Tuscany with similar popular institutions. In this way the guilds had taken the government into their hands, and it was a time of both social and political prosperity. It was no wonder that literature also rose to an unlooked-for height. In Tuscany, too, there was some popular love poetry; there was a school of imitators of the Sicilians, their chief being Dante of Majano; but its literary originality took another line—that of humorous and satirical poetry. The entirely democratic form of government created a style of poetry which stood in the strongest antithesis to the mediæval mystic and chivalrous style. Devout invocation of God or of a lady came from the cloister and the castle, in the streets of the cities everything that had gone before was treated with ridicule or biting sarcasm. Folgore of San Gimignano laughs when in his sonnets he tells a party of Siennese youths what are the occupations of every month in the year, or when he teaches a party of Florentine lads the pleasures of every day in the week. Cene della Chitarra laughs when he parodies Folgore's sonnets. The sonnets of Rustico di Filippo are half fun and half satire; laughing and crying, joking and satire, are all to be found in Cecco Angiolieri of Siena, the oldest "humorist" we know, a far-off precursor of Rabelais, of Montaigne, of Jean Paul Richter, of Sydney Smith. But another kind of poetry also began in Tuscany. Guittone d'Arezzo made art quit chivalrous for national motives, Provençal forms for Latin. He attempted political poetry, and, although his work is full of the strangest obscurities, he prepared the way for the Bolognese school. In the 13th century Bologna was the city of science, and philosophical poetry appeared there. Guido Guinicelli was the poet after the new fashion of the art. In him the ideas of chivalry are changed and enlarged; he sings of love and together with it of the nobility of the mind. The reigning thought in Guinicelli's *Canzoni* is nothing external to his own subjectivity. His speculative mind, accustomed to wandering in the field of philosophy, transfuses its lucubrations into his art. Guinicelli's poetry has some of the faults of the school of Guittone d'Arezzo: he reasons too much; he is wanting in imagination; his poetry is a product of the intellect rather than of the fancy and the heart. Nevertheless he marks a great development in the history of Italian art, especially because of his close connexion with Dante's lyric poetry.

Allegorical poetry.

But before we come to Dante, certain other facts, not, however, unconnected with his history, must be noticed. In the 13th century there were several poems in the allegorical style. One of these is by Brunetto Latini, who, it is well known, was attached by ties of strong affection to Alighieri. His *Tesoretto* is a short poem, in seven-syllable verses, rhyming in couplets, in which the author professes to be lost in a wilderness and to meet with a lady, who is Nature, from whom he receives much instruction. We see here the vision, the allegory, the instruction with a moral object,—three elements which we shall find again in the *Divina Commedia*. Francesco da Barberiuo, a

learned lawyer who was secretary to bishops, a judge, a notary, wrote two little allegorical poems,—the *Documenti d'Amore* and *Del Reggimento e dei Costumi delle Donne*. Like the *Tesoretto*, these poems are of no value as works of art, but are, on the other hand, of importance in the history of manners. A fourth allegorical work was the *Intelligenza*, by some attributed to Dino Compagni, but probably not his, and only a version of French poems.

While the production of Italian poetry in the 13th century was abundant and varied, that of prose was scanty. The oldest specimen dates from 1231, and consists of short notices of entries and expenses by Mattalà di Spinello dei Lambertini of Siena. In 1253 and 1260 there are some commercial letters of other Siennese. But there is no sign of literary prose. Before we come to any, we meet with a phenomenon like that we noticed in regard to poetry. Here again we find a period of Italian literature in French. Halfway on in the century a certain Aldobrando or Aldobrandino (it is not known whether he was of Florence or of Siena) wrote a book for Beatrice of Savoy, countess of Provence, called *Le Régime du Corps*. In 1267 Martino da Canale wrote in the same "langue d'oil" a chronicle of Venice. Rusticiano of Pisa, who was for a long while at the court of Edward I. of England, composed many chivalrous romances, derived from the Arthurian cycle, and subsequently wrote the travels of Marco Polo, which may perhaps have been dictated by the great traveller himself. And finally Brunetto Latini wrote his *Tesoro* in French.

Prose in 13th century.

Next in order to the original compositions in the langue d'oil come the translations or adaptations from the same. There are some moral narratives taken from religious legends; a romance of Julius Cæsar; some short histories of ancient knights; the *Tavola Rotonda*; translations of the *Viaggi* of Marco Polo and of the *Tesoro* of Latini. At the same time there appeared translations from Latin of moral and ascetic works, of histories, and of treatises on rhetoric and oratory. Up to very recent times it was still possible to reckon as the most ancient works in Italian prose the *Cronaca* of Matteo Spinello da Giovenazzo, and the *Cronaca* of Ricordano Malespini. But now both of them have been shown to be forgeries of a much later time. Therefore the oldest prose writing is a scientific book—the *Composizione del Mondo* by Ristoro d'Arezzo, who lived about the middle of the 13th century. This work is a copious treatise on astronomy and geography. Ristoro was superior to the other writers of the time on these subjects, because he seems to have been a careful observer of natural phenomena, and consequently many of the things he relates were the result of his personal investigations. There is also another short treatise, *De Regimine Rectoris*, by Fra Paolino, a Minorite friar of Venice, who was probably bishop of Pozzuoli, and who also wrote a Latin chronicle. His treatise stands in close relation to that of Egidio Colonna, *De Regimine Principum*. It is written in the Venetian dialect.

The 13th century was very rich in tales. There is a collection called the *Cento Novelle Antiche* which contains stories drawn from Oriental, Greek, and Trojan traditions, from ancient and mediæval history, from the legends of Brittany, Provence, and Italy, and from the Bible, from the local tradition of Italy as well as from histories of animals and old mythology. This book has a distant resemblance to the Spanish collection known as *El Conde Lucanor*. The peculiarity of the Italian book is that the stories are very short, and that they seem to be mere outlines to be filled in by the narrator as he goes along. Other prose novels were inserted by Francesco Barberino in his work *Del Reggimento e dei Costumi delle Donne*, but they are of much less importance than the others. On the whole the Italian novels of the 13th century have little originality, and are only a faint reflexion of the very rich



legendary literature of France. Some attention should be paid to the *Lettere* of Fra Guittone d'Arezzo, who wrote many poems and also some letters in prose, the subjects of which are moral and religious. Love of antiquity, of the traditions of Rome and of its language, was so strong in Guittone that he tried to write Italian in a Latin style, and it turned out obscure, involved, and altogether barbarous. He took as his special model Seneca, and hence his prose assumed a bombastic style, which, according to his views, was very artistic, but which in fact was alien to the true spirit of art, and resulted in the extravagant and grotesque.

New  
Tuscan  
school  
of lyric  
poetry.

2. *The Spontaneous Development of Italian Literature.*—In the year 1282, the year in which the new Florentine constitution of the "Arti Minori" was completed, a period of literature began that does not belong to the age of first beginnings, but to that of development. With the school of Lapo Gianni, of Guido Cavalcanti, of Cino da Pistoia, and Dante Alighieri, lyric poetry became exclusively Tuscan. The whole novelty and poetic power of this school, which really was the beginning of Italian art, consist in what Dante expresses so happily—

"Quando  
Amore spira, noto, ed a quel modo  
Ch'ei detta dentro, vo significando—"

that is to say, in a power of expressing the feelings of the soul in the way in which love inspires them, in an appropriate and graceful manner, fitting form to matter, and by art fusing one with the other. The Tuscan lyric poetry, the first true Italian art, is pre-eminent in this artistic fusion, in the spontaneous and at the same time deliberate action of the mind. In Lapo Gianni the new style is not free from some admixture of the old associations of the Siculo-Provençal school. He wavered as it were between two manners. The empty and involved phraseology of the Sicilians is absent, but the poet does not always rid himself of their influence. Sometimes, however, he draws freely from his own heart, and then the subtleties and obscurities disappear, and his verse becomes clear, flowing, and elegant.

Guido  
Caval-  
canti.

Guido Cavalcanti was a learned man with a high conception of his art. He felt the value of it, and adapted his learning to it. Cavalcanti was already a good deal out of sympathy with the mediæval spirit; he reflected deeply on his own work, and from this reflexion he derived his poetical conception. His poems may be divided into two classes,—those which portray the philosopher, "il sottilissimo dialettico," as Lorenzo the Magnificent called him, and those which are more directly the product of his poetic nature imbued with mysticism and metaphysics. To the first set belongs the famous poem *Sulla Natura d'Amore*, which in fact is a treatise on amorous metaphysics, and was annotated later in a learned way by the most renowned Platonic philosophers of the 15th century, such as Marsilius Ficinus and others. In other poems of Cavalcanti's besides this, we see a tendency to subtilize and to stifle the poetic imagery under a dead weight of philosophy. But there are many of his sonnets in which the truth of the images and the elegance and simplicity of the style are admirable, and make us feel that we are in quite a new period of art. This is particularly felt in Cavalcanti's *Ballate*, for in them he pours himself out ingenuously and without affectation, but with an invariable and profound consciousness of his art. Far above all the others for the reality of the sorrow and the love displayed, for the melancholy longing expressed for the distant home, for the calm and solemn yearning of his heart for the lady of his love, for a deep subjectivity which is never troubled by metaphysical subtleties, is the ballata composed by Cavalcanti when he was banished from Florence with the party of the Bianchi in 1300, and took refuge at Sarzana.

The third poet among the followers of the new school was Cino da Pistoia, of the family of the Sinibaldi (see CINO DA PISTOIA). His love poems are so sweet, so mellow, and so musical that they are only surpassed by Dante. The pains of love are described by him with vigorous touches; it is easy to see that they are not feigned but real. The psychology of love and of sorrow nearly reaches perfection.

As the author of the *Vita Nuova*, Dante also belongs to the same lyric school. This is a little book of poetry and prose, which tells the story of his love for Beatrice, who is pretty generally held to be the daughter of Folco Portinari. In the lyrics of the *Vita Nuova* (so called by its author to indicate that his first meeting with Beatrice was the beginning for him of a life entirely different from that he had hitherto led) there is a high idealization of love! It seems as if there were in it nothing earthly or human, and that the poet had his eyes constantly fixed on heaven, while singing of his lady. Everything is supersensual, aerial, heavenly, and the real Beatrice is always gradually melting more and more into the symbolical one—passing out of her human nature and into the divine. The life of Dante covered a period of fifty-six years (1265–1321). In 1289 he fought at Campaldino against the Ghibellines of Arezzo. In 1300 he was probably one of the ambassadors from the Guelphs to Pope Boniface VIII. He was afterwards elected a prior, and it is believed that he took part in the measure for banishing the heads of the factions of the Bianchi and Neri which began that same year in Florence. The Neri betook themselves to Boniface, accusing their adversaries of an understanding with the Ghibellines. For the purpose of meeting these accusations, Dante went to Boniface, but in the meanwhile the latter sent Charles of Valois as a peacemaker, with secret injunctions to crush the Bianchi. Charles fulfilled this part of his mission with zeal. One of the proscribed was Dante, on the charge of illicit gains and of extortion during his priorate. Henceforth the poet's life was a perpetual pilgrimage from one Italian town to another. He was also at Paris in 1308. He hoped great things from the descent of Henry VII. of Luxembourg into Italy, and wrote to the people and princes to announce the coming of the day of redemption. He had hopes, too, of Ugucione della Faggiuola, leader of the Pisans against Florence (1315). But all his hopes proved vain, and he took refuge with Can Grande della Scala at Verona (1316), moving on later to Busone di Raffaelli at Gubbio (1318), to Vagano della Torre at Udine (1319), and to Guido Novello da Polenta at Ravenna (1320), where he died the next year.

It appears that Dante began the *Convito* in his youth, that he continued it in his exile, and never completed it. He named the book the *Convito*, to signify that a banquet of wisdom was served up in it. He meant to comment on fourteen of his songs, and the commentary was to be the promised serving up of the banquet. But he only composed four out of the fourteen treatises. As has been said by one of Dante's chief admirers in modern Italy, "it is a book of much learning, but the symbolism kills the poetry, and the quotations stifle the real knowledge." The *Convito* is very valuable as giving a notion of the mind of Dante and of his scholastic education. On the other hand, his treatise *De Monarchia* shows us his political conception. It was probably written in 1310, when the coming of Henry VII. revived such hopes in him. He meant to prove in it that a universal monarchy is necessary to the well-being of the world, that the Roman people had a right to claim the exercise of this office, that the authority of a monarch comes straight from God and not from his vicar, the pope. The *De Monarchia* is written in scholastic

Latin, and the treatment is scholastic. Another work of Dante's, also written in Latin, is the *De Vulgari Eloquio*. It seems that it was to have consisted of four books, but only two were written. His work is a defence of the "vulgare illustre" (the noble vulgar tongue) against the Italian dialects. Modern criticism regards it as very superficial.<sup>1</sup>

The work which made Dante immortal, and raised him above all the other men of genius in Italy, was his *Divina Commedia*. The author himself called it a "comedy," as he says in his letter to Can Grande della Scala, for two reasons,—because it has, like comedies, a sad beginning and a cheerful ending, and because it is written in a "middle" style, treating alike of lofty and of lowly things. Alighieri is the protagonist of the great drama. He represents himself as lost in a forest, in a night at the end of March and in the first days of April 1300, when he was thirty-five years old. At first he is much alarmed, but afterwards he is cheered when, at dawn, he finds himself at the foot of a hill. He wishes to ascend it, but three wild beasts prevent his doing so,—a panther, a lion, and a she-wolf. When he flees back in haste to the forest, Virgil appears to him, and tells him that he is sent by Beatrice, at the command of the "Gentle Lady" (Mary) and of St Lucy. He tells him that, in order to escape from the she-wolf, he must go through hell and purgatory with him, and afterwards Beatrice herself will lead him up to heaven. Dante's Inferno takes the shape of a deep valley, reaching down in constantly narrowing circles from the surface of our hemisphere, in the midst of which stands the mount of Jerusalem, to the centre of the earth. This valley, or inverted cone, is cut by nine circles, where the souls of the damned are tortured; they are divided into three principal classes, viz., the incontinent, the violent, and the fraudulent. The valley is shut in at its entrance by the river Acheron, and afterwards crossed by the Stygian marsh, and the rivers Phlegethon and Cocytus. The two poets pass through the ninth part of each circle, talking to some of the shades they meet, and at last they come to Lucifer, stationed in the centre of the earth. "Grasping at his hair," they pass the centre of gravity, and begin to ascend a narrow way which brings them to the other hemisphere. They reach a little island, whence rises a very high mountain, which is purgatory. It also is divided into nine circles: in the first two are the souls of those who deferred their repentance till the hour of death; in the others the shades are cleansing themselves from the seven deadly sins. Cato of Utica guards this place. The two poets ascend the mountain, going always to the right hand. On the summit they find the earthly paradise, which is the exact antipodes to the mountain of Jerusalem. Here appear a long train of venerable persons, who precede a chariot drawn by griffins. Beatrice makes her appearance, and with her Dante takes his flight through the nine heavens, where he sees the souls of the blessed according to the order of their desert. At the tenth heaven, the Empyrean, he sees them again all together, arranged in the shape of a gleaming rose round a most dazzling centre, which is God. Here the poet contemplates the mysteries of the Trinity and of the manhood of Christ. Then the vision comes to an end.

An allegorical meaning is hidden under the literal one of the *Commedia*. Dante, travelling through the invisible worlds, is a symbol of mankind aiming at the double object of temporal and eternal happiness. By the forest in which the poet loses himself is meant the civil and religious confusion of society, deprived of its two guides,

<sup>1</sup> See "Sal Trattato de Vulgari Eloquio," in the *Saggi Critici*, by Francesco d'Ovidio, Naples, 1879.

the emperor and the pope. The mountain illuminated by the sun is universal monarchy. The three beasts are the three vices and the three powers which offered the greatest obstacles to Dante's designs: envy is Florence, light, fickle, and divided by the Bianchi and Neri; pride is the house of France; avarice is the papal court; Virgil represents reason and the empire. Beatrice is the symbol of the supernatural aid without which man cannot attain the supreme end, which is God.

But the merit of the poem does not lie in the allegory, which still connects it with mediæval literature. What is new in it is the individual art of the poet, the classic art transfused for the first time into a Romance form. Dante is above all a great artist. Whether he describes nature, analyses passions, curses the vices, or sings hymns to the virtues, he is always wonderful for the grandeur and delicacy of his art. Out of the rude mediæval vision he has made the greatest work of art of modern times. He took the materials for his poem from theology, from philosophy, from history, from mythology,—but more especially from his own passions, from hatred and love; and he has breathed the breath of genius into all these materials. Under the pen of the poet, the dead come to life again; they become men again, and speak the language of their time, of their passions. Farinata degli Uberti, Boniface VIII., Count Ugolino, Manfred, Sordello, Hugh Capet, St Thomas Aquinas, Cacciaguida, St Benedict, St Peter, are all so many objective creations; they stand before us in all the life of their characters, their feelings, their habits.

Yet this world of fancy in which the poet moves is not only made living by the power of his genius, but it is changed by his consciousness. The real chastizer of the sins, the rewarder of the virtues, is Dante himself. The personal interest which he brings to bear on the historical representation of the three worlds is what most interests us and stirs us. Dante remakes history after his own passions. Thus the *Divina Commedia* can fairly be called, not only the most life-like drama of the thoughts and feelings that moved men at that time, but also the most clear and spontaneous reflexion of the individual feelings of the poet, from the indignation of the citizen and the exile to the faith of the believer and the ardour of the philosopher. The *Divina Commedia* fixed and clearly defined the destiny of Italian literature, to give artistic lustre, and hence immortality, to all the forms of literature which the Middle Ages had produced. Dante begins the great era of the Renaissance.

Two facts characterize the literary life of Petrarch (1304-1374),—classical research and the new human feeling introduced into his lyric poetry. Nor are these two facts separate; rather is the one the result of the other. The Petrarch who travelled about unearthing the works of the great Latin writers helps us to understand the Petrarch who, having completely detached himself from the Middle Ages, loved a real lady with a human love, and celebrated her in her life and after her death in poems full of studied elegance. Petrarch was the first humanist, and he was at the same time the first lyric poet of the modern school. His career was long and tempestuous. He lived for many years at Avignon, cursing the corruption of the papal court; he travelled through nearly the whole of Europe; he corresponded with emperors and popes; he was considered the first man of letters of his time; he had honours and riches; and he always bore about within him discontent, melancholy, and incapacity for satisfaction,—three characteristics of the modern man.

He wrote many Latin works, the most important of which are the *Epistole* and the poem entitled *Africa*. He was the first to have a style of his own, and to attempt to revive the art of the Latin authors. He specially studied



Cicero, and endeavoured to copy him. Perhaps there was a sort of affinity between their characters. The *Epistole* are of very great importance for the study of Petrarch's life and mind, as well as for the history of his times. *Africa* is a long poem in hexameters on the campaigns of Scipio, which in places shows the gleam of genius. In the *Itinerarium Syriacum*, and in another work that is now lost,<sup>1</sup> Petrarch appears as the first geographer of modern times.

It is not very certain who was the lady loved by Petrarch. There are some reasons for believing that she was called Laura De Noves, and was the wife of Ugo de Sade, but this is very far from being proved. It appears anyhow that the lady lived at Avignon.

The *Canzoniere* is divided into three parts,—the first containing the poems written during Laura's lifetime, the second the poems written after her death, the third the *Trionfi*. The one and only subject of these poems is love; but the treatment is full of variety in conception, imagery, and in sentiment, derived from the most varied impressions of nature. Petrarch's love is real and deep, and to this is due the merit of his lyric verse, which is quite different, not only from that of the Provençal troubadours and of the Italian poets before him, but also from the lyrics of Dante. Petrarch is a psychological poet, who dives down into his own soul, examines all his feelings, and knows how to render them with an art of exquisite sweetness. The lyrics of Petrarch are no longer transcendental like Dante's; but on the contrary keep entirely within human limits. In struggles, in doubts, in fears, in disappointments, in griefs, in joys, in fact in everything, the poet finds material for his poetry. The second part of the *Canzoniere* is the more passionate. The *Trionfi* are inferior; it is clear that in them Petrarch tried to imitate the *Divina Commedia*, but never came near it.

The *Canzoniere* includes also a few political poems,—a canzone to Italy, one supposed to be addressed to Cola di Rienzi, and several sonnets against the court of Avignon. These are remarkable for their vigour of feeling, and also for showing that Petrarch had formed the idea of *Italianità* better even than Alighieri. The Italy which he loved was different from any conceived by the men of the Middle Ages, and in this also he was a precursor of modern times and of modern aspirations. Petrarch had no decided political idea. He exalted Cola di Rienzi, invoked the emperor Charles IV., praised the Visconti; in fact, his politics were affected more by impressions than by principles; but above all this reigned constantly the love of Italy, his ancient and glorious country, which in his mind is reunited with Rome, the great city of his heroes Cicero and Scipio.

**Boccaccio.** Boccaccio (1313-1375) had the same enthusiastic love of antiquity and the same worship for the new Italian literature as Petrarch. He was the first, with the help of a Greek born in Calabria, to put together a Latin translation of the *Iliad* and the *Odyssey*. His vast classical learning was shown specially in the work *De Genealogia Deorum*, in which he enumerates the gods according to genealogical trees constructed on the authority of the various authors who wrote about the pagan divinities. This work marked an era in studies preparatory to the revival of classical learning. And at the same time it opened the way for the modern criticism, because Boccaccio in his researches and in his own judgment was always independent of the authors whom he most esteemed. The *Genealogia Deorum* is, as Heeren said, an encyclopædia of mythological knowledge; and it was the precursor of the great humanistic movement which was developed in the 15th century. Boccaccio was also the first historian of

women in his *De Claris Mulieribus*, and the first to undertake to tell the story of the great unfortunate in his *De Casibus Virorum Illustrium*. He continued and perfected former geographical investigations in his interesting book *De Montibus, Silvis, Fontibus, Lacubus, Fluminibus, Stagnis, et Paludibus, et de Nominibus Maris*, for which he made use of Vibius Sequester, but which contains also many new and valuable observations. He also wrote in Latin several eclogues, some letters, and other minor compositions. Of his Italian works his lyrics do not come anywhere near to the perfection of Petrarch's. His sonnets, mostly about love, are quite mediocre. His narrative poetry is better. Although now he can no longer claim the distinction long conceded to him of having invented the octave stanza (which afterwards became the metre of the poems of Boiardo, of Ariosto, and of Tasso), yet he was certainly the first to use it in a work of some length and written with artistic skill, such as is his *Teseide*. This is a poem in twelve books, and the subject is the love of two Theban youths, Arcita and Palemone, for Emilia, one of the Amazons. We find in it great luxury of description, inflated speeches, much erudition, but little poetry. However, the *Teseide* is the oldest Italian romantic poem. The *Filostrato* relates the loves of Troilo and Griseida (Troilus and Cressida). It may be that Boccaccio knew the French poem of the Trojan war by Benoît de Sainte-More; but the interest of the Italian work lies in the analysis of the passion of love, which is treated with a masterly hand. The *Ninfale Fiesolano* tells the love story of the nymph Nesola and the shepherd Africo. The *Amorosa Visione*, a poem in triplets, doubtless owed its origin to the *Divina Commedia*. The *Ameto* is a mixture of prose and poetry, and is the first Italian pastoral romance.

The *Filocolo* takes the earliest place among prose romances. In it Boccaccio tells in a laborious style, and in the most prolix way, the loves of Florio and Biancafiore. Probably for this work he drew materials from a popular source or from a Byzantine romance, which Leonzio Pilato may have mentioned to him. In the *Filocolo* there is a remarkable exuberance in the mythological part, which damages the romance as an artistic work, but which contributes to the history of Boccaccio's mind. The *Fiammetta* is another romance, about the loves of Boccaccio and Maria d'Aquino, a supposed natural daughter of King Robert, whom he always called by this name of Fiammetta.

The Italian work which principally made Boccaccio famous was the *Decamerone*, a collection of a hundred novels, related by a party of men and women, who had retired to a villa near Florence to escape from the plague in 1348. Novel-writing, so abundant in the preceding centuries, especially in France, now for the first time assumed an artistic shape. The style of Boccaccio tends to the imitation of Latin, but in him prose first took the form of elaborated art. The rudeness of the old *fabliaux* gives place to the careful and conscientious work of a mind that has a feeling for what is beautiful, that has studied the classic authors, and that strives to imitate them as much as possible. Over and above this, in the *Decamerone*, Boccaccio is a delineator of character and an observer of passions. In this lies his novelty. Much has been written about the sources of the novels of the *Decamerone*. Probably Boccaccio made use both of written and of oral sources. Popular tradition must have furnished him with the materials of many stories, as, for example, that of Griselda.

Unlike Petrarch, who was always discontented, preoccupied, wearied with life, disturbed by disappointments, we find Boccaccio calm, serene, satisfied with himself and with his surroundings. Notwithstanding these funda-

<sup>1</sup> See Hortis, *Studi sulle Opere Latine del Boccaccio*, Trieste, 1879, pp. 235, 236.

mental differences in their characters, the two great authors were old and warm friends. But their affection for Dante was not equal. Petrarch, who says that he saw him once in his childhood, did not preserve a pleasant recollection of him, and it would be useless to deny that he was jealous of his renown. The *Divina Commedia* was sent him by Boccaccio, when he was an old man, and he confessed that he never read it. On the other hand, Boccaccio felt for Dante something more than love—enthusiasm. He wrote a biography of him, of which the accuracy is now unfairly depreciated by some critics, and he gave public critical lectures on the poem in Santa Maria del Fiore at Florence.

Fazio degli Uberti and Federigo Frezzi were imitators of the *Divina Commedia*, but only in its external form. The former wrote the *Dittamondo*, a long poem, in which the author supposes that he was taken by the geographer Solinus into different parts of the world, and that his guide related the history of them. The legends of the rise of the different Italian cities have some importance historically. Frezzi, bishop of his native town Foligno, wrote the *Quadragesimo*, a poem of the four kingdoms—Love, Satan, the Vices, and the Virtues. This poem has many points of resemblance with the *Divina Commedia*. Frezzi pictures the condition of man who rises from a state of vice to one of virtue, and describes hell, the limbo, purgatory, and heaven. The poet has Pallas for a companion.

Minor novelists. Ser Giovanni Fiorentino wrote, under the title of *Peorone*, a collection of tales, which are supposed to have been related by a monk and a nun in the parloir of the monastery of Forl. He closely imitated Boccaccio, and drew on Villani's chronicle for his historical stories. Franco Sacchetti wrote tales too, for the most part on subjects taken from Florentine history. His book gives a life-like picture of Florentine society at the end of the 14th century. The subjects are almost always improper; but it is evident that Sacchetti collected all these anecdotes in order to draw from them his own conclusions and moral reflexions, which are to be found at the end of every story. From this point of view Sacchetti's work comes near to the *Moralisations* of the Middle Ages. A third novelist was Giovanni Sercambi of Lucca, who after 1374 wrote a book, in imitation of Boccaccio, about a party of people who were supposed to fly from a plague and to go travelling about in different Italian cities, stopping here and there telling stories.

Historians. It has already been said that the chronicles formerly believed to have been of the 13th century are now regarded as forgeries of later times. At the end of the 13th century, however, we find a chronicle by Dino Compagni, which, notwithstanding the unfavourable opinion of it entertained especially by some German writers, is in all probability authentic. Little is known about the life of Compagni. Noble by birth, he was democratic in feeling, and was a supporter of the new ordinances of Giano della Bella. As prior and gonfalonier of justice he always had the public welfare at heart. When Charles of Valois, the nominee of Boniface VIII., was expected in Florence, Compagni, foreseeing the evils of civil discord, assembled a number of citizens in the church of San Giovanni, and tried to quiet their excited spirits. His chronicle relates the events that came under his own notice from 1280 to 1312. It bears the stamp of a strong subjectivity. The narrative is constantly personal. It often rises to the finest dramatic style. A strong patriotic feeling and an exalted desire for what is right pervade the book. Compagni is more an historian than a chronicler, because he looks for the reasons of events, and makes profound reflexions on them. According to our judgment he is one of the most important authorities for that period of Florentine history, notwithstanding the not insignificant mistakes in fact which are to be found in his

writings. On the contrary, Giovanni Villani, born in 1300, was more of a chronicler than an historian. He relates the events up to 1347. The journeys that he made in Italy and France, and the information thus acquired, account for the fact that his chronicle, called by him *Istorie Fiorentine*, comprises events that occurred all over Europe. What specially distinguishes the work of Villani is that he speaks at length, not only of events in politics and war, but also of the stipends of public officials, of the sums of money used for paying soldiers and for public festivals, and of many other things of which the knowledge is very valuable. With such an abundance of information it is not to be wondered at that Villani's narrative is often encumbered with fables and errors, particularly when he speaks of things that happened before his own time. Matteo was the brother of Giovanni Villani, and continued the chronicle up to 1363. It was again continued by Filippo Villani. Gino Capponi, author of the *Commentari dell' Acquisto di Pisa* and of the narration of the *Tumulto dei Ciompi*, belonged to both the 14th and the 15th centuries.

The *Divina Commedia* is ascetic in its conception, and in a good many points of its execution. To a large extent similar is the genius of Petrarch; yet neither Petrarch nor Dante could be classified among the pure ascetics of their time. But many other writers come under this head. St Catherine of Siena's mysticism was political. She was a really extraordinary woman, who aspired to bring back the Church of Rome to evangelical virtue, and who has left a collection of letters written in a high and lofty tone to all kinds of people, including popes. She joins hands on the one side with Jacopone of Todi, on the other with Savonarola. Hers is the strongest, clearest, most exalted religious utterance that made itself heard in Italy in the 14th century. It is not to be thought that precise ideas of reformation entered into her head, but the want of a great moral reform was felt in her heart. And she spoke indeed *ex abundantia cordis*. Anyhow the daughter of Jacopo Benincasa must take her place among those who from afar off prepared the way for the religious movement which took effect, especially in Germany and England, in the 16th century.

Another Siennese, Giovanni Colombini, founder of the order of Jesuati, preached poverty by precept and example, going back to the religious idea of St Francis of Assisi. His letters are among the most remarkable in the category of ascetic works in the 14th century. Passavanti, in his *Specchio della vera Penitenza*, attached instruction to narrative. Cavalea translated from the Latin the *Vite dei Santi Padri*. Rivalta left behind him many sermons, and Franco Sacchetti (the famous novelist) many discourses. On the whole, there is no doubt that one of the most important productions of the Italian spirit of the 14th century was the religious literature.

In direct antithesis with this is a kind of literature which has a strong popular element. Humorous poetry, the poetry of laughter and jest, which as we saw was largely developed in the 13th century, was carried on in the 14th by Bindo Bonichi, Arrigo di Castruccio, Cecco Nuccoli, Andrea Orgagna, Filippo de' Bardi, Adriano de' Rossi, Antonio Pucci, and other lesser writers. Orgagna was specially comic; Bonichi was comic with a satirical and moral purpose. Antonio Pucci was superior to all of them for the variety of his production. He put into triplets the chronicle of Giovanni Villani (*Centiloquio*), and wrote many historical poems called *Serventesi*, many comic poems, and not a few epico-popular compositions on various subjects. A little poem of his in seven cantos treats of the war between the Florentines and the Pisans from 1362 to 1365. Other poems drawn from a legendary source celebrate the *Reina d'Oriente*, *Apollonio di Tiro*, the *Bel Gherardino*, &c. These poems, meant to be recited to the



people, are the remote ancestors of the romantic epic, which was developed in the 16th century, and the first representatives of which were Boiardo and Ariosto.

Political  
and  
satirical  
poetry.

Many poets of the 14th century have left us political works. Of these Fazio degli Uberti, the author of *Dittamondo*, who wrote a *Serventese* to the lords and people of Italy, a poem on Rome, a fierce invective against Charles IV. of Luxemburg, deserves notice, and Francesco di Vanzo, Frate Stoppa, and Matteo Frescobaldi. It may be said in general that following the example of Petrarch many writers devoted themselves to patriotic poetry. \* From this period also dates that literary phenomenon known under the name of Petrarchism. The Petrarchists, or those who sang of love, imitating Petrarch's manner, were found already in the 14th century. But others treated the same subject with more originality, in a manner that might be called semi-popular. Such were the *Ballate* of Ser Giovanni Fiorentino, of Franco Sacchetti, of Niccolò Soldanieri, of Guido and Bindo Donati. Ballate were poems sung to dancing, and we have very many songs for music of the 14th century. We have already stated that Antonio Pucci versified Villani's *Chronicle*. This instance of versified history is not unique, and it is evidently connected with the precisely similar phenomenon offered by the "vulgar Latin" literature. It is enough to notice a chronicle of Arezzo in terza rima by Goro de' Sinigardi, and the history, also in terza rima, of the journey of Pope Alexander III. to Venice by Pier de' Natali. Besides this, every kind of subject, whether history, tragedy, or husbandry, was treated in verse. Neri di Landocio wrote a life of St Catherine; Jacopo Gradenigo put the gospels into triplets; Paganino Bouafede in the *Tesoro dei Rustici* gave many precepts in agriculture, beginning that kind of Georgic poetry which was fully developed later by Alamanni in his *Coltivazione*, by Girolamo Baruffaldi in the *Canapaio*, by Rucellai in the *Api*, by Bartolommeo Lorenzi in the *Coltivazione dei Monti*, by Giambattista Spolverini in the *Coltivazione del Riso*, &c.

Histories  
in verse.

Drama.

There cannot have been an entire absence of dramatic literature in Italy in the 14th century, but traces of it are wanting, although we find them again in great abundance in the 15th century. The 14th century had, however, one drama unique of its kind. In the sixty years (1250 to 1310) which ran from the death of the emperor Frederick II. to the expedition of Henry VII., no emperor had come into Italy. In the north of Italy, Ezzelino da Romano, with the title of imperial vicar, had taken possession of almost the whole of the March of Treviso, and threatened Lombardy. The popes proclaimed a crusade against him, and, crushed by it, the Ezzelini fell. Padua then began to breathe again, and took to extending its dominion. There was living at Padua Albertino Mussato, born in 1261, a year after the catastrophe of the Ezzelini; he grew up among the survivors of a generation that hated the name of the tyrant. After having written in Latin a history of Henry VII., he devoted himself to a dramatic work on Ezzelino, and wrote it also in Latin. The *Eccerinus*, which was probably never represented on the stage, has been by some critics compared to the great tragic works of Greece. It would probably be nearer the truth to say that it has nothing in common with the works of Æschylus; but certainly the dramatic strength, the delineation of certain situations, and the narration of certain events are very original. Mussato's work stands alone in the history of Italian dramatic literature. Perhaps this would not have been the case if he had written it in Italian.

In the last years of the 14th century we find the struggle that was soon to break out between the indigenous literary tradition and the reviving classicism already alive in spirit. As representatives of this struggle, of this

antagonism, we may consider Luigi Marsilio and Coluccio Salutati, both learned men who spoke and wrote Latin, who aspired to be humanists, but who meanwhile also loved Dante, Petrarch, and Boccaccio, and felt and celebrated in their writings the beauty of Italian literature.

3. *The Renaissance*.—A great intellectual movement, which had been gathering for a long time, made itself felt in Italy in the 15th century. A number of men arose, all learned, laborious, indefatigable, and all intent on one great work. Such were Niccolò Niccoli, Giannozzo Manetti, Palla Strozzi, Leonardo Bruni, Francesco Filelfo, Poggio Bracciolini, Carlo d'Arezzo, Lorenzo Valla. Manetti buried himself in his books, slept only for a few hours in the night, never went out of doors, and spent his time in translating from Greek, studying Hebrew, and commenting on Aristotle. Palla Strozzi sent into Greece at his own expense to search for ancient books, and had Plutarch and Plato brought for him. Poggio Bracciolini went to the council of Constance, and found in a monastery in the dust-hole Cicero's *Orations*. He copied Quintilian with his own hand, discovered Lucretius, Plautus, Pliny, and many other Latin authors. Guarino went through the East in search of codices. Giovanni Aurispa returned to Venice with many hundreds of manuscripts. What was the passion that excited all these men? What did they search after? What did they look to? These Italians were but handing on the solemn tradition which, although partly latent, was the informing principle of Italian mediæval history, and now at length came out triumphant. This tradition was that same tenacious and sacred memory of Rome, that same worship of its language and institutions, which at one time had retarded the development of Italian literature, and now grafted the old Latin branch of ancient classicism on the flourishing stock of Italian literature. All this is but the continuation of a phenomenon that has existed for ages. \* It is the thought of Rome that always dominates Italians, the thought that keeps appearing from Boetius to Dante Alighieri, from Arnold of Brescia to Cola di Rienzi, which gathers strength with Petrarch and Boccaccio, and finally becomes triumphant in literature and life,—in life, because the modern spirit is fed on the works of the ancients. Men come to have a more just idea of nature: the world is no longer cursed or despised; truth and beauty join hands; man is born again; and human reason resumes its rights. Everything, the individual and society, are changed under the influence of new facts.

First of all there was formed a human individuality, which was wanting in the Middle Ages. As Burckhardt has said, the man was changed into the individual. He began to feel and assert his own personality, which was constantly attaining a fuller realization. As a consequence of this, the idea of fame and the desire for it arose. A really cultured class was formed, in the modern meaning of the word, and the conception was arrived at (completely unknown in former times) that the worth of a man did not depend at all on his birth but on his personal qualities. Poggio in his dialogue *De Nobilitate* declares that he entirely agreed with his interlocutors Niccolò Niccoli and Lorenzo de' Medici in the opinion that there is no other nobility but that of personal merit. \* External life was growing more refined in all particulars; the man of society was created; rules for civilized life were made; there was an increasing desire for sumptuous and artistic entertainments. The mediæval idea of existence was turned upside down: men who had hitherto turned their thoughts exclusively to heavenly things, and believed exclusively in the divine right, now began to think of beautifying their earthly existence, of making it happy and gay, and returned to a belief in their human rights. \* This was a great

Græco-Latin  
learning.

New  
social  
condi-  
tions.

advance, but one which carried with it the seeds of many dangers. The conception of morality became gradually weaker. The "fay ce que vouldras" of Rabelais became the first principle of life. Religious feeling was blunted, was weakened, was changed, became pagan again. Finally the Italian of the Renaissance, in his qualities and his passions, became the most remarkable representative of the heights and depths, of the virtues and faults, of humanity. Corruption was associated with all that is most ideal in life; a profound scepticism took hold of people's minds; indifference to good and evil reached its highest point.

Besides this, a great literary danger was hanging over Italy. Humanism threatened to submerge its youthful national literature. There were authors who laboriously tried to give Italian Latin forms, to do again, after Dante's time, what Guittone d'Arezzo had so unhappily done in the 13th century. Provincial dialects tried to reassert themselves in literature. The great authors of the 14th century, Dante, Petrarck, Boccaccio, were by many people forgotten or despised.

It was Florence that saved literature by reconciling the classical models to modern feeling, Florence that succeeded in assimilating classical forms to the "vulgar" art. Still gathering vigour and elegance from classicism, still drawing from the ancient fountains all that they could supply of good and useful, it was able to preserve its real life, to keep its national traditions, and to guide literature along the way that had been opened to it by the writers of the preceding century. At Florence the most celebrated humanists wrote also in the vulgar tongue, and commented on Dante and Petrarck, and defended them from their enemies. Leon Battista Alberti, the learned Greek and Latin scholar, wrote in the vernacular, and Vespasiano da Bisticci, whilst he was constantly absorbed in Greek and Latin manuscripts, wrote the *Vite di Comini Illustri*, valuable for their historical contents, and rivalling the best works of the 14th century in their candour and simplicity. Andrea da Barberino wrote the beautiful prose of the *Reali di Francia*, giving a colouring of "romanità" to the chivalrous romances. Belcari and Benivieni carry us back to the mystic idealism of earlier times.

But it is in Lorenzo de' Medici that the influence of Florence on the Renaissance is particularly seen. In forming an opinion of him many people are led away by political preconceptions. Even as a statesman, Lorenzo has a conspicuous place in the history of his time, and in our day it will not be deemed reasonable to expect that in the age of lordships and principalities he alone should stand out from his time, and not feel the influence of the general condition of Italy. With this, however, we have nothing to do. We have to consider Lorenzo de' Medici as a man of letters; and as such he is one about whom tradition and reality best agree. His mind was formed by the ancients: he attended the class of the Greek Argyropoulos, sat at Platonic banquets, took pains to collect codices, sculptures, vases, pictures, gems, and drawings to ornament the gardens of San Marco and to form the library afterwards called by his name. In the saloons of his Florentine palace, in his villas at Careggi, Fiesole, and Ambrà, stood the wonderful chests painted by Dello with stories from Ovid, the Hercules of Pollajuolo, the Pallas of Botticelli, the works of Filippino and Verrocchio. Lorenzo de' Medici lived entirely in the classical world; and yet if we read his poems we only see the man of his time, the admirer of Dante and of the old Tuscan poets, who takes inspiration from the popular muse, and who succeeds in giving to his poetry the colours of the most pronounced realism, as well as of the loftiest idealism,—who passes from the Platonic sonnet to the impassioned triplets of the *Amori di Venere*, from the grandiosity of the *Salve to Nencia* and to *Beoni*, from the

*Canto Carnascialesco* to the *Lauda*. The feeling of nature is strong in him,—at one time sweet and melancholy, at another vigorous and deep, as if an echo of the feelings, the sorrows, the ambitions of that deeply agitated life. He liked to look into his own heart with a severe eye, but he was also able to pour himself out with tumultuous fulness. He described with the art of a sculptor; he satirized, laughed, prayed, sighed, always elegant, always a Florentine, but a Florentine who read Anacreon, Ovid, and Tibullus, who wished to enjoy life, but also to taste of the refinements of art.

Next to Lorenzo comes Poliziano, who also united, and with greater art, the ancient and the modern, the popular and the classical style. In his *Rispetti* and in his *Ballate* the freshness of imagery and the plasticity of form are inimitable. He, a great Greek scholar, wrote Italian verses with dazzling colours; the purest elegance of the Greek sources pervaded his art in all its varieties, in the *Orfeo* as well as the *Stanze per la Giostra*.

As a consequence of the intellectual movement towards the Renaissance, there arose in Italy in the 15th century three academies, those of Florence, of Naples, and of Rome. The Florentine academy was founded by Cosmo I. de' Medici. Having heard the praises of Platonic philosophy sung by Gemistus Pletho, who in 1439 was at the council of Florence, he took such a liking for those opinions that he soon made a plan for a literary congress which was especially to discuss them. Marsilius Ficinus has described the occupations and the entertainments of these academicians. Here, he said, the young men learnt, by way of pastime, precepts of conduct and the practice of eloquence; here grown-up men studied the government of the republic and the family; here the aged consoled themselves with the belief in a future world. The academy was divided into three classes:—that of patrons, who were members of the Medici family; that of hearers, among whom sat the most famous men of that age, such as Pico della Mirandola, Angelo Poliziano, Leon Battista Alberti; that of disciples, who were youths anxious to distinguish themselves in philosophical pursuits. It is known that the Platonic academy endeavoured to promote, with regard to art, a second and a more exalted revival of antiquity. The Roman academy was founded by Giulio Pomponio Leto, with the object of promoting the discovery and the investigation of ancient monuments and books. It was a sort of religion of classicism, mixed with learning and philosophy. Platina, the celebrated author of the lives of the first hundred popes, belonged to it. At Naples, the academy known as the Pontaniana was instituted. The founder of it was Antonio Beccadelli, surnamed Il Panormita, and after his death the head was Il Pontano, who gave his name to it, and whose mind animated it.

Romantic poems were the product of the moral scepticism and the artistic taste of the 15th century. Italy never had any true epic poetry in its period of literary birth. Still less could it have any in the Renaissance. It had, however, many poems called *Cantàri*, because they contained stories that were sung to the people; and besides there were romantic poems, such as the *Buovo d'Antona*, the *Regina Ancoja*, and others. But the first to introduce elegance and a new life into this style was Luigi Pulci, who grew up in the house of the Medici, and who wrote the *Morgante Maggiore* at the request of Lucrezia Tornabuoni, mother of Lorenzo the Magnificent. The material of the *Morgante* is almost completely taken from an obscure chivalrous poem of the 15th century recently discovered by Professor Pio Rajna. On this foundation Pulci erected a structure of his own, often turning the subject into ridicule, burlesquing the characters, introducing many digressions, now capricious, now scientific, now theological. Pulci's merit consists in having been the first to

Literary dangers of Latinism.

Influence of Florence.

Lorenzo de' Medici.

Poliziano.

The academies.

Romantic poetry.



raise the romantic epic which had been for two centuries in the hands of story-tellers into a work of art, and in having united the serious and the comic, thus happily depicting the manners and feelings of the time. With a more serious intention Matteo Boiardo, count of Scandiano, wrote his *Orlando innamorato*, in which he seems to have aspired to embrace the whole range of Carolingian legends; but he did not complete his task. We find here too a large vein of humour and burlesque. Still the Ferrarese poet is drawn to the world of romance by a profound sympathy for chivalrous manners and feelings,—that is to say, for love, courtesy, valour, and generosity. A third romantic poem of the 15th century was the *Mambriano* by Francesco Bello (Cieco of Ferrara). He drew from the Carolingian cycle, from the romances of the Round Table, from classical antiquity. He was a poet of no common genius, and of ready imagination. He showed the influence of Boiardo, especially in something of the fantastic which he introduced into his work.

**Drama.** The development of the drama in the 15th century was very great. This kind of semi-popular literature was born in Florence, and attached itself to certain popular festivities that were usually held in honour of St John the Baptist, patron saint of the city. The *Sacra Rappresentazione* is in substance nothing more than the development of the mediæval *Mistero* ("mystery-play"). Although it belonged to popular poetry, some of its authors were literary men of much renown. It is enough to notice Lorenzo de' Medici, who wrote *San Giovanni e Paolo*, and Feo Belcari, author of the *San Panunzio*, the *Abramo ed Isaac*, &c. From the 15th century, some element of the comic-profane found its way into the *Sacra Rappresentazione*. From its Biblical and legendary conventionalism Poliziano emancipated himself in his *Orfeo*, which, although in its exterior form belonging to the sacred representations, yet substantially detaches itself from them in its contents and in the artistic element introduced.

**Pastoral poetry.** From Petrarch onwards the eclogue was a kind of literature that much pleased the Italians. In it, however, the pastoral element is only apparent, for there is nothing really rural in it. Such is the *Arcadia* of Jacopo Sannazzaro of Naples, author of a wearisome Latin poem *De Partu Virginis*, and of some piscatorial eclogues. The *Arcadia* is divided into ten eclogues, in which the festivities, the games, the sacrifices, the manners of a colony of shepherds are described. They are written in elegant verses, but it would be vain to look in them for the remotest feeling of country life. On the other hand, even in this style, Lorenzo de' Medici was superior. His *Nencia da Barberino*, as a modern writer says, is as it were the new and clear reproduction of the popular songs of the environs of Florence, melted into one majestic wave of octave stanzas. Lorenzo threw himself into the spirit of the bare realism of country life. There is a marked contrast between this work and the conventional bucolic of Sannazzaro and other writers. A rival of the Medici in this style, but always inferior to him, was Luigi Pulci in his *Beca da Dicomano*.

**Lyric poetry.** The lyric love poetry of this century was unimportant. In its stead we see a completely new style arise, the *Canto Carnascialesco*. These were a kind of choral songs, which were accompanied with symbolical masquerades, common in Florence at the carnival. They were written in a metre like that of the ballade; and for the most part they were put into the mouth of a party of workmen and tradesmen, who, with not very chaste allusions, sang the praises of their art. These triumphs and masquerades were directed by Lorenzo himself. At eventide there set out into the city large companies on horseback, playing and singing these songs. There are some by Lorenzo himself, which surpass

all the others in their mastery of art. That entitled *Bacco ed Arianna* is the most famous.

Girolamo Savonarola arose to fight against the literary and social movement of the Renaissance. He was a Ferrarese friar, born in 1452, and he came to Florence in 1489. Some have tried to make out that Savonarola was an apostle of liberty, others that he was a precursor of the Reformation. In truth, however, he was neither the one nor the other. In his struggle with Lorenzo de' Medici, he directed his attack against the promoter of classical studies, the patron of pagan literature, rather than against the political tyrant. Animated by mystic zeal, he took the line of a prophet, preaching against reading voluptuous authors, against the tyranny of the Medici, and calling for popular government. This, however, was not done from a desire for civil liberty, but because Savonarola saw in Lorenzo and his court the greatest obstacle to that return to Catholic doctrine which was his heart's desire; while he thought this return would be easily accomplished if, on the fall of the Medici, the Florentine republic should come into the hands of his supporters. There may be more justice in looking on Savonarola as the forerunner of the Reformation. If he was so, it was more than he intended. The friar of Ferrara never thought of attacking the papal dogma, and always maintained that he wished to remain within the church of Rome. He had none of the great aspirations of Luther. He only repeated the complaints and the exhortations of St Catherine of Siena; he desired a reform of manners, entirely of manners, not of doctrine. He prepared the ground for the German and English religious movement of the 16th century, but unconsciously. In the history of Italian civilization he represents retrogression, that is to say, the cancelling of the great fact of the Renaissance, and return to mediæval ideas. His attempt to put himself in opposition to his time, to arrest the course of events, to bring the people back to the faith of the past, the belief that all the social evils came from a Medici and a Borgia, his not seeing the historical reality as it was, his aspiring to found a republic with Jesus Christ for its king,—all these things show that Savonarola was more of a fanatic than a thinker. Nor has he any great merit as a writer. He wrote Italian sermons, hymns (laudi), ascetic and political treatises, but they are roughly executed, and only important as throwing light on the history of his ideas. The religious poems of Girolamo Benivieni are better than his, and are drawn from the same inspirations. In these lyrics, sometimes sweet, always warm with religious feeling, Benivieni and with him Feo Belcari carry us back to the literature of the 14th century.

History had neither many nor very good students in the 15th century. Its revival belonged to the following age. It was mostly written in Latin. Leonardo Bruni of Arezzo wrote the history of Florence, Gioviano Pontano that of Naples, in Latin. Bernardino Corio wrote the history of Milan in Italian, but in a rude way.

Leonardo da Vinci wrote a treatise on painting, Leon Battista Alberti one on sculpture and architecture. But the names of these two men are important, not so much as authors of these treatises, but as being embodiments of another characteristic of the age of the Renaissance,— versatility of genius, power of application along many and varied lines, and of being excellent in all. Leonardo was an architect, a poet, a painter, an hydraulic engineer, and a distinguished mathematician. Alberti was a musician, studied jurisprudence, was an architect and a draughtsman, and had great fame in literature. He had a deep feeling for nature, an almost unique faculty of assimilating all that he saw and heard. Leonardo and Alberti are representatives and almost a compendium in themselves of all that intellectual vigour of the Renaissance age, which in the

Religious  
reaction.  
Savonar-  
ola.

Historia,  
&c.

16th century took to developing itself in its individual parts, making way for what has by some been called the golden age of Italian literature.

Develop-  
ment of  
the Re-  
naissance.

4. *Development of the Renaissance.*—The fundamental characteristic of the literary epoch following that of the Renaissance is that it perfected itself in every kind of art, in particular uniting the essentially Italian character of its language with classicism of style. This period lasted from about 1494 to about 1550; and, strange to say, this very period of greater fruitfulness and literary greatness began from the year 1494, which with Charles VIII.'s descent into Italy marked the beginning of its political decadence and of foreign domination over it. But this is not hard to explain. All the most famous men of the first half of the 16th had been educated in the preceding century. Pietro Pomponazzo was born in 1462, Marcello Virgilio Adriani in 1464, Castiglione in 1468, Machiavelli in 1469, Bembo in 1470, Michelangelo Buonarroti in 1475, Ariosto in 1474, Nardi in 1476, Trissino in 1478, Guicciardini in 1482. Thus it is easy to understand how the literary activity which showed itself from the end of the 15th century to the middle of the following one was the product of the political and social conditions of the age in which these minds were formed, not of that in which their powers were displayed.

History.

Niccolò Machiavelli and Francesco Guicciardini were the chief originators of the science of history. Machiavelli's principal works are the *Istorie Fiorentine*, the *Discorsi sulla prima Deca di Tito Livio*, the *Arte della Guerra*, and the *Principe*. His merit consists in having been the creator of the experimental science of politics,—in having observed facts, studied histories, and drawn consequences from them. His history is sometimes inexact in facts; it is rather a political than an historical work. The peculiarity of Machiavelli's genius lay, as has been said, in his artistic feeling for the treatment and discussion of politics in and for themselves, without regard to an immediate end,—in his power of abstracting himself from the partial appearances of the transitory present, in order more thoroughly to possess himself of the eternal and inborn kingdom, and to bring it into subjection to himself. His *Principe* has been the subject of the severest accusations. But now, especially since Macaulay's essay, it is clear to every one that this book was only the result of the civil and moral conditions of Italy, as it still is the faithful portrait of them.<sup>1</sup>

Next to Machiavelli both as an historian and a statesman, comes Francesco Guicciardini. He taught law for many years at Florence; then, having devoted himself to politics, he was always in the service of the Medici. Leo X. made him governor of Modena, Reggio, and Parma. Clement VII. gave him the appointment of president of the Romagna, and afterwards that of lieutenant-general of the army against Charles V., and finally that of governor of Bologna. He worked for the return of the Medici to Florence, defending Duke Alexander from the accusations of the exiles and supporting the election of Cosmo I. Guicciardini was very observant, and endeavoured to reduce his observations to a science. His *Storia d'Italia*, which extends from the death of Lorenzo de' Medici to 1534, is full of political wisdom, is skilfully arranged in its parts, gives a lively picture of the character of the persons it treats of, and is written in a grand style. He shows a profound knowledge of the human heart, and depicts with truth the temperaments, the capabilities, and

the habits of the different European nations. Going back to the causes of events, he looked for the explanation of the divergent interests of princes and of their reciprocal jealousies. The fact of his having witnessed many of the events he related, and having taken part in them, adds authority to his words. The political reflexions are always deep: in the *Pensieri*, as Capponi<sup>2</sup> says, he seems to aim at extracting through self-examination a quintessence, as it were, of the things observed and done by him,—thus endeavouring to form a political doctrine as adequate as possible in all its parts. Machiavelli and Guicciardini may be considered, not only as distinguished historians, but as originators of the science of history founded on observation.

Inferior to them, but still always worthy of note, were Jacopo Nardi (a just and faithful historian and a virtuous man, who defended the rights of Florence against the Medici before Charles V.), Benedetto Varchi, Giambattista Adriani, Bernardo Segni; and, outside Tuscany, Camillo Perzio, who related the *Congiura de' Baroni* and the history of Italy from 1547 to 1552, Angelo di Costanza, Pietro Bembo, Paolo Paruta, and others.

Ariosto's *Orlando Furioso* was a continuation of Boiardo's *Romanzo Innamorato*. His characteristic is that he assimilated the romance of chivalry to the style and models of classicism. Ariosto.

Ariosto was an artist only for the love of his art; his sole aim was to make a romance that should please the generation in which he lived. His *Orlando* has no grave and serious purpose; on the contrary it creates a fantastic world, in which the poet rambles, indulging his caprice, and sometimes smiling at his own work. His great desire is to depict everything with the greatest possible perfection; the cultivation of style is what occupies him most. In his hands, the style becomes wonderfully plastic to every conception, whether high or low, serious or sportive. The octave stanza reached in him the highest perfection of grace, variety, and harmony.

Meanwhile, side by side with the romantic, there was an Herote attempt at the historical epic. Gian Giorgio Trissino of

Vicenza composed a poem called *Italia liberata dai Goti*. Full of learning and of the rules of the ancients, he formed himself on the latter, in order to sing of the campaigns of Belisarius; he said that he had forced himself to observe all the rules of Aristotle, and that he had imitated Homer. In this again, we see one of the products of the Renaissance; and, although Trissino's work is poor in invention and without any original poetical colouring, yet it helps one to understand better what were the conditions of mind in the 16th century.

Lyric poetry was certainly not one of the kinds that Lyric rose to any great height in the 16th century. Originality poetry. was entirely wanting, since it seemed in that century as if nothing better could be done than to copy Petrarch. Still, even in this style there were some vigorous poets. Monsignore Giovanni Guidiccioni of Lucca (1500–1541) showed that he had a generous heart. In fine sonnets he gave expression to his grief for the sad state to which his country was reduced. Francesco Molza of Modena (1489–1544), learned in Greek, Latin, and Hebrew, wrote in a graceful style and with spirit. Giovanni della Casa (1503–1556) and Pietro Bembo (1470–1547), although Petrarchists, were elegant. Even Michelangelo Buonarroti was at times a Petrarchist, but his poems bear the stamp of his extraordinary and original genius. And a good many ladies are to be placed near these poets, such as Vittoria Colonna (loved by Michelangelo), Veronica Gambara, Tullia d'Aragona, Giulia Gonzaga, poetesses of great delicacy, and superior in genius to many literary men of their time.

The 16th century had not a few tragedies, but they are Drama

<sup>1</sup> Hitherto there has been no complete and objective study on Machiavelli, although very much has been written about him. This want, it is hoped, will be supplied when Signor Villari has completed his work, of which only the first volume has as yet appeared, *Niccolò Machiavelli e i suoi tempi illustrati con nuovi documenti*, Florence, 1877.

<sup>2</sup> *Storia della Repubblica di Firenze*, Florence, 1876.



all weak. The cause of this was the moral and religious indifference of the Italians, the lack of strong passions and vigorous characters. The first to occupy the tragic stage was Trissino with his *Sofonisba*, following the rules of the art most scrupulously, but written in sickly verses, and without warmth of feeling. The *Oreste* and the *Rosmunda* of Giovanni Rucellai were no better, nor Luigi Alamanni's *Antigone*. Sperone Speroni in his *Canace* and Giraldi Cintio in his *Orbecche* tried to become innovators in tragic literature, but they only succeeded in making it grotesque. Decidedly superior to these was the *Torrismondo* of Torquato Tasso, specially remarkable for the choruses, which sometimes remind one of the chorus of the Greek tragedies.

The Italian comedy of the 16th century was almost entirely modelled on the Latin comedy. They were almost always alike in the plot, in the characters of the old man, of the servant, of the waiting-maid; and the argument was often the same. Thus the *Lucidi* of Agnolo Firenzuola, and the *Vecchio Amoroso* of Donato Giannotti were modelled on comedies by Plautus, as were the *Sporta* by Gelli, the *Marito* by Dolce, and others. There appear to be only three writers who should be distinguished among the many who wrote comedies,—Machiavelli, Ariosto, and Giovan Maria Cecchi. In his *Mandragora* Machiavelli, unlike all the others, composed a comedy of character, creating types which seem living even now, because they were copied from reality seen with a finely observant eye. Ariosto, on the other hand, was distinguished for his picture of the habits of his time, and especially of those of the Ferrarese nobles, rather than for the objective delineation of character. Lastly, Cecchi left in his comedies a treasure of spoken language, which nowadays enables us in a wonderful way to make ourselves acquainted with that age. The notorious Pietro Aretino might also be included in the list of the best writers of comedy.

The 15th century was not without humorous poetry; Antonio Cammelli, surnamed the Pistoian, is specially deserving of notice, because of his "pungent *bonhomie*," as Sainte-Beuve called it. But it was Francesco Berni who carried this kind of literature to perfection in the 16th century. From him the style has been called "bernesque" poetry. In the "Berneschi" we find nearly the same phenomenon that we already noticed with regard to *Orlando Furioso*. It was art for art's sake that inspired and moved Berni to write, as well as Anton Francesco Grazzini called Il Lascia, and other lesser writers. It may be said that there is nothing in their poetry; and it is true that they specially delight in praising low and disgusting things and in jeering at what is noble and serious. Bernesque poetry is the clearest reflexion of that religious and moral scepticism which was one of the characteristics of Italian social life in the 16th century, and which showed itself more or less in all the works of that period, that scepticism which stopped the religious Reformation in Italy, and which in its turn was an effect of historical conditions. The Berneschi, and especially Berni himself, sometimes assumed a satirical tone. But theirs could not be called true satire. Pure satirists, on the other hand, were Antonio Vinciguerra, a Venetian, Lodovico Alamanni, and Ariosto, the last superior to the others for the Attic elegance of his style, and for a certain frankness, passing into malice, which is particularly interesting when the poet talks of himself.

In the 16th century there were not a few didactic works. In his poem of the *Aspi* Giovanni Rucellai approaches to the perfection of Virgil. His style is clear and light, and he adds interest to his book by frequent allusions to the events of the time. But of the didactic works that which surpasses all the others in importance is

Baldassare Castiglione's *Cortigiano*, in which he imagines a discussion in the palace of the dukes of Urbino between knights and ladies as to what are the gifts required in a perfect courtier. This book is valuable as an illustration of the intellectual and moral state of the highest Italian society in the first half of the 16th century.

Of the novelists of the 16th century, the two most important were Anton Francesco Grazzini and Matteo Bandello,—the former as playful and bizarre as the latter is grave and solemn. As part of the history of the times, we must not forget that Bandello was a Dominican friar and a bishop, but that notwithstanding his novels were very loose in subject, and that he often holds up the ecclesiastics of his time to ridicule.

At a time when admiration for qualities of style, the desire for classical elegance, was so strong as in the 16th century, much attention was naturally paid to translating Latin and Greek authors. Among the very numerous translations of the time those of the *Aeneid* and of the *Pastorals of Longus* the Sophist by Annibal Caro are still famous; as are also the translations of Ovid's *Metamorphoses* by Giovanni Andrea dell' Anguillare, of Apuleius's *Golden Ass* by Firenzuola, and of Plutarch's *Lives* and *Moralia* by Marcello Adriani.

The historians of Italian literature are even now in doubt whether Tasso should be placed in the period of the highest development of the Renaissance, or whether he should form a period by himself, intermediate between that and the one following. Certainly he was profoundly out of harmony with the century in which he lived. His religious faith, the seriousness of his character, the deep melancholy settled in his heart, his continued aspiration after an ideal perfection, all place him as it were outside the literary epoch represented by Machiavelli, by Ariosto, by Berni. As Carducci has well said, Tasso "is the legitimate heir of Dante Alighieri: he believes, and reasons on his faith by philosophy; he loves, and comments on his love in a learned style; he is an artist, and writes dialogue of scholastic speculation that would fain be Platonic." He was only eighteen years old when, in 1562, he tried his hand at epic poetry, and wrote *Rinaldo*, in which he said that he had tried to reconcile the Aristotelian rules with the variety of Ariosto. He afterwards wrote the *Aminta*, a pastoral drama of exquisite grace. But the work to which he had long turned his thoughts was an heroic poem, and that absorbed all his powers. He himself explains what his intention was in the three *Discorsi* written whilst he was composing the *Gerusalemme*: he would choose a great and wonderful subject, not so ancient as to have lost all interest, nor so recent as to prevent the poet from embellishing it with invented circumstances; he meant to treat it rigorously according to the rules of the unity of action observed in Greek and Latin poems, but with a far greater variety and splendour of episodes, so that in this point it should not fall short of the romantic poem; and finally, he would write it in a lofty and ornate style. This is what Tasso has done in the *Gerusalemme Liberata*, the subject of which is the liberation of the sepulchre of Jesus Christ in the 11th century by Godfrey of Bouillon. The poet does not follow faithfully all the historical facts, but sets before us the principal causes of them, bringing in the supernatural agency of God and Satan. The *Gerusalemme* is the best heroic poem that Italy can show. It approaches to classical perfection. Its episodes above all are most beautiful. There is profound feeling in it, and everything reflects the melancholy soul of the poet. As regards the style, however, although Tasso studiously endeavoured to keep close to the classical models, one cannot help noticing that he makes excessive use of metaphor, of antithesis, of far-fetched conceits; and it is

Bur-  
lesque  
and  
satire.

Didactic  
works.

specially from this point of view that some historians have placed Tasso in the literary period generally known under the name of "Secentismo," and that others, more moderate in their criticism, have said that he prepared the way for it.

Period of decadence.

5. *Period of Decadence.*—From about 1559 began a period of decadence in Italian literature. The Spanish rule oppressed and corrupted the peninsula. The minds of men were day by day gradually losing their force; every high aspiration was quenched. No love of country could any longer be felt when the country was enslaved to a stranger. The suspicious rulers fettered all freedom of thought and word; they tortured Campanella, burned Bruno, made every effort to extinguish all high sentiment, all desire for good. Cesare Balbo says, "if the happiness of the masses consists in peace without industry, if the nobility's consists in titles without power, if princes are satisfied by acquiescence in their rule without real independence, without sovereignty, if literary men and artists are content to write, paint, and build with the approbation of their contemporaries, but to the contempt of posterity, if a whole nation is happy in ease without dignity and the tranquil progress of corruption,—then no period ever was so happy for Italy as the hundred and forty years from the treaty of Cateau Cambresis to the war of the Spanish succession." This period is known in the history of Italian literature as the Secentismo. Its writers, devoid of sentiment, of passion, of thoughts, resorted to exaggeration; they tried to produce effect with every kind of affectation, with bombast, with the strangest metaphors, in fact, with what in art is called mannerism, "baroecism." The utter poverty of the matter tried to cloak itself under exuberance of forms. It seemed as if the writers vied with one another as to who could best burden his art with useless metaphors, with phrases, with big-sounding words, with affectations, with hyperbole, with oddities, with everything that could fix attention on the outer form and draw it off from the substantial element of thought.

The Secentismo.

At the head of the school of the "Secentisti" comes Giovan Battista Marini of Naples, born in 1569, especially known by a poem called *L'Adone*. His aim was to excite wonder by novelties; hence the most extravagant metaphors, the most forced antitheses, the most far-fetched conceits, are to be found in his book. It was especially by antitheses that he thought he could produce the greatest effect. Sometimes he strings them together one after the other, so that they fill up whole stanzas without a break. Achillini of Bologna followed in Marini's steps. He had less genius, however, and hence his peculiarities were more extravagant, becoming indeed absolutely ridiculous. In general, we may say that all the poets of the 17th century were more or less infected with "Marinism." Thus Alessandro Guidi, although he does not attain to the exaggeration of his master, is empty bombastic, inflated, turgid, while Fulvio Testi is artificial and affected. Yet Guidi as well as Testi felt the influence of another poet, Gabriello Chiabrera, born at Savona in 1552. In him the Secentismo took another character. Enamoured as he said he was of the Greeks, he made new metres, especially in imitation of Pindar, treating of religious, moral, historical, and amatory subjects. It is easy to understand that a Pindaric style of poetry in the 17th century in Italy could not but end in being altogether artificial, without anything of those qualities which constitute the greatness of the Greek poet. Chiabrera, though elegant enough in form, proves empty of matter, and, in his vain attempt to hide this vacuity, has recourse to poetical ornaments of every kind. These again, in their turn, become in him a fresh defect. Nevertheless, Chiabrera's school, in the decadence of the 17th century, marks an improvement;

and sometimes he showed that he had lyrical capacities, which in better literary surroundings would have brought forth excellent fruit. When he sings, for example, of the victories of the Tuscan galleys against the Turks and the pirates of the Mediterranean, he rises to grand imagery, and seems quite another poet.

Filicaja the Florentine has a certain lyric *élan*, particularly in the songs about Vienna besieged by the Turks, which seems to raise him more than the others above the vices of the time; but even in him we see clearly the rhetorical artifice and the falseness of the conceits. And in general all the lyric poetry of the 17th century may be said to have had the same defects, but in different degrees,—defects which may be summed up as absence of feeling and exaggeration of form. There was no faith; there was no love; and thus art became an exercise, a pastime, a luxury, for a servile and corrupt people.

The belief then arose that it would be sufficient to change the form in order to restore literature, in forgetfulness that every reform must be the effect of a change in social and moral conditions. Weary of the bombastic style of the 17th century, full of conceits and antithesis, men said—let us follow an entirely different line, let us fight the turgid style with simplicity. In 1690 the "Academy of Arcadia" was instituted. Its founders were Giovan Maria Crescimbeni and Gian Vincenzo Gravina. The Arcadia was so called because its chief aim and intention were to imitate in literature the simplicity of the ancient shepherds, who were fabulously supposed to have lived in Arcadia in the golden age. As the "Secentisti" erred by an overweening desire for novelty, which made them always go beyond the truth, so the Arcadians proposed to themselves to return to the fields of truth, always singing of subjects of pastoral simplicity. This was obviously nothing else than the substitution of a new artifice for the old one; and they fell from bombast into effeminacy, from the hyperbolic into the petty, from the turgid into the over-refined. The Arcadia was a reaction against Secentismo, but a reaction which, reversing the movement of that earlier epoch, only succeeded in impoverishing still further and completely withering up the literature. The poems of the "Arcadians" fill many volumes, and are made up of sonnets, madrigals, canzonets, and blank verse. The one who most distinguished himself among the sonneteers was Felice Zappi. Among the authors of songs Paolo Rolli was illustrious. Innocenzo Frugoni was more famous than all the others, a man of fruitful imagination but of shallow intellect, whose wordy verses nobody now reads.

Whilst the political and social conditions in Italy in the 17th century were such as to make it appear that every light of intelligence, all spirit of liberty, was extinguished, there appeared in the peninsula, by that law of reaction which in great part governs human events, some strong and independent thinkers, such as Bernardino Telesio, Giordano Bruno, Tommaso Campanella, Lucilio Vanini, who turned philosophical inquiry into fresh channels, and opened the way for the scientific conquests of Galileo Galilei, the great contemporary of Descartes in France and of Bacon in England. Galileo was not only a great man of science, but also occupied a conspicuous place in the history of letters. A devoted student of Ariosto, he seemed to transmute into his prose the qualities of that great poet,—a clear and frank freedom of expression, a wonderful art of knowing how to say everything with precision and ease, and at the same time with elegance. Galileo's prose is in perfect antithesis to the poetry of his time. Perhaps it is the best prose that Italy has ever had; it is clear, goes straight to the point, is without rhetorical ornaments and without vulgar slips, artistic without appearing to be so.

Another symptom of revival, a sign of rebellion against Satire.

The Arcadia

Symptoms of revival. Scientific prose.



the vileness of Italian social life, is given us in satire and in particular in that of Salvator Rosa and Alessandro Tassoni. Salvator Rosa, born in 1615, near Naples, was a painter, a musician, and a poet. As a poet he showed that he felt the sad condition of his country, showed that he mourned over it, and gave vent to his feeling (as another satire-writer, Giuseppe Giusti, said) in *generosi rabbuffi*. His exhortation to Italian poets to turn their thoughts to the miseries of their country as a subject for their song—their country languishing under the tyrant's hands—certain passages where he deploras the effeminacy of Italian habits, a strong apostrophe against Rome, make Salvator Rosa a precursor of the patriotic literature which inaugurated the revival of the 18th century. Tassoni, a man really quite exceptional in this century, was superior to Rosa. He showed independent judgment in the midst of universal servility, and his *Secchia Rapita*, proved that he was an eminent writer. This is an heroic comic poem, which is at the same time an epic and a personal satire. He was bold enough to attack the Spaniards in his *Filippiche*, in which he urged Duke Carlo Emanuele of Savoy to persist in the war against them.

6. *The Revival in the 18th Century.*—Having for the most part freed itself from the Spanish dominion in the 18th century, the political condition of Italy began to improve. Promoters of this improvement, which was shown in many civil reforms, were Joseph II., Leopold I., and Charles I. The work of these princes was copied from the philosophers, who in their turn felt the influence of a general movement of ideas, which was quietly working in many parts of Europe, and which came to a head in the French encyclopedists.

Giambattista Vico was a token of the awakening of historical consciousness in Italy. In his *Scienza Nuova* he applied himself to the investigation of the laws governing the progress of the human race, and according to which events are developed. From the psychological study of man he endeavoured to infer the “*comune natura delle nazioni*,” i.e., the universal laws of history, or the laws by which civilizations rise, flourish, and fall.

From the same scientific spirit which animated the philosophical investigation of Vico, there was born a different kind of investigation, that of the sources of Italian civil and literary history. Lodovico Antonio Muratori, after having collected in one entire body (*Rerum Italicarum Scriptores*) the chronicles, the biographies, the letters, and the diaries of Italian history from 500 to 1500, after having discussed the most obscure historical questions in the *Antiquitates Italice Medii Ævi*, wrote the *Annali d'Italia*, minutely narrating facts derived from authentic sources. Muratori's associates in his historical researches were Scipione Maffei of Verona and Apostolo Zeno of Venice. In his *Verona illustrata* the former left, not only a treasure of learning, but an excellent specimen of historical monograph. The latter added much to the erudition of literary history, both in his *Dissertazioni Vossiane* and in his notes to the *Biblioteca dell'Eloquenza Italiana* of Monsignore Giusto Fontanini. Girolamo Tiraboschi and the Count Giovanni Maria Mazzuchelli of Brescia devoted themselves to literary history. The latter meant to give in his *Scrittori d'Italia*, not only the biography of all the writers, but an account of their works. Only six volumes were printed, containing the letters A and B; but the immense materials collected by him are in the Vatican library, and it is to be hoped that some day they may be arranged and published.

While the new spirit of the times led men to the investigation of historical sources, it also led them to inquire into the mechanism of economical and social laws. Francesco Galiani wrote on currency; Gaetano Filangieri wrote a

*Scienza della Legislazione*. Cesare Beccaria, in his treatise *Dei Delitti e delle Pene*, made a contribution to the reform of the penal system and promoted the abolition of torture.

The man in whom above all others the literary revival of the 18th century was most conspicuously embodied was Giuseppe Parini. He was born in a Lombard village in 1729, was mostly educated at Milan, and as a youth was known among the Arcadian poets by the name of Darisbo Elidonio. Even as an Arcadian, however, Parini showed signs of departing from the common type. In a collection of poems that he published at twenty-three years of age, under the name of Ripano Eupilino, there are some pastoral sonnets in which the poet shows that he had the faculty of taking his scenes from real life, and also some satirical pieces in which he exhibits a spirit of somewhat rude opposition to his own times. These poems are perhaps based on reminiscences of Berni, but at any rate they indicate a resolute determination to assail boldly all the literary conventionalities that surrounded the author. This, however, was only the beginning of the battle. Parini lived in times of great social prostration. The nobles and the rich, all given up to ease and to silly gallantry, consumed their lives in ridiculous trifles or in shameless self-indulgence, wasting themselves on immoral “*Cicisbeismo*,” and offering the most miserable spectacle of feebleness of mind and character. It was against this social condition that Parini's muse was directed. Already, improving on the poems of his youth, he had proved himself an innovator in his lyrics, rejecting at once Petrarchism, Secentismo, and Arcadia, the three maladies that had weakened Italian art in the centuries preceding his own, and choosing subjects taken from real life, such as might help in the instruction of his contemporaries. In the *Ódi* the satirical note is already heard. But it came out more strongly in the poem *Del Giorno*, in which he imagines himself to be teaching a young Milanese patrician all the habits and ways of gallant life; he shows up all its ridiculous frivolities, and with delicate irony unmasks the facilities of aristocratic habits. Dividing the day into four parts, the *Mattino*, the *Mezzogiorno*, the *Vespera*, the *Notte*, by means of each of these he describes the trifles of which they were made up, and the book thus assumes a social and historical value of the highest importance. Parini, satirizing his time, fell back upon truth, and finally made art serve the purpose of civil morality. As an artist, going straight back to classical forms, aspiring to imitate Virgil and Dante, he opened the way to the fine school that we shall soon see rise, that of Alfieri, Foscolo, and Monti. As a work of art, the *Giorno* is wonderful for the Socratic skill with which that delicate irony is constantly kept up by which he seems to praise what he effectually blames. The verse has new harmonies; sometimes it is a little hard and broken, not by accident, but as a protest against the Arcadian monotony. Generally it flows majestically, but without that Frugonian droning that deafens the ears and leaves the heart cold.

Gasparo Gozzi's satire was less elevated, but directed towards the same end as Parini's. In his *Osservatore*, something like Addison's *Spectator*, in his *Gazzetta Veneta*, in the *Mondo Morale*, by means of allegories and novelties he hit the vices with a delicate touch, and inculcated a practical moral with much good sense. Gozzi's satire has some slight resemblance in style to Lucian's. It is smooth and light, but withal it does not go less straight to its aim, which is to point out the defects of society and to correct them. Gozzi's prose is very graceful and lively. It only errs by its overweening affectation of imitating the writers of the 14th century. Another satirical writer of the first half of the 18th century was Giuseppe Baretti of Turin. To a journal called the *Frusta Letteraria* he took to lashing

New political conditions.

Historical works.

Social science.

without mercy the works which were then being published in Italy. He had learnt much by travelling; and especially his long stay in England had contributed to give an independent character to his mind, and made him judge of men and things with much good sense. It is true that his judgments are not always right, but the *Frusta Letteraria* was the first book of independent criticism, directed particularly against the Arcadians and the pedants.

Everything tended to improvement, and the character of the reform was to throw off the conventional, the false, the artificial, and to return to truth. The drama felt this influence of the times. Apostolo Zeno and Metastasio (the Arcadian name for Pietro Trappasi, a native of Rome) had endeavoured to make "melodrama and reason compatible." The latter in particular succeeded in giving fresh expression to the affections, a natural turn to the dialogue, and some interest to the plot; and if he had not fallen into constant unnatural over-refinement and unseasonable mawkishness, and into frequent anachronisms, he might have been considered as the first dramatic reformer of the 18th century. That honour belongs to Carlo Goldoni, a Venetian. He found comedy either entirely devoted to classical imitation, or given up to extravagance, to *coups de théâtre*, to the most boisterous succession of unlikely situations, or else treated by comic actors who recited impromptu on a given subject, of which they followed the outline. In this old popular form of comedy, with the masks of pantaloon, of the doctor, of harlequin, of Brighella, &c., Goldoni found the strongest obstacles to his reform. But at last he conquered, creating the comedy of character. No doubt Molière's example helped him in this. Goldoni's characters are always true, but often a little superficial. He studied nature, but he did not plunge into psychological depths. In most of his creations, the external rather than the internal part is depicted. In this respect he is much inferior to Molière. But on the other hand he surpasses him in the liveliness of the dialogue, and in the facility with which he finds his dramatic situations. Goldoni wrote much, in fact too much (more than one hundred and fifty comedies), and had no time to correct, to polish, to perfect his works, which are all rough cast. But for a comedy of character we must go straight from Machiavelli's *Mandragora* to him. Goldoni's dramatic aptitude is curiously illustrated by the fact that he took nearly all his types from Venetian society, and yet managed to give them an inexhaustible variety. A good many of his comedies were written in Venetian dialect, and these are perhaps the best.

Patriotic literature and return to classicism.

The ideas that were making their way in French society in the 18th century, and afterwards brought about the Revolution of 1789, gave a special direction to Italian literature of the second half of the 18th century. Love of ideal liberty, desire for equality, hatred of tyranny, created in Italy a literature which aimed at national objects, seeking to improve the condition of the country by freeing it from the double yoke of political and religious despotism. But all this was associated with another tendency. The Italians who aspired to a political redemption believed that it was inseparable from an intellectual revival, and it seemed to them that this could only be effected by a reunion with ancient classicism,—in other words, by putting themselves in more direct communication with ancient Greek and Latin writers. This was a repetition of what had occurred in the first half of the 15th century. The 17th century might in fact be considered as a new Italian Middle Age without the hardness of that iron time, but corrupted, enervated, overrun by Spaniards and French, an age in which previous civilization was cancelled. A reaction was necessary against that period of history, and a construction on its ruins of a new country and a new

civilization. There had already been forerunners of this movement; at the head of them the revered Parini. Now the work must be completed, and the necessary force must once more be sought for in the ancient literature of the two classic nations. Patriotism and classicism then were the two principles that inspired the literature which began with Alfieri. He worshipped the Greek and Roman idea Alfieri. of popular liberty in arms against the tyrant. He took the subjects of his tragedies almost invariably from the history of these nations, made continual apostrophes against the despots, made his ancient characters talk like revolutionists of his time; he did not trouble himself with, nor think about, the truth of the characters; it was enough for him that his hero was Roman in name, that there was a tyrant to be killed, that liberty should triumph in the end. But even this did not satisfy Alfieri. Before his time and all about him there was the Arcadian school, with its foolish verbosity, its empty abundance of epithets, its nauseous pastoralizing on subjects of no civil importance. It was necessary to arm the patriotic muse also against all this. If the Arcadians, not excluding the hated Metastasio, diluted their poetry with languishing tenderness, if they poured themselves out in so many words, if they made such set phrases, it behoved the others to do just the contrary, to be brief, concise, strong, bitter, to aim at the sublime as opposed to the lowly and pastoral. Having said this, we have told the good and evil of Alfieri. He desired a political reform by means of letters; he saved literature from Arcadian vacuities, leading it towards a national end; he armed himself with patriotism and classicism in order to drive the profaners out of the temple of art. But in substance he was rather a patriot than an artist. In any case the results of the new literary movement were copious.

Ugo Foscolo was an eager patriot, who carried into life Foscolo the heat of the most unbridled passion, and into his art a rather rhetorical manner, but always one inspired by classical models. His life was a most exciting one: he was a soldier with General Massena, a professor of eloquence at the university of Pavia, an exile after 1815. Three strong passions were always united in him—a passion for Italy, for art, and for beautiful women. Foscolo was born at Zante, and took pride in being a Greek. He translated some books of the *Iliad*, and the *Coma Berenices* of Catullus. He studied classical authors widely, and in his original works the reflexion of them is perceptible. The *Lettere di Jacopo Ortis*, inspired by Goethe's *Werther*, are a love story with a mixture of patriotism; they contain a violent protest against the treaty of Campo Formio, and an outburst from Foscolo's own heart about an unhappy love-affair of his. His passions were sudden and violent; they came to an end as abruptly as they began; they were whirlwinds that were over in a quarter of an hour. To one of these passions *Ortis* owed its origin, and it is perhaps the best, the most sincere, of all his writings. Even in it he is sometimes pompous and rhetorical, but much less so than he is, for example, in the lectures *Dell' Origine e dell' Ufficio della Letteratura*. On the whole, Foscolo's prose is turgid and affected, and reflects the character of the man who always tried to pose, even before himself, in dramatic attitudes. This was indeed the defect of the Napoleonic epoch; there was a horror of anything common, simple, natural; everything must be after the model of the hero who made all the world gaze with wonder at him; everything must assume some heroic shape. In Foscolo this tendency was excessive; and it not seldom happened that, in wishing to play the hero, the exceptional man, the little Napoleon of ladies' drawing-rooms, he became false and bad, false in his art, bad in his life. The *Sepolcri*, which is his best poem, was prompted by high



feeling, and the mastery of versification shows wonderful art. Perhaps it is to this mastery more than to anything else that the admiration the *Sepolcri* excites is due. There are most obscure passages in it, as to the meaning of which it would seem as if even the author himself had not formed a clear idea. He left incomplete three hymns to the Graces, in which he sang of beauty as the source of courtesy, of all high qualities, and of happiness. Here again what most excites our admiration is the harmonious and easy versification. Among his prose works a high place belongs to his translation of the *Sentimental Journey* of Sterne, a writer by whom one can easily understand how Foscolo should have been deeply affected. He went as an exile to England, and died there. He wrote for English readers some *Essays* on Petrarch and on the texts of the *Decamerone* and of Dante, which are remarkable for the time at which they were written, and which may be said to have initiated a new kind of literary criticism in Italy. Foscolo is still greatly admired, and not without reason. His writings stimulate the love of fatherland, and the men that made the revolution of 1848 were largely brought up on them. Still, his fame both as a man and as an artist is now on the decline.

Monti.

If in Foscolo patriotism and classicism were united, and formed almost one passion, so much cannot be said of Vincenzo Monti, in whom the artist was absolutely predominant. Yet we must be careful; Monti was a patriot too, but in his own way. He had no one deep feeling that ruled him, or rather the mobility of his feelings is his characteristic; but each of these was a new form of patriotism, that took the place of an old one. He saw danger to his country in the French Revolution, and wrote the *Pellegrino Apostolico*, the *Bassvilliana*, and the *Feroniade*; Napoleon's victories caused him to write the *Prometeo* and the *Musagonia*; in his *Fanatismo* and his *Superstizione* he attacked the papacy; afterwards he sang the praises of the Austrians. Thus every great event made him change his mind, with a readiness which might seem incredible, but is yet most easily explained. Monti was above everything an artist; art was his real, his only passion; everything else in him was liable to change, that alone was persistent. Fancy was his tyrant, and under its rule he had no time to reason and to see the miserable aspect of his political tergiversation. It was an overbearing deity that moved him, and at its dictation he wrote. Pius VI., Napoleon, Francis II., were to him but passing shadows, to which he hardly gives the attention of an hour; that which endures, which is eternal to him, is art alone. It were unjust to accuse Monti of baseness. If we say that nature in giving him one only faculty had made the poet rich and the man poor, we shall speak the truth. But the poet was indeed rich. Knowing little Greek, he succeeded in making a translation of the *Iliad* which is remarkable for its Homeric feeling, and in his *Bassvilliana* he is on a level with Dante. In fine, in him classical poetry seemed to revive in all its florid grandeur.

Nicolini.

Monti was born in 1754, Foscolo in 1778; four years later still was born another poet of the same school, Giambattista Nicolini. In literature he was a classicist; in politics he was a Ghibelline, a rare exception in Guelph Florence, his birthplace. In translating or, if the expression is preferred, imitating Æschylus, as well as in writing the *Discorsi sulla Tragedia Greca*, and on the *Sublime e Michelangelo*, Nicolini displayed his passionate devotion to ancient literature. In his tragedies he set himself free from the excessive rigidity of Alfieri, and partly approached the English and German tragic authors. He nearly always chose political subjects, striving to keep alive in his compatriots the love of liberty. Such are *Nabucco*, *Antonio Foscarini*, *Giovanni da Procida*, *Lodovico il Moro*, &c. He assailed papal Rome in *Arnaldo da Brescia*, a long tragic

piece, not suited for acting, and epic rather than dramatic. Nicolini's tragedies show a rich lyric vein rather than dramatic genius. At any rate he has the merit of having vindicated liberal ideas, and of having opened a new path to Italian tragedy.

The literary period we are dealing with had three writers who are examples of the direction taken by historical study. It seems strange that, after the learned school begun by Muratori, there should have been a backward movement here, but it is clear that this retrogression was due to the influence of classicism and patriotism, which, if they revived poetry, could not but spoil history. Carlo Botta, born in 1766, was a spectator of French spoliation in Italy and of the overbearing rule of Napoleon. Hence, excited by indignation, he wrote a *History of Italy from 1789 to 1814*; and later on he continued Guicciardini's *History* up to 1789. He wrote after the manner of the Latin authors, trying to imitate Livy, putting together long and sonorous periods in a style that aimed at being like Boccaccio's, caring little about that which constitutes the critical material of history, only intent on declaiming his academic prose for his country's benefit. Botta wanted to be classical in a style that could no longer be so, and hence he failed completely to attain his literary goal. His fame is only that of a man of a noble and patriotic heart. Not so bad as the two histories of Italy is that of the *Guerra dell'Indipendenza Americana*.

Close to Botta comes Pietro Colletta, a Neapolitan born nine years after him. He also in his *Storia del Reame di Napoli dal 1734 al 1825* had the idea of defending the independence and liberty of Italy in a style borrowed from Tacitus; and he succeeded rather better than Botta. He has a rapid, brief, nervous style, which makes his book attractive reading. But it is said that Pietro Giordani and Gino Capponi corrected it for him. Lazzaro Papi of Lucca, author of the *Commentari della Rivoluzione Francese dal 1789 al 1814*, was not altogether unlike Botta and Colletta. He also was an historian in the classical style, and treats his subject with patriotic feeling; but as an artist he perhaps excels the other two.

At first sight it seems unnatural that, whilst the most burning political passions were raging, and whilst the most brilliant men of genius in the new classical and patriotic school were at the height of their influence, a question should have arisen about "purism" of language. Yet the phenomenon can be easily accounted for. Purism is another form of classicism and patriotism. In the second half of the 18th century the Italian language was specially full of French expressions. There was great indifference about fitness, still more about elegance of style. Prose then was to be restored for the sake of national dignity, and it was believed that this could not be done except by going back to the writers of the 14th century, to the "aurei trecentisti," as they were called, or else to the classics of Italian literature. One of the promoters of the new school was Antonio Cesari of Verona, who republished ancient authors, and brought out a new edition, with additions, of the *Vocabolario della Crusca*. He wrote a dissertation *Sopra lo stato presente della Lingua Italiana*, and endeavoured to establish the supremacy of Tuscan and of the three great writers Dante, Petrarch, Boccaccio. And in accordance with that principle he wrote several books, taking pains to copy the "trecentisti" as closely as possible. But patriotism in Italy has always had something municipal in it; so to this Tuscan supremacy, proclaimed and upheld by Cesari, there was opposed a Lombard school, which would know nothing of Tuscan, and with Dante's *De Vulgari Eloquentia* returned to the idea of the "lingua illustre." This was an old question, largely and bitterly argued in the Cinquecento (16th century) by Varchi,

Muzio, Castelvetro, Speroni, and others. Now the question came up again quite fresh, as if no one had ever discussed it before. At the head of the Lombard school were Monti and his son-in-law Count Giulio Perticari. This gave Monti an occasion to write *Proposta di alcune Correzioni ed Aggiunte al Vocabolario della Crusca*, in which he attacked the Tuscanism of the *Crusca*, but in a graceful and easy style, such in fact as to form a prose that is one of the most beautiful in Italian literature. Perticari on the other hand, with a very inferior intellect, narrowed and exasperated the question in two treatises *Degli Scrittori del Trecento* and *Dell' Amor Patrio di Dante*, in which, often disguising or altering the facts, he only makes confusion where there was none. Meantime, however, the impulse was given. The dispute about language took its place beside literary and political disputes, and all Italy took part in it,—Basilio Puoti at Naples, Paolo Costa in the Romagna, Marc' Antonio Parenti at Modena, Salvatore Betti at Rome, Giovanni Gherardini in Lombardy, Luigi Forrucciari at Lucca, Vincenzo Nannucci at Florence.

Giordani.

A patriot, a classicist, and a purist all at once was Pietro Giordani, born in 1774; he was almost a compendium of the literary movement of the time. His whole life was a battle fought for liberty. Most learned in Greek and Latin authors, and in the Italian trecentisti, he only left a few writings behind him, but they were carefully elaborated in point of style, and his prose was in his time considered wonderful. Now it is looked on as too majestic, too much laboured in phrases and conceits, too far from nature, too artificial. Giordani closes the literary epoch of the classicists.

Contemporary literature.

7. *Contemporary Period.*—At this point the contemporary period of literature begins. It has been said that the first impulse was given to it by the romantic school, which had as its organ the *Conciliatore* established in 1818 at Milan, and on the staff of which were Silvio Pellico, Lodovico di Breme, Giovinetti Scalvini, Tommaso Grossi, Giovanni Berchet, Samuele Biava, and lastly Alessandro Manzoni. It need not be denied that all these men were influenced by the ideas that, especially in Germany, at the beginning of the 19th century constituted the movement called Romanticism. Nevertheless in Italy the course of literary reform took another direction. There is no doubt that the real head of the reform, or at least its most distinguished man, was Alessandro Manzoni. He formulated in a letter of his the objects of the new school, saying that it aspired to try and discover and express "il vero storico" and "il vero morale," not only as an end, but as the widest and eternal source of the beautiful. And it is precisely realism in art that characterizes Italian literature from Manzoni onwards. The *Promessi Sposi* is the one of his works that has made him immortal. No doubt the idea of the historical novel came to him from Sir Walter Scott, but he succeeded in something more than an historical novel in the narrow meaning of that word; he created an eminently realistic work of art. The romance disappears; no one cares for the plot, which moreover is of very little consequence. The attention is entirely fixed on the powerful objective creation of the characters. From the greatest to the least they have a wonderful verisimilitude; they are living persons standing before us, not with the qualities of one time more than another, but with the human qualities of all time. Manzoni is able to unfold a character in all particulars, to display it in all its aspects, to follow it through its different phases. He is able also to seize one moment, and from that moment to make us guess all the rest. Don Abbondio and Renzo are as perfect as Azeccagarbugli and Il Sarto. Manzoni dives down into the innermost recesses of the human heart, and draws thence the most subtle psychological reality. In this his

greatness lies, which was recognized first by his companion in genius, Goethe. With the exception of the *Promessi Sposi*, his works are important for the history of the author's mind, not for the history of literature. Some of them are rather in contrast to that masterpiece. It is chiefly the *Inni Sacri* and the two tragedies that explain why Manzoni became the head of the school of Romanticism. It is not to be denied that even as a poet he had gleams of genius, especially where he describes human affections, as in some stanzas of the *Inni* and in the chorus of the *Adelchi*. But it is the *Promessi Sposi* alone that places him at the head of the Italian literature of the 19th century, on account of the artistic realism prevailing in it. But Manzoni shared this glory with another writer, Giacomo Leopardi. It may seem absurd, but still it is the case, that the mystic, the religious Manzoni, has his place side by side with the poet of atheism and despair: they are indissolubly bound together for all time by an artistic intention, identical although realized by different means. Leopardi was born thirteen years after Manzoni at Recanati, of a patrician family, bigoted and avaricious, and he almost entirely educated himself. His body was deformed, and he was of a sickly habit, so that in the years that bring cheerfulness and laughter to youths and children he shut himself up in his father's library and studied. He became so familiar with Greek authors that he used afterwards to say that the Greek mode of thought was more clear and living to his mind than the Latin or even the Italian. Solitude, sickness, domestic tyranny, prepared him for profound melancholy. From this he passed into complete religious scepticism. He sought rest in art, and first wrote a *Canzone all' Italia* and another for the monument of Dante Alighieri (1818), both full of classical and patriotic feeling. They show that for the time, though only for the time, he was of the school of Alfieri, Foscolo, and the others we have spoken of. His love of classicism always continued, but he changed its subject. He passed on into the poetry of sentiment and nature, describing with an unsurpassable realism what he felt and saw. The *Passero solitario*, the *Quiete dopo la Tempesta*, the *Sabato del Villaggio*, are pictures in which objective realism reaches its highest ideality; whilst beside them there are the *Ultimo Canto di Saffo*, the *Ricordanze*, the *Genestra*, and other poems, in which is poured out all the sorrow that weighs on the unhappy man to whom nature has denied every joy and every happiness. Everything is terrible and grand in these poems, which are the most agonizing cry in modern literature, uttered with a solemn quietness that at once elevates and terrifies us. The poetry of despair never had a more powerful or a more sorrowful voice than this. In this Leopardi surpasses even Byron and Shelley. But, besides being the greatest poet of nature and of sorrow, he was also an excellent prose writer. In his *Operette Morali*—dialogues and discourses marked by a cold and bitter smile at human destinies which freezes the reader—the clearness of style, the simplicity of language, and the depth of conception are such that perhaps he is not only the first poet since Dante, but also the most perfect writer of prose that Italian literature has had.

As realism in art gained ground, the positive method in criticism kept pace with it. From the manner of Botta and Colletta history returned to its spirit of learned research, as is shown in such works as the *Archivio Storico Italiano*, established at Florence by Giampietro Vieusseux, the *Storia d'Italia nel Medio Evo* by Carlo Troya, a remarkable treatise by Manzoni himself, *Sopra alcuni Punti della storia Longobardica in Italia*, and the very fine history of the *Vespri Siciliani* by Michele Amari. The same positive method is now being applied to literary history.

But alongside of the great artists Leopardi and Manzoni,



alongside of the learned scholars, there was also in the first half of the 19th century a patriotic literature. To a close observer it will appear that historical learning itself was inspired by the love of Italy. It is well known what Vieusseux's intentions were when he established the *Antologia*, in which work all Italian liberals took part, and which was suppressed by the action of the Russian Government. And it is equally well known that the *Archivio Storico Italiano* was, under a different form, a continuation of the *Antologia*. Florence was in those days the asylum of all the Italian exiles, and these exiles met and shook hands in Vieusseux's rooms, where there was more literary than political talk, but where one thought and one only animated all minds, the thought of Italy.

The literary movement which preceded and was contemporary with the political revolution of 1848 may be said to be represented by four writers,—Giuseppe Giusti, Francesco Domenico Guerrazzi, Vincenzo Gioberti, and Cesare Balbo. Giusti wrote epigrammatic satires in popular language. In incisive phrase he scourged the enemies of Italy; his manner seemed very original, but it really was partly imitated from Beranger. He was a telling political writer, but a mediocre poet,—too much a poet of occasion. Few of his verses will survive as works of art. Guerrazzi had a great reputation and great influence; he was the author of historical novels written with a political object, such as the *Assedio di Firenze*, the *Battaglia di Benevento*, &c. Read with feverish avidity before 1848, these books of his are now almost forgotten. They struck the imagination then by their style, which is partly affected and partly spasmodic. They seemed to be sublime, but were little less than ridiculous. Gioberti had a noble heart and a great mind; his philosophical works are already as good as dead, but the *Primato morale e civile degli Italiani* will last as an important document of the times. It is a book false in substance, but inspired by lofty sentiments, and it is written in an easy and eloquent style, although sometimes a little verbose. The *Gesuita moderno* will live as the most tremendous indictment ever written against the Jesuits. Gioberti was a powerful polemical writer; and in polemics he showed his most original and characteristic qualities. Balbo was an earnest student of history, and made history useful for politics. Like Gioberti in his first period, Balbo was zealous for the civil papacy, and for a federation of the Italian states presided over by it. His *Sommario della Storia d'Italia* is the best epitome that exists of the intricate history of Italy. In the *Pensieri sulla Storia d'Italia* he touched on important subjects, which still await treatment. He did not do himself justice in the *Meditazioni Storiche*, a work on the philosophy of history, for which he had not the necessary qualifications.

It is not advisable to speak of living authors. We shall only notice the fact that the political revival in Italy seems to have brought forth good fruit also in the fields of literature. It appears that the literary bent of the present day is towards historical research. Of the poets, only one, Giosuè Carducci, has as yet acquired a reputation that seems certain to last.

*Literature.*—The following are the more important recent works relating to the history of Italian literature.—Emiliani Giudici, *Storia della Letteratura Italiana*, 2 vols., Florence, 1855; Francesco de Sanctis, *Storia della Letteratura Italiana*, 2 vols., Naples, 1870; Adolfo Bartoli, *Storia della Letteratura Italiana* (the first three volumes are published), Florence, 1879–80; Giosuè Carducci, *Studi Letterari*, Leghorn, 1874; Alessandro d'Ancona, *Origini del Teatro in Italia*, 2 vols., Florence, 1878; Virgili, *Francesco Berni*, Florence, 1881; Pasquale Villari, *Niccolò Machiavelli e i suoi tempi*, vol. i., Florence, 1877; Pio Rajna, *Le Fonti dell'Orlando Furioso*, Florence, 1875; Attilio Hortis, *Studi sulle Opere latine del Boccaccio*, Trieste, 1879; Francesco de Sanctis, *Saggi Critici*, 3 vols., Naples, 1872; Francesco d'Ovidio, *Saggi Critici*, Naples, 1878.

(A. B.)

## INDEX.

- Academies, literary, 507.  
Administration, 462.  
Aquilans, 445.  
Agriculture, 412; statistics of, 450.  
Alberti, Leon Battista, 508.  
Alluzzi, 479.  
Alfieri, 513.  
Alps, 434.  
Anchovy fishery, 455.  
Apennines, 434.  
Arcadia, academy of, 511.  
Area, 434, 448.  
Ariosto, 509.  
Army, 458.  
Art schools, 461.  
Asynims, 462.  
Austrian succession, 484; preponderance, 486.  
Banks, 465.  
Barbarossa, 472.  
Benevolent institutions, 462.  
Berm and Bernesque, 510.  
Boccaccio, 504.  
Bonvecino, 499.  
Botta, Carlo, 570.  
Calabria, 439.  
Cambrai, treaty of, 482.  
Campo Formio, treaty of, 485.  
Carbonari, 488.  
Carni, 447.  
Cateau Cambresis, treaty of, 483.  
Catherine of Siena, 505.  
Cattle, 451.  
Cavalcanti, Guido, 502.  
Cavour, 487.  
Central Italy, 437.  
Ceramic industry, 454.  
Charlemagne, 468.  
Charles V., 482.  
Charles Albert, 488.  
Cheese-making, 452.  
Chiabrera, Gabriello, 511.  
Chioggia, war of, 480.  
Chronicles, early, 505.  
Church, rivalry of, with the emperors, 476.  
Cities, free, 471; their war with the nobles, 474.  
Ciullo d'Alcamo, 409.  
Climate, 441.  
Coast-line, 441.  
Commerce, 456.  
Communes, rise of, 471.  
Companies of adventure, 477.  
Coral, 455.  
Corno, Monte, 437.  
Cotton manufacture, 453.  
Courts, law, 462.  
Crime, 463.  
Currency, 466.  
Custoza, battle of, 488.  
Dairy produce, 452.  
Dante, 502.  
Debt, national, 465.  
Dialects, 492.  
Divisions, territorial, 448.  
Education statistics, 460.  
Electors, 463.  
Emigration, 450.  
Emperors, Frankish, 468; German, 469; rivalry with the Church, 476.  
Ethnography, 443.  
Etruscans, 446.  
Eugeneans, 447.  
Expenditure, national, 465.  
Exports, 456.  
Ezzelino, 475.  
Fasani, Raniero, 500.  
Filicaja, lyricist, 511.  
Finance, 464.  
Fisheries, 442; statistics of, 455.  
Florence, commonwealth of, 479; its influence on literature, 507.  
Foscolo, 513.  
France and Spain, rivalry of, 481.  
Francis of Assisi, 500.  
Frankish emperors, 468.  
Frederick I., 472.  
Frederick II., 474.  
Free cities, rise of, 471; war with nobles, 474.  
Free companies, 477.  
French invasion (1859), 400.  
French revolution, 485.  
Galileo, 511.  
Garibaldi, 487, 490.  
Gauls, 446.  
Genoa, power of, 475.  
Geography, 434–447; ancient, 443.  
Geology, 443.  
German emperors, 469.  
Ghibellines and Guelphs, 475.  
Giacomino, 499.  
Gioberti, 516.  
Giordani, Pietro, 515.  
Goldoni, Carlo, 513.  
Gothic kingdom, 467.  
Gozzi, Gasparo, 512.  
Gran Sasso, 437.  
Guelphs and Ghibellines, 475.  
Guerrazzi, 516.  
Guicciardini, 509.  
Gninicelli, Guido, 501.  
Herbert, 470.  
Hernicans, 445.  
History, 467–491.  
Hospitals, 462.  
Iapygians, 443.  
Imports, 456.  
Independence (1861), 490.  
Innocent III., 474.  
Inquisition, 482.  
Investments, war of, 471.  
Islands, 440.  
Jacopone, 500.  
Justice, administration of, 462.  
Lakes, 440.  
Land tenure system, 452.  
Language, 491–498.  
Latins, 445.  
Law courts, 462.  
Leonardo da Vinci, 508.  
Liberation, war of, 490.  
Libraries, 461.  
Liguria, 437, 446.  
Literature, 498–516.  
Local government, 464.  
Lombardy, kingdom, 467; league, 473.  
Lorenzo de' Medici, 507.  
Machiavelli, 509.  
Magenta, battle of, 430.  
Manufactures, 453.  
Manzoni, Alessandro, 515.  
Maringano, battle of, 481.  
Marini, Giovan Battista, 511.  
Mazzini, 486.  
Medici, influence of, 479.  
Medici, Lorenzo de', 507.  
Mentana, Garibaldi's surrender at, 491.  
Metastasio, 513.  
Milan, recognition of the commune in, 470; duchy of, 478.  
Minerals, 442.  
Money, 466.  
Moiti, Vincenzo, 514.  
Mortality statistics, 449.  
Mountains, 434.  
Napoleon I., 485.  
Napoleon III., 490.  
National debt, 465.  
Navy, 458.  
Nicolini, 514.  
Nobility, 466; extinction of, 483.  
Norman invasion, 470.  
Northern Italy, 435.  
Novara, battle of, 488.  
Oenotrians, 443.  
Olive culture, 442, 451.  
Oscans, 445.  
Papacy, weakening of, the, 480.  
Parini, Giuseppe, 512.  
Parliament, 468.  
Peasantry, 455.  
Petrarck, 503.  
Pius IX., 489.  
Polish accession, 484.  
Population, 448.  
Postal system, 457.  
Prisons, 465.  
Provinces, modern, 448.  
Pucci, Antonio, 505.  
Pulci, Luigi, 507.  
Races, 443.  
Railways, 467.  
Ravenna, battle of, 481.  
Religion, statistics of, 458.  
Renaissance, 506.  
Revenue, 464.  
Revolutions (1820, 1830), 486; (1848), 488.  
Rienzi, 480.  
Rivers, 450.  
Riviera, 437.  
Rome, influence of, on Italy, 470; sack of (1527), 482; declared a republic (1849), 488.  
Sabines, 444.  
Samnites, 445.  
Sannino, 439.  
San Marino, 485.  
Saracen invasion, 470.  
Sardine fishery, 455.  
Sardinia, kingdom of, 489.  
Savonarola, 481, 508.  
Savoy, house of, 483.  
Savoy and Nice annexed to France, 490.  
Secentismo literature, 511.  
Schools, statistics of, 460.  
Sheep, 452.  
Shipbuilding, 457.  
Shipping, 457.  
Silk, 442, 453.  
Solferino, battle of, 490.  
Southern Italy, 439.  
Spain and France, rivalry of, 481.  
Spanish succession, 484.  
Statistics, 448–466.  
Tasso, 510.  
Telegraphs, 458.  
Territorial divisions, 448.  
Titles of honour, 466.  
Tobacco, 454.  
Topography, 434.  
Trade, 456.  
Trissino, Gian Giorgio, 509.  
Two Sicilies, 470, 478.  
Umbrians, 444.  
United Italy, 491.  
Universities, 461.  
Vegetable productions, 441.  
Vesetti, 447.  
Venice, power of, 474; republic of, 479; decline of, 484; restored to Italy, 491.  
Victor Emmanuel, 489.  
Vienna, congress of (1815), 485.  
Vine culture, 451.  
Visconti, rise of, the, 477.  
Vital statistics, 448.  
Volcanoes, 443.  
Volscians, 445.  
Woolen manufacture, 453.

ITHACA (Ἰθάκη), vulgarly Thiaki (Θιάκη), is next to Pasco the smallest of the seven Ionian Islands, with an area of about 44 square miles. It forms an eparchy of the nomos of Cephalonia in the kingdom of Greece, and its population, which was 9873 in 1870, is given by the census of 1879 at 12,222, of whom 6305 were males. The island consists of two mountain masses, connected by a narrow isthmus of hills, and separated by a wide inlet of the sea known as the Gulf of Molo. The northern and greater mass culminates in the heights of Anoi (2066 feet), and the southern in Hagios Stephanos, or Mount Marovugli (2135 feet). Vathy (Βαθύ), the chief town and port of the island, lies at the northern foot of Mount Stephanos, its whitewashed houses stretching for about a mile round the deep bay in the Gulf of Molo, to which it owes its name (*cf.* Dieppe and such Dutch names as Hollands Diep). As there are only one or two small stretches of arable land in Ithaca, the inhabitants are dependent on commerce for their grain supply; and olive oil, wine, and currants are the principal products obtained by the cultivation of the thin stratum of soil that covers the calcareous rocks. Goats are fed in considerable number on the brushwood pasture of the hills; and hares (in spite of Aristotle's supposed assertion of their absence) are exceptionally abundant. The island is divided into four districts:—Vathy, Aeto (or Eagle's Cliff), Anoge (Anoi) or Upland, and Exoge (Exoi) or Outland.

The name Ithaca (Ἰθάκη), like Utica, has been explained by ΠΙΛΥ, a "colony," which would point to a Phœnician connexion. It has remained attached to the island from the very earliest times with but little interruption of the tradition; though in Brompton's travels (12th century) and in the old Venetian maps we find it called Fale or Val da Compar, and at a later date it, not unfrequently appears as Little Cephalonia. This last name indicates the general character of Ithacan history (if history it can be called) in modern and indeed in ancient times; for the fame of the island is almost solely due to its position in the Homeric story of Ulysses. Ithaca, according to the Homeric epics, was the royal seat and residence of King Ulysses, and within its narrow limits lies the scene of much of the poem. The island is incidentally described with no small variety of detail, picturesque and topographical; but the very apparent definiteness of the description has rendered the process of identification peculiarly perplexing, and the coincidences between the Ithaca of the *Odyssey* and the Ithaca of the present day are sometimes as puzzling as the points of disagreement. The phraseology in which the position of the island is indicated is of doubtful interpretation, and the important word χαμαλί would have naturally been rendered "low-lying" if stress of present fact had not forced the commentators to find or fancy such significations as "with low shores" (the shores after all being rather unusually high) or "slanting downwards." The Homeric localities for which counterparts have been sought are Mount Neritos, Mount Neion, the harbour of Phoreys, the town and palace of Ulysses, the fountain of Arethusa, the cave of the Naiads, the stalls of the swineherd Eumeus, the orchard of Laertes, and the Korax or Raven Cliff. The master site may be said to be that of the town; and several of the minor points may be at once dismissed as hopeless of all certainty of recognition. Among the "identificationists" there are two schools, one placing the town at Polis on the west coast in the northern half of the island (Leake, Gladstone, &c.), and the other at Aeto on the isthmus. The latter site, which was advocated by Sir William Gell (*Topography and Antiquities of Ithaca*, London, 1807), has received a great accession to its probability as opposed to the rival theory by the excavations of Dr Schliemann carried on in 1873 and 1878 (see Schliemann, *Ithaque, le Péloponnèse, Troie*, Paris, 1869, also published in German; his letter to *The Times*, September 26, 1878; and the author's life prefixed to *Ilios*, London, 1880). He found that the valley called Polis or city has never been the site of a town, and that the apparent ruins on a neighbouring height supposed to be the acropolis are really a group of castellated rocks. Remains of Cyclopean structures at the spot known as Homer's school (a name of the most modern origin) were the only evidence in favour of the existence of a town in the northern part of the island. On the ridge of Mount Aeto, on the other hand, he found vast Cyclopean walls built of stones even larger than those of Mycenæ and Tiryns; and within the area which they enclose there may have been, he calculates, 2000 houses similar to those which he actually made out to the number of 190. Fragments of pottery of a Trojan type, of tiles with impressed ornaments, and of a curious handmill were the only relics of the former inhabitants. "In the south-eastern extremity of the island are a number of rooms like stables, averaging 35 feet in length and 10 feet in breadth, partly rock-cut, partly

formed by Cyclopean walls of very huge rudely wrought stones, and in their immediate vicinity thousands of very common but most ancient potsherds." Mr Bunbury (*Hist. of Ancient Geography*, vol. i. p. 83) is disposed to consider this evidence conclusive as to the site of the capital.

See, besides the works already referred to, the separate works on Ithaca by Schreiber, Leipzig, 1829; Rühle von Lilienstern, Berlin, 1832; N. Karavias Grivas (*Ἰστορία τῆς νήσου Ἰθάκης*), Athens, 1849; Bowen, London, 1851; and Gandar, Paris, 1854; Hercher, in *Hermes*, 1856; Leake's *Northern Greece*; Nure's *Tour in Greece*; Bursian's *Geogr. von Griechenland*; Gladstone, "The Dominions of Ulysses," in *Macmillan's Magazine*, 1877. A history of the discussions will be found in Buchholz, *Die Homerische Realien*, Leipzig, 1871.

ITHACA, the chief town of Tompkins county, New York, U.S., is prettily situated in a township of the same name on the Cayuga Inlet, 1½ miles from the southern end of Lake Cayuga, and 142 miles west by south of Albany. It is at the junction of several railways, has gas and water works, and carries on some commerce, of which the shipping of coal from the Pennsylvanian anthracite district forms an important constituent. The manufactures include agricultural implements, paper, glass, leather, and machinery. On an eminence to the north-east rise the handsome buildings of Cornell university, chartered in 1865 and opened in 1868, in which a marked characteristic is the prominence given to the study of agriculture and the mechanical arts. Sage College was presented to the university by the Hon. H. W. Sage, on condition that women should have the same advantages for education as men. The public library of Ithaca was built and stocked at a cost of £13,000 by the same munificent citizen whose endowment of the university is commemorated in its name. The neighbourhood of Ithaca is remarkable for the number of its waterfalls, of which Ithaca Fall, 160 feet high by 150 feet broad, is the chief. The population of the town in 1880 was 9864.

ITINERARIUM. This Latin word, equivalent to road-book, is more particularly employed to designate the descriptions still extant of the ancient Roman roads and routes of traffic, with the stations and distances. It is usual to distinguish two classes, *Itineraria Adnotata* or *Scripta* and *Itineraria Picta*,—the former having the character of a book, and the latter being a graphic indication of the route in the form of a chart. Of the *Itineraria Scripta* the most important are:—(1) *It. Antonini* (see ANTONINI ITINERARIUM and ANTONINUS), which consists of two parts, the one dealing with roads in Europe, Asia, and Africa, and the other with familiar sea-routes,—the distances usually measured from Rome (the better MSS. probably represent a revision dating from the time of Diocletian; edited by Tobler, St Gall, 1863); (2) *It. Hierosolymitanum* or *Burdigalense*, which belongs to the 4th century, and contains the route from Bordeaux to Jerusalem and from Heraclea by Rome to Milan (see Pindar in *Verhandl. of the Berlin Academy*, 1860; A. de Barthélémy in *Revue Archéol.*, 1864; Aurès, *Concordance des voies apollinaires*, &c., Nîmes, 1868); (3) *It. Alexandri*, containing a sketch of the march-route of Alexander the Great, mainly derived from Arrian and prepared for Constantius's expedition in 340–345 A.D. (first ed. by Mai, Milan, 1817, since by C. Müller in Dübner's *Arrianus*, Paris, 1846, and by D. Volkmann, Naumb., 1871; see Kluge, *De itin. Alexandri*, Berlin, 1861). A collected edition of the ancient itineraria was issued by Fortia d'Urban, Paris, 1845. Of the *Itineraria Picta* only one great example has been preserved. This is the famous *Tabula Peutingeriana*, which, without attending to the shape or relative position of the countries, represents by straight lines and dots of various sizes the roads and towns of the whole Roman world. The best edition is by Desjardins, Paris, 1868.

ITIUS PORTUS, a place of no importance in itself, has a kind of factitious interest as the point whence Julius Cæsar sailed from Gaul to Britain. Although Cæsar does not mention the Portus in speaking of his first expedition



(55 B.C.), his language in describing it as the naval rendezvous before his second invasion (54 B.C.) leaves little doubt that he had sailed from it before. To determine, therefore, the site of the Portus Itius, while it would decide one of the most vexed questions of either ancient or modern geography, would go far to fix the spot where the great captain first set foot in England. It is impossible here to describe the controversy, or to detail the arguments which at one time or another have been advanced in favour of every bay between Calais and Boulogne. Modern criticism selects four sites as probable—Boulogne, Wissant, Ambleteuse, and the mouth of the Somme. The first two number most adherents; and in recent criticism Wissant, about 3¼ miles north-east of Cape Grisnez (*Itium Promontorium*), has, united a majority of voices.

The question turns upon the interpretation of certain passages in Caesar's *De Bello Gallico* (iv. 20 sq., v. 1 sq.), with direct and indirect mentions in other Latin and Greek writers. See also Camden's *Britannia*, 1659; Du Cange, *Dissertation sur la Vie de Saint Louis*, diss. xxviii., "Portus Itius," 1678; D'Anville, "Dissertation sur le portus Itius," in *Mémoires de l'Académie des Inscriptions*, xxiii., 1761; Airy, "On the Place of Julius Caesar's Departure from Gaul, &c.," in *Archæologia*, 1862; papers by Airy and Guest in the *Athenæum*, 1851, 1859, 1863; by George Long in the *Reader of 1863*; by H. L. Long in *Gentleman's Magazine*, 1846; and an elaborate article by H. J. Heller in the *Zeitschrift für Allgemeine Erdkunde*, vol. xviii., Berlin, 1865; Thomas Lewin, *The Invasion of Britain by Julius Caesar*, 1862; Cardwell, "Remarks on Julius Caesar's Invasion of Britain," in *Archæologia Cantiana*, vol. iii.; Captain Bocher, "Caesar's Invasions of Britain: Nautical Conclusions on the place of his departure from Gaul, &c.," in *Nautical Magazine*, 1862; papers by F. de Sauley and General Creuly in the *Revue Archéologique*, 1860 and 1863; E. de Sauley, "Les Expéditions de César en Grande-Bretagne," in *Campagnes de César*, vol. i., 1862; Abbé Haigueré, *Etude sur le portus Itius de Jules César*, 1862; Von Göler, *Caesar's gallischer Krieg in den Jahren 58 bis 53 v. Chr.*, 1858; Id., *Caesar's gallischer Krieg im Jahre 51 v. Chr.*, 1860; H. L'empereur, "L'ancienne voie romaine d'Épéby," in *L'Institut*, 1864; and A. Wauter's brochure, *Wissant l'ancien Portus Itius*, Brussels, 1879.

ITURBIDE, or YTURBIDE, AUGUSTIN DE (1783–1824), emperor of Mexico from May 1822 to March 1823, was born September 27, 1783, at Valladolid, now Morelia, in Mexico, where his father, an Old Spaniard from Pampeluna, had settled with his creole wife. After enjoying a better education than was then usual in Mexico, Iturbide entered the military service, and in 1810 held the post of lieutenant in the provincial regiment of his native city. In that year the insurrection under Hidalgo broke out, and Iturbide, more from policy, it would seem, than from principle, served in the royal army. Possessed of splendid courage and brilliant military talents, which fitted him especially for guerilla warfare, the young creole did signal service, and rapidly rose in military rank. In December 1813 Colonel Iturbide, along with General Llano, dealt a crushing blow to the revolt by defeating Morelos, the successor of Hidalgo, in the battle of Valladolid; and the former followed it up by another decisive victory at Puruaran in January 1814. Next year Don Augustin was appointed to the command of the army of the north and to the governorship of the provinces of Valladolid and Guanajuato, but in 1816 grave charges of extortion and violence were brought against him, which led to his recall. Although the general was acquitted, or at least although the inquiry was dropped, he did not resume his commands, but retired into private life for four years, which, we are told, he spent in a rigid course of penance for his former excesses. In 1820 Apodaca, viceroy of Mexico, received instructions from the Spanish cortes to proclaim the constitution promulgated in Spain in 1812, but, although obliged at first to submit to an order by which his power was much curtailed, he secretly cherished the design of reviving the absolute power for Ferdinand VII. in Mexico. Under pretext of putting down the lingering remains of revolt, he

levied troops, and, placing Iturbide at their head, instructed him to proclaim the absolute power of the king. Four years of reflexion, however, had modified the general's views, and now, led both by personal ambition and by patriotic regard for his country, Iturbide resolved to espouse the cause of national independence. His subsequent proceedings—how he issued the *Plan of Iguala*, on February 24, 1821, how by the refusal of the Spanish cortes to ratify the treaty of Cordova, which he had signed with O'Donoju, he was transformed from a mere champion of monarchy into a candidate for the crown, and how, hailed by the soldiers as emperor Augustin I. on May 18, 1822, he was compelled within ten months by his arrogant neglect of constitutional restraints, to tender his abdication to a congress which he had forcibly dissolved—will be found detailed under MEXICO. Although the congress refused to accept his abdication on the ground that to do so would be to recognize the validity of his election, it permitted the ex-emperor to retire to Leghorn in Italy, while in consideration of his services in 1820 a yearly pension of £5000 was conferred upon him. But Iturbide resolved to make one more bid for power; and in 1824, passing from Leghorn to London, he published a *Statement*, and on May 11th set sail for Mexico. The congress immediately issued an act of outlawry against him, forbidding him to set foot on Mexican soil on pain of death. Ignorant of this, the ex-emperor landed in disguise at Soto la Marina on July 14th. He was almost immediately recognized and arrested, and on July 19, 1824, was shot at Padilla, by order of the state of Tamaulipas, without being permitted an appeal to the general congress. Don Augustin de Iturbide is described by his contemporaries as being of handsome figure and ingratiating manner. His brilliant courage and wonderful success made him the idol of his soldiers, though towards his prisoners he displayed the most cold-blooded cruelty, boasting in one of his despatches of having honoured Good Friday by shooting three hundred excommunicated wretches. Though described as amiable in his private life, he seems in his public career to have been ambitious and unscrupulous, and by his haughty Spanish temper, impatient of all resistance or control, to have forfeited the opportunity of founding a secure imperial dynasty. His son Augustin was chosen by the ill-fated emperor Maximilian as his successor.

See *Statement of some of the principal events in the public life of Augustin de Iturbide*, written by himself, English translation, 1824.

ITZEHOE, one of the busiest commercial towns of northern Germany, is situated on the Stör, a navigable tributary of the Elbe, in the circle of Steinburg of the Prussian province of Schleswig-Holstein, 32 miles north-west of Hamburg and 15 miles north of Glückstadt. As chief town of the circle, it is the seat of the usual local courts and of a head custom-house. The church of St Lawrence, dating from the 12th century, and the building in which the Holstein estates formerly met, are noteworthy. The town has a convent founded in 1256, a high school, a hospital, and other benevolent institutions. The sugar-refinery, which employs some 500 hands, is the largest in Germany. Iron-founding, shipbuilding, and wool-spinning are also carried on, and the manufactures include machinery, tobacco, fishing-nets, chicory, soap, cement, beer, and other articles. Fishing employs some of the inhabitants, and the markets for cattle and horses are important. A considerable trade is carried on in agricultural products and wood, chiefly with Hamburg and Altona. Including the garrison, the population in 1875 was 9776.

Itzehoe is the oldest town in Holstein. Its nucleus was a castle built to restrain the Danes in 809 by Egbert, one of Charlemagne's counts. The community which sprang up around it was diversely called Esseveldoburg, Eselsfletb, and Ezcho. In 1201 the town was destroyed, but it was restored in 1224. To the new town the Lübeck

rights were granted by Adolphus IV. in 1238, and to the old town in 1303. During the Thirty Years' War Itzehoe was twice destroyed by the Swedes, in 1644 and 1657, but was rebuilt on each occasion. It passed to Prussia in 1867, with the duchy of Schleswig-Holstein.

IVAN (or JOANN, *i.e.*, JOHN) I., grand-duke of Moscow from 1328 to 1340, was surnamed Kalita in allusion to the "purse" which he always carried at his girdle. Some have imagined that it contained alms for distribution; others with greater probability look upon it as characteristic of the miserly habits of the prince. The great importance of Ivan in Russian history is that he was the consolidator of the power of Moscow, the nucleus out of which the empire was to be formed at a future period. By treachery he procured from Uzbek, the Tatar Khan, the ruin of his rival the prince of Tver, and by craft and bribery made many additions to his territory. He also induced the metropolitan to reside at Moscow which brought dignity and influence to the city.

IVAN II., grand-duke from 1353 to 1359, son of Ivan I., succeeded on the death of his brother Simon Gordi, or the Proud. He appears to have been a kindly man, but, in so far as his short reign had any effect, it weakened the principality of Moscow.

IVAN III., surnamed the Great, grand-duke from 1462 to 1505, forms one of the most important figures in the annals of Russia, for to him is due the consolidation of the autocracy. His long reign of forty-three years was very beneficial to his country. He was a skilful diplomatist, and often brought about by intrigue what others could only effect by force of arms. Thus he reduced to submission the haughty republic of Novgorod, and united to the principality of Moscow those of Tver, Rostoff, and Yaroslavl; he also took Kazan in 1487, but it was not definitively incorporated with Moscow till the reign of Ivan IV. He reconquered the territory as far as the river Sozh, which had fallen under the dominion of the Lithuanians. In 1472 he married Sophia, niece of Constantine Paleologus. In consequence of this union Ivan considered himself the heir of the Byzantine emperors, and adopted the two-headed eagle for his arms. Embassies were sent to foreign powers. Italian architects were invited into Russia, and many learned Greek monks found refuge there from the yoke of the Turks.

IVAN IV., surnamed the Terrible (*Grozni*), the first czar of Russia, was a mere child at the time of the death of his father Vasili in 1533. His reign may be divided into three periods:—(1) his minority, under the regency of his stepmother Helen Gliuska; (2) from his attaining his majority till the death of his amiable wife Anastasia Romanova, during which time he was a bold and vigorous ruler, and careful of the happiness of his subjects; and (3) from her death till the conclusion of his reign in 1584, the period signalized by those atrocities which have earned for Ivan such an unenviable reputation. He was the first Russian sovereign who took the title of Czar, a Slavonic form of Cæsar. In 1552 he annexed Kazan, and Astrakhan two years later. In many points of his character Ivan resembles Louis XI., especially in his statecraft and superstition; indeed, just as France owed her aggrandizement to some of her most cruel sovereigns, so in Russia the greatest tyrants have been the consolidators of the empire. In the time of Ivan a printing press was set up at Moscow, and the first book published (in 1564) was an *Apostol*—a name given to a collection of the Acts of the Apostles and the apostolic epistles; but persecution was soon directed against the printers, who, from the jealousy of those who gained their livelihood by copying religious books, were compelled to fly from Russia, and were protected by Sigismund II. of Poland. They afterwards printed the whole Bible at Ostrog in Volhynia in 1581.

In the British Museum is a copy of this book, which formerly belonged to the terrible Ivan. Sir Jerome Horsey, the English ambassador, has written on the fly-leaf, "this Bibell in the Slavonian tongue had owt of the emperor's librari." Siberia was also annexed in this reign through the enterprise of the Cossack Yermak, and the English first opened up commercial intercourse with the country by means of the expedition of Sir Hugh Willoughby and Richard Chancellor in 1553. The English for a long time enjoyed the monopoly of the Russian trade, and it is to some of them that the Russians are indebted for interesting accounts of their land, especially to Dr Giles Fletcher, uncle of the dramatist, whose *Russe Commonwealth* (London, 1591) is a mine of valuable information. The atrocities committed by Ivan at Novgorod in 1569, and at Pskov soon afterwards, are well known. It is from foreigners, such as Horsey, that we get minute accounts of his many cruelties. In the British Museum are preserved some of his letters to Queen Elizabeth, of whom he requested that an English wife should be chosen for him and sent to Russia. A Lady Mary Hastings, daughter of the earl of Huntingdon, was selected and introduced to the Russian ambassador Pisemski, but when the time drew near for her departure she entreated her father with tears not to send her to such a husband. The miserable tyrant expired in 1584, from grief for his son, whom he had killed in a fit of passion three years before. Like Louis XI., he loved to surround himself with quacks and magicians, some of whom, according to Horsey, prophesied the day of his death. The latter has left us the following curious notice of him:—

"Thus much to conclude with this emperor Ivan Vasiliwiech. He was a goodlie man of person and presence, well favoured, high forehead, shrill voice, a right Sithian, full of readie wisdom, cruell, bloulye, merciless; his own experience mannged by direction both his state and commonwealth affaires; was sumptuously intomed in Michell Archangel church, where he, though garded daye and night, remains a fearful spectacle to the memory of such as pass by or hear his name spoken of, [who] are contented to cross and bless themselves from his resurrection againe."

IVAN V., czar from 1682 to 1696, was the son of Alexis by his first wife Maria Miloslavskaia. He was infirm both in mind and body. The Narishkins, to which family the widow of Alexis (his second wife) belonged, were anxious that Peter, the next brother, should succeed, but Sophia, the ambitious daughter of Alexis by his first wife, wished Ivan to rule, so that she might govern in his name. She was ultimately forced, however, into the Devichi monastery, and Ivan reigned conjointly with his brother, the government being really in the hands of Peter assisted by his mother, the Narishkins, Dolgoroukis, and Boris Golitzin.

IVAN VI., czar in 1740–41, was son of Anthony Ulrich of Brunswick by his marriage with Anne, granddaughter of Ivan V. The reign of this unfortunate young man lasted but a year, under the regencies of his mother and Biren. Owing to the success of the revolution under Elizabeth, daughter of Peter the Great, he was confined as a prisoner in Schlüsselburg, and Anthony and Anne with their other children were banished to Kholmogori in the government of Archangel. By long detention in the fortress Ivan became, it is said, half-witted. In the year 1764 a certain Lieutenant Mirovich attempted to deliver him from captivity and proclaim him emperor. Ivan, however, was slain in the skirmish that ensued, and Mirovich was afterwards publicly executed. According to some, he had been urged to the act by Catherine, who wanted an excuse for putting Ivan to death.

For the Ivans see Soloviev, *Istoriya Rossii*, 29 vols.; Oustrialov, *Rousskaya Istoriya*, 2 vols.; W. R. S. Ralston, *Early Russian History*; Rambaud, *Histoire de la Russie*.



IVANOVO, or IVANOVO-VOZNESENSK, the "Manchester of Russia," a town in the government of Vladimir, 20 miles north-west of Shua, near the river Uvod, and on the road from Shua to Nerakhta. It consists, as the full name implies, of what were originally two villages—Ivanovo, which existed at least as early as the 16th century, and Voznesensk, of much more recent date—united into a town in 1861. Of best note among the public buildings are the cathedral of the Elevation of the Cross, and the church of the Intercession of the Virgin, formerly associated with an important monastery founded in 1579 and abandoned in 1754. One of the colleges of the town contains a public library. The industrial history of Ivanovo begins with the 18th century. Linen-weaving was introduced in 1751, and in 1776 the manufacture of chintzes was brought from Schlüsselburg by some natives of the village. By 1850 the worth of the chintzes amounted to 6,680,875 roubles, and 10,000 workmen were employed in the manufacture of coarse calico. The reports of 1879 show 35 calico-print works, a wool-spinning factory, 6 cotton-weaving factories, 8 bleachworks, 6 iron-works, 3 chemical works, and several minor establishments. The workmen number about 15,000 or 20,000. The cotton factories produce to the annual value of 25,000,000 to 30,900,000 roubles; the iron works manufacture 110,000 poods (1770 tons) of iron, and there is a considerable turn out of boilers and factory machinery. Bast mats are made to the value of 15,000 roubles.

IVORY is essentially equivalent to dentine, that hard substance, not wholly unlike bone, of which most teeth principally consist. By usage, however, its application has become almost restricted to the dentine of those teeth which are large enough to be available for industrial purposes, viz., the tusks of the elephant, the hippopotamus, the walrus, the narwhal, and the sperm whales.

Ivory consists of an organic matrix or basis substance (which by prolonged boiling is converted into gelatin), permeated by an immense number of exceedingly fine canals. The matrix is richly impregnated with calcareous salts, which are probably held in some loose form of chemical combination with it, and is of such consistence that it retains its form after removal of the salts by an acid solvent. The canals start from the axial pulp cavity, and run in a direction generally outwards towards the periphery of the tusk; in the elephant they are of exceptional fineness, being only about  $\frac{1}{1500}$  of an inch in diameter, and are placed very closely, being separated by intervals not much greater than their own diameter. To the regularity with which the tubes are disposed, and to their small size and frequent curvature, ivory owes its fineness of grain, and probably also its almost perfect elasticity; whilst to the peculiarities of their curvatures it owes that very characteristic pattern of curved decussating lines, like engine turning, which is seen where the surface is a section transverse to the tusk. For, though it is broadly true that the tubes in elephant ivory run from the axis of the tusk to its periphery, they do not run straight, but make a succession of strong bends at regular intervals, and as the light is differently refracted by the basis substance and by the tubes according to the direction they are pursuing, this peculiarity of their course results in producing that pattern found in the dentine of *Proboscidea* only. Ivory differs from bone in its finer structure and greater elasticity, and in the absence of those larger canals which convey blood-vessels through the substance of bone, and appear upon it as specks or as stripes, according as it is cut transversely or longitudinally. When a transverse section of a tusk cut at a distance from the growing pulp is examined, its middle is seen to be occupied by a darkish spot of obviously different structure; this is the last remains of the pulp,

rudely calcified. The outer border of the section consists of a thick layer of cementum, with which the whole tusk is coated, and the rest is ivory, showing the characteristic engine-turning pattern, and, in addition to this, numerous circular lines, concentric with the central spot. These "contour" lines are due to the occurrence of a large number of minute irregular spaces, found in all dentine, but specially abundant and disposed with a greater regularity in ivory; they are known as interglobular spaces, from the form of their boundaries when seen under a moderate magnifying power. In the areas occupied by these spaces there is a smaller proportion of lime salts and more organic matter; consequently the ivory is here less dense and more liable to decomposition, and fossil tusks, as well as the less perfectly preserved of mammoth tusks, are frequently found to have broken up into a number of superposed cones, and in transverse section to present many concentric detached rings of ivory more or less friable. See Plate VII.

Arguing from the analogy of other dentine, it cannot be doubted that the minute tubes and the interglobular spaces are not empty in living ivory, but that they contain protoplasmic substance, though how far this may have perished or altered in that portion of the tusk which is extruded and far distant from the growing pulp can only be determined by observations at present wanting. According to Von Bibra's analyses, ivory contains as much as from 40 to 43 per cent. of organic matter, whereas human dentine contains only about 25 per cent.; of fat it contains from 24 to 34 per cent. It differs from other dentines chiefly in its richness in organic constituents, in the fineness of its tubes, in their peculiarly curved course, and in the abundance of interglobular spaces arranged in "contour" lines. The tusks of the elephant are a pair of upper incisor teeth, which may attain to an enormous development. The largest teeth were possessed by the extinct mammoths, of which tusks have been found in Siberia 12 feet and more in length, and weighing 200 lb each. Holzapfel mentions one of very fine quality, that was cut up into piano keys in England, which weighed 186 lb. Among recent elephants the African species possess the largest tusks, these attaining to a length of 9 or 10 feet and a weight of 160 lb each, whilst the tusk of an Indian elephant which measured 8 feet in length and weighed 90 lb has been placed on record as exceptionally large. A pair of African tusks at the London exhibition of 1851 weighed 325 lb, and measured 8 feet 6 inches in length and 22 inches in circumference; but authorities acquainted with the African ivory districts give 20 to 50 lb as the average weight of tusks. In Africa both males and females are furnished with large tusks; but in the Indian species a sexual difference exists, the tusks of the female projecting only a few inches from the gums, while even of the males by no means all are "tuskers." Sanderson says that 10 per cent. of Indian male elephants have very small tusks, while in Ceylon only one in three hundred of the males is powerfully armed. The peculiarity is not always transmitted, tuskless sires ("mucknas") breeding "tuskers," and vice versa. The importance of tusks as giving an advantage in combat to their possessors is sufficiently indicated by the dread of a "tusker" shown by other elephants less favoured. Tusks are often broken by fighting, and always show marks of considerable wear, while even captive elephants, with their shortened tusks, make great use of them for a variety of purposes; for example, an elephant will, when set to pull at a rope, take it between his molar teeth and pass it over one of his tusks to get a good purchase. Nothing but an extremely strong and elastic material such as ivory could withstand the strains to which it is constantly exposed.

Captive elephants have their tusks shortened, and the

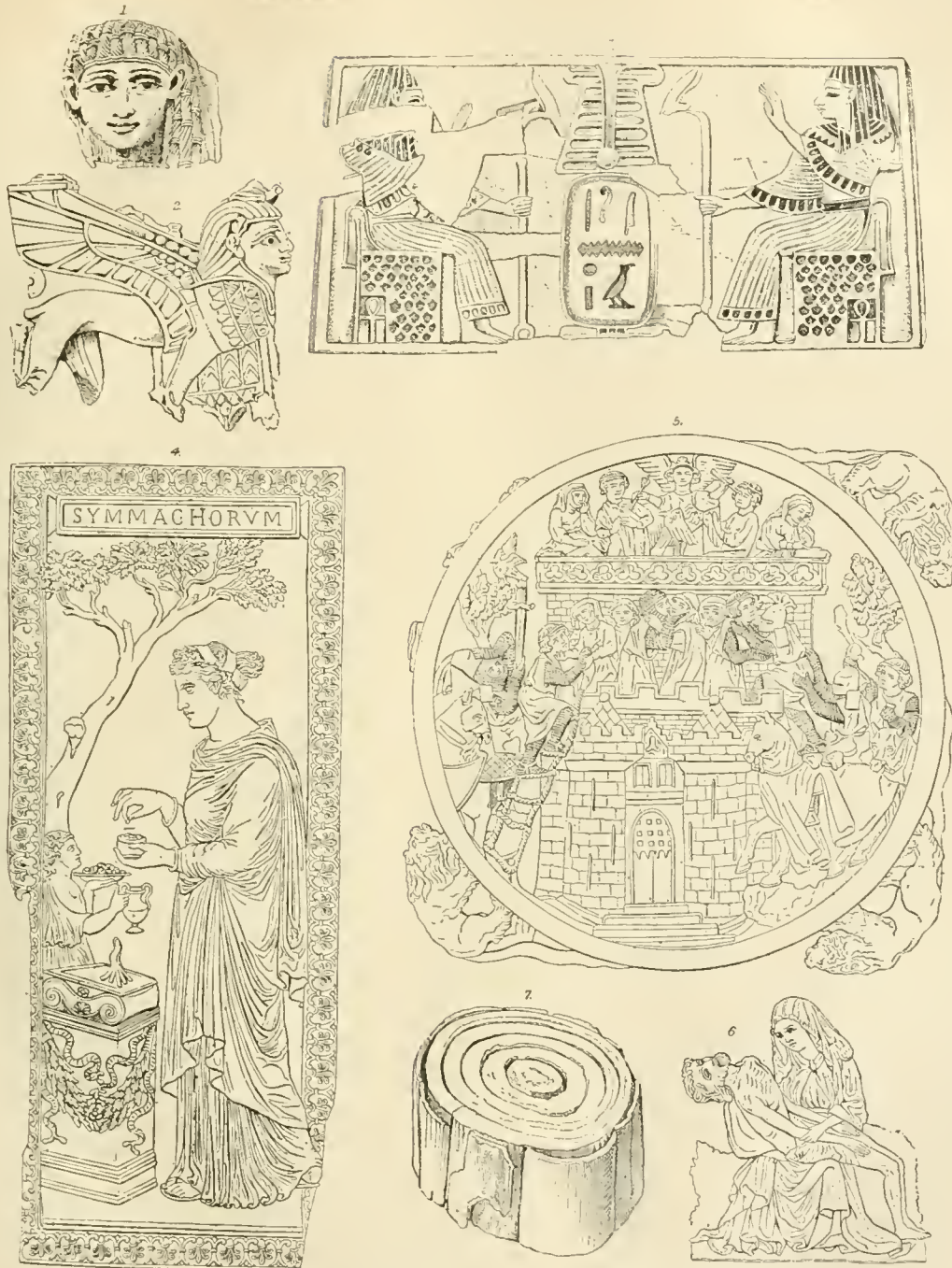

1 FEMALE HEAD IN HIGH RELIEF, NINEVEH COLLECTION, BRITISH MUSEUM  
 2 SPHINX IN HIGH RELIEF, NINEVEH COLLECTION  
 3 PLAQUE APPARENTLY USED FOR INLAYING, NINEVEH COLLECTION  
 4 LEAF OF A DIPTYCH, ROMAN, PROBABLY ABOUT 4<sup>TH</sup> CENTURY, SOUTH KENSINGTON MUSEUM COLLECTION

5 MIRROR CASE ILLUSTRATING STORMING OF THE CASTLE OF LOVE  
 FRENCH ABOUT 14<sup>TH</sup> CENTURY, SOUTH KENSINGTON MUSEUM  
 6 PIETA ABOUT 14<sup>TH</sup> CENTURY, BRITISH MUSEUM  
 7 SECTION OF DISINTEGRATED MAMMOTH TUSK.





ends bound with *areta* to prevent their splitting; and, as the tusk is continually growing by the conversion of fresh portions of vascular pulp into ivory, the operation has to be repeated. When this is done at intervals of ten years, the segment cut off is valuable, and is sold as ivory; some prefer, however, to cut the tusks much more frequently. In a young elephant the vascular pulp extends beyond the portion of the tusk implanted in the jaw, while in the older animal it does not reach so far; its probable extent has to be borne in mind in shortening the tusk, as if it be encroached upon much suffering is entailed on the animal. Yet the vascular formative pulp of an elephant's tooth is singularly tolerant of injury without having its function of ivory formation destroyed, and hence it happens that foreign bodies which have got access into the pulp chamber become solidly enclosed in ivory. The growing end of the tusk is widely open, and its edges are not much thicker than paper; the cavity which contains the pulp is of conical form, tapering to a point, which is situated at a distance down the tusk, varying, as has been before stated, with the age of the animal. The tusk grows by the conversion of successive portions of the surface of the conical mass of pulp into ivory, whilst fresh pulp is added at the flat base or open end of the tusk. The tusks are deeply implanted in curved bony sockets, which run nearly vertically upwards, so that the open growing ends of the tusks are brought up to about the level of the eyes. Hence it is not a rare occurrence for a sportsman's bullet, intended to pierce the elephant's brain, to penetrate the tusk near to its growing end, where the walls of the pulp cavity are quite thin, and to lodge in the "nerve" of its tooth. Indeed sportsmen remark that the forehead shot is less fatal to African than to Asiatic elephants, owing to the size and position of their tusks. The amount of disturbance produced by a bullet in the nerve is variable; sometimes the conversion of pulp into ivory goes on with but little interruption, so that the bullet comes to be imbedded in ivory, which fits closely up against it, instead of in pulp as it was at first. Generally the pulp immediately around it has been so disintegrated by its impact, or by subsequent inflammation, that it is incapable of conversion into normal ivory, and in its place there is a more or less irregular development of nodular secondary dentine. And sometimes there is a failure to produce even this less highly organized tissue in the immediate proximity of the bullet, which then ultimately comes to lie loose in an irregular cavity completely surrounded by secondary dentine. Of a similar nature is the so-called "abscess in ivory"; this was really an abscess in the formative pulp surrounded by a limiting membrane; as the conversion of the pulp into ivory went on, calcification passed all round the abscess and enclosed this, pus, membrane, and all, in solid ivory; and there it is discovered by the ivory cutter as an empty hole lined by a thin dried skin, the old abscess sac.

African natives sometimes spear elephants to death when they have been surrounded by an extemporized barrier of twisted creepers, and for this purpose some of them climb into trees; they also set traps made of a very heavy piece of wood shod with an iron spearhead, arranged to fall upon the elephant as he passes along a track beneath (Du Chailin); elsewhere lances of extreme length are used in the same way. The open base of the tooth, containing the formative pulp, looking directly upwards, a spear from above intended to fall upon the head or to "pith" the animal might easily enter it, and break away, leaving the point in the tooth pulp. In a specimen now in the museum of the Odontological Society, London, such a spear head remained without stopping the further growth of the tusk, and came to be solidly enclosed in ivory and secondary dentine, although it measures no less than  $7\frac{1}{2}$  by  $1\frac{1}{2}$  inches. Not a trace of

its presence was discernible upon the exterior of the tusk, and it was only discovered when the tooth was sawn up. This specimen is not unique, there being said to be another, which has been turned into a cup with the imbedded spear head as its stem; and there is a specimen of a javelin head firmly built in by ivory in the museum of the Royal College of Surgeons. But that an elephant is not wholly indifferent to a large foreign body in the nerve of his tooth is proved by the fact that a notoriously fierce and dangerous "rogue" elephant in Ceylon was found when killed to have been suffering from inflammation and suppuration consequent upon the presence of a bullet in the pulp of a tooth; the supposed madness of the famed elephant of Exeter Change was also found to have been due to the pain of a diseased tooth. A common result of injury to a growing tusk is the conversion of a portion of the pulp into irregular globular masses of secondary dentine,—sometimes enclosed solidly in the midst of normal ivory, sometimes forming loose masses as big as hen eggs in the pulp cavity, and sometimes stalagmite-like appendages to its walls. Of course such deviations from normal structure seriously injure its value for industrial purposes, and they are specially apt to occur in domesticated animals whose tusks are being repeatedly shortened, the cut not being invariably made at a sufficient distance from the apex of the living pulp. But under no circumstances is the ivory from domesticated elephants so highly esteemed as that from the wild animal.

The large balls of secondary dentine appear on section as a conglomerate of spherical masses bound together by softer and looser-textured materials; they are sometimes beautiful, but cannot be made much use of. Small spots of globular dentine sometimes occur in the midst of normal ivory, for which no cause can be detected. Malformed tusks are far from rare; the College of Surgeons possesses one about 2 feet in length, the base of which is an irregular mass of osteodentine nearly as large as a man's head. Spiral tusks are also met with, and are almost always the result of some disease of one side of the pulp, leading to a slower growth on the one side than on the other. Much of the ivory of such tusks will be faulty; they should not be purchased except as curiosities.

The Board of Trade returns for 1879 give as the total weight of ivory imported into England during the year 9414 cwt., of the value of £406,927;<sup>1</sup> but nearly half this quantity appears again amongst the exports. By far the larger portion of the ivory is entered as coming from African ports, and less than one-fourth from India, while from this fourth a further reduction must be made in estimating the quantity produced by the country, as a considerable weight of African ivory from Zanzibar, &c., is shipped from Bombay. About 1080 cwt. is entered as "from other countries."<sup>2</sup>

The best ivory is the African, and the first quality of that comes from near the equator; much is brought down by natives by land from the interior, whilst in other districts expeditions are organized by Europeans to go into the interior, and collect the stores gathered by native tribes; 20,000 lb, valued at Khartoum at £4000, would be considered a good result for a season's expedition with one

<sup>1</sup> The imports vary considerably from year to year. In 1875 they amounted to 16,253 cwt., valued at £772,371.

<sup>2</sup> Westendorp states that Africa exports on an average about 15,550 cwt. a year, which would be worth from £600,000 to £750,000, and that the ivory trade is steadily growing, especially on the West Coast. He estimates that in the west not less than 51,000 elephants are killed annually, and anticipates their becoming less numerous. Although the export from India only reached in 1875-7 from 9000 to 17,000 lb a year, a considerably larger quantity of ivory is used in India for arm rings, &c., and for decorative and ornamental purposes. China also deals in ivory, exporting most of it after it has been carved.



hundred and fifty men. The price of ivory varies much in different districts, being generally higher on the west than on the east coast; the transaction is generally one of barter, and the price therefore difficult to estimate. The tusks are sold by weight, and stones and iron are sometimes thrust down into the hollow pulp cavity to increase the weight, so that dealers generally feel down the hollow with an iron rod to detect foreign matter. The value of the ivory depends upon the size of the tusks; those below 6 or 7 lb weight are not worth more than half the price per lb of really fine tusks. Something depends on the care bestowed upon the tusks, which are sometimes roughly treated, while others are waxed and carefully wrapped up for protection. The African ivory trade is an ancient one, and in mediæval times Marco Polo speaks of the traffic in ivory at Zanzibar as being astonishing in its amount.

The tusks of the mammoth from northern Siberia are said to furnish almost the whole of the ivory used by Russian ivory workers. They are found in most extraordinary abundance, and it is said that from the time of Dr Breyne's quaint paper "Behemoth" in the *Philosophical Transactions* for 1737 till now there has been no intermission in the supply. They come principally from the neighbourhood of the Lena and other great rivers discharging themselves into the Arctic Ocean, and are abundantly found in the Liakhoff Islands. Mammoth tusks are slenderer, much more curved, and in proportion to the size of the animal much larger than those of recent elephants. In Siberia at different times four mammoths have been found entire, their hair, skin, and even all their soft parts having been preserved without change in the ice for countless years. Just as in some few cases all the most perishable soft parts were preserved, so in a vastly greater number the less perishable ivory was kept without change by the low temperature and exclusion of air: thus when in the summer the ice tears down portions of river banks, or floods break up frozen morasses, the tusks are brought to light. Some are in the most beautiful preservation, like recent ivory; others having been exposed before, in previous summers, their organic constituents have partly perished, and they are inclined to become broken up along the lines of interglobular space into concentric rings, or may have become so disintegrated that a fragment may be used like chalk to write with.

In England this ivory is not very highly esteemed, being considered too dry and brittle for elaborate work, and to be very liable to turn yellow. Most ivory workers strenuously deny ever using them, but, though more rarely than in former years, mammoth tusks are occasionally imported. Within the last few years an exceptionally large tusk in splendid condition was offered for sale to the Oxford University Museum at a price of £100, but was not purchased. In 1872 1630 very fine tusks were brought to England; and in 1873 1140 tusks weighing from 140 to 160 lb each were imported. The best were sold at a very good price, but proved less available, even for such purposes as cutting into koife handles, than was expected, and although smaller importations arrive from time to time they can hardly be considered as a regular article of commerce, and are difficult of sale; some have been very recently sold at a price so low as ten shillings a cwt. Westendarp personally investigated the Siberian ivory trading districts, and returned with no favourable impression. He found that about 14 per cent. of the teeth were good, 17 per cent. could be made some use of, 54 were quite bad, and 15 wholly useless. The ivory looks better outside than it really is, and, as only about 30 per cent. is usable, it does not pay well for transport. He thought it not worth more than 1s. 6d. a pound.

The finest quality of ivory from equatorial Africa

is closer in the grain, and has less tendency to become yellow by exposure than Indian ivory. When first cut it is semi-transparent and of a warm colour; in this state it is called "green" ivory, and as it dries it becomes much lighter in colour and more opaque. This is supposed to be the result of the drying out of the "oil"; but ivory contains less than one-half per cent. of fatty material, and that which dries out is water, not oil. During this drying process the ivory shrinks considerably, so that it is necessary to season it like wood when such things as box lids, which need to fit, are to be made from it. The tusks shrink much more in their width than in their length, which will be readily understood when the many concentric rings of interglobular spaces, containing soft material, which dries up and leaves them empty, are remembered. It is on account of this peculiarity of structure that billiard balls are turned from tusks not greatly exceeding them in diameter, for by the selection of such tusks the ivory on the opposite sides of the ball will correspond in density and in structure, and the shrinkage will be uniform about its centre. They are usually turned roughly into shape, kept for some time in a warm room to shrink, and then turned true. The thin plates cut for piano keys are dried and shrunk at once by being baked for a time in an oven, but after being dried they are still subject to changes in bulk in a moist atmosphere.

It is not always possible to judge of the quality of ivory before the tusk is cut up. The exterior, or cementum, should be smooth and polished; it is often of a deep coffee colour in the best tusks, and it should not show any large cracks. But the most profound disorganization of the ivory may exist inside an exterior which promises well, or it may be badly cracked from unequal shrinkage in drying without cracks being noticeable on its exterior. About half of the length of an average sized tusk is implanted; this will be hollow, and in a young animal the hollow will extend beyond the implanted portion; the extruded part, recognizable by the deeper colour of its cementum, is solid, and is circular or oval in section. Great care is taken by ivory cutters to cut up the tusk to the greatest advantage, its high price necessitating the strictest economy in its use. Veneers of large size have been cut by a reciprocating saw cutting a spiral shaving round the tusk, one having been thus produced 40 feet in length by 12 inches in width; but they are not of much practical value, save as an example of what is possible. With age ivory turns yellow, and various receipts are given for restoring its whiteness; but they mainly depend upon mere removal of the outer surface, and no satisfactory method of bleaching it is known; it preserves its colour best when exposed to light. Considering the high percentage of organic matter which it contains, it is surprisingly durable. In some of the ivories brought by Mr Layard from Nineveh, in which the organic constituent had partially perished, leaving them very friable, its place was supplied by boiling them in a solution of gelatin, a process suggested by Professor Owen as the likeliest means of restoring to them something like what they had lost during the lapse of time by exposure. It is possible that by some such treatment the perished ivory of the mammoth may be rendered useful for some purposes. The existence of chryselephantine statues of Phidias, and of flat plaques of ivory larger than could be cut from any known tusk, renders it probable that ancient workers possessed some method of bending it; and receipts have come down from the 12th century for softening it so as to alter its form. But these, which depend upon its partial decalcification, have not been found to yield the excellent results claimed for them, and the larger plaques in question present no appearance of having been submitted to any such process. Moreover, Westendarp states that

from a tusk weighing 200 lb the largest plaques he knows of could have been cut. \* Ivory can be made flexible by submitting it to the solvent action of phosphoric acid; when washed and dried it becomes hard, and when moistened again it resumes its flexibility; but this is at the sacrifice of many of its properties.

Ivory takes a variety of dyes well, without interfering with the polish of its surface; the actual matrix is stained, and the colour is not merely due to the penetration of pigment into the open dentinal tubes.

The great canine teeth of the hippopotamus furnish an ivory which is harder and whiter than that of the elephant, and less prone to turn yellow; these differences are probably due to its containing a smaller percentage of organic matter. It also lacks the engine-turning pattern of elephant ivory. The tusk of the hippopotamus is a tooth of persistent growth, strongly curved into a segment of a circle, and solid in the greater part of its length. It is thickly coated with enamel on its exterior surface, and is trihedral. On transverse section the remains of the pulp cavity are seen as a line or fissure in the middle, and occasionally there is a nodule of secondary dentine in it. The ivory is not quite homogeneous; for the back of the tooth, which is not covered with enamel and in use wears down the fastest so as to keep a sharp edge to the tusk, is markedly softer than the rest of the tooth. No large piece can be obtained from a hippopotamus tusk, and the incisors and the upper canines yield even smaller pieces than the lower canines. Thirty years ago there was a considerable demand for them for dentists' use, and at that time a fine tusk of 5 lb weight was worth from five to seven guineas, but the price is now much lower, and comparatively few are imported.

Amongst the northern nations the tusks of the walrus have long been used as a source of ivory. The great upper canines consist of a body of dentine invested with cementum; they are oval in section, solid, and their axis is made up of secondary dentine, which is far larger in amount than in the hippopotamus, and makes up a considerable part of the whole tooth. This is very nodular in appearance when cut and polished, but is of dense and tolerably uniform consistence.

The spirally twisted tusk of the narwhal, the teeth of the sperm whales, the ear bones of whales, and the molar teeth of the elephant, are also all made use of as sources of ivory, though they are far less valuable than the larger tusks. For the subject of carvings in ivory, see CARVING, vol. v. p. 167. The earliest piece of ivory work known is a rude incised drawing of a mammoth upon a fragment of mammoth tusk, which must have been executed by a contemporary of the animal. Numerous references to ivory occur in the Old Testament, which show that it was regarded as of great value. It seems to have been used for the decoration of the temple, and it is often mentioned amongst the presents brought to kings, who employed it for purposes of regal state. Some, however, of the references would seem more strictly applicable to wood than to ivory.

The Nineveh ivories in the British Museum are of very great antiquity, a probable date of 900 B.C. having been assigned to them; yet many of them are in good preservation, and others have been tolerably well restored by boiling in gelatin. All exhibit considerable artistic merit and mastery over the material, whilst some reach a very high degree of excellence alike in design and execution. Competent judges declare that, underlying the obviously Egyptian character of the work, there are differences sufficient to lead to the inference that the ivories were not executed in that country. Some of them consist of thin plaques on which figures were delineated by means of incised lines; some were carved in low, and others in high

relief; whilst there are many examples of detached heads, and even entire figures, carved in close imitation of nature (see Plate VII.). Traces of gilding remain on many of them, and they were often further enriched by being inlaid with fragments of lapis lazuli, or of a coloured glass in apparent imitation of this; the eyes of the larger heads were generally rendered conspicuous by this means. In one of the panels figured, the border of the dresses, the thrones on which the figures are seated, the ornaments above the cartouche, and the symbols upon the cartouche itself were thus inlaid with colour. The largest object is a carved staff, perhaps a sceptre; amongst the smaller pieces are heads of animals and entire animals, griffins, human heads, crossed and clasped hands, rings, &c. Like the ivory carvers of later times, these early workers seem to have studied economy of their material; thus a beautiful carving in high relief of two griffins standing upon papyrus flowers has been carved on the interior of a segment of a large tusk, the natural curvature of which it follows. The tendency of ivory to decompose into concentric layers parallel with its exterior has been already noticed, and Mr Layard himself speaks of the trouble he experienced owing to the flaking of the pieces he discovered; it is by the separation along the contour lines that many ancient ivories have been spoiled. Besides those discovered at Nineveh, some other ivories of great antiquity exist; and ivory workers are mentioned as a distinct class of artificers at the commencement of the Christian era. Many writing tablets of ivory, with raised rims inside, where wax was spread over their surface, have come down to us; these were often made to fold together, and the exterior richly ornamented with carvings. † It was the custom for newly appointed consuls under the empire to send these plaques to persons of importance, and the covers sometimes have upon them representations of the consul in his robes of office.

One of the most beautiful of ancient ivories is the Roman 3d century plaque purchased by the South Kensington Museum for £100 (see Plate VII.). It forms one half of a diptych, and measures  $11\frac{3}{4}$  by  $4\frac{3}{4}$  inches. ‡ The other half is in the Hôtel Cluny.

From these times down to the present day there has been a constant succession of ivory workers, though in mediæval times artists of higher ability were to be found than any who will now devote themselves to such work. A large proportion of the carvings deal with sacred subjects: one of the most beautiful is a Pieta, the virgin holding the dead body of Christ in her lap (see Plate VII.); this was executed about the 14th century. Illustrations of old romances were frequently made use of to decorate mirror cases, boxes, &c., and elaborately carved chessmen of walrus ivory referable to an ancient period have been found in the island of Lewis. Schlicmann, in his excavation at the supposed site of Troy, found many useful articles made of ivory,—pins, buckles, &c.,—but no carvings, even of rude character.

Among the chryselephantine statues of ancient Greece executed by Phidias, Praxiteles, and others, one of Minerva in the Parthenon was 40 feet in height, and was constructed of ivory and gold; others are mentioned as made of wood, with face, hands, and feet of ivory. § Yet in some cases it is expressly said that the statue was entirely of ivory, special exception being made of a portion of the dress which was not. Among the Nineveh ivories are some which apparently belonged to figures partly wood and partly ivory, but these were of no great size; the wood employed seems to have been ebony.

In former times ivory was frequently used for the manufacture of artificial teeth; but this has become a thing of the past, ivory having been superseded by more durable and more manageable materials. Its use for this purpose



is quite ancient; thus Martial contemptuously speaks of a lady of his own time "emptis ossibus iadicoque cornu" as having but a poor chance of passing them off as her own teeth. For the use of the dentist elephant ivory was less suitable than that of the hippopotamus or the walrus; of these two the former was generally preferred. The enamel was chipped off with a chisel, or made to fly off by a judicious application of a blowpipe flame, and the tusk was so cut that the plate might consist as far as possible of the hardest part of the dentine which had formed the front of the tooth. This, carved up to fit the mouth accurately, formed a supporting plate which commonly carried in the front actual human teeth secured by pins, though sometimes the teeth were formed of ivory carved in imitation of teeth, and at the back blocks of hippopotamus or walrus ivory were added for the purposes of mastication. They were called "bone pieces," though there was really no bone used in their construction; their durability was in no case great, though it varied in the mouths of different persons, and a plate had to be ultimately discarded on account of the ivory getting discoloured, softened, and offensive. For dental purposes walrus ivory was more durable than hippopotamus, but its colour was not so suitable, nor was it so hard. Some specimens of native Indian dental work in ivory exist, but these have probably been copied from plates worn by Europeans.

The principal demand for ivory, beyond the purposes already alluded to, arises in connexion with the cutlery trade, very large quantities being used for the handles of pocket and table knives. It is also extensively employed for the handles of walking sticks and umbrellas, for combs, paper knives, and ladies' fans, and for measuring rules and mathematical scales. Further, it is in considerable demand for the manufacture of chess and draughts men, for statuettes, rilievo plaques, caskets, and many minor objects of furniture, decoration, and ornament, and for the purposes of inlaying. Dieppe is now a principal centre of the European ivory manufacture.

But it is in the East, and especially in China, that ivory is now most highly prized and most elaborately worked into decorative forms. No amount of patience and care appears to be considered excessive among the Chinese for the decorative working of ivory, as is obvious in the extremely minute and delicate workmanship in their lacelike carved open-work trays, while their carved nests of concentric ivory balls are still reckoned among the puzzles of industry. By the Japanese ivory is equally held in esteem, and is decoratively treated in their peculiar manner in the form of spill cases, medicine boxes, and the elaborately carved and ornamented nitsuké or large buttons. In India ivory is extensively used in the inlaid work of Bombay, &c., and for furniture decoration generally; and it is also cut into long slender filaments for making the tails of state chowries or fly-flappers, which, both handle and tail, are in many instances made of ivory.

All ivory dust, chips, and pieces unsuited for working are utilized by being converted into gelatin, which they may be made to yield by prolonged boiling, or by being calcined into ivory black. Confectioners are said to make use of ivory dust as a basis for soups, and it forms an excellent colourless size, employed for delicate purposes. When ivory is calcined in a close chamber, in which there is not enough oxygen to burn the carbon into carbonic acid, the organic matrix is burnt into carbon with which remain in the most intimate admixture the lime and magnesium salts which had previously hardened it. Strange to say, the calcined ivory retains its form and texture notwithstanding the destruction of the organic matrix, and specimens sometimes show the engine-turning markings on the cut surface with the utmost distinctness. It is an

animal charcoal of great purity, and owes its delicacy and particular properties to the extremely fine division of the carbon particles. When ground up and mixed with appropriate media, it affords both to the oil and the water-colour painter a most valuable black pigment; it is also used as an ingredient in the fine printing ink used for engravings and etchings.

Attempts have been made to manufacture an artificial ivory, but with no very satisfactory result. Billiard balls and other small objects have been manufactured of celluloid, a combination of gun cotton and camphor with ivory dust, which becomes plastic at a temperature of about 250°, and when cold is again quite hard and somewhat translucent. Plaster copies or reproductions of artistic ivories are prepared, under the name of fictile ivories, by casting in very fine plaster of Paris tinted with yellow ochre, and subsequently treating the surface with a mixture of wax and spermaceti or stearine. But it may fairly be said that for the purposes to which ivory is ordinarily applied no substitute approaches it either in beauty or in those other qualities which render it so agreeable and so satisfactory a material for the workman, whether carver, turner, or miniature painter.

See Dr Brayne, *Phil. Trans.*, 1737; Owen, "On the Ivory and Teeth of Commerce," in *Journ. Soc. of Arts*, 1856; Lye, *Principles of Geology*; Boyd Dawkins, *Cassell's Natural History*, vol. ii.; C. S. Tomes, *Dental Anatomy*; Catalogue of Hunterian Museum, Royal College of Surgeons; Holzapfel, *Turning or Mechanical Manipulation*; *South Kensington Handbooks*. "Ivories" Colonel Yule's *Marco Polo*; Du Chailu, *Equatorial Africa*; Burton, *First Footsteps in Eastern Africa*; Tennent, *Island of Ceylon*; Bowring, *Kingdom of Siam*; Westendorp, *Mittheil. der geograph. Gesellschaft*, Hamburg, 1878-9; Jayard's *Ninneeck and its Remains*. Schliemann's *Ilios*. (C. S. T.)

**IVORY, VEGETABLE.** The plant yielding the vegetable ivory of commerce is known to botanists as *Phytolophus macrocarpa*, Ruiz and Pavon. It is a native of South America, occurring chiefly on the banks of the river Magdalena, Colombia, always found in damp localities, not only, however, on the lower coast region as in Darien, but also at a considerable elevation above the sea. It is mostly found in separate groves, not mixed with other trees or shrubs, and where travellers tell us even herbs are rarely met with, "the ground appearing as if it had been swept." The plant is severally known as the "Tagua" by the Indians on the banks of the Magdalena, as the "Anta" on the coast of Darien, and as the "Pullipunta" and "Homero" in Peru. It is a stemless or caulescent palmlike plant, the top of which is crowned with from twelve to twenty very long pinnatifid leaves. The plants are dioecious, the males forming higher, more erect, and robust trunks than the females. The male inflorescence is in the form of a simple fleshy cylindrical spadix covered with flowers; the female flowers are also in a single spadix, which, however, is shorter than in the male. The fruit consists of a conglomerated head composed of six or seven drupes, each containing from six to nine seeds, and the whole being enclosed in a walled woody covering forming altogether a globular head as large as that of a man. A single plant sometimes bears at the same time from six to eight of these large heads of fruit, each weighing from 20 to 25 lb. In its very young state the seed contains a clear insipid fluid, which travellers take advantage of to allay thirst. As it gets older this fluid becomes milky and of a sweet taste, and it gradually continues to change both in taste and consistence until it becomes so hard as to make it valuable as a substitute for animal ivory. In their young and fresh state the fruits are eaten with avidity by bears, hogs, and other animals. The seeds, or nuts as they are usually called when fully ripe and hard, are used by the American Indians for making small ornamental articles and toys. They are imported into Britain in

considerable quantities, frequently under the name of "Corozo" nuts, a name by which the fruits of some species of *Attalea* are known in Central America,—their uses being chiefly for small articles of turnery. The question of the position of this plant in the vegetable kingdom is one upon which botanists have been much divided. The plant has at different times occupied the attention of such well-known botanical authorities as Ruiz and Pavon, who gave to it its scientific name of *Phytelphas macrocarpa*, and of Martins, Morren, Humboldt, Bonpland, Spruce, and others, by whom it has been considered respectively to be near to the *Palmeæ* or the *Pandaneæ*, or to belong to a separate and distinct order, the *Phytelphasieæ* of Brongniart. This order is now placed by Le Maout and Decaisne between *Palmeæ* and *Pandaneæ*, and *Phytelphas* is of course retained in it as the type,—one other genus only, that of *Wettinia*, being included.

IVORY, JAMES (1765-1812), a Scottish mathematician, was born in Dundee in 1765. In 1779 he entered the university of St Andrews, where after four years study he graduated M.A., distinguishing himself especially as an ardent and successful student of mathematics. He then entered on a regular course of theological training; but, after two sessions at St Andrews and one at Edinburgh, he abandoned all idea of the church, and in 1786 settled in his native town as assistant-teacher of mathematics and natural philosophy in a newly established academy. Three years later he became partner in and manager of a flax-spinning company at Douglastown in Forfarshire, still, however, prosecuting in moments of leisure his favourite studies. He was essentially a self-trained mathematician, and was not only deeply versed in the ancient and modern geometry, but had also, what was extremely rare in his country in those days, a full knowledge of the analytical methods and discoveries of the Continental mathematicians. His earliest memoir, dealing with an analytical expression for the rectification of the ellipse, is published in the *Transactions of the Royal Society of Edinburgh* for the year 1796; and this and his later papers on "Cubic Equations" (1799) and "Kepler's Problem" (1802) evince great facility in the handling of algebraic formulae. In 1801 after the dissolution of the flax-spinning company of which he was manager, he obtained one of the mathematical chairs in the Royal Military College at Marlow (afterwards removed to Sandhurst); and till the year 1816, when failing health obliged him to resign, he discharged his professional duties with remarkable success. During this period he published in the *Philosophical Transactions* several important memoirs, which earned for him the Copley medal in 1814, and ensured his election as a Fellow of the Royal Society in 1815. Of special importance in the history of attractions is the first of these earlier memoirs (*Phil. Trans.*, 1809), in which the problem of the attraction of a homogeneous ellipsoid upon an external point is reduced to the simpler case of the attraction of another but related ellipsoid upon a corresponding point interior to it. This beautiful theorem is known as Ivory's theorem. His later papers in the *Philosophical Transactions* treat of astronomical refractions, of planetary perturbations, of equilibrium of fluid masses, &c. For his investigations in the first named of these he received a royal medal in 1826 and again in 1839. In 1831, on the recommendation of Lord Brougham, King William IV. granted him a pension of £300 per annum, and conferred on him the Hanoverian Guelphic order of knighthood. His more purely scientific honours sufficiently prove the high position he held among his contemporaries. Thus, besides being directly connected with the chief scientific societies of his own country, the Royal Society of Edinburgh, the Royal Irish Academy, &c., he was corresponding

member of the Royal Academy of Sciences both of Paris and Berlin, and of the Royal Society of Göttingen. He died September 21, 1842.

IVORY COAST, that part of the West African seaboard which lies between the Grain Coast (now almost all belonging to Liberia) and the Gold Coast, or between Cape Palmas on the west and the Assini river on the east. Slightly different limits are assigned by different writers, and part of the territory which belongs to the traditional Ivory Coast is now officially incorporated in the Gold Coast region, the western limit of which is placed at 5° W. long., a good way to the west of the Assini river. In the older books of travel (both English and foreign) we often find the alternative names Tooth Coast (*Zahn-Küste*) or Quanza Coast, and less frequently the coast of the five and six stripes (alluding to a kind of cotton fabric in favour with the natives). The trade in ivory has long lost its importance, and at the present day there are very few European trading stations in this part of Guinea. Fort Nemoir, Grand Bassam, Piccaniny Bassam, Drewin, and Walloo are the chief points of interest.

IVREA, the ancient *Eporedia*, a town of northern Italy, capital of a district of the same name, is situated at the foot of the Alps on an eminence at the southern extremity of the beautiful and luxurious Val d' Aosta, near the river Dora Baltea, and at the termination of a branch railway line from Chivasso, 29 miles north-north-east of Turin. It is irregularly built, and has an antique and picturesque appearance. The site of the old fortifications is now occupied by promenades. The town possesses an old citadel with three lofty brick towers; a cathedral, supposed to occupy the site of a temple of Apollo; an ecclesiastical seminary, a gymnasium, and several convents and benevolent institutions. The river is crossed by a Roman bridge of one arch. There are important silk manufactures, and a considerable trade in cheese, cattle, and other produce of the Alps. The population of the town in 1871 was 5093.

Ivrea occupied the site of the old Roman Eporedia, which originally belonged to the Salassi, and received a Roman colony about 100 B.C., founded in accordance with the directions of the Sibylline books. It afterwards became the seat of the Longobardian dukes, and on the conquest of the Longobards by Charlemagne it was made the capital of a marquisate. In 950 Berenger II. of Ivrea succeeded in mounting the Italian throne, but he held this position for only a short time. His grandson Otto became the founder of the line of the dukes of Burgundy. Arduin, marquis of Ivrea, again aspired to the throne of Italy after the death of Otto III. in 1002, and also disputed the possession of the imperial dignity with Henry II. but was defeated by Henry in 1003, after which Ivrea was incorporated with the empire. In 1248 the town and marquisate were given to the counts of Savoy. The town was occupied by the French in 1554, 1641, and 1704. In 1796 they again made themselves masters of it; and, after losing it for some time, they reacquainted it in 1800, and held it till 1814, making it the capital of the department of Doire.

IVRY-SUR-SEINE, a town and commune of France, in the arrondissement of Sceaux and the department of Seine, is situated near the left bank of the river Seine, 4 miles south-east of Paris. It has an interesting old church, but of the castle of the 17th century the fine gardens are the chief memorial. In the Petit Château died the duchess of Orleans, mother of Louis-Philippe. Ivry manufactures cordage, organs, glass, matches, manure, and chemicals. There are numerous handsome villas and fine gardens in the neighbourhood. The population in 1876 was 15,247.

Ivry-sur-Seine is of ancient foundation. In a charter of Louis IV. (D'Outremer), its name appears as Ivriacum, and in contemporary documents as Ivriacum. The fort of Ivry played an important part in the defence of Paris against the Germans in 1870-71, and in the Communist struggle of the latter year. Ivry-la-Bataille, in the department of Eure, where Henry IV. won his victory over the Leaguets in 1590, is not to be confounded with Ivry-sur-Seine.



IVY (A. S., *Ifig*; Germ., *Epheu*; perhaps connected with *apium*, ἄπιον) is the collective designation of certain species

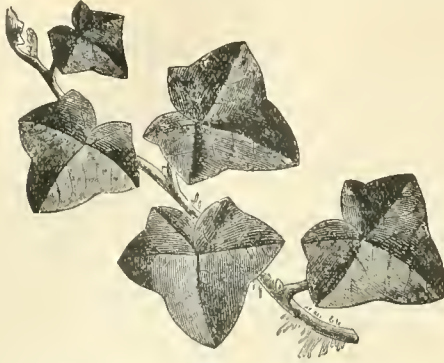

FIG. 1.—European Ivy (*Hedera Helix*). Half nat. size. and varieties of *Hedera*, the important alliances of which are *Aralia* and *Panax*, which, with some twenty other

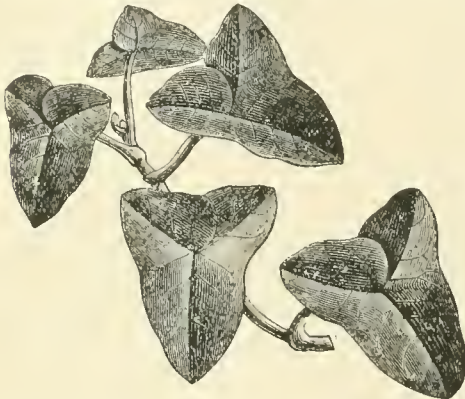

FIG. 2.—*Hedera Helix*, var. *Deltoidea*. Half nat. size. less-known genera, constitute the natural order *Araliaceæ*. There are fifty species of ivy recorded in modern books, but



FIG. 3.—Fruiting Form of *Hedera Helix*. Half nat. size. they may be reduced to three. The European ivy is the *Hedera Helix* of Linnæus (figs. 1-3), a plant subject to in

finite variety in the forms and colours of its leaves, but the tendency of which is always to a three-lobed form when climbing and a regular ovate form of leaf when producing fruit (fig. 3). The African ivy is *H. canariensis*, Willd. (fig. 4), otherwise known as the Irish ivy, a native of Africa and the adjacent islands. This also varies, but in a less degree than *H. Helix*, from which its leaves differ in their larger size, rich deep green colour, and a prevailing tendency to

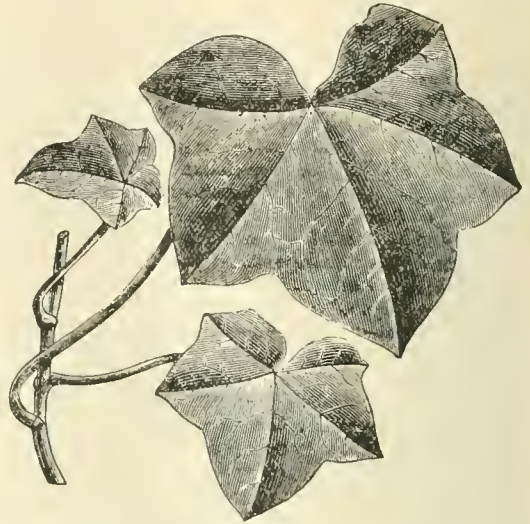

FIG. 4.—African Ivy (*Hedera canariensis*). Half nat. size.

a five-lobed outline. When in fruit the leaves are usually three-lobed, but they are sometimes entire and broadly ovate. The Asiatic ivy is *H. colchica*, Koch (fig. 5), otherwise known as *H. ragneriana* and *H. rugosina*. This has ovate, obscurely three-lobed leaves of a coriaceous texture and a deep green colour; in the tree or fruiting form the leaves are narrower than in the climbing form, and without any trace of lobes. Distinctive characters are also to be



FIG. 5.—Asiatic Ivy (*Hedera colchica*). One-third nat. size.

found in the appendages of the pedicels and calyx, *H. Helix* having six-rayed stellate hairs, *H. canariensis* fifteen-rayed hairs, and *H. colchica* yellowish two-lobed scales. A revision of the natural order *Hederaceæ* by the late Dr B. Seemann will be found in the *Journal of Botany*, 1864-5-6.

It is of the utmost importance to note the difference

of characters of the same species of ivy in its two conditions of climbing and fruiting. The first stage of growth, which we will suppose to be from the seed, is essentially scandent, and the leaves are lobed more or less. This stage is accompanied with a plentiful production of the clasps by means of which the plant becomes attached and obtains support. When it has reached the summit of the tree or tower, the stems being no longer able to maintain a perpendicular attitude fall over and become horizontal or pendent. Coincidentally with this change they cease to produce clasps, and the leaves are strikingly modified in form, being now narrower and less lobed than on the ascending stems. In due time this tree-like growth produces terminal umbels of greenish flowers, which are five-divided, with the styles united into a very short one. These flowers are succeeded by smooth black or yellow berries, containing two to five seeds. The yellow-berried ivy is met with in northern India and in Italy, but in northern Europe it is known only as a curiosity of the garden, where, if sufficiently sheltered and nourished, it becomes an exceedingly beautiful and fruitful tree.

It is stated in books that some forms of sylvestral ivy never flower, but a negative declaration of this kind is valueless. Sylvestral ivies of great age may be found in woods on the western coasts of Britain that have apparently never flowered, but this is probably to be explained by their inability to surmount the trees supporting them, for until the plant can spread its branches horizontally in full daylight, the flowering or tree-like growth is never formed. As regards the clasps, respecting which various views prevail, they are veritable roots, as may be proved by planting an ivy in a damp fern case, when the clasps acquire a new character and penetrate the soil and perform all the functions of roots, suggesting that the hard felt-like form in which they appear on old ivy stems is the consequence simply of an arrest of development. We occasionally see ivies on towers completely isolated from the soil through the destruction of their stems. In these cases the clasps penetrate the structure, and in the capacity of roots obtain the needful sustenance, and the plant lives though no longer deriving nourishment from the earth.

A question of great practical importance arises out of the relation of the plant to its means of support. A moderate growth of ivy is not injurious to trees; still the tendency is from the first inimical to the prosperity of the tree, and at a certain stage it becomes deadly. Therefore the growth of ivy on trees should be kept within reasonable bounds, more especially in the case of trees that are of special value for their beauty, history, or the quality of their timber. In regard to buildings clothed with ivy, there is nothing to be feared so long as the plant does not penetrate the substance of the wall by means of any fissure. Should it thrust its way in, the natural and continuous expansion of its several parts will necessarily hasten the decay of the edifice. But a fair growth of ivy on sound walls that afford no entrance beyond the superficial attachment of the clasps is, without any exception whatever, beneficial. It promotes dryness and warmth, reduces to a minimum the corrosive action of the atmosphere, and is altogether as conservative as it is beautiful.

The economical uses of the ivy are not of great importance. The wood is used by leather cutters to sharpen their knives. From the trunk a resinous substance is obtained called "ivy gum," which is employed for the relief of toothache. The leaves are eaten greedily by horses, deer, cattle, and sheep, and in times of scarcity have proved useful. The flowers afford a good supply of honey to bees; and, as they appear in autumn, they occasionally make amends for the shortcomings of the season. The berries

are eaten by wood pigeons, blackbirds, and thrushes. From all parts of the plant a balsamic bitter may be obtained, and this in the form of *hederic acid* is the only preparation of ivy known to chemists.

In the garden the uses of the ivy are innumerable, and the least known though not the least valuable of them is the cultivation of the plant as a bush or tree, the fruiting growth being selected for this purpose. The variegated tree forms of *H. Helix*, with leaves of creamy white, golden green, or rich deep orange yellow, soon prove handsome miniature trees, that thrive almost as well in smoky town gardens as in the pure air of the country, and that no ordinary winter will injure in the least. The tree-form of the Asiatic ivy (*H. colchica*) is scarcely to be equalled in beauty of leafage by any evergreen shrub known to English gardens, and, although in the course of a few years it will attain to a stature of 5 or 6 feet, it is but rarely we meet with it, or indeed with tree ivies of any kind; but little attention hitherto having been given to this subject. The scandent forms are more generally appreciated, and are now much employed in the formation of marginal lines, sereus, and trained pyramids, as well as for clothing walls. A very striking example of the capabilities of the commonest ivies, when treated artistically as garden plants, may be seen in the Zoological Gardens of Amsterdam, where several paddocks are enclosed with wreaths, garlands, and bands of ivy in a most picturesque manner.

The ivies known in gardens number about sixty varieties, the whole of which are figured and described in *The Ivy, a Monograph*, by Shirley Hibberd, 1872. To cultivate these is an extremely simple matter, as they will thrive in a poor soil and endure a considerable depth of shade, so that they may with advantage be planted under trees. The common Irish ivy is often to be seen clothing the ground beneath large yew trees where grass would not live, and it is occasionally planted in graveyards in London to form an imitation of grass turf, for which purpose it is admirably suited.

The ivy, like the holly, is a scarce plant on the American continent. In the northern United States and British America the winters are not more severe than the ivy can endure, but the summers are too hot and dry, and the requirements of the plant have not often obtained attention. In districts where native ferns abound the ivy will be found to thrive, and the varieties of *Hedera Helix* should have the preference. But in the drier districts ivies might often be planted on the north side of buildings, and, if encouraged with water and careful training for three or four years, would then grow rapidly and train themselves. A strong light is detrimental to the growth of ivy, but this enhances its value, for we have no hardy plants that may be compared with it for variety and beauty that will endure shade with equal patience. (s. n.)

IXION, a hero of Thessalian legend, was king of Gyrtion. As a punishment for the murder of his father-in-law, Deioneus, madness came upon him, until Zeus purified him of his crime and received him as a guest in Olympus. Æschylus uses him as the type of a guilt-laden mortal purified and pardoned by divine grace, and the mythical representative of all later penitents (*Eum.*, 441). Ixion abused his pardon by trying to seduce Hera; but the goddess substituted for herself a cloud, by which he became the father of the Centaurs. Zeus bound him on a fiery wheel, which rolls unceasingly through the air. The wheel is one of the commonest symbols of the sun, and Ixion is clearly the sun-god, and a form of Zeus. His wife Dia is, as her name shows, the consort of Zeus (*Il.*, xiv. 317), and her son Pirithous is called son of Zeus as well as of Ixion. Nephele, the cloud, occurs also as wife of Zeus-Athamas, as here of Zeus-Ixion.



## J

**J**. THIS letter is a modified I. If we consider its place in the alphabet immediately after I, and the corresponding position of V and W after U, we are naturally led to conclude that the new letter was intentionally formed by some one who wished to have a special symbol to denote the palatal consonant *y*, into which *i* readily passes, just as *v* denotes the labial consonant into which *u* passes. For the symbol is a new one. It is not found in the Latin alphabet, in which I was employed alike for the vowel and consonant—though sometimes the I was doubled for the consonant. So far, however, as we can see, J in its origin was nothing but a fancy of the scribes. In 15th century English MSS. the *i*-symbol was drawn a little below the line to denote J, and by degrees this was curled slightly to the left. Again in writing numbers such as vii, viii, it was usual to write uij, uiij, &c. This was imitated in early printing, and hence arose *j*, the earliest regularly curled form. At the same time we find only I in capitals, not J—a modern letter made to correspond with little *j*. This at least seems to have been the history of the symbol in England, and possibly the French history is similar.

It follows from this that the value of J ought to have been in all languages, not that which it has with us, nor yet that which it has in France, but that which it has in Germany, e.g., in "Jahr," our "year,"—which is retained by us in the borrowed Hebrew word "Hallelujah." But generally in English J denotes the sound which is best represented by *dsh*; in this compound *zh* represents the French *j*-sound: the difference between the two may be well seen by comparing the English "Joha" with French "Jean" (Engl. J = *dsh*, Fr. J = *zh*). J, however, is not the only symbol which we employ to represent this sound; we also use G in "gem," "gin," and GE at the end of words such as "edge," "hedge," "wedge," "knowledge," "singe"; while the *zh*-sound (which is the sound corresponding to the surd *sh* in "shall," "wish," &c.) is never represented with us by J, but by numerous other letters, e.g., in *rouge* (a word borrowed from the French), pleasure, division, azure. See A. J. Ellis, *Early English Pronunciation*, c. vi.

The way in which this *dsh*-sound arose seems to have been as follows. In mediæval Latin an inorganic *d*-sound was produced before a *y*-sound,—sometimes when medial, as in "ma-d-ius" for "maius," sometimes initial, as in "diacere" for "iacere." This arose from a careless pronunciation of the palatal *y*. That sound has been liable to obscuration in many languages—notably in Greek, in which a *δ* was developed before it to a very remarkable degree; see Curtius, *Grundzüge*, book iii. D. iii. A simple example may be seen in the particle *δῆ*, which is identical with German "ja" our "yea": the sound of the word was originally *yā*; then in Greek a *d* sprang up before the *y*, producing *dyā*; and finally the *y* was expelled altogether, leaving the *d*-sound alone. Sometimes a double sound was produced (denoted by the symbol *z*) as in *ζῆμα* for (*d*)*yām-ia* or *ἐπιζω* for *ἐπιδ-yo*; here the sound may have been *dzh*, but was more probably *dz*; be this as it may, the change in Greek, which produced a great effect upon the language, may help us to understand how the *d* sprang up in late Latin, and how the compound sound *dsh* was perpetuated in Italian—but there represented by *gi*, as in "giacere," "Giacomo," &c.—and in Old French, in which language it passed at a later time into the modern *zh*-sound described above. But it was introduced into England from France

with its original value in French words. The sound, however, had already existed in England in words of Teutonic origin, the class already mentioned ending in *ge*; "edge" was originally spelt "ecg," and was doubtless sounded as we now sound "egg"; but the final *g*-sound had been palatized, though probably not before the 13th century. These are the two sources of the *dsh*-sound in England, and it is noteworthy that the sound when final has never been spelt with *j*, as though a consciousness of the difference of origin in these cases lingered on in the language. A parallel change (but much more common) has taken place in the *k*-sound: this passed into a *ch*-sound in very many words and not merely at the end, but also at the beginning as in "chill," "child," "church," &c., and this *ch*-sound is not the simple palatal *ch*, but *tsh*, which therefore bears exactly the same relation to *k* as *dsh* (our *j*) bears to *g*.

It appears then that the symbol J ceased to have its proper signification in English by connexion with that of another compound sound borrowed from the French. Meanwhile another symbol Y was being prepared to do the work of J. G at the beginning of a word was often weakened into the *y*-sound: thus "genew" (comp. German "genug") became "ynow," our "enough." Then the old English form of *g* (that is, *ȝ*) was used to express this *y*-sound, and out of it the symbol *y* was gradually developed, while the French form (*g* or nearly so) was kept for the momentary sound.

In Spanish the symbol J denotes the momentary sound corresponding to *y*,—that is, the palatal denoted by *ch* in German, and heard also in Scotland, e.g., in "loch."

**JABALPUR**, or **JUBBULPORE**,<sup>1</sup> a British district in the commissionership of the Central Provinces, India, between 21° 12' and 23° 56' N. lat., and between 76° 40' and 81° 35' E. long., is bounded on the N. by Panna and Maihar, on the E. by Rewah, on the S. by the districts of Mandla, Seoni, and Narsinhpur, and on the W. by Damoh district.

Jabalpur consists of a long narrow plain running north-east and south-west, and shut in on all sides by highlands. This plain, which forms an offshoot from the great valley of the Nerbudda, is covered in its western and southern portions by a rich alluvial deposit of black cotton-soil. At Jabalpur town the soil is sandy, and water plentiful near the surface. The north and east belong to the Ganges and Jumna basins, the south and west to the Nerbudda basin. Thus between Jabalpur and Mirzápur lies the great watershed betwixt the Gulf of Cambay and the Bay of Bengal. The Nerbudda flows through the district for 70 miles from east to west, passing about 9 miles below Jabalpur town through the famous marble rocks, where it throws itself from a rocky ledge with a fall of 30 feet, called *Dhruv-dhar*, or the "misty shoot."

The population was estimated in 1877 at 555,796; but a more careful census taken in 1872 returned it at 528,859, of whom 270,237 were males and 258,622 females. The ethnical division in 1877 showed—Europeans, 776; Eurasians, 201; aboriginal tribes, 105,349; Hindus, 416,770; Mahometans, 27,282; Buddhists and Jains, 3654. Jabalpur, the capital, which has a population of 55,188, is the only town with more than 5000 inhabitants. Of the total area of 3918 square miles, only 1320 are cultivated, but 1308 more are returned as cultivable. Of the cultivated land 3949 acres are irrigated—entirely by private enterprise. Cereals, rice, cotton, and oil-seeds are the principal crops. The district is rich in garden

<sup>1</sup> The division of Jabalpur or Jubbulpore is one of the four which make up the Central Provinces. It comprises the districts of Jabalpur, Sagar (Saugor), Damoh, Seoni, and Mandla, has an area of 18,564 square miles, and in 1878 had a population of 1,839,100.

produce, raising, besides the ordinary Indian fruits, peaches, pine-apples, strawberries, and potatoes. Both the plains and the high lands are well wooded; the forest produce is of considerable value, consisting of lac and gum, and *assar* silk. The trade of the district converges at Jabalpur town, which is one of the most important railway centres in India, being at the junction of the Great Indian Peninsula and East Indian systems. One of the chief manufactures is iron. The most productive mines are at Dabwára, Agariá, and Janti; but the most important are those of the Kumbhi parganá, which supply Panágur, the chief seat of the iron industry in the district. The other manufactures include brass utensils, cotton cloth, and leather articles. Coal is found at several places. The total revenue in 1876-77 was £76,013. The number of Government or aided schools was 125, attended by 7015 pupils. The climate is healthy, and the temperature extremely moderate. As a rule, the hot weather extends only over two months, and, except immediately before the rains, is not oppressive. The rains last from early in June until the latter part of September. The prevailing diseases of the district are fevers and dysentery. Cholera and small-pox are occasional visitants, and influenza at times assumes the character of an epidemic. In 1876 eight charitable dispensaries afforded medical relief to 35,795 indoor and outdoor patients.

The early history of Jabalpur is unknown; but inscriptions record the existence during the 11th and 12th centuries of a local line of princes of that Haihai race which is so closely connected with the history of Gondwána. In the 16th century the Gond rájá of Garhá Mandla extended his power over fifty-two districts, including the present Jabalpur. During the minority of his grandson, Asaf Khán, the viceroy of Kara Mánikpur, conquered the Garhá principality and held it at first as an independent chief. Eventually he resigned his pretensions, and submitted himself to the emperor Akbar. The Delhi power, however, enjoyed little more than a nominal supremacy; and the princes of Garhá Mandla maintained a practical independence until their subjugation by the governors of Ságar (Saugor) in 1781. In 1798 the peshwá granted the Nerhudda valley to the Bhonslá princes of Nágpur, who continued to hold the district until the British occupied it after an engagement on the 19th December 1817. At first the Ságar and Nerhudda territories were governed by a commissioner in subordination to the resident at Nágpur; but in 1861 Jabalpur was formed into a separate district of the Central Provinces.

JABALPUR, or JUBBULPORE, the headquarters of the above district, is situated in 23° 11' N. lat., 79° 59' E. long., in a rocky basin, at an elevation above sea-level of about 1458 feet, 165 miles north-east from Nágpur, and 108 miles south-east from Ságar. The numerous gorges in the neighbouring rocks have been taken advantage of to surround the town with a series of lakes, which, shaded by fine trees, and bordered by fantastic crags and massy boulders, add much beauty to the suburbs. The town itself is modern, and is laid out in wide and regular streets. A streamlet separates the civil station and cantonment from the town; but, though the climate is mild, a swampy hollow beneath renders the site unhealthy for Europeans. Jabalpur contains a school of industry, where tents and carpets are largely manufactured. The opening of the railway system has immensely developed the trade of Jabalpur, which has now become one of the most important centres of commerce in the Central Provinces. In 1875-76 the total imports were valued at £567,000, the chief items being piece-goods, wheat, sugar, metals, salt, rice, country cloth, oil-seeds, spices, *ghí*, oil, inferior grains, lac, and raw cotton. The total exports, principally raw cotton and wheat, were valued at £160,000. The population, almost entirely Hindn, was 55,188 in 1877.

JABIRU, according to Marcgrave<sup>1</sup> the Brazilian name of a bird, subsequently called by Linnæus *Mycteria americana*, one of the largest of the Storks, *Ciconiidae*, which occurs from Mexico southwards to the territory of the Argentine Republic. It stands between 4 and 5 feet in height, and is conspicuous for its massive bill, slightly upturned, and its entirely white plumage; but the head and neck are bare and black, except for about the lower third part of the latter, which is bright red in the living

bird. Very nearly allied to *Mycteria*, and also commonly called Jabirus, are the birds of the genera *Xenorhynchus* and *Ephippiorhynchus*—the former containing one or (in the opinion of some) two species, *X. australis* and *X. indicus*, and the latter one only, *E. senegalensis*. These belong to the countries indicated by their names, and differ chiefly by their feathered head and neck, while the last is sometimes termed the Saddle-billed Stork from the very singular shape of its beak. Somewhat more distantly related are the gigantic birds, known to Europeans in India and elsewhere as Adjutants, belonging to the genus *Leptoptilus*, distinguished by their sad-coloured plumage, their black scabrous head, and their enormous tawny pouch, which depends occasionally some 16 inches or more in length from the lower part of the neck, and seems to be



Jabiru.

connected with the respiratory, and not, as commonly believed, with the digestive system. In many parts of India *L. dubius*, the largest of these birds, the *Hargila* as Hindus call it, is a most efficient scavenger, sailing aloft at a vast height and descending on the discovery of offal, though frogs and fishes also form part of its diet. It familiarly enters the large towns, in many of which on account of its services it is strictly protected from injury, and, having satisfied its appetite, seeks the repose it has earned, sitting with its feet extended in front in a most grotesque attitude. A second and smaller species, *L. javanicus*, has a more southern and eastern range; while a third, *L. crumenifer*, of African origin, and often known as the Marabou-Stork, gives its name to the beautifully soft feathers so called, though our markets are mostly supplied with them by the Indian species (in which they form the lower tail-coverts), if not, as some suppose, by Vultures. (A. N.)

JABORANDI, a name popularly applied in a generic manner in Brazil and South America to a number of different plants, all of which possess more or less marked sialogogue and sudorific properties. In the year 1875 a drug was introduced under the above name to the notice of

<sup>1</sup> An apparently accidental transposal of two of the figures given by this author (*Hist. Nat. Brasiliæ*, pp. 200, 201) misled several of his successors from Piso to Brisson, until noticed by De Buffon (*Hist. Nat. Oiseaux*, vii. pp. 230-236).



medical men in France by Dr Coutinho of Pernambuco, its botanical source being then unknown. When examined by Professor Baillon, the fragments of leaves were found to belong to *Pilocarpus pennatifolius*, Lem., of the natural order *Rutaceæ*. About the same time Holmes found that the commercial drug in England consisted also to some extent of *P. Selloanus*, Engl., and his statement was afterwards confirmed by Baillon, and also by Balansa, the latter of whom observed that species to be employed in Asuncion, and collected for exportation to Europe. *P. pennatifolius* is a slightly branched shrub about 10 feet high, growing in the eastern provinces of Brazil. The compound imparipinnate leaves, which are placed alternately on the stem, are often 1½ feet long, and consist of from 2 to 5 pairs of opposite leaflets, the terminal one having a longer pedicel than the others. The leaflets are oval,



Jaborandi—*a*, leaf (reduced); *b*, leaflet (natural size); *c*, flower; *d*, fruit (natural size).

lanceolate, entire, and obtuse, and often slightly emarginate, from 3 to 4 inches long and 1 to 1½ inch broad in the middle. When held up to the light they may be observed to have scattered all over them numerous pellucid dots or receptacles of secretion immersed in the substance of the leaf. The leaves in size and texture bear some resemblance to those of the cherry-laurel (*Prunus Laurocerasus*, L.), but are less polished on the upper surface. The flowers, which are produced in spring and early summer, are borne on a raceme, 6 or 8 inches long, and the fruit consists of 5 carpels, of which not more than two or three usually arrive at maturity. These present the characters of the natural order to which the plant belongs. (See *Pharm. Journ.*, ser. 3, vol. v. p. 582.) *P. Selloanus* differs from the above chiefly in the leaves never being hairy and in the longer and more slender

pedicels of the flowers. The leaves are the part of the plant usually imported, although occasionally the stems and roots are attached to them. The active principle for which the name *pilocarpine*, suggested by Holmes, was ultimately adopted, was discovered almost simultaneously by Hardy in France and Gerrard in England, but was first obtained in a pure state by Petit of Paris. It is an alkaloid, of a soft viscous character, slightly soluble in water, and very soluble in alcohol, ether, and chloroform. It strongly rotates the plane of polarization to the right, and forms crystalline salts of which the nitrate, hydrochlorate, and phosphate are those chiefly used in medicine. The nitrate and phosphate are insoluble in ether, chloroform, and benzol, while the hydrochlorate and hydrobromate dissolve both in these menstrua and in water and alcohol; the sulphate and acetate being deliquescent are not employed medicinally. The formula of the alkaloid is given by Kingzett as  $C_{23}H_{34}N_4O_4 + 4H_2O$ . The volatile oil contained in the leaves was found by Hardy to be a complex body consisting of *pilocarpeue*, which is a dextrogyre hydrocarbon, sp. gr. 0.852, boiling at 178° C. (352° F.), of another hydrocarbon boiling at 250° C. (492° F.), and a third boiling at a still higher temperature, and forming a colourless transparent solid.

The physiological action of jaborandi is that of an extremely powerful diaphoretic and sialogogue. It acts as a sedative on the heart, probably influencing the circulation through the terminal branches of the vasomotor nerves, and widening the arteries and lessening their tension. The alkaloid does not cause the nausea and vertigo often resulting from the use of the crude drug. Atropine and pilocarpine have been proved to possess antagonistic and mutually antidotal properties. Jaborandi, in the form of liquid extract, tincture, or alkaloid, has been found useful in some forms of chronic pneumonia, in relieving pleuritic effusion in dropsy, in diabetes insipidus, in Bright's disease, as a galactagogue, and more recently in diphtheria. In small doses it restrains the perspiration of phthisis. It has also been proposed as a remedy for hydrophobia. As a mydriatic pilocarpine is said to possess an advantage over eserine, inasmuch as it contracts the pupil of the eye to an equal extent, while it produces less irritation of the conjunctiva, less supraorbital pain, and less spasm of the accommodating apparatus.

According to Peckolt the following are known in some of the Brazilian provinces as jaborandi:—*Serronia Jaborandi*, Guill., *Piper reticulatum*, L., *P. nodulosum*, Link., *Artanthe mollicoma*, Miq., *Aubletia trifolia*, Rich., *Xanthoxylum elegans*, Engl. To these may be added *Piper citrifolium*, Lam. Only one of them appears to have undergone chemical examination. In 1875 Parodi isolated from the *Serronia Jaborandi* a crystalline alkaloid  $C_{16}H_{12}N_2O_6$ , which he named *jaborandine*. It is slightly soluble in ether, has but a weak affinity for acids, and appears to belong to the piperine group; at the same time a volatile oil of an acrid and biting taste was also obtained from the plant.

See *Pharmacographia*, 2d ed., p. 113; Stillé and Maisch, *National Dispensatory*, 1879; Bentley and Trimen, *Medicinal Plants*, No. 43; Kingselt, *Journ. Chem. Soc.*, Oct. 1876, p. 367; Hardy, in *Pharmaceutical Journal* (3) vi. p. 565, vii. p. 496; Holmes, *Ibid.* (3) v. pp. 581, 641, 784; and other papers in the same journal and in *British Medical Journal*, 1875, 1876, 1877. (E. M. H.)

JACA, a frontier city of Spain, in the province of Huesca, formerly capital of a partido in the kingdom of Aragon, is situated on the left bank of the Aragon, at an elevation of 2333 feet above the sea-level. It is the seat of a bishop, and the most important of the public buildings is the massive cathedral, the construction of which was begun under King Ramiro in 1040. The industries of the city are unimportant. Its population in 1877 was 4155.

The diligence road from Zaragoza to Pau by the Puerto de Canfranc passes through Jaca.

The origin of the city is unknown. The Jacetani (Ἰακκητῶν) are mentioned as one of the most celebrated of the numerous small tribes inhabiting the basin of the Ebro by Strabo (p. 161), who adds that their territory was the theatre of the wars between Sertorius and Pompey, and afterwards between Pompey's son Sextus and the generals of Caesar. They are probably identical with the Lacetani of Livy (xxi. 60, 61) and Caesar (*B.U.*, i. 60). Jaca at an early period of the invasion fell into the possession of the Moors, by whose writers it is referred to under the name of Dyaka as one of the chief places in the province of Sarkosta (Zaragoza). The date of its reconquest is uncertain, but it must have been before the time of Ramiro, who gave it the title of "city," and in 1063 held within its walls a council, which, inasmuch as the people were called in to sanction its decrees, is regarded as having been of great importance in the history of the parliamentary institutions of the peninsula. The original "fuero" of Jaca is one of the oldest extant. In 1705 Jaca was the only city which stood out for King Philip, from whom, in consequence, it received the title of "muy noble, muy leal y vencedora." In the war of independence in 1809 it surrendered to the French; it also yielded to General Mina in 1814.

JACAMAR, a word formed by Brisson from *Jacameri*, the Brazilian name of a bird, as given by Maregrave, and since adopted in most European tongues for the species to which it was first applied and others allied to it, forming the Family *Gallulidae* of ornithologists, the precise position of which is uncertain, since the best authorities differ greatly thereupon. All will agree that the Jacamars belong to the great heterogeneous group called by Nitzsch *Picariæ*, but further into detail it is hardly safe to go. The *Gallulidae* have zygodactylous feet, like the *Cuculidae*, *Bucconidae*, and *Picidae*, they also resemble both the latter in laying glossy white eggs, but in this respect they bear the same resemblance to the *Momotidae*, *Alcedinidae*, *Meropidae*, and some other groups, to which affinity has been claimed for them. In the opinion of Mr Sclater<sup>2</sup> the Jacamars form two groups—one consisting of the single genus and species *Jacamarops aureus* (*J. grandis* of most authors), and the other including all the rest, namely, *Urogalba* with two species, *Gallbula* with nine, *Brachygalba* with five, and *Jacamaralecyon* and *Gallbaleyrhynchus* with one each. They are all rather small birds, the largest known being little over 10 inches in length, with sharply pointed bills, and the plumage in every case more or less resplendent with golden or bronze reflexions, but at the same time comparatively soft. *Jacamaralecyon tridactyla* differs from all the rest in possessing but three toes (as its name indicates) on each foot, the hallux being deficient. With the exception of *Gallbula melanogena*, which is found also in Central America and southern Mexico, all the Jacamars inhabit the tropical portions of South America eastward of the Andes, *Gallbula ruficauda*, however, extending its range to the islands of Trinidad and Tobago.<sup>3</sup> Very little is known of the habits of any of the species. They are seen sitting motionless on trees, sometimes solitarily, at other times in companies, whence they suddenly dart off at any passing insect, catch it on the wing, and return to their perch. Of their nidification almost nothing has been recorded, but the species above-mentioned as occurring in Tobago is said by Mr Kirk—apparently the only European observer of the mode of propagation in these birds—to make its nest in marl-banks, digging a hole about an inch and a half in diameter and some 18 inches deep. From the accounts

<sup>1</sup> *Gallbula* was first applied to Maregrave's bird by Meuring. It is another form of *Galydus*, and seems to have been one of the many names of the Golden Oriole. See ICHERUS (vol. xii. p. 696).

<sup>2</sup> A *Monograph of the Jacamars and Puff-birds*, 4to, London (in course of publication).

<sup>3</sup> The singular appearance, recorded by Canon Tristram (*Zoologist*, p. 3906), of a bird of this species in Lincolnshire seems to require notice. No instance seems to be known of any Jacamar having been kept in confinement or brought to this country alive. The fact, if such it be, is therefore more difficult of explanation than the occurrence of Dr Plot's Toucan near Oxford.

received by other travellers we may possibly infer that more of the Family possess the same habit. (A. N.)

JACANA,<sup>4</sup> the Brazilian name, according to Maregrave, of certain birds, since found to have some allies in other parts of the world, which are also very generally called by the same appellation. They have been most frequently classed with the Water-hens or Rails (*Rallidae*), but are now recognized by many systematists as forming a separate Family, *Paridae*,<sup>5</sup> whose leaning seems to be rather towards the *Limicolæ*, as apparently first suggested by Blyth, a view which is supported by the osteological observations of Professor Parker (*Proc. Zool. Society*, 1863, p. 513), though denied by Professor A. Milne-Edwards (*Ois. foss. de la France*, ii. p. 110). The most obvious characteristic of this group of birds is the extraordinary length of their toes and claws (the latter being turned upwards), whereby they are enabled to walk with ease

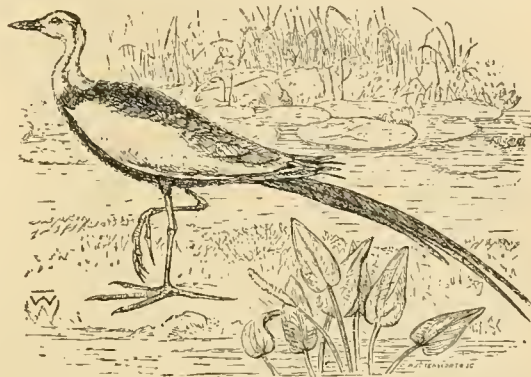

Jacana.

over water-lilies and other aquatic plants growing in rivers and lakes. It is also remarkable for the carpal spurs with which its members are armed. The Family has been divided into four genera,—of which *Parra*, as now restricted, inhabits South America; *Metopidius*, hardly differing from it, has representatives in Africa, Madagascar, and the Indian Region; *Hydralector*, also very nearly allied to *Parra*, belongs to the northern portion of the Australian Region; and *Hydrophasianus*, the most extravagant form of the whole, is found in India, Ceylon, and China—the draughtsmen of the country last named making it a favourite subject of their pictures, in which its flowing tail and the very peculiar filamentous appendages to the tip of its first and fourth primaries are generally faithfully represented. In habits the Jacanas have much in common with the Water-hens, but that fact is insufficient to warrant the affinity asserted to exist between the two groups; for in their osteological structure, as already implied, there is much difference, and the resemblance seems to be only that of analogy. The *Paridae*, or at least such of them as have been sufficiently observed, lay very peculiar eggs, of a rich olive-brown colour, in most cases closely marked with dark lines, thus presenting an appearance by which they may be readily known from those of any other birds, though an approach to it is occasionally to be noticed in those of certain *Limicolæ*, and especially of certain *Charadriidae*. The genus *Palamedea*, consisting of the bird very commonly

<sup>4</sup> In pronunciation the *c* is soft, and the accent placed on the last syllable.

<sup>5</sup> The classic *Parra* is by some authors thought to have been the Golden Oriole (cf. ICHERUS), while others suppose it was a Jay or Pigeon. The word seems to have been imported into Ornithology by Aldrovandus, but the reason which prompted Linnaeus to apply it, as he seems first to have done, to a bird of this group, cannot be satisfactorily stated.



named the Horned Screamer, was at one time thought to be allied to this Family, but is now, by almost common consent, relegated to the neighbourhood of the Geese (*Anatidae*), though forming a separate Family. (A. N.)

JACINTH, a name given to the reddish-brown variety of zircon, known also as *Hyacinth*. The hyacinthus of ancient writers appears to have been our sapphire, or blue corundum, while the jacinth or hyacinth of modern mineralogists may have been the ancient *lyncurium*. The true jacinth is a silicate of zirconium, crystallizing in the dimetric or tetragonal system, and exhibiting strong double refraction. Its hardness is denoted by 7.5; that is to say, it is harder than quartz but not so hard as topaz. The most distinctive feature of the stone, serving to distinguish it from other minerals with which it is likely to be confounded—such as garnet, topaz, and cairngorm—is its high specific gravity; this varies, however, in different varieties of zircon from 4.05 to 4.75. On ignition, most zircons increase in density without loss of weight; but Professor Church has shown that the jacinth of Mudjee, when heated, remains practically unchanged in density, though it loses colour. It is only when the native silicate of zirconium presents a red colour that it is known as jacinth or hyacinth,—those varieties which are of yellow brown and green colours being distinguished, if transparent, by the name of *jargoon*, while the dull-coloured varieties, more or less opaque, are termed simply *zircon*. The lustre of the zircon when polished is of the peculiarly brilliant character designated *adamantine*, and indeed some of the pale jargoons are often sold as inferior diamonds. The Singalese variety, found chiefly at Matura, has been termed “Matura diamond.” The true jacinth, or red zircon, is an extremely rare stone. Fine examples, however, have been found of late years as pebbles among the auriferous detritus at Mudjee in New South Wales. Small crystals occur in the river-sands of Expailly, Pay-en-Velay, France, but these are too small to be cut as ornamental stones. Most of the gems termed jacinth or hyacinth by jewellers belong to the deep orange-brown variety of garnet known to mineralogists as *essonite* or *cinnamon stone*: the lower specific gravity of the garnet serves to distinguish the false from the true jacinth. It is probable that many of the antique camei and intagli reputed to be jacinths are merely hyacinthine garnets.

JACKAL (*Canis aureus*), a carnivorous mammal belonging to the dog family (*Canidae*), and believed by many naturalists to be one of the species from which certain of the semi-domesticated dogs of Asia and North Africa have been derived. It is dog-like in external appearance, and there is, according to Geoffroy Saint Hilaire, no constant difference between its structure and that of the small canine races. It resembles them in dentition, in the roundness of its eye pupils, in its period of gestation, and to a large extent also in its habits, while like the dog it is subject to hydrophobia. It grows to a height of 15 inches at the shoulders, and to a length of about 2 feet, exclusive of its bushy fox-like tail. Its fur is of a greyish-yellow colour, darker on the back and lighter coloured beneath. An excrescence consisting of a horny cone, half an inch in length, and concealed by a tuft of hair, is, according to Emerson Tenent, sometimes found on the head of the jackal. The Singalese aver that it is only found on the leader of the pack, and they esteem it as an invaluable talisman. Jackals, of which there are several well-marked varieties, are widely distributed throughout southern Asia and the north of Africa. They are nocturnal animals, concealing themselves until dusk in woody jungles and other natural lurking places, thereafter sallying forth in packs, which sometimes number two hundred individuals, and visiting farmyards, villages, and towns in search of food. This consists for the most part of the smaller mammals

and poultry, although their association in packs enables them also to hunt down antelopes and sheep. When unable to obtain living prey, they feed upon carrion and refuse of all kinds, and are thus useful in removing putrescent matter from the streets of Eastern towns. They are also fond of grapes and other fruits, and are thus the pests of the vineyard as well as the poultry-yard. The cry of the jackal has been described as even more appalling than that of the hyena, a shriek from one member of a pack being the signal for a general chorus of screams, which is kept up during the greater part of the night. In India these animals are occasionally hunted with foxhounds



Jackal.

and greyhounds, and from their extreme cunning and pluck they are said to afford excellent sport. When brought to bay, they frequently turn upon their assailants and inflict severe wounds with their teeth; at other times they have been known to feign death as a means of escape. Jackals are readily tamed; and domesticated individuals are said, when called by their masters, to wag their tails, crouch, and throw themselves on the ground, and otherwise behave in a dog-like fashion. The jackal, like the fox, has a peculiarly offensive odour, due to the secretion of a gland at the base of the tail, but in domesticated specimens this odour is much fainter than in the wild forms.

JACKDAW, or simply DAW (Old Low German, *Daha*; Dutch, *Kaauw*), the prefix being doubtless imitative of the bird's cry, as indeed is probably the substantive name!—one of the smallest species of the genus *Corvus* (Crow, vol. vi. p. 617), and a very well known inhabitant of Europe, the *C. monedula* of ornithologists. In some of its habits it much resembles its congener the Rook (*q.v.*), with which it constantly associates during a great part of the year; but, while the Rook only exceptionally places its nest elsewhere than on the boughs of trees and open to the sky, the Daw almost invariably chooses holes, whether in rocks, hollow trees, rabbit-burrows, or buildings. Nearly every church-tower and castle, ruined or not, is more or less numerously occupied by Daws, and if they are not

† See Professor Skeat's *Etymol. Dictionary*, pp. 153, 304.

also tenants with us of our own dwellings, it is because convenient recesses are therein ordinarily wanting. Yet our chimneys frequently give them the accommodation they desire, much to the annoyance of the householder, who finds the funnel choked by the quantity of sticks brought together by the birds, since their industry in collecting materials for their nests is as marvellous as it often is futile.<sup>1</sup> In some cases the stack of loose sticks piled up by Daws in a belfry or tower has been known to form a structure 10 or 12 feet in height, and hence this species may be accounted one of the greatest nest-builders in the world. The style of architecture practised by the Daw thus brings it more than the Rook into contact with man, and its familiarity is increased by the boldness of its disposition, which, though tempered by discreet cunning, is hardly surpassed among birds. Its small size, in comparison with most of its congeners, alone incapacitates it from inflicting the serious injuries of which some of them are often the authors, yet its pilferings are not to be denied, though on the whole its services to the agriculturist are great, for in the destruction of injurious insects it is hardly inferior to the Rook, and it has the useful habit of ridding sheep, on whose backs it may be frequently seen perched, of some of their parasites.

The Daw displays the glossy black plumage so characteristic of the true Crows, varied only by the heavy grey of the ear-coverts, and of the nape and sides of the neck, which is the mark of the adult; but examples from the east of Europe and western Asia have these parts much lighter, passing into a silvery white, and hence have been deemed by some authorities to constitute a distinct species (*C. collaris*, Drumm.). Further to the eastward occurs the *C. danuricus* of Pallas, which has not only the collar broader and of a pure white, but much of the lower parts of the body white also. Japan and northern China are inhabited also by a form resembling that of western Europe, but wanting the grey nape of the latter. This is the *C. neglectus* of Professor Schlegel, and is said by Mr Dresser, on the authority of Swinhoe, to interbreed frequently with *C. danuricus*. These are all the birds that seem entitled to be considered Daws, though Mr Sharpe (*Cat. B. Brit. Museum*, vol. iii. p. 24) associates with them (under the little-deserved separate generic distinction *Colinus*) the Fish-Crow of North America, which appears both in structure and in habits to be a true Crow. (A. N.)

JACKSON, chief city of Jackson county, Michigan, U.S., is situated on the Grand river, about 75 miles west of Detroit. The city is paved and lighted with gas, and several of the buildings are very handsome. It is the seat of the large State penitentiary. The commercial interests of the city are fostered by its position on no fewer than six railways; and its manufactures are assisted by the water power, afforded by the river, which flows through the town, and is spanned by an iron bridge. Jackson manufactures fire-clay goods, railway and other carriages, chemicals, agricultural implements, &c., and has foundries, planing-mills, and flour-mills. The presence of bituminous coal in the neighbourhood affords additional stimulus to trade; and the surrounding country is fertile. A business college and a system of graded schools are among the educational resources of the city. Population in 1870, 11,447; in 1880, 16,105.

JACKSON, capital of the State of Mississippi, U.S., and chief city of Hinds county, is pleasantly situated on the right

bank of the Pearl river, about 180 miles north of New Orleans, with which it is connected by rail. The city is fairly well built; the chief buildings are the State capitol, the State penitentiary, and the institutions for the blind and for the deaf and dumb. One mile distant is the lunatic asylum. There are several good schools, and a State library of 15,000 volumes. The chief trade is in cotton, the average export being about 30,000 bales a year. Foundries and a factory for sashes and doors are among the manufactories of the place. Population in 1870, 4234; in 1880, 5205.

JACKSON, chief city of Madison county, Tennessee, U.S., is situated on the Forked Deer river, about 70 miles north-east of Memphis. Its chief trade is in cotton, of which many thousand bales are exported annually. Jackson has flour and planing mills, and manufactories of railway and other carriages, besides smaller industries. Of its several educational institutions the chief is West Tennessee college, founded in 1844, which had in 1874-75 four professors and one hundred students. The South-Western Baptist university was opened in 1875. The population in 1880 numbered 5371.

JACKSON, ANDREW (1767-1845), seventh president of the United States, was born March 15, 1767, at the Waxhaw or Warsaw settlement (whose position in relation to the later boundaries of North and South Carolina is unknown), whither his parents had immigrated from Carrickfergus in Ireland in 1765. Jackson had no regular education. He had some slight share in the war of independence, and was taken prisoner in 1781. He studied law at Salisbury, North Carolina, and was admitted to the bar and began to practise at Nashville in Tennessee. In 1791, on the first incorrect report that Mrs Rachel Robards (*née* Donelson) had succeeded in getting a divorce bill from her husband passed in Virginia, Jackson married her; when, later, it was passed, they were remarried. In 1796 Jackson assisted to frame the constitution of Tennessee, and represented that State in the federal congress, where he distinguished himself as an irreconcilable opponent of Washington. In 1797 he was elected a United States senator; but he resigned the following year. He was judge of the supreme court of Tennessee from 1798 to 1804. In 1804-5 he contracted a friendship with Burr; and at the latter's trial in 1807 Jackson was one of his conspicuous champions. Up to the time of his nomination for the presidency, the biographer of Jackson finds nothing to record but military exploits in which he displayed perseverance, energy, and skill of a very high order, and a succession of personal acts in which he showed himself ignorant, violent, perverse, quarrelsome, and astonishingly indiscreet. In 1806 he killed Charles Dickinson in a duel. In 1813, as major-general of militia, he commanded in the campaign against the Creek Indians in Georgia and Alabama, and there first attracted public notice by his talents. In May 1814 he was commissioned as major-general in the regular army to serve against the English; in November he captured Pensacola, used by the English as a base of operations; and on January 8, 1815, he inflicted a severe defeat on the enemy before New Orleans. During his stay in New Orleans, he declared martial law, and carried out his measures with unrelenting sternness, banishing from the town a judge who attempted resistance. When civil law was restored, Jackson was fined \$1000 for contempt of court; in 1844 congress ordered the fine with interest (\$2700) to be repaid. In 1818 Jackson received the command against the Seminoles. His conduct in following them up into the Spanish territory of Florida gave rise to much hostile comment in the cabinet and in congress; but the negotiations for the purchase of Florida put an end to the diplomatic question. In 1821 Jackson

<sup>1</sup> Some writers, as Jesse (*Scenes and Tales of a Country Life*, p. 57), have ascribed great sagacity to the Daw as a nest-builder, but the statement of this author seems open to a very different interpretation (*Yarrell's Br. Birds*, ed. 4, ii. p. 303, note); and Jardine's remark (*Nat. Library*, x. p. 236) that it often exhibits great want of instinct, seems to be quite justified by the known facts.



was appointed military governor of Florida, and there again he came into collision with the civil authority. From this, as from the previous troubles, J. Quincy Adams extricated him.

In August 1822 the house of representatives of Tennessee nominated Jackson for president; and in 1823 he was elected to the senate at Washington. The rival candidates for the office of president were Adams, Crawford, and Clay. Jackson obtained the largest number of votes in the electoral college; but no one had an absolute majority. At the election by the house of representatives (February 9, 1825) Adams was chosen. Jackson, however, was recognized by the abler politicians as the coming man; Van Buren and others, going into opposition under his banner, waged from the first a relentless and factious war on the administration. Van Buren was the most adroit politician of his time; and Jackson was in the hands of very astute men, who advised and controlled him. He was easy to lead when his mind was in solution; and he gave his confidence freely where he had once placed it. He was not suspicious, but if he withdrew his confidence he was implacable. When his mind crystallized on a notion that had a personal significance to himself, that notion became a hard fact that filled his field of vision. When he was told that he had been cheated in the matter of the presidency, he was sure of it, although those who told him were by no means so.

There was great significance in the election of Jackson in 1828. A new generation was growing up under new economic and social conditions. They felt great confidence in themselves, and great independence. They despised tradition and Old World ways and notions; and they accepted the Jeffersonian dogmas, not only as maxims, but as social forces—the causes of the material prosperity of the country. By this generation, therefore, Jackson was recognized as a man after their own heart. They liked him because he was vigorous, brusque, uncouth, relentless, straightforward, and open. They made him president in 1828, and he fulfilled all their expectations. He had 178 votes, in the electoral college against 83 given for Adams. Though the work of redistribution of offices began almost at his inauguration, it is yet an incorrect account of the matter to say that Jackson corrupted the civil service. His administration is rather the date at which a system of democracy, organized by the use of patronage, was introduced into the federal arena by Van Buren. The administration had two parties in it from the first, Van Buren's and Calhoun's, and the president's interference in a purely private matter brought about a rupture. In April 1831 the whole cabinet resigned; Jackson and Calhoun quarrelled; and the former transferred to Van Buren his support for succession in the presidency.

In 1832 Jackson was re-elected by a large majority over Clay, his chief opponent. The battle raged mainly around the re-charter of the Bank of the United States. It is probable that Jackson's advisers in 1828 had told him, though erroneously, that the bank had worked against him, and then were not able to control him. The first message of his first presidency had contained a severe reflexion on the bank; and in the very height of this second campaign (July 1832) he vetoed the re-charter, which had been passed in the session of 1831-32. Jackson interpreted his re-election as an approval by the people of his war on the bank; and after the exciting episode of South Carolina's opposition to the tariff-rates he pushed it with energy. In September 1833 he ordered the public deposits in the bank to be transferred to selected local banks, and entered upon the "experiment" whether these could not act as fiscal agents for the Government, and whether the desire to get the deposits would not induce them to

adopt sound rules of currency. During the next session the senate passed a resolution condemning his conduct. Jackson protested, and after a hard struggle the resolution was ordered to be expunged from the record, January 16, 1837.

Jackson was very successful in collecting old claims against various European nations, for spoliations inflicted under Napoleon's continental system. Aiming at a currency consisting largely of specie, he caused the payment of these claims to be received and imported in specie as far as possible; and in 1836 he ordered land-agents to receive for land nothing but specie. About the same time a law passed congress for distributing among the States some \$35,000,000 balance belonging to the United States, the public debt having all been paid. The eighty banks of deposit in which it was lying had regarded this sum almost as a permanent loan, and had inflated credit on the basis of it. The necessary calling in of their loans in order to meet the drafts in favour of the States, combining with the breach of the overstrained credit between America and Europe and the decline in the price of cotton, brought about a crash which prostrated the whole financial, industrial, and commercial system of the country for six or seven years. The crash came just as Jackson was leaving office; the whole burden fell on his successor, Van Buren.

Jackson is the only president of whom it may be said that he went out of office far more popular than he was when he entered. When he went into office he had no political-opinions, only some popular notions. He left his party strong, perfectly organized, and enthusiastic on a platform of low expenditure, payment of the debt, no expenditure for public improvement or for glory and display in any form, and low taxes. His name still remained a spell to conjure with, and the politicians sought to obtain the assistance of his approval for their schemes; but in general his last years were quiet and uneventful. He died near Nashville, June 8, 1845.

Biographies of Jackson have been written by J. H. Eaton, 1824; William Cobbett, 1834; Amos Kendall, 1844; and James Parton, 3 vols., 1860. (W. G. S.)

JACKSON, THOMAS JONATHAN (1824-1863), "Stonewall Jackson," a distinguished Confederate general in the American civil war, was born in Harrison county, Virginia, 21st January 1824, and came of that Scotch-Irish stock to whose hardy virtues the middle States of America are largely indebted for the pure and resolute virtues of their people. His early education was only such as could be furnished by an obscure country school. Thence he passed to West Point military academy, where, though he was at first impeded by his meagre acquirements, his indomitable courage and conscientious diligence eventually raised him to a foremost place. At West Point he exhibited the qualities by which he was distinguished in the splendour of his career,—courage, patience, constancy of purpose, inflexible fidelity to duty, and an artless simplicity of character which engaged instant and universal confidence. Graduating at twenty-two, he was appointed lieutenant of artillery in the army of the United States, and participated, with distinction, in several of the most important battles in Mexico. After the war he resigned his commission, and accepted the professorship of natural philosophy in the Virginia military institute at Lexington, a position which he held until the outbreak of hostilities between the Union and the Confederate States. During his sojourn at Lexington, he entered the Presbyterian communion, and was remarkable ever after for the fervour of his religious devotion. In political discussions or agitations, Major Jackson—such was his title by brevet—had never engaged; but in principle and by profession he was a State-right Democrat of the Virginia school; in other words, he maintained the legitimacy of negro slavery and the

sovereign right of a State to withdraw from the Union, and therefore to the secession movement of 1861 he at once accorded his sympathy. On the organization of the Virginia troops he was commissioned colonel of infantry by Governor Letcher, who, long intimate with him, adequately appreciated his yet undisclosed military genius.

Jackson's first exploit in the war of secession was the capture, on May 3, 1861, of the Federal arsenal at Harper's Ferry. Soon afterwards he received the command of a brigade—the brigade which, by its immovable fortitude at Bull Run, turned the tide of battle in that long doubtful struggle, and, from the admiration of its comrades, extorted for itself and its chief the now historic name of "Stonewall."

Detached from the army at Manassas for separate service in the Shenandoah Valley, Jackson soon signaled his genius for war. Placing himself between the converging columns of Shields, Milroy, and Banks, he struck one after the other; and, with a force inferior to his adversaries separately, he eventually drove them back upon Washington in utter defeat. In this "campaign of the valley" Jackson displayed true military instinct and the highest military art. By vigilance, sagacity, celerity and secrecy of movement, and faultless tactical skill on the field of battle, he achieved the greatest possible results with the smallest possible means. His reputation was now fixed in the estimation alike of friend and foe; and, while the Confederate States were filled with the renown of his achievements, the Federal forces were in constant terror of his prowess. Having stayed the invasion of Virginia along the line of the valley, Jackson repaired to Richmond to concert with Lee the deliverance of the Confederate capital, then closely pressed by McClellan. Appointed, meanwhile, to the command of a corps, he suddenly revealed himself on the right flank of the Federal army at Mechanicsville; and in a series of desperately fought engagements he routed the besieging army, and drove McClellan to shelter at Harrison's Landing. Richmond relieved, Jackson, without pause, hastened to confront Pope, who was menacing the city from the north. In the battle of Cedar Run he inflicted signal defeat upon that general, and compelled him to retrace his steps across the Rappahannock.

Reinforced by McClellan's army and fresh troops from the northern States, Pope made a stand at Manassas; but in the second battle on that field he suffered an overthrow as decisive as that sustained by McDowell in the first fight at Bull Run. As usual Jackson's corps bore the brunt of the battle; and as usual to his skill and courage the Confederate army was mainly indebted for its success. Following up the victory by the invasion of Maryland, Lee detached Jackson for an attack on Harper's Ferry, again in the hands of the Federalists, and garrisoned by 12,000 troops. In a few days the surrender of the place, with all its force and munitions of war, was announced to Lee, who, slowly retiring before McClellan, anxiously expected the arrival of Jackson, that he might turn and crush his pursuer. But before he could effect the desired junction Lee was brought to bay at Antietam, and compelled to accept battle under every disadvantage. Jackson now arrived, however, with two of his divisions, and his presence not only averted an otherwise inevitable disaster, but rescued the Confederate army from the destruction which awaited it if defeated with its rear resting on the river. Henceforth Jackson's operations were under the immediate eye and command of Lee; and, while at Fredericksburg and Chancellorsville his gallantry was as conspicuous as ever, to his illustrious chief belongs the glory of those hard-fought fields.

On the afternoon of May 2, 1863, Jackson fought his last battle. Executing a plan of his own conception, he suddenly struck the flank of the 11th Federal corps, and

drove it pell-mell before him. Night fell with the hostile forces in close proximity; and, while Jackson was making a reconnaissance with a view to pressing the pursuit, he was fired on in the dark by men of his own command, and received wounds of which he died on May 10, 1863. His death smote the Confederates with a pang of unspeakable anguish. The fall of their foremost chieftain was bewailed as the omen of the fall of the party.

In deportment Jackson was grave and measured; but he relaxed on approach, and his address was bland and gracious. In conversation he conveyed the impression of a frank, firm character, and of an intellect clear and direct, but in no wise of superior order. No opinion floated languidly in his understanding; he held all his beliefs with an intense earnestness of conviction, and he was prompt and resolute in carrying his convictions into action. He engaged in the war of secession with an unflinching faith in the justice of the cause and an unhesitating persuasion of its triumph. He was the idol of his troops. At his command they would cheerfully endure any sacrifice or confront any peril. On the field of battle he was never known to lose his self-possession, or to be surprised by any fluctuation of fortune; his quick eye would detect the exigent moment, and his unerring judgment direct the decisive manœuvre. (R. A. P.\*)

JACKSON, WILLIAM (1730-1803), an English musician of repute, was born at Exeter, in May 1730. His father, a grocer, bestowed a liberal education upon him, but, on account of the lad's strong predilection for music, was induced to place him under the care of John Silvester, the organist of Exeter Cathedral, with whom he remained about two years. In 1748 he went to London, and studied under John Travers, organist of the king's chapel. Returning to Exeter, he settled there as a teacher and composer, and in 1777 was appointed subchanter, organist, lay-vicar, and master of the choristers of the cathedral. In 1755 he published his first work, *Twelve Songs*, which became at once highly popular. His next publication, *Six Sonatas for the Harpsichord*, was a failure. His third work, *Six Elegies for three voices, preceded by an Invocation, with an Accompaniment*, was very successful, and placed him among the first composers of his day. Dr Burney considered these as the best of Jackson's works, and added that "no composer copied less from others than Jackson." His fourth work was another set of *Twelve Songs*, now very scarce; and his fifth work was again a set of *Twelve Songs*, all of which are now forgotten. He next published *Twelve Hymns*, with some good remarks upon that style of composition, although his precepts were better than his practice. A set of *Twelve Songs* followed, containing some good compositions. Next came an *Ode to Fancy*, the words by Dr Warton. *Twelve Canzonets for two voices* formed his ninth work; and one of them—"Time has not thinned my Flowing Hair"—long held a place at public and private concerts. His tenth work was *Eight Sonatas for the Harpsichord*, some of which were novel and pleasing. He composed three dramatic pieces,—*Lycidas* (1767), *The Lord of the Manor*, to General Burgoyne's words (1780), and *The Metamorphoses*, a comic opera produced at Drury Lane in 1783, which did not succeed. In the second of these dramatic works, two airs—"Encompassed in an Angel's Form" and "When first this Humble Roof I knew"—were great favourites. Some of his church music, published after his death, did not please the critics. In 1782 he published *Thirty Letters on Various Subjects*, which are well written and interesting. In these he severely attacked canons, and described William Bird's *Non nobis Domine* as containing passages not to be endured. But his anger and contempt were most strongly expressed against catches of all kinds, which he denounced as bar-



barous. In 1791 he put forth a pamphlet, *Observations on the Present State of Music in London*, in which he found fault with everything and everybody. He published in 1798 *The Four Ages, together with Essays on Various Subjects*,—a work which gives a favorable idea of his character and of his literary acquirements. It appears that he cultivated a taste for landscape painting, and imitated, not unsuccessfully, the style of his friend Gainsborough. He died July 12, 1803.

**JACKSONVILLE**, the chief city in Duval county, Florida, U.S., and the largest in the State, is situated on the west bank of the St John's river, 25 miles from the sea. The city is regularly built. The streets, many of which are pleasantly shaded with trees, are laid out on the common American rectangular system. Jacksonville exports very large quantities of lumber, besides fruit, cotton, sugar, and fish, and carries on a coasting trade with Charleston, Savannah, and St Augustine. The fine salubrious climate attracts numerous visitors and invalids from the northern States. Jacksonville, which owes its name to President Jackson was laid out as a town in 1822. In 1880 its population was 7650.

**JACKSONVILLE**, the chief city of Morgan county, Illinois, U.S., on Mauvaiseterre Creek, a tributary of the Illinois river, is situated at the intersection of several railways, about 200 miles S.S.W. of Chicago. Its streets are wide and generally well shaded. The public buildings include State institutions for the blind, the feeble-minded, the deaf and dumb, and the insane. Among the educational institutions, which are numerous, are Illinois College, three colleges for women, and a conservatory of music. There is also a free library, with reading-room. The population in 1880 was 10,928.

**JACOB** (יַעֲקֹב or יִשְׂרָאֵל, derived according to Gen. xxv. 26, xxvii. 36, from יַעֲקֹב, and meaning "one who seizes the heel" or "supplants"), the younger son of Isaac and Rebekah, and the father of the twelve patriarchs. According to the Elohistic (Levitical) narrative in Genesis, he was born in the land of Canaan when his father was sixty years of age. After Esau, his twin brother, at the age of forty years had married two Hittite wives, Isaac at the instigation of Rebekah sent Jacob with his blessing to Padan Aram, there to seek a wife in the family of his maternal uncle Laban. Arrived at his destination, he married Rachel (to whom Bilhah was given as a maidservant); the same narrative implies also his union with Leah (whose maid was Zilpah). Before he left Padan Aram he had become the father of twelve sons, including Benjamin (Gen. xxxv. 23-26). On his return, with the property he had acquired, to his father Isaac in Canaan (xxxv. 18), God met him and blessed him and changed his name from Jacob to Israel; the place where this occurred was called by him Bethel (xxxv. 9-13, xxxv. 15). In the course of a further migration southwards, Rachel died at a point not far from Ephrath (Bethlehem); finally Mamre, near Kiriath Arba (Hebron), where Isaac was living, was reached and a permanent settlement appears to have been made until the death of Isaac there at the age of one hundred and eighty years. The subsequent migration of Jacob to Egypt with his household of seventy souls is then briefly indicated, and his hospitable reception as an old man of one hundred and thirty by Pharaoh. A residence was assigned to the colony in the best part of the land, the land of Rameses, by Joseph, and here the Israelites prospered much and rapidly increased. Seventeen years after the interview with Pharaoh the patriarch died, after having blessed his sons and particularly Joseph, whose two sons Ephraim and Manasseh he put upon a level with Reuben and Simeon. He was buried by his family, according to his own desire, in the cave of Machpelah, fronting Mamre, in the land of

Canaan. The combined parallel narrative of the Jehovist and the other (elder) Elohist is much fuller, and in some points not easily to be reconciled with the preceding account. Various circumstances connected with the birth of the twins Isaac and Jacob are detailed; the partiality of Isaac for the elder and of Rebekah for the younger is indicated; Jacob's departure from Canaan is represented as a flight necessitated by his fraudulent conduct towards Isaac and Esau with reference to the blessing of the former; a revelation received at Bethel in the course of this flight is described; many minute particulars of his domestic life at Padan Aram and of his relations with Laban his uncle and father-in-law are given; the scene of the change of name is placed at Peniel, where he wrestled with the angel (see Hos. xii. 5); a period of residence at Shechem is mentioned; the death of Rachel at Ephrath is said to have happened in childbirth; after having fixed his home successively at Hebron and Beersheba, he is ultimately led by circumstances, which are described with much fulness and vividness, to migrate to Egypt, where he dies. Consideration of the relations of these parallel narratives may be postponed to the article PENTATEUCH. As to the interpretation of the history of Jacob, it is now usual to regard it as having an ethnological at least quite as much as a personal significance; but none of the attempts hitherto made to mythologize it (as by Popper, who sees in the wrestling Jacob the Asiatic Hercules, Melicertes, Palæmon) can be regarded as even plausible.

See Ewald, *Gesch. Israels*, i. 412 sqq., 489 sqq.; Wellhausen, *Gesch. Israels*, i. 314, 374; Kuenen in the *Theol. Tijdschr.* for May, 1871.

**JACOBÁBÁD**, a municipality and the chief town of the frontier district of Upper Sind, India, is situated in 28° 17' N. lat. and 68° 28' 45" E. long. Laid out in 1847 by General John Jacob, on the site of the village of Khangarh, it is now the headquarters of the large military force of the Upper Sind frontier, and also of the local civil administration. It contains therefore a considerable European population, and possesses all the usual public offices and institutions of an important station. In addition to the cantonments, civil and judicial courts, dispensary, jail, post and telegraph offices, &c., it has also a "residency," and lines for the accommodation of trade caravans (*káfilas*) from Central Asia. The civil court, which is under the Shikárpur jurisdiction, was established in 1870, the sessions judge of Shikárpur visiting it twice a year. Population, including the military camp, 10,954.

**JACOBI, FRIEDRICH HEINRICH** (1743-1819), a distinguished writer on philosophy, was born at Düsseldorf on the 25th January 1743. The second son of a wealthy merchant, who owned an extensive sugar factory near Düsseldorf, he was educated for a commercial career, partly in his native place, partly at Frankfort-on-the-Main. At the age of sixteen he was sent to complete his training at Geneva, where he remained for four years. Of a retiring disposition, and far more inclined to thoughtful meditation than to practical activity, Jacobi mainly associated himself at Geneva with the literary and scientific circle of which the most prominent member was Lesage. He studied closely the works of Bonnet, the Swiss naturalist and metaphysician, and was brought into contact with the new political ideas of Rousseau and Voltaire. In 1763 he was called back to Düsseldorf, and in the following year he married and took his place at the head of the mercantile concern handed over to him by his father. After a short period he gave up his commercial career, and in 1770 became a member of the council for the duchies of Juliers and Berg, in which capacity he distinguished himself by his ability in the management of financial affairs, and his zeal in the direction of social reforms. Like his contem-

porary Hemsterhuis, whom he resembles in many points, Jacobi kept up his interest in literary and philosophic matters by an extensive correspondence, and his mansion at Pempelfort, near Düsseldorf, was the centre of a distinguished literary circle. With Wieland he contributed to start a new literary journal, the *Mercury*, in which some of his earliest writings, mainly on practical or economical subjects, were published. Here too appeared in part the first of his philosophic works, the *Correspondence of Allwill* (*Allwill's Briefe-Sammlung*, 1774), a combination of romance with speculation, containing a remarkable delineation of that which we may call the principle of the early romantic school in Germany. This was followed in 1779 by *Woldemar*, a philosophic novel, of very imperfect structure, but full of genial speculation, and giving the most complete picture of Jacobi's method of philosophizing. In 1779 he was invited to Munich as member of the privy council, but after a short stay there differences with his colleagues and with the authorities of Bavaria drove him back to Pempelfort. A few unimportant tracts on questions of theoretical politics were followed in 1785 by the work which first brought Jacobi directly into relation with the contemporary philosophical public. A conversation which he had held with Lessing in 1780, in which Lessing avowed that he knew no philosophy, in the true sense of that word, save Spinozism, led him to a protracted study of Spinoza's works, while his statement of Lessing's confession induced a correspondence with Moses Mendelssohn. The *Letters on Spinoza's Theory* (*Briefe über die Lehre Spinoza's*, 1785, 2d ed., much enlarged and with important *Appendices*, 1789) expressed sharply and clearly Jacobi's strenuous objection to a demonstrative system in philosophy, and drew upon him the vigorous enmity of the Berlin clique, whose philosophic protagonist was Moses Mendelssohn. Jacobi was ridiculed as endeavouring to reintroduce into philosophy the antiquated notion of unreasoning belief, was denounced as an enemy of reason, as a pietist, and as in all probability a Jesuit in disguise, and was especially taken to task for his employment of the ambiguous term "belief" (*Glaube*, which may mean *belief* in the ordinary sense, or *faith* in the specifically theological significance). Mendelssohn's reply showed little more than the writer's very slight acquaintance with the Spinozistic system to which he had so frequently and so earnestly appealed, and his mortification at the public disclosure of the fact that he had remained in entire ignorance that Spinoza's *Opera Posthuma* contained the *Ethics* is said to have hastened his death.

Jacobi's next important work, *David Hume on Belief, or Idealism and Realism*, a dialogue (*David Hume über den Glauben, oder Idealismus und Realismus*, 1785), was an attempt to show not only that the term *Glaube* had been used by the most eminent writers to denote what he had employed it for in the *Letters on Spinoza*, but that the nature of the cognition of facts as opposed to the construction of inferences could not be otherwise expressed. In this writing, and especially in the *Appendix*, Jacobi came into contact with the critical philosophy, and subjected the Kantian view of knowledge to searching examination.

The outbreak of the war with the French republic induced Jacobi in 1793 to leave his home at Düsseldorf, and for nearly ten years he resided in Holstein. While there he became intimately acquainted with Reinhold, in whose *Beiträge*, pt. iii., 1801, his important work *On the Endeavour of the Critical Philosophy to bring Reason to Understanding* was first published, and with Matthias Claudius, the author of the *Wandsbecker Bote*. During the same period the excitement caused by the accusation of atheism brought against Fichte at Jena led to the

publication of Jacobi's *Letter to Fichte*, in which he made more precise the relation of his own philosophic principles to theology.

Soon after his return to Germany, Jacobi received a call to Munich in connexion with the new academy of sciences just founded there. The loss of a considerable portion of his fortune induced him to accept this offer; he settled in Munich in 1804, and in 1807 became president of the academy. In 1811 appeared his last philosophic work, directed against Schelling specially, *On Divine Things* (*Von den göttlichen Dingen*), the first part of which, a review of the *Wandsbecker Bote*, had been written in 1798. A bitter reply from Schelling was left without answer by Jacobi, but gave rise to an animated controversy in which Fries and Baader took prominent part. In 1812 Jacobi retired from the office of president, and began to prepare a collected edition of his works. He died before this was completed, on 10th March 1819. The edition of his writings was continued by his friend Köppen, and was completed in 1825. The works fill six volumes, of which the fourth is in three parts. To the second is prefixed an introduction by Jacobi, which is at the same time an introduction to his philosophy. The fourth volume has also an important preface.

The philosophy of Jacobi presents itself as in no way a system, — indeed, as, from its principle, essentially unsystematic. A certain fundamental view which underlies all his thinking is brought to bear in succession upon those systematic doctrines which appear to stand most sharply in contradiction to it, and any positive philosophic results are given only occasionally. The leading idea of the whole is that of the complete separation between understanding and apprehension of real fact. For Jacobi understanding, or the logical faculty, is purely formal or elaborative, and its results never transcend the given material supplied to it. From the basis of immediate experience or perception thought proceeds by comparison and abstraction, establishing connexions among facts, but remaining in its nature mediate and finite. The principle of reason and consequent, the necessity of thinking each given fact of perception as conditioned, impels understanding towards an endless series of identical propositions, the records of successive comparisons and abstractions. The province of the understanding is therefore strictly the region of the conditioned; to it the world must present itself as a mechanism. If, then, there is objective truth at all, the existence of real facts must be made known to us otherwise than through the logical faculty of thought; and, as the regress from conclusion to premises must depend upon something not itself capable of logical grounding, mediate thought implies the consciousness of immediate truth. Philosophy therefore must resign the hopeless ideal of a systematic (*i.e.*, intelligible) explanation of things, and must content itself with the examination of the facts of consciousness. It is a mere prejudice of philosophic thinkers, a prejudice which has descended from Aristotle, that mediate or demonstrated cognition is superior in cogency and value to the immediate perception of truths or facts.

The fundamental principle of Jacobi's system, thus sketched, presents a most interesting analogy with that which has become familiar in English philosophy through the writings of Sir W. Hamilton. Upon the historical relations between the two thinkers nothing requires here to be said. No reader of Hamilton can fail to be made aware of the great obligations the Scotch psychologist was under to his German predecessor. But attention to the results of Jacobi's fundamental doctrine, as these were wrought out by comparison of it with the speculative systems of Spinoza, Kant, and Schelling, will throw great light upon Hamilton's writings, and make clear the connexions of the several parts which in his imperfect expositions too frequently remained in obscurity.

As Jacobi starts with the doctrine that thought is partial and limited, applicable only to connect facts, but incapable of explaining their existence, it is evident that for him any demonstrative system of metaphysics which should attempt to subject all existence to the principle of logical ground must be repulsive. Now in modern philosophy the first and greatest demonstrative system of metaphysics is that of Spinoza, and it lay in the nature of things that upon Spinoza's system Jacobi should first direct his criticism. A summary of the results of his examination is thus presented (*Werke*, i. 216-223).—“(1) Spinozism is atheism; (2) the Kabalistic philosophy, in so far as it is philosophy, is nothing but undeveloped or confused Spinozism; (3) the philosophy of Leibnitz and Wolff is not less fatalistic than that of Spinoza, and carries a resolute thinker to the very principles of Spinoza; (4) every demonstrative method ends in fatalism; (5) we can demonstrate only similarities



(agreements, truths conditionally necessary), proceeding always in identical propositions; every proof presupposes something already proved, the principle of which is immediately given (*Offenbarung*, revelation, is the term here employed by Jacobi, as by many later writers, *c.g.*, Lotze, to denote the peculiar character of an immediate, unproved truth); (6) the keystone (*Element*) of all human knowledge and activity is belief (*Glaube*). Of these propositions only the first and fourth require further notice. Jacobi, accepting the law of reason and consequent as the fundamental rule of demonstrative reasoning, and as the rule explicitly followed by Spinoza, points out that, if we proceed by applying this principle so as to recede from particular and qualified facts to the more general and abstract conditions, we land ourselves, not in the notion of an active, intelligent creator of the system of things, but in the notion of an all-comprehensive, indeterminate *Nature*, devoid of will or intelligence. Our unconditioned is either a pure *abstraction*, or else the impossible notion of a completed system of conditions. In either case the result is atheism, and this result is necessary if the demonstrative method, the method of understanding, is regarded as the only possible means of knowledge. Moreover, the same method inevitably lands in fatalism. For, if the action of the human will is to be made intelligible to understanding, it must be thought as a conditioned phenomenon, having its sufficient ground in preceding circumstances, and, in ultimate abstraction, as the outflow from nature which is the sum of conditions. But this is the fatalist conception, and any philosophy which accepts the law of reason and consequent as the essence of understanding is fatalistic. Thus for the scientific understanding there can be no God and no liberty. It is impossible that there should be a God, for if so he would of necessity be finite. But a finite God, a God that is *known*, is no God. It is impossible that there should be liberty, for if so the mechanical order of phenomena, by means of which they are comprehensible, would be disturbed, and we should have an unintelligible world, coupled with the requirement that it shall be understood.

Cognition, then, in the strict sense, occupies the middle place between sense perception, which is belief in matters of sense, and reason, which is belief in supersensuous fact. (Jacobi wavered much in his terminology, especially with respect to the word reason; but even at this stage of his thinking the distinctions just named are sufficiently apparent.) Such a view, and especially the fundamental peculiarity that the categories of the understanding are to be regarded as mere forms of the conditioned, from their very nature limited and relative, presented a certain analogy to the critical philosophy, and accordingly, in the second period of Jacobi's speculative development, he is driven to a comparison of his doctrines with those of Kant.

His adverse criticism of the Kantian doctrines was directed on three points mainly, and, though in itself but ill-founded, it deserves the careful consideration of all Kantian students. (1) The categories of the understanding and the forms of intuition supply a blank scheme for the given element of sense. But if the given element be merely sensation, and not actually the external thing, we are still, Jacobi thinks, within the position of subjective idealism. At no point in the whole process do we ever get beyond empty form, bare identity. The synthetical unity of consciousness, if no reality be supplied in regard to which it may operate, is mere repetition of the form of conjunction, mere *possibility* of cognition. Whence do we obtain the reality, the *objectivity*, of knowledge? To Jacobi it seemed that Kant, in the second edition of the *Kritik*, made an effort to demonstrate the external reality of phenomena of experience, and he views the change in Kant's doctrine as the effect of his own critical comments. Nevertheless such demonstration still seems to him unsatisfactory; it yields only the thought-form of externality, not externality in fact. (2) Jacobi agrees with Kant so far as the critical view of the incapacity of understanding to encompass the ideas is concerned, but he thinks Kant in error in supposing that such incapacity results from the subjective limitation of our power of thinking and not from the nature of the categories of understanding in themselves. At the same time he holds that Kant treats the ideas unjustly, and that in his view of reason he tends to make that faculty inferior to understanding. (3) Kant's moral theory is as little satisfactory as his theory of perception. Here, too, in the demand for universally valid law as the law of a will that is its own content, Jacobi can find but the form and not the reality of a universal rule. The universal will is void of content, and the sharp opposition which in the Kantian ethics appears between the ethical motive and all modes of feeling is the natural result of mere formalism. When Jacobi endeavours to supply the place of the Kantian theorems which he rejects, the inherent weakness of his own principle becomes apparent. External things are known to us by immediate perception, a combination of intuition and belief. The principle of inference to realities is that of cause and effect, the significance of which we learn from observing the relation between our will and changes in the objective world, and this principle by a natural necessity we extend to all existence. The infinite progress from consequents to grounds, which is the

form of procedure of understanding, yields no conclusion as regards the being of a God. But when we regard the whole system of real things, we are compelled to infer a real cause, which, from the significance of the causal principle, is seen to be of necessity an active intelligent will, a God who foresees events. This apprehension of God is faith, reason, or feeling, as Jacobi, following Fries, is willing to call it.

Not even in his latest work of importance (*Von den göttlichen Dingen*), which is specifically on religion, does Jacobi manage to make clear the step, which he has himself characterized as the *salto mortale* of the human intellect, from the finite to the infinite; still less the further difficulty as to the possibility of holding that the God who for cognition is the unknown God must be held to possess providence, personality, life. He acknowledges that this is anthropomorphic, bitterly assails Schelling for identifying divine and human reason, but leaves the problem standing. The truth is that what Jacobi called feeling, and regarded as immediate knowledge, is not a simple act of mind, capable of yielding simple results, but the very essence of complex thinking. We cannot separate knowledge of things from apprehension of them in the way he has adopted. Nor can the human reason rest satisfied with a system devoid of inner coherence and harmony.

The best introductions to Jacobi's philosophy are the preface to the second vol. of the *Works*, and Appendix 7 to the *Letters on Spinoza's Theory*. There are two monographs of some extent upon him:—Kuhn, *Jacobi und die Philosophie seiner Zeit*, 1834; and Zirngiebl, *F. H. Jacobi's Leben, Dichten, und Denken*, 1867. See also *F. H. Jacobi's Auserlesener Briefwechsel*, 2d ed., by Roth, 2 vols., 1825-27; and Gildemeister's edition of Hamann's *Schriften*, vol. v. (R. AD.)

JACOBI, KARL GUSTAV JACOB (1804-1851), one of the great mathematicians of the present century, was born at Potsdam, of Jewish parentage, December 10, 1804. He studied at Berlin university, where he obtained the degree of doctor of philosophy in 1825, his thesis being an analytical discussion of the theory of fractions. In 1827 he became "extraordinary" and in 1829 "ordinary" professor of mathematics at Königsberg; and this chair he filled till 1842, when he visited Italy for a few months to recruit his health. On his return he removed to Berlin, where he lived as a royal pensioner till his death, February 18, 1851. His investigations in elliptic functions, the theory of which he established upon quite a new basis, and more particularly his development of the Theta-function, as given in his great treatise *Fundamenta Nova Theoriæ Functionum Ellipticarum* (Königsberg, 1829), and in later papers in *Crelle's Journal*, constitute his grandest analytical discoveries. Second in importance only to these are his researches in differential equations, notably the theory of the last multiplier, which is fully treated in his *Vorlesungen über Dynamik*, edited by Clebsch (Berlin, 1866). It was in analytical development that Jacobi's peculiar power mainly lay, and he made many important contributions of this kind to other departments of mathematics, as a glance at the long list of papers that were published by him in *Crelle's Journal* from 1826 onwards will sufficiently indicate. Thus he was one of the early founders of the theory of determinants; in particular, he invented the functional determinant formed of the  $n^2$  differential coefficients of  $n$  given functions of  $n$  independent variables, which now bears his name (Jacobian), and which has played an important part in many analytical investigations. Valuable also are his papers on Abelian transcendents, and his investigations in the theory of numbers, in which latter department he mainly supplements the labours of Gauss, with whom as with the other great Continental mathematicians of the day, Legendre, Bessel, Abel, &c., he was on terms of the closest intimacy. The planetary theory and other particular dynamical problems likewise occupied his attention from time to time. He left a vast store of manuscript, portions of which have been published at intervals in *Crelle's Journal*. See INFINITESIMAL CALCULUS.

JACOBITE CHURCH, an ecclesiastical organization thinly spread over Syria, Mesopotamia, and Babylonia, having for its distinctive doctrinal principle the Monophysite thesis with regard to the person of Christ; it consequently accepts the decrees of the second ("Robber") synod of

Thesus, and rejects those of the council of Chalcedon. It has some minor peculiarities in points of detail,—for example, as to the preparation of the communion elements, the mode of making the sign of the cross, and the method of electing patriarchs and bishops. Its head is called the patriarch of Antioch, who has his residence, however, for the most part at Diarbekir; second to him is the "maphrian" (*i.e.*, "fertilizer"), who has a kind of primacy over the eastern section of the church. No accurate statistics as to the numerical strength of the Jacobite Church exist; its numbers may probably be safely placed considerably under 250,000. For a considerable time a Roman Catholic patriarch of the Jacobites has resided at Aleppo, and lately the Jacobites of Damascus have accepted Catholicism. The Jacobite Church owes its origin, as its name, to Jacobus, surnamed Baradaeus and sometimes Zanzalus, a native of Tella, who became a monk at Constantinople, and afterwards receiving episcopal consecration (541 or 543 A.D.) devoted thenceforward the rest of his life (nearly forty years) to extensive labours throughout Asia Minor, Syria, Egypt, and the Mediterranean islands, on behalf of the Monophysite cause. Such were his energy and zeal that he is said to have consecrated in the course of his travels no fewer than two patriarchs, twenty-seven bishops, and fully 100,000 priests and deacons. The epithet "Jacobite" is sometimes applied with less strict propriety to the Coptic, Abyssinian, and Armenian Churches, which also are Monophysite, and owe much to the influence of Baradaeus.

JACOBS, CHRISTIAN FRIEDRICH WILHELM (1764–1847), a German scholar and author, was born at Gotha, October 6, 1764. After studying philology and theology at Jena and Göttingen, he in 1785 became teacher in the gymnasium of his native town, and in 1802 was appointed to an office in the public library. In 1807 he became classical teacher in the lyceum of Munich, but he again returned to Gotha in 1810 to take the charge of the library and the numismatic cabinet. From 1831 to 1842 he was superintendent of the art collections of the town. He died at Gotha, March 30, 1847.

Jacobs, besides editing a large number of the less known Greek and Latin authors, was a voluminous translator and also a successful writer in various departments of general literature. Of his editorial labours the most important is the edition of the *Anthologia Græca*, 13 vols., 1794–1814. He also published translations from the Greek Anthology under the title *Tempo*, 2 vols., 1803. His *Elementarbuch der griechischen Sprache*, 1805, has gone through many editions. His miscellaneous essays on classical subjects were published collectively at various periods under the title *Vermischte Schriften*, and amount in all to 8 volumes. Among his other writings may be mentioned *Schriften für die Jugend*, 3 vols., 1842–44; and *Erzählungen*, 7 vols., 1824–37.

JACOTOT, JOSEPH (1770–1840), a French educationist, and author of the method of "Émancipation intellectuelle," was born at Dijon, March 4, 1770. He was educated at the university of Dijon, where in his nineteenth year he was chosen professor of Latin, after which he studied law, became advocate, and at the same time devoted a large amount of his attention to mathematics. In 1788 he organized a federation of the youth of Dijon for the defence of the principles of the Revolution; and in 1792, with the rank of captain, he set out to take part in the campaign of Belgium, where he conducted himself with bravery and distinction. After for some time filling the office of secretary of the "commission d'organisation du mouvement des armées," he in 1794 became deputy of the director of the Polytechnic school, and on the institution of the central schools at Dijon he was appointed to the chair of the "method of sciences," where he made his first experiments in that mode of tuition which he afterwards developed more fully. On the central schools being replaced by other educational institutions, Jacotot occupied successively the

chairs of mathematics and of Roman law until the overthrow of the empire. In 1815 he was elected a representative to the chamber of deputies; but after the second restoration he found it necessary to quit his native land, and, having taken up his residence at Brussels, he was in 1818 nominated by the Government teacher of the French language at the university of Louvain, where he perfected into a system the educational principles which he had already practised with success in France. His method was not only adopted in several institutions in Belgium, but also met with some approval in France, England, Germany, and Russia. An account of it will be found in the article EDUCATION, vol. vii, pp. 677–78. After the revolution of 1830 Jacotot returned to France, and he died at Paris, July 30, 1840.

His system was described by him in *Enseignement universel, Langue maternelle*, Louvain and Dijon, 1823—which has passed through several editions—and in various other works; and he also advocated his views in the *Journal de l'Émancipation intellectuelle*. For a complete list of his works and fuller details regarding his career, see *Biographie de J. Jacotot*; by Achille Guillard, Paris, 1860.

JACQUARD, JOSEPH MARIE (1752–1834), inventor of the Jacquard silk-weaving loom, was born of humble parents at Lyons, July 7, 1752. The earlier part of his life is involved in considerable obscurity, though it is said that his mechanical talent was manifest from an early age. Jacquard married in 1777, and at the death of his father fell heir to two looms and a small sum of money. These, however, like Palissy's furniture, were sacrificed to the inventive pursuits of their owner, who was at last forced to become a lime-burner at Bresse, while his wife supported herself at Lyons by plaiting straw. In 1793 Jacquard took part in the unsuccessful defence of Lyons against the troops of the convention; but afterwards served in their ranks on the Rhone and Loire. After seeing some active service, in which his young son was shot down at his side, Jacquard again returned to Lyons, where he succeeded in finding work. He still laboured at his machines, and in 1801 a medal was awarded him for an invention which he exhibited in the industrial exhibition at Paris, whereby one workman per loom was superseded in the weaving of figured silks. Jacquard was summoned to Paris, and after interviews with Napoleon and Carnot was attached to the Conservatoire des Arts et Métiers. A loom of Vaucanson's, deposited there, suggested various improvements in his own, which he gradually perfected to its final state. In 1804 he returned to Lyons, and although his invention was fiercely opposed by the silk weavers, whom it threatened to deprive of a livelihood, its advantages were too great to suffer resistance. Many years before his death, which occurred at Oullins, a village near Lyons, on August 7, 1834, the inventor had the satisfaction of seeing his loom in almost universal use, and, as a consequence, the prosperity of his native city rapidly advancing. Jacquard was rewarded with a pension of £60, a royalty of £2 upon each loom erected, and the cross of the legion of honour. His statue was erected in Lyons in 1840.

See Lamartine's *Jacquard*, and the article WEAVING.

JADE, a name popularly applied to several distinct ornamental stones, but restricted scientifically to a definite mineral species known as *nephrite*. The term nephrite, from νεφρός, the kidney, refers to the reputed value of the mineral in renal diseases, whence it was formerly known as *Lapis nephriticus*. Probably the word *jade* is a corruption of the Spanish *hijada*, since this mineral is one of the stones which were known to the Spanish conquerors of Mexico and Peru under the name of *pieдра de hijada*, or "stone of the loins"—a name which first appears in the writings of Monardes, in 1565, as *pieдра de la yjada*. So numerous have been the names applied to this mineral in



various parts of the world, and at different times, that Professor Fischer has collected nearly one hundred and fifty synonyms of jade.

True jade, or nephrite, is a native silicate of calcium and magnesium, which may be regarded as a compact or crypto-crystalline variety of hornblende, and may be referred either to actinolite or to tremolite, according as its colour tends to green or to white. It never exhibits crystalline form or distinct cleavage; but, according to recent observers who have visited the old quarries in Turkestan, and have seen the mineral *in situ*, traces of cleavage may occasionally be observed; usually, however, the substance breaks with a splintery fracture. The specific gravity of jade varies from 2.91 to 3.06, and offers one of the readiest means of distinguishing between this mineral and others with which it is likely to be confounded. Most specimens of jade are scratched by flint or quartz, their hardness being about 6.5; but, while the hardness is not excessive, the mineral is remarkable for its toughness. It is notable that Hermann von Schlagintweit, who inspected the quarries in the Kara-kash valley, found that the hardness of the stone when freshly broken was considerably less than that assumed by it after a short exposure. The colour of jade is subject to great diversity, -- some varieties presenting almost every shade of green, while others are yellowish, grey, or even white.

So far as is at present known, no true jade has ever been detected *in situ* in Europe. A loose block has been found at Schwemsal near Leipzig, and the mineral is said to occur in the drift at Potsdam near Berlin. Corsica and Turkey have also been recorded as jade localities, but probably on insufficient grounds.

It is by the Chinese that jade has always been most highly prized, and, notwithstanding its intractability, most elaborately carved. To the Chinese it is known under the name of *yu* or *yu-chi* (yu-stone). Much of the Chinese jade was formerly obtained from quarries in the Kuen-lun mountains, on the sides of the Kara-kash valley, in Turkestan. These ancient workings were visited and described a few years ago by H. v. Schlagintweit, by Dr Stolicka, and by Dr Cayley. The mineral is found in nests and veins running through schistose and gneissose rocks. It is probable that jade occurs throughout the Kuen-lun range, and that a rich site exists to the south of Khotan. The Khotan jade has been known to the Chinese for upwards of two thousand years. In Turkestan the jade is known as *yeshm* or *yeshm*, a word which appears in Arabic as *yeshb*, and is said to be cognate with *iaspis* or jasper. Indeed, by early mineralogists the jade was often described as *jaspis viridis*. Fine boulders of dark green jade have been found by M. Alibert in the neighbourhood of his graphite mine near Batougol in Siberia. New Zealand is one of the most famous localities for jade, and the stone is highly prized by the natives, who work it, with great labour, into amulets, axe-heads, and various other objects. Among these objects may be mentioned the peculiar club-like implement known as the *mere* or *pattoo-pattoo*, and the hideous breast ornament termed *hei tiki*. By the Maories jade is known as *panamu* or "green-stone," and the occurrence of this mineral along the western coast of the south island has led to the name *Te wahi panamu*, or "the place of the green-stone," being applied to this district. Jade also occurs in New Caledonia and in some of the smaller Pacific islands. In consequence of its use by the South Sea islanders as a material for making axe-heads, it is often known to German mineralogists as *Beilstein* or "axe-stone."

Under the name of "oceanic jade," M. Damour has described a fibrous variety found in New Caledonia and in the Marquesas Islands, having a specific gravity of

3.18, and differing from ordinary nephrite in the proportion of lime and magnesia which it contains. If this oceanic jade be recognized as a distinct variety, the ordinary nephrite may be distinguished as "oriental jade."

Although it was from America that the original jade, or "spleen-stone," was introduced into Europe, it is curious that few, if any, American localities for this mineral are recorded in modern works on mineralogy. Dr Dawson has, however, noted its occurrence in British Columbia. At the time of the Spanish conquest of America, amulets in jade or in some jade-like mineral were highly venerated throughout Mexico, Central America, and Peru. It has been supposed by Mr E. G. Squier that jade was one of the green stones so greatly prized by the ancient Mexicans under the name of *chalchihuitl*. The "Amazon stone," which has sometimes been regarded as jade, is a green variety of microcline-felspar; while the "Bowenite" from Smithfield in Rhode Island, which was at one time supposed to be nephrite, is found to be a variety of serpentine of unusual hardness. Serpentine is also used as a substitute for jade in some of the common objects imported from China.

While true jade has not hitherto been found *in situ* in Europe, it is a very suggestive fact that neolithic celts and scrapers have been found among the relics of several of the ancient pile-dwellings in the lakes of Switzerland. The principal localities have been the stations of Lüscherz and Schaffis on the Lake of Biemmo (Biel), Meilen on the Lake of Zurich, and Robenhausen on the Lake of Pfäffikon. Yet no jade has been discovered among the rocks of the Swiss Alps; neither have any chippings been found which might lead us to suspect that the stone was worked in Switzerland. As it seems beyond doubt that the jade must be a foreign material, it becomes an interesting question to determine whether such objects were obtained by barter, or had been brought by the ancestors of the old lake-dwellers from their primitive abode in the East, and preserved generation after generation during their migration westwards. It should be mentioned that jade celts have been found by Dr Schliemann among the relics of the oldest of the cities at Hissarlik. A jade celt engraved with a Gnostic formula in Greek characters is preserved in the Christy collection; and among the Assyrian and Babylonian seal-cylinders in the British museum there is said to be one specimen of jade.

It was shown by M. Damour, in 1863, that much of the so-called jade is altogether different from nephrite, and must be separated as a distinct species, for which he suggested the name of "jadeite." Jadeite is a silicate of aluminium and sodium, and therefore differs widely from nephrite in chemical composition. Mineralogically its relations lie rather with epidote than with hornblende. Its colour is generally brighter than that of nephrite, and the paler-tinted kinds often contain veins of a bright-green colour. It is slightly harder than nephrite, but its most distinctive characteristic is its high specific gravity; this ranges from 3.28 to 3.35, while the density of nephrite, even in oceanic jade, never exceeds 3.18.

Much of the Chinese "jade" is really jadeite. According to Pumpelly the jadeite of Yn-nan in south-west China is known as *fei-tsu*. Jadeite also occurs to the north-west of Bhamo in Burmah. Axes of jadeite are not unfrequently found in the remains of the Swiss lake-dwellings, but the mineral is not known to occur in the rocks of Europe. Jadeite forms the substance of many ancient Mexican ornaments, while implements wrought in the same material have been found in Costa Rica. Fischer records an Egyptian scarabeus in jadeite.

The green jade-like stones which are known to the Maories as *kawa-kawa* and *tangivai* do not appear to be





the place. As early as 1544 the missionaries under Francis Xavier had made converts in this part of Ceylon, and after the conquest the Portuguese maintained their proselytizing zeal. They had a Jesuit college and a Franciscan and a Dominican monastery. The Dutch drove out the Portuguese in 1658. The Church of England Missionary Society began its work in Jaffna in 1818, and the American Missionary Society in 1822.

**JAGÁDHRI**, a municipal town in Ambálá district, Punjab, India, is situated in 30° 10' N. lat. and 77° 20' 45" E. long., a little west of the river Jumna, 37 miles south-east of Ambálá city, and 3 miles north of the Sind, Punjab, and Delhi Railway. Before the Sikh invasions, Jagádhri was a mere village; but Rái Sinh of Búria, the Sikh conqueror, encouraged the commercial and manufacturing classes to settle on the spot, so that a considerable trade rapidly sprang up. Destroyed by Nádir Sháh during one of his incursions, but rebuilt in 1783 by Rái Sinh, it passed to the British in 1829 together with the territory of which it was the capital. Jagádhri has imperts of copper and iron, considerable manufacture of metal work, and exports of vessels and tools. It contains a *tahsil*, police-office, and rest-house. The population in 1868 was 11,676, comprising 9220 Hindus, 2319 Mahometans, and 137 Sikhs.

**JAGUAR** (*Felis onca*). This powerful and ferocious animal is the largest of the species of *Felidæ* found upon the American continent. It ranges from Texas through Central and South America into Patagonia. In the countries which bound its northern limit it is not frequently met with, but in South America it is still quite common, and Azara states that when the Spaniards first settled the district between Monte Video and Santa Fé



Jaguar.

as many as two thousand were killed yearly. The jaguar is usually found singly, or sometimes in pairs, and preys upon such quadrupeds as the horse, tapir, capybara, dogs, or cattle, and its strength is so great that it has been known to swim with a horse it had killed across a wide river, and then to carry its prey into the woods. It rarely slays at a time more than is requisite to satisfy its hunger, and leaves the unconsumed portions for the benefit of any stray prowler who may find them. Its manner of killing its victim is, after springing upon it, to strike it to the earth by a blow of its powerful paw. The jaguar often feeds upon turtles, sometimes following the reptiles into the water to effect a capture; having secured one and turned it over on its back, it inserts a paw between the shells and drags out the body of the turtle by

means of its sharp claws. Occasionally, after having tasted human flesh, the jaguar becomes a confirmed man-eater. The cry of this great cat, which is heard at night, and most frequently during the pairing season, is deep and hoarse in tone, and consists of the sound *pu, pu*, often repeated. The female brings forth from two to four cubs towards the close of the year; they are able to follow their mother in about fifteen days after birth. The colour of the jaguar varies greatly among individuals, ranging from white to black, the rosette markings in the extremes being but faintly visible. The general or typical coloration is a rich tan upon the head, neck, body, outside of legs, and tail near the root. The upper part of the head and sides of the face are thickly marked with small black spots, and the rest of body is covered with rosettes, formed of black spots, with a black spot in the centre, and ranged lengthwise along the body in five to seven rows on each side. These black rings are heaviest along the back. The lips, throat, breast, and belly, the inside of the legs, and the lower sides of tail are pure white, marked with irregular spots of black, those on the breast being long bars, and on the belly and inside of legs large blotches. The tail has large black spots near the root, some with light centres, and from about midway of its length to the tip it is ringed with black. The ears are black behind, with a large buff spot near the tip. The nose and upper lip are light rufous brown. The size varies, the total length of a very large specimen measuring 6 feet 9 inches; the average length, however, is about 4 feet from the nose to root of tail. In form the jaguar is thick-set; it does not stand high upon its legs; and in comparison with the leopard it is heavily built. But its movements are very rapid, and it is fully as agile as its more graceful relative. The skull resembles that of the lion and tiger, but is much broader in proportion to its length. The forehead is concave, and the nasal region broad. The frontal processes of the maxillary are rounded, in contradistinction to the truncated form of the tiger and the pointed one of the lion, and do not extend as far back as the fronto-nasal articulation. On the inner edge of the orbit is a well-developed tubercle. The canines are long and stout, the molar series well developed. The second sillon on the outer side of the crown of the canines is rudimentary, sometimes absent.

**JAHANÁBAD**, a town in Gayá district, Bengal, situated on the Patná road, 25° 13' 10" N. lat., 85° 2' 10" E. long. Population (1872) 21,022—namely, 12,413 Hindus and 8609 Mahometans. It was at one period a flourishing trading town, and in 1760 it formed one of the eight branches of the company's central factory at Patná. Since the introduction of Manchester goods, the trade of the town in cotton cloth has almost entirely ceased; but large numbers of the Juláha or weaver caste live in the neighbourhood.

**JAHN, JOHANN** (1750–1816), a distinguished Orientalist and Biblical critic of the Roman Catholic Church, was born at Tasswitz, Moravia, on June 18, 1750. After completing his school education at Znaim he studied philosophy at Olmütz, and in 1772 began his theological studies at the Præmonstratensian convent of Bruck in the neighbourhood of Znaim. Having been ordained to the priesthood in 1775, he for a short time held a cure of souls at Mis'cz, but was soon recalled to Bruck to become professor of Oriental languages and Biblical hermeneutics there. On the suppression of the convent by Joseph II. in 1784, Jahn was removed to a chair at Olmütz corresponding to that which he had previously held, and in 1789 he was transferred to Vienna as professor of Oriental languages, Biblical archæology, and dogmatics. In 1792 he published his *Einleitung ins Alte Testament* (2 vols.), which almost

immediately began to cause him trouble; a certain Cardinal Migazzi laid a complaint against him before the emperor because in his preface he had confessed himself to have in some points departed from the views of his learned predecessors and adopted opinions of his own, while in the work itself he declared Job, Jonah, Tobit, and Judith to be didactic poems. To these charges was added a third, that in his New Testament lectures he had stated the cases of demoniacal possession there mentioned to be cases of natural disease. On the matter being referred to an ecclesiastical commission, it was reported that the views themselves were not necessarily heretical, but that Jahn had shown undue rashness in giving out, as his own, opinions which teachers of theology ought not to mention otherwise than as foreign; in accordance with this it was decided that he ought to modify his expressions in future editions of his work and in his subsequent lecturing. Although he appears honestly to have accepted this judgment, the hostility of those who were opposed to his teaching did not cease until at last (1806) he was compelled to accept a canonry at Vienna, which involved the resignation of his chair. This step had been preceded by the condemnation of his *Introductio in libros sacros Veteris Fœderis in compendium redacta*, published in 1804, and also of his *Archæologia Biblica in compendium redacta* (1805). The only work of importance, outside the region of mere philology, afterwards published by him, was the *Enchiridion Hermeneuticæ* (1812). He died August 16, 1816. Jahn's place in the history of the modern science of Biblical criticism is undoubtedly an honourable one, and also of some importance, especially when his ecclesiastical environment is taken into account. If he cannot be said to have been either very original or very profound, he has at least the merit of being laborious, candid, and clear-sighted within his range of vision; one of his books, the *Archæologia*, is not even yet entirely superseded.

Besides the works already mentioned, he published *Hebräische Sprachlehre für Anfänger*, 1792; *Aramäische od. Chaldäische u. Syrische Sprachlehre für Anfänger*, 1793; *Arabishe Sprachlehre*, 1796; *Elementarbuch der Hebr. Sprache*, 1799; *Chaldäische Chrestomathie*, 1800; *Arabishe Chrestomathie*, 1802; *Lexicon Arabico-Latinum Chrestomathias accomodatam*, 1802; an edition of the Hebrew Bible, 1805; *Grammatica linguæ Hebræicæ*, 1809; a critical commentary on the Messianic passages of the Old Testament (*Vaticinia prophetarum de Jesu Messia*), 1815. In 1821 a collection of *Nachträge* appeared, containing six dissertations on Biblical subjects. The English translation of the *Archæologia* by Upham has passed through several editions. See A. G. Hoffmann's article in Ersch and Gruber's *Encyclopædie*.

JAHN, OTTO (1813-1869), eminent alike as an archæologist, philologist, and art critic, was born June 16, 1813, at Kiel, where he began under Nitzsch the philological and archæological education which he continued at Leipsic under Hermann and at Berlin under Lachmann and Gerhard. After the completion of his university studies he travelled for three years (1836-39) in France and Italy; having "habilitated" in 1839 at Kiel, he in 1842 became professor-extraordinary of archæology and philology at Greifswald, where in 1845 he was promoted to the rank of ordinarus. In 1847 he accepted the chair of archæology at Leipsic, but for having taken part in the political movements of 1848-49 he was deprived in 1851. He continued to remain in private life until in 1855 he was appointed ordinary professor of the science of antiquity, and director of the academical art museum at Bonn. In 1867 he was called to succeed Gerhard at Berlin; but after a lingering illness he died at Göttingen, September 9, 1869.

The following list of his works is not to be regarded as exhaustive. 1. Archæological: *Telephos u. Troilos*, 1841; *Die Gemälde des Polygnot*, 1841; *Specimen epigraphicum in memoriam Kellermannii*, 1842; *Pentheus u. die Menaden*, 1842; *Paris u. Oionoe*, 1845; *Die hellenische Kunst*, 1846; *Peitho, die Göttin der Uebersetzung*, 1847; *Ueber einige Darstellungen des Paris-Urtheils*, 1849; *Die*

*Ficoronense Cista*, 1852; *Beschreibung der Vasensammlung des Königs Ludwig*, 1854; *Die Wandgemälde des Columbariums in der Villa Pamfili*, 1857; *Pausanias descriptio arcis Atheniensis*, 1860; *Bestimmungen griechischer Dichter auf Vasenbildern*, 1861; *Ueber bemalte Vasen mit Goldschmuck*, 1865; *Ueber Darstellungen des Handwerks u. des Handelsverkehrs*, 1868. 2. Philological: Critical editions of Persius, 1843; Censorinus, 1845; Florus, 1852; the *Brutus*, 1849, and *Orator*, 1851, of Cicero; Juvenal, 1851; the *Periochæ* of Livy, 1853; the *Psyche et Cupido* of Apuleius; the *Electra* of Sophocles, 1861; Longinus, 1867. 3. Biographical and Æsthetic: *Ueber Mendelssohn's Paulus*, 1842; *Biographie Mozarts*, a work of extraordinary labour and loving care, 1856-1860; *Ludwig Uhland*, 1853; *Gesammelte Aufsätze über Musik*, 1866; *Biographische Aufsätze*, 1866.

JAINS, the most numerous and influential sect of heretics, or nonconformists to the Brahmanical system of Hinduism, in India, are found in every province of Upper Hindustan, in the cities along the Ganges, and in Calcutta. But they are more numerous to the west—in Mewar, Guzerat, and in the upper part of the Malabar coast—and are also scattered throughout the whole of the southern peninsula. They are mostly traders, and live in the towns; and the wealth of many of their community gives them a social importance greater than would result from their mere numbers. Of what their actual number may be it is unfortunately impossible to form any exact estimate, as in the census returns they are confounded with the Buddhists. Their magnificent series of temples and shrines on Mount Abu, one of the seven wonders of India, is perhaps the most striking outward sign of their wealth and importance.

The Jains are the last direct representatives on the continent of India of those schools of thought which grew out of the active philosophical speculation and earnest spirit of religious inquiry so rife in the valley of the Ganges during the 5th and 6th centuries before the Christian era. For many centuries Jainism was so overshadowed by that stupendous movement, born at the same time and in the same place, which we call Buddhism, that it remained almost unnoticed by the side of its powerful rival. But when Buddhism, whose widely open doors had absorbed from the mass of the community, became thereby corrupted from its pristine purity and gradually died away, the smaller school of the Jains, less diametrically opposed to the victorious orthodox creed of the Brahmans, survived, and in some degree took its place.

Jainism purports to be the system of belief promulgated by Vardhamana, better known by his epithet of Mahā-vīra, who was a contemporary of Gautama, the Buddha. But the Jains, like the Buddhists, believe that the same system had previously been proclaimed through countless ages by each one of a succession of earlier teachers. The Jains count twenty-four such prophets, whom they call Jinas, or Tirthankaras, that is, conquerors or leaders of schools of thought. It is from this word Jina that the modern name Jainas, meaning followers of the Jina, or of the Jinas, is derived. This legend of the twenty-four Jinas contains a germ of truth. Mahā-vīra was not an originator; he merely carried on, with but slight changes, a system which existed before his time, and which probably owes its most distinguishing features to a teacher named Pārṣwa, who ranks in the succession of Jinas as the predecessor of Mahā-vīra. Pārṣwa is said, in the Jain chronology, to have lived two hundred years before Mahā-vīra (that is, about 700 B.C.); but the only conclusion that it is safe to draw from this statement is that Pārṣwa was considerably earlier in point of time than Mahā-vīra. Very little reliance can be placed upon the details reported in the Jain books concerning the previous Jinas in the list of the twenty-four Tirthankaras. The curious will find in them many reminiscences of Hindu and Buddhist legend; and the antiquarian must notice the distinctive symbols assigned to each, in order to recognize



the statues of the different Jinas, otherwise identical, in the different Jain temples.

Very little is at present known of the details of the Jain system of belief. But fresh light is being thrown upon this question year by year, and some of their principal tenets are already beyond dispute. The Jains are divided into two great parties,—the *Digambaras*, or Sky-clad Ones, and the *Svetāmbaras*, or the White-robed Ones. The latter have only as yet been traced, and that doubtfully, as far back as the 6th century after Christ; the former are almost certainly the same as the Niganthas, who are referred to in numerous passages of the Buddhist Pāli Pitakas, and must therefore be at least as old as the 4th century B.C. In many of these passages the Niganthas are mentioned as contemporaneous with the Buddha; and details enough are given concerning their leader Nigantha Nāta-putta (that is, the Nigantha of the Jnātrika clan) to enable us to identify him, without any doubt, as the same person as the Vardhamāna Mathā-vira of the Jain books. This remarkable confirmation, from the scriptures of a rival religion, of the Jain tradition seems conclusive as to the date of Mathā-vira; and, should any one still doubt the antiquity of the sect, it may be mentioned here that the Niganthas are referred to in one of Asoka's edicts (*Corpus Inscriptionum*, Plate xx.). Unfortunately the account of the teachings of Nigantha Nāta-putta given in the Buddhist scriptures are, like those of the Buddha's teachings given in the Brahmanical literature, not only very meagre, but also very little to be depended upon. And the Jain scriptures themselves, though based on earlier traditions, are not older in their present form than the 6th century of our era. The most distinctively sacred books are called the forty-five Āgamas, consisting of eleven Angas, twelve Upangas, ten Prakṛṅakas, six Chedas, four Māla-sūtras, and two other books. Several of these are in process of translation into English for the series of translations from the sacred books of the East now being published under the auspices of the university of Oxford. It was Devaddhi-gaṇin, who occupies among the Jains a position very similar to that occupied among the Buddhists by Buddhaghosa, who at the date just mentioned collected the then existing traditions and teachings of the sect into these forty-five Āgamas. It is most probable that, previous to his time, the sacred lore of the Jains was handed down by memory, and not by writing. This mode of transmitting a literature seems very unsafe according to modern European ideas. But when we call to mind the very great value of the historical results drawn from the Vedas and the Buddhist scriptures, both of which were for many centuries preserved for posterity by memory alone, we may confidently look forward to important additions to our knowledge when the Jain Āgamas shall have been made accessible to European scholars. Like the Buddhist scriptures, the earlier Jain books are written in a dialect of their own, the so-called Jaina Prakṛit; and it was not till between 1000 and 1100 A.D. that the Jains adopted Sanskrit as their literary language.

The most distinguishing outward peculiarity of Mathā-vira and of his earliest followers was their practice of going quite naked, whence the term *Digambara*. Against this custom Gaṅtama, the Buddha, especially warned his followers; and it is referred to in the well-known Greek phrase *Gymnosophist*, used already by Megasthenes, which applies very aptly to the Niganthas. Even the earliest name Nigantha, which means "free from bonds," may not be without allusion to this curious belief in the sanctity of nakedness, though it also alluded to freedom from the bonds of sin and of transmigration. The statues of the Jinas in the Jain temples, some of which are of enormous size, are still always quite naked; but the Jains themselves have abandoned the practice, the Digambaras being sky-clad at meal time only, and the Svetāmbaras being always completely clothed. And even among the Digambaras it is only the recluses or *Vatis*, men devoted to a religious life, who carry out this practice. The Jain laity—the *Srāvakas*, or disciples—do not adopt it.

The supreme aim of the Jains as of the Buddhists is called *Nirvāṇa*; but the word conveys different ideas in the two religions. The Jains appear to believe in the existence of a soul inside the human body, and in the transmigration of souls; and their Nirvāṇa seems to consist in the delivery of the soul from this transmigration. It differs from the *moksha* of the Hindus in that the Jains, not teaching the existence of a supreme being, do not hope for an absorption of the soul into the deity. This Nirvāṇa will follow on the belief in certain metaphysical theories, the nature of which still remains unknown to scholars. But it is to be accompanied by the practice of the four virtues—liberality, gentleness, piety, and remorse for failings—by goodness in thought, word, and deed, and by kindness to the brute creation and even to the forms of vegetable life. This last item in their belief, though common to the Jains and the Buddhists, has been carried out by the Jains to a more extreme result, and seems to be based on the wide extension of the doctrine of the soul. They regard all animals and plants as endowed with souls, and they consider it an act of piety to put up and to maintain hospitals for sick animals. They believe also in the existence of numerous nigels or demons, good and bad, among whom they include most of the deities of the Hindu pantheon; and the later Jains do not scruple to render a kind of worship to these spirits. This practice is, however, not in accordance with the earlier and stricter Jainism; and it is the negative side of their creed, their denial of the power of the gods, of the authority of the Vedas, and of the sacredness of caste, which has been the most important part of their teaching. Practically, no doubt, many of their laity adhere to some of the social caste distinctions of the Hindus; and their authors quote the Vedas with respect when passages from the Vedas can be used in support of their own views; but no distinction of caste excludes from their religious orders, or prevents the attainment of their Nirvāṇa; and the Vedas, even when quoted, are not regarded as conclusively authoritative. Professor Jacobi, who is the best authority on the history of this sect, thus sums up the distinction between the Mathā-vira and the Buddha: "Mathā-vira was rather of the ordinary class of religious men in India. He may be allowed a talent for religious matters, but he possessed not the genius which Buddha undoubtedly had. . . . The Buddha's philosophy forms a system based on a few fundamental ideas, whilst that of Mathā-vira scarcely forms a system, but is merely a sum of opinions (*pannathā*) on various subjects, no fundamental ideas being there to uphold the mass of metaphysical matter. Besides this . . . it is the ethical element that gives to the Buddhist writings their superiority over those of the Jains. Mathā-vira treated ethics as corollary and subordinate to his metaphysics, with which he was chiefly concerned."

*Authorities.*—Bhadrabāhn's *Kalpa Sūtra*, the recognized and popular manual of the Svetāmbara Jains, edited with English introduction by Professor Jacobi, Leipzig, 1879; Hemacandra's "Yoga Sūtram," edited by Windisch, in the *Zeitschrift der deutschen morgenl. Ges.* for 1874; "Zwei Jaina Sūtras," edited in the *Indische Studien*, vol. xv., *Zin Fragment der Bhagavati*, by Professor Weber; *Mémoires de l'Académie de Berlin*, 1865; *Nirayavalīya Sūtra*, edited by Dr. Warren, with Dutch introduction, Amsterdam, 1879; *Over de godsdienstige en wifsiggerige Begrippen der Jainas*, by Dr. Warren (his doctor-dissertation, Zwolle, 1875); *Beiträge zur Grammatik des Jaina-Prakṛit*, by Dr. Edward Müller, Berlin, 1876; Colebrooke's *Essays*, vol. II. Mr. Burgess has an exhaustive account of the Jain Cave Temples (none older than the 7th century) in Fergusson and Burgess's *Cave Temples in India*, London, 1850. (T. W. R. D.)

**JĀINTIA HILLS.** For administrative purposes the Jaintia Hills are regarded as a subdivision of the Khāsi and Jaintia Hills district, in the province of Assam. They cover an area of about 2000 square miles, and are bounded N. by the district of Nowgong, E. by Cachar, S. by Sylhet, and W. by the Khāsi Hills.

The Jaintia Hills are divided into twenty-five fiscal divisions, of which three are inhabited by Kukī or Lushāi immigrants, and one by Mikirs. The remainder of the inhabitants are Syntengs, a race akin to the Khāsis, but with distinct ethnical characteristics and language. The chief crop is rice, grown on the nomadic system of agriculture known as *jūm*. The most valuable natural product is limestone, which is quarried on the river banks, and despatched by water into Bengal from the Sylhet markets. Coal of excellent quality has been found in situations mostly inaccessible to water traffic. The Syntengs are keen traders, and retain in their own hands the valuable commerce of their hills. They frequent the markets held in the chain of villages at the foot of the hills on the Sylhet side. In 1876-77 the total value of exports from the subdivision was £19,000, and of the imports (chiefly cotton, woollen, and silk cloth, rice, dried fish, salt, and tobacco) £34,560. The gross revenue in the same year was £1271.

This tract was annexed in 1835, its rājā having been deposed for complicity in carrying away British subjects, and in their immolation as human sacrifices in a shrine of the goddess Kālī. At first no change was made in the indigenous revenue system, which consisted simply in the payment of a he-goat once a year by each village. In 1860, when a fresh taxation was introduced, the hillmen objected; and in January 1862 they rose in open rebellion. The police station at Jowai was burned to the ground, the garrison of sepoy's was closely besieged, and all show of British authority was swept away throughout the hills. The hillmen fought bravely for their independence. At first they were successful in cutting off several detachments of sepoy's and police, but the ringleaders were captured, and order finally restored in March 1863.

**JĀIPUR.** See **JEYPORE.**

**JĀISALMIR**, a native state in Rājputāna, under the political superintendence of that agency and the Government of India, lying between 26° 5' and 28° 24' N. lat. and between 69° 30' and 72° 50' E. long., with an area of 16,447 square miles, is bounded on the N. by Bahāwalpur, on the E. by Bikaner and Jodhpur, on the S. by Jodhpur and Sind, and on the W. by Khairpur state and Sind.

Jāisalmir is almost entirely a sandy waste, forming a part of "the Great Indian Desert." The general aspect of the country is that of an interminable sea of sandhills, of all shapes and sizes, some rising to a height of 150 feet. Those in the west are covered with *phog* bushes, those in the east with tufts of long grass. Water is scarce, and generally brackish; the average depth of the wells is said to be about 250 feet. There are no perennial streams, and only one small river, the Kakni, which, after flowing a distance of 28 miles, spreads over a large surface of flat ground, and forms a lake or *jhil* called the Bhuj-Jhil. The climate is essentially dry and healthy. The temperature is highest in May and June; the coldest months are from the middle of December to the middle of February. Throughout Jāisalmir, only rain-crops, such as *bājra*, *joār*, *moth*, *ūl*, &c., are grown; spring crops of wheat, barley, &c., are very rare. Owing to the scanty rainfall, irrigation is almost unknown.

The main part of the population lead a wandering life, grazing their flocks and herds. Large herds of camels, horned cattle, sheep, and goats are kept. The principal trade is in wool, *ghī*, camels, cattle, and sheep. The chief imports are grain, sugar, foreign cloth, piece-goods, &c. There is only one civil court. Education is at a very low ebb. Jain priests are the chief schoolmasters, and their teaching is very elementary. The income of the state for 1873-74 was £11,854, the expenditure £15,911. The mahārājā has a force of 651 infantry and 155 cavalry, who have no drill or discipline, but are very efficient as police. It has been estimated that the total number of inhabitants does not exceed 72,000; 43,500 are said to be Hindus, 26,000 Mahometans, and 2,500 Jains.

The majority of the inhabitants are Yadu Bhati Rājputs, who take their name from an ancestor named Bhati, renowned as a warrior, when the tribe were located in the Punjab. Shortly after this the clan was driven southwards, and found a refuge in the Indian desert, which was thenceforth their home. Dcorāj, a famous prince of the Bhati family, is esteemed the real founder of the present Jāisalmir dynasty, and with him the title of *rāval* commenced. In 1156 Jāisāl, the sixth in succession from Dcorāj, founded the fort and city of Jāisalmir, and made it his capital. Jāisāl was succeeded by several warlike princes, who were constantly engaged in battles and raids. In 1294 the Bhatias so enraged the emperor Alā-ud-dīn that his army captured and sacked the fort and city of Jāisalmir, so that for some time it was quite deserted. After this there is nothing to record till the time of Rāwāl Sabal Sīah, whose reign marks an epoch in Bhati history in that he acknowledged the supremacy of the Delhi emperor Shāh Jahān, and was the first of the Jāisalmir princes who held his dominions as a fief of the Delhi empire. The Jāisalmir princes had now arrived at the height of their power, but from this time till the accession of Rāwāl Mulraj in 1762 the fortunes of the state rapidly declined, and most of its outlying provinces were lost. In 1813 Mulraj entered into political relations with the British. Since his death in 1820, no stirring events have occurred. The present chief is Mahārājā Bairi Sal, who was born in 1843, and is a Yadu Bhati Rājput. The ruler of Jāisalmir is styled *mahārājāval*, and holds that position as head of the clan of Bhatias. The constitution may be described as tribal suzerainty in process of conversion to the feudal stage. Many of the tribal chiefs are to a great extent independent, inasmuch that they hold their estates rent free.

**JĀJPUR**, or **JAJPORE**, a municipal town in Cuttack district, Beugal, is situated on the right bank of the Baitarāni river, in 20° 50' 45" N. lat., 86° 22' 56" E. long. It contains the usual subdivisional and public buildings, a charitable dispensary, a Government-aided school, &c. It was the capital of the province of Orissa under the Kesari dynasty until the 11th century, when it was superseded by Cuttack, the modern metropolis. Jājpur is celebrated as a settlement of Brāhman Sivaite priests, and as the headquarters of one of the four regions of pilgrimage into which Orissa is divided, viz., that sacred to Parvatī, the wife of the All-Destroyer. In Jājpur are numerous ruins of Sivaite temples, sculptures, &c. In the 16th century this town was the scene of the struggle between Musalmān and Hindu powers, from which it emerged in ruins. It, however, still ranks as the fourth town of Orissa, and derives much wealth from its yearly fair in honour of Barunī, "Queen of the Waters," at which numbers of pilgrims assemble to bathe in the holy Baitarāni, the Sīx of Hindu mythology. The population in 1872 numbered 10,753.

**JAKOB**, **LUDWIG HEINRICH VON** (1759-1827), a German writer on political economy, was born at Wettin, 26th February 1759. After receiving preparatory instruction at Merseburg and at the gymnasium of Halle, he in 1777 entered the university of the latter city, at first devoting his attention specially to philological studies. In 1780 he was appointed teacher at the gymnasium, and, now occupying his leisure chiefly with the study of philosophy, he in 1785 obtained the degree of doctor of philosophy, and in 1791 was appointed professor of philosophy at the university. The suppression of the university of Halle having been decreed by Napoleon, Jakob betook himself to Russia, where in 1807 he was appointed professor of political economy at Kharkoff, and in 1809 a member of the Government commission to inquire into the finances of the empire. In the following year he became president of the commission for the revision of criminal law, and he at the same time obtained an important office in the finance department, with the rank of counsellor of state; but in 1816 he returned to Halle to occupy the chair of political economy. He died at Lauchstädt, July 22, 1827.

Shortly after his first appointment to a professorship in Halle, Jakob had begun to turn his attention rather to the practical than the speculative side of philosophy, and in 1805 he published at Halle *Lehrbuch der Nationalökonomie*, in which he was the first to advocate in Germany the necessity of a distinct science dealing specially with the subject of national wealth. His principal other works are *Grundriss der allgemeinen Logik*, Halle, 1788; *Grundsätze der Polizeigesetzgebung und Polizeianstalten*, Leipsic, 1809; *Einführung in das Studium der Staatswissenschaften*, Halle, 1819; *Entwurf eines Criminalgesetzbuchs für das Russische Reich*, Halle, 1818; and *Staatsfinanzwissenschaft*, 2 vols., Halle, 1821.

**JALALABAD.** See **AFGHANISTAN.**

**JALANDHAR**, or **JULLUNDUR**, a British district in the lieutenant-governorship of the Punjab, India, lies between 30° 56' 30" and 31° 37' N. lat., and between 75° 6' 30" and 77° 49' 15" E. long., forming the southernmost district in the division<sup>1</sup> of the same name. It is bounded on the N.E. by the district of Hushiārpur, on the N.W. by the native state of Kapurthāla and the river Biās, and on the S. by the Sutlej. The blunt triangular tongue of land enclosed by the confluent streams of the Sutlej and the Biās bears the general name of the Jalandhar Doab. Its submontane portion belongs to Hushiārpur; the remainder is divided between Kapurthāla state and the district of

<sup>1</sup> Jalandhar, a division under a commissioner in the Punjab, comprises the three districts of Jalandhar, Hoshiarpur, and Kangra, between 30° 56' 30" and 32° 59' N. lat., and 75° 6' 30" and 77° 49' 15" E. long., with an area of 12,181 square miles, of which 2738 are cultivated, and a population (1898) of 2,477,536, of whom 1,334,653 are males and 1,142,883 females.



Jalandhar. Below the hills, the whole Doáb consists of one unbroken alluvial expanse; whose fertility extends from river to river. A well-defined bank marks the bed of the Sutlej on the Jalandhar side. In winter the river contains about 15 feet of water in its deepest parts, and is navigable at all seasons for large flat-bottomed country boats. The main channel shifts from year to year through the wide bed, often forming new islands by slight changes in its course. The Biás touches upon the district for a few miles only. The torrents from the Siwálik hills in Hushiárpur district unite in two main streams, the White and the Black Ben, the former of which runs through the whole of Jalandhar. The White Ben receives numerous affluents, which meet it at right angles; and, following a serpentine path in a deep channel, it finally falls into the Sutlej 4 miles above its junction with the Biás. Several marshy lakes (*jhils*) collect a considerable quantity of water in the rains, which they retain throughout the dry season.

The chief staples are wheat, barley, gram, rice, sugar-cane, Indian corn, *jowar*, cotton, and moth. Except on the low alluvial tract of the Sutlej, irrigation is carried on by means of wells, worked with Persian wheels. Water lies everywhere near the surface, and is absolutely necessary for the higher cereals and sugar-cane, so that well irrigation prevails very generally. The traffic of the district consists mainly in its agricultural produce. Sugar-cane forms the chief commercial crop, and sugar and molasses are largely manufactured. English piece-goods and draught cattle are the principal imports. Cotton cloth, silver wire, and gold and silver lace are manufactured at Jalandhar town. The Sind, Punjab, and Delhi Railway passes through the district, with stations at several of the principal towns. Education was carried on in 1875-76 by means of 1615 aided schools, with a total roll of 7876 pupils. The proximity of the hills renders the climate of Jalandhar comparatively moist, and the annual rainfall for the seven years ending 1872-73 amounted to 28.6 inches. Malarious fever in an endemic form proves the chief cause of mortality, but small-pox often appears as an epidemic, and dysenteric complaints are frequent. There are five Government charitable dispensaries, which afforded relief in 1872 to 34,308 persons.

Jalandhar ranks first in the density of its population amongst all the Punjab districts, and is only exceeded by those of Benares, Jaunpur, and Gházipur in the North-Western Provinces. The enumeration of 1868, taken over an area of 1332 square miles, disclosed a total population of 794,764 persons, of whom 436,639 were males and 358,075 females. As regards religion, Hindus numbered 318,401; Mahometans, 358,427; Sikhs, 117,167; and others, 769. The district contained eleven municipal towns in 1875-76, whose names and populations were as follows:—Jalandhar, 48,933; Kartárpur, 10,953; Aláwalpur, 4873; Adampur, 3269; Banga, 4508; Nawashahr, 4946; Rahon, 14,394; Phillaur, 7535; Narnahál, 7866; Mahatpur, 6374; and Nakodar, 8800. The following towns had populations exceeding 5000 in 1868:—Basti Shaikh, 8000; Bilga, 6441; Jandiála, 6439; Malsián, 6256; and Rurkha Kalan, 5721. The district contains a total cultivated area of 657,094 acres, of which 200,097 are artificially irrigated.

The Jalandhar Doáb in early times formed a separate Hindú kingdom, ruled by a family of Rájputs, whose descendants still exist in the petty princes of the Kangra hills. Under Mahometan rule the Doáb was generally attached to the province of Lahore, in which it is included as a *sarkar* or governorship in the great revenue survey of Akbar's reign. Its governors seem to have held a partially independent position, subject to the payment of a fixed tribute into the imperial treasury. The Sikh reaction extended to Jalandhar at an early period, and a number of petty chieftains established themselves by force as independent princes throughout the Doáb. In 1766 the town of Jalandhar fell into the hands of the Sikh confederacy of Faiz-ullá-puria, then presided over by Khushal Singh. His son and successor built a masonry fort in the city, while several other leaders similarly fortified themselves in the suburbs. Meanwhile, Ranjit Singh was consolidating his power in the south, and in 1811 he annexed the Faiz-ullá-puria dominions in the Doáb. By the autumn of the same year the mahárája's authority was successfully established. Thenceforth Jalandhar became the capital of the Lahore possessions in the surrounding Doáb up to the date of the British annexation, which took place at the close of the first Sikh war.

JALANDHAR, a municipal town and cantonment in the above district, is situated in 31° 19' 50" N. lat. and 75° 37' 20" E. long. It lays claim to considerable antiquity, having been the original capital of the Rájput kingdom of Kátoch, which dates back to the period

before Alexander's invasion. I-twen Tsang, the Chinese Buddhist pilgrim of the 7th century, describes the town as 2 miles in circuit, the metropolis of a considerable state. Ibráhim Sháh of Ghazni reduced the town to the Mahometan yoke, and it appears as a place of considerable strength during the early Musalmán times. The modern city consists of a cluster of wards, originally distinct, and each enclosed by a wall of its own. Some of them still remain detached, but the majority have now united. The cantonment is 4 miles from the town, and was established in 1846. It has an area of 7½ square miles, and a population (1868) of 11,634 persons. Numerous suburbs, known as *bastia*, surround the city. The trade, though considerable, presents little special interest. The staples of local traffic are English piece-goods and country produce. In 1871-72 the imports were valued at £105,248, and the exports at £96,020. The population in 1868 was 50,067, of whom 15,921 were Hindus, 33,601 Mahometans, 468 Sikhs, and 77 Christians.

JALAP, a cathartic drug consisting of the tuberous roots of *Ecozonium Purga*, Benth., a convolvulaceous plant growing on the eastern declivities of the Mexican Andes at



Jalap (*Ecozonium Purga*).

an elevation of 5060 to 8000 feet above the level of the sea, more especially about the neighbourhood of Chiconquiaco, and near San Salvador on the eastern slope of the Cofre de Perote. In these localities, where the temperature varies during the day from 60° to 75° Fahr. (15° to 24° C.), and rain falls almost every day, it flourishes in the deep rich soil of shady woods. Jalap has been known in Europe

since the beginning of the 17th century, and derives its name from the city of Jalapa in Mexico, near which it grows, but its botanical source was not accurately determined until the year 1829, when Dr Coxe of Philadelphia published a description and coloured figure taken from living plants sent him two years previously from Mexico. The Jalap plant has slender herbaceous twining stems, with alternately-placed cordate acuminate leaves sharply pointed at the basal angles, and salver-shaped deep purplish-pink flowers. The underground stems are slender and creeping; their vertical roots enlarge and form turnip-shaped tubers, which, as they do not bear leaf organs on their surface, are sometimes called tubercules. The roots are dug up in Mexico throughout the year, and are suspended to dry in a net over the hearth of the Indians' huts, and hence acquire a smoky odour. The large tubers are often gashed to cause them to dry more quickly. In appearance they vary from spindle-shaped to ovoid or globular, and in size from a pigeon's egg to a man's fist. Externally they are brown, and marked with small transverse paler scars, and internally they present a dirty white resinous or starchy fracture. The ordinary drug is distinguished in commerce as Vera Cruz jalap, from the name of the port whence it is shipped. The average annual imports into Great Britain have been estimated at 180,000 lb.

Jalap has been cultivated for ten years past in India, at Ootacamund, and grows there as easily as a yam, often producing clusters of tubers weighing over 9 lb; but these, as they differ in appearance from the commercial article, have not as yet obtained a place in the English market. They are found, however, to be rich in resin, containing 18 per cent. In Jamaica also the plant has been grown, at first amongst the cinchona trees but more recently in new ground, as it was found to exhaust the soil. The 1880 crop of jalap in Jamaica amounted to 14,294 lb, and sold in the fresh state for £62, 3s. 8d. Some of it was exported to the London market.

Jalap owes its properties to *jalapin*, a resin which is present in it to the extent of 12 to 18 per cent. According to Mayer<sup>1</sup> its composition is  $C_{31}H_{50}O_{10}$ . Jalapin is soluble in alcohol, but insoluble in ether and bisulphide of carbon. Jalap also contains in small quantity *convolvulin*, a resin soluble in ether, homologous with jalapin, and of the composition  $C_{34}H_{50}O_{16}$ . It yields also about 19 per cent. of sugar according to Guibourt, and starch, gum, uncrystallizable sugar, and colouring matter.

Besides Mexican or Vera Cruz jalap, a drug called Tampico jalap has been imported during the last few years in considerable quantity. It has a much more shrivelled appearance and paler colour than ordinary jalap, and lacks the small transverse scars present in the true drug. It differs also in containing in the place of jalapin a resin identical with the convolvulin above mentioned, and with the para-rhodeoretin of Kayser, which exists in it to the extent of 11 per cent. This kind of jalap, the Purga de Sierra Gorda of the Mexicans, was traced by Hanbury to *Ipomea simulans*, Hanbury. It grows in Mexico along the mountain range of the Sierra Gorda in the neighbourhood of San Luis de la Paz, from which district it is carried down to Tampico, whence it is exported. A third variety of jalap known as woody jalap, male jalap, or Orizaba root, or by the Mexicans as Purga macho, is derived from *Ipomea orizabensis*, Ledanois, a plant of Orizaba. The root occurs in fibrous pieces, which are usually rectangular blocks of irregular shape, 2 inches or more in diameter, and are evidently portions of a large root. It is only

occasionally met with in commerce. The resin contained in it is identical with that found in Tampico jalap.

According to Dr W. Rutherford, jalap acts as a powerful hepatic and intestinal stimulant. It is used as a hydragogue cathartic in combination with cream of tartar in dropsy, and in all cases where it is desirable to cause a copious watery evacuation, also as a vermifuge. Buchheim asserts that jalap is only purgative when combined with bile, in which the resin is soluble.

JALAPA, or XALAPA, the Aztec Xalapan, a town of Mexico, in the state of Vera Cruz, and about 70 miles inland from the city and port of that name, with which it communicates by a railway opened since 1870. There are few towns in Mexico which are so happily situated: at a height of 4500 feet above the sea, on the edge of the plateau behind which towers the summit of Macul-tepec, it looks out over the rich lowlands of the *tierra caliente*, enjoying their beauty and escaping their baneful vapours. The immediate vicinity is abundantly fertile, and yields a harvest of rare variety for the botanist. The town lost much of its importance as a commercial entrepôt by the opening of the railway from Vera Cruz *via* Orizaba to Mexico, but the line above mentioned may help to restore its prosperity. Of chief note among the public buildings are the principal church and the old Franciscan monastery, built in 1555. The population is stated at 10,000.

JALÁUN, a British district in the lieutenant-governorship of the North-Western Provinces of India, lies between 25° 46' and 26° 26' N. lat., and between 78° 59' and 79° 55' E. long., with an area of 1553 square miles, and forms the northern district of the Jhānsi division. It is bounded on the N.E. and N. by the river Jumna, on the W. by the Gwalior and Datia states, on the S. by the Samthar state and the river Betwa, and on the E. by Baoni state. The district lies entirely within the level plain of Bundelkhand, north of the hill country, and is almost surrounded by the Jumna and its tributaries the Betwa and Pabūj. The central region thus enclosed is a dead level of cultivated land, almost destitute of trees, and sparsely dotted with villages. The southern portion especially presents one unbroken sheet of cultivation. The boundary rivers form the only interesting feature in Jalāun. The little river Noh flows through the centre of the district, which it drains by innumerable small ravines instead of watering. Jalāun has little picturesqueness or beauty, but possesses great fertility and abundant agricultural resources.

The census of 1872 gives a population of 404,384, of whom 216,607 were males and 187,777 females. The principal tribes are the Brāhmans, the Kūrmis, the Gūjars, the Kachhwāhas, the Lengars, the Kayaths, and the Musalmāns. There were four towns in 1872 with a population exceeding 5000:—Kālpi, 15,570; Kūneh, 14,448; Jalāun, 10,197; and Urāi, 6398. The staple crops are the cereals, gram, and cotton. Oil-seeds, dye-stuffs, and sugar-cane are also raised, but in no large quantities. Irrigation was employed in 1872 over 19,157 acres. Jalāun has suffered much from the noxious *Kāns* grass, owing to the spread of which many villages have been abandoned and their lands thrown out of cultivation. Drought is the great danger in Jalāun. The last important drought was that of 1868-69; no actual famine resulted, but great distress prevailed. Jalāun is almost entirely an agricultural district, and its trade accordingly depends mainly upon its raw materials and food-stuffs. Kālpi is the great mart of the district; Kūneh is also a considerable trading town. The river traffic by Kālpi is chiefly for through goods; and the Jumna is little used as a highway. A good commercial road connects Urāi and Jalāun with Phāpūnd, the railway station on the East Indian line. There is also a great military road from Kālpi to Jhānsi. The administration is on the non-regulation system, which unites civil, criminal, and fiscal functions in the same officer. In 1860 there were 1434 children under instruction; in 1871, 2703. The climate, though hot and dry, is not considered unhealthy. The mean temperature is 81°·9 Fahr. The prevailing diseases are fevers, and dysentery and other bowel complaints.

Jalāun seems to have been subject to the Nāga dynasty, which

<sup>1</sup> By Mayer, Gmelin, and others, jalapin is called convolvulin. It is identical with the rhodeoretin of Kayser.



lasted from the 1st to the 3d century of our era. In course of time the eastern portion fell under the power of the Chandels, while the western districts, including that of Jaláun, were ruled by the Kachhwahas, a Rájput clan. These seem to have held most of the district until the invasion of the Bundelas in the 14th century. But the town of Kálpi on the Jumna was conquered for the princes of Ghor as early as 1196. Early in the 14th century the Bundelas occupied the greater part of Jaláun, and even succeeded in holding the fortified post of Kálpi. That important possession was soon recovered by the Musalmáns, and passed under the sway of the Mughal emperors. Akbar's governors at Kálpi maintained a nominal authority over the surrounding district; and the native princes were in a state of chronic revolt, which culminated in the war of independence under Chhatar Sál. On the outbreak of his rebellion in 1671 he occupied a large province to the south of the Jumna. Setting out from this basis, and assisted by the Marhattás, he reduced the whole of Bundelkhand. On his death he bequeathed one-third of his dominions to his Marhattá allies, who displayed their usual alacrity in occupying their new territory, and before long succeeded in quietly annexing the whole of Bundelkhand. Under Marhattá rule the country was a prey to constant anarchy and intestine strife. To this period must be traced the origin of all the poverty and desolation which are still conspicuous throughout the district. In 1806 Kálpi was made over to the British, and in 1840, on the death of Náná Gobind Rás, his possessions lapsed to them also. Various interchanges of territory took place, and in 1856 the present boundaries were substantially settled. During the whole period of British rule before the mutiny, Jaláun only recovered its prosperity by very slow degrees. When the news of the rising at Cawnpur reached Kálpi, the men of the 53d native infantry deserted their officers, and in June the Jhánsi mutineers reached the district, and began their murder of Europeans. The natives everywhere revelled in the licence of plunder and murder which the mutiny had spread through all Bundelkhand, and it was not till September 1858 that the rebels were finally defeated. Since the mutiny the condition of Jaláun seems to have been steadily but slowly improving.

JALÁUN, a decayed town in the above district, and the former capital of a native state, is situated in 26° 8' 32" N. lat., 79° 22' 24" E. long. It occupies a large area, and contains a considerable number of good houses, and a ruined fort. The position is low, and swamps surrounding the town engender cholera and malarious fever, for which reason the headquarters of the district have been fixed at Urál. The population in 1872 was 10,197,—8824 Hindus and 1373 Mahometans.

JÁLNA, or JAULNA, a town in Hyderabad state, southern India, 19° 50' 30" N. lat., and 75° 56' E. long., 240 miles north-west of Sikandarábád (Secunderabad), 38 east of Aurangábád, and 210 miles north-east of Bombay. It has a British cantonment, situated on a gentle declivity, at an elevation of 1652 feet above the sea, in an arid tract of country; the lines were built in 1827. Two miles south-west of Jálna is the old town of the same name, once the seat of a flourishing trade, but now rapidly decaying.

JÁLPÁIGURI, or JALPIGOREE, a British district of India, forming the north-eastern part of the Rájsháhí Kuch Behar division, under the lieutenant-governor of Bengal, and lying between 26° 0' 35" and 26° 59' 30" N. lat., and between 88° 22' 40" and 89° 55' 20" E. long. It consists of an irregularly shaped tract south of Bhután and north of the state of Kuch Behar and Rangpur district, with an area (1875) of 290,464 square miles. The district divides into a "regulation" tract, lying towards the south-west, and a strip of country, about 22 miles in width, running along the foot of the Himálayas, and known as the Western Dwárs. The former is a continuous expanse of level paddy fields, only broken by groves of bamboos, palms, and fruit-trees. The Western Dwárs are, for the most part, overgrown with grassy jungle, the secure home of large game, and are everywhere traversed by hill torrents, which, on the higher slopes, lose themselves beneath the sandy soil. The frontier towards Bhután is formed by the Sinchulá mountain range, some peaks of which attain an elevation of 6000 feet. It is thickly wooded from base to summit. The principal rivers, proceeding from west to east, are the Mahánandá, Karátóyá,

Tístá, Jáldhaká, Duduyá, Mujnai, Torshá, Káljáni, Ráidhak, and Sankos. The most important is the Tístá, which forms a valuable means of water communication. The Government forest reserves in the Western Dwárs cover a total area of 342.54 square miles. Lime is quarried in the lower Bhután hills. During the last few years tea-planting has been introduced, with every prospect of success.

The parliamentary abstract of 1878 gives a population of 418,665. The returns from the Dwárs were not drawn up in the form adopted for Bengal generally. The remaining part has a population of 327,985 (169,288 males and 158,697 females), comprising 25 Europeans, 7 Eurasians, 8 Chinese, 144 Nepáls, 553 aborigines, 148,043 semi-Hinduized aborigines, 32,155 Hindus according to caste, 2070 Hindus not recognizing caste, and 144,980 Mahometans. The great bulk of the population belongs to the semi-Hinduized tribe known as Koch or Rajhañsi, which numbers 137,135, and is ascertained to form as much as two-thirds of the total inhabitants in the Western Dwárs. Rice is the staple crop in all parts of the district. Mustard seed is extensively grown; cotton is the staple of the Dwárs, jute and tobacco of the regulation tract; trigonon is common in the Western Dwárs. There is still some spare land uncultivated in the regulation tract; and in the Western Dwárs it has been estimated that about three-fourths of the land now waste is capable of cultivation. Of late years trade has been stimulated by the demand for agricultural produce from the south, and by the institutions of fairs on the Bhután frontier. The chief exports are jute, tobacco, timber, and rice; the chief imports are piece-goods, salt, and betel-nuts.

Education encounters great difficulties in Jálpáiguri, because the people are not gathered into villages, each family living in its own sequestered homestead. In 1875 the number of schools was 153, with 3263 pupils. The climate in the vicinity of Jálpáiguri town does not materially differ from that common to northern Bengal; except that the rainfall is heavier, and during the cold months fogs and mists are of daily occurrence. The average annual rainfall is over 100 inches; the average temperature is 76° Fahr. The climate of the Western Dwárs is markedly different; the hot weather disappears altogether, and the rains last continuously from April to October. The average annual rainfall at Baxá is 280 inches; the temperature averages 74° Fahr. The principal diseases are malarious fevers, splenitis, enlargement of the liver, diarrhoea, dysentery, and goitre. Of late years some very fatal outbreaks of cholera have occurred.

The district of Jálpáiguri first came into existence in 1869, when the Tístá subdivision of Rangpur was incorporated with the Western Dwárs, and erected into an independent revenue unit. The permanently settled portion of Jálpáiguri has no history of its own, apart from the parent district of Rangpur. The Western Dwárs became British territory as the result of the war with Bhután in 1864-65. The newly acquired territory was immediately formed into the two districts of the Eastern and Western Dwárs, the former of which has since been incorporated with the Assam district of Godpárá. The remainder, with the exception of a subdivision, was formed into the new district of Jálpáiguri with the addition of a portion taken from the unwieldy jurisdiction of Rangpur. Cultivation is now rapidly extending throughout the Dwárs; and it is believed that the population has been doubled during the ten years that have elapsed since British annexation. From motives of precaution, a regiment of native infantry is stationed in permanent cantonments at the hill pass of Baxá.

JÁLPÁIGURI, the administrative head-quarters of the above district, is situated on the west bank of the Tístá, in 26° 32' 20" N. lat., 88° 45' 38" E. long. This town has only risen into importance since the creation of the district in 1869, since which date its population has doubled. The population is estimated at between 4000 and 5000, including the regiment of native infantry in the cantonments, which lie south of the civil station.

JALÍ. See JAMS AND JELLIES, p. 564.

JAMAICA, an island lying between the Caribbean Sea and the Gulf of Mexico, and about 80 miles to the southward of the eastern extremity of the island of Cuba, within 17° 40' and 18° 30' N. lat., and 76° 10' to 78° 30' W. long. It is the largest island of the British West Indies, being 135 (or, as sometimes stated, 144) miles in length and 21½ to 49 miles in breadth. Its area is about 4200 square miles, or, as stated in the Report of the Geological Survey, 3250 square miles. Within its government are comprised the three small islands called the Caymanas,







References

- |                       |                  |
|-----------------------|------------------|
| I Bantam              | XII Pasuruan     |
| II Batavia            | XIII Probolinggo |
| III Krawang           | XIV Banyuwangi   |
| IV Preanger Regencies | XV Besula        |
| V Cheribon            | XVI Banyumas     |
| VI Tagal              | XVII Bagelen     |
| VII Pekalongan        | XVIII Kadu       |
| VIII Samarang         | XIX Jolokarte    |
| IX Japara             | XX Surakarta     |
| X Reubang             | XXI Madiun       |
| XI Surabaya           | XXII Kediri      |
| XXIII Madura          |                  |







—Grand Cayman, the principal of these, lying off the centre of the Yucatan passage; British Honduras has a lieutenant-governor under the general government of Jamaica, although distant 660 miles, on the mainland of Central America; and Turks and Caicos islands, lying between 21° and 22° N. lat. and 71° and 72° 37' W. long., were annexed to Jamaica in 1874.

The surface of Jamaica is usually hilly or mountainous, and there is a great variety of climate, according to situation and elevation. The largest extent of level land is to the westward, where the low lands are near the sea. The form of the coasts presents the outline of a turtle, the mountain ridges representing the back. The highest elevations are situated to the east, the inclined slope rising from the west. Vestiges of intermittent volcanic action occur. From the sea-level on all sides a series of ridges gradually ascend towards the central range, dividing the large rivers, and rising occasionally into peaks of 6000 feet. The Blue Mountains, running centrally from east to west, rise at some points to above 7000 feet. The vapours ascending from the rivers and surrounding ocean produce in the upper regions clouds saturated with moisture, which induce vegetation belonging to a colder climate. During the rainy season there is such an accumulation of vapour as to cause a general coolness over the island, and of course occasioning very sudden and heavy showers, and sometimes destructive floods. Upwards of one hundred and fourteen rivers or streams find their way from the interior to the sea, besides the numerous tributaries which issue from every ravine in the mountains. These streams for the most part are not navigable; in times of flood they become devastating torrents. In the parish of Portland, the Rio Grande receives all the smaller tributaries from the west; there is scarcely a mile width between any of these streams, and the land rises about 1000 feet to the mile. In St Thomas in the east, the drainage of the main ridge is performed by the Plantain Garden river, the tributaries of which form deep ravines and narrow gorges in the mountains, which unite and descend, the valley of the Plantain Garden expanding out into a most picturesque and fertile plain. Black River flows through a level country, and is accessible to small craft for about 30 miles. Salt River and the Cabarita, both also on the south side, are navigable by barges. The others on the south are the Rio Cobre (where irrigation works have been constructed for the sugar estates and provision and fruit growing in the district), Yallahs, and Rio Minho; on the north Martha Brae, the White River at Buff Bay, the Great Spanish River, and Rio Grande. There are several medicinal springs. Jamaica has sixteen harbours, the chief of which are Port Morant, Kingston, Old Harbour, Green Island, Montego Bay, Falmouth, Port Maria, St Ann's Bay, Lucea, and Port Antonio, besides numerous bays, roadsteads, and shipping stations affording tolerable anchorage. The surface of the valleys and level lands consists of alluvial deposits composed of sediment derived from the disintegration of the higher land. The White Limestone formation seems to originate two descriptions of alluvia, one white and the other red, the colour being due to oxide of iron combined with the argillaceous residue of the pre-existing limestone. The red soil is particularly favourable for coffee growing. The area occupied by the Coast Limestone and White Limestone represents about five-eighths of the island. The substructure of Jamaica consists of igneous rocks. In economic geology Jamaica produces a great variety of marbles, porphyrites, granite, and ochres. Traces of gold have been found associated with some of the oxidized copper ores (blue and green carbonates) of the Clarendon mines. Copper ores are very widely diffused, though the working of the veins has been found too expensive. Cobalt and

lead have been worked, but hitherto unprofitably. Manganese occurs, also iron ores and a form of arsenic. There is a great variety (and at the same time great equability) of climate. In the lowlands the temperature rises from 75° at night to 85° in the day, and is tempered by the sea and land breezes. At Up-Park Camp, 225 feet above the sea-level, the mean temperature of the hottest month (July) was 81°-71, and of the coldest month (January) 75°-65. At Newcastle, 3800 feet, the hottest month was 67°-75, and the coldest 61°. The temperature therefore is very equable. In the higher levels the temperature may be 40° to 50°. In the plains there is much humidity. At Kingston the temperature ranges from 70° to 80° throughout the year. Parts of the island are extremely favourable for sufferers from tubercular disease. The island is generally healthy, though sometimes subject to yellow fever, like most tropical countries. Hurricanes, when they occur, come between July and October. The periodical rains, which generally last for six weeks, constitute the May and October seasons.

The vegetable productions are very numerous. There are forest trees fit for every purpose; among these are the ballata, rosewood, satinwood, mahogany, lignum vitae, lancewood, and ebony. The logwood and fustic are exported for dyeing. There are also the Jamaica cedar, and the silk cotton tree (*Ceiba Bombax*). Pimento (peculiar to Jamaica) is indigenous, and furnishes the allspice. The bamboo, coffee, and cocoa are well known. Several species of palm abound,—the macaw, the fan palm, screw palm, and palmetto royal. There are plantations of cocoa-nut palm. The Government are raising cocoa-nuts with profit on a barren spit of sand by the sea. Cinchona plantations have recently been successfully established in the mountains, the produce selling well in the London market. The other noticeable trees and plants are the mango, the breadfruit tree, the papaw, the lacebark tree, and the guava. The *Palma Christi*, from which castor oil is made, is a very abundant annual. English vegetables grow in the hills, and the plains produce plantains, cocoa, yams, cassava, ochra, beans, pease, ginger, and arrowroot. Maize and guinea corn are cultivated, and the guinea grass, accidentally introduced in 1750, is very valuable for horses and cattle,—so much so that pen-keeping or cattle farming is a highly profitable occupation. Among the principal fruits are the orange, shaddock, lime, grape or cluster fruit, pine-apple, mango, banana, grapes, melons, avocado pear, breadfruit, and tamarind. There are public gardens at Kingston, at Castleton, about 20 miles from Kingston, and at Bath, and an experimental plantation of different varieties of cane at Hope plantation. The sugar cane was cultivated at an early period, for in 1671 there were a number of sugar works. There are many beautiful flowers, such as the aloe, the yucca, the datura, the mountain pride, the *Victoria regia*; the cactus tribe is well represented. Innumerable varieties of ferns grow in the mountains, and orchids in the woods. The sensitive plant grows in pastures.

There are fourteen sorts of *Lampyridæ* or fireflies, besides the *Elateridæ* or lantern beetles. There are no venomous serpents, but plenty of harmless snakes and lizards. The large lizard, the iguana, is eaten, as are also the land crab and tortoise. The scorpion and centipede are poisonous, but not very dangerous. Ants, mosquitoes, and sandflies swarm in the lowlands. Gosse enumerates twenty different song birds in Jamaica. Parrots, pigeons, guinea fowl, and a great variety of water birds are found. The sea and rivers swarm with fish, and turtles abound. The seal and manatee are sometimes found, and the crocodile. The domestic animals are those of the ordinary English kind. Jamaica beef and pork are very good. Poultry succeeds well.



The population was returned in the census of 1844 as 380,000, of whom 16,000 were white, 68,000 coloured, and the rest black. In 1864 it was returned at 441,000, of whom 14,000 were white, 80,000 coloured, and 347,000 black. In 1871 the numbers were 13,000 white, 100,000 coloured, 393,000 black; total 506,000. The census of 1881 will probably show a total of 600,000,—a large increase in the black and coloured population, and a stationary if not reduced number of white people.

The total value of imports was £1,492,722 (including £757,077 from the United Kingdom) in 1878, and £1,347,342 in 1879—amounts considerably below the values for the preceding six years, in four of which it was above £1,700,000. The imports consist principally of provisions for consumption, a considerable proportion coming from the United States. The total value of exports in 1878 was £1,210,705 (£954,584 to the United Kingdom), consisting of 9,572,714 lb of coffee (an extending industry), 908,603 lb of ginger, 6,195,109 lb of pimento, 18,115 puncheons of rum, 26,066 hds. of sugar, and 35,157 tons of logwood. The total value is below that of the six preceding years. The sugar exported was below the average of preceding years; but in 1879 sugar exports rose again to 29,000 hds. The value of the fruit exported (principally to United States) had risen from £9337 in 1875 to £39,451 in 1878. The total exports for 1879 were £1,357,571 value. The area under crops in 1878 was 121,457 acres, in guinea grass 120,264, in pasture 318,549, in wood and runate 1,217,596, leaving 942,134 acres of the total extent to be accounted for as unpatented primeval forest or rocky land of no value. One of the newest industries, besides cinchona, is the growth of excellent tobacco; Jamaica cigars are now becoming well known in England. The public revenue for 1878 was £438,564, and the appropriated revenues from roads, poor rates, &c., £71,900, making a grand total of £512,465, or about 18s. per head of the population. The estimates for 1880 showed a public revenue of £469,875 and appropriated £72,580, total £542,455. £245,000, or more than half the public revenue, is raised from import duties, and £94,000 from rum duties; the railway receipts (Government having purchased the line by loan with a view to extension) for 1880 were estimated at £23,000. The remainder comes from licences, postal revenues, and other sources. The public expenditure for 1879 was £460,154, the appropriated £73,050, total £533,204, and the estimated expenditure for 1880—public £485,655, appropriated £72,580, total £558,235. The main items of expenditure are—debt charges and sinking funds and redemption, £73,000; administrative departments, £33,000; revenue departments, £33,000; judicial, £36,000; ecclesiastical, £10,000 (the church has been disestablished, and the expenditure will be gradually less as vested interests disappear); medical, £55,000; constabulary, £50,000; penitentiary and prisons, £25,000; education, £25,000; railway managing, &c., £14,000; public works and irrigation, £53,000.

In 1878, 617 schools underwent inspection by the Government; 51,488 children were on the books, the average attendance being 29,679. Of these schools, 54 passed first class, 176 second class, and 343 third class. The average Government grant to each school aided during the year was £29, and the total education grant, exclusive of departmental salaries, was £18,572. Elementary education has made progress during the eleven years the present system has been in operation. The collegiate school in Kingston offers higher education. Among educational institutions, the Church of England high school, the Calabar institution or Jamaica Baptist College, and Wolmer's free school, founded in 1729 by John Wolmer for the free education of poor children, as well as the Mico school, require mention. The ecclesiastical establishment is regulated by Law No. 30 of 1870, which provided for gradual disendowment. This law created a synod, to consist of clergymen and lay representatives, and it continued to each existing rector, island curate, and stipendiary curate the payments from the state so long as they fulfilled their functions. Under this law the estimates for 1880 show as still on the establishment five rectors, twenty island curates, and three stipendiary curates, the total amount for the Church of England being £9749; this, with £367 to the Church of Scotland, and £100 to the Church of Rome, makes up the ecclesiastical establishment. Besides the state paid clergymen, there are about forty clergymen paid out of the Diocesan Church Fund. Besides three American church missionaries at Kingston, there are about twenty Presbyterian ministers, thirty Wesleyan, eight of the London Missionary Society, fifty Baptist, one Independent, six United Methodist Free Church. The Moravians have fourteen stations and seventeen missionaries. There are two synagogues.

Kingston, the capital, is on the south coast. It was founded in 1693, and is built on a plain which rises from the shore with a gradual ascent to the foot of the Liguanea mountains. This plain is covered with country residences

and sugar estates. The town population in 1871 was 4393 whites, 13,291 coloured, and 16,630 blacks. It is now estimated at over 40,000. The seat of government was recently transferred from Spanish Town to Kingston, and the principal civil and judicial business is transacted there. The chief retail business street is Harbour Street. Port Royal Street is the chief thoroughfare of the wholesale merchants, who keep wharves which line the seaboard of the town. The public buildings possess little architectural interest. The Victoria Market (opened in 1872) and public landing place at the foot of King Street (where Rodney's statue was brought from Spanish Town); form a very fine market-place. The court house in Harbour Street is a handsome building. The public hospital (with 170 beds), the law library, the chancery registrar's office (with its piece of tapestry of the royal and island arms, which used to be carried before the governor on state occasions), the court of vice-admiralty, the public library and museum in East Street, are also worthy of mention. The parish church in King Street is one of the oldest churches in the island, dating probably from 1692. It contains the tombs of William Hall (1699) and Admiral Benbow (1702). The only bank is a branch of the Colonial Bank, besides the Government Savings Bank. Up-Park Camp, to the north-east of the city, is the headquarters of a West India regiment.

Jamaica was discovered by Columbus and possession taken in the name of the king of Spain on the 3d of May 1494. He called it St Jago, but it is known by its Indian name Jamaica, "the isle of springs." It is sometimes written Xamayca. The inhabitants belonged to the gentler Indian tribes, not to the fierce Caribs. In June 1503 Columbus was driven by a tempest into a bay on the north side, now St Ann's Bay. After his departure the island remained unvisited until 1509, when his son Diego, having established his right in the council of the Indies to the governorship of Hispaniola, sent Don Juan d'Esquivel to take possession of the island, in opposition to Alonzo d'Ojeda, who claimed it under a royal grant. Thenceforward, under the rule of the Spaniards, the Indian population diminished, until in 1655, when the island fell into the possession of the English, the race was practically extinct. The controversy respecting the rights of the descendants of Columbus continued for a long time. About the year 1523 Diego Columbus founded St Jago de la Vega, St James of the Plain, which was the official capital, under the name of Spanish Town, until Kingston was recently selected. Attention had been gradually given to agriculture, the cotton plant, sugar cane, and various kinds of corn and grass having been introduced. In 1596, during the alliance of Queen Elizabeth with the Low Countries, and the consequent war with Spain, Sir A. Shirley, a British admiral, invaded Jamaica, but made no attempt at occupation. In the reign of Charles I. Colonel Jackson defeated the inhabitants at Passage Fort. Shortly afterwards the island was divided into eight districts in the nominal possession of eight noble families, and the total population became extremely small. The next important event was the expedition sent by Cromwell, under Admirals Penn and Venables; failing against Hispaniola, they took possession of Jamaica on the 3d May 1655, the island having been in the possession of the Spaniards one hundred and sixty-one years. Under Cromwell emigrants were sent from Scotland and Ireland and other places. But the Spaniards and their negroes harassed the new comers, who died in considerable numbers. On the 8th May 1658 an attack from Hispaniola was defeated, and soon after the remaining Spaniards were driven from the island. The slaves called Maroons, however, who had fled to the mountains, continued formidable. Down to the end of the 18th century the disaffection of these Maroons caused much trouble. In 1661 a regular civil government was established, Colonel D'Oyley being appointed governor-general with an elective council. Next year he was succeeded by Lord Windsor, who was instructed to summon a popular assembly to pass laws. Jamaica became the resort of the buccaneers, who carried on a profitable piracy on these seas during the war with Spain. In 1670 peace was made with Spain, and the English title was recognized by the treaty of Madrid. The buccaneers were suppressed. In 1672 the Fourth or Royal African Company was formed to carry on a monopoly of the slave trade. From 1700 to 1786 the number of slaves imported was estimated at 610,000, of whom about one-fifth were re-exported. In 1673 the governor sent home the first pot of sugar to the secretary of state; at this time there were 7768 whites and 9504 negroes on the island. In 1678, while the earl of Carlisle was governor, an attempt was made to saddle the island with a yearly tribute to the crown, and to restrict the free legis-



tative power of the assembly. The privileges of the assembly, however, were restored under Sir Thomas Lynch in 1682; it was not until 1723 that £8000 (currency) a year was settled on the crown, and the laws and statutes of England were made equally applicable to Jamaica. This amount was afterwards commuted for £6000, used by the governor for salaries, allowances, and contingencies. In 1854 this fund was merged in the ordinary civil list. The other principal event in the general history of Jamaica was the threatened invasion in 1782 by the combined fleets of France and Spain under De Grasse. It was saved by the victory of Rodney and Hood, off Dominica, in commemoration of which event a statue of Rodney, by Bacon, was erected in Spanis' Town.

A great earthquake occurred in 1692, when the chief part of the town of Port Royal, built on a shelving bank of sand, slipped into the sea. In 1712 and 1722 there were dreadful hurricanes, the last causing the seat of commerce to be transferred from Port Royal to Kingston. Since then there have been a number of hurricanes, the most recent being in August 1880, when considerable damage was done to crops, provision grounds, churches, chapels, and school-houses in the eastern part of the island.

Since 1800 the history of Jamaica has been, with some exceptions (such as the defeat by Admiral Duckworth in 1806 of the French squadron intended to invade Jamaica), confined to its domestic concerns and its relations with the mother country. In 1807, when the slave trade was abolished, there were 323,827 slaves in the island. The island was very prosperous,—sugar, coffee, cocoa, cotton, pimento, ginger, and indigo being produced; and it was also the depot of a very lucrative transit trade between Europe and the Spanish main. The anti-slavery agitation in England, growing stronger every year, caused great excitement in the island, and there was much violence and misrepresentation on both sides of the question. The negroes revolted in 1832, under the belief that emancipation had been granted; many hundreds of lives were sacrificed, a large amount of property destroyed, and various atrocities were committed. This stimulated the agitation in England, and in 1833 the Emancipation Act was passed, the period of apprenticeship being ultimately reduced to four years. Of the £20,000,000 compensation, £6,161,927 was awarded to Jamaica, being about £19 a head on a slave population of 309,338. The wisdom of the manner in which the emancipation policy was carried out by England has been often questioned. During Sir Lionel Smith's administration, on the 1st of August 1838, the apprenticeship came to an end, and entire emancipation was effected by an Act of the assembly. Difficulties arising between the British Government and the assembly as to the Prisons Act, a bill was introduced by Mr Labouchere (Lord Taunton) into the House of Commons to suspend the constitution of Jamaica, the rejection of which measure occasioned the resignation of Lord Melbourne's ministry. The dispute was afterwards compromised, and under the government of Sir Charles Metcalfe an improved state of things was brought about. Education and religious instruction and better administration of justice were subjects of attention, together with schemes of agriculture to develop the varied resources of the island. The want of cheap and continuous labour was, however, a great obstacle. The introduction of labourers from Africa was objected to in England as a renewal of the slave trade. Coolie immigration was fenced about with such expensive restrictions by the home Government that no large or comprehensive scheme was possible. The earl of Elgin continued Sir C. Metcalfe's policy, and a railway was opened, 12 miles long, between Kingston and Spanish Town, but the prospects of the colony became exceedingly gloomy under the effects of the legislation in 1846 equalizing the duties on free and slave sugar. The advantages of slave labour in Cuba were so great that the utmost economy and skill of practical resident planters in Jamaica failed of success. Differences between the assembly, the council, and the home Government on the means of retrenching the public expenditure, created much bitterness of feeling, and most disastrous results were brought about, affecting seriously the credit of the island, by the assembly refusing to perform its functions and renew duties necessary for revenue. An outbreak of cholera added to the confusion and gloom. The result of this controversy was that the home Government offered an imperial guarantee for a loan of £500,000 and other financial assistance, conditionally on permanent provision being made for official salaries, on the initiation of all money grants by the crown, and on certain members of the legislature being held responsible for the expenditure of the public money. Sir Henry Barkly had the task of carrying out these arrangements. In 1854 the Incumbered Estates Act was passed, under which in recent years considerable sales of property in Jamaica have taken place. During the next decade the island was tranquil, but very much depressed. Many white people, of a superior class, had left. Public business suffered by the recriminations in the assembly, and by want of economy and good management (causing annual deficits) of the public finances. But in 1865 an event occurred which opened a perfectly new chapter in Jamaica history. On October 20 Governor Eyre reported to the secretary of state (the present Lord Cardwell) a "serious and alarming insurrection of the negro popula-

tion." In this despatch the letter written by Dr Underhill, the secretary to the Baptist Society, was referred to as causing public meetings to be held, and giving rise to excitement. Dr Underhill subsequently asserted that it was through Governor Eyre his letter became public. The letter referred to the distress among the population, to alleged unjust taxation, to the alleged refusal of just tribunals, to the denial of political rights to the emancipated negroes. The despatches of Governor Eyre caused much discussion and excitement in England, and under date of 30th December 1865 a royal commission was issued to inquire into the disturbances. The commissioners—Sir Henry Storks (sent out as governor), Mr Russell Garney, and Mr J. B. Maule—began their work on January 23, 1866, and sat for fifty-one days. They reported on the 9th April that the disturbances in St Thomas in the east had their immediate origin in a planned resistance to lawful authority, arising from the desire to obtain land free of rent, want of confidence in tribunals, feelings of hostility towards political and personal opponents, while not a few contemplated the death or expulsion of the white inhabitants. Had more than a momentary success been obtained, the ultimate overthrow of the insurgents would have been attended with a still more fearful loss of life and property. The commissioners attributed the speedy termination of the outbreak to the skill, promptitude, and vigour of Governor Eyre in the early stages; they viewed the military and naval operations as prompt and judicious; but they thought martial law was continued too long, and that the punishments inflicted were excessive. The commissioners expressed an opinion that the conduct of Gordon, a member of the assembly, whose trial by court martial and execution caused great controversy in England, had been such as to convince both friends and enemies of his being a party to the rising, yet they could not see any sufficient proof either of his complicity in the outbreak at Morant Bay, or of his having been a party to a general conspiracy. The case was warmly taken up in England by the Jamaica committee under the leadership of Mr J. S. Mill. A charge was made against Mr Eyre, resulting in an elaborate exposition of martial law by Chief Justice Cockburn, and the stoppage of the prosecution by the grand jury ignoring the bill. On the 20th December 1866 the assembly passed an Act rendering it lawful for the Queen to create and constitute a Government for the island; the same was passed by the council on the 22d, and on the 23d it received the governor's consent.

Thus the constitution which had existed for two hundred years was swept away. It was composed at the time of a governor, a privy council, a legislative council, an assembly of forty-seven elected members, and a paid body called the executive committee, who were practically responsible ministers of the crown, holding office at the governor's pleasure. The present constitution is that of an ordinary crown colony. It was established by an imperial Act, and an order in council, dated 9th April 1866, and subsequent orders. There is only one chamber, called a legislative council. In 1880 this consisted of the governor as president, eight officials, (viz., colonial secretary, senior military officer, attorney general, director of roads, collector general, auditor general, assistant colonial secretary, and crown solicitor), and eight non-officials, nominated by the crown,—all councillors holding office at the royal will and pleasure. No proposal is admitted or debate allowed on any matter affecting revenue, unless introduced by the governor or by his direction. Sir J. P. Grant was governor from 1866 to 1874, and reforms and changes were vigorously effected. The revenue was better collected. Irrigation and other public works were begun. But the sugar industry has continued in a state of great depression, though Sir A. Musgrave, who was appointed governor in 1877, reported in 1880 that the public debt had been reduced from £719,000 to £485,000 (excluding loans for special purposes), that there had been no increase of taxation since 1867, that savings banks deposits had increased from £53,913 in 1868 to £207,000 in 1879 (the Government paying interest at 4 per cent.), and that the industrious negroes, especially those with small holdings, growing provisions, coffee, cocoa, or possessing small sugar mills, were fairly prosperous. These results are attributed by officials to the change from representative to crown government, although the latter has been much criticized as too arbitrary, and tending to a narrow officialism. The number of parishes for purposes of local government has been reduced from twenty-two to fourteen. Each parish has its own hospitals, almshouses, &c., managed by its municipal board, the chairman of whom is the custos, nominated by the governor. The members are appointed by the custos, subject to the governor's approval. Each parish also has a road board. The judicial establishment consists of the chancellor (the governor), a vice-chancellor and chief justice, two puisne judges of the supreme court, attorney general, crown solicitor, &c.; there are seven district courts, somewhat on the model of county courts in England, the judges being barristers sent out from England. There are also four stipendiary magistrates, and a police magistrate for Kingston. The constabulary was placed on its present footing in 1867, and is modelled on the system of the Irish (semi-military) constabulary. Parochial medical officers paid by Government attend the parochial institutions, constabulary, and immigrants. These officers are



allowed private practice in addition. The island is in telegraphic communication with England, and indeed with the world, and has also an inland telegraphic service. The Government have purchased the 25 miles of railway from Kingston to Old Harbour, and are about to construct 47 miles more. Steam communication is very frequent between England, United States, and the colony.

See Long's *History*, 1774; Bryan Edward's *History*, 1809, and Appendix, 1819; Reany's *History*, 1807; Bridge's *Annals*, 1828; M. G. Lewis's *Journal of a West India Proprietor*; Montgomery Martin's *History of the British Colonies*, 1835; Philippo's *Past and Present State*, 1843; *Geological Survey Reports*, 1869; Gardner's *History*, 1873; Philippo's *Cimate*, 1876; Sir Sibald D. Scott's *Jamaica and Barb.*, 1876; parliamentary papers, Colonial Office lists, local publications, and almanacs. For natural history, see Gloane, 1692; Brown, 1754; Barham, 1794; Luann, 1814; and Gosse's *Journal of a Naturalist in Jamaica*, 1841; and *Birds of Jamaica*, 1847. For descriptions of scenery, see Tom Cringle's *Log and the Cruise of the Midge*, by Michael Scott, a Kingston merchant. See also the map of Harrison, 1873. (J. L. O.)

**JAMES** (Ἰάκωβος). This name, the Hebrew *Yakob* or *Jacob*, belongs to several persons mentioned in the New Testament, of whom the first that appears in the Gospels is

1. *James the son of Zebedee*. He was among the first who were called to be Christ's immediate followers and afterwards chosen to be his apostles, and is one—the others being Peter, Andrew, and John (the brother of James)—of the always first-mentioned and, as the narrative shows, most remarkable group of the apostolic band. In all the enumerations of the twelve (Matt. x. 2; Mark iii. 17; Luke vi. 14; Acts i. 13), his name appears early in the list, twice occupying the second place after Peter's. The call of James and John (the fullest account of which is given in Luke v. 1–11; comp. Mark i. 20) took place on the same occasion when Peter and Andrew, the other pair of brothers, were taken from their humble fisher's trade to be fishers of men. After this we next find James noticed as one of the persons present (Mark i. 29) when Jesus restored Simon Peter's wife's mother, who was sick of a fever.

His brother and he were surnamed by our Lord (Mark iii. 17) "Boanerges," a name derived from two Aramaic words signifying "Sons of thunder," as it is interpreted by the evangelist. The name has been explained as having reference to the powers of their eloquence in preaching, or even from their being present when the voice like thunder spake to Jesus from the cloud (John xii. 29). It is more probable, especially as one meaning of the word translated "thunder" is "rage, anger," that the name was given to them by the Lord because he perceived the fiery impetuosity of their nature. Two instances (Luke ix. 54; Mark x. 32–41) are recorded in the Gospels from which we can discern somewhat of this character of the sons of Zebedee.

James is included among those who after the ascension waited at Jerusalem (Acts i. 13) for the descent of the Holy Ghost on the day of Pentecost. This is one of the passages in which the name of James is placed before those of John and Andrew, and we may judge from the little that we are told of him subsequently that he was a most zealous and prominent member of the Christian community. For when a victim is to be chosen from among the apostles who should be sacrificed to the animosity of the Jews, it is on James that the blow falls first. The brief notice is given Acts xii. 1, 2: "Now about that time Herod [Agrippa I.] the king put forth his hands to afflict certain of the church. And he killed James the brother of John with the sword."

Eusebius (*H. E.*, ii. 9) has preserved for us from Clement of Alexandria the circumstance that the accuser of the apostle, "beholding his confession and moved thereby, confessed that he too was a Christian. So they were both led away to execution together, and on the road the accuser asked James for forgiveness. Gazing on him for a little while, he said, 'Peace be with thee,' and kissed him. And then both were beheaded together." Other legends which tell of the apostle's preaching in Spain, and of the translation of his body to Compostella,

are to be found in the *Acta Sanctorum*, July 25 (vol., vi. pp. 1–124).

2. *James the son of Alphæus*. He also was one of the apostles, and is mentioned in all the four lists (Matt. x. 3; Mark iii. 18; Luke vi. 15; Acts i. 13) by this name, but in no other place. It is, however, thought by some that he is the same with

3. *James the Lord's brother*. In Matt. xiii. 55 and Mark vi. 3 the brethren of the Lord are named James, Joses, Judas, and Simon. It is also to be remarked that they are in both places spoken of as the children of the carpenter, that is, of Joseph the husband of the Virgin Mary. But it has been urged that they were called sons of Joseph and Mary because the children of two families,—of Mary the Virgin and Mary the wife of Clopas, her half sister,—were brought up together. Those who in this way make James the Lord's brother to be a son of Alphæus require to establish (a) that Clopas is the same name as Alphæus, (b) that Mary the wife of Clopas (John xix. 25) was the sister of the Virgin Mary, and (c) that this Mary, wife of Clopas, is the same who is called (Matt. xxvi. 56; Mark xv. 40) Mary the mother of James and Joses, and (Mark xvi. 1; Luke xxiv. 10) simply the mother of James, in which four passages the same person is evidently intended. But the identity of the names Alphæus and Clopas is by no means certain. Those who maintain it take Clopas as the Aramaic Chalpai, and Alphæus to be a Græcized form thereof. But when we turn to what might be supposed the best source of evidence on this point, viz., the Peshito version of the New Testament, instead of finding the two names treated as the same word, we find in all cases Chalpai where the Greek has Alphæus, and where Clopas or Cleopas occurs, it is simply transliterated Kleopha. The same is the case with the Jerusalem Syriac. The identity of these names is thus far from being established. Then in John xix. 25 the versions and best authorities are in favour of making four persons of those there mentioned: "his mother, and his mother's sister, and Mary the wife of Clopas, and Mary Magdalena." This is the Peshito rendering, and, even if the conjunction were not there, it is not uncommon in Scriptural enumeration to find names given in pairs without any conjunction, while to make Mary the wife of Clopas the Virgin's sister would be to assume two Marias in the same family of sisters, which is not very probable. Whether Mary wife of Clopas was the mother of a James (called in one place "the little") and of Joses can neither be asserted nor denied from the evidence in the Gospels; but, when the other two assumptions have so little foundation to rest on, it seems impossible to consider the son of Alphæus the same person with the "brother of the Lord."

Further, James the Lord's brother was bishop of Jerusalem (comp. Gal. i. 19 with Gal. ii. 9–12), and was president of the church in its earliest days (Acts xii. 17, xv. 13, xxi. 18). Such a position required him to be a resident in Jerusalem, while had he been an apostle (as the son of Alphæus was) we should have expected him to take his share of the missionary labour of publishing the gospel in distant lands. But this bishop of Jerusalem was the author of the epistle of St James. He simply styles himself in the introduction thereto "a servant of God and of the Lord Jesus Christ." He who could thus write with the certainty of being identified must have been the most famous person of his name in the church, must have been what St Paul, in a passage (Gal. ii. 9) where he places James before both Peter and John, calls him, "a pillar" of the Christian society. And again Jude, when commencing his epistle, calls himself the brother of James, with no other mark of distinction. Here too the same

James must be intended, and when we read St Jude's epistle (17, 18) we find him distinguishing himself from the apostles, and as it were disclaiming the apostolic dignity. This is as it would be if James and Jude were both brethren of the Lord and were not apostles, but we should certainly expect one or other would have left some indication in their letters had they been of the number of the twelve, and most surely neither of them would have been likely to give us reason for believing that he was not an apostle.

The two passages (1 Cor. xv. 7; Gal. i. 19) from which it might be argued that James the brother of the Lord was an apostle cannot be relied on, for we find the same title given to Barnabas, and it is certain that the name "apostle" began to be more widely applied after the ascension than it is in the Gospels.

Once more, the brethren of the Lord are expressly said (John vii. 5) not to have believed on Jesus at a period much later in his ministry than the appointment of the twelve; while in the mention of them in Acts i. 14 there is given first a list of the eleven, who are said all to have "continued in prayer with the women and Mary the mother of Jesus and with his brethren." Such a studied severance of the brethren of the Lord from the number of the apostles is very significant, while the position which they hold in the list may well be due to the fact that it was only at a late period that they had become disciples of Jesus. The change in their opinions has been thought by many to be sufficiently accounted for by the statement of St Paul (1 Cor. xv. 7) that after his resurrection Jesus "was seen of James." Such a demonstration of the truth of what others had long believed and Jesus himself had taught could not fail to work conviction on a mind which, if we may accept the tradition of the "Gospel according to the Hebrews" (which also testifies to this appearance of Christ to James), was somewhat inclined to believe, even before the crucifixion.

It seems right therefore to conclude that James the son of Alphæus, one of the apostles, was a different person from James the Lord's brother and bishop of Jerusalem. Of the history of the former we are told nothing except that he was an apostle. The latter is spoken of by St Peter (Acts xii. 17) as if he were at that time the recognized head of the Christian community in Jerusalem. Again (Acts xv. 13), after the debate at Jerusalem about the circumcision of the Gentiles, it is he who sums up the arguments and declares the sentence of the council, as if he were the chief person among them. In Acts xxi. 18, on St Paul's last visit to Jerusalem, he holds the same position, and receives the visit of St Paul in the presence of all the presbyters. In Gal. i. 19, ii. 9 he is placed foremost among "the pillars" of the church of Jerusalem.

From the New Testament we learn no more of the history of James the Lord's brother, but Eusebius (*H. E.*, ii. 23) has preserved for us from Hegesippus the earliest ecclesiastical traditions concerning him. By that authority he is described as having been a Nazarite, and on account of his eminent righteousness called "Just" and "Oblivion." So great was his influence with the people that he was appealed to by the scribes and Pharisees for a true and (as they hoped) unfavourable judgment about the Messiahship of Christ. Placed, to give the greater publicity to his words, on a pinnacle of the temple, he, when solemnly appealed to, made confession of his faith, and was at once thrown down and murdered. This happened immediately before the siege. Josephus (*Antiq.*, xx. 9, 1) tells that it was by order of Ananus the high priest, in the interval between the death of Festus and the arrival of his successor Albinus, that James was put to death; and his narrative gives the idea

of some sort of judicial examination, for he says that along with some others James was brought before an assembly of judges, by whom they were condemned and delivered to be stoned.<sup>1</sup>

Other less important bearers of this name are (4) James, of whom all we know is that he was the "son of Mary" (Matt. xxviii. 56; Mark xv. 40, xvi. 1; Luke xxiv. 10) and the brother of a certain Josès (comp. Mark xv. 40 with xvi. 1), and that he is called "the little," ὁ μικρός (A. V. "the less," wrongly); and (5) James, who was either the father or brother of Judas, one of the apostles. The Greek gives (Luke vi. 16; Acts i. 13) "Judas of James." The ellipsis may, as has been shown by Winer, be supplied either by the word "father" or "brother." The A. V. supplies "brother." But, as in both these lists within a line of the name of this Judas a similar form "James of Alphæus" occurs, which is in both places rendered James the "son" of Alphæus, as it is also in both the other lists of the apostles in St Matthew and St Mark, it seems natural to suppose that the evangelists intended the same noun to be supplied in both cases. If this be so, the James here mentioned would be a person otherwise unknown, but the father of the apostle Judas, who is distinguished as Lebbæus and Thaddeus, and also by St John (xiv. 22) as "Judas not Iscariot."

JAMES, THE GENERAL EPISTLE OF. Of the author of this epistle enough has been said in the previous article (3): it only remains to add in connexion with the introductory words thereof that probably the same reason actuated both St James and St Jude to leave out any mention that they were "brethren of the Lord." We need not enter into the question of what relationship is intended by these words, though, from the mention of Joseph on each occasion where the "brethren" are spoken of, it is probable that they were really his children by a former marriage. Thus Jesus would be younger than those who are called "his brethren," and their behaviour in rejecting his teaching for so long a time may have been partly a result of their growing up with him and regarding him as a younger member of the same family, and from familiarity becoming less willing than strangers would be to acknowledge anything which looked like an assertion of superiority. But, whatever the reason for their former unbelief, it is easy to see that, when they had at length come to own Jesus as their Lord, humility would check the mention of the relationship in which they might claim to stand to Jesus, as would also a desire not to appear to place themselves in a position of close connexion with Christ, to which none others could lay claim.

The epistle is addressed "to the twelve tribes which are of the dispersion." The word "dispersion" (*διασπορά*) was employed in the New Testament times to signify the Jewish population in every part of the then known world. Jews were to be found in Persia, Egypt, Asia Minor, and indeed in all the lands surrounding the Mediterranean Sea. When the writer addresses them as "the twelve tribes" he gives us the key to the character of his epistle. It was written to Christians who had been converts from Judaism, but to whom their ancient faith was still of the very highest importance, indeed, of somewhat more importance than it ought to have been. We can see therefore why the language of this epistle partakes so largely of the character of the preaching of John the Baptist (comp. Jas. i. 22, 27 with Matt. iii. 8; Jas. ii. 15, 16 with Luke iii. 11;

<sup>1</sup> For a discussion of these traditions, and on the question whether the text of Josephus is interpolated, consult Credner, *Einführung*, p. 531; Hilgenfeld, *Einl.*, p. 523 *seq.*; Wieseler in *Jahrb. f. D. Theol.*, 1878, p. 99 *seq.* Compare also Jerome's account of James in his book *De vir. ill.*, 2, where further traditions from the Gospel according to the Hebrews are given.



Jas. ii. 19, 20 with Matt. iii. 9; and Jas. v. 1-6 with Matt. iii. 10-12) and of that of our Lord's earliest teaching in the Sermon on the Mount (*cf.* especially Jas. i. 2, 4, 5, 9, 20; ii. 13, 14; iii. 17-18; iv. 4, 10, 11; v. 2, 10, 12, 15), and why it is so largely illustrated by the language of books like Ecclesiasticus and the Book of Wisdom, which were specially esteemed by the Jews of Alexandria and other Hellenistic centres of Judaism (see Jas. i. 1, 5, 8, 11, 12, 17, 19, 20, 23, 25; ii. 21; iii. 5, 6; iv. 14). We should judge from this that the bishop of Jerusalem, in the earlier days of the Christian church, availed himself of his central position to circulate among the scattered Judæo-Christian populations, of whom representatives would constantly be within his reach, such a letter as was suited to stimulate the new converts to more truly Christian life, and to check errors into which, from their attachment to the older faith, they were prone to fall. The epistle contains many exhortations to accept a higher standard for the conduct of life, though a considerable section (i. 22-ii. 26) applies more specifically to the dangers that beset Jewish converts of trusting to a faith which produced no results in the form of Christian love.

But it was not only for those who were scattered into distant parts of the world that the epistle was written. It bears marks of its relation to a time of special trial and hardship, and has much to say of how trials and sufferings are to be borne. "Count it all joy when ye fall into divers temptations" is the opening language; and the writer returns to the same theme at the close of his letter: "Be ye also patient," "Establish your hearts," "Behold, we count them happy which endure." Such words agree best with the dispersion of the first Christian brotherhood after the death of Stephen, and with that persecution by Herod Agrippa I. in which James the brother of John was put to death. It is an additional indication that the epistle was written about those times that in it there is no word of that contention which soon agitated the whole Christian church about the circumcision of the Gentiles, and about which James pronounced the sentence of the council of Jerusalem in 51 A.D. The persecution which ensued on the martyrdom of Stephen (33 A.D.) is too early a date after the ascension for us to think it probable that Christianity could have had enough representatives among the dispersion to make such an epistle as the present necessary. It seems better therefore to refer it to that larger persecution in which the one James suffered death, and after which the other James comes into special prominence in Christian church history. This would lead to the conclusion that the epistle, primarily addressed to the Jewish Christians throughout Palestine, but intended also for others who lived beyond the limits of the Holy Land, was written at Jerusalem, from which James the Just seems never to have departed, and that it should be dated some time after 44 A.D., the date of Herod's persecution, and antecedent probably by several years (for the agitation which led to the council must have existed for some time) to the council at Jerusalem (51 A.D.).

The epistle contains nothing to indicate where it was written, but at the same time there is nothing in the imagery and illustrations employed by the writer which would be out of character with one writing in Palestine. It is therefore probable that, since tradition represents James as constantly resident in Jerusalem, the epistle was written there. He uses the Jewish name "synagogue" (ii. 2) for the place of assembly for worship, which would perhaps be longer preserved among the Christians in Jerusalem than elsewhere; but on the other hand he speaks (v. 14) of the "elders of the church" (ἐκκλησία) just as we find St Luke doing in the Acts of the Apostles. He mentions the "burning wind" (καύσων) spoken of in the

Gospels (Matt. xx. 12; Luke xi. 55), and his language (iii. 4) about ships and the storms by which they are driven is such as would be natural in one who knew by experience of the tempests that sometimes sweep suddenly over the Sea of Galilee, with which this James must have been familiar as well as the son of Zebedee.

The epistle appears to have been written with a view, in the first place, to comfort some who were undergoing severe trials. This is clear from the opening sentence, "Count it all joy when ye fall into divers trials." But the words also seem to show that there was a spirit prevailing among those for whom the letter was first intended which did not tend to that perfect patience under sufferings that should characterize the faithful Christian. And so the writer passes on to notice a want of perfect trust in God, and a too great regard for temporal things, concerning which they are exhorted to foster such a mind as shall make changes in worldly affairs, when they are for the worse, yet still no cause for sorrow. For the only perfect gifts are of God's own sending, and in His gifts as in Himself there is no change. The epistle next dwells on that which was the great danger with Jewish converts, the profession of a belief in God and Christ without a corresponding Christian life; they are further exhorted to avoid sins of the tongue and sins of presumption, while those to whom wealth had become the chief object in life are severely condemned. But before the close the writer turns once more to his first theme, the commendation of patience under sufferings, which he enforces by the examples of the prophets and of Job. Then with certain cautions about the use of oaths, some precepts for conduct under sorrow, joy, sickness, or the consciousness of sin, the epistle is brought to a close, and has not the apostolic benediction, a feature which also marks the letter as one of the earliest of the Christian writings. The time of trial alluded to suits well with the date which has been suggested, when Herod's persecutions made it necessary for the Christians in Jerusalem to meet in secluded rooms, and to exercise the utmost precaution about all whom they admitted to their meetings. We know too, from the statements of Josephus, that it was from the wealthy Sadducees that the Christians in Jerusalem experienced most persecution, and that they especially were adverse to Christianity because of the preaching of the resurrection of Jesus. The followers of Jesus were, as we know, at this time just beginning to be called Christians, and this name soon became (if it was not at first given as) a name of reproach. These circumstances seem to be specially noticed in this epistle (ii. 6, 7). To the necessities of those days then the letter appears to be first directed, though it contains precepts eminently profitable for those who, having held firm to the belief in the unity of God (ii. 19), were disposed, even after the acceptance of the teaching of the gospel, to think that an intellectual assent to what was set forth was enough, without any effort to build up on the groundwork of faith the superstructure of Christ-like virtues.

In the time of Eusebius (325 A.D.) the epistle of St James was reckoned among the books not fully accepted by the church. He says (*H. E.*, iii. 25) "among the controverted books, which are yet well known and recognized by most is the epistle circulated under the name of James." But among the apostolic fathers we have quotations from it in the writings of Clement of Rome (*1 Ep. ad Cor.*, cc. 10, 12) and perhaps of Hermas (*Pastor*, mand. xii. 5). Further, in the Syriac version of Melito's apology there are some passages which bear a striking resemblance to the words of St James, and may have been quotations (see Cureton's *Spicil. Syr.*, pp. 42, 48); and the Peshito Syriac version contains the epistle. Origen in his commentary on John (*Works*, xix. 6) speaks of the epistle as

in "circulation under the name of James," and he quotes from it in another place (*Works*, xii. 129) as that of James, without any comment. Dionysius of Alexandria, who was at the head of the catechetical school there (245), quotes from the epistle. These are all the notices of the epistle on which dependence can be placed before the council of Laodicea (363), when it was included among the canonical books. But there seems no doubt that the words "well known and recognized by most," used by Eusebius indicate that the epistle was by him regarded as a part of Scripture, for in other portions of his works he alludes to it as if he so esteemed it, and evidence of its recognition in the Syrian Church speaks strongly in favour of its authenticity. For that church was most likely to have the best knowledge concerning the origin and early circulation of the epistle. We can account for the slight extent to which it was known from the fact that it was addressed, by a bishop who never moved from his home, to one section only of the Christian church, and was not likely to gain such wide acceptance at first as the epistles of St Paul, whose missionary labours made his name and his writings well known in different countries. Moreover, the tone of the epistle is practical and not doctrinal, and for this reason also it would be less likely to be noticed in the writings of the Christian fathers. Indeed, this feature of the epistle led Luther, who thought there was in it some contradiction to St Paul's teaching on the doctrine of justification by faith, to call it *eine rechte strokerne Epistel* (ed. of German N. T., 1522), "a veritable epistle of straw." But language like this is due to the distorted way in which the great Reformer looked at the subject. His day called for prominence to be given to the Pauline view of justification. St James's day had different needs. The character of those for whom this epistle was intended and their special dangers are sufficient to account for the way in which St James emphasizes what St Paul would as stoutly have maintained in a like case, that "faith without works is dead."

The view given above, which dates the epistle before the rise of the Pauline controversy, has been ably maintained by many recent theologians, especially in Germany, in opposition to the Tübingen school. See Schneckenburger's *Annotatio*, 1832; Luther's *Commentar*, 1858, 2d ed. 1870; Neander, *Phylogog*, 4th ed. 1847, p. 664 seq.; Ritschl, *Allgöth. Kirche*, 2d ed. 1857, p. 109 seq., and *Rechtf. und Versöh.*, 1874, ii. 277 seq.; Weiss, *Bib. Theol. des N. T.*, 1st ed. 1868, 2d ed. 1873; Bayschlag in *Stud. und Krit.*, 1874, i.; Hofmann, *Heilige Schrift*, vii. 3, 1876. Other scholars, while defending the genuineness of the epistle, recognize in it distinct allusions to the Pauline theology, and so prefer a later date. So, for example, Ewald (*Geschichte*, vi. 591 seq.; *Schwab. an d. Heb. u. Jakobus Rundsch.*, 1870), who takes the epistle as directed against mistaken inferences from Paul's teaching. The Tübingen school, on the other hand, regards the epistle as directly anti-Pauline, and at the same time denies that it is genuine. So Baur, *Paulus*, 2d ed. 1867, Anh. 2; Schwieger, *Nachap. Zeital.*, 1846, i. 413 seq.; Hilgenfeld, *Eintl.*, 1875, and in *Z. f. v. T.*, 1877, p. 87 seq.; Blom, *De Brief van Jacobus*, Dort, 1869, and in *Theol. Tijdsch.*, 1872, p. 241 seq. See also Holtzmann in Schenkel's *Bibelen*, s.v. "Jakobusbrief." The argument turns mainly on the interpretation of the doctrine of faith and works in chap. ii. 24, which formally at least is in direct opposition to Rom. iii. 28. In other words, Luther's difficulty is still the chief turning-point of the argument. Now it is certain that the antithesis between Paul and James is not really so sharp as it appears in the verses just cited, because the two do not attach the same meaning to the word "faith." In fact, James's faith without works is not Paul's justifying faith, but the useless faith without love spoken of in 1 Cor. xiii. We have to deal with two types of doctrine using the same terms in different senses, so that it is not inconceivable that the two may really be capable of such reconciliation in the practical Christian life as to make their divergences unimportant. But, say Baur and his school, there is no proof and great internal improbability that any type of doctrine existed before Paul, maintaining justification by faith alone, precisely in Pauline terms, and using the very illustrations of Abraham and Rahab which occur in the Pauline theology and the kindred epistle to the Hebrews. Starting with this difficulty, and indicating in detail the proofs of the author's familiarity with the peculiar terminology of the great Pauline epistles, the Tübingen school urge also that James ii. 5, i. 12 presuppose acquaintance with Rev. ii.

9, 10, and even that the allusion to Rahab (ii. 25) proves the author to have read Heb. xi. 31. Further, it is contended that the supposed marks of an early date, in the condition of the churches addressed, and payable of another interpretation, and that the persecution alluded to may be best understood of the time of Domitian. Finally, the language of the epistle is regarded as a proof that the date is not very early, and the author different from the thoroughly Hebrew figure of James as described by Hierocypus. The weight of these arguments is finally very unequal, and the ultimate solution of the controversy must mainly be in the region of Biblical theology, where one side has often been tempted to minimize the difference between James and Paul, while the other has not done justice to the positive value of the teaching of our epistle, often speaking of it as a mere ineffective polemic against Paul by one who did not understand him. Compare further Alford, *Gk. Test.*; Wordsworth, *Gk. Test.*; Bishop Lightfoot's *Essay on the Brethren of the Lord*; Davidson's *Introduction to the N. Test.*; Plumtree, *St James*; Semler, *Paraphrasis Ep. Jacobi*, 1781; Monod, *Introduction à l'Ép. de S. Jacques*, 1846; Wiesinger, "Der Brief des Jakobus," in Olshausen's *Bibelwerk*, 1854; Bonn, *De Jacobi epistola cum Siracida libro convenientia*, 1860; Reuss, *L'Épître de Jacques*, 1878. (J. R. L.)

JAMES I. (1394-1437), king of Scotland, third son of Robert III. and of Annabella Drummond of Stobhall, was born at Dunfermline in 1394. A second son, John, did not survive infancy. David, duke of Rothesay, the eldest son, had died under suspicious circumstances while committed to the care of the king's brother the duke of Albany, to whom had also been delegated the virtual government of the kingdom: and the king, in order to secure the safety of the surviving son, resolved in 1405 to place him under the protection of the king of France. The prince, however, on his way thither fell into the hands of the English, and Henry IV. determined not to admit him to ransom. On the death of his father, April 13, 1406, James became nominal sovereign, but, as he was still retained in captivity in England, the duke of Albany continued regent, and was succeeded, on his death in 1419, by his son Murdoch. At first James was confined in the Tower of London, but in 1407 he was removed to the castle of Nottingham, where he enjoyed as much liberty as was compatible with detection, and was treated in all respects by his governor, Sir John Pelham, as a member of the household. The physical and intellectual training begun at St Andrews under Bishop Wardlaw was completed by the most accomplished tutors, so that he not only attained to high proficiency in all kinds of manly sports, but reached perhaps a more varied and thorough culture than any of his contemporaries. His figure was not much if at all above the middle height, and, though thickset, was finely proportioned. His agility was no less remarkable than his strength; he not only excelled in throwing the hammer and putting the stone, but in all kinds of athletic feats demanding suppleness of limb and quickness of eye. As regards his intellectual attainments he is reputed to have been well acquainted with philosophy, and it is evident from his subsequent procedure as a sovereign that he had made a special study of jurisprudence; while, besides being a proficient in instrumental and vocal music, he cultivated the art of poetry with a success not surpassed by any previous English writers with the exception of his models Gower and Chaucer. Henry V., on succeeding his father in 1413, removed James to close confinement in the Tower, but shortly afterwards took him to Windsor, and in 1417, with the view of detaching the Scotch auxiliaries from the French standard, invited him to accompany him in his expedition against France. From this time, and especially after the death of the duke of Albany in 1419, James was treated with much consideration; and, having given a pledge of his friendly intentions towards England by his marriage with Lady Jane Beaufort, February 2, 1424, he finally obtained his release in the end of March of the same year, the Scottish nation agreeing to pay a ransom of £40,000, in name of expenses for his maintenance while in captivity.



With the reign of James I., whose coronation took place at Scone on the 21st May, may almost be said to begin the substitution in Scotland of constitutional sovereignty, regulated by definite principles and laws and modified by a regard to the opinions and interests of the subjects, for the indefinite authority of the king and the arbitrary rule of the nobles. It is true that after his death the lawless contests of the nobles broke out as fiercely as ever, but by his energetic repression of their violence during his lifetime, and more especially by the virtual creation of statutes law modelled on that of England, and the additional importance assigned to parliament, the heaven was partly prepared which was to work towards the destruction of their unlicensed influence. During a session of the parliament held at Perth on the 12th March 1425, James suddenly arrested a large number of the nobles, including the duke of Albany and his two sons, whom along with the earl of Lennox he caused to be executed. With similar strategy he at a parliament held at Inverness in 1427 arrested Donald of the Isles and fifty of his chiefs. Donald, however, on making all due submission, received his liberty; but when, in violation of his oath he made an abortive attempt to assert his independence, the king, on his making unconditional surrender, confined him to Tantallon castle. As was natural, the energetic rule of the king, and especially his stringent coercion of the nobles, aroused a secret purpose of revenge; and, acting on the inspiration of the earl of Athole, uncle of the king, Sir Robert Graham and other accomplices, with a band of three hundred Highlanders, suddenly, on the evening of the 20th or morning of the 21st February 1437, entered the apartment of the king in the priory of the Dominicans at Perth, and stabbed him to death with their daggers.

Although the constitutional reforms introduced by James I., and the general tenor of his reign, showed that in him were united in a rare degree decision in action with far-sighted sagacity, his merits as a statesman have been cast in the shade by his achievements in literature. It is also worthy of mention that it was owing chiefly to his representations when in captivity that the pope was induced to grant a bull for the erection of a university at St Andrews. The *Poetical Remains* of James I. were first published in 1783, edited by William Tytler. The principal poems of which he is the reputed author are *The King's Quair*, *Christis Kirk on the Grene*, and *Peblis to the Play*, and he also wrote several minor pieces. A manuscript of the *King's Quair* formerly belonging to Selden is preserved in the Bodleian library at Oxford. The poem, which is divided into seven cantos, and is written in the seven-lined stanzas of Chaucer, was composed during his captivity in England, to celebrate his love for the lady whom he afterwards married. It is allegorical in form and somewhat tedious in its minute description of details, but always preserves a smooth and harmonious versification, while it contains many finely imaginative passages inspired by true and tender feeling, and characterized by a charming simplicity and grace akin to those of his master Chaucer. One reason why many have doubted that James could be the author of *Christis Kirk on the Grene* is its entire dissimilarity in manner and style to the *King's Quair*. Pope's line, "A Scot will fight for Christ's Kirk o' the Green" is sarcastic, but undoubtedly chronicles a fact. The poem is a humorous delineation of a phase of Scotch rustic life, and its spirit and graphic vigour are not unworthy of Burns, who indeed has received from it more than one suggestive hint, and in *The Holy Fair* and *The Ordination* has imitated its refrain. The oldest evidence for assigning it to James I. is that of the Bannatyne MS. collection made by George Bannatyne in 1568; and, if this evidence is not conclusive for James I., it is so against James V., the only other probable

author. There is no printed edition earlier than 1663. Since then several separate editions have appeared, and it has also been printed along with *The Gaberlunzie Man* as the work of James V. That James I. was the author of the poem receives a certain amount of corroboration from its resemblance in subject and style to *Peblis to the Play*, the first words of which are quoted by John Major in describing a ballad which he attributes to James.

The contemporary authorities on the reign of James I. are principally Wytoun's *Cronykil*, and Bower's continuation of Fordun's *Scotichronicon*. To the succeeding century belong the histories of John Major, Hector Boece, and Bishop Lesley. The modern histories of Pinkerton, Tytler, and Burton are of course well known. In regard to questions connected with his character as an author, see Sibbald's *Chronicles of Scottish Poetry*; Walpole's *Royal and Noble Authors*; Chalmers's *Historic Remains of Scottish Kings*; Tytler's *Scottish Worthies*; Pinkerton's *Ancient Scottish Poems*; Ritson's *Historical Essay on Scottish Song*; Washington Irving's *Sketch Book*; Prescott's *Miscellanies*; and David Irving's *History of Scottish Poetry*. An account of the murder of James I., professedly translated from the Latin of John Shirley in 1440, has been published in an Appendix to Pinkerton's History; in vol. ii. of *Miscellaneous Scotia*, Glasgow, 1818; and in Galt's novel, *The Spacewife*.

JAMES II. (1430-1460), twin son of James I., was born in 1430, and, Alexander his elder brother having died in infancy, was shortly after the assassination of his father crowned king at Holyrood. During his minority the house of Douglas used every endeavour to extend their influence,—William, who succeeded to the earldom in 1443, ultimately making no pretension to conceal his claims to independent sovereignty, and at the festivities in 1449, in honour of the king's marriage to Mary of Gueldres, with ostentatious bravado bringing in his train as many as 5000 followers. Shortly after the king attained his majority he in 1452 invited Douglas to become his guest in Stirling castle, and, on his refusing to break the "bands" he had made with the other nobles, in sudden passion stabbed him with a dagger, after which Sir Patrick Grey completed the assassination with a poleaxe. It was not till 1454 that the struggle following this act of violence, which involved all Scotland in a series of intermittent contests, was brought to a close by the flight of the Douglas and the forfeiture of his estates to the crown. His own kingdom being freed from distraction, James resolved to take advantage of the protracted intestine conflict in England, known as the Wars of the Roses, to wrest from the English the possessions they held in the south of Scotland; but while conducting the siege of Roxburgh castle he was killed by the bursting of a cannon, 3d August 1460.

JAMES III. (1452-1488), king of Scotland, son of James II., was born 1st June 1452, and shortly after the death of his father was crowned king at Kelso. The custody of the young prince was entrusted to Bishop Kennedy of St Andrews, but in 1466 he was seized at Linlithgow by Lord Boyd, who in this way succeeded in obtaining the governorship of the royal fortresses, and also won the apparent friendship of the king. James was, however, as fickle and faithless as he was weak and pliant, and while Lord Boyd's eldest son, who had been created earl of Arran, and had married the king's sister, was absent in the summer of 1469 on an embassy to bring home the king's bride, Margaret of Denmark, the enemies of the Boyds set agencies in motion for having them tried for their seizure of the king. The earl of Arran, obtaining news of their machinations before landing, returned to Denmark; Lord Boyd fled to England; but Sir Alexander, brother of Lord Boyd, suffered execution, and the estates of the family were forfeited. James, whether the fault was his own or not, was sadly unfortunate in his connexion with his near relations. While his brother-in-law was a fugitive from his vengeance, his two brothers were also, whether justly or not, the objects of his animosity and dread. The earl of Mar, the younger brother, died at

Craigmillar castle in circumstances so suspicious that he was generally believed to have been murdered; and the duke of Albany the elder, making his escape from Edinburgh castle to France, afterwards in 1482 came to an agreement with Edward IV. to hold the kingdom as his vassal. The rivalry of Albany was the more formidable because James by the preference which he showed for artists and musicians and by his retired and reserved manners had alienated the majority of the nobility. While James in the summer of this year was leading an army against England, the nobles, headed by Douglas, suddenly at Lauder seized Cochrane and several of the king's other favourites, and, having hanged them before his eyes, returned with their royal captive to Edinburgh castle. On this Albany suddenly made his appearance, and, having demanded and received the king's liberty, assumed with apparently no objection on the part of James the sovereignty of the kingdom, until an accusation for treasonable connexions with England compelled him to flee thither. For some years after this Scotland enjoyed both outward and inward tranquillity, but the jealousy of the nobles against the king's favourites induced them in 1488, along with the young prince, afterwards James IV., to raise the standard of rebellion. The two armies met at the stream of Sauchieburn, near Stirling, but hardly had they come to blows when the king fled in panic from the field. In his flight he was thrown from his horse, and being received into the cottage of a miller near Bannockburn, was there (June 11) stabbed to death by a person unknown, undoubtedly a straggler from the hostile army.

JAMES IV. (1472-1513), king of Scotland, son of James III., was born March 17, 1472, and on the death of his father in 1488 was crowned king at Scone, probably on June 26th. As he not only adopted an entirely opposite policy with the nobles from his father, but also showed great affability towards the lower classes of his subjects, among whom he delighted to wander incognito, few kings of Scotland won such general popularity or passed a reign so untroubled by intestine broils. His libertinism was overlooked on account of his open and friendly bearing, and was to some extent atoned for by his hardiness and courage and his just and temperate rule. So slight were the attempts at insurrection on his accession to the throne that they scarcely required repression; and, although in 1491 Lord Bothwell and others entered into an agreement with Henry VII. to seize his person, the circumstances were always such as either not to require or not to favour the carrying out of the project. Indeed, Henry seems throughout to have greatly preferred the friendship of the Scotch monarch either to his active hostility or his enforced submission; and accordingly, although James had welcomed "Perkin Warbeck," the pretender to the English throne, and made a futile invasion of England in support of his claims, Henry after Warbeck left Scotland in 1497 was willing to forget all old causes of enmity. In September of that year a truce of seven years was negotiated between the two monarchs, and in August 1503 the alliance was confirmed by the marriage of James with the princess Margaret of England,—a union which led eventually in default of the Tudors to the accession of the Stuart dynasty to the English throne. Of the peace with England James took advantage to establish order in the Highlands, where he introduced a more complete legal jurisdiction. After the accession of Henry VIII. it became apparent that the friendly relations with England were no longer possible; and, James, having several private grounds of quarrel, was induced by the king of France to venture in 1513 on an invasion of England. His methods of warfare seem, however, to have been formed chiefly according to notions borrowed from the knightly tournaments, the organization of which had made him famous throughout Europe: and on the threshold of his enterprise

he was slain on the 9th September at Flodden Field, his death and the disastrous rout of his army being due to his rash and quixotic bravery.

JAMES V. (1512-1542), king of Scotland, son of James IV., was born at Linlithgow 10th April 1512, and crowned king at Scone in October 1513. At first the regency was vested in his mother, but after her marriage with the earl of Angus in 1514 the office was transferred by the estates to the duke of Albany. The English forebore to follow up their victory at Flodden, but the close connexion of Albany with France now aroused the jealousy of Henry VIII., and Scotland was continually exposed to more or less serious attacks from the English until Albany, to whose arrogant bearing and French manners and habits not even the enmity against him of Henry could reconcile the estates, finally in 1524 took his departure to the country of his choice. Upon this James, through the scheming of Henry, was "erected" king in the Tolbooth of Edinburgh, ruling the kingdom by the advice of his mother and the lords in council. In 1526 James was persuaded to choose as his governor the earl of Angus, who kept him in close confinement until May 1528, when he made his escape from Falkland, and put such vigorous measures in execution against Angus as compelled him to flee to England. In 1532 Angus, taking advantage of the discontent in the south of Scotland caused by the king's conduct towards the Armstrongs, and of the distracted condition of the Highlands, aided an English raid on the borders; but shortly afterwards negotiations for peace were begun, and a treaty was finally signed in 1534. In January 1537 James was married to Madeleine of France, but, she dying in July of the same year, he in June 1538 espoused Mary of Lorraine. Henry VIII. was by no means satisfied with the influence he exercised in Scotch affairs, or the amount of deference he received from his nephew; and, his jealousy receiving special provocation from the interest taken by James in foreign politics, he in 1542 despatched an expedition against Scotland, which failed from want of a commissariat. James determined to make reprisals, but owing to the indecision of the nobles, who had no love of the enterprise, his army was scattered at the rout of Solway Moss on the 25th November. On the 14th December following James died at Falkland. His successor was his daughter Mary, born seven days before his death. Though possessing a weak constitution which was further impaired by his irregular manner of life, James manifested great vigour and independence as a sovereign, both in withstanding the machinations of his uncle and opposing the influence of the nobles. The persecutions to which the Protestants were exposed during his reign were, however, due to the excessive influence exercised by the ecclesiastics, especially David Beaton, archbishop of St Andrews. The king's habit of mingling with the peasantry secured him a large amount of popularity, and has led many to ascribe to him the authorship of three poems descriptive of scenes in lower class life—*Christis Kirk on the Grene*, *The Gaberlunzie Man*, and *The Jolly Beggar*. There is no proof that he was the author of any of these poems, but from expressions in the poems of Sir David Lyndsay, who was on terms of special intimacy with him, it would appear that he occasionally wrote verses.

JAMES I (1566-1625), king of England. This sovereign, James VI. of Scotland, in whom the crowns of Scotland and England were united, was the son of Mary Queen of Scots and of Henry, Lord Darnley, and was born in the castle of Edinburgh 19th June 1566. His mother while in captivity having been forced to abdicate the sovereignty, James was crowned king at Stirling July 29, 1567. The regency was vested in the earl of Murray, who by his masterly political skill and force of character held



the various factions in complete restraint until his assassination at Linlithgow in February 1570. The absence of his authoritative will at once allowed free scope to the various elements of disorder latent in the kingdom, and during the regency of Lennox, who was mortally wounded in a fray at Stirling with the adherents of Mary, September 1571, and of the earl of Mar his successor, who died in October 1572, strife and confusion held almost rampant sway. The earl of Morton, the next regent, being possessed, however, of some of the high qualities of his predecessor Murray, succeeded with assistance from Elizabeth of England in quelling the last embers of insurrection, and afterwards held in check the interested ambition of the nobles, until in 1578 they succeeded in discrediting his influence by the scheme of placing the government nominally in the hands of the boy monarch. In June 1581 Morton suffered death for his connexion with the murder of Darnley. James, to whom were thus early entrusted the functions of sovereignty, had spent his infancy under the care of the earl of Mar, on whose death he was taken charge of by the earl's brother, Alexander Erskine. For his principal tutor he had George Buchanan, who inspired him with a genuine interest in learning and a strong ambition to excel in poetical composition; he was also so far influenced by the Reformed type of religion as to have imbibed a love for theological argument, although he always cherished a strong distaste towards both Calvinistic doctrine and the Presbyterian form of government. His character was indeed formed amidst moral and intellectual surroundings strangely mingled and inharmonious, in addition to which the nature he inherited was rather a medley of isolated capacities than a definite and distinct idiosyncrasy. From the first compelled to adopt an attitude hostile to his mother, and, at the same time that he could not but resent her imprisonment by Elizabeth, unable to trust in her intentions towards himself, he seems to have regarded her death both as a relief and as a calamity and disgrace. As he knew that each party in the state, the Catholics, the nobles, the Presbyterians, wished to make him their tool, he resolved to act towards them as suited his convenience; but, although he possessed a certain sharp shrewdness and foresight as well as no small knowledge of character, his inability to take a comprehensive view of affairs, or to form a truly courageous resolution, made his policy often rash and reckless in regard to matters seemingly small, and always shifting and irresolute in regard to affairs of the highest moment. The moral courage he possessed was not inconsistent with physical cowardice; indeed the chief element in it was an overweening self-conceit, to which the consciousness of superior intellectual attainments gave the consummating touch; and thus it was that the very difficulties of his position gradually nourished within him the conviction of the divine right inherent in his office, and caused all his conduct, wavering and uncertain as it was, to be inspired by the one purpose of building up his kingly prerogative.

Taking advantage of the weakness of the royal authority during the king's minority, the General Assembly of the Scottish Church resolved in 1581 to substitute Presbyterianism for Episcopacy, and James, being shortly afterwards seized by the nobles at the raid of Ruthven, was unable to put his veto on their procedure, until after the overthrow of those implicated in the conspiracy, when in 1584 the estates passed an act denouncing their assumption of legislative power. In 1585 James was, however, besieged in Stirling by the exiled lords, and compelled to pardon them and dismiss his favourite, Arran. As their influence was moreover backed by Elizabeth, and as the hopes of James were even thus early directed towards succeeding her on the English throne, he discovered it to be advan-

tageous to disguise his sentiments towards the Presbyterians. The destruction in 1588 that overtook the Armada of the Catholic Philip of Spain deprived James of all anxiety regarding the effects of his mother's testamentary disposal of her crown to that monarch, but it naturally inclined him for a time to a more close alliance with the Protestants, the result of which was seen, not only in his marriage in 1589 to the Protestant princess Anne of Denmark, but in an Act of the estates in 1592, which sanctioned the formal abolition of Episcopacy. In 1594 he also found it necessary to reduce the Catholic lords of the north of Scotland, but in 1597 he deemed it prudent to balance the influence of the Presbyterians, and also to flatter the hopes of the Catholics of England by securing the revocation of the forfeiture of the estates of the banished nobles, and permitting them to return. Previous to this his action against the preacher of a sermon in which Elizabeth was attacked as an atheist led to a "No Popery" riot in Edinburgh. The breach between him and the Presbyterians was still further widened by the statute of 1599, appointing a certain number of ministers to a seat in parliament with the title of bishop, and by his publication in the same year of his *Basilicon Doron*, in which he promulgated his views in regard to the divine right of kings. With the exception, however, of his peculiar experiences in connexion with the mysterious Gowrie conspiracy at Perth (August 5, 1600), the remainder of his reign in Scotland until his succession to the English throne in 1603 was quiet and uneventful; and the only fact of notable importance connected with his subsequent government of that kingdom is his suspension of the meetings of the General Assembly, until by the banishment and imprisonment of Melville and its principal leaders he was able in 1610 to convene an Assembly which agreed to the organization of a modified Episcopacy. The peculiar union of talents and defects which constituted the character of James made him perhaps the most unfit successor of Elizabeth that could have been chosen. His strutting pomposity was rendered strangely ludicrous by a personal appearance the several defects of which were heightened by their contrast with each other, and it was also constantly interfered with by his want of a proper sense of decorum. If he displayed great cleverness in avoiding immediate political difficulties and in gaining for the moment his own ends, he was incapable of adapting himself mentally to his new position as sovereign of England, and his fussy self-importance made it almost inevitable that he should mortally offend the political temperament then in England so peculiarly sensitive. Indeed, the traditional policy which the circumstances of Scotland had rendered almost a second nature to the Stuarts was repugnant to the susceptibilities of England, and utterly alien to her political constitution, and in the case of James all the worst defects of this policy were exaggerated. Thus his seeming shrewdness in small matters, and his witty and terse political axioms, only secured him the reputation of being the "wisest fool in Christendom;" and, while his absurd personality cast ridicule on his kingly pretensions, the general character of his political procedure estranged from him every party in the state, and called into nector influences which in the subsequent reign wrought the overthrow of the monarchy whose prestige he had almost hopelessly tarnished. Having narrowly escaped a plot of the Catholics to seize his person shortly after his arrival in London, James resolved to flatter their hopes by granting them toleration, but his proclamation in February 1604 against the Jesuits revealed the hollowness of his professions and led to the futile gunpowder conspiracy of November 1605. Its discovery dissipated for the time the alienation already begun between him and the Commons on account of his imprudent assertion of

his prerogative against the Puritans at the Hampton Court conference, and the subsequent disagreements in regard to ecclesiastical reform and a union with Scotland. Against the goodwill of the Commons, which showed itself in the readiness with which a subsidy was granted for his debts, he, however, trespassed almost immediately by abusing the royal custom of placing impositions on merchandise. All attempts at a compromise on the subject having failed, James in February 1611 dissolved the parliament, and a second parliament which he summoned in 1614 proving equally recalcitrant was also dissolved, the fact that it was not allowed the opportunity of transacting business earning for it from the courtiers the name of the "addled parliament." To help in filling the vacuum in his treasury, James had recourse with small success to the odious practice of demanding benevolences, and, in addition to various other misuses of his prerogative, to the excessive increase of monopolies, and to the virtual sale of peerages and other high offices. The administration of the affairs of the kingdom was at the same time gradually withdrawn from the council, and the whole executive authority entrusted to favourites. As the breach between him and his subjects gradually widened he became more anxious—both in order to supply himself with money, and to obtain the support of an influential external authority—for an alliance with Spain, and in 1617 negotiations were entered into for a marriage between the young prince Charles and the Spanish infanta. But on the part of Spain these proposals were never seriously entertained. Their only result was to impart such irresolution to the policy of James in reference to the Bohemian insurrection as to afford Spain the opportunity of seizing the Palatinate; and by continuing to dangle the possibility of the marriage before the eyes of James the emperor succeeded in delaying his interference till the Palatinate was lost. Still intent on his purpose of the Spanish marriage, to which he had ruthlessly sacrificed the life of Sir Walter Raleigh, James despatched his favourite Buckingham along with Charles to Madrid, and the return of the baffled and disappointed wooer in 1624 dissipated the last lingering sentiment of respect which the English nation may have cherished towards the king. Buckingham and Charles now virtually overrode the royal prerogative, and at their instance not only was war declared against Spain, but on the condition of granting toleration to the Catholics of England, a treaty of marriage between Charles and Henrietta Maria of France was signed at the close of 1624. James died on March 25, 1625.

James inaugurated his literary career in 1584 by the publication of the *Essays of a Prentice in the Divine Art of Poetry*, and in 1591 he published *Poetical Exercises at Vacant Hours*. His other compositions in verse include a paraphrase of the Revelation of St John and a version of the Psalms. As he deemed it necessary to give to the world his opinion on almost every subject of importance which then occupied public attention, his prose disquisitions are legion, but the best known are *Demonologie*, 1597; *Basilicon Doron*, 1599; and *Counterblast to Tobacco*, 1616. A collected edition of his prose writings was published in 1616, edited by the bishop of Winchester. Some of his poetical translations are not without merit, but both his prose and poetry, though displaying occasional wit and cleverness and some facility of composition, are studded with absurdities, and but for the fact that their author was a monarch would scarcely deserve a reference.

The original authorities for the reign of James I. are the state-papers published in the series of the Master of the Rolls; the *Register of the Privy Council of Scotland* (vol. ii. 1569-78, by Burton, 1878; vol. iii., 1578-85, by Masson, 1880); the *Letters and State-Papers during the reign of James the Sixth*, published by the Abbotsford Club; the *Letters of the children and other relations of James*, published by the Maitland Club, in facsimile form, from the originals in the Advocates' Library, Edinburgh; the letters published under the title of the *Court and Times of James I.*, 1846; his correspondence with Cecil, published by the Camden Society; the correspondence in the *Cabala*; Camden's *Annals*; Goodman's *Court of James I.*, edited by J. S. Brewer, 1839; Calderwood's

*History of the Church of Scotland: Melville's Diary; Historie and Life of James the seate, 1566-96, with a short continuation to 1617, published by the Bannatyne Club, Edinburgh, 1825; the secret histories by Osborne, Weldon, Heylin, and Peston, edited by Sir Walter Scott; Arthur Wilson's Life and Times of James I., London, 1653. See also, in addition to the histories of Burton, Tytler, Gardiner, Ranke, and others, Harris's Historical and Critical Account of the Writings of James I., 1573; Irving's History of Scottish Poetry; and Disraeli's Literary and Political Character of James I.*

JAMES II. (1633-1701), king of England, and as king of Scotland James VII., second surviving son of Charles I. and Henrietta Maria, was born at the palace of St James's, October 15, 1633, and was created duke of York in January 1643. During the civil war he was taken prisoner by Fairfax at Oxford in 1646, but in 1648 he made his escape to Holland. After the second failure of the Stuart cause he served for some time in the French army under Turenne, but at the command of his brother he in 1656 accepted a military commission from Spain. At the Restoration in 1660 he was appointed lord high admiral and lord warden of the Cinque Ports. For the management of the civil administration of the navy he had the qualification of industry and careful regard to details; and if his victory over the Dutch in 1665 was principally a happy stroke of good luck, and his drawn battle with De Ruyter in 1672 was more to his antagonist's credit than to his, still the fact that his career as an admiral was free from disaster shows that his seamanship must have been at least respectable. Outside, however, the sphere of practical routine, James was blind and insensate, and his whole political conduct—while it indicated that he could stoop to compromise and deception when he deemed these necessary—was marked by a heedlessness and perverse obstinacy possible only to a rigid and contracted understanding preoccupied with a single purpose. He possessed the vices of his race without its virtues and redeeming points, and in him the propensity to despotism developed itself in a form unmitigated by any mildness or amiable weakness of temper, unenlightened by any gift of foresight or practical wisdom, and unadorned by any personal accomplishment. Although at the Restoration his sympathies were so little Catholic that he supported the policy of Clarendon, whose daughter Anne he secretly married in September 1660, publicly acknowledging the union in the December following, he soon thereafter became a convert to Romanism, and in 1672, in opposition to the expostulations of his brother, openly avowed his change of faith. Anne Hyde having died in 1671, he also persuaded his brother to defy the wishes of both Houses of Parliament by permitting him in 1673 to marry the Catholic princess Mary of Modena. On account of the Test Act, passed in this year, he had been compelled to resign his office of admiral, and, although the marriage in 1677 of his daughter Mary to William, prince of Orange, somewhat allayed the distrust with which he was regarded, it was deemed advisable on the discovery of the Popish plot in 1679 that he should retire for a time to Brussels. Afterwards he was appointed lord high commissioner to Scotland, where his arbitrary bigotry found congenial employment in the persecution of the Covenanters; but in 1684 Charles ventured to dispense in his case with the Test Act, and restored him to his office of admiral.

The influence of the loyal enthusiasm which surrounded the last days of Charles in 1685 was felt in the calm acquiescence with which the nation witnessed James's succession to the throne on February 6, and his coronation on April 23, 1686. The trust awakened by his promise to preserve the Government both in church and state as by law established was indeed almost immediately rudely shaken by his public celebration of mass, by his prohibition of preaching against Catholicism, and by his appointment of Catholic officers to the army; but that the goodwill at



least of the Commons was still strong was manifested by the grant of a revenue of two millions, and by the enactment of severer measures against treason. If the loyalty of the nation had begun to waver, it was also for the time strengthened by the premature and headstrong attempts at rebellion by Argyll in Scotland, and Monmouth in England. The renewal of the Covenanting persecutions had, however, branded the name of James with the hatred of the Scottish people, and the butchery of the Bloody Assizes, which in England followed the discomfiture of Monmouth, left behind it a widespread horror, the repression of which only wrought effects on the mind of the nation the deeper and more ineffaceable. But James was too intent on his one aim—the establishment of irresponsible despotism—to scrutinize or consider the indirect consequences of his acts. In that aim was necessarily involved the restoration of Popery, because James was a Papist, but happily the accidental prominence given to this secondary and subordinate aim made the other impossible of success. In his imprudent zeal to accomplish his purpose, James outran the wishes even of Rome, but that was because the purpose which to the one was secondary was to the other primary. James required both a large standing army and freedom from the control of parliament; but for these ends a foreign source of money supply was at first necessary, and this he could only obtain by an arrangement which, while it was unpalatable to himself and loathsome to the nation, was far from acceptable to the pope,—namely, by becoming the temporary vassal of Louis of France, whose ambitious designs, notwithstanding his intense and virulent Catholicism, had awakened the jealousy of Rome. Besides, many of the individual acts of James were prompted by the Jesuits, with whom the pope was then at feud. The progress of James's ill-starred design was marked by clear and well-defined steps. While all England was shocked by the cruelties following the revocation by Louis of the edict of Nantes, James resolved to demand the repeal of the Test Act, and when this was refused by parliament he fabricated by means of corrupted judges a semblance of legal sanction for his disregard of its provisions, and not only encamped an army on Hounslow Heath, chiefly officered by Catholics, but manifested his determination that henceforth to be a Catholic should be a recommendation and not a bar to the highest offices of state, by creating Father Petre and five Catholic peers privy councillors. An appearance of liberality was indeed given to his policy by a declaration of indulgence to Protestant dissenters, but this only quickened suspicion as to his ultimate purpose. Moreover, while a commission was illegally appointed to restrain the discussion of political subjects by the clergy, the publication of Romanist sentiments was freely permitted, monasteries and Catholic schools were being rapidly augmented, and an attempt was made to swamp the Protestantism of the universities by conferring the principal dignities as they became vacant on Catholics. This final step, and a second declaration of indulgence of April 1688, which contained a provision for the prosecution of those clergymen who might refuse to read the declaration in their pulpits, dissipated the last atoms of veneration in the minds of the Tories for the divine right of the king; and after the birth of a son to James in May of the same year nearly every party in the state was prepared to support the invitation to William of Orange to aid in the restitution of the liberties of the country. The discussion of the motives which induced William to accept this invitation, and the results which followed his landing in England, belong properly to the article on WILLIAM III. James, finding the bulwarks of despotism crumbling around him, after refusing the advice of a council of lay and temporal peers to open negotiations

with William, made a pretence of yielding only to gain time to escape, and by his cowardly flight, which he persevered in even after being interecepted and brought back to London, rendered the coronation of Mary and William indispensable. All hope in England was for the time lost, and as by his action on the Test Act he had alienated the sycophantic estates of Scotland, the rising in the Highlands afforded no permanent benefit to his cause: but in Ireland it might be possible for him still to enjoy, though in diminished lustre, the glories of sovereignty until he should be restored to his vider dignities. If his policy towards Ireland had been dictated by the position in which he was now placed, it failed of its purpose, for even before the arrival of William he discovered that he had to fight his way to dominion, and finally, notwithstanding the aid of French troops, his craven irresolution in the face of danger lost him the battle of the Boyne, July 1, 1690, after which he made a hurried escape to France. An expedition to England in his favour was projected by Louis in 1692, but was frustrated by the defeat of the French fleet off Cape La Hogue on May 17, and another invasion planned to follow on the success of an assassination plot on February 10, 1696, was foiled by the discovery of the treachery. James died at St Germain, September 1701.

The principal contemporary authorities for the reign of James are the *Diaries* of Evelyn, Pepys, and Luttrell; Burnet's *History of His Own Times*; Sir William Temple's *Memoirs, Life of James II.*, London, 1705; Bishop Kennet's *History of England*; *The Ellis Correspondence*, London, 1829; and the *Life of James II.*, collected out of *Memoirs written by his own hand*, by J. C. Clarke, 1816. See also the *Life* by C. J. Fox, C. T. Watson, *James II. and the Duke of Berwick*, 1876; and the histories of Macaulay, Lingard, and Ranke.

JAMES, or, in full, JAMES FREDERICK EDWARD STUART (1688–1766), prince of Wales, called by his adherents James III. of England, but better known as the Pretender, was the son of James II. and Mary of Modena, and was born in St James's Palace, London, June 10th 1688. The general opinion prevailing at the time of his birth that he was a supposititious child seemed to be confirmed by a variety of circumstances, but it has been completely overthrown by undoubted facts. Shortly before the flight of the king to Sheerness, the infant prince along with his mother was sent to France, and afterwards he continued to reside with his father at the court of St Germain. On the death of his father he was immediately proclaimed king by Louis XIV. of France, but a fantastic attempt to perform a similar ceremony in London so roused the anger of the populace that the mock pursuivants barely escaped with their lives. A bill of attainder against him received the royal assent a few days before the death of William III. in 1702, and the Princess Anne, half-sister of the Pretender, succeeded William on the throne. An influential party still, however, continued to adhere to the Jacobite cause; and an expedition planned in favour of James failed of success chiefly in all probability because his falling ill of measles, on the eve of its departure, enabled the English to assemble so powerful a fleet as rendered disembarkation inadvisable. A rebellion in the Highlands of Scotland was inaugurated in September 1715 by the raising of the standard "on the braes of Mar," and the solemn proclamation of James Stuart, "the Chevalier of St George," in the midst of the assembled clans, but its progress was arrested in November by the indecisive battle of Sheriffmuir, and it was practically extinguished a few weeks afterwards by the surrender at Preston. Unaware of the gloomy nature of his prospects, the Chevalier landed in December at Peterhead, and advanced as far south as Scone, accompanied by a small force under the earl of Mar; but, on learning of the approach of the duke of Argyle, he retreated to Montrose, where the Highlanders dispersed to the

mountains, and he embarked again for France. A Spanish expedition sent out in his behalf in 1718 under the direction of Alberoni was scattered by a tempest, only two frigates reaching the appointed rendezvous in the island of Lewis. In 1719 James was married at Avignon to the Princess Clementina of Poland, by whom he had two sons, Charles Edward, and Henry, afterwards Cardinal York. His licentious habits soon led to a separation from his wife, and his indolence and irresolution having completely unfitted him for the rôle of aspirant to the English throne, the hopes and affections of his adherents were gradually transferred to his son Charles Edward, of whose career an account is given in vol. v. p. 426-7. James spent the remainder of his years at Rome, where he was regarded with very little esteem both by the pope and the populace. The papal soldiers mounted guard at the Palazzo Muti, where he resided, and the pope issued an order that he should be styled king of England, but the Italians were in the habit of naming him the king *here* in contradistinction to the king *there*, that is, in England. Latterly his regular income was 12,000 scudi from the pope, which only was supplemented by the donations, probably not very large, of the adherents of the cause in England. Horace Walpole, writing in 1752, thus describes him, "He is tall, meagre, and melancholy of aspect. Enthusiasm and disappointment have stamped a solemnity on his person which rather awakens pity than respect. He seems the phantom which good nature divested of reflexion conjures up when we think of the misfortunes without the demerits of Charles the First. Without the particular features of any Stuart, the Chevalier has the strong lines and fatality of air peculiar to them all." For several of the last years of his life the Chevalier was so infirm in health that he was unable to leave his bed-chamber. He died at Rome, January 12, 1766, and was interred in the church of St Peter's.

The Jacobite cause in Scotland has given rise to some of the finest specimens of national ballad literature. Two volumes of *Jacobite Relics* were published in 1819-1821, but the collection is very miscellaneous. An edition of Jacobite songs appeared at Glasgow in 1829, and a more complete collection was published in 1861, edited by Charles Mackay. See *History of the Jacobite Club*, London, 1712; *Secret Memoirs of Bar-le-duc*, 1716; Macpherson's *Original Papers; The Decline of the Last Stuarts*, printed for the Roxburgh Club, 1843; Chambers's *History of the Rebellion*, 1824; Jesse, *The Pretenders and their Adherents*, 1858; Thackeray, *Henry Esmond*; Delbosse, *L'Italie il y a Cent Ans*, 1836; Lacroix de Marès, *Histoire du Chevalier de Saint-Georges et du Prince Charles Etouard*, 1868 and 1876; Doran, *Manners and Customs of the Court of Florence*, 1875; *Id.*, London in the *Jacobite Times*, 1877.

JAMES, GEORGE PAYNE RAINSFORD (1801-1860), English novelist, was born in George Street, Hanover Square, London, in 1801, and was educated at Greenwich and afterwards in France. He began to write early, and had, according to his own account, composed the stories afterwards published as *A String of Pearls* before he was seventeen. Contributing plentifully to newspapers and magazines, he came under the notice of Washington Irving, who is said to have encouraged him to produce (in 1822) his *Life of Edward the Black Prince*. His next attempt was *Richelieu*, which was finished in 1825, and was well thought of by Sir Walter Scott (who apparently saw it in manuscript), but was not brought out till 1829. Perhaps Irving and Scott, from their natural amiability and invariable habit of encouraging literary aspirants, were rather dangerous advisers for a writer so well inclined by nature to abundant production as James. But he took up the ball of historical romance writing at a lucky moment. Scott had firmly established the popularity of the style, and James in England, like Dumas in France, reaped the reward of their masters' labours as well as of their own. For thirty years the author of *Richelieu*

continued to pour out novels of the same kind though of varying merit. The full list of his works in prose fiction, verse narrative, and history of an easy kind includes between seventy and eighty items, most of them being three-volume novels of the usual length. The best examples of his style are perhaps *Richelieu*, 1829; *Philip Augustus*, 1831; *Henry Masterton* (probably the best of all), 1832; *Mary of Burgundy*, 1833; *Darnley*, 1839; *Corse de Léon*, 1841; *The Smuggler*, 1845. His poetry does not require special mention, nor does his history, though for a short time in the reign of William IV. he held the office of historiographer royal. After writing vigorously in all these styles for about twenty years, James in 1850 went to America with his family. He was appointed consul at Richmond, Virginia, and held that post from 1852 to 1858. In September of the latter year he was appointed to a similar post at Venice, where he died May 9, 1860.

James has been compared to Dumas, and the comparison holds good in respect of kind, though by no means in respect of degree of merit. Both had a certain gift of separating from the picturesque parts of history what could without much difficulty be worked up into picturesque fiction, and both were possessed of a ready pen. Here, however, the likeness ends. Of purely literary talent James had little. His plots are poor, his descriptions weak, his dialogue often below even a fair average, and he was deplorably prone to repeat himself. His "two cavaliers", who in one form or another open most of his books have passed into a proverb, and Thackeray's good-natured but fatal parody of *Barbazure* is likely to outlast *Richelieu* and *Darnley* by many a year. Nevertheless, though James cannot be allowed any very high rank even among the second class of novelists, the generation that read him, and those chiefly youthful persons who read him now and will read him for some time to come so long as he is attainable on the bookstalls, are not wholly without excuse. He had a considerable portion of the narrative gift, and, though his very best books fall far below *Les trois Mousquetaires* and *La Reine Margot*, there is a certain even level of interest, such as it is, to be found in all of them. James never resorted to illegitimate methods to attract readers, and deserves such credit as may be due to a purveyor of amusement to the public who never caters for the less creditable tastes of his guests.

JAMES, JOHN ANGELL (1785-1859), preacher and author, was born at Blandford, Dorsetshire, June 6, 1785. After obtaining at school a knowledge of reading, writing, ciphering, and a little Latin, he was at the age of thirteen bound to a seven years' apprenticeship with a linendraper at Poole, with the view of assisting his father in his business at Blandford; but about the close of his term of apprenticeship he began to form the resolution of becoming a preacher, and in 1802 he went to prosecute his studies at the theological college of Gosport. After remaining there for a year and a half, he happened to pay a visit to Birmingham, where his preaching was so highly esteemed by the congregation of Carr's Lane Independent chapel that they invited him to "exercise his ministry amongst them," and accordingly, after finishing his short theological course, he was settled there in the beginning of September 1805, and ordained on the 8th May of the following year. For seven years his success as a preacher was comparatively small, but about 1814 his eloquence almost suddenly acquired for him a popularity which attracted large crowds wherever he officiated in England, and never faded during the long term of his subsequent ministry. At the same time his numerous religious writings, the best known of which are *The Anxious Inquirer* and *An Earnest Ministry*, acquired a wide circulation both in England and in America. He died at Birmingham



October 2, 1859. The degree of D.D. was conferred on James by the college of Princeton, New Jersey, and also by the university of Glasgow.

A collected edition of James's works appeared in 1860-64. See *A Review of the Life and Character of J. Angell James*, by J. Campbell, 1860; *True Greatness, a brief Memoir of J. A. James*, 1860; and *Life and Letters of J. A. James*, edited by R. W. Dale.

JAMESON, ANNA (1794-1860), was born in Dublin in 1794. Her father, Mr Brownell Murphy, who was a miniature and enamel painter of some celebrity, took part in his early days in the political commotions which then agitated Ireland. His removal to England in 1798 confined his attention fortunately to his more peaceful calling, in which he attained considerable skill, but his daughter's mind seems to have been influenced in the highest sense by the circumstances that surrounded her birth; she was distinguished from her tenderest years by that arduous and courage and keenness to supply the needs and redress the injuries of others which marked her career through life.

At sixteen years of age she undertook the office of governess in the family of the marquis of Winchester, and later in that of Mr Littleton, afterwards Lord Hatherton. Between these two engagements she accompanied a young pupil, one of a party of travellers, to Italy, a tour which gave rise to a narrative of what she saw and did, written in an imaginary character. This, her first literary production, the merits of which she little appreciated, did not make its appearance until after her marriage with Mr Robert Jameson, a barrister, in 1825, when it was advertised by a friend under the title of a *Lady's Diary*, and ultimately published by Mr Colburn as *The Diary of an Ennuyée*. Mrs Jameson's marriage was not a happy one; but, if not more unfortunate than many of her sex in this form of trial, she set the example of a rare discretion under it. Her marriage troubles were made no excuse for appealing against the laws of the land or the usages of society. The *Diary of an Ennuyée* attracted much attention. Italy was no such beaten ground then, nor a traveller with ardent feelings for art and nature so common, as both have become since. The authoress has been blamed for assuming the disguise of an invalid, who dies on her way back; but such a tinge of romance made no difference in the truth of her descriptions, while it procured them more readers.

In 1829 Mr Jameson was appointed puisne judge in the island of Dominica. It was decided to be impracticable for her to accompany him, and meanwhile Mrs Jameson visited the Continent again with her father. Traces of this journey appear in *Visits and Sketches at Home and Abroad*. Hitherto the subjects she had treated had been limited to impressions of outer scenes and passing things, or to abridgements of history, as in her good schoolbook *Female Sovereigns*. The first work in which her powers of original thought became embodied were her *Characteristics of Shakespeare's Women*, which appeared in 1832. These analyses of the great poet's heroines are unsurpassed for delicacy of critical insight and fineness of literary touch. They are the result of a penetrating but essentially feminine mind, applied to the study of individuals of its own sex, detecting characteristics and defining differences not perceived by the ordinary critic, and entirely overlooked by the general reader.

In 1833 Mrs Jameson paid her first visit to Germany, the literature and art of which country may be said to have then first roused the curiosity of English minds. Dresden and Tieck and Retsch, Frankfort and Dannecker, Weimar and, if not Goethe, who had died the year before, yet the homage which more than restored him to life, successively occupied her. Nor was she proof to the spell of the modern German art which the late King Louis of Bavaria had evoked in his caput J. Those conglomerations of hard

lines, cold colours, and pedantic subjects which decorated Munich were new to the world, and Mrs Jameson's enthusiasm first gave them the reputation which has long since faded away.

It was in 1836 that Mrs Jameson was summoned by her husband to join him in Canada. She started with many a regret for the life she was leaving, and was not long left in doubt as to the fruitlessness of the step. He failed to meet her, even by a letter, at New York, and she was left to make her way alone at the worst of seasons to Toronto. After six months' experiment she felt it useless to prolong a life far from all ties of family happiness and opportunities of usefulness. Before leaving, she undertook a journey to the depths of the Indian settlements in Canada; she explored Lake Huron, and saw much of emigrant and aborigines life unknown to travellers, which she afterwards embodied in her *Winter Studies and Summer Rambles*. She returned to England in 1838. It was at this period that Mrs Jameson first devoted her attention to the subject of art. She began by making careful notes of the chief private collections in and near London which had hitherto received no systematic description. This *Companion to the Private Galleries* was soon followed by the *Handbook to the Public Galleries*. These works were useful compilations, and had a certain circulation; but the authoress laid claim to no powers of real discrimination, and many of her verdicts, in which she only followed those that went before her, have been since superseded by exacter knowledge. These works, however, led on to those by which her literary career has been specially distinguished,—her series of *Sacred and Legendary Art*. The time was ripe for such contributions to the traveller's library. The *Arta Sacrorum* and the *Book of the Golden Legend* had had their readers, but no one had ever pointed out the connexion between these tales and the works of Christian art. The painters employed by convent or church had introduced the local or family saints according to contract, and the faithful had retained the tradition of their names; but for the modern Protestant traveller the whole was a *terra incognita*. The way to these studies had been pointed out in the preface to Kugler's *Handbook of Italian Painting* by Sir Charles Eastlake, who had intended pursuing the subject himself. Eventually he made over to Mrs Jameson the materials and references he had collected. They could not have been placed in better hands. She recognized the extent of the ground before her as a mingled sphere of poetry, history, devotion, and art. She directed the taste of her readers with judgment and even enthusiasm; and, with the same penetration that had guided her in her literary tasks, she threw many a light on a master's intentions which had escaped both artists and critics.

Another service Mrs Jameson rendered to the English public, and that the most valuable of all, has still to be noticed. She began her literary career by analysing books, she proceeded to analyse works of art, and she ended by analysing society. It was a natural supplement to a course of varied personal experience and no little struggle that her attention should be directed to the great moral questions of the day, and especially to those affecting the education, occupations, and maintenance of her own sex. Her early essay on *The Relative Social Position of Mothers and Governesses* is a masterpiece. She knew both sides; and in no respect does she more clearly prove the falseness of the position she describes than in the certainty with which she predicts its eventual reform.

To Mrs Jameson we owe the first popular enunciation of the principle of male and female cooperation in works of mercy and education. Her mind was peculiarly to be trusted with the advocacy of such tenets—it had become as clear and judicious by experience as it was ardent and

vigorous by nature. In her later years she took up a succession of subjects all bearing on the same principles of active benevolence, and the best ways of carrying them into practice. Sisters of charity, hospitals, penitentiaries, prisons, and workhouses all claimed her interest—all more or less included under those definitions of "the communion of love and communion of labour" which are inseparably connected with her memory. To the clear and temperate forms in which she brought the results of her convictions before her friends in the shape of private lectures, subsequently printed, may be traced the source whence living reformers and philanthropists took counsel and courage.

Mrs Jameson died in March 1860. She left the last of her *Sacred and Legendary Art* series in preparation. It was completed, under the title of *The History of our Lord in Art*, by Lady Eastlake. (E. E.)

JAMESON, or JAMESONE, GEORGE (c. 1587-1644), a Scotch portrait painter, was born, probably in 1587, at Aberdeen, where his father was architect and a member of the guild. After studying painting under Rubens at Antwerp, with Vandyck as a fellow pupil, he returned in 1620 to Aberdeen, where he was married in 1624 and remained at least until 1630, after which he took up his residence in Edinburgh. The department of painting which he chiefly practised was portraiture in oil, but he also painted a few historical subjects and landscapes. His portraits are generally less than life size. According to Walpole they are characterized by "delicacy and softness, with a clear and beautiful colouring"; but, although undoubtedly the instructions of Rubens had left their influence on his style, he has no claim to the title of the Vandyck of Scotland by which he is often known, and perhaps owed even his exceptional fame in Scotland as much to chance as to his own merits. Having been employed by the magistrates of Edinburgh to copy several portraits of the Scottish kings for presentation to Charles I. on his first visit to Scotland in 1633, the king rewarded him with a diamond ring from his own finger. This circumstance appears to have at once established his fame, and he soon found constant though not very remunerative employment in painting the portraits of the nobility and gentry of his native land. He also painted a portrait of Charles, which he declined to sell to the magistrates of Aberdeen for the price they offered. The largest collection of the works of Jameson is said to be that in Taymouth castle, and, besides those in the houses of several of the gentry of Scotland, there are a few in the colleges of Aberdeen. He died at Edinburgh in 1644.

JAMESON, ROBERT (1774-1854), regius professor of natural history in the university of Edinburgh, was born at Leith July 11, 1774. After an education at Leith grammar school and Edinburgh university, he became assistant to a surgeon in his native town; but, having studied natural history under Dr Walker in 1792 and 1793, he felt that his true province lay in that science, for which indeed he had had a predilection from boyhood. The course of his studies during the next few years is to be traced in his scientific papers and books. He went in 1800 to Freiberg to study for nearly two years under the learned Werner, and spent other two in Continental travel. On his return to Edinburgh in 1804, when he succeeded Dr Walker in the chair of natural history, he became, in lectures, writings, and controversy, perhaps the first great exponent in England of the Wernerian geological system; and it is to his credit that, when he found that theory untenable, he frankly and honestly announced his conversion to the views of Hutton. As a teacher, Professor Jameson was no less remarkable than Werner for his power of imparting his own enthusiasm to his students,

and from his classroom there radiated an influence which gave a marked impetus to the study of geology in Britain. It was his energy also that, by means of Government aid, private donation, and personal outlay, amassed the greater part of the splendid collection which now occupies the natural history department of the Edinburgh Museum of Science and Art. In 1808 Jameson founded the Wernerian Natural History Society, and in 1819, along with Sir David Brewster, he originated the *Edinburgh Philosophical Journal*, which after the tenth volume remained under his sole conduct till his death, which took place April 19, 1854. His bust, presented by the Wernerian Society to the museum some years before his death, now stands in the university library hall.

Professor Jameson was the author of *Mineralogy of Arran and the Shetland Islands*, 1798, incorporated with *Mineralogy of the Scottish Isles*, 2 vols. 4to, 1800; *Mineralogical Description of Scotland*, vol. i. pt. 1, "Dumfriesshire," 1804 (this was to have been the first of a series embracing all Scotland); *System of Mineralogy*, 1804; *Characters of Minerals*, 1804; *Elements of Geognosy*, 1809; and *Manual of Minerals and Mountain Rocks*, 1821; besides a number of occasional papers, of which a list will be found in the *Edinburgh New Philosophical Journal* for April 1854, along with a biographical sketch of the author.

JAMESTOWN, a village in Chautauqua county, New York, is situated on the Chautauqua Outlet at the southern end of Chautauqua Lake, about 55 miles south-south-west of Buffalo. It may be conveniently reached by rail, or by steamer from Mayville at the north end of the lake, and its vicinity is steadily rising into favour as a summer resort. The manufactures include alpaca, woollens, pianos and furniture, sashes and blinds, edge-tools and iron. The population, which in 1870 was 5336, was 7264 in 1880.

JAMI. Nûruddin 'Abdurrahmán ibn Ahmed (1414-1492), called el Jámí from his birthplace Jám in Khorásán, was the last great poet and mystic of Persia. See PERSIA.

JAMIESON, JOHN (1759-1838), author of the *Scottish Dictionary*, was born in Glasgow, where his father was a Dissenting clergyman, March 3, 1759. He was educated at Glasgow university, and subsequently attended classes in Edinburgh. After six years' theological study, Jamieson was licensed to preach in 1779. From 1780 till 1797 he was pastor of the Secession (Antiburgher) congregation of Forfar; and from 1797 till his death on July 12, 1838, he occupied the pulpit of the Antiburgher church in Nicolson Street, Edinburgh.

Jamieson's name stands at the head of a tolerably long list of works in the *Bibliotheca Britannica*; but by far his most important book is the laborious and erudite compilation, best described by its own title-page:—*An Etymological Dictionary of the Scottish Language; illustrating the words in their different significations by examples from Ancient and Modern Writers; showing their Affinity to those of other Languages, and especially the Northern; explaining many terms which though now obsolete in England were formerly common to both countries; and elucidating National Rites, Customs, and Institutions in their Analogy to those of other nations; to which is prefixed a Dissertation on the Origin of the Scottish Language.* This appeared in 2 vols. 4to, at Edinburgh in 1808, followed in 1825 by a *Supplement*, in 2 vols. 4to, in which he was assisted by scholars in all parts of the country. Both appeared together in later editions; in 1879 the first volume of an edition, in which the *Supplement* is incorporated in the body of the work, was published. Abridgments of the *Dictionary* have been issued in 1818, and in many subsequent years. Among Jamieson's other works may be mentioned *The Use of Sacred History*, 2 vols., 1802; *Hermes Scythicus, or the Radical Affinities of the Greek and Latin Languages to the Gothic*, 1814; and various essays, sermons, and poems. For his *Vindication of the Doctrine of Scripture and of the Primitive Faith concerning the Deity of Christ*, 1795, a reply to Dr Priestley, Jamieson received the degree of D.D. from the college of New Jersey.

JAMNIA ('Iamvía or 'Iámvēia), the Greek form of the Hebrew name Jabneel (Josh. xv. 11) or Jabneh (2 Chron. xxvi. 6), the modern Arabic *Yebna*, a city of Palestine, on the border between Dan and Judah, situated 13 miles south of Jaffa, and 4 miles east of the sea-shore. The



modern village stands on an isolated sandy hillock, surrounded by gardens with olives to the north, and sand-dunes to the west. It contains a small Gothic church, now a mosque. The place belonged to the Philistines in Biblical times, was taken by Judas Maccabæus (2 Mac. xii. 8, 9), and is mentioned by Strabo (xvi. 2) as a very populous village. The population was mainly Jewish (Philo, *Leg. ad Cæum*, § 30), and the town is principally famous as having been the seat of the Sanhedrin from 70 to 135 A.D. In 1144 a crusading fortress was built on the hill; it is often mentioned under the name Ibelin. There was also a Jabneel in Lower Galilee (Josh. xix. 33), called later Caphar Yama, the present village *Yemma*, 12 English miles south of Tiberias; and another fortress in Upper Galilee was named Jamnia (Joseph., *Vita*, 37).

JAMRUD, a ruined fort in Pesháwar district, Punjab, India, situated in 34° N. lat. and 71° 24' E. long., at the mouth of the Khyber Pass, 1670 feet above sea-level. It was occupied by Hari Singh, Ranjit Singh's commander, in 1836; but in April 1837 Dust Muhammad sent a body of Afgháns to attack it. A battle ensued, in which the Sikhs gained a doubtful victory, with the loss of their general, Hari Singh. During the military operations of 1878-79 Jamrud became a place of considerable importance as the frontier outpost on British territory towards Afghánistán.

JAMS and JELLIES are conserves of the pulp and juice of succulent and juicy fruits prepared by boiling with sugar. They differ from each other only in the fact that jam is a thick pulpy opaque preparation, sometimes of the entire fruit—rind, pulp, and kernel—and sometimes of fruits only partly broken, as in the case of black currant jam, while jellies are pure transparent gelatinous preparations of juices alone. The preparation of these preserves was formerly a purely domestic art; but of recent years manufactures of very large dimensions have sprang up for the preservation of many of the commoner fruits, as an example of which the marmalade trade may be cited, marmalade being simply a form of jam. The principal fruits commonly used for jam-making are varieties of plums, apricots, cherries, black currants, gooseberries, strawberries, raspberries, mulberries, cranberries, oranges, and quinces; rhubarb stalks are also employed. Jellies have a wider significance than is comprehended in the above definition, which embraces fruit jellies alone, as many jellies have for their basis isinglass and other gelatin-yielding bodies of animal origin, and starches also form with boiling water a kind of jelly. Fruit jellies owe their property of gelatinizing to the presence or development of a gummy principle in their composition, called pectin. Except in its gelatinizing effect pectin is in no way related to gelatin, being indeed a non-nitrogenous body closely allied to cellulose. Pectin is only found in very ripe fruits, but an allied body, pectose, which is abundant in growing and partially ripened fruits, is easily transformed into pectin by the action of heat, and such a transformation takes place in the boiling of the juices of acid nripe fruits. In the preparation of jellies it is essential to obtain the juices as free from all pulp and cloudiness as possible, therefore the less the fruits are squeezed the more transparent will be the resulting jelly. To get the juice to flow freely from hard fruits it is necessary in most cases to heat and in some instances to boil them. The quantity of sugar required for the preservation of jams and jellies varies from two-thirds to equal weight of the fruit or juice, and the boiling should be conducted at a gentle heat as short a time as possible after the addition of the sugar, which by long or violent boiling tends to become syrupy, this destroying the gelatinizing property. Jellies are principally prepared from red, white, and black currants, gooseberries, grapes, apples,

raspberries, cherries, bilberries, pomegranates, quinces, and various other juicy fruits. Jams and jellies for preservation are poured into earthenware jars; the surface of the preserves is then covered with a disk of paper dipped in brandy, and the jar tightly tied over with membrane or gummed paper, and stored in a cool dry situation. They must be prepared from clean dry fruit, and it is essential that cane and not beet sugar should be used for their preservation. Wet or otherwise damaged fruit, and all fruits preserved with beet sugar, are peculiarly subject to mouldiness, an evil against which some amount of precaution is necessary at all times. The domestic uses of these preparations, and the esteem in which they are held, are known universally. They have a refrigerating and gently laxative influence, and the citrate, malate, or tartrate salts they contain give them a positive value as anti-scorbutics, in addition to the pleasant and refreshing taste and flavour they possess. While these preserves have the same anti-scorbutic efficacy as the respective fresh fruits from which they are prepared, they are free from the tendency to induce choleraic disorders which frequently attends the consumption of uncooked fruits, and the sugar with which they are prepared possesses its own proper nutritive value as an article of food.

JAMU, or JAMMOO, a town in Kashmir state, Punjab, India, headquarters of Jamu province, in 32° 43' 52" N. lat. and 74° 54' 14" E. long. on the Tawi, a tributary of the Chenab, among the mountains of the outer Himáláyan range. The town and palace stand upon the right bank of the river; the fort overhangs the left shore at an elevation of 150 feet above the stream. The lofty whitened walls of the palace and citadel present a striking appearance from the surrounding country. An adjacent height commands the fortress, rendering it untenable against modern artillery. Extensive and handsome pleasure grounds and ruins of great size in the suburbs attest the former prosperity of the city when it was the seat of a Rájput dynasty of independent rájás, whose dominions extended into the plains and included the modern district of Siáلكot. It was afterwards conquered by the Sikhs, and formed part of Ranjit Singh's dominions. For its subsequent acquisition by Ghuláb Singh, see KASHMIR. The population is estimated at about 8000.

JANESVILLE, chief town of Rock county, Wisconsin, U.S., was founded in 1836, and received its city charter in 1853. It contains numerous churches and schools, including the State institute for the blind. Rock river, flowing through the city, supplies water-power for five flour-mills, two woolen factories, and a cotton factory; and the manufactures comprise boots and shoes, carriages and farm machinery, and beer. The population in 1870 was 8789; in 1880, 9018.

JANGIPUR, or JAHANGIRPUR, the chief town of the subdivision of the same name, in Murshidábád district, Bengal, situated on the left bank of the Bhágirathí, in 24° 28' N. lat. and 88° 6' 45" E. long. The town is said to have derived its name from having been founded by the Mughal emperor Jahángir. During the early years of British rule it was an important centre of the silk trade, and the site of one of the Company's commercial residences. Jangipur is best known as the toll station for registering all the traffic on the Bhágirathí. The number of boats registered there annually is about 10,000; the amount of toll is £8000, or about one-third of the total gross revenue derived from the Nadiyá rivers. The population in 1872 was 11,361.

JANIN, JULES GABRIEL (1804-1874), a remarkable instance of a certain kind of eritic, was born at St Étienne, the great manufacturing town of the department of the Loire, on December 24, 1804, and died at his house near

Paris in June 1874. His father was a lawyer, and he was well educated, first at St Étienne, and then at the famous Collège Louis-le-Grand at Paris. He betook himself to journalism very early, and worked on different papers, the *Figaro*, the *Quotidienne*, &c., until in 1836 he fixed himself as dramatic critic of the *Débats*. Long before this, however, he had made a considerable literary reputation, for which indeed his strange novel *L'Âne Mort et la Femme Guillotinée* (1829) would have sufficed. *La Confession*, which followed, was less remarkable in substance but even more so in style; and *Barnave*, in 1831, sustained the literary reputation of the author, though the violent attacks it contained on the Orleans family did not, when they were taken with his subsequent conduct, increase his reputation for consistency. From the day, however, when Janin became the theatrical critic of the *Débats*, though he continued to write books indefatigably, he was to most Frenchmen a dramatic critic and nothing more. His system was odd enough. He called himself "prince of critics," a self-presented testimonial in which the mixture of irony and vanity (in all senses of the word) which marked all his work may be detected. He was outrageously inconsistent, and judged things from no general point of view whatsoever, though at least latterly his judgment was usually good-natured. But few journalists have ever been masters of a more attractive fashion of saying the first thing that came into their heads, and if he had called himself a prince of journalists he would not have been far wrong. After many years of *feuilleton* writing he collected some of his articles in the work called *Histoire de la littérature dramatique*, which, as may be gathered from what has been said, by no means deserves the title. In 1865 he made his first attempt upon the Academy, but was not successful till five years later. Meanwhile he had not been content with his *feuilletons*, written persistently about all manner of things. No one was more in request with the Paris publishers for prefaces, letterpress to illustrated books, and all the other hackwork which usually engages in France men of letters of a somewhat higher class than those who generally devote themselves to it in England. He travelled (picking up in one of his journeys a curious windfall, a country house at Lucca, which fell to him in a lottery), and wrote accounts of his travels; he wrote numerous tales and novels, for the titles of which we have no space here, and composed many other works, of which by far the best is the oddly entitled *Fin d'un Monde et du Neveu de Rameau*, in which, under the guise of a sequel to Diderot's masterpiece, he showed to considerable advantage his great familiarity with the late 18th century. He married in 1841; his wife had money, and he was always in easy circumstances. In the early part of his career he had many quarrels; notably one with Felix Pyat, but latterly, partly owing to his critical authority and partly to his good temper and hospitality, he was a very popular man with his craft, and at his death his library was said to contain the greatest number of gift and dedication copies of contemporary works that had ever been brought to the hammer. Even in the few years since his death, however, his reputation has rapidly faded, and except with those who know how to look at literature in the largest and most tolerant way, it is not likely to revive. His *Âne Mort* is really a most remarkable book. Written half in parody, half in deliberate pursuance of the romantic ideas, it anticipated by fifty years in point of time and far excelled in point of literary value the recent performances of the naturalist school. Those who wish to know what Janin might have been should read this, *Barnave*, and the *Fin d'un Monde*. But for the most part his work is mere improvisation, and has no elements of vitality in it except a light and vivid style.

JANINA, JANNINA, JOANNINA, or, as the name is frequently written according to its actual Albanian pronunciation, YANINA, a town of European Turkey in southern Albania, or—to retain the ancient designation—Epirus. The position of Janina is strikingly picturesque. At the foot of the grey limestone mass of Mount Mitzekeli (1500 ft.), which forms part of the fine range of hills running north from the Gulf of Arta, there lies a valley (the Hellenia of antiquity) partly occupied by a lake; and on the slopes of a slight eminence, stretching down to the western shore, stands this town of St John. It has greatly declined from the state of barbaric prosperity which it enjoyed in the beginning of this century, when it was the seat of Ali Pasha, estimated to have from 30,000 to 50,000 inhabitants. The fortress—Demir-Kule or Iron Castle, which like the principal seraglio was built on a promontory jutting down into the lake—is now in ruins. But the town still possesses fourteen mosques, each embosomed by a cluster of trees, and there are also seven churches, two synagogues, a Greek college, a library, and a hospital. As the centre of a vilayet it contains a governor's residence (rebuilt in 1870). Sayades (opposite Corfu) and Arta are the places through which it receives its imports. A considerable activity in trade and industry is maintained by the Greek population, the rich gold and silver embroidery for which the town has long been famous being still one of the notable articles in its bazaar. According to M. Moreau, the French consul (*Bull. de la Soc. de Géogr.*, Paris, 1876), Janina contained 16,230 inhabitants in 1875, of whom 4136 were Mahometans, 8989 Christians, and 3105 Jews. Synvet (*Les Grecs de l'Empire Ottoman*, Constantinople, 1878) reckons the Greeks alone at 14,362 (the island on the lake being included). The vilayet of Janina, previous to the cessions made to Greece in 1881, comprised the sandjaks of Janina, Argyrocastro, Berat (Avlona), Prevesa, and Thessaly, and the sandjak contains the districts of Janina (town and country), Aidwat, Prevena, Cognitza, Metzovo, and Philates. The lake (perhaps to be identified with the Pambotus of antiquity) is 6 miles long, and has an extreme breadth of 3 miles. In time of flood it is united with the smaller lake of Labchistas, which lies to the north. According to Guido Cora's investigations in 1878, the greatest depth does not exceed 32 feet. There are no affluents of any considerable size, and the only outlets are underground passages or *katavoltra* extending for many miles through the calcareous rocks.

The theory supported by Leake (*Northern Greece*) that the citadel of Janina is to be identified with Dodona, is now generally surrendered in favour of the claims of a more southern site. As Anna Comnena, in describing the capture of the town (τὰ Ἰωάννινα) by Bohemond in 1082, speaks of the walls as being dilapidated, it may be supposed that the place existed before the 11th century. It is mentioned from time to time in the Byzantine annals, and on the establishment of the lordship of Epirus by Michael Angelus Comnenus Ducas, it became his capital. During the 14th century it was frequently attacked by the Albanians; but it was still in possession of the successors of Michael when the forces of Sultan Anurath appeared before it in 1430 (*cf. Hahn, Alban. Studien*, pp. 319-322). Since 1431 it has continued under Turkish rule. In modern times it became famous as the seat of the tyrant Ali (1783-1822). See ALI PASHA, vol. i. p. 573. Descriptions of Janina will be found in Holland's *Travels*, 1815; Hughes, *Travels in Greece*, &c., 1830; Foxer, *The Highlands of Turkey*, 1869. See also Major R. Stewart, "On the Phys. Geogr. of Epirus," in *Journ. Roy. Geogr. Soc.*, 1869.

JANIZARIES, or JANISSARIES (Turkish, *Yeni*, new, and *askari*, soldier). See ARMY, vol. ii. p. 617.

JANSEN [JANSENIUS], CORNELIUS (1565-1638) bishop of Ypres, and the author of the celebrated *Augustinus*, was born, of humble Catholic parentage, at Acquoy or Aekooi, a small village near Leerdam, and 7 miles to the north-east of Gorcum, Holland, on 28th October 1565. After completing his preliminary studies at Leerdam and



Utrecht, he in 1602 proceeded to Louvain, where he studied for a short time at the Jesuit college; but afterwards, becoming dissatisfied with the doctrines there taught on the hotly discussed questions of free will and grace, he transferred himself to the college of Adrian VI., where he came under the influence of a pious and learned teacher, Jacobus Jansonius by name, who is described as having been an ardent disciple of Augustine and a follower of Michael Bajus (see *BAJUS*), whose doctrinal views had been condemned by Pius V. and Gregory XIII. At the same time he formed an acquaintance, which grew into intimate friendship, with the like-minded Vergerius (see *DU VERGIER DE HAURANNE*), who afterwards became abbé of St Cyran. Having graduated in philosophy at Louvain in 1604, Jansen went to Paris for the benefit of his health, which had suffered from the ardour with which he had pursued his studies in theology with a view to a doctor's degree. Here he remained for some time, supporting himself by teaching; afterwards he accompanied Vergerius to Bayonne, the native place of the latter, where they spent several years together, Du Vergier ultimately becoming canon of the cathedral, and Jansen head of the episcopal college. Every available moment of their time was devoted to the study of the fathers and especially of Augustine. In 1617 Jansen returned to Louvain, whither he had been urgently summoned by Jansonius, who greatly desired to have there a man of real learning and energy who should be able to counteract the growing influence of the Jesuits. On his arrival he undertook the principal charge of the newly founded college of St Pulcheria, but this appointment he did not long retain, feeling, it is said, a growing aversion to philosophical pursuits, and desiring to possess the utmost possible leisure that he might devote himself wholly to theology. In 1619 he became doctor in that faculty. The reputation which he even then enjoyed as a theologian is well indicated by the fact that he was formally requested by the papal nuncio to undertake a reply to the recently published *De Republica Ecclesiastica* of Marco Antonio de Dominis, archbishop of Spalatro, while the direction in which his sympathies so strongly ran was at the same time not obscurely indicated by the fact that he excused himself from complying with the invitation. In 1624, and again in 1626, he undertook a journey to Spain, on behalf of the university, with reference to certain encroachments of the Jesuits on its exclusive privileges; in the second of these missions he was successful, the members of the Society of Jesus in the Low Countries being ordered to continue to observe the restrictions which had been laid upon them in 1612. In 1630 Jansen was made regius professor of Biblical exegesis; and in the same year, in connexion with the recent introduction of the Reformed religion into Bois-le-Duc, he entered upon a controversy about Protestantism with the learned Voetius, the issue of which conclusively showed that he had grievously underestimated his adversary's strength. In 1635 he published a pseudonymous work entitled *Alexandri Patricii Armanani, Theologi, Mars Gallicus, seu de justitia armorum et federum Regis Gallia libri duo*, embodying an argument and remonstrance against the policy of France in its recent alliance with the Protestant Gustavus Adolphus. For this supposed service to Spain he was rewarded in 1636 with the bishopric of Ypres. He was preparing for the press his great work upon St Augustine, which had occupied him for twenty-two years, when he was cut off by sudden illness on May 6, 1638. By his last will the MSS. of this work were bequeathed to his chaplain Lamæus, and his friends Fromondus and Calenus, to be published "quam fidelissime"; at the same time he declared his obedience to the Roman See should any alterations be desired.

The title of the first work of Jansen against Voetius was *Alexipharmacum*; it called forth *Nota in Alexipharmacum*, to which he replied in his *Spongia*, 1630. On the publication of Voet's *Desperata Causa Papatus* in 1635, Jansen handed over the further management of the controversy to Fromond, whose *Crisis* (1636) was met with Schook's *Desperatissima Causa Papatus*. Among other works of Jansen are mentioned *Tetrateuchus sive Commentarius in IV. Evangelia* and *Pentateuchus sive Commentarius in V. libros Moysis*. See *Leydeker's Historia Jansenismi* (Utrecht, 1695).

**JANSENISM.** The *Augustinus, seu doctrina S. Augustini de humanæ naturæ sanitate, ægritudine, et medicina, adversus Pelagianos et Massilienses* of Jansen, published in 1640, is a work in three folio volumes. The first of these is devoted to an historical exposition of the Pelagian and Massilian (semi-Pelagian) heresies; the second sets forth the Augustinian doctrine as to the state of innocence and the fallen state; while the third treats, in ten books, of the grace of Christ the Saviour. The sting of the work is to be found mainly in the epilogue, which draws a parallel, in various particulars, between the errors of the Massilians and those "recentiorum quorundam," the Jesuits being referred to. Its bearing upon previous controversy had become well known long before its publication; and while it was still in the press at Louvain strenuous efforts were made by the Jesuit party there, through the papal inter-nuncio, to induce the university to prohibit its appearance, on the ground that various popes had forbidden that anything should be written on the delicate subject of the grace of God without express papal permission. These efforts not only failed to attain their immediate object, but had the effect of greatly stimulating public interest in the *Augustinus* when it appeared; and as soon as it arrived in Paris it was forthwith reprinted with the written approval of six of the most eminent doctors of the faculty of theology there. In 1641 the reading of the book, thus flung into the arena of theological controversy and ecclesiastical intrigue, was prohibited by the Inquisition; no opinion, however, was pronounced as to its doctrine, and the counter-agitation of the Jesuits in relation to it was condemned as inconsistent with the spirit of the papal injunctions already referred to. But the dispute did not admit of being thus quietly repressed, and accordingly, in 1643, the bull *In eminenti* of Urban VIII. was published, renewing and confirming the constitutions of Pius V. and Gregory XIII., as well as the decrees of Paul V. and of himself, and forbidding the reading of the *Augustinus*, not only on the ground that its appearance had not been sanctioned, but also because it contained various errors. This bull encountered a very general resistance in the Netherlands, on the part both of the university of Louvain and of the clergy at large; but ultimately, through the intervention of the Spanish Government, it was accepted (1651), subscription to it, however, not being insisted on. At the Sorbonne also it was badly received, and the dissatisfaction it had caused in France found expression in the *Apology for Jansen* by Arnauld in 1644, which was followed by a second in 1645. The strength of these *Apologies* lying largely in the fact that no particular doctrines of Jansenius had been condemned as heretical in the papal bull, the Jesuits, inflexible in their determination to secure the effectual condemnation of a book which told so powerfully against their distinctive theology, immediately set about obviating this weakness in their attack, and various attempts were accordingly made to formulate, in the shape of definite propositions, the heresy which they believed to exist. In 1646 eight such propositions were stated by Habert, "theologal" of Notre Dame, to be submitted to the judgment of the pope; subsequent successive adjustments reduced them in 1650 to five, which in the name of eighty-five French prelates were forwarded for condemnation to Rome. They were as follows:—(1) There are some com-

mandments of God which just men, although willing and anxious to obey them, are unable with the strength they have to fulfil, and the grace by which they might fulfil them is also wanting to them; (2) in the state of fallen nature inward grace is never resisted; (3) in the fallen state merit and demerit do not depend on a liberty which excludes necessity, but on a liberty which excludes constraint; (4) the semi-Pelagians admitted the necessity of an inward preventient grace for the performance of each particular act, and also for the first act of faith, and yet were heretical inasmuch as they maintained that this grace was of such a nature that the will of man was able either to resist or obey it; (5) it is semi-Pelagian to say that Christ died or shed His blood for all men without exception. The pope long resisted the pressure with which he was urged to pronounce upon these theses in an adverse sense; it is easy to understand why he should steadily have inclined to the old and simple expedient of enjoining silence upon disputants on either side of the controversy; for, if the Jansenist propositions had a Calvinistic ring about them, there was no denying that they also admitted of an Augustinian and therefore presumably of an orthodox interpretation. At length, however (May 1653), Innocent X. in the bull entitled *Cum occasione impressionis libri* pronounced the first four points heretical, while the fifth was declared to be false, with the addition that, if it was intended to convey the meaning that Christ died only for the elect, it was impious and blasphemous as well as heretical. This bull was accepted and promulgated in France and the Netherlands with the royal consent, and the victory of the Jesuits was quite decisive. The Jansenists still seemed indeed to have one line of defence left to them; they expressed themselves willing to condemn the five propositions in their heretical sense, but not as propositions of Jansen. This position, however, ceased to be tenable when, in September 1654, the pope declared that the propositions were found in the *Augustinus* of Jansen, and that their condemnation, as doctrines of Jansen, was imperative. Arnauld nevertheless, with whom were the other Port Royalists (see PORT ROYAL), refused to yield. In the second of his "Letters" to a person of quality (the Duc de Luines), he argued that, while the Holy See had authority to decide with respect to doctrine, and every good Catholic owed submission not only "de respect" but also "de croyance" to such determinations, yet it might be mistaken on the question of "fact" whether a given book contained certain statements or not. The commotion which ensued called forth in January 1656 the first and second of the *Provincial Letters* of Pascal, but these brilliant controversial efforts did not suffice to avert the expulsion of Arnauld from the Sorbonne (31st January 1656). In the following year the theological faculty of Paris drew up a formula avowing full acceptance of the bull of Alexander VII., in which it had been specifically declared that the five propositions contained *de facto* Jansenist error. This document, sanctioned by the king in 1661, the clergy and all inmates of conventual establishments were called upon to sign, all who refused being treated as heretics. The leading Jansenists were compelled to go into hiding, and the nuns of Port Royal were subjected to imprisonment, and other harsh treatment. Many of the clergy, with whom were four bishops, persisted in their refusal to sign, until at last, in September 1668, the compromise called the "peace of Clement IX." was arranged, in virtue of which, by the omission of a single word ("purement"), assent was no longer required to the proposition that Jansen had actually taught the five propositions in a "purely" heretical sense. The respite from controversy and persecution thus secured was not of long duration. The Jesuits were quite unable to make a moderate use of the power of

which they were now so fully ascertained. Arnauld was driven into Holland, where he found congenial society and apt disciples in Catholic circles, and particularly at Delft. In 1705 a bull was obtained from Clement XI. in which the heretical character of Jansen's teaching, in Jansen's sense, was authoritatively asserted, and thus the peace of Clement IX. was destroyed. This measure ultimately led, in 1710, not only to the breaking up of the establishment at Port Royal, but also to the destruction of the very buildings. Louis XIV. was further induced to approach the pope for a decision upon the doctrine contained in Quesnel's *Réflexions morales sur le Nouveau Testament*, a work of practical edification, which, published in 1693-94, had attained great popularity in France, and been recommended by many bishops, including the cardinal-archbishop of Paris, De Noailles, but was suspected of latent Jansenism. In this way the bull *Unigenitus* (1713) was obtained, in which no fewer than one hundred and one propositions taken from Quesnel were condemned as erroneous and heretical. The result was to divide the French Church into two parties, the acceptants or constitutionists, and the appellants or anti-constitutionists; but again the Jesuit influence was able to secure the ultimate defeat (1728) of Noailles and his party, and in 1730 the bull was formally registered as the law of the kingdom. Oppressed Jansenism now changed its method of defence. Reports of miracles wrought in the cemetery of St Medard, Paris, at the grave of François de Paris, a young Jansenist deacon who had died in 1727, began to be circulated; and the spot became a pilgrimage centre daily visited by thousands of fanatics. It was in vain that the place was walled up (giving occasion to the witty epigram "De par le Roi, défense à Dieu De faire miracle en ce lieu"); portions of earth which had been taken from the grave were equally efficacious, and the number of convulsory prophets of coming ruin to the state and church continued to increase. Repression by imprisonment and other violent means was vainly attempted; but as the novelty of the movement wore off the excitement gradually died down; and after the middle of the 18th century, the appellants or Jansenists of France ceased to make any figure in the public view. Their cause may be said to have been buried in the grave of François de Paris. In Holland the history of the disciples of Jansen followed a different course. The Catholics there, though steadfastly refusing to be called Jansenists, became deeply imbued with his views; at their head was the archbishop of Utrecht, who on this account was deprived by the pope in 1704. In 1723 the chapter there secured the consecration of a successor (which the pope had steadily refused) by an appelliant bishop; in similar circumstances bishops were consecrated at Haarlem and Deventer also, and the separatist church thus constituted still subsists, though its members in 1869 were under 6000. Its adherents claim to be disciples of St Augustine and members of the Catholic Church, of which they recognize the pope as the visible head, although they deny his infallibility.

For the earlier stages of the history of Jansenism, see Leydecker, *Historia Jansenismi*, 1695, and the anonymous work of Gerberon, *Histoire Générale du Jansénisme*, 1700. Modern authorities are Sainte-Beuve, *Port-Royal*, 1840-48, 31 ed. 1867; Reuchlin, *Geschichte v. Port-Royal*, 1839-44; and Bouvier, *Étude critique sur le Jansénisme*, 1864.

JANSSSEN, or JANSEN (sometimes JOHNSON), CORNELIUS (1590-1665), painter, was born at Amsterdam about 1590. About 1618 he went to England, where he was patronized by James I. and the court. Under Charles I. he continued to paint the numerous portraits which adorn very many of the mansions and collections of England; but in 1648, after the outbreak of civil war, he retired to Holland, where his brush was busy till his death in 1665. Janssen's pictures, chiefly portraits, are distinguished by clear



colouring, delicate touch, good taste, and careful finish. He generally painted upon panel, and often worked on a small scale, sometimes producing replicas of his larger works. A characteristic of his style is the very dark background, which throws the carnations of his portraits into rounded relief.

JANSSENS, or JANSENS, VAN NUYSSEN, ABRAHAM (1567-1632), painter, was born at Antwerp in 1567. He studied under Jau Snellinck, was a "master" in 1602, and in 1607 was dean of the master-painters. Till the appearance of Rubens he was considered perhaps the best historical painter of his time. The styles of the two artists are not unlike. In correctness of drawing Janssens excelled his great contemporary; in bold composition and in treatment of the nude he equalled him; but in faculty of colour and in general freedom of disposition and touch he fell far short. A master of chiaroscuro, he gratified his taste for strong contrasts of light and shade in his torch-lights and similar effects. Good examples of this master are to be seen in the Antwerp museum and the Vienna gallery. The stories of his jealousy of Rubens and of his dissolute life are quite unfounded. He died at Antwerp in 1632.

JANSSENS, or JANSENS, VICTOR HONORIUS (1664-1739), painter, was born at Brussels in 1664. After seven years in the studio of an obscure painter named Volders, he spent four years in the household of the duke of Holstein. The next eleven years Janssens passed in Rome, where he took eager advantage of all the aids to artistic study, and formed an intimacy with Tempesta, in whose landscapes he frequently inserted figures. Rising into popularity, he painted a large number of cabinet historical scenes; but, on his return to Brussels, the claims of his increasing family restricted him almost entirely to the larger and more lucrative size of picture, of which very many of the churches and palaces of the Netherlands contain examples. In 1718 Janssens was invited to Vienna, where he stayed three years, and was made painter to the emperor. The statement that he visited England is based only upon the fact that certain fashionable interiors of the time in that country have been attributed to him. Janssens's colouring was good, his touch delicate, and his taste refined. He died in 1739.

JANUARIUS, ST, or SAN GENNARO, the patron saint of Naples, according to the Roman Breviary, was bishop of Benevento, and flourished towards the close of the 3d century after Christ. On the outbreak of the persecution by Diocletian and Maximian, he was taken to Nola and brought before Timotheus the governor of Campania on account of his profession of the Christian religion. After he had withstood various assaults upon his constancy, he was at last sentenced to be cast into the fiery furnace, through which he passed wholly unharmed. On the following day, along with a number of fellow martyrs, he was exposed to the fury of wild beasts, which, however, contrary to their nature, laid themselves down in tame submission at his feet. Timotheus, again pronouncing sentence of death, was struck with blindness, but immediately healed by the powerful intercession of the saint, a miracle which converted nearly five thousand men on the spot. The ungrateful judge, only roused to further fury by these occurrences, caused the execution of Jannarius by the sword to be forthwith carried out. The body was ultimately removed by the inhabitants of Naples to that city, where the relic became very famous for its miracles, especially in counteracting the more dangerous eruptions of Vesuvius. His clotted blood, preserved in a glass phial, even to this day is wont to liquefy and bubble up as if but recently shed whensoever it is placed within sight of the martyr's head. So far the Breviary. This liquefaction of the blood, which is brought about at least twice a year on

May 1 and on September 19, the day assigned to the saint in the Roman calendar, is a miracle the recurrence of which is observed by believing Neapolitans on each occasion with various festivities extending over a whole week. The Januarius of Cordoba whom along with Saints Faustus and Martialis, a special local office is assigned in the Spanish Breviary, has a story which bears a general resemblance to the preceding; he also is stated to have suffered under Diocletian and Maximian, but the scene of his martyrdom was Cordoba. His day is October 13, and the invention of his remains is commemorated on November 26. The number of minor saints of this name is very considerable; the cognomen appears to have been somewhat common.

JANUARY, the first month in our present calendar, consists of thirty-one days. It was, however, not the first month of the year in the British Isles till the reformation of the calendar was made in 1752, when the legislature, by an Act passed in the preceding year, altered the mode of reckoning time from the Julian to the Gregorian style. At this period it was directed that the legal year which had commenced in some parts of the country on March 25, and in others with January, should thenceforward be appointed to begin always on the 1st of January. January derives its name from the god Janus, who had two faces looking in opposite directions, and Macrobius states that it was dedicated to him because, from its situation, it might be considered to be retrospective to the past and prospective to the opening year. The consecration of the month took place by an offering of meal, salt, frankincense, and wine, each of which was new. On the first of this month all enmities were suspended, presents were exchanged, consuls installed, &c. The principal festivals now observed in this month are the following:—Jan. 1, New Year's Day, Feast of the Circumcision; Jan. 6, Epiphany, Twelfth-Day; and Jan. 25, Conversion of St Paul. See CALENDAR.

JANUS, a Roman god, after whom the month of January was named. His temple was open in war and closed during peace, and the ceremony of closing it for the third time in Roman history was performed by Augustus, 29 B.C., when he had established his authority over the whole empire. This temple, which was in reality only an arch or gateway, facing east and west, stood near the forum. When most of the Roman gods were merged in Greek divinities, Janus retained his native character. Amid the obscurity that hangs over the genuine Roman religion, it is difficult to determine the nature and origin of Janus: It is probable that he was the chief deity of one of the races which were united in the Roman people, and that his worship was maintained beside, but overshadowed by, that of Jupiter, the chief deity of another of these races. The hill of Janus, Janiculum, lay on the north or Etruscan side of the Tiber, and was doubtless the seat of his original worshippers. An Etruscan origin is thus suggested, and most authorities accept this hypothesis. The Romans themselves thought that Janus and the feminine Jana, *i.e.*, Diana, were sun and moon; and the names are commonly assimilated to the Greek Ζην, *i.e.*, Δην. If, however, Janus was an Etruscan god, belonging to the Etruscan element in Rome, he must then be identified with the Etruscan deity Aai, the form of the name being prompted by the word *janua*, as Janus is the god of opening and beginning. The god is represented with two faces looking in opposite directions, a design found on the coins of the Etruscan Volaterra, but possibly due to the influence of Greek art:

See Preller, *Röm. Myth.*; Gerhard, *Griech. Myth.*, ii.; Hartung, *Relig. der Römer*; Schwieger, *Itin. Geschichte*, &c.; Deecke, *Templum von Piacenza*. Mommsen in his history proposes a different view.







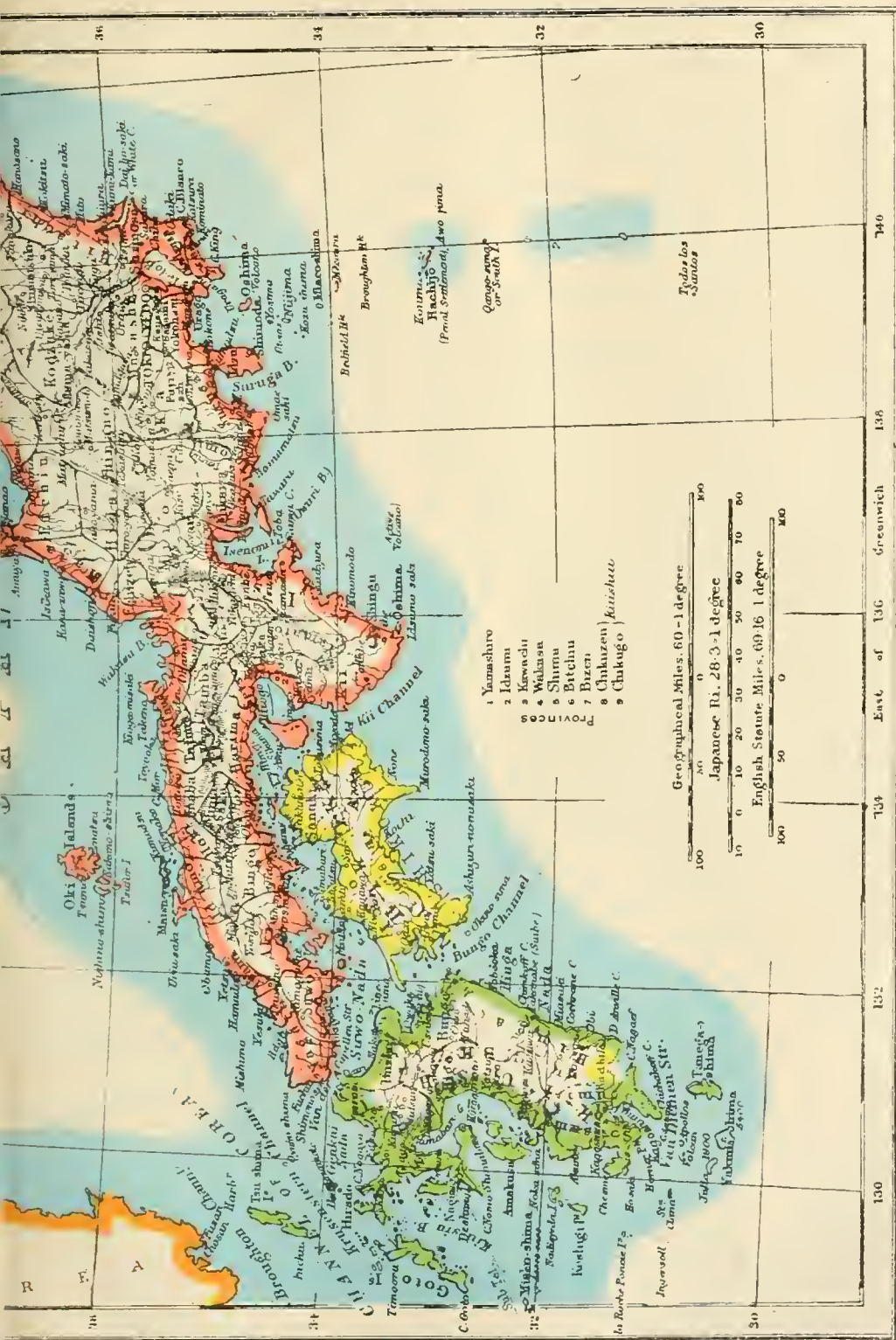

- 1 Yamashiro
- 2 Idzumi
- 3 Kawachi
- 4 Wakasa
- 5 Shirma
- 6 Bitchu
- 7 Bizen
- 8 Chikuzen
- 9 Chikugo

Geographical Miles - 1 degree  
 0 100

Japanese Ri. 28.3 = 1 degree  
 0 10 20 30 40 50 60 70 80 100

English Statute Miles - 69.16 = 1 degree  
 0 100

130 132 134 136 138 140

East of Greenwich

30 32 34 36





## JAPAN

Plate  
IX

THE empire of Japan consists of a long chain of islands separated from the eastern coast of Asia by the Seas of Japan and Okhotsk, and extending from 24° to 50° 40' N. lat., and from 124° to 156° 38' E. long. It commences with the Kurile Islands and descends in a south-westerly direction to the Loochoo group, to which the Japanese Government reasserted their claim in 1875. The southern portion of the island of Saghalien was ceded to Russia in exchange for the Kuriles. The whole empire is called by the natives *Dai Nippon*, or "Great Japan"; but *Nippon* or *Nihon* is often employed alone. *Nippon* means literally, "sun's origin," i.e., the land over which the sun first rises, and thus denotes the position the empire occupies in the extreme East. The principal islands may be enumerated as follows:—

1. The main island, which does not bear any special name in many of the older geographical works it is stated that *Nippon* is the distinctive appellation of this one island, but the Japanese themselves the name is applied only to the whole country.
2. *Kiushiu* (lit., "the nine provinces").
3. *Shikoku* (lit., "the four provinces").
4. *Yezo*.
5. *Sado*.
6. *Tsushima*.
7. *Hirado* (often wrongly written *Fivando*).
8. *Awaji*.
9. *Oshima* ("Vries Island") and the chain adjacent to it, terminating with *Haichijō* (misspelt on charts *Fatsisio*).
10. *Iki*, with several smaller isles.
11. The *Oki* group.
12. The *Gotō* group.
13. The *Bonin* group.
14. The *Riukiu* (Loochoo) group.
15. The *Kurile* group (*Chijima*; lit., "the thousand islands").

Owing to the lack of reliable surveys, it is exceedingly difficult to form a correct estimate of the area of the Japanese empire. A few years ago the Government instituted surveying operations under the direction of skilled foreign engineers, and an ordnance map of the city of Tōkiō has already been prepared and published; but any correct calculation of the size of the whole country can hardly be obtained for some years to come. In a work on general geography published a few years ago by the Education Department at Tōkiō, the area of Japan is stated to be 24,780 square *ri*, which measurement, taking the linear *ri* as equal to 2.45 English miles, gives a total of about 148,742 miles, or nearly one-fourth more than the area of the United Kingdom. This estimate, however, is founded on maps which are far from correct.<sup>1</sup>

The old division of Japan into provinces was made by the emperor Seimu (131-190 A.D.), in whose time the jurisdiction of the sovereign did not extend further north than to a boundary line running from the Bay of Sendai, on the east coast of the main island, to near the present treaty port of Niigata on the west coast. The northern

<sup>1</sup> Even in ordinary Japanese maps there are noticeable very glaring discrepancies as to distances, &c. The common measurement of length is the *ri*, equivalent, as has been said above, to about 2.45 miles. The *ri* usually contains 36 *chō*, though in the extreme western portion of the country 50 *chō* are sometimes reckoned to the *ri*. In hilly regions we often meet with what is termed the "mountain *ri*," which is one-half of the ordinary one. In former days, in stating distances along the roads, &c., the space occupied by temple enclosures was not reckoned, and thus the traveller had often to traverse a far longer route than that actually noted in the guide-books. The minor linear measures are the *sun*, or inch, 10 of which make the *shaku*, which is as nearly as possible equivalent to our foot; 6 *shaku*, or 71½ English inches, make up the Japanese *ken*, while the *jō* contains 10 *shaku*. See recent works on Japanese weights and measure, by Mr W. Bramsen.

portion beyond this line was then occupied by barbarous tribes, of whom the Ainos (still to be found in *Yezo*) are probably the remaining descendants. The whole country was then divided into thirty-two provinces. In the 3d century the empress Jingō, on her return from her victorious expedition against Corea, partitioned out the empire into five home provinces and seven circuits, in imitation of the Korean system. By the emperor Mommu (696-707) some of the provinces were subdivided so as to increase the whole number to sixty-six, and the boundaries then fixed by him were resurveyed in the reign of the emperor Shōmu (723-756). The old division is as follows:—

I. The *Go-kinai*, or "five home provinces," i.e., those lying immediately around Kōto, the capital, viz.:—

<i>Yamashiro</i> <sup>2</sup> also called <i>Jōshiu</i> .	<i>Idzumi</i> , also called <i>Senshiu</i> .
<i>Yamato</i> , " <i>Washiu</i> .	<i>Setsu</i> , " <i>Sesshiu</i> .
<i>Kawachi</i> , " <i>Kashiu</i> .	

II. The seven circuits, as follows:—

1. The *Tōkaidō*, or "eastern-sea circuit," which comprises fifteen provinces, viz.:—

<i>Iya</i>	<i>Ishiu</i> .	<i>Kai</i>	or <i>Kōshiu</i> .
<i>Isé</i>	" <i>Seishiu</i> .	<i>Sagami</i>	" <i>Sōshiu</i> .
<i>Shima</i>	" <i>Shishiu</i> .	<i>Musashi</i>	" <i>Brushiu</i> .
<i>Owari</i>	" <i>Bishiu</i> .	<i>Awa</i>	" <i>Dōshiu</i> .
<i>Mikawa</i>	" <i>Sanshiu</i> .	<i>Kadzusa</i>	" <i>Sōshiu</i> .
<i>Tōtōmi</i>	" <i>Enshiu</i> .	<i>Shimōsa</i>	" <i>Sōshiu</i> .
<i>Saruga</i>	" <i>Sunshiu</i> .	<i>Hitachi</i>	" <i>Jōshiu</i> .
<i>Idzū</i>	" <i>Dzushiu</i> .		

2. The *Tōzandō*, or "eastern-mountain circuit," which comprises eight provinces, viz.:—

<i>Ōmi</i>	or <i>Gōshiu</i> .	<i>Kōdzuné</i>	or <i>Jōshiu</i> .
<i>Mino</i>	" <i>Nōshiu</i> .	<i>Shimotsuké</i>	" <i>Yashiu</i> .
<i>Hida</i>	" <i>Hishiu</i> .	<i>Mutsu</i>	" <i>Ōshiu</i> .
<i>Shinano</i>	" <i>Shinshiu</i> .	<i>Dewa</i>	" <i>Ushiu</i> .

3. The *Hokurikudō*, or "northern-land circuit," which comprises seven provinces, viz.:—

<i>Wakasa</i>	or <i>Jakushiu</i> .	<i>Etchū</i>	or <i>Esshiu</i> .
<i>Echizen</i>	" <i>Eschiu</i> .	<i>Echigo</i>	" <i>Eschiu</i> .
<i>Kaga</i>	" <i>Kashiu</i> .	<i>Sado</i> (island)	" <i>Sashiu</i> .
<i>Noto</i>	" <i>Nōshiu</i> .		

4. The *Sanindō*, or "mountain-back circuit," which comprises eight provinces, viz.:—

<i>Tamba</i>	or <i>Tanshiu</i> .	<i>Hōki</i>	or <i>Hakushiu</i> .
<i>Tango</i>	" <i>Tanshiu</i> .	<i>Idzumo</i>	" <i>Unshiu</i> .
<i>Tajima</i>	" <i>Tanshiu</i> .	<i>Iwami</i>	" <i>Sekishiu</i> .
<i>Inaba</i>	" <i>Inshiu</i> .	<i>Ōki</i> (group of islands).	

5. The *Sanyūdō*, or "mountain-front circuit," which comprises eight provinces, viz.:—

<i>Harima</i>	or <i>Banshiu</i> .	<i>Bingo</i>	or <i>Bishiu</i> .
<i>Mimasaoka</i>	" <i>Sakushiu</i> .	<i>Aki</i>	" <i>Geishiu</i> .
<i>Bizen</i>	" <i>Bishiu</i> .	<i>Suwō</i>	" <i>Bōshiu</i> .
<i>Bitchū</i>	" <i>Bishiu</i> .	<i>Nagato</i>	" <i>Chōshiu</i> .

6. The *Nankaidō*, or "southern-sea circuit," which comprises six provinces, viz.:—

<i>Kii</i>	or <i>Kishiu</i> .	<i>Sonuki</i>	or <i>Fanshiu</i> .
<i>Awaji</i> (i-land)	" <i>Tanshiu</i> .	<i>Iyo</i>	" <i>Yoshiu</i> .
<i>Awa</i>	" <i>Ashiu</i> .	<i>Tosa</i>	" <i>Toshiu</i> .

7. The *Saikaidō*, or "western-sea circuit," which comprises nine provinces, viz.:—

<i>Chikuzen</i>	or <i>Chikushiu</i> .	<i>Higo</i>	or <i>Hishiu</i> .
<i>Chikugo</i>	" <i>Chikushiu</i> .	<i>Hiuga</i>	" <i>Nisshiu</i> .
<i>Izumi</i>	" <i>Hōshiu</i> .	<i>Osumi</i>	" <i>Gōshiu</i> .
<i>Bungo</i>	" <i>Hōshiu</i> .	<i>Satsuna</i>	" <i>Sasshiu</i> .
<i>Hizen</i>	" <i>Hishiu</i> .		

III. The two islands, viz.:—

1. *Tsushima* or *Taishiu*.
2. *Iki* " *Ishiu*.

Upon comparing the above list with a map of Japan it

<sup>2</sup> The names given in italics are those more commonly used. Those in the first column are generally of pure native derivation; those in the second column are composed of the Chinese word *shiu*, a "province," added to the Chinese pronunciation of one of the characters with which the native name is written. In a few cases both names are used.



will be seen that the main island contains the *Go-kinaï*, *Tôzandô*, *Hokurikudô*, *Sanindô*, *Sanyôdô*, and one province (Kishiu) of the *Nankaidô*. Omitting also the island of Awaji, the remaining provinces of the *Nankaidô* give the name *Shikoku* ("the four provinces") to the island in which they lie; while the *Saikaidô* coincides exactly with the large island of *Kiushiu* ("the nine provinces"). This name *Kiushiu* must not be confounded with that of the one province of *Kishiu* on the main island.

In 1868, when the rebellious nobles of Ôshiu and Déwa, in the *Tôzandô*, had submitted to the *mikado* (the emperor), those two provinces were subdivided, Déwa into Uzen and Ugo, and Ôshiu into Iwaki, Iwashiro, Rikuzen, Rikuchiu and Michinoku (sometimes also called Mutsu). This increased the old number of provinces from sixty-six to seventy-one. At the same time there was created a new circuit, called the *Hok'kaidô*, or "northern-sea circuit," which comprised the eleven provinces into which the large island of Yezo was then divided (viz., Oshima, Shiribéshi, Ishikari, Teshiwo, Kitami, Ifuri, Hitaka, Tokachi, Kushiro, and Nemûro) and the Kurile Islands (Chijima).

Another division of the old sixty-six provinces was made by taking as a central point the ancient barrier of Osaka on the frontier of Ômi and Yamashiro,—the region lying on the east, which consisted of thirty-three provinces, being called the *Kuantô*, or "east of the barrier," the remaining thirty-three provinces on the west being styled *Kuansai*, or "west of the barrier." At the present time, however, the term *Kuantô* is only applied to the eight provinces of Musashi, Sagami, Kôdzuké, Shimotsuké, Kadzusa, Shimôsa, Awa, and Hitachi,—all lying immediately to the east of the old barrier of Hakoné, in Sagami.

*Chiu-goku*, or "central provinces," is a name in common use for the *Sanindô* and *Sanyôdô* taken together. *Saikoku*, or "western provinces," is another name for *Kiushiu*, which in books again is frequently called *Chinsei*.

Each province (*kuni*) is divided into what may be termed departments (*kôri*). The latter vary in number according to the size of the province. In the old system there were altogether six hundred and twenty-nine departments, but the addition of the *Hok'kaidô* has raised the number to considerably over seven hundred.

For purposes of administration the whole of the empire except the *Hok'kaidô* was again divided in 1872 into three cities (*fu*) and seventy-two prefectures (*ken*). The three cities are Yedo, Ôzaka, and Kiôto. In 1869 Yedo also received the name of Tôkiô, or "eastern capital," as opposed to Saikiô (the new name for Kiôto), or "western capital." This was in consequence of the removal of the emperor's court from his old capital to Yedo. It may, however, be here remarked that, whilst the Japanese invariably speak of *Tôkiô Fu*, "the city of Tôkiô," they use the name *Kiôto Fu*, "the city of Kiôto," and not, as might have been supposed, *Saikiô Fu*. The limits of the prefectures (*ken*) were irrespective of the boundaries of the provinces. There were originally seventy-two, but a gradual process of amalgamation has considerably reduced the list; and in August 1876 a Government notification fixed the prefectures at only thirty-five, the names of which are given in the following table:—

The Home Provinces (14)—Sakai, Hiôgo (part)—apart from the two cities of Ôzaka and Kiôto.  
 Tôkaidô (8)—Ibaraki, Chiba, Saitama, Kanagawa, Yamanashi, Shidzuoka, Aichi, Miye—apart from the city of Tôkiô.  
 Tôzandô (11)—Awomori, Iwadé, Miyâgi, Fukushima, Akita, Yamagata, Tochigi, Gumma, Nagano, Gifu, Shiga.  
 Hokurikudô (2)—Niigata, Ishikawa.  
 Sanindô (1)—Shimane.  
 Sanyôdô (3)—Hiôgo (part), Okayama, Hiroshima, Yamaguchi.  
 Nankaidô (3)—Wakayama, Ehime, Kôchi.  
 Saikaidô (6)—Ôda, Fukuoka, Kumamoto, Nagasaki, Kagoshima.

From the above list it may be noted that in many instances a single *ken* now contains several provinces or portions of different provinces. In 1878-9 a separate prefecture (called the Okinawa *ken*) was created, including the Riukiu (Loochoo) group. Until that time Riukiu was governed by a king of its own, but being in fear of its powerful neighbours, China and Japan, it had for many years sent tribute to both. A question of double allegiance thus arose, which was solved by Japan asserting its sovereignty; the king received the title of noble of Japan, and the Okinawa *ken* was established. Whether this action on the part of the Japanese Government may not embroil them with China is a point not yet definitely settled.

The total number of islands in the Japanese group, smaller exclusive of the four main ones, is stated to be over three thousand. Many of these are mere barren rocks, uninhabited and uncultivated. Others, again, are of considerable size and exceedingly fertile, particularly the countless islets in the *Suwo Nada*, commonly known to Europeans under the name of the "Inland Sea," lying between the main island on the north and the islands of Shikoku and Kiushiu on the south. The whole coast-line, too, is dotted with islands and rocks of all sizes. Ôshima, also called Vries Island, at the mouth of the Bay of Yedo, is one of considerable importance. It has many inhabitants, and its volcanic soil is fairly productive. It is the most northerly of a chain which extends as far south as the 27th degree of north latitude. The Bonin group, termed by the Japanese the Ogasawara Islands, lies far out at sea, to the south of the entrance of Yedo Bay; it consists of two large islands, separated from each other by 50 miles of sea, and a host of islets. The Japanese Government reasserted their sovereignty over the Bonins in 1878. The Kurile Islands are merely a chain of barren rocks, and the few inhabitants are chiefly occupied in the fisheries and in hunting the sea-otter. Due south from the province of Satsuma lie several minor groups, terminating with the Riukiu Islands. The Gotô group (lit. "the five islands") extends in a westerly direction from the province of Hizen, in Kiushiu, to which it belongs.

*Coast-line*.—The bays along the coast are often of considerable size. The Japanese, strange to say, have no names for either their bays or their straits, the appellations found on maps and charts having been given by European navigators. Yedo Bay is perhaps the best known to foreigners, but Sendai Bay (on the east coast) and that running up to the north of the island of Awaji, and commonly called Ôzaka Bay, are also famous. Owari Bay, in the province of that name, is of considerable size. The Bay of Kagoshima, in the province of Satsuma, is long and narrow; it is well known to foreigners as having been the scene in 1863 of an attack on Kagoshima (the castle-town of the lord of Satsuma) by a British squadron. The entire coast-line teems with smaller bays and harbours, in many of which good anchorage can be found. An English man-of-war, the "Sylvia," has for several years been employed as a surveying vessel to obtain soundings of the principal inlets and draw up charts of the coast.

The straits best known to foreigners are the Straits of Tsugaru (often miscalled Saugur in maps), which separate Yezo from the northern portion of the main island; the Straits of Akashi and of Idzumi, near the island of Awaji, at the eastern entrance of the "Inland Sea"; and the Straits of Shimonoséki, at the extreme western end of that sea, separating the main island from Kiushiu. The attack on Shimonoséki in 1864 by an allied squadron of English, French, Dutch, and American vessels, in retaliation for injuries inflicted upon foreign shipping passing

through the straits by the batteries erected by the lord of Chôshiu (in which province Shimonoséki is situated) is a matter of historical note. The current in these straits is so swift that vessels have difficulty in stemming it unless under steam.

Capes.

It will suffice to name a few of the almost countless promontories and capes along the coast. On the extreme north of the main island we have Riubi-zaki and Fujishi-zaki in the Tsugaru Straits. Inuboyé no saki lies on the east coast just below the mouth of the Tonégawa. Su-saki in Awa and Miura no misaki (called by foreigners Cape Sagami) mark the entrance to the Bay of Yedo. Cape Idzu is in the province of that name, and at the southern extremity of the province of Kishiu are Idzumo-zaki and Shiwo no misaki. Muroto-zaki and Ashizuri no misaki are the chief promontories on the south coast of the island of Shikoku, both being situated in the province of Tosa. Tsutsui-zaki in Hiuga, and Sata no misaki (better known to Europeans as Cape Chichakoff) in Ôsumi are the extreme southern points of the island of Kiushiu. In the island of Yezo there are several noticeable promontories.

Harbours.

The number of harbours and trading-ports called by the natives *ô-minato* ("large harbours") is stated to be fifty-six, but many of these would no doubt be inaccessible to foreign vessels of heavy tonnage. They are, however, admirably adapted for the accommodation of coasting junks and fishing craft, and these vessels have no lack of places of refuge in heavy weather. In many instances the entrances are blocked by one or more small islands or rocks, which render the anchorage within even more secure. In Yezo the port of Matsumae is the one best known. The Bay of Yedo abounds with harbours, some being situated within the mouths of the rivers. In Idzu, Shimoda is one that deserves special mention; the water is there very deep, and it is a common occurrence for vessels beating up towards the entrance of Yedo Bay to seek shelter in it. Shinidzu in Suruga is also a well-known place; a long sandy promontory covered with fir trees defends the port from the sea on the south. In the province of Shima are Toba and Matoya, both magnificent harbours. The "Inland Sea" is, of course, especially rich in this respect, the harbour of Mitarai, between two islands near the province of Aki, being a favourite place of call. In Shikoku, Takamatsu in Sanuki is the best known. Kiushiu is abundantly supplied, Kagoshima in Satsuma being one of the largest and best. The harbours on the north-west coast of the main island are also numerous, and each of the islands Tsushima, Iki, and Sado possesses one. The ports thrown open to foreign trade since the year 1859 are Yokohama, Hiôgo (Kôbê), and Niigata on the main island, Nagasaki in Kiushiu, and Hakodaté in Yezo.

Mountains.

*Mountains.*—Japan, as might reasonably be expected in a country where volcanoes are so numerous, is very hilly; and in some districts there are many mountains of considerable height. The most extensive plains are those of the Kuantô and Echigo, and the north of Ôshiu. The provinces of Mikawa, Mino, and Owari are also very flat. Half-way between Tôkiô (Yedo) and Kiôto lies the great watershed of the east of Japan, the table-land of Shinano, elevated some 2500 feet above the level of the sea. The ridges around or forming part of it are very lofty, particularly those of the province of Hida. The plain of Yedo lies to the east of this table-land, about 1800 feet below, while to the north the hills gradually slope away to the province of Echigo. Another range of considerable height runs due north from Aidzu to Tsugaru, thus dividing the old provinces of Ôshiu and Déwa. The province of Kai is almost entirely surrounded by mountains, and the hill scenery in Kishiu and near Kiôto is exceedingly fine. Shikoku

possesses some large ridges, and the south of Kiushiu, especially in the provinces of Higo and Hiuga, is also by no means deficient. Even in the wide rice-plains throughout the country there may often be seen minor elevations or hills, rising abruptly, in some cases to a considerable height. The mountain best known to foreigners is Fuji-san,—commonly, but most erroneously, termed Fusi-yama or Fusi-no-yama in geographical works. It rises more than 12,000 feet above high-water level, and is in shape like a cone; the crater is 500 feet deep. It stands on the boundary line of the three provinces of Kai, Suruga, and Sagami, and is visible at a considerable distance seaward. It is regarded by the natives as a sacred mountain, and large numbers of pilgrims make the ascent to the summit at the commencement of summer. The apex is shaped somewhat like an eight-petaled lotus flower, and offers from three to five peaks to the view from different directions; it is visible from no less than thirteen different provinces. Though now apparently extinct, it was in former times an active volcano, and Japanese histories mention several very disastrous eruptions. The last of these occurred in 1707, when the whole summit burst forth into flames, the rocks were shattered and split by the heat, and ashes fell even in Yedo (about 60 miles distant in a direct line) to a depth of several inches.<sup>1</sup> After Fuji-san may be mentioned Gassan in the province of Uzen, Mitaké in Shinano, the Nikkô range in Shimotsuké, Ôminé in Yamato, Hakusan in Kaga, Tatéyama in Etchui, Kirishima-yama in Hiuga, Asosan in Higo, Tsukubasan in Hitachi, Onsen-ga-také in Hizen, Asama-yama in Shinano, Chôkaizan in Ugo, and Iwaki in Michinoku. There are several active volcanoes in the country, that best known to foreigners being Asama-yama. This mountain is 8500 feet in height. The earliest eruption of which records now exist seems to have taken place in 1650; after that the volcano was only feebly active for one hundred and thirty-three years, when there occurred a very severe eruption in 1783. Even so lately as 1870 there was a considerable emission of volcanic matter, at which time, also, violent shocks of earthquake were felt at the treaty port of Yokohama. The crater is very deep, with irregular rocky walls of a sulphury character, from apertures in which sulphurous fumes are constantly sent forth. At present very little is known in regard to the heights of the mountains, but the subject is one that has attracted the attention of foreign residents in Japan for several years past. The following is an approximate estimate:—

<sup>1</sup> According to Japanese tradition, it was upheaved in a single night from the bottom of the sea, about twenty-one and a half centuries ago, and its history has been carefully recorded. From July to September the wants of the pilgrims are supplied by temporary restaurants distributed along the principal routes of ascent, one of which is from the east by Subashiri, another from the north by Yoshida, and a third from the south by Murayama. The white vestments usually worn by the pilgrims are stamped by the priests at the top with various seals and images. Sir Rutherford Alcock and a party of Englishmen ascended the mountain in 1860, and since then it has frequently been visited by Europeans. The height as then estimated by Lieutenant Robinson was 14,177 feet; but a mean of several subsequent measurements gives only 12,200. In the great crater there are neither sulphuric exhalations nor steam. According to Dr von Drasche this is a circular bowl about 700 or 800 feet deep. The lavas are mainly dolomitic; those forming the walls of the crater are composed of anamesite, in which here and there grains of felspar are visible. The Japanese poets never weary in celebrating the praises of Fuji-san, and its conical form is one of the most familiar objects in Japanese painting and decorative art. See the notice of Sir R. Alcock's ascent in *Journal R. G. Soc.*, 1861; of A. Jeffrey's ascent in August 1872, in *Proc. of R. Soc.*, 1873; and of Dr von Drasche's in his "Bemerkungen über die japanischen Vulkanen Asa-yama . . . und Fusi-yama," in *Jahrbuch K. K. Geol. Reichsanstalt*, 1877; also J. Rein's "Der Fuji-no-yama und seine Besteigung," in *Petermann's Mittheilungen*, 1879.



1. Fuji-san	12,365 feet (above high-water mark at the town of Numadzun)."
2. Asama-yama	8,500 ..
3. Nantai-zan (the loftiest hill in the Nikkô range)	7,800 ..
4. Ôyama, in Sagami	5,400 ..
5. Tsukuba-san	5,000 ..
6. Onsen-ga-také	4,100 .. (according to Siebold).

## Rivers.

*Rivers.*—The rivers of Japan, although very numerous, are in no case of any great length. This of course is easily explained by the fact that the islands are narrow and hilly. The longest and widest river is the Tonégawa, which rises in the province of Kôdzuké, and flows due east to the Pacific, throwing off, however, at Sékiyado in Shimôsa, a branch that flows into Yedo Bay near the capital.<sup>1</sup> The length of the Tonégawa is over 170 miles. At Sékiyado (which is a large and thriving river-port) the water is no less than 40 feet in depth, while a few hundred yards above that town foot-passengers can ford the stream without any great difficulty. The Shinanogawa and Kiso-gawa, both of which take their rise in the province of Shinano, rank next to the Tonégawa. The former flows first in a north-westerly direction, next due north, and then north-east through Echigo to the sea at Niigata; the Kiso-gawa flows to the westward and then to the south, between the provinces of Mino and Owari, and finally falls into the sea at Kuwana. The Ôi-gawa rises in the south-west of Kni, and traverses the province of Tôtômi; it is less remarkable for the length of its course than for the great breadth of its bed, which near the mouth is 2½ miles across, its current being also very swift. The Fuji-kawa, flowing due south from the mountains of Kni through the province of Suruga, is famous as being one of the swiftest streams in all Japan. In the north, the Sakata-gawa flows due west from the range of mountains separating the provinces of Uzen and Rikuzen, and enters the Sea of Japan at the town of Sakata, from which it takes its name. Nearly all the rivers are fed by countless tributary streams, which in many cases form a complete network in the lower portions of the country, and thus greatly facilitate transport from the interior to the coast. On the Tonégawa and a few other streams of greater depth small river steamers ply for several miles; but in general large flat-bottomed boats, drawing as a rule but a few inches of water, are employed. It is by no means uncommon to see boats of this description in process of construction even in remote country villages on the banks of streams in which the depth of water is but from 12 to 18 inches at ordinary times. Floods are of frequent occurrence, especially at the commencement of summer, when the melting of the snows on the mountain ranges causes at times an almost incredible downflow from the higher lands to the plains. These floods invariably occasion great destruction of property, as the bridges spanning the rivers are only built of wood and turf, supported by piles. In some localities, notably in the western portion of the province of Shimôsa, traversed by the southern branch of the Tonégawa, large tracts of rice-land are almost entirely destroyed by the fine sand from the bed of the river, swept over the fields during inundations. In addition to boats, long rafts of timber are constantly to be seen descending the larger rivers; the logs are floated down in a rough state, to be afterwards thinned and sawn up at the seaport towns where the timber trade is carried on.

*Lakes.*—Japan contains a large number of lakes, but only one—the Biwa Lake, in the province of Ômi—is worthy of special notice on account of its size. Its length is about 50 miles, and its greatest breadth about 20 miles. At

<sup>1</sup> See Naumann's excellent paper, "Ueber die Ebene von Yedo," in Petermann's *Mittheilungen*, 1879

a village called Katada, some 10 miles from its southern extremity, it suddenly contracts to a breadth of only a mile and a half, after which it again slightly expands. This lake derives its name from a fancied resemblance to the *biwa* or Japanese lute; the scenery around it is particularly beautiful, and it is a favourite resort for sightseers from Kiôto. An ancient Japanese legend asserts that in the year 286 B.C., in the reign of the emperor Kôrei, there occurred a terrible earthquake, when the earth opened and Lake Biwa was formed; at the same time rose the mountain called Fuji-san. In Ômi there is a small hill called Migami, which in shape slightly resembles Fuji-san, and this fact is quoted by the natives in support of the theory connecting the lake with the sacred mountain; and the inhabitants of Ômi were privileged to undertake the ascent of Fuji-san after only seven days' purification, instead of one hundred days', the prescribed term for all other persons. After Biwa may be noted the lakes of Chiuzenji, Suwa, and Hakoné, all of which lie far above the level of the sea. That of Chiuzenji is situated at the foot of the mountain called Nantai-zan, in the Nikkô range in the province of Shimotsuké. The scenery in its vicinity has given rise to the proverb that he who has not seen Nikkô should not pronounce the word "beautiful." The lake of Suwa is in the province of Shinano, and can be reached by a road called the Nakasendô, running north-west from Tôkiô through the heart of the country to Kiôto. The Hakoné Lake lies in the range of hills bearing the same name just to the east of Fuji-san; the water is exceedingly cold, and of great depth. A Japanese legend, indeed, asserts that it has never been fathomed. The hill scenery around it is very picturesque, and large numbers of foreign residents from Tôkiô and the neighbouring port of Yokohama visit it during the summer months. The Inawashiro Lake, in the province of Iwashiro, is said to be about 10 miles in length. It is fed by two streams flowing from the east and north-east, while out of it flows the Aka-no-gawa, which falls into the sea near Niigata. It is surrounded by hills of no great elevation; the temperature there is cool, and in winter the streams are frozen for several weeks. On the boundary line of the provinces of Hitachi and Shimôsa there are also large tracts of water, or lagoons (Japanese *numa*), fed by the Tonégawa; these, though not actually lakes, may almost be classed under that heading, as their connexion with the river itself consists in many cases of but one narrow outlet. Those of chief note are the Ushiku-numa in Hitachi, and the Imba-numa, Téga-numa, and Naga-numa in Shimôsa. The country in this vicinity is as a rule exceedingly flat, but the Imba-numa is for some distance along its eastern shore bordered by small hills, thickly wooded down to the water's edge, the whole forming a very pretty landscape. The lagoons are well stocked with fish, the large eels found in the Ushiku-numa being especially prized for excellence of flavour; in the winter months they teem with wild fowl. The inhabitants of the numerous villages along the shores are, in fact, almost entirely maintained by fishing and shooting or trapping.

*Minerals.*—Japan is particularly rich in minerals, Mineral among which may be specially mentioned gold, silver, iron, copper, coal, and stone of various kinds. The gold was first discovered and melted in the year 749 A.D., during the reign of the emperor Shômu; it came from the department of Oda in the province of Ôshiu, and in the following year more was found in the province of Suruga. During the long period of Japan's seclusion from the rest of the world, the gold discovered remained in the country, and the amount augmented year by year; and this no doubt tended in a great degree to convey to the earlier foreign visitors the

impression that the supply was far more abundant than was actually the fact. The quantity of bullion exported by the Portuguese during their stay in Japan (1550-1639) may be estimated at the least at fifty-nine and a half millions sterling, or an average of £660,000 yearly. Dr Kaempfer even speaks of some years with an export of two and a half millions of gold. From 1649 to 1671 the Dutch also exported large quantities, together with silver and copper, and the total value of gold and silver alone sent out of Japan during the 16th and 17th centuries may be estimated at nearly one hundred and three millions sterling. At an exhibition held in Kiôto in 1875 were shown about twenty samples of gold ore found in different provinces. The ore is generally poor, and many gold-yielding places are now lying unworked, because the increased cost of labour renders it very difficult to work them with profit. Pure auriferous quartz has been found in the provinces of Satsuma and Kai, gravel in Ôsumi, and quartz in Rikuchiu and at the mine of Aikawa in the island of Sado. The mode in which the Japanese work the gold ores nearly resembles Western methods. They understand perfectly the separation of even the smallest quantities of gold dust from stones and gravel by means of a system of washing and levigation. They do not, however, possess any good process for the separation of gold from silver, and hence all Japanese gold contains a greater or less proportion of the latter metal. Silver ore was discovered accidentally in the year 667 A.D., in the island of Tsushima; this ore produced the first Japanese silver metal, in the year 671. From 1400 to 1600 it was obtained and melted in Japan in far larger quantities than at the present time. It generally occurs in comparatively small quantities as an admixture in several copper and lead ores. The principal mines are in the provinces of Jôshiu, Iwami, and Setsu; but it is also found mixed with lead in Hida, Iwashiro, Echizeo, Echigo, Rikuchiu, Suwô, Hinga, and Higo. Of the numerous iron ores to be found, the principal is magnetic iron ore, which forms the main basis of the Japanese iron industry. Leadstone was discovered in the year 713 in the province of Ômi. The exact date of the first manufacture of iron is unknown; it is certain only that the Japanese have worked their iron ores from the 10th century onward. The principal seats of the industry are in the provinces of Idzumo, Bingo, Ôshiu, Hinga, Tajima, Wakasa, Bizen, Bitchiu, Shinano, Tôtômi, Kai, Suruga, and Satsuma. The best steel is manufactured in Harima, Hôki, Idzumo, and Iwami. The excellent temper of the Japanese sword-blades is well known. The most noted smiths formerly resided in the provinces of Sagami, Bizen, and Kishiu, and in the neighbourhood of Kiôto. Japanese legends assert that the first sword was forged in the reign of the emperor Sûjû (97-30 B.C.), but this statement is of course open to considerable doubt. Copper was, it is said, smelted in Japan for the first time in the year 698 at Inaba in the province of Suwô; and in the year 708 the first Japanese copper coin was cast, in the province of Musashi. Since the 10th century enormous quantities of ore have been smelted, and this metal formed the chief trade of the Dutch and Chinese at Nagasaki from 1609 to 1858,—the amount exported by the former being more than four millions of piculs and by the latter undoubtedly still more.<sup>1</sup> It is perhaps the metal most commonly found in Japan, and is used for all kinds of household goods, doors to storehouses, ornaments, temple-furniture, mirrors, bronzes, smoking utensils, and current coinage. It is found and smelted in all parts of the country, particularly in the northern and western

provinces, and its export figures considerably in the trade returns of the treaty ports during the past few years. As a rule Japanese copper is exceedingly free from the presence of injurious metals. After the year 1600 many bronze guns were cast in Japan, the workmanship being exceedingly good; these old guns are often to be seen even now, though by far the larger number, together with the temple bells, &c., made from the same material, have been broken up and exported as old bronze by European merchants. Of other metals Japan also produces lead, quicksilver, and tin. Coal is found in large quantities, particularly in Kiushiu, where the province of Hizen contains the well-known mines of Karatsu, and in the island of Takashima, near the treaty port of Nagasaki. Coal-fields also exist in the large northern island of Yezo. Nearly all the steamers plying between Japan and China coal at Nagasaki, where this trade attracts a good deal of enterprise. The numerous quarries throughout the empire afford large quantities of stone. Marble and granite are found principally in the provinces of Shinano, Mino, and Kôdzuké; freestone is also procured from Setsu and Idzu. The huge blocks of which the ramparts of the castle at the capital are built were originally brought from the latter province. In the old castle of Ôzaka, in Setsu, there is an enormous piece of granite measuring thirteen paces in length and about 9 feet in height. The foundations of all the more ancient temples throughout the country are formed of large blocks, and these, together with the long flights of steps, still remain to prove the durability of the old style of architecture. It is strange, however, that at the present moment stone is but sparingly used for building purposes; even in the great cities the dwelling-houses are almost entirely constructed of timber, stone being used only for bridges and for edifices on a larger scale than ordinary.<sup>2</sup>

*Climate.*—The climate of Japan, as might naturally be expected in view of the great length of the chain of islands, varies to a considerable extent in different localities.<sup>3</sup> Thus we find that while the Riukiu and Bonin groups, lying close to the tropics, enjoy perpetual summer, the Kurile Islands in the far north of the empire share the arctic temperature of Kamtschatka. The climate is, on the whole, favourable for Europeans, although its frequent changes often prove trying to foreign residents. All the mountain ranges are wrapped deep in snow throughout the winter months; indeed, from many peaks snow never entirely disappears. In the northern provinces it has been known to fall to a depth of no less than 8 feet, and the province of Echigo is specially noted in this respect. At the treaty port of Niigata, in that province, small bamboo sheds are built out from the fronts of the dwelling-houses so as to form a covered way along which pedestrians can pass when the rest of the town is snowed up. At Tôkiô snow falls some three or four times during the winter; it covers the ground to a depth of from 3 to 5 inches on an average, but does not lie long. In January 1876, however, a remarkably severe snowstorm occurred, when the whole city was covered to a depth of 2 feet or more; so unusual was this phenomenon deemed that a large number of photographs of the landscape were taken to perpetuate the memory of the event. Farther to the south and west the

<sup>1</sup> See a paper on "Mining and Mines in Japan," in the *Memoirs of the Tôkiô University*, and A. J. C. Geerts, *Les produits de la nature japonaise et chinoise* (Yokohama, 1878). For the geology, see B. S. Lyman's *Geological Survey of Japan, Reports of Progress for 1878-79* (Tokio, 1879).

<sup>2</sup> See Dr J. J. Rein's papers in Petermann's *Mittheil.*, 1875 and 1879; A. Wejckof's "Reisen in Japan in 1876," in the *Mittheil.*, 1878, and his "Zum China von Japan," in the *Zeitschr. d. Oesterr. Ges. f. Meteor.*, 1878; and T. H. Tizard's *Contributions to the Meteorology of Japan* (London, 1876).

<sup>1</sup> 1 picul = 133½ lb. avoirdupois.



cold is not, as a rule, so intense, while in the summer months the heat is far greater. Near Yokohama and Tôkiô the summer commences in May, but the heat only becomes oppressive in July and August, when the thermometer has been known to register 104° F. At the break-up of the summer there are heavy rains, which render the interior of the houses exceedingly damp and uncomfortable. After the winter there also occurs a short rainy season. The best months for making excursions into the interior are April and October, as the weather is then generally of a mean temperature. Southerly winds blow from the middle of May, and often even from April, until the end of August. On the Sea of Japan south-west winds (known as the south-west monsoon) prevail, while in Yokohama and all parts of the country adjacent to the Pacific Ocean southerly winds predominate. The south-west monsoon sets in in April and prevails until the middle or end of September; but the regularity with which the monsoons set in and blow on the Chinese coasts is unknown in Japan. On calm days land and sea breezes alternate on the Japanese coast in the same manner as elsewhere. Mention should here be made of the violent revolving storms, known as typhoons, which are closely related to the West Indian hurricanes and to the cyclones of the Indian seas. These generally occur in the months of July, August, or September; they invariably occasion great damage, not only to shipping, but also to property on land. Large trees are often snapped asunder like mere twigs, while the roofs and chimneys of foreign-built edifices suffer severely. As a rule, one of these storms is experienced every year.

Earth-  
quakes

Destructive earthquakes have often taken place, while slight shocks are of frequent occurrence, several having been felt lately within the space of a few days. Japanese histories furnish numerous records of these phenomena. The ancient legend of the great earthquake in 286 B.C., when Mount Fuji rose and the Biwa Lake was formed, has already been noticed; but it is not possible to procure reliable information for several centuries later than the date mentioned in that fanciful tale. The earliest authentic instance is perhaps that which is said to have occurred in 416 A.D.; when the imperial palace at Kiôto was thrown to the ground. Again, in 599, the buildings throughout the province of Yamato were all destroyed, and special prayers were ordered to be offered up to the deity of earthquakes. In 679 a tremendous shock caused many fissures or chasms to open in the provinces of Chikuzen and Chikugo, in Kinshiu; the largest of these fissures was over 4 miles in length and about 20 feet in width. In 829 the northern province of Déwa was visited in similar manner: the castle of Akita was overthrown, deep rifts were formed in the ground in every direction, and the Akita river was dried up. To descend to more recent instances, in 1702 the lofty walls of the outside and inside moats of the castle of Yedo were destroyed, tidal waves broke along the coast in the vicinity, and the road leading through the famous pass of Hakoné (in the hills to the east of Fuji-san) was closed up by the alteration in the surface of the earth. Of late years these disastrous earthquakes have fortunately been of more rare occurrence, and the last really severe shocks were those felt in 1854 and 1855. In the former year the provinces of Suruga, Mikawa, Tôtômi, Isé, Iga, Setzu, and Harima, and also the large island of Shikoku, were severely shaken. It was this earthquake which destroyed the town of Shimoda, in the province of Idzu, which had been opened as a foreign port in Japan, while a Russian frigate, the "Diana," lying in the harbour at the time was so severely damaged by the waves caused by the shock that she had to be abandoned. The earthquake of 1855 was felt most severely at Yedo, though its destructive power extended for some distance to the west,

along the line of the Tôkaidô. It is stated that on this occasion there were in all 14,241 dwelling-houses and 1649 fire-proof storehouses overturned in the city, and a destructive fire which raged at the same time further increased the loss of life and property.

Meteorological observations have for some time back been carefully taken at the college in Tôkiô, and efforts are now (1881) being made to start a seismological society in the capital. Japan is peculiarly a country where a learned society of this nature could gather most interesting and useful information from actual observation.

*General Aspect of the Country.*—The physical structure of the islands alternates between mountain ranges, rugged upland regions, wide plains, and lands consisting of an endless succession of dale and down, level fields and small ridges. Yezo has not yet become thoroughly known to foreigners; but it possesses both hills and plains, the latter being in some cases very sandy. The northern portion of the main island of Japan is exceedingly mountainous, though large moors and uncultivated stuppes are to be observed on all sides. To the south-east lies the wide plain of Yedo, remarkably fertile, and closed in by lofty ranges. From this away to the west the country is hilly in the centre, with lower ground to the north and south; while in the large islands of Kiusiu and Shikoku the high ground is far in excess of the plain.

*Vegetable Products.*—The greater part of the cultivated Rice land consists of rice-fields, commonly termed "paddy-fields." These are to be seen in every valley or even dell where farming is practicable; they are divided off into plots of square, oblong, or triangular shape by small grass-grown ridges a few inches in height, and on an average a foot in breadth,—the rice being planted in the soft mud thus enclosed. Narrow pathways intersect these rice-valleys at intervals, and rivulets (generally flowing between low banks covered with clumps of bamboo) feed the ditches cut for purposes of irrigation. The fields are generally kept under water to a depth of a few inches while the crops are young, but are drained immediately before harvesting. They are then dug up, and again flooded before the second crop is planted out. The rising grounds which skirt the rice-land are tilled by the hoe, and produce Indian corn, millet, and edible roots of all kinds. The well-wooded slopes supply the peasants with timber and firewood. The rice-fields yield two crops yearly. The seed is sown in small beds, and the seedlings are planted out in the fields after attaining the height of about 4 inches. The finest rice is produced in the fertile plains watered by the Tonégawa in the province of Shimôsa, but the grain of Kaga and of the two central provinces of Setzu and Harima is also very good. Prior to the revolution of 1868-9 the fiefs of the various *daimiô* or territorial nobles were assessed at the estimated total yield of rice. Until very recently there existed a Government prohibition against the export of the grain. Rice not only forms the chief food of the natives, but the national beverage, called *Saké*. *saké*, is brewed from it. In colour the best *saké* resembles very pale sherry; the taste is rather acid. None but the very best grain is used in its manufacture, and the principal breweries are at Itami, Nada, and Hiôgo, all in the province of Setzu. Of *saké* there are many varieties, from the best quality down to *shiro-zaké*, or "white *saké*," and the turbid sort, drunk only in the poorer districts, known as *nigori-zaké*; there is also a sweet sort, called *mirin*.

The whole country is clothed with most luxuriant vegetation, except in some of the very hilly regions. The principal forests consist of *Cryptomeria* (Japanese cedar) and pine; the ilex, maple, mulberry, and giant camellia also abound. Some of the timber is remarkably fine, and the long avenues following the line of the different high roads

afford a most grateful shade in summer. On the road from Tôkiô to the celebrated temples at the foot of the Nikkô hills is an avenue nearly 50 miles in length, of cedars and pines, some of the trees being fully 50 or 60 feet in height. Unfortunately these noble specimens are fast disappearing, as the wood-cutter's axe and saw have been ruthlessly plied during the past few years. In Japanese wood-felling a common plan is to kindle a fire at the roots of the tree; this dries up the sap in the trunk, and renders the wood harder and firmer. Two principal varieties of the pine occur, called respectively the red and the black, from the colour of the bark. The former thrives in sandy ground, while the latter grows in softer black soil. It is said that, if one of these varieties be transplanted to the soil bearing the other, it will also in time change in colour till it resembles its new companions. The tints of the maple foliage, bright green in summer and brown-red in autumn, contribute in no slight degree to the beauty of a Japanese landscape. The mulberry tree grows well in the eastern regions, where the silkworm is reared and the silk industry carried on. The bamboo is especially useful and plentiful. Bamboo clumps are seen at frequent intervals in the rice-land; they line the river banks, and flourish equally well on the higher grounds; and it would be impossible to enumerate the multifarious purposes for which the cane is used. Of fruit-trees Japan possesses the orange, apple, walnut, chestnut, plum, persimmon, damson, peach, and vine. The fruit, however, is in most cases of quality far below that of European orchards. The best oranges come from the province of Kishiu; these have a smooth and very thin rind, and no seeds. The larger oranges, with thick and rough rinds grow throughout the country. The so-called apple resembles the large russet, but only in colour and shape; it has absolutely no flavour, and is hard and stringy. The plum, of which there are several varieties, may be said to be the best fruit obtained, next to the orange and persimmon. This latter is exceedingly plentiful and has two varieties, the soft and the hard; it is, often dried, and sold packed in boxes like figs. The peaches are not remarkable either for size or flavour. The best grapes are grown in the provinces of Kai and Kawachi; both the black and the white are found, but the fruit is small, and only continues in season for a short time. The tea-plant grows well in Japan, and tea forms one of the chief exports to foreign countries. The best leaf comes from the neighbourhood of Uji, in the province of Yamashiro, to the south-east of Kiôto; but it is also largely exported from Yokohama, being produced in the fertile district in the east of the main island. The production of vegetable wax has always formed one of the principal industries of the island of Kinsiu, and the trees bearing the wax berries grow in great number on the hill slopes and round the edges of most of the cultivated fields (excepting rice-land) in the provinces of Hizen, Higo, Chikuzen, and Chikugo; in Satsuma, however, they are not so plentiful. The cotton-plant, introduced from India in 799, also thrives. The camphor tree is found in most parts of the country, particularly in some of the higher regions; on account of its agreeable smell the wood is largely used in the manufacture of small cabinets and boxes. Amongst the minor vegetable products the sweet potato is particularly plentiful; it has several varieties, that known as the Satsuma potato being perhaps the best. Water melons and gourds of various sizes and shapes thrive in the more sandy soil; and onions, carrots, small turnips, tomatoes, and beet-root are also cultivated. The brinjal bears a dark purple fruit shaped like a pear. The long white radish, called by the Japanese *daikon* (lit. "great root"), is exceedingly common, and forms one of the chief articles of food amongst the

lower classes, who eat it either raw or dried and pickled; the average size of the root is from 18 inches to 2½ feet in length, and 1½ inches or so in diameter. Beans and peas can also be grown. The climate of Yezo is said to be very favourable for both wheat and barley, and it is probable that in future years this large island may thus prove a source of considerable gain to the Japanese. In the island of Shikoku the indigo plant is found in abundance, and it also occurs in the eastern portion of the main island. The poppy is grown in Shikoku. In ferns and creepers of various kinds Japan is particularly rich, but her list of flowers is not very lengthy. The rose, peony, azalea, camellia, lotus, and iris are, however, to be seen.<sup>1</sup>

*Animals.*—As regards animal life Japan is well provided. Mammals. The domestic animals comprise the horse, ox, dog, and cat; while the wilder tribes are represented by the bear, deer, antelope, boar, fox, monkey, and badger. In Yezo are found very large bears, so powerful as to be able to pull down a pony; in the central provinces of Shimotsuké and Shioaoo a small black species exists. The deer, antelope, and monkey are caught in nearly all the hilly regions throughout the whole country. Sheep do not thrive, although the hardier goat does,—the reason assigned for this being that the "bamboo grass," with its sharp-edged and serrated blade, proves very deleterious as pasture. In the western part of the province of Shimôsa a sheep-farm was started a few years ago; but it is not yet possible to judge whether the venture will prove successful in any great degree. In the meantime sheep are usually imported from China. The Japanese horses, or rather ponies, are not very powerful animals; they stand on an average from 13 hands 2 inches to 14 hands 2 inches in height. They are thick-necked and rather high-shouldered, but fall off in the hind quarters. Large numbers of ponies are imported from China. At the Shimôsa farm experiments have been made in putting an Arab or Barb to a Japanese mare; the half bred animal thus obtained compares very favourably with the pure native breed, being of better shape and of far superior speed. The oxen are small but sturdy, and it is probable that, if the vast tracts of moorland at present lying uncultivated in the northern provinces were utilized for breeding cattle, substantial gains would be secured. The ordinary Japanese dog is very like the Eskimo dog, and is generally white, grey, or black in colour. A few, however, are red-brown, and much resemble the fox; these are used by the hunters in the pursuit of game. There are several species of monkeys, and large numbers of these animals, taken in the hills of Kai and Shinano, are brought into the Tôkiô market, where they are sold for food; the flesh is white and very palatable. Wild birds<sup>2</sup> are represented in

<sup>1</sup> The great authority on the Japanese flora is Franchet and Savatier's *Enumeratio plantarum in Japonia sponte crescentium*, Paris, 1875-1879, 2 vols., which contains 2743 species of phanerogamic plants,—700 species more, than is, than were given by Miquel, who in 1866 contributed a survey of the subject to the *Mémoires de la K. Acad. van Wetensch.* (Amsterdam), and in 1870 published *Catal. Musei Botanici* (Leyden, part i., *Flora Japonica*) on the basis of the rich collections of the Leyden Museum. Much interesting matter will also be found in Rein's contributions to Petermann's *Mittheilungen*, 1875 and 1879; in the *Mittheil. der deutsch. Ges. Ost-Asiens*; and in Knipping, "Ozaka, Kiôto, &c., in Nippon" in Petermann's *Mittheil.*, 1878. It has been shown that the Japanese flora as a whole has a great similarity not only to that of the neighbouring Asiatic continent but also to that of North America, the coincidences being most frequent, however, not with the flora of the eastern but with that of the western coast.

<sup>2</sup> T. Blakiston and H. Pryer, in their "Catalogue of the Birds of Japan" (*Trans. of the As. Soc. of Japan*, 1880), mention three hundred and twenty-five species of birds, and they do not consider the list as anything like complete. Of these, one hundred and eighty species also occur in China, and about one hundred are identical with those of Great Britain. The Straits of Tsugaru (15 or 20 miles across) appear to be a line of zoological demarcation, as neither the sheep-faced antelope (*Neurothædus crispus*), the Japanese monkey (*Uromia*



**Birds.** Japan by the cormorant, the crane (*Grus leucauchen*, Jap. *Tan-chiyan*), is the national crane), wild goose (at least eight species), swan (*Cygnus musicus*), mallard, widgeon, teal (four species, including falcated teal or Yoshi-gamo), pheasant, woodcock, wood-pigeon, plover, and snipe. There are also found the bittern, the heron, and the white wader, commonly known as the "paddy-bird." Prior to 1868 there existed very stringent laws prohibiting the ordinary Japanese from shooting or snaring the crane, geese, or swan. One species of bittern was even deemed worthy of a special rank of nobility, and is to this day known as the *go-i sagi*, or "bittern of the fifth grade,"—a quaint conceit, reminding us of the well-known jest of Henry VIII. in knighting the loin of beef. Many varieties of domestic fowls exist, the tiny bantam being one of the most celebrated; there is also a large game-cock said to have been originally imported from Siam. Flocks of tame pigeons are to be seen in nearly every farm yard. The lark, swallow, and common sparrow are as numerous as in England. One of the most beautiful birds is the drake of the species generally called the "mandarin-duck" (*Aix galericulata*, Jap. *Oshi-dori*), found on small streams in country districts. When in full plumage this drake presents an exquisite combination of bright colours, and two broad feathers, of a deep golden tint and shaped like a fan, stand erect above the back from under the wings. The Japanese fisheries are marvellously productive, and afford occupation to the inhabitants of the countless villages along the coasts. Herrings are caught off the island of Yezo, and the bonito, cod, sole, crab, and lobster are found in great plenty on nearly every part of the coast. In some of the rivers in Yezo, and also in the Tonégawa, fair-sized salmon are caught; and there is also a fish very much resembling the trout. The *tai*, a large fish of the carp species, is esteemed a special delicacy: of this there are two varieties, —the red *tai*, caught in rivers with sandy beds, and the black *tai*, found at the mouths of streams where the darker soil of the sea bed commences. Eels, small carp, and fish of many other kinds are freely taken in nearly all the mirror lakes and streams. The oyster is found in considerable quantities in the shallows at the head of the Bay of Yedo and elsewhere. To any student of zoology a visit to Japan would prove in the highest degree interesting.<sup>1</sup>

**Communication.**—The means of transport, although not exceptionally good, have yet improved considerably during

*speciosus*), nor the boar (*Sus leucomystax*) have crossed into Yezo. *Heralda glacialis*, *Tetrates bonasia*, *Picus minor*, *Dryocopus martius*, *Corvus corax*, *Ampelis garrula*, *Acredula caudata*, *Leucosticte brunneinucha*, *Geocinus canus*, *Garrulus Brandti*, are apparently confined to Yezo, while *Lobivanellus inornatus*, *Phasianus versicolor* and *Phasianus Sommeringii* (the two species of pheasant peculiar to the country), *Geocinus avokira*, *Cyanopica cyanus*, *Garrulus japonicus*, *Acredula trivirgata*, are not found north of Tsugaru Straits. One species of cuckoo (*Hierococcyx fugax*, Horsf.) is supposed to portend earthquakes, its cry resembling the Jap. *jishin*, earthquake. Among favourite cage-birds are *Zosterops japonica* (Jap. *Meiuro*); *Parus varius* (Jap. *Yama-yara*); the Japanese nightingale, *Cettia cantans* (Jap. *Uyuhisq*); the thrush, *Turdus caedis* (Jap. *Kuro tsugu*); and *Emberiza sulphurata*, the hunting. The robin, the most expensive bird sold by the dealers, seems to be imported from Corea. Compare Temminck and Schlegel, *Fauna Japonica*, and papers by Blakiston, H. Whiteley, and Swinhoe, in *Ibis*, 1862, 1867, 1874, and 1877.

<sup>1</sup> A. R. Wallace has devoted a chapter of his *Island Life* to the treatment of Japan and Formosa. He points out that 40 species of mammals are known to exist in Japan, and that 26 of these are peculiar; whereas of the 165 land-birds already registered only 16 species are peculiar. He gives a list of 40 species of birds which are common to Great Britain and Japan, and adds that it does not sufficiently indicate the resemblance, as there are many birds which, though distinct species from the British, have the same general appearance. Bleeker, the great Dutch naturalist, has *Eijdr. tot de kennis der ichthyol. fauna van Japan* (Amsterdam and Batavia, 1854, &c.), and "Énumération des espèces de poissons actuellement connues du Japon," in *Verhandl. der Kon. Akad. v. Wet.* (Amsterdam, 1879). See also Adams's *Travels of a Naturalist in Japan and Manchuria* (London, 1870).

the past few years. There are but two lines of railway **Railways** in Japan, both very short. The first (opened to traffic in 1872) runs from Tôkiô to Yokohama, and is but 18 miles in length. Shortly afterwards a line of about the same length was completed between the port of Hiôgo and the city of Ôzaka, and this line was in 1877 extended from the latter place to the city of Kiôto, the opening ceremony taking place on the 5th of February in that year. Both these lines were opened by the emperor in person. Surveying operations have been going on for some years, with a view to the construction of other railways, and in some districts the direction of future lines has already been staked out. Mention has been already made of the great facilities for transport afforded by the network of small streams throughout the country. The system of **Roads.** roads, too, is very fair, although in remote districts the work of supervision and repair is not done so carefully as is really necessary. Of the highways the Tôkaidô is that best known to foreigners. This is nearly 307 miles in length, and connects Kiôto and Tôkiô. Its course lies along the south-eastern coast of the main island, and it is the only road in the country which is named after the circuit that it traverses. Dr Kaempfer, one of the early residents in the Dutch factory at Nagasaki, gives in his well-known *History of Japan* a graphic and entertaining account of his journey from Nagasaki to Yedo in 1691, part of which he made by the Tôkaidô. One of the most remarkable works recently completed by Japanese labour, without aid from foreign engineers, is a tunnel on this road. It is situated about 6 miles to the westward of the large town of Shiôzuoka, and about 106 miles west of Tôkiô. The tunnel is cut through a high ridge of hills intersecting the Tôkaidô. The old line of road passed over the summit of the ridge, but this engineering work renders the journey far shorter and easier. A good roadway, some 18 feet in breadth, leads up the ridge on either side, in a zigzag direction, so as to admit of wheeled vehicles passing along it with perfect safety; and the tunnel runs through the centre of the hill, thus connecting the two roadways. The passage is about 200 yards in length; at the eastern end it is faced with stone, then the roof is supported by timber arches for some distance; a small portion is next hewn out of a stratum of solid rock, and finally the timber arches are again continued as far as the western extremity. The breadth throughout is about 12 feet, and the height about 10 feet. As the tunnel runs in a curved line, owing to the formation of the hill, and is thus very dark, lamps are placed in it at intervals; while at each end are fixed in the ground several posts, each surmounted by a brightly polished oblong plate of tin, to reflect the rays of the sun into the interior. This important work was commenced in 1873, but was not completed until March 1876. Another road between Kiôto and Tôkiô is the Nakasendô, also called the Kiso-kaidô; this runs through the heart of the country, to the north of the Tôkaidô, and is a little over 323 miles in length. Some of the hill scenery on the western half of this road is exceptionally grand; the elevation in many parts is so great that in winter the roadway is much obstructed by snow. The longest high road in Japan is the Ôshiu-kaidô, running northward from Tôkiô to Awamori on the Tsugaru Straits. It traverses the provinces of Musashi, Shimotsuké, Iwashiro, Rikuzen, Rikuchiu, and Michinoku, and its length is given at nearly 444 miles. Two roads from Tôkiô to Niigata exist, the longer being about 264 and the shorter about 223 miles in length; the latter is said to be impassable in winter. Neither of these possesses a name, and for a considerable distance each is identical with the Nakasendô. Another road, which, though far shorter than those already mentioned, still possesses great interest for the traveller on

account of the beauty of its mountain scenery, is the Kôshin-kaidô. It unites Tôkiô and Kôfu, the chief town in the province of Kai, and is 77 miles in length; from Kôfu a continuation of it joins the Nakasendô at Shîmono-suwa, in the province of Shinano, some 32 miles further. To the west of Kiôto lie many other roads, but they are of less importance because there is little traffic in the Saniudô, while that of the Sanyôdô is conducted in junks which ply on the Inland Sea. In the islands of Shikoku and Kiushiu the roads are stated to be very bad, particularly in the mountainous regions lying in the southern portion of the latter, on the confines of the provinces of Hiuga, Higo, and Satsuma.

The question of road superintendence is one of which the Japanese Government has fully realized the importance. At a general assembly of the local prefects held at Tôkiô in June 1875 there was brought forward a bill to classify the different roads throughout the empire, and to determine the several sources from which the sums necessary for their due maintenance and repair should be drawn. After several days' discussion all roads were eventually ranged under one or other of the following heads:—

I. National roads, consisting of—

Class 1. Roads leading from Tôkiô to the various treaty ports.

Class 2. Roads leading from Tôkiô to the ancestral shrines of Japan in the province of Isô, and also to the various *fu* ("cities"), or to the military stations.

Class 3. Roads leading from Tôkiô to the various *ken* ("prefecture") offices, and those forming the lines of connexion between the various *fu* and military stations.

II. *Ken* ("prefecture") roads, consisting of—

Class 1. Roads connecting different prefectures, or leading from the various military stations to their several outposts.

Class 2. Roads connecting the head offices of the various cities and prefectures with their several branch offices.

Class 3. Roads connecting noted localities with the chief town of such neighbourhoods, or leading to the seaports convenient of access from those localities.

III. Village roads, consisting of—

Class 1. Roads passing through several localities in succession, or merely leading from one locality to another.

Class 2. Roads specially constructed, for benefit of irrigation, pasturage, mines, manufactories, &c., consequent upon measures determined by the local population.

Class 3. Roads constructed for the benefit of Shintô shrines, Buddhist temples, or for cultivation of rice-fields and arable land.

Of the above three headings, it was decided that all national roads should be maintained at the national expense, the regulations for their repair, cleansing, &c., being entrusted to the care of the prefectures along the line of route, but the cost incurred being paid from the imperial treasury. *Ken* roads are to be kept up by a joint contribution from the Government and from the particular prefecture, each paying one-half of the sum needed. Village roads, being for the convenience of the local districts alone, are to be maintained at the expense of such districts under the general supervision of the corresponding prefecture. The width of the national roads was determined at 7 ken<sup>1</sup> for class 1, 6 ken for class 2, and 5 ken for class 3; the prefecture roads were to be from 4 to 5 ken; and the village roads were optional, according to the necessity of the case.

Vehicles.

On most of the high roads run small stage waggons of various sizes, but these are as a rule badly made, insecure, and for the conveyance of passengers alone. In the mountainous regions, and especially in the hills immediately behind the foreign settlement (Kôbé) at Hiôgo, in the province of Setsu, small bullock cars are to be seen. These are roughly made of untrimmed timber, and are anything but strong; each rests on three wheels of solid wood, and is drawn by one bullock. They are, however, very useful for the conveyance of blocks of stone from the hills, and for rough country work. In the large towns, and also on all fairly level roads, passengers may travel in small two-wheeled carriages called *jin-riki-sha*; these are in shape like a miniature gig, and are as a rule drawn by a single coolie, though for rapid travelling two men are

<sup>1</sup> 1 ken = 71½ inches.

usually employed. In the city of Tôkiô alone there exist over 10,000 of these *jin-riki-sha*, and various improvements as regards their style, shape, and build have been introduced since 1870, the year in which they first came into use. Many are of sufficient size to carry two persons, and on a good road they travel at the rate of about 6 miles an hour; the rate of hire is about 5d. per Japanese *ri*, or about 2d. per mile. For the transport of baggage or heavy goods large two-wheeled carts are in use; these are pushed along by four or six coolies. Until very lately the only vehicle employed in travelling was the palanquin. Of these there were two kinds, viz., the *norimono*, a large litter carried by several bearers, and principally used by persons of the better class, and the *kago*, still to be seen in hilly districts where carriages cannot pass. The *kago* is a mere basket-work conveyance, slung from a pole carried across the shoulders of two coolies; and it is easy to see that the substitution of the wheeled *jin-riki-sha* drawn by only one man was a great improvement as regards both economy of labour and facility of locomotion. In country districts, and wherever the roads are stony or narrow, long strings of pack-horses meet the eye. These animals are shod with straw sandals to protect the frog of the hoof, and their burden is attached by ropes to a rough pack-saddle without girths. They go in single file, and move only at a walk. To their necks is attached a string of small metal bells,—a survival of the ancient usage whereby a state courier was provided with bells to give timely warning of his approach at the different barriers along his route, and so to guard against any impediment or delay. The peasants also often employ oxen as beasts of burden in hilly regions; these animals, too, are shod with straw sandals, having a portion raised so as to fit into the cleft in the hoof. Burdens of moderate weight are usually carried by coolies, one package being fastened at each end of a pole borne across the shoulder. In remote districts even the Government mails are thus forwarded by runners. In all the post-towns and in most of the larger villages are established transport offices, generally branches of some head office in the capital, at which travellers can engage *jin-riki-sha*, *kago*, pack-horses, and coolies, or make arrangements for forwarding baggage, &c. The tariff of hire is fixed by the Government, and this is paid in advance, a stamped receipt being given in return. Most of the inns in the post-towns subscribe to one or another of the so-called travelling guilds, each of which has a head office in Tôkiô, and often in Kiôto and Ôzaka. Upon application at this office, the traveller can obtain a small book furnishing general information as to the route by which he proposes to proceed,—such as the distances between the halting places, the names of rivers and ferries, and hints as to places of interest along his road. It also contains a full list of the inns, &c., enrolled on the books of that guild, a distinction being made between lodging-houses and places where meals alone are provided. To this list each landlord is obliged, at the traveller's request, to affix his stamp or seal at the time of presenting his account; and by this system cases of incivility or overcharge can be reported at the head office, or application made there in the event of articles being forgotten and left behind at any inn. The Japanese themselves seldom travel in the interior except under this system, and were foreign visitors only to follow their example they might avoid a good deal of the inconvenience they not unfrequently experience.

*Towns.*—The towns and villages are very numerous along the line of the great roads. The three great cities are Tôkiô (Yedo), Ôzaka, and Kiôto. The last-named was the ancient capital, and had been in existence for centuries before Tôkiô, and also for a very considerable time before



Ōzaka was built. Now, however, these two have rapidly outstripped Kiōto both in size and importance, and are in fact the two great centres of trade throughout the whole country. The emperor's court now resides at Tōkiō, and it is there that the foreign legations are stationed. The city of Ōzaka (often wrongly spelt Osacca) is purely mercantile; it is intersected by numberless canals spanned by bridges that are in some cases of great length, and a very large proportion of the buildings are storehouses for merchandise. The Japanese mint (opened in April 1874) is at Ōzaka. Next in importance to these three cities may fairly be classed the various ports thrown open, under the treaties with Western powers, to foreign trade. Commencing from the north, we come first to Hakodaté (erroneously spelt Hakodadi) in the south of the island of Yezo. There is here no distinct foreign settlement, the houses of the few Europeans being mingled with those of the natives. The chief exports are dried fish and seaweed. On the main island the most northern port is Nūgata, in the province of Echigo, where also no foreign settlement as yet exists. The trade is exceedingly small, owing to the bad anchorage. A bar of sand at the mouth of the river (the Shinano-gawa) prevents the approach of foreign-built vessels, and the roads off the river mouth are so unprotected that when a heavy gale blows the European ships often run across to the island of Sado for shelter. Some little trade, however, is carried on, the neighbourhood being very fertile; rice and copper are the chief productions. Yokohama, about 18 miles to the south of the capital, and situated on the western shore of the Bay of Yedo, enjoys by far the greater proportion of the whole foreign trade of Japan. The foreign settlement is very large, and numerous bungalows and small villas of the European residents are also built on a hill (known as the "Bluff") overlooking the "settlement" proper. The chief exports are tea and silk; the former goes principally to the United States and to England, and the latter to the French markets. Large business transactions also take place in silkworm eggs and cocoons, as well as in copper, camphor, and sundry other articles of trade. Proceeding westward, we come to the port of Hiōgo, in the province of Setsu. The foreign settlement, generally called Kōbē, is not so large as that of Yokohama, but the streets are wider and more commodious. A railway connects this place with Ōzaka, where there is also a foreign settlement, though of very small size. The principal exports here are tea, silk, camphor, vegetable wax, &c. Nagasaki, the best known by name of all the open ports, is in the province of Hizen, in the large south-western island of Kiushiu. The foreign settlement is small, though the native-town is of considerable extent. Coal is the staple export. Dr Kaempfer's *History of Japan* gives a most exhaustive and interesting description of the everyday life of the early Dutch residents at this port, where they were pent up in the tiny peninsula of Deshima (commonly misspelt Decima or Dezima) in the harbour. Throughout the rest of the country the largest towns are as a rule those that were formerly the seats of the territorial nobles (*daimiō*), and are even now commonly known as "castle-towns." It is easy to conceive that in the olden days, under the feudal system, the residence of the lord of the district formed a kind of small metropolis for that particular locality; and the importance thus attaching to the castle-towns has in most cases survived the departure of the nobles to the capital. The castles usually stood some slight distance from the rest of the town, often on a hill or rising ground overlooking it. In the centre rose the keep or citadel, a strong tower of three or five stories, commanding the whole of the fortifications; this was surrounded by high earthen ramparts, faced on the outside with rough-hewn blocks of stone and

defended by a moat, which was often of considerable width. The gateways were square, with an outer and an inner entrance, constructed of stone and heavy timbers. The lines of fortification were as a rule three in number. Above the ramparts rose a slight superstructure of wattled stakes, whitewashed on the outside and loopholed for musketry and archers' shafts. The whole produced a very striking effect when viewed from some slight distance, the grey stone and the brighter whitewash showing distinctly from among the dark foliage of the trees in the pleasure grounds within the enclosure. It was not, however, every castle that was built on the scale just described; many of them were exceedingly small, and were defended only by narrow ditches and weak wooden gates, the buildings within being thatched with straw and hardly superior to the ordinary peasant's dwelling. Most of these castles have been demolished, but a few yet remain nearly intact to tell the tale of the former pomp and state of the feudal nobility. On the outskirts of the castle dwelt the retainers of the *daimiō*, their houses being sometimes situated within the outermost moat, and sometimes, again, completely beyond it. The houses of the townspeople still stand in their original positions. They are constructed almost entirely of wooden posts, beams, and planks, the roofs being generally tiled. The floors are raised to a height of about 18 inches from the level of the ground, and are covered with large straw mats an inch and a half in thickness. These mats are nearly all 6 feet in length by 3 in breadth, are covered with a layer of finely plaited straw, and have the edges bound with some dark cloth. The doors to the rooms are formed of sliding screens of wooden framework covered with paper; these are 6 feet high, and move in grooves in the beams fixed above and below them. In the houses of well-to-do persons, these slides are often covered with coarse silken stuff, or formed of finely planed boards, usually decorated with paintings. At one side of the room is generally seen a recess, with a low dais; on this various ornaments or curiosities are ranged, and a painted scroll is hung at the back of the whole. A few years back, before the wearing of swords was prohibited, a large sword-rack (often of finely lacquered wood) usually occupied the place of honour on the dais. The ceilings are of thin boards, with slender cross-beams laid over them at intervals. Except in the larger towns, there are hardly any buildings of more than two stories, though the inns and lodging-houses sometimes have as many as four. The front of the dwelling is either left entirely open, or, with the better class of tradespeople, is closed by a kind of wooden grille with slender bars. Those who can afford it usually shut in the frontage altogether by a fence, through which a low gateway opens upon a small garden immediately in front of the entrance to the dwelling. At the back there is generally another tiny garden. All round the house runs a narrow wooden verandah, of the same height as the floor, over which the roof protrudes; this verandah is completely closed at night or in stormy weather by wooden slides known as "rain-doors," moving in grooves like the slides dividing the rooms in the interior. Next in importance to the castle-towns come the post-towns along the high roads, where travellers can obtain accommodation for the night, or engage conveyances and coolies for the road. The houses are similar to those already described, but are built on a smaller scale, and most of them are thatched instead of being tiled. The inns and tea-houses are the grand feature of these towns; as a rule the accommodation there to be obtained is excellent, though this is of course only on the great highways. In remote country districts the traveller is frequently forced to rough it, and put up with what he can find in the way of shelter. Each post-town possesses an office for the receipt, for-

Treaty  
ports.Castle  
towns.

Houses.

Post-  
towns

warning, and delivery of the postal mails; as a rule the mayor or vice-mayor of the district is charged with this duty.

**Villages.** *Rural Life.*—The agricultural villages are often very poor places, the houses being dilapidated, and the food and clothing of the peasants meagre in the extreme. In many instances the farm-buildings are situated in the midst of the rice-fields or on a hill slope, at some little distance from the road. Even the women and children go out to till the ground from early morn until late in the evening, their labour being sometimes varied by felling trees or cutting brushwood on the hills. In some localities they eke out their means of livelihood by snaring birds, or by fishing in the numerous ponds and rivulets. Those who can afford to do so keep a pack-horse or an ox to be used either as a beast of burden or to draw the plough. The farming implements are in many cases very primitive.

The plough is exceedingly small, with but one handle, and is easily pulled through the soft mud of the rice-fields by a single pony or a couple of coolies. To separate the ears of grain from the stalks the latter are pulled by hand through a row of long iron teeth projecting from a small log of timber; the winnowing fans are two in number, one being worked by each hand at the same time. The spades and hoes used are tolerably good implements, but the sickle consists merely of a straight iron blade, some 4 inches in length, pointed, and sharpened on one side, which projects from a short wooden handle about 15 inches long. When the grain is gathered in, the straw is stacked in small sheaves and left in the fields to dry, after which it is used for thatching or as litter for cattle. In the wilder districts the peasantry are wretchedly poor, and cannot indeed afford to eat even of the rice they cultivate; their ordinary food is millet, sometimes mixed with a little coarse barley. The potato and the long radish (*daikon*) are almost the only other articles of food within their means. Agrarian riots are not unfrequently occasioned by bad harvests or scarcity from other causes, and the consequences are sometimes very disastrous, the peasants, when once excited, being prone to burn or pillage the residences of the local officials or headmen of the villages. These riots do not, however, arise as in former days from the exactions of the lords of the soil. There is no doubt that prior to the revolution of 1868-69 the peasantry were in too many cases grievously oppressed by their feudal chiefs, especially on those estates owned by the *katomoto* or petty nobility of the *shōgun's* court at Yedo. These nobles, with some very rare exceptions, resided continuously in the city, leaving their fiefs under the control and management of stewards or other officers; whenever money was needed to replenish the coffers of the lord, fresh taxes were laid on the peasantry, and, should the first levies prove insufficient, new and merciless exactions were made. Under the present central Government, however, the condition of the Japanese agricultural classes has been greatly ameliorated. A fixed land-tax is levied, so that the exact amount of dues payable is known beforehand. In the event of inundations, poor harvests, or similar calamities, Government grants are constantly made to the sufferers.

**Education.**—Throughout the whole country schools have been established, for the support of which the Government often gives substantial assistance. The cost of tuition in these establishments is generally fixed at a rate within the means of the poorest classes. In most of the remote villages the schoolhouse is now the most imposing building.

**Administration.**—Court-houses have been erected in each prefecture, where the laws are administered by Government officials appointed by the department of justice at the capital. These courts are placed under a smaller number of superior courts, to which appeals lie, and these

are in turn subordinate to a supreme court of appeal in Tōkiō. By a Government edict issued on the 13th of September 1876 the titles and jurisdiction of the various courts were fixed as follows:—

1. Tōkiō court.....Tōkiō fu, Chiha ken.
2. Kiōto court.....Kiōto fu, Shiga ken.
3. Ōzaka court.....Ōzaka fu, Sakai ken, and Wakayama ken.
4. Yokohama court.....Kanagawa ken.
5. Hakodatē court.....Hok'kaidō.
6. Kōbē court.....Hiōgo ken, Okayama ken.
7. Niigata court.....Niigata ken.
8. Nagasaki court.....Nagasaki ken, Fukuoka ken.
9. Tochigi court.....Tochigi ken, Ibaraki ken.
10. Urawa court.....Gumma ken, Saitama ken.
11. Awomori court.....Awomori ken, Akita ken.
12. Ichinosēki court.....Iwadē ken, Miyagi ken.
13. Yonēzawa court.....Yamagata ken, Fukushima ken.
14. Shidzuoka court.....Shidzuoka ken, Yamanashi ken.
15. Matsumoto court.....Nagano ken, Gifu ken.
16. Kanazawa court.....Ishikawa ken.
17. Nagoya court.....Aichi ken, Miyē ken.
18. Matsuyama court.....Shimane ken.
19. Matsuyama court.....Ehimē ken.
20. Kōchi court.....Kōchi ken.
21. Iwakuni court.....Yamaguchi ken, Hiroshima ken.
22. Kumamoto court.....Kumamoto ken, Ōida ken.
23. Kagoshima court.....Kagosima ken.

Four superior courts, having jurisdiction over the above, were then also established, viz:—

1. Tōkiō superior court..... { Tōkiō, Yokohama, Tochigi, Urawa, Aichi, Shidzuoka, Niigata, and Matsumoto courts.
2. Ōzaka superior court..... { Kiōto, Ōzaka, Kōbē, Kanazawa, Matsuyama, Kōchi, Matsuyē, and Iwakuni courts.
3. Miyagi superior court..... { Awomori, Ichinosēki, Yonēzawa, and Hakoda courts.
4. Nagasaki superior court... { Nagasaki, Kumamoto, and Kagoshima courts.

Small police stations have been erected in all towns and villages of any importance; along the high roads the system is carefully organized and well carried out, though in distant localities the police force is often wholly inadequate to the numbers of the population. The Japanese lower orders are, however, essentially a quiet and peaceable people, and thus are easily superintended even by a very small body of police. In the capital and the large garrison towns it is a different matter, and collisions frequently occur with the riotous soldiery. The military stations are established in some of the larger castles throughout the country, the principal garrisons being at Tōkiō, Sakura in Shimōsa, Takasaki in Kōdzukē, Nagoya in Owari, Ōzaka in Setsu, Hiroshima in Aki, and Kumamoto in Higo.

Since the restoration of the *mikado* Japan has undergone many internal changes. Innumerable measures of reform in the internal administration of the country have been introduced. The former territorial nobles surrendered their castles and muster-rolls of retainers to the central Government, and are now, in common with the old court nobles of Kiōto, classed under the one name of *kuazoku*, or simply "nobles." They now reside in Tōkiō, the capital of the empire. To this class of nobles belongs the former king of the Riuki Islands. After the *kuazoku* come two other grades, called respectively the *shōzoku* and the *heimin*, or, as they may be termed, the gentry and commoners. The former comprises the old *katomoto*, or petty nobility of the *shōgunate*, and the *samurai*, or military families, from whom the retainers of the *daimiō* were recruited. The *heimin* include the peasantry, artisans, and traders. Thus the ancient "four classes" of the population have been reduced to three. The *han* system has been abolished, and the system of *ken*, or prefectures, directly under the control of officers of the central Government, established in its stead. The debts of the *han*, consisting chiefly of the redemption of their paper-currency, were also taken over, and this measure certainly involved the present administration in considerable financial difficulties from the very outset, so much so that large issues of Government notes and bonds have become necessary. A grand scheme for the capitalization of incomes was put into operation in August 1876. The *daimiō*, on surrendering their muster-rolls to the crown, were relieved from the necessity of paying the incomes of their retainers, and, with the old

Educa-  
tion.

Adminis-  
tration.



*kné* class, received certain allowances from the Government. It is probable that only the wealthier nobles found any hardship entailed upon them by this arrangement, for, if we take into consideration the payments that had to be made by a *daimiô* under the old régime in the way of dues to the *shôgun* and allowances to retainers, &c., it cannot be doubted that the lower grades of the former territorial chieftains are in many cases better off at present than they were before the revolution. Their old retainers, too, received from the Government certain fixed incomes, or pensions, calculated upon their former rates of pay, and thus became direct dependants of the nation instead of one particular *han*. In 1876, however, these allowances to both *kuazoku* and *shizoku* alike were commuted, according to an elaborate scheme drawn up by the finance department. Government bonds for a total commutation sum were given to each person, to be paid off yearly, by lot, to a certain amount, and bearing in the meantime interest varying from 5 to 7 per cent., due every half year. In course of time, therefore, the Government will be entirely relieved from its heavy responsibility in this respect. Amongst other reforms, the wearing of swords by the *samurai* was also, about this time, prohibited by public edict. This, as might have been foreseen, occasioned considerable dissatisfaction for a while, especially in the southern provinces of Satsuma and Tosa; but, as it had been wisely prepared for, some time before, by a notification making the carrying of these weapons optional, large numbers of the military class had already discarded them ere the second notice was issued, and the task was thus rendered far more easy of accomplishment. An exception was, however, made in the case of officers and men of the newly-organized army and navy. These two branches of the public service are now on a fixed system, formed on the model of those adopted by Western nations; and large numbers of foreign instructors have been from time to time employed by the Japanese Government.

Numerous departments or bureaus now exist for the direction of public affairs, the principal being those for home affairs, finance, public works, foreign affairs, war, admiralty, education, justice, and police. Many of these are subdivided into several sections, varying considerably in number according to circumstances. The whole constitution is avowedly modelled after the Western systems.

There does not as yet exist any house of parliament, but already the seeds have been sown from which it may rise at some future day. A chief council, termed the *genrôin* or "senate," exists, and throughout the whole country are found numerous "assemblies," the members of which are elected by vote. These assemblies, however, do not possess any share in the administration; their functions are as a rule very limited, and the subjects discussed by them are chiefly matters relating to roads, drainage, bridges, and other local affairs of but minor importance. The local prefects also meet at intervals to discuss various points of local interest. There are not wanting indications that the establishment of a parliament, like that of England, would be welcomed with joy by a very large proportion of the people. The press is under the supervision of the Government officials in each district, and many restrictions are imposed upon any excess of freedom of speech in the newspapers. The editors have in many instances been subjected to fine or imprisonment for having permitted the publication of certain articles that proved distasteful to the Government. The press laws under which these punishments were awarded were issued in 1875.

Popula-  
-ion.

**Population.**—The number of inhabitants in Japan was until lately very uncertain. To the ordinary traveller it would seem to be very dense, as the roadways are lined with villages; but in the wider regions the population is widely scattered, and indeed in certain localities not a single dwelling-house is to be seen for miles together. Dr Kaempfer's ideas on the subject may be taken as rather exaggerated, for it must be remembered that they were derived merely from that portion of the country traversed by him in his journeys from Nagasaki to Yedo. As he visited on his route the large city of Ôzaka, and as he then passed along the Tôkaidô—the most populous and frequented of all the roads throughout the whole empire—it is easy to understand that his theory as to the enormous population was based upon a very deceptive impression. The total has been generally asserted by the Japanese themselves to be about 30,000,000, the authority being a census made so far back as in 1804. A return compiled in 1875, however, put the exact total at 33,997,449; and the still later census of 1880 gave it as 34,338,404, of whom 17,419,785 were males, and 16,918,619 females. The population of the city of Tôkiô is variously stated, but

is probably not much over 800,000. According to a computation made in the year 1870, Kiôto had then about 370,000 inhabitants. Next in importance after these two cities comes Ôzaka, with a population of 414,000 souls. After Ôzaka may be mentioned Nagoya, the chief town of the province of Owari, followed closely by Hiroshima in Aki, Saga in Hizen, Kagoshima in Satsuma, Kanazawa in Kaga, and Himéji in Harima,—most of which are said to possess over 100,000 inhabitants. Fukui in Echizen and Gifu in Mino rank in the second class. Of the ports open to foreign trade, Ôzaka being excluded, Nagasaki is said to have the largest population, being very slightly in excess of Yokohama; Hakodaté and Niigata have perhaps about 30,000 each. The foreign communities are very small: they may be numbered at a few hundreds at Yokohama, Tôkiô, Kôbé, and Nagasaki, while at Ôzaka, Hakodaté, and Niigata the European residents may be reckoned by tens.<sup>1</sup>

**National Wealth.**—Although possessed of considerable National mineral wealth, Japan cannot be called a rich country. wealth. The early foreign residents, from the time the treaties were made in 1858 and following years, were perhaps over-sanguine in their expectations. Recent commercial returns show that the balance of trade has been against Japan, her exports being considerably in arrears of the imports.<sup>2</sup> Up to the present time this deficiency has been chiefly supplied by an export of bullion, paper money being issued in large quantities for use in the country itself. The value of the notes now in circulation is very great, and it is hard to say how or when they can be redeemed. The notes issued at the time of the revolution of 1868 bore an endorsement to the effect that they were to be redeemed within thirteen years; but, instead of this, they have been replaced by another issue, without any such endorsement. In 1879-80 the Japanese paper currency fell to a discount of above 50 per cent. as compared with the silver Mexican dollar in use amongst the foreign merchants.

**Public Works.**—In spite of these financial difficulties, Public works. the Japanese have made great advances in public works. In the number of its lighthouses Japan may compare favourably with many a Western nation. Though all have been erected by foreign engineers during the past ten or twelve years, there is hardly a promontory or island lying in the direct track of the shipping but is possessed of a lighthouse. Many of the lights are very powerful; but in localities of less importance, or lying off the track of foreign vessels, smaller junk lights are used. Buoys and beacons of various sizes have been moored in many places. The whole system is under the superintendence of a special Government bureau (the lighthouse department), which despatches steamers at stated periods to make the tour of the coast and convey stores and provisions to the different posts. At the more important lighthouses foreign lightkeepers are employed, but in many instances the service is performed by natives alone. The rocky and dangerous character of the Japanese coasts makes this system one of peculiar utility. As already mentioned, good progress is being made in railway construction. Numerous lines of telegraph have been erected throughout the country, not only between the treaty ports but also in the interior, particularly to the garrison towns and local Government offices. The mint at Ôzaka has been working since the year 1871. At Yokosuka, on the western shore of the Bay of Yedo, are a dockyard and arsenal, superintended by French engineers; those

<sup>1</sup> According to an official report published in 1880 there are in Japan 108 towns with 10,000 inhabitants and upwards.

<sup>2</sup> The consular trade reports for the open ports in Japan, published yearly in the blue books, afford minute information on all subjects connected with commerce between Japan and other nations.



have proved of great utility. Large numbers of foreign men-of-war and other vessels have there been docked and repaired. Paper-mills have been established in different localities, and manufactories of various descriptions started. The postal system is exceedingly well managed, and extends over the whole empire. Attention is also given to custom-house arrangements at the open ports. In the capital there are numerous colleges and Government schools, notably for military, naval, and scientific instruction, conducted in many instances by foreign teachers. The mail service along the coast deserves special mention. The steamers employed belong chiefly to the Japanese steamship company known as the Mitsubishi Company; these ply along the entire length of the coast and also to Shanghai, passing through the "Inland Sea," and smaller boats run to Newchwang in China, and to the Riukiu islands. The company is subsidized by the Government.

*Religion.*—The religious beliefs of the Japanese people may be divided under two heads, the *Shintô* and the Buddhist. By the former is meant the religious belief of the natives prior to the introduction from abroad of Buddhism and the Confucian philosophy.

*Shintô* means literally "the way of the gods." Though often styled by foreign writers a religion, it really is not one. No concise definition of it appears to exist, but the following are some of its leading points.<sup>1</sup> It contains no moral code, the writer Motoori (a high authority on this subject, born 1730, died 1801) even asserting that in Japan there was no necessity for any system of morals, as every Japanese acted aright if he only consulted his own heart. He also declared that the whole duty of a good Japanese consisted in obeying implicitly and without question the commands of the *mikado*. In *Shintô* Japan is held to be the country of the gods, and the *mikado* to be the direct descendant and actual representative of the Sun goddess. In it there also seems to be mixed up a system of hero worship, many renowned warriors and other personages of ancient days being exalted into what we should term demi-gods; thus it inculcates a reverential feeling toward the dead. By it, too, spiritual agencies are attributed to the elements or natural phenomena. The *Shintô* shrines throughout the country are built in very simple style, being generally constructed of white wood, unadorned by brilliant colouring as in Buddhist temples, and roofed with thatch. Before each shrine stand one or more *torii*, archways formed of two upright posts with a projecting cross bar laid on their summits, beneath which is a smaller horizontal beam, the ends of which do not project. As its name implies, the *torii* was originally a perch for the fowls offered to the gods, not as food, but to give warning of daybreak. This archway gradually assumed the character of a general symbol of *Shintô*, and the number which might be erected in honour of a deity became practically unlimited. The special peculiarity distinguishing the pure *Shintô* shrines from the Buddhist temples is the absence of images exposed as objects for the veneration of the worshipper; but at the same time the former nearly always contain some object in which the spirit of the deity therein enshrined is supposed to reside. The principal *Shintô* shrines are those in the department of Watarai in the province of Isé, known as *Isé Dai-jin-gu* ("the great divine palaces of Isé"), and maintained by Government.

The first Buddhist images and Sûtras were brought to Japan from Corea in the year 552, if we can believe the *Nihongi*; but it was long before the religion obtained much hold on the people. In the beginning of the 9th century the priest Kûkai (now better known as Kôbô Daishi) compounded out of Buddhism, Confucianism, and *Shintô* a

system of doctrine called *Riôbu Shintô*, the most prominent characteristic of which was the theory that *Shintô* deities were nothing more than transmigrations of Buddhist divinities. Buddhism, thus fairly introduced, ere long obtained complete ascendancy; it became the religion of the whole nation, and held that position until the Tokugawa dynasty of *shôgun*, when it was supplanted in the intellects of the educated class by the philosophy of Choo He. Its teachings were calculated to awaken man to a sense of his own shortcomings and to cause him to long for perfection; it encouraged belief in a succession of lives and transmigration of souls; and the highest reward promised to the true believer was to be absorbed into Buddha and to attain to absolute perfection. Under the Tokugawa family, many grants were made from their treasuries to famous Buddhist temples, notably to that of Zôjôji in the district of Shiba, in Yedo, which was endowed by Iyéyasu himself in the concluding years of the 16th century. These grants were, however, withdrawn after the restoration of the *mikado* in 1868, and Buddhism has been virtually disestablished since 1st January 1874. Many temples are still kept up, but these are maintained by voluntary contributions from the people and from former patrons.

Since the admission of foreigners into Japan, various Christian missions have been established, principally in Tôkiô and Yokohama, and a tolerably large number of missionaries reside in different parts of the country. Churches have been built, and schools opened for the instruction of children. Christianity is no longer prohibited, as of old, by Government edict, and the number of the native converts is said to be increasing.<sup>2</sup>

#### HISTORY.

The ancient history of Japan, as recorded in the native annals, is Early so completely enshrouded in mythological legend as to be absolutely untrustworthy. In these legends numerous deities play a conspicuous part, the country itself being styled the "land of the gods," and the pedigree of the sovereign traced back to *Tenshô Daijin*, the "Sun goddess." It is asserted that there first existed seven generations of "heavenly deities," who were followed by five generations of "earthly deities," who in turn were succeeded by the mortal sovereigns, of whom the present *mikado* or emperor is the 122d. The earliest date accepted amongst the Japanese themselves corresponds to 660 B.C., when the first emperor (Jimmu) succeeded to the throne. The present year (1881) is thus the 2541st year of the Japanese era. The long line of sovereigns comprises one hundred and eleven emperors and eleven reigning empresses. A strong ground for disbelieving the accuracy of ancient Japanese chronology, even after 660 B.C., is the extraordinary longevity assigned by it to the early *mikados*. Of the fifteen emperors from Jimmu onwards, eleven are said to have lived considerably over one hundred years; one of them, Suiin, reached the age of one hundred and forty-one years, while his successor Keikô attained to one hundred and forty-three. After the year 399 A.D., however, these wonderful assertions are no longer made. From the commencement of the 10th century the Japanese annals are more to be trusted, and, although many discrepancies no doubt exist, still the events recorded are generally accepted as authentic.<sup>3</sup>

The precise origin of the Japanese race is by no means easy to determine, and it would seem probable that it is an amalgamation of several different races. The present Aino tribes of the island of Yezo are supposed to be the descendants of the ancient aborigines of the empire. These aborigines, or "savages," as Japanese historians are wont to style them, were at first spread over by far the greater portion of the country, but were gradually driven towards the north by an opposing race who advanced from the south-west.<sup>4</sup> This latter race, the ancestors of the present true

<sup>2</sup> On July 1, 1878, the nine American and six British Protestant missions in Japan had 104 missionaries (77 American), 26 churches, 112 chapels, &c., 1617 church members, 3 theological schools, 173 students, 9 ordained preachers, and 93 assistant preachers, besides many largely attended schools for children. The Roman Catholics and the Greek Church claim many converts also.

<sup>3</sup> See William Bramsen's *Japanese Chronological Tables*, from 645 A.D. to 1873.

<sup>4</sup> See D. N. Anntschin, "Der Völkerstamm der Ainos," in *Russ. Rev.*, 1877; and L. de Rosny, "Étude sur les Aino." *Ann. intern. de scienc. géogr.*, Paris, 1878.

<sup>1</sup> See also Dr Magel's papers on "Les Religions du Japon," in the *Annales de l'extrême Orient*. 1878-1879.

Religion.

Shintô.

Bud-  
dhis-m.



Japanese people, are by some writers supposed to have been of Chinese origin; and Japanese annals certainly make mention of such a colony as founded during the reign of the seventh emperor, Kōrei (290-215 B.C.). It is, however, beyond all doubt that the Malay tribes are also represented in the Japanese people, and history further notes an invasion by "black savages," which would seem to point to the natives of Papua or New Guinea. From the relative positions of Japan and Corea, too, it seems probable that some of the inhabitants of the latter place may also have crossed the narrow seas dividing them from Tsushima and the main island of Japan. Ethnologists are not unanimous in their opinions on these points, but it is generally conceded that there did exist an ancient indigenous race, who were subsequently subjugated and driven towards the north by certain tribes advancing from the southwest. Thus, in the early history of Japan we find that Kiōto and the provinces immediately around it were occupied by the conquerors, from whom descended the modern Japanese; while the aboriginal tribes were with difficulty restrained and pent up in the eastern and northern regions.

Relation of the mikado and military class.

The *mikado* himself dwelt at Kiōto, with his court. The nobles composing the court were styled *kuge*, and were themselves descended from cadet branches of the imperial family. There was but one sovereign, and to him the whole empire owed allegiance; he lived in extremely simple style both as regards food and dress, and rode out to the chase surrounded by his retainers. But the inroads of the savages on the eastern borders necessitated constant and vigilant measures for their repression. In such expeditions, however, no special class of generals was created; everything was ordered in the name of the *mikado* himself, or in some cases an imperial prince acted as his representative, so that in no instance did the power even appear to pass from the hands of the sovereign. In the Middle Ages, however, the Chinese military system was adopted as a model, and generals were appointed; the able-bodied males in each province were formed into distinct military corps, and men were told off according to the muster-rolls to garrison the capital or to guard the frontiers. Expeditions were carefully organized, being placed under a general (*shōgun*), who was assisted by subordinate officers. All weapons of war and other appliances were kept in the military stores, and issued as occasion required; when warlike operations were suspended, the arms were returned to the stores for safe keeping. As time passed on the powerful family of Fujiwara began to exercise the administrative power hereditarily, in virtue of its relationship to the throne by the female side, and it then became the usage that high descent should be the only qualification for office. The rank and title of general were consequently conferred on the two rival clans of Hei and Gen, or Taira and Minamoto, as they are also termed. Upon this there first arose the expression "military class," and during the period 770-780 the complete sovereignty of the agricultural class and the soldiery took place. From this time onwards the military domination acquired yearly greater strength, while the power of the *mikado* decreased in proportion. The turbulent common people of the provinces of Ōshū, Déwa, and the Kwantō were always in the possession of armour and horses, and openly styled themselves "warriors." In the 10th and 11th centuries the clans of Taira and Minamoto increased in warlike power and influence, became deadly rivals, and virtually ruled the whole country, all the inhabitants owing fealty to one or other of the two factions. A terrible civil war ensued, extending from the middle to the end of the 12th century, when the Taira clan was annihilated by its rivals, who thereupon seized the supremacy. They in their turn succumbed and were succeeded by others, down to the last dynasty (that of the Tokugawa family), which existed from 1603 till 1868. All this time the *mikados* were in reality merely puppets swayed at will by the military faction in power at the time; and the ancient state of affairs was overthrown, and the sovereign himself was kept almost a prisoner in his palace at Kiōto. In 1868, however, the revolution shattered the might of the then ruling clan of Tokugawa, the restoration of the *mikado* was effected, and the present position of the sovereign is at last almost perfectly similar to what it was in the very ancient times.

Taira and Minamoto clans.

The most interesting portion of Japanese history is that of the rise and fall in the Middle Ages of the warlike families which in turn seized the power and overawed the crown. Of these the Taira clan stands pre-eminent, though much of its history is mixed up with that of its rival, the Minamoto clan. The two came first into notice in the 10th century, and quickly increased in influence and strength. It would appear indeed that the court strove to play off the one against the other, being moved by fear that the power of either might become too great. Thus, if one of the Taira rebelled, the Minamoto were authorized by the emperor to subdue him; while, if any members of the latter clan proved unruly, the Taira were only too glad to obtain an imperial commission to proceed against them. This gave rise to incessant intrigue and frequent bloodshed, ending at last, in the middle of the 12th century, in open warfare. Taira no Kiyomori was at that time the head of his clan; he was a man of unscrupulous character and unbounded ambition;

and constantly strove to secure offices at court for himself, his family, and his adherents. In 1156-59 severe fighting took place at the capital between the rival clans, each side striving to obtain possession of the person of the sovereign in order to give some colour of right to its actions. In 1159 Kiyomori eventually triumphed, and the sword of the executioner ruthlessly completed the measure of his success in the field. Nearly the whole of the Minamoto chiefs were cut off,—among them being Yoshitomo, the head of the clan. A boy named Yoritomo, the third son of Yoshitomo, was, however, spared through the intercession of Kiyomori's step-mother; and Yoshitsuné, also Yoshitomo's son by a concubine, was, with his mother and two brothers, permitted to live. Yoritomo and his half-brother Yoshitsuné were destined eventually to avenge the death of their kinsmen and completely to overthrow the Taira house, but this did not take place till thirty years later. In the meantime Kiyomori's power waxed greater and greater; he was himself appointed *daijō-daijin* ("prime minister"), and he married his daughter to the emperor Takakura, whom, in 1180, he forced to abdicate in favour of the heir-apparent, who was Kiyomori's own grandson. After raising his family to the highest pinnacle of pride and power, Kiyomori died in 1181, and retribution speedily overtook the surviving members of his clan. The once almost annihilated Minamoto clan, headed by Yoritomo, mustered their forces in the Kwantō and other eastern regions for a final attempt to recover their former influence. Marching westwards under the command of Yoshitsuné, they started on one grand series of triumphs, terminating (1185) in a crowning victory in a sea-fight off Danoura, near Shimonoséki, in the province of Chōshū. The overthrow of the Taira family was complete: the greater number perished in the battle, and many were either drowned or delivered over to the executioner. The emperor himself (Antoku, 82d of his line), then only in the seventh year of his age, was drowned, with other members of the imperial house. The Taira supremacy here came to an end, having existed during the reigns of nine emperors.

Taira supremacy.

The period of the Minamoto supremacy lasted from this time until the year 1219. Yoritomo was the leading spirit, as his sons moto Yoriyū and Sanétomo, who succeeded him in turn, did not in any way attain to special fame. Having secured himself against molestation from the Taira, Yoritomo directed his efforts systematically to the consolidation of his power in the east. Commencing from the Kwantō, he soon overawed the whole of the northern provinces, and also extended what was virtually his dominion to the westward in the direction of Kiōto. Kamakura, a town on the sea-shore in the province of Sagami, an old seat of the Minamoto family, was made his metropolis. The site of this town faces the sea, and is completely shut in on the rear by a semicircular ridge of steep hills, through which narrow cuttings or passes lead to the country beyond. Under Yoritomo Kamakura prospered and increased in size and importance; a large palace was built, barracks were erected, and it became the capital of the east of Japan. In the year 1192 the emperor Takahira (also known as Go-Toba no In) issued a decree creating Yoritomo *Sei-i-tai-shōgun* Shōgun (literally, "barbarian-subjugating generalissimo"), and despatched an imperial envoy from Kiōto to Kamakura to invest him with the office. He and each *shōgun* who came after him were thus nominated commanders-in-chief, holding the office by order of and investment from the emperor, to preserve peace and tranquillity on the eastern marches of Japan. This has given rise, in numerous works on Japan published by different authors (Dr Kaempfer among them), to the common assertion that Japan possessed two emperors,—the one "spiritual," residing at Kiōto, and the other "temporal," residing at Kamakura and afterwards at Yedo. This idea, though entirely erroneous, is not unnatural; for, although each successive *shōgun* owned allegiance to the emperor and was invested by the latter, still his own position as supreme head of the military organization of the country and his influence over the powerful territorial nobles made him *de facto* almost the equal of a sovereign in his own right. This condition of affairs continued until the revolution of 1868, when the *shōgun's* power was shattered, the military domination swept away, and the *mikado* reinstated in his early position of supreme authority. Yoritomo's two sons Yoriyū and Sanétomo were in turn invested with the office of *shōgun*; they both dwelt at Kamakura. In 1219 Sanétomo was killed by Yoriyū's son in revenge for the supposed murder of Yoriyū himself, and, as he died without issue, the main line of the Minamoto family thus came to an end.

Upon this commenced the supremacy of the Hōjō family, who had Hōjō for years been adherents of the Minamotos. The heirs of the latter family having failed, the office of *shōgun* was conferred upon different members of the illustrious house of Fujiwara, who all resided at Kamakura. The military administration, however, was invariably in the hands of the Hōjōs, who acted as regents of the *shōgun*; their supremacy lasted from 1225 to 1333, through what is commonly called the "seven generations of the Hōjō family." The Mongol event of principal importance during this period was the repulse of invasion the Mongol invasion, which occurred in the year 1281.—Kublai sion



Khan, founder of the Yuen dynasty in China, had for some years back repeatedly sent to demand submission from Japan, but, this being refused, about 10,000 of his troops attacked Tsushima and Oki in 1274. This expedition was repulsed, and some envoys despatched to Japan in 1275 and also in 1279 were decapitated by the regent, Hôjô no Tokimuné. Exasperated at this defiance, the Mongol chief collected a mighty armament, which was despatched to Japan in 1281. The numbers of this invading force are by Japanese writers estimated at no less than one hundred thousand Chinese, Mongol, and Korean troops. They descended upon the coast of Kiusiu, where several engagements were fought; eventually a severe storm destroyed and dispersed the fleet, and the Japanese taking advantage of this favourable opportunity vigorously attacked and completely annihilated the invaders, of whom but three are said to have escaped to tell the tale. It is not surprising that no further attempt to conquer Japan should have been made by the Mongols. In 1331, towards the close of the Hôjô supremacy, the succession to the crown was disputed, and from that time until 1392 there existed two courts, known as the northern and the southern; in the latter year, however, the southern dynasty (established at the town of Nara, near Kiôto) handed over the regalia to the emperor Go-Komatsu, who from that time was recognized as the legitimate *mikado*. During the period of anarchy and civil war that took place in this century, Kamakura was attacked and destroyed, in 1333, by Nitta Yoshisada, head of a family descended from the Minamoto clan: The rule of the Hôjôs was thus terminated, and by 1338 the family had well nigh disappeared.

Two courts.

Later Hôjô family.

Hidé-yoshi.

During the confusion and disturbance created by the contest between the rival courts, and also throughout the whole of the 15th century, Japan was devastated by fire and sword in civil wars of the most terrible description. Several families endeavoured in succession to acquire the supremacy, but none were able to wield it long. The dynasty of *shôgun* (the Ashikaga line) proved bad rulers, and, though the families of Nitta, Uyétsugi, and others came prominently into notice, they were unable to pacify the whole empire. In the early part of the 16th century what was termed the "later Hôjô" family arose in the Kwantô, and for "four generations" established their chief seat at the town of Odawara, in the province of Sagami, immediately to the east of the Hakoné hills. At this time, too, lived the famous generals Ota Nobunaga and Toyotomi Hidéyoshi. The latter is perhaps best known to Europeans as the Taikô Hidéyoshi, or simply as Taikô-sama, "my lord the Taikô." *Taikô*, it may here be remarked, is not a name (as commonly supposed) but a title, and signifies literally "great lord." Another common error is to speak of Hidéyoshi as the *shôgun*; he never held that office. The 16th century also saw the first persecutions directed against the native Christians; the religion had been introduced by the Portuguese in 1549, when Xavier first came to Japan. In 1586 Ota Nobunaga was assassinated, and the *taikô* succeeded him in the chief military power. In 1590 the family of the "later Hôjô" was overthrown by him, and the town of Odawara taken. Hidéyoshi then bestowed upon his general Tokugawa Iyéyasu the eight provinces of the Kwantô, at the same time directing him to take up his residence at Yedo, which was at that period a town of very small importance. Hidéyoshi died in 1594.

Tokugawa dynasty.

Iyéyasu.

Nobles.

The Tokugawa dynasty lasted from the appointment of Iyéyasu to the office of *shôgun* in 1603 until the resignation of the last *shôgun*, Yoshinobu (usually called Keiki), in 1867. This dynasty comprised fifteen generations of the family, and is undoubtedly the most important throughout the whole of Japanese history. Iyéyasu was a consummate politician as well as a successful general, and to him the powerful territorial nobles (*daimiô*) throughout the whole country speedily submitted, some from motives of personal interest, and others under compulsion after a crowning victory obtained over them by the Tokugawa chief at Sêkigahara, on the confines of the provinces of Mino and Ômi, in 1600. This famous battle completely established the supremacy of Iyéyasu, and his rule was gladly accepted by the country as putting an end to the scenes of bloodshed and anarchy from which all classes had so severely suffered for well nigh two centuries back. Under this dynasty of *shôgun* Yedo became a large and populous city, as the presence of their court gave a grand impetus to trade and manufactures of all kinds. The attendants of the *mikado* at Kiôto were the old *keugi*, or court nobles, descended from cadet branches of the imperial line; they were, as a rule, of anything but ample means, yet their rank and prestige received full recognition from all classes. The court of the *shôgun* at Yedo was, on the contrary, mainly composed of men who were more noted for their territorial possessions and influence than for ancient lineage, for skill in warlike accomplishments rather than in literature and art. This court of Yedo was formed from the territorial nobles (*daimiô*), the petty nobility of the Tokugawa clan (called *hatamoto*), and lower attendants, &c., known as *yoké-nin*. The *hatamoto* were originally no less than 80,000 in number, and were in fact the soldiers composing the victorious army of Iyéyasu and enabled by him; they resided continuously in Yedo, very rarely even visiting their country fiefs. The *daimiô*, on the other hand, were

forced to attend in Yedo only at certain stated intervals varying considerably in different cases, and spent the rest of their time at their castle-towns in the provinces,—their wives and families remaining behind in Yedo, virtually as hostages for the good behaviour of the heads of their respective clans. The feudal system was thus introduced by Iyéyasu, but he was too wary to force his yoke in a precipitate manner upon the great nobles. He gathered around him his own immediate adherents, upon whom he conferred the more important positions of trust (notably in regard to the garrisoning of a *coron* of minor strongholds around his own castle at Yedo); and as the power of his clan became more and more firmly established he was enabled more effectively to impose terms and restrictions upon the *daimiô*. It was, however, reserved for his grandson Iyémitsu (1623-1650) to complete the system thus inaugurated: by the latter the nobles were treated solely as feudal vassals, and many very stringent regulations for their guidance and direction were put into force. A similar course was adopted by the successors of Iyémitsu, and this system prevailed until the fall of the Tokugawa dynasty in 1868. Under their rule, however, Japan enjoyed the benefit of almost uninterrupted peace for more than two hundred and fifty years; and though the burden imposed by them grew in the end too heavy to be longer borne, it was only cast off after fifteen members of the clan had in turn succeeded to the chieftainship. Instead of being, as of old, one united empire acknowledging as its sovereign the *mikado* alone, Japan was now partitioned out into numerous fiefs, in many ways resembling petty kingdoms. Each fief or territory was ruled by a *han* or clan of which the *daimiô* was the chief, assisted by hereditary *karô*, or "councillors," and other officials. According to the will of each *daimiô* did the usages and rules to be observed in the respective fiefs differ. Districts actually adjacent to each other might be placed under totally opposite regulations, both as regards taxes and imposts and with respect to the paper money there in circulation. The various *han* issued notes of different denominations, for use in that one district alone, and this was done without the slightest reference to the paper currency of neighboring fiefs. The permission of the *shôgun*'s ministers at Yedo had to be obtained for the purpose, but it is beyond all doubt that large quantities of paper-money were issued by the *han*, when pressed by want of funds, without any such authority. The chief evil was that these notes were only local currency, and did not pass freely throughout the whole country; thus a person undertaking a long journey might be put to considerable inconvenience as soon as he crossed the boundary of his own clan's territory. The levying of taxes, too, afforded opportunities for frequent abuse of power: in many *han*, it is certain, taxes were collected with due regard to the condition of the peasantry, but in other instances cruel oppression and ruthless extortion were but too prevalent. This, as has already been remarked, was chiefly the case on the estates of the *hatamoto*, who enjoyed a life of ease and pleasure in Yedo, and who cared little or nothing as to the means by which their supplies were wrung from their miserable serfs. Some of the *daimiô* ruled very large territories,—often a whole province or even more; while others, again, owned an estate measuring but a few square miles. The military class, or gentry, who were entitled to wear two swords as a sign of gentle birth, formed the retainers or clansmen of the great nobles, and were recognized as the first of the "four classes" into which the whole population was divided. These classes were—(1) The military families, commonly known as the *samurai*; (2) The agricultural or farming population; (3) the artisans; and (4) the mercantile or trading class. But, though by this arrangement the peasants were placed immediately after the gentry, their lot was undoubtedly far harder than that of the artisans or traders, seeing that they were at the mercy of any capricious or tyrannical feudal noble who might be made lord over the villages in which they dwelt. There existed a small number of independent yeomen (called *gôshi*) who owned no allegiance to any chieftain; but they also were included in the second of the "four classes." The succession to the *shôgun*ate was vested in the head branch of the Tokugawa clan, but, in the event of a direct heir failing, it was determined that the dignity and office should pass to one of the three kindred clans of Mito, Ôwari, and Kishiu, or, failing these, to one of the three noble families of Tayasu, Shimidzu, and Hitotsubashi. These two lines of kinsmen of the *shôgun*'s house were termed the *go-san-ke* and the *go-san-kei* respectively. The ceremonial investiture of each *shôgun* by the *mikado* was always kept up, the latter being thus still recognized as the sovereign, although there only remained to him the title without the power. The *shôgun* was, in fact, nothing more nor less than the chief subject of the *mikado*. The chief power and the direction of political affairs were certainly in his hands, but the name of sovereign was never even assumed by him; and in point of actual rank the mighty territorial chieftains were held to be inferior to the poverty-stricken nobles of the *mikado*'s court.

Han system.

The four classes.

The earlier period of the Tokugawa supremacy was disgraced by Persecution of the native Christians. By an edict issued in 1614 by Iyéyasu (who had resigned in 1605 in favour of his son Hi-Chiridétada, but still continued to exercise administrative functions) tianâ.



Christianity was finally proscribed, a decree of expulsion was directed against the Jesuit missionaries then in Japan, and persecution raged until 1637. In that year the peasantry of a convert district in the province of Iizen, oppressed past endurance by the cruelties to which they were subjected, assembled to the number of 30,000, and fortified an old feudal castle at the town of Shimabara, declared open defiance to the Government. *Iyémitsu, who was then shōgun* (1623-1660), despatched an army against them, and after a brief but desperate struggle the Christians were all massacred. These stern measures repressed the profession of the religion, but many clung to it in secret, and several prohibitory edicts were issued throughout the 17th and 18th centuries. So lately, indeed, as 1868 these proclamations might still be seen on the public notice-boards in every village throughout the country.

**Fends of nobles.** Although the Tokugawa period was not disturbed by the warfare, expeditions or civil conflicts from which Japan had until then suffered, there nevertheless existed considerable cause of uneasiness in the numberless intrigues or petty conspiracies which prevailed among the great *han* and in the families of the feudal nobles. The question of succession to the chieftainship of a clan not unfrequently stirred up strife amongst the retainers, and in many cases the most unscrupulous means were adopted in order to obtain the desired result. Towards the close of the dynasty several conspiracies were set on foot, but these were promptly stamped out. Japan was now in seclusion from the rest of the world, the inhabitants having been forbidden to leave its shores without express permission under pain of heavy punishments; but the direction of the internal affairs of the country was a task that fully occupied the ruling house. The jealousy and private feuds of the *daimiō* increased to such an extent that on several occasions even the sacred precincts of the *shōgun's* palace became the scene of quarrel and bloodshed. The great nobles gradually rebelled more and more against the rule of enforced restrictions imposed upon them by a lord who was virtually but one of their own class; while to the peasants the feudal system was in most cases exceedingly distasteful. Reaction against the military domination thus set in, and men's eyes naturally turned towards the renewal of the ancient régime when the *mikado* was the sole sovereign, before whose authority every subject, whether gentle or simple, bowed in submission. These, among other causes, gradually led to the revolution of 1868, by which the *mikado's* power was restored. In the meantime, since 1858, treaties had been made by the *shōgun's* ministers with several of the foreign powers, and the foreign element had thus been introduced into Japanese political affairs. By some writers undue stress has been laid upon this fact, as if the advent of Western nations had been the main cause of the downfall of the Tokugawa supremacy. From an attentive perusal, however, of native works treating of political matters for some time previous, it would appear that such was not the case. The decay of the shōgunate had gradually

**Appearance of foreigners.** been going on for years back; the whole system was tottering to its fall, and it is not improbable that even in the total absence of foreigners the revolution would have occurred exactly as it did. The *shōgun* was declared a usurper, and the great clans of Satsuma, Chōshū, and Tosa warmly espoused the cause of the *mikado*. The Tokugawa clan did not present any very determined front, and the struggle was exceedingly brief. Some fighting, did, however, take place in the vicinity of Kiōto, and also at various points around Yedo; but the most severe conflict was the siege of the castle of Wakamatsu, in Ōshū. This castle was the stronghold of the powerful northern *daimiō* of Aizu, a partisan of the shōgunate; his troops offered a stout resistance, but the place was eventually taken by the *mikado's* army after a siege of some two months' duration. The *shōgun* himself had resigned in 1867, and this virtually settled the question in favour of the emperor's army, although some desultory fighting occurred both at Yedo and near Hakodaté two years afterwards. In 1869 the official name of Yedo was changed to Tokiō (the "eastern capital"), and the *mikado* retired to the town of Shidzuoka, in the province of Suruga, where he still lives in retirement, his only title being that of a noble of the empire. The ancient form of government was thus restored, and the feudal system is now a thing of the past.

**Decay of shōgunate.** Since this revolution Japan has become tolerably well known to Europeans. Although her relations with foreign countries were never of any very great importance, they nevertheless commenced at an early date. Allusion has already been made to early Chinese and Korean arrivals in Japan. Dr Kaempfer asserts that in later times young Chinese of good family constantly came to Nagasaki on pleasure excursions. In 201 A.D. the empress Jingō invaded Corea, and gained several victories over the troops that opposed her; and on her return she introduced into Japan the Korean arrangement of geographical division. The Japanese being a maritime nation, it is not surprising that, prior to the edict forbidding them to leave their country, they should have extended their voyages throughout the whole of the Eastern seas. We read of their visiting China, Siam, and India; indeed at one time

**Foreign relations** there existed a Japanese colony or settlement at Coahuila. It is known that vessels sailed from Japan to the western coast of Mexico. The Mongol invasion in 1281 has been already noticed. In the 16th century Europeans approached the shores of Japan. As early as 1542 Portuguese trading vessels began to visit the empire, and a system of trade by means of barter was carried on. Seven years later three Portuguese missionaries, Xavier, Torres, and Fernandez, took passage in one of these merchant ships, and landed at Kagoshima in Satsuma. The island of Hirado off the coast of Iizumi appears to have been then the rendezvous of trade between the two nations. From that time commercial relations continued until the Portuguese were expelled the country in 1639. A second expedition against Corea was undertaken by the *taikō* Hidēyoshi in 1592; the Japanese troops not only withdrawn till 1598, and it is interesting to note that a number of Coreans were then brought over to Japan, where they practised the art of making pottery. Descendants of these Coreans still occupy a village in the province of Satsuma. Towards the end of the 16th century Spanish vessels visited Japan, and in 1602 an embassy was despatched by Iyeyasu to the Philippines; but the relations between the two nations were never very close. The Dutch first arrived in 1610, and from that date down to the close of the Tokugawa dynasty they enjoyed almost a monopoly of the Japanese trade. They at first settled in the island of Hirado, but afterwards removed to Nagasaki, where they were virtually imprisoned in their factory on the small peninsula of Deshima in the harbour, connected by narrow causeways with the town itself. Dr Kaempfer's *History of Japan* gives a full and graphic description of the mode of life of the early Dutch settlers; he himself dwelt in Japan during the rule of Tsunayoshi, the fifth *shōgun* of the house of Tokugawa, 1680-1709. The first Englishman who visited the shores of Japan was William Adams, a Kentish man, who came out to the East as pilot to a Dutch vessel. He lived in the city of Yedo for a considerable time in the opening years of the 17th century, during which period he is stated to have frequently been at the court of Iyeyasu. He instructed the Japanese in the art of shipbuilding, and the title of *hatsunoto* was conferred upon him. In 1613 Captain Saris succeeded in founding an English factory in Hirado, but it did not exist for any length of time. Finally, in 1854, Commodore Perry's expedition from America took place, when a quasi treaty was made between him and the ministers of the shōgunate at Uraga, on the Bay of Yedo; and later in the same year Admiral Stirling concluded a similar negotiation, at Nagasaki, on behalf of Great Britain. In 1858 these treaties were extended, and others were concluded with the Dutch and French, under which the ports of Nagasaki, Hakodaté, and Kanagawa (now known as Yokohama) were thrown open to foreign traders belonging to those nationalities, from the year 1859. Other European powers gradually followed the example, and at the present moment Japan is in treaty with no less than eighteen nations, viz., Austria-Hungary, Belgium, China, Italy, Peru, Portugal, Russia, Spain, Sweden, Switzerland, and the United States. Prior to the recent revolution the foreign treaties were concluded with the ministers of the *shōgun*, at Yedo, under the erroneous impression that he was the emperor of Japan. The title of *taikun* (often misspelt *tycoon*) was then for the first time used; it means literally the "great ruler," and was employed for the occasion by the Tokugawa officials to convey the impression that their chief was in reality the lord paramount. It is, however, worthy of note that even in these earlier treaties the title corresponding to "His Majesty" was never assumed by the *shōgun*. The actual position of this official remained unknown to the foreign envoys until 1868, when the British, Dutch, and French ministers proceeded to Kiōto, and there obtained from the *mikado* his formal ratification of the treaties already concluded with his powerful subject. Since that time all treaties with Western powers are made out in the name of the emperor of Japan. It was thus that the foreigners came prominently into notice at the time of the revolution, with which, however, beyond this they had really no connexion.

In 1873-4 Japan sent an expedition against the aboriginal tribes Formosa inhabiting the island of Formosa, off the eastern coast of China, to expel them. The demand satisfaction for the murder, some years before, of certain Japanese subjects who had been shipwrecked on that island. Some skirmishing took place, in which the Japanese gained the advantage. The most important point in the whole matter was the negotiation with China. Formosa is Chinese territory, but the Japanese contended that, if the Chinese Government would not exact reparation from the aboriginal tribes, they would themselves attack the latter. This they did, and, although at one period it appeared highly probable that war would be declared between China and Japan, the matter was eventually settled amicably, China paying a sum as indemnity for the outrages complained of. Towards the end of Corea 1875 a dispute arose with Corea, a Japanese gubcoat having been fired on from a shore fort while engaged in surveying operations close by the Korean capital. The gubcoat returned the fire, and landed a party of men, who attacked and destroyed the fort and stockades, and seized upon the weapons &c., found in it. Some



diplomatic negotiations ensued, by which the matter was settled peaceably, and on February 27, 1876, a treaty was concluded in Corea, by two Japanese high commissioners despatched for that purpose. Japanese officials and traders now reside in Corea on precisely the same terms as those on which foreigners have dwelt at the open ports in Japan since 1858.

It could not, of course, be expected that the numerous reforms and changes introduced by the present Government would all be accepted without murmur by the people. Riots have of late years occurred in different parts of the country among the farming classes; and outbreaks of a yet more serious character have been stirred up among the *shizoku*. The latter took place chiefly in the western provinces, but were soon quelled. The only one of real magnitude was the insurrection in Satsuma, which broke out in the spring of 1877. Excited by various seditious cries, over 10,000 insurgents collected together and marched in a body northwards from Kagoshima. Their avowed object was to make certain representations to the emperor in person. Delaying in their advance to attack the Government garrison stationed in the castle-town of Kumamoto, in Higo, the rebels allowed time for large bodies of troops to be despatched against them from Tōkiō. The scene of action was thus confined to the island of Kjusin, and after severe fighting, which lasted for several months, the rebels were annihilated, their leaders either dying on the field or committing suicide. This deplorable attempt was, however, useful inasmuch as it proved the strength of the Government; and in view of its complete failure it would seem unlikely that any effort of a similar nature should be made in future. The restoration of the ancient régime has united and strengthened the empire, instead of letting it remain broken up into numberless petty territories, each unlike its neighbours, as was the case under the old feudal system.

LANGUAGE.

The Japanese language is by some philologists thought to have an affinity with the Aryan family; but, as the points of resemblance are very slight and the differences exceedingly great, it is evident that, if there be any affinity at all, the divergence must have taken place at a period when the common ancestor of the Japanese and Aryan tongues was a language exceedingly rude and undeveloped. Nor has any relationship been clearly established with any other language of Asia. Japanese thus stands, as it were, by itself, and must be regarded as an almost entirely separate tongue.

Japanese may be considered under the two distinct heads of the spoken and the written languages; the former is the ordinary colloquial, and the latter the more classical style,—of late years to a great degree mixed up with Chinese. According to native historians, the study of the Chinese classics was introduced in 285 A.D.; but this assertion may certainly be questioned, and it seems probable that the actual date was considerably later. At the present day, however, the Chinese characters occupy by far the most important place in the Japanese style of writing.

The Japanese *kanji*, or syllabary, consists of forty-seven syllables, viz.; *i, ro, ha, ni, ho, he, to, chi, ri, nu, ru, vo, ita, ka, yo, ta, re, wa, tsu, ne, na, ra, nu, u, i, no, o, ku, ya, ma, ke, fu, ko, ye, te, a, u, ki, yū, me, ni, shi, ye, hi, mo, se, su*,—to which may be added *n* final. The following modifications of some of these syllables increase the number to seventy-two:—*h* and *f* sometimes become *b* or *p*; *t* may be modified to *d, ts* to *dz, s* to *z, sh* and *ch* to *j*, and *k* to *g*. This change is called in Japanese the *nigori*

<i>a</i>	is pronounced like <i>a</i> in father.
<i>e</i>	" " " <i>ay</i> " say.
<i>i</i>	" " " <i>ee</i> " meet.
<i>o</i>	" " " <i>o</i> " more.
<i>u</i>	" " " <i>oo</i> " fool.

*I* and *u* are frequently almost inaudible; in such cases they have been written *i, ū*. A final *u*, in particular, is very seldom sounded in full. The distinction between long and short vowels, and single and double consonants, demands careful attention, as the meaning often depends upon it. Long vowels generally represent the contraction of two others; thus *au* or *ou* becomes in sound *ō, ii* becomes *ī*, and so on. The consonants are pronounced as in English, with the exception of *r, h, f, n, d, t, and g*, which differ somewhat from the corresponding English sounds. The true pronunciation of these letters must be learned from a Japanese. In the case of double consonants, both must be sounded.

In writing there is a character for each of the forty-seven syllables given above; and each character may be written in either the *katakana* or the *hiragana* style. The former is the "square" hand, consisting in each case of a portion of the particular Chinese character whose sound (to the Japanese ear) is most clearly imitated by the sound of the Japanese syllable in question; the latter is the cursive or "running" hand, adapted from the *katakana* characters, and having several varying styles. Except by the lower and uneducated classes, these written syllabaries are seldom used in writing letters, &c., unless as mere terminations to be taken in connection with a Chinese character immediately preceding, as,

for instance, to mark the tense of a verb, &c. As in writing the pure Chinese characters, in the letters of the educated class, the "square" and "running" hands are also used, the syllable characters attached are also, according to circumstances, usually written in the *katakana* or the *hiragana* for the sake of appearance.

The spoken language may be classified under the heads of noun, Spoken and particles, pronoun, adjective, verb, adverb, preposition, conjunction, and interjection. There is also a distinct class of numerals.

The nouns have no inflexions to distinguish gender, number, or case, but they are preceded or followed by particles which serve these and other purposes. Except in the case of a few common words, no distinction is made between the masculine and the feminine; when necessary, however, there may be used the prefix *o* or *on* for the former, and *me* or *men* for the latter. The neuter has no prefix at all. In general there is no mark of the plural, but whenever necessary the plural idea may be expressed by the addition of *ra, gata, dono, tochi*, or other particles; a few nouns, again, have a kind of plural formed by a repetition of the noun itself. Compound nouns are formed in various ways, the first letter of the second part of such compounds generally changing in sound by the *nigori* already noted.

The personal pronoun does not demand much attention, except as regards that of the second person. Here the word used is different according to the rank or condition of the person or persona addressed. This idea of "honorific" terms is also to be noted in the use of verbs. As a rule, there are three modes of address,—to superiors, to equals and friends, and to inferiors. The plural of personal pronouns is often formed by the addition of the plural particles noticed under the heading of nouns. The personal pronoun is not to be used too frequently in speaking; as a rule, it is not employed by natives except where its omission might cause ambiguity. Possessive pronouns are virtually personal pronouns, with the addition of the possessive particles *no* or *ya*. Demonstrative and interrogative pronouns also exist; by the addition of certain particles to the former, the indefinite pronoun is formed. There are but few reflective pronouns, and the relative pronoun does not exist. To express that idea, however, the verb of the relative clause is put before the word to which the relative pronoun refers.

The adjective may be declined,—the chief part being what may be termed the root, from which (by the addition of certain syllables) various other forms (including the adverb) are obtained. The Japanese adjective has no degrees of comparison, but an idea of comparison can be expressed by the use of certain particles and by turning the sentence in a peculiar way. Many nouns do duty as adjectives, and are often considered such.

The verb has no means of expressing the distinctions of number or person. In the spoken language there are two conjugations of verbs, in each of which there are four principal parts, viz., the root, the base for negative and future forms, the present indicative, and the base for conditional forms. To each of the principal parts of the verb a number of particles or terminations are annexed; and in this way there are produced forms somewhat similar to the moods and tenses of European grammars. There are, however, a few irregular verbs, in the conjugation of which slight differences are to be noticed. The conjunctions and the interjections are but few in number, and do not call for any special remark.

In a sentence the first place is occupied by the nominative case, the second by the objective or other cases, and the last by the verb. The adjective precedes the noun, and the adverb the verb. Prepositions are placed after the nouns to which they refer. Conjunctions and interrogative particles are placed at the end of the clause or sentence to which they belong.

The above parts of speech are also to be found in use in the written language. Here, however, there is to be noticed a great difference in the inflexions, which are in most cases totally distinct from those used in the ordinary colloquial. Many old expressions and words that have fallen into disuse in conversation are here still retained, and the written language is by far the more classical of the two.

In the writing hand at present in use Chinese characters predominate. In official documents, despatches, &c., the square character is commonly used, generally with *katakana* terminations. In ordinary letter-writing the cursive hand, more or less abbreviated, is employed, being supplemented, when required, by the *hiragana*. The characters, though identical with those used in China, are arranged in different order, so much so that, though the general meaning and sense of a Japanese document might be intelligible to a Chinese, the latter would scarcely be able to give an exact rendering of it. The sounds of the characters are also in most cases entirely different, the Japanese reading them by what is to them the nearest approach to the true Chinese pronunciation. Thus, a final

<sup>1</sup> The student is referred to the *Grammar of the Japanese Spoken Language* by W. G. Aston, M.A., London 1873, from which work the above notes have been compiled.

<sup>2</sup> The student is referred to the *Grammar of the Japanese Written Language*, by W. G. Aston.



Foreign words.

ng preceded by a vowel in Chinese is generally rendered in Japanese reading by a long *o*, while an initial *h* is not unfrequently changed into *k*. Of late years, since the restoration, there has come into prominent notice an ever-increasing tendency to introduce into ordinary conversation numerous Chinese words that had in many cases been never heard before that time. This style is, of course, affected chiefly by men of letters and by officials, and several successive editions of small dictionaries containing these newly introduced expressions alone have been published at intervals; the increase in bulk of the last edition as compared with the first is very perceptible. A rather stilted style of address has always found favour with the military and literary class; the personal pronoun of the second person being usually rendered by the word *sensei*, "teacher," or *kimi*, "lord." Intercourse with foreign countries and has of late years naturally created a demand for certain words and phrases hitherto unnecessary and consequently unknown, and these have therefore been freshly coined as if were for the occasion. It is worthy of remark that certain European words have for years been in such common use as to be now deemed actually Japanese. Among these may be mentioned the following:—

*Pan*, bread, derived from the Latin, through the Spanish or Italian.  
*Kasutera*, a kind of sponge-cake, an adaptation from the Spanish (Castile).  
*Tabako*, tobacco.  
*Dontaku*, Sunday, derived from the Dutch.

The English words "minute," "second" (of time), "ton," "electric," &c., are now freely used, the pronunciation being only slightly at fault. Several Malay expressions have also from time to time crept into use; but these are as a rule heard only among the lower classes at the treaty ports.

Dialects

Although differences of dialect are distinctly apparent in various localities, these are not by any means so marked as is the case in China. As a rule, a man speaking the pure Yedo dialect might travel through nearly the whole of Japan without experiencing any considerable difficulty; his words would generally be fully understood, though he might now and again be unable to catch the true meaning of the answers he received. In the capital a slight *n* sound is given before the consonant *g*, making it almost *ng*; and in the case of an initial *h*, a slight sibilant is plainly perceptible, giving almost the sound of *sh*. The interjection *né* is often heard in the vulgar Yedo dialect; it has no meaning, is little used by men, and serves merely to draw the attention of the person addressed. In the north this *né* is changed to *na*, and in other parts of Japan to *no*. In most of the northern provinces, and also in the far west, a series of aspirate sounds take almost an initial *f* instead of *h*; it is thus apparent, for instance, why the name of the large island off the coast of Hiizen is so often termed *Furando* instead of its true name *Hirado*. A nasal intonation is very noticeable in the neighbourhood of other northern districts, particularly in the neighbourhood of Sendai, and this is also heard in the Osaka dialect. In Osaka and its vicinity, too, the Yedo *né* is rendered by the exclamation *sakai*; at Kiôto, as might be expected, many of the older forms of expression prevail. The Satsuma dialect presents, perhaps, the greatest difficulty: the letter *r*, particularly at the commencement of a word, is replaced by a very decided *j*, and there is a strong tendency to clip off final vowels in all words. This dialect possesses, too, many words peculiar to its own province, so much so indeed that a conversation carried on between two Satsuma men is often all but unintelligible to a native of Tôkiô, although the latter might be able to make himself understood by either of the others. In many country districts also a *patois* is used known only to the peasants, and presenting great difficulty to any Japanese of the better class who comes from a different locality. Even in cases where the word or expression itself is identical, a peculiar intonation or pronunciation so completely disguises it as to convey the impression that it is totally different.

Dictionaries.

Reading and writing are often almost unknown in remote districts, and the abstruse Chinese characters are beyond the knowledge of the ordinary Japanese peasant. Some few of the easier characters are used, and the *kana* supplies the place of the rest; on most of the Government notice boards, &c., and also in the newspapers published for the express benefit of the lower classes, the reading of any Chinese characters used is generally added at the side in the *kana*. It is only among the better-educated ranks that the Chinese writing is well understood and in common use. The dictionaries used are arranged after the Chinese style, each character being looked out, according to the number of radicals contained in it, under its proper radical. The list of radicals is the same as in China, and they are always printed in regular index form at the commencement of the dictionary. At the side of each character in the work is placed the Japanese attempt at the rendering of the true Chinese sound, and underneath is given the meaning in Japanese colloquial. There are special dictionaries for the running hand. This style consists of the ordinary cursive hand, which is not as a rule very unlike the square hand, and also of what is termed the "grass" hand, which is very much abbreviated and exceedingly difficult to acquire. Unless the square hand of a particular "grass" character be known it is often wholly impossible to look it up in a

dictionary. The pens and ink used in writing are precisely the same as the Chinese; the lines of writing are perpendicular, and are read material downwards, commencing with the column to the extreme right of and the volumes end. The beginning of a Japanese book is thus where our usages. The paper used for letters is thin, and in rolls, the written part being torn off when the note is finished; for official despatches large ruled sheets of superior paper are now in fashion. The signature of the writer is always placed at the foot of the page, while the name of the person addressed is written near the top, with the same honorific title appended to it. Whenever the title of the sovereign occurs in an official document, it is either placed as the first character in a fresh column, or else a small space, generally of size sufficient to contain one character, is left vacant immediately above it. In a letter numerous honorifics are used, and these serve to distinguish the second person; in speaking of himself the writer omits these, and sometimes also writes the characters in a rather smaller hand and slightly towards the side of the column instead of in the centre. This is of course done in affectation of humility, and is a truly Asiatic idea. The honorific expressions applied only to the *mikado* himself would suffice to compose a small glossary; some of these are exceedingly flowery, as, for instance, the "Phoenix Car," the "Dragon Chariot," the "Jewelled Throne," &c.

The language of the Aino tribes in the island of Yezo is totally Aino. There does not as yet exist any satisfactory dictionary to throw light upon it, and it can now only be regarded as a kind of local *patois*, intelligible to the Ainos alone. Whether this be the descendant of the most ancient form of speech amongst the inhabitants of Japan, it is impossible to conjecture. It does not in sound resemble pure Japanese, being guttural, and spoken in a much lower key.

The natives of the Rinkiu group also possess a language of their own, but this does not differ in any great degree from Japanese. Many of the persons of the better classes speak Japanese with perfect correctness, and it is also stated that the higher officials are acquainted with the court dialect of China. The Rinkiu tongue may be described as nothing more than a very strongly marked dialect of Japanese, and in it there are still preserved many words long since obsolete in Japan itself. In writing, the Chinese characters are chiefly used.<sup>1</sup>

## LITERATURE.

Literature in Japan has of late years received far more attention and careful study than in ancient times, if we are to judge by the multitude of recently published books as compared with those existing even less than a century ago. The introduction of printing presses with movable type has no doubt been the principal cause of this; wooden blocks were in use far earlier, but it was a work of great labour to prepare them; and, as only a certain number of copies could be struck from them, in the case of any work much sought after the demand very soon exceeded the supply. As many of the old manuscripts have been set up in type and published in the modern style, there is no great difficulty in procuring specimens of the ancient literature.

In the earliest times Kiôto was the principal if not almost the only seat of learning and literature in Japan. Intermittent wars and feuds kept the inhabitants of the eastern portion of the empire too fully occupied with military affairs to allow of their being able to engage in more learned and peaceful pursuits, even had they so wished. The court of the *mikado* at Kiôto enjoyed a far more tranquil existence, and the nobles composing that court devoted themselves with zest to literary pursuits. Poetry was by them held in high honour, and received perhaps the greater share of their attention; but the writing of diaries seems also to have been a favourite occupation, and examples of these, still extant, afford a very interesting insight into the mode of life then prevalent at the court and in the neighbourhood of Kiôto.

The ancient literature of Japan contains but few works of a popular character. Almost everything then composed that is still extant was written by and for the members of the learned circle around the court, and was thus exclusively adapted to the minds of the well-read and highly educated class. Later on, in the 10th century, when the learned were devoted chiefly to the study of Chinese, the cultivation of the Japanese language was in a great measure abandoned to the ladies of the court. A very large portion of the best writings of the best age of Japanese literature was the work of women; and the names of numerous poetesses and authoresses are quoted with admiration even at the present time.

<sup>1</sup> The scientific study of Japanese in Europe is of comparatively modern date. The chief names associated with it are Franz von Siebold, J. Hoffmann, Léon de Rosny, and Pfizmaier. Among Léon de Rosny's works may be mentioned *Introduction à l'étude de la langue japonaise* (1857), *Manuel de la lecture japonaise* (1859), *Recueil de textes japonais* (1869), *Cours de japonais* (1869), *Dictionnaire japonais-français-anglais* (Paris, 1875). Pfizmaier is the author of a *Japanese-German-English Dictionary* (Vienna, 1851), of a *Japanese chrestomathy* (Vienna, 1847), *Untersuchungen über den Bau der Aino Sprache* (1852), &c., and has published a variety of critical papers and Japanese texts in the *Sitzungsberichte* of the Vienna Academy. English workers in Japanese are E. Satow, Aston, Chamberlain, Alcock, Hepburn.



The earliest of the extant Japanese records is a work entitled *The Kojiki*, or "Record of Ancient Matters," commonly asserted to date from the year 711. Prior to that time, in 620 and again in 631, two other works treating of ancient Japanese history are said to have been compiled, but neither has been preserved. The emperor Temmu (673-686 A.D.), according to the preface to the *Kojiki*, resolved to take measures to preserve the true traditions from oblivion, and he therefore had all the records then existing carefully examined, compared, and purged of their faults. Their contents were then committed to memory by a person in the imperial household, named Hiyeda no Are. Before this record could be reduced to writing, the emperor died, and for twenty-five years Are's memory was the sole depository of what afterwards became the *Kojiki*. At the end of this interval the empress Gemmei (708-715) commanded one of her ministers to write it down from the mouth of Are, and the work was thus completed at the end of the year 711. Soon after this, in 720, another work was completed entitled the *Nihongi*, or "Japanese Record," which is said to have so far superseded the *Kojiki* that the latter was almost forgotten. The *Nihongi*, like the *Kojiki*, appeared during the reign of an empress (Genshō, 715-723), and the yet earlier work of the year 620 was commenced under the auspices of the empress Suiko (593-623); the person called Are is also by some supposed to have been a woman. The *Kojiki* is to be found numerous traces of direct Chinese influence: the chief object of the one was to preserve the form and spirit of Japanese antiquity, while the other rather fell in with the growing adoption of Chinese ideas. Both works may be described as ancient histories, purporting to commence from the "divine age" and the very origin of all things, and replete with allusions to Japanese cosmogony and legends of antiquity; they are held to be the chief exponents of the *Shintō* faith, or "way of the gods." They formed a basis for many subsequent works of almost similar style, and were the subject of numerous commentaries. Of these latter writings the one demanding special mention is the *Kojiki-den*, an edition of the *Kojiki* with an elaborate commentary by a renowned scholar named Motoori Norinaga, who lived during the 18th century. It was commenced in 1764, but the first part was not completed until 1786; the second was finished in 1792, and the concluding portion in 1796. The printing of this great work was begun in 1789, and concluded in 1822, Motoori himself having died in 1801.

Farthest among the later Japanese historical works is the *Daini-bonshi*, or "History of Great Japan," in two hundred and forty books. This was composed under the direction of one of Iyeyasu's grandsons, the famous second lord of Mito (1622-1700), commonly known as Mito no Kōmon sama. This illustrious noble was a noted patron of literature, and collected a vast library by purchasing old books from various temples or shrines and from the people. At the old castle-town of Mito (in the province of Hitachi) there are still pointed out the ruins of this noble's library buildings, situated for greater safety within the castle moat, hard by the palace. Tradition says that among the numerous scholars who aided the lord of Mito in compiling the *Daini-bonshi* there were several learned Chinese who had fled to Japan from the tyranny of their Manchu conquerors. This book is the standard history of Japan to the present day, and all subsequent writers on the same subject have taken it as their guide. Of all the succeeding histories the most worthy of note is the *Nihon Gwaishi*, or "External History of Japan," by an author named Rai Sanyō (born 1780, died 1832), who also composed several other works, all of them in classical Chinese. The *Gwaishi* is the most widely read, and forms the chief source from which Japanese men of education derive their knowledge of the history of their own country. It was first published in 1827, and numbers twenty-two volumes; the author was occupied for no less than twenty years in its composition; and he appends a list of two hundred and fifty-nine Japanese and Chinese works from which he drew his materials. The book treats, in order, of the great families that held supremacy after the commencement of the military domination and the decadence of the *mikado's* authority, and thus introduces the reader to the Taira, Minamoto, Hōjō, Kusunoki, Nitta, Ashikaga, later Hōjō, Takeda, Uyesugi, Mori, Ota, Toyotomi, and Tokugawa houses. Many of these sections are necessarily very short, as they treat of only one or perhaps two generations, but the records of the chief clans are of considerable length. The writer invariably identifies himself with the particular family in each case, and thus the transactions of two or more factions who strove together for the supreme power at certain epochs have to be detailed twice or even thrice, each time from a different point of view and with varied colouring. The whole period thus rehearsed extends from the middle of the 12th century to the beginning of the 18th. Many other historical works exist, written in less learned style, and adapted for popular reading and the instruction of young students. The *Gempei Seisuiiki*, or "Record of the Rise and Fall of the Gen and Hei," is a noteworthy specimen

of its class; it treats only of the two rival clans of Minamoto and Taira, and of the deeds and feats of arms performed by the heroes on both sides. Most of these popular histories are illustrated by woodcuts, in many cases taken from portraits, &c., in ancient scrolls or paintings.

Poetry having always been a favourite study, it is not surprising that there should exist numerous volumes of verses either written or collected by the old court nobles. Of these the most ancient is the *Manyōshū*, or "Collection of a Myriad Leaves," which dates probably from early in the 8th century. But this work, notwithstanding its great antiquity, is perhaps less familiar to the Japanese than the *Hakuninshū*, or "Collection of One Hundred Persons," which appeared considerably later, and includes some pieces written by emperors themselves. This was followed by almost numberless minor volumes of the same kind. Verse-making attained to such favour that it was a usual custom for one of the nobles to invite together several of his friends noted for their scholarship, solely for the purpose of passing away the time in this occupation. The collections thus obtained were either kept in the original manuscript or printed for convenience. The verses were in nearly all cases in the style known as *uta*, which may be described as the purer Japanese ode as opposed to the *shi*, or style of Chinese poetry introduced in later years, and much affected by men of learning. The *uta* usually consists of thirty-one syllables, the arrangement being in what may be called 5 lines, containing 5, 7, 5, 7, and 7 syllables respectively. The meaning is continuous, though there is often a slight break at the end of the third line, what follows being in antithesis to what has gone before, or a fresh simile with identical meaning but a varied expression. Thus if the position of the two portions of the whole *uta* be reversed, the meaning is generally in no way altered. Each *uta* is complete in itself, and expresses one single idea. The Japanese do not possess any great epics, or any didactic poems, though some of their lyrics are happy examples of quaint ways of thought and modes of expression. It is, however, a hard task to translate them into a foreign tongue with any hope of giving an exact rendering of the allusions contained in the original. The *uta* are often inscribed on long strips of variegated paper; and it is even now a common practice, when offering a present, to send with it a verse composed for the occasion by the donor. Again, even down to very recent times, when a man had determined to commit suicide, or was about to hazard his life in some dangerous enterprise, it was by no means uncommon for him to compose and leave behind him a verse descriptive of his intention and of the motive urging him to the deed. It is stated in Japanese histories that Sanetomo, the third and last shōgun of the Minamoto house, was so extravagantly fond of poetry that any criminal could escape punishment by offering him a stanza.

Probably the largest section of Japanese literature is that treating of the local geography of the country itself. The works on geography, this subject are exceedingly numerous, and include guide-books, itineraries, maps and plans, notes on celebrated localities, &c. In most cases only one particular province or neighbourhood forms the subject of the one book, but as very minute details are usually given these works are often of considerable length. Every province in Japan possesses many scenes of historic interest, and can boast of ancient temples, monuments, and other memorials of the past (this is especially the case in those lying immediately around Kiōto or Tōkiō); and it is to preserve and hand down the old traditions relating to them that these guides to celebrated localities have been compiled. They have much resemblance to the county histories in England. Although mainly geographical, they contain no inconsiderable store of historical information, which, as a rule, is printed at the head of each section. The traveller can thus ascertain without difficulty the names of the principal villages, rivers, hills, &c., and can decide what temples, shrines, or monuments along his route are worthy of a visit. Inns, ferries, lodging-houses, &c., receive particular attention. The Japanese maps are not, as a whole, very correct; the greater part are struck from wooden blocks, copper-plate engraving having been but lately introduced. Many of the sheets are coloured. The roads are laid down with some degree of care, and distinctive marks are allotted to the former castle-towns, the post-towns, and the minor villages; the distance from one town to its nearest neighbour is usually added in small characters along the line indicating the road. Very few maps include the whole of the country; most of them show only a few provinces, and some consist of a series of engravings, each plate being devoted to a single province. Plans of all the cities and of the larger towns are easily procured, and these are drawn for the most part very correctly; there are also road-books of the chief highways showing simply the towns, rivers, &c., along the route in question, much used by travellers in the interior.

There are not many works on art, though there have been published several collections of engravings from drawings by famous Japanese painters. Of late years, however, some slight impetus has been given to this branch of literature, and many of the older

<sup>1</sup> See a most interesting paper entitled "The Revival of Pure Shintō," by E. Satou, in the *Transactions of the Asiatic Society of Japan*, vol. III, 1874-5.

<sup>2</sup> See the masterly treatise on this subject, entitled *Classical Poetry of the Japanese*, by E. H. Chamberlain, London, 1880.



editions have been reprinted. Some works on ancient pottery and other antiquities have also appeared.

## Drama.

The drama does not hold in Japan the position it enjoys in European countries. No classic author such as Shakespeare was ever known, and the pieces represented on the stage are as a rule of a popular character. The style of these plays is often rather stilted, a large number of ancient and almost obsolete words and expressions being used; but the ordinary farces and light pieces are in the everyday colloquial. Theatre-going is a favourite amusement, especially among the lower classes in the larger towns.

## News-papers.

The growth of the newspaper press during the past few years deserves special attention. At the period of the recent revolution there existed but one publication that could be properly classed under this head,—the so-called "Government Gazette," which was read only by the official class, for whom alone its contents possessed any interest. But since then so many newspapers have come into existence that the list for the whole country now comprises several hundreds. In the chief cities they are issued daily, in country districts every two or three days or only once a week. The Tōkiō papers have the widest circulation, and are forwarded even to the most remote post-towns. Among these the *Nichi-nichi Shimbun* ("Daily News"), the *Chōya Shimbun* ("Court and Country News"), and the *Hōchi Shimbun* ("Information News") are perhaps the best known; the first-named is a semi-official organ. These journals appear on every day except holidays. They are all similar in style: the first page contains Government notifications and a leading article, the second miscellaneous items of information, and the third contributed articles, sometimes of a political but oftener of a popular or satirical character, while the fourth page is devoted to advertisements. The papers are chiefly printed from movable metal type. The style of composition is principally Chinese, interspersed with *kana* at intervals; but the papers published for the express benefit of the very low classes are almost entirely in *kana*, and are in many cases illustrated by rough woodcuts. Freedom of the press is as yet unknown, and many an editor has been fined or imprisoned for publishing what was deemed by the officials an infraction of the press laws recently notified. These laws are in some respects very stringent, and the newspaper press is in no slight degree trammelled by them. Before a paper is started, a petition requesting the permission of Government must be sent in, and a promise made that if such permission be granted the press laws shall be strictly obeyed. The paper, once it is started, is under the supervision of the local officials, and whatever they may deem to be a contravention of the laws in question is punished by fine, imprisonment, or suspension or total abolition of the offending journal. It is needless to point out that under this system anything like free and open criticism of the proceedings of Government is well nigh impossible, although ingenious plans have been contrived, whereby, though keeping within the actual letter of the law, the editor can proclaim his true views on the subject under discussion. A very common method is to draw a satirical picture of Japan under the name of some other country. The bonds imposed by the Government are felt to be galling, and perfect freedom of the press would be hailed with delight by the exceedingly large and influential class interested in the maintenance and publication of this kind of literature.

## Novels.

Another large section consists of romances or novels, some of considerable length. In many instances the fiction is woven in with a certain degree of historical fact, as, for instance, in following the supposed adventures of some noble's retainer, during one of the campaigns of the mediæval civil wars. In these, as in European works of the same description, the reader is generally introduced to a hero and heroine, whose thrilling adventures are described in graphic terms. Pretty little fairy-tales also abound, and short story-books with small woodcuts fill every bookstall in the streets. Many of these are entirely written in *kana*, and, the prices being very moderate, they are within the reach of even the lowest classes. Unfortunately, hardly any of these popular works would bear translation into a foreign language. Children's toy books, illustrated with large and gaudy pictures in colours, and representing chiefly the warlike heroes of ancient days or the noted actors of modern times, complete the final section of the very interesting literature of Japan. (T. M'C.)

## ART.

The range of Japanese art, its origin, and its progress, in connexion with some of its most characteristic features, cannot fail to interest all true lovers of art, especially as applied to industries and manufactures. In this latter category should be placed all those applications of art "in the vast and diversified region of human life and action," to quote Mr Gladstone's words, "where a distinct purpose of utility is pursued, and where the instrument employed aspires to an outward form of beauty,"—in which consists "the great mass and substance of the *Kunst-Leben*, the art-life of a people." As it is within these limits that art has taken its chief development in Japan it is in this respect more especially that some account will be given here of its leading characters and principles.

If art in its application to purposes of utility may be taken as the first stage in all countries towards the higher art more especially appealing to the imaginative and intellectual faculties, the degree of perfection attained by any nation in this first *Kunst-Leben* must be taken into account in judging of their artistic power and capabilities. Viewed in this light, it is not too much to say that no nation in ancient or modern times has been richer in *Art-motifs* and original types than the Japanese. They undoubtedly have the merit of having created one of the few original schools of decorative art handed down to us from past ages,—a school uninfluenced by any foreign admixture, if we except the first rudiments of all their arts and industries, derived in remote periods from their more advanced neighbours the Chinese, but from that time left to native influences and powers of development. A strangely constituted race, unlike even the Chinese, from whom in fact they may have descended, voluntarily maintaining an isolated state for a long succession of centuries, the Japanese nation has grown up under the circumstances best adapted to produce originality, and the "insular pride" so natural in their isolated position among a group of islands in the Pacific Ocean. Thus left to themselves, the genius of the race has led them rather to direct their efforts to confer beauty on objects of common utility and materials of the lowest value than to create masterpieces of art to be immured in palaces or only exhibited in museums. The faculty of making common and familiar things tell pleasantly upon the ordinary mind, by little artistic surprises and fresh interpretations of the common aspects of natural objects and scenes, is especially their gift, and a gift as valuable as it is rare. It is from this standpoint that the art of Japan should be viewed for a right appreciation of its claims to admiration, and for the proper application of the lesson it conveys to art-workmen and manufacturers of objects of utility.

Previous to the London International Exhibition of 1862 Japan had in fact been a sealed book to the Western world, save in so far as a small collection of industrial and natural products of the country to be seen at the Hague could afford information. The Portuguese *via* Macao, and later the Dutch traders allowed to occupy a factory at Nagasaki in Japan in the 17th and 18th centuries, were in the habit of shipping a few articles for Europe, of utilitarian rather than ornamental character. These consisted chiefly of dinner services of porcelain made to order after European models—known as "Old Japan"—with heavy gilding and staining colours, as unlike any native work as can well be imagined. Lacquered cabinets and large coffers or chests of rough workmanship also found their way to Europe, and some of these are still occasionally to be met with in old country houses or curiosity shops, both in England and on the continent. When the London exhibition, therefore, made its display in the "Japanese court," followed, as this was, by a great exhibition in Paris in 1867 and in Vienna in 1875, the Japanese contributions to which were carefully selected on a large scale by the Japanese Government itself, the rich treasures of art-work came upon Europe as a new revelation in decorative and industrial arts, and have continued since to exercise a strong and abiding influence on all industrial art-work. In London, as in every Continental capital, specimens of Japanese manufacture in great variety speedily followed in the shop windows; and large importations, taking place almost monthly at depôts in London, are speedily bought up to be distributed over the country, and sold in retail. In the International Exhibition of Paris in 1878, the "Japanese court" again presented a matchless collection of perfect workmanship and design in every variety of material. In textile fabrics, such as silks, gauzes, crapes, and embroidery; in bronzes, cloisonnés, champlevé, repoussé, inlaid and damascened work; in art-pottery, faience, and porcelain; and in lacquer and carved wood and ivory,—there was a bewildering variety; but only one opinion prevailed as to the palm of superiority due to them. The inferiority of most of the articles of the same class exhibited in the adjoining "Chinese court," which from its close proximity provoked while it afforded every facility for a close comparison, was very marked. If other tests of excellence were needed, it is amply supplied by the flattery of imitation; though the mischief of merely copying Japanese art work, without any knowledge of the history, religion, popular legends, or the artistic tastes which inspire the workman in Japan, is obvious in the vulgarized reproductions and the incongruous combinations now so common. They may be *Japaneseque*, but they are certainly not Japanese in spirit, feeling, or execution. Defects are exaggerated, and excellences are lost sight of altogether.

Before proceeding with a general survey of the most characteristic Art features of Japanese art, it may be useful for purposes of reference to give a list of English works that have appeared in recent years on this subject. Mr John Leighton in the spring of 1863 was the first to draw public attention to the collection of Japanese objects in the exhibition of 1862 and their artistic merit, by a lecture delivered at the Royal Institution, which was afterwards printed. Dr C. Dresser, in his *Art of Decorative Design*, published his opinion that Japan could "supply the world with the most beautiful domestic



articles that we can anywhere procure"; and both in that work and in another entitled *Unity in Variety*, as deduced from the *Vegetable Kingdom*, he makes particular reference to Japanese decorative work. A series of articles on "Art and Art Industries in Japan," which appeared in the *Art Journal* in 1875-76, were published, with considerable additions, in a single volume in 1878. About the same time two works appeared on the same subject, J. J. Jarves's *Glimpses at the Art of Japan* (1876) and Messrs Audsley & Bowes's *Keramic Art of Japan* (1875-80). A fourth work entitled *Fugaku Hiyaoku-Kei, or a Hundred Views of Fusuyama*, by Hokusai, with introductory and explanatory prefaces from the Japanese, and descriptions of the plates by J. V. Dickins of the Middle Temple, reproduces facsimile plates of the original collection of this celebrated native artist, and even to the paper and form of the thin volumes is a perfect counterpart of the original work as published in Japan. Lastly, there has appeared a valuable contribution to our materials for an intelligent judgment, in Thomas Cutler's *Grammar of Japanese Ornament and Design* (1881). The plates, exceeding sixty in number, are preceded by a carefully written introductory essay, giving a discriminative survey of the chief art-industries and the principles of Japanese ornamentation.

Art in Japan, it has been well observed, "is not, as in Europe, the grafting of one style upon another, and the accumulated knowledge of all the various schools from the remotest antiquity." It has been a growth unaffected by any extraneous influences, self-contained and strictly national, and hence the astonishment and delight created when the art of Japan was first revealed to the outside world. It is in comparing the decorative art of Japan with that of China that we see how far the former has distanced its early Chinese masters, and how thoroughly it has produced a school peculiarly its own. Commenting on its application to ceramic ware, lacquer, bronzes, textile fabrics, &c., Mr Cutler has well remarked, "if we study the decorative art of the Japanese, we find the essential elements of beauty in design, fitness for the purpose which the object is intended to fulfil, good workmanship, and constructive soundness, which give a value to the commonest article, and some touch of ornament by a skilful hand, together creating a true work of art."

The school of art due to the native genius of the Japanese as a race is essentially decorative, and, in its application, to a great degree purely industrial. Pictorial art as understood in Europe can hardly be said to have any existence in Japan. Most of their decorative designs consist of natural objects treated in a conventional way. This conventionalism is, however, so perfect and free in its allurements that nature seems to suggest both the motive and the treatment. Though neither botanically nor ornithologically correct, their flowers and their birds show a truth to nature, and a habit of minute observation in the artist, which cannot be too much admired. Every blade of grass, each leaf and feather, has been the object of loving and patient study. It has been rashly assumed by some of the writers on Japanese art that the Japanese do not study from nature. All their work is an emphatic protest against so erroneous a supposition. It is impossible to examine even the inferior kind of work without seeing evidences of minute and faithful study. It can in fact be shown conclusively that the Japanese have derived all their fundamental ideas of symmetry, so different from ours, from a close study of nature and her processes in the attainment of endless variety.

It is a special feature in their art that, while often closely and minutely imitating natural objects, such as birds, flowers, and fishes, the especial objects of their predilection and study, they frequently combine the facts of external nature with a conventional mode of treatment better suited to their purpose. During the long apprenticeship the Japanese serve to acquire the power of writing with the brush the thousand complicated characters borrowed from the Chinese, they unconsciously cultivate the habit of minute observation and the power of accurate imitation, and with these a delicacy of touch and freedom of hand which only long practice could give. A dot or an angle, is fatal to good calligraphy, both among the Chinese and the Japanese. When they come to use the pencil therefore in drawing, they are possessed of the finest instruments in accuracy of eye and free command of the brush. Whether a Japanese art worker sets himself to copy what he sees before him or to give play to his fancy in combining what he has seen with some ideal in his mind, the result equally shows a perfect facility of execution and easy grace in all the lines.

In their methods of ornamentation the Japanese treat every object flatly, as do their Chinese masters to this day, and this to a certain extent has tended to check any progress in pictorial art, though they have obtained other and very admirable decorative effects. Without being, as Mr Cutler, in common with some other writers, assumes, ignorant of chiaroscuro, or the play of light and shadow, it is true that they usually, though not invariably, paint in flat tones as on a vase, and so dispense with both. It is not a picture so much as a decoration that they produce, but it is a decoration full of beauty in its harmonized tints and graceful freedom of design. The delicacy of touch is everywhere seen, whether bird

or leaf or flower or all combined be chosen as the subject. The Japanese artist especially excels in conveying an idea of motion in the swift flight of birds and gliding movements of fishes, one of the most difficult triumphs of art.

It has been said that the golden age of Japanese art is over and gone, and that the conditions no longer exist, and can never be renewed, under which it has developed its most characteristic excellences. A feudal state, in which the artist and the workman were generally one and the same person, or at least in the same feudal relation to a chief who was bound to support them working or idle, and took pride in counting among his subjects or serfs those who could most excel in producing objects of great beauty and artistic value, is a condition as little likely to return in Japan as the former isolation and freedom from all foreign influences of the people. Under these altered circumstances it is to be feared that Japanese art has culminated, and shown the best of which it is capable. But if the hour of decadence has arrived, and a deterioration of taste inevitably set in, by an intermixture of foreign and debasing influences overlaying original thought and *motifs*, and leading to imitations of European vulgarities, we have the more reason to be grateful to those who, like Messrs Bowes & Audsley and Mr Cutler, have undertaken to preserve by costly and faithful examples works produced in the most brilliant period in the life of a singularly gifted people. One of the characteristic features of all Japanese art is individuality of character in the treatment, by which the absence of all uniformity and monotony or sameness is secured. Repetition without any variation is abhorrent to every Japanese. He will not tolerate the stagnation and tedium of a dull uniformity by mechanical reproduction. His temperament will not let him endure the labour of always producing the same pattern. Hence the repetition of two articles the exact copy of each other, and, generally, the diametrical division of any space into equal parts, are instinctively avoided,—as nature avoids the production of any two plants, or even any two leaves of the same tree, which in all points shall be exactly alike. The application of this principle in the same free spirit is the secret of much of the originality and excellence of the art of Japan. Its artists and artisans alike aim at symmetry, not by an equal division of parts as we do, but rather by a certain balance of corresponding parts, each different from the other, and not numerically even, with an effect of variety and freedom from formality. They seek it, in fact, as nature attains the same end. If we take for instance the skins of animals that are striped or spotted, we have the best possible illustration of nature's methods in this direction. Examining the tiger or the leopard, in all the beauty of their symmetrical adornment, we do not see in any one example an exact repetition of the same lines or spots on each side of the mesial line of the spine; they seem to be alike, and yet are all different. The line of division along the spine, it will be observed, is not perfectly continuous or defined, but in part suggested; and each radiating stripe on either side is full of variety—size, direction, and to some extent in colour and depth of shade. Thus nature works, and so following in her footsteps works the Japanese artist. The same law prevailing in all nature's creation, in the plumage of birds, the painting of butterflies' wings, the marking of shells, and in all the infinite variety and beauty of the floral kingdom, the lesson is constantly renewed to the observant eye. Among flowers the whole family of orchids, with all their fantastic extravagance and mimic imitations of birds and insects, is especially prolific in examples of symmetrical effects without any repetition of similar parts or divisions into even numbers. We may take any one of this class almost at random for a perfect illustration. The *Oncidium leucocochilum* is by no means the most eccentric or baroque member of the family of orchids. But in its eleven number of similar parts, and the variety in form and colour by which a symmetrical whole is produced, there is nothing left to be desired. The sepals are nearly alike, but not quite, either in size, shape, or colour-marking. These are balanced, not by three, but by two petals, which match each other, but are broader and more ovate in shape than the sepals, and, instead of being barred and spotted like the sepals, they are broadly painted to about half their length with a deep chestnut colour; and, while the lip rising from the centre is pure white and wholly different in form, texture, and colour, the crest rising from the base with tubercles is yellowish, with patches of reddish-brown.

This assemblage of parts, so diverse in form, number, and colour, nevertheless forms a single flower of exceeding beauty and symmetry, affording the strongest contrasts and the greatest variety imaginable, such as delight the Japanese artist's mind. The orchids may be taken as offering fair types of his ideal in all art work. And thus, close student of nature's processes, methods, and effects as the Japanese art workman is, he ever seeks to produce humble replicas from his only art master. Thus may we understand how he proceeds in all his decorative work, avoiding studiously the exact repetition of any lines and spaces, and all diametrical divisions, or, if these be forced upon him by the shape of the object, exercising the utmost ingenuity to disguise the fact, and train away the eye from observing the weak point, as nature does in like circumstances.



Thus if a lacquer box in the form of a parallelogram is the object, the artists will not divide it in two equal parts by a perpendicular line, but by a diagonal, as offering a more pleasing line and division. If the box be round, they will seek to lead the eye away from the naked regularity of the circle by a pattern distracting attention, as, for example, by a zigzag breaking the circular outline, and supported by other ornaments.

A similar feeling is shown by them as colourists, and, though sometimes eccentric and daring in their contrasts, they very seldom produce discords in their chromatic scale. They have undoubtedly a fine sense of colour in common with other Eastern races, and a similarly delicate and subtle feeling for harmonious blending of brilliant and sober hues. As a rule they seem to prefer a quiet and refined style, using full but low-toned colours. They know the value of bright colours, however, and how best to utilize them cleverly, both supporting and contrasting them with their secondaries and complementaries, as Mr Leighton remarks.

Having thus taken a very rapid glance at some of the leading features of Japanese decorative art as a whole, and traced the principles that underlie and in great degree determine the processes by which the workman seeks to realize his ideal while taking nature's methods for his guide, we must now pass in review the several art-industries in which they have most excelled. The following account of these, though by no means supplying an exhaustive list, may be considered to include the principal industries. Such, however, is the delicacy of touch and skill in manipulation exhibited by Japanese workmen of all kinds that, apart from the general principles applied in all decorative processes, the simplest toy box of wood or papier-mâché is apt to be made a work of art, and as a piece of constructive workmanship is not easily rivalled, or in danger of being mistaken for the work of any other than Japanese hands.

Pottery and porcelain.

**Pottery and Porcelain.**—There has been much discussion as to the source whence the Japanese derived their skill in pottery and porcelain. The general conclusion that, at a remote era, some Korean priests introduced the manufacture of porcelain from China, the country most advanced in civilization in the eastern half of Asia, may be accepted as sufficiently attested. There is evidence that both Chinese and Japanese have since that time borrowed largely from each other, while inventing new forms and processes by their own ingenuity, taste, and skill. Thus differences in treatment and working traditions would become the inheritance of each, giving rise to the very characteristic distinction which may be observed in the present day between Chinese and Japanese porcelain and pottery of all kinds, notwithstanding a certain generic likeness. The discovery of the art of making hard porcelain, the *porcelaine dure* of the French in contradistinction to the *porcelaine tendre*, cost European workmen much time and labour, after the first importations of Chinese and Japanese porcelain excited the admiration and envy of Europe; and the secret was never revealed by either Chinese or Japanese to any European.

There are to this day many secrets of these crafts as jealously guarded as eyes. The mystery of cracked china, of lace-work translucent porcelain covered with glaze, and of the marvellous egg-shell cups, and the process whereby these are enamelled and covered by a fine woven case of bamboo, as well as the composition and sources of their colours, are still so many secrets to the European manufacturers, although something has been divined or discovered quite lately as to crackle and lace-work porcelain.

The Japanese of late have been much given to lacquering their porcelain, but very often this is not burnt in, and washes off—not even in the beginning has it much beauty to recommend it. Their enamel painting on this porcelain is in many cases very delicate and beautiful both in design and colour,—but perhaps not as a rule equal to the fine specimens of China of the Ming dynasty, or even of the reign of Kanghi, who was a great patron of the arts early in the 17th century. Of the art-pottery and stoneware of Satsuma and Hizen, and indeed of many other provinces in Japan, it may be said that nothing better in the material has ever been produced. The Japanese have no pretension to rank with the classic designs on the Etruscan and Greek vases, because they have never learned to draw the human figure correctly. But in flowers, birds, fishes, and insects the Greeks themselves never approached the perfection of Japanese art, where such objects give a beauty and value often to the very commonest piece of pottery, made with the finger and thumb for the chief tools, and retaining the impress of the skin on the surface.

The great variety of pottery and ceramic ware produced in Japan may most conveniently be arranged under the three heads adopted by Mr Franks in his useful *Art Handbook for the Collection in the South Kensington Museum*:—(1) common pottery and stoneware; (2) a cream-coloured faience, with a glaze often crackled and delicately painted in colours; (3) hard porcelain. The best account perhaps of the very varied substances used by the Japanese in making these wares and forming their porcelain clay is to be found in the report published under the authority of the Japanese commission, *Le Japon à l'Exposition Universelle de 1873*.

Porcelain painted or enamelled with flowers and other designs is largely produced in the province of Hizen in the island of Kjusiu, of which Nagasaki, where there are large manufactories, is a port; but it is also manufactured in a great number of other provinces and districts. The decoration, whether in enamel colours or metals, is laid on after the final burning of the clay or *paste*, and above the glaze. But the artists often live apart from the factories and independent of them, working at their own homes, and owning, separately or jointly according to circumstances, small ovens, where at a comparatively low temperature they can fix their easily fused enamels. Thus much of the finer egg-shell porcelain used to be sent in the white state to Tôkiô, Hizen, and other places, there to be decorated by artists of local celebrity. But from the Hizen factories also comes a great quantity of low-class porcelain for ship ment at Nagasaki, to suit the demand of the European markets. That for the most part is vulgar in taste, made on European models for domestic use, and consists of toilet sets, tea services, jars, trays, &c., coarsely even if elaborately painted, akin to the ware so long received from Canton under similar conditions of deterioration. The colours are bad, with no refined tones. Light greens, red, and blue, all poor in quality, are most common, and have a vulgar and disagreeable effect. This is the result of a demand for cheap articles by tradesmen who have no taste themselves. But Arita, Kiôto, Kaga, Satsuma, and Owari are all centres whence the most characteristic and admired ceramic wares of Japan are obtained. Several varieties of enamelled and painted faience are produced in all, and from Satsuma and Owari, especially the former, the faience is very rich. The delicate tints of the paste, and the better ground which the *paste tendre* furnishes for the reception of enamel colours compared with the *paste dure* of the polished porcelain, give a special beauty to all this ware, while the soft creamy-looking crackled glaze adds an additional charm.

There is a kind of terra cotta and pottery or earthenware industry in Japan of which the produce has been largely exported of late years in the form of jars and censers or flower-pots. The objects selected for the decorative part are usually in very high relief and roughly modelled, consisting of flowers, foliage, or animals, but their artistic merit is not great, though as specimens of technical skill and mastery of all the difficulties offered by subject and material they are very remarkable.

**Lacquer Ware.**—China has given its name to all porcelain in the Western world, as the country whence it was first imported. So has Japan given its name to all lacquer ware, first introduced to the knowledge and admiration of Europe in the 17th century after the discovery of that country. The beauty and excellence of Japanese lacquer ware have never been matched in Europe. Not even in China, where the varnish tree is also indigenous, and the industry may date quite as far back, has equality been ever established. Japan reigns supreme now as at first, in this, the most beautiful and perfect product of all her skilled labour and artistic power.

The unmatched and apparently unmatchable beauty of Japanese lacquer may be due to many causes. The varnish tree is of several kinds, and the *Urushi* tree growing in Japan (the fruit of which yields the vegetable wax, from which is derived the lacquer varnish, supplies, it is said, a finer gum than any other of the same species. It is extracted from the tree at particular seasons only, by incisions in the bark, and from first to last is subjected to many manipulations and refining processes, conducted with a patient attention and a delicacy such as could with difficulty be secured in any other country,—perhaps not in Europe at any cost. It admits in these processes of various admixtures of colouring matter, and from the first gathering to the last use of it in highly finished work, increasing care as to the dryness or moisture of the atmosphere, the exclusion of every particle of dust, and other conditions is essential. The articles to be lacquered, whether cabinets or boxes of infinite variety in size and form, are generally made of light fine-grained pine wood, very carefully seasoned, and smoothed so that not the slightest inequality of surface or roughness of edge remains. Layer after layer of the lacquer is laid on at stated intervals of days or weeks, and after each step the same smoothing process is repeated, generally with a lump of fine charcoal and the fingers, as the finest and most perfect of polishing instruments. These layers vary in number, according to the intended effect and perfection of the article, and also in relation to the design. Very frequently this is either in basso or alto rilievo, in which ivory and agates, coral, or precious stones are inserted, as well as gold and silver in rich profusion. Some of the older and finer pieces of lacquer, which even in the early days of treaty relations in 1859 were rarely in the market, and now an exceedingly scarce in Japan itself, represent the labour of months and even years of the most skilled workmen, who must be artists as well as masters of the manual craft. On these articles they lavish all their art, and enrich them by every kind of decoration.

Free patterns are in constant use in all Japanese art, sometimes in the form of borders, and more frequently in diapers, which they use with excellent effect on surfaces in filling up and varying the spaces, and in combination with floral and other designs. Their love of variety leads them to adopt several different diapers in covering any sur-



face, often enclosing them in irregular-shaped compartments, fitting into each other or detached according to the fancy of the artist and the shape of the object ornamented. The same kind of ornamentation and decorative art is carried out in their woodwork, as may constantly be seen in their cabinets of marquetric and inlaid boxes. Their predilection for geometrical forms is best to be seen in their great variety of diapers.

Nor must their floral diapers be overlooked, consisting as they do of an almost infinite variety for covering whole surfaces, in which flowers and foliage form the material. In the spaces of decoration as in all else, the Japanese artist studiously avoids uniformity or repetition of exact spacing. He repeats, but with the greatest irregularity possible, to disguise as it were the repetition of what is in effect the same design or pattern. In close connexion with the diaper system of ornamentation is that known as powdering, familiar enough in European art; but in Japan, following the principle of irregularity, the decorator avoids any regular distribution of the design adopted. Lastly, there is a style of ornamentation peculiarly Japanese which consists in the use of medallions grouped or scattered over a surface—of various colours and forms—and filled in with different diapers, the whole producing an effect as pleasing as it was novel when first introduced to European eyes. And in this treatment of metallion powdering may best be seen the triumph of this system for the avoidance of uniformity and diametrical division. The medallions being of definite forms, and usually geometrical in outline, the ingenuity displayed in overcoming the difficulty such forms present is very instructive. They are placed either singly or in groups—in the latter case partially, overlapping, and of different outlines—in different colours, and filled in with various diapers, the whole being irregularly distributed over the surface in such a way as to avoid diametrical division or uniformity of any kind.

This applies to the finer specimens of the work, where all the principles of surface ornamentation and design adopted by the Japanese may be seen in their greatest perfection. But lacquer is the common ware for domestic use, almost as common as pottery and earthenware are in Europe. Cups and saucers, trays and saké bottles, medicine boxes and dishes, are in the poorest houses; and so excellent is the varnish that neither boiling water nor oil will affect the surface. In the finer and older specimens this hardness increases with age, so that some of them can with difficulty be scratched with pin or needle. The value of such specimens, first introduced into England at the London exhibition of 1862, has now been fully recognized, and the cost of the best and oldest lacquer, always high, has greatly increased of late years. Dr Dresser mentioned in a recent lecture a box of about six inches square, for which he was asked in Japan £100, and he was told that in Yedo (now Tôkiô) fine specimens were "bringing their weight in gold." In the Paris exhibition of 1878 there was a large lacquer screen of great beauty valued at 65,000 francs. It, however, was modern, and, with all its beauty, was over-priced. The Japanese also, besides applying lacquer with colours on porcelain, possess in rare perfection the art of lacquering on tortoiseshell and ivory. On these they present minute figures and landscapes with a mixture of gilding and rich colours, sometimes in relief, at other times engraved and sunk, and in this manner they ornament miniature cabinets, jewel boxes, and other quaintly formed miniature boxes, medicine cases, &c., in a way to defy competition in their marvellous beauty and delicacy of execution.

*Metals and Bronzes.*—In all manipulations of metals and amalgams the Japanese are great masters. They not only "are in possession of secret processes unknown to workmen in Europe," by which they produce effects beyond the reach of the latter, but show a mastery of their material in the moulding and designing of their productions which imparts a peculiar freedom and grace to their best work. A lotus leaf and flower and seed-pod they will produce with inimitable fidelity in the subtle curves and undulating lines and surfaces, and in the most minute markings of leaf and flower. So birds and fishes and insects cast in bronze seem instinct with life, so true are they to nature, while at other times the same objects are adopted for a purely conventional mode of treatment. Their inlaying and overlaying of metals, bronze, silver, and steel, more than rival the best productions of the ateliers of Paris or Berlin, and constitute a special art-industry, with some features of finish and excellence not yet attained in Europe.

*Shakudô.* Of the metallurgic triumphs of art which the Japanese may justly claim over all competitors, Chinese, Indian, or European, perhaps the greatest is the perfection to which they have brought the designs in "shakudô," an amalgam of which are usually made the brooches or buttons used to fasten their tobacco pouches and pocket-books, or to ornament the handles of their swords. Shakudô is chiefly of iron, relieved by partial overlaying of gold, silver, and bronze. One of the jurors (the late Mr Huut) of the London exhibition of 1862, an employer of the highest artistic and mechanical skill in the working of the precious metals, was convinced, as he stated in his report to the commissioners, that "the Japanese were in possession of some means not known in Europe of forming amal-

gams, and of overlaying one metal on another, and in the most minute and delicate details introducing into the same subject, not covering an inch, silver, gold, bronze, &c., so as to make a variegated picture of divers colours."

*Cloisonné, Champlevé, and Repoussé Work.*—In the varied applications of the art of enamelling, the Japanese have run their great rivals in cloisonné work very close, although upon the whole the Chinese have the superiority, their colouring being more brilliant and finely toned in harmony, and their work more solid and satisfactory both to the eye and the touch. A dull and sombre tone is generally adopted in Japanese cloisonné work, which much impairs the beauty of their good workmanship in its general effect.

The mode of producing cloisonné work has often been described. It derives this name from the process of building up the design in cells formed by raised septa varying from  $\frac{1}{4}$  to  $\frac{1}{2}$  of an inch in depth; these labyrinthine cells forming elaborate patterns of flowers, diapers, frets, &c., are soldered on the surface of the vases selected, made generally of copper; and into these cells the enamel of the consistence of oil paints and of the various colours required by the pattern is carefully pressed by a wooden spatula. When complete the piece is placed in a primitive kind of oven or "muffle," where it is fired with a regulated heat until the paste is fused and converted into a vitreous substance, when it is allowed very gradually to cool. This is a process which, however primitively conducted, as most things are both in China and Japan, and with very simple tools and rude contrivances, is nevertheless one which requires to be watched with the greatest care and judgment. Too much heat would injure the colours, and might fuse the septa or the copper foundation, in which case the whole vessel would become misshapen, or clouded in colour and otherwise marred and rendered worthless. Apart from the risky nature of the process, the enamel colours are very valuable, and the artistic labour required in the pattern and manipulation is too great to allow cloisonné articles to become otherwise than costly even in China or Japan. And as to their reproduction in Europe, or any rivalry there, M. Christophle of Paris is understood to have devoted much time and money for the attainment of this object, and succeeded in producing some very beautiful specimens which were exhibited at one of the international exhibitions in London; but the production proved too costly to pay as a matter of business. A good deal has been manufactured in China of late years, it is true, to meet a somewhat indiscriminating demand for articles in such great request. That these modern productions should be inferior to the older work, produced in a much more leisurely way, and for temples or palaces rather than for sale in open market, will be readily understood.

The arts of champlevé and repoussé are not unknown to the Japanese, but both are less practised than the other kinds of metal work above described. Of the latter Mr Monney, late secretary of legation in Japan, succeeded in finding and bringing away many very fine specimens in silver.

*Carving.*—A nation showing such artistic power in metals, and in more feeble material, such as clay, could not fail to excel in wood and ivory carving. Perhaps in no department are they better known, owing to the large number of "mitsuké," as the little ivory groups of figures are called, replete with life and humour, that are to be seen in a hundred shops in every capital. These in the days now rapidly passing away used to be employed as buttons, and were as much matters of costly fancy as seals and rings or brooches with us. Whether they take wood or ivory for their material, the result is equally admirable. There are mitsuké and nitsuké, however, as there are artists and artists. Many of the nitsuké that have been imported into Europe in vast quantities of late years are but poor specimens of the Japanese carver's skill, fancy, and invention.

*Wall Papers.*—There is a great field for the display of their originality and love of variety in the wall papers, which are much used to ornament their walls and screens. What has already been said of their decorative system and methods of surface ornamentation applies to their wall papers; and the system itself is nowhere so severely tried, because something of mechanical reproduction is unavoidable. Whether stencilled or printed, the design of a single square must of necessity be the same in each. By what force of imagination and ingenuity they disguise the effect of exact repetition, and lead the eye away from noticing the uniformity, can only be realized by inspection of the papers covering the walls of an apartment, and no description could supply a substitute. Suffice it to say that their art-principles triumph, even under this severe trial.

*Textile Fabrics and Embroidery.*—Of textile fabrics and embroidery, in both of which they have developed an industry peculiarly their own, something of the same kind may be said as of their wall papers. These fabrics have, however, been so familiarized in England by the eager adoption of the best and most novel in female costumes that their chief characteristics must be very generally known. It was the custom in former times for each daimio to have his private looms, for weaving the brocades which he himself and his wife and family required, and also the fabrics of less costly materials for his retainers. The robes manufactured for the court at Kiôto and Yedo were in like manner only to be



had from the imperial looms; some of these, a gift from the shōgun to a minister taking leave of his court, were to be seen in the London exhibition of 1862.

But in many of the more common textile fabrics the best evidence perhaps may be found of the artistic feeling of the nation, and the universality of art work. Towels and dusters of the least expensive material often display very choice designs—as do also the Turkish and Syrian fabrics of the same quality. A piece of bamboo, a broken branch of blossoms, or a flight of birds in counter-changed colours, suffices in their hands to produce the most charming effect, in the most perfect taste. Their embroidery has never been excelled in beauty of design, assortment of colours, and perfection of needlework.

This summary of the leading characteristics of Japanese art, and the industries to which it has been applied with such unequalled success, is much too brief to be otherwise than imperfect. The art works and the art thought of a people so truly artistic as the Japanese have proved themselves to be form a subject of wide scope and great complexity. The reports issued by the Japanese commissioners at the great exhibitions held successively in Paris in 1867 and 1878, in Vienna in 1875, and in Philadelphia in 1876; and the report written by direction of the Japanese Government for the South Kensington Museum, and now embodied in the valuable *Art Handbook on Japanese Pottery*, by Mr A. W. Franks, its editor, afford the best evidence of the extent and variety of art work for which as a nation they have now a world-wide reputation.

It is true, and strange as true, that the Japanese have apparently never sought to overstep the limits of a purely decorative art, and have thus stopped short of the art development of other nations. Whether this limitation may be from some organic defect, or is merely a result of their neglect to study the human figure and master the difficulties of rendering the fine harmony of line and proportion seen in greatest perfection there, it is difficult to determine. Certain it is, they have never advanced so far. They have always been content to treat the human figure in a conventional style, not much in advance of the Egyptian rendering, and quite incompatible with good drawing. (R. AL.)

JAPANING is the art of coating surfaces of metal, wood, &c., with a variety of varnishes, which are dried and hardened on, by means of a high temperature, in stoves or hot chambers, which drying processes constitute the main distinguishing features of the art. The trade owes its name to the fact that it is an imitation of the famous lacquering of Japan, although the latter is prepared with entirely different materials and processes, and is in all respects much more brilliant, durable, and beautiful than any ordinary japan work. Japaning is done in clear transparent varnishes, in black, and in body colours; but black japan is the most characteristic and common style of work. The varnish for black japan consists essentially of pure natural asphaltum with a proportion of gum animé dissolved in linseed oil and thinned with turpentine; but there are numerous receipts given for the varnish, and manufacturers generally conceal the composition of their own preparations. In thin layers such a japan has a rich dark brown colour, and only shows a brilliant black in thicker coatings. For fine work, which has to be smoothed and polished, several coats of black are applied in succession, each being separately dried in the stove at a heat which may rise to near 300° Fahr. Body colours consist of a basis of transparent varnish mixed with the special mineral paints of the desired colours or with bronze powders. The transparent varnish used by japaners is a copal varnish which contains less drying oil and more turpentine than is contained in ordinary painter's oil varnish. By japaning a very brilliant polished surface may be secured which is much more durable and less easily affected by heat, moisture, or other influences than any ordinary painted and varnished work. Japaning may be regarded as a process intermediate between ordinary painting and enamelling. It is very extensively applied in the finishing of ordinary ironmongery goods, and domestic iron work, deed boxes, clock dials, and papier mâché articles. The process is also applied to blocks of slate for making imita-

*Bibliography.*—For its knowledge of Japan Europe was for a long time indebted mainly to the members of the Dutch colony; but since the restoration of intercourse between Japan and the Western nations a very extensive literature *de rebus Japonicis* has grown up in the chief European languages. The following works are among the more important.—F. Caron, *Beschrijving van het machtigh Koninkrycke Japan*, Amst., 1649; R. Manley's English version of Caron, London, 1663; A. Montanus, *Gesantschappen . . . aan de Kaisaren van Japan*, Amst., 1669; Kaempfer, *History of Japan*, Lond., 1728, a translation by J. C. Scheuchzer; Titsingh, *Mémoires, &c.*, Paris, 1820; Thunberg, *Voy. au Japon*, Paris, 1795; G. F. Meylan, *Japan voorgesteld in Schetsen*, Amst., 1830; Fischer, *Bijdrage tot de kennis van het Japanische Rijk*, Amst., 1833; Plistorius, *Bijdrage tot de geschiedenis van Japan*, Amst., 1849; Francis L. Hawks, *Narrative of the American Expedition by Commodore Perry*, New York, 1856; Fraissinet, *Le Japon Contemporain*, Paris, 1857; Lihudori, *Acht Monate in Japan nach dem Abschluss des Vertrags von Kanagawa*, Bremen, 1857; Cornwallis, *Two Journeys to Japan*, Lond., 1859; Furet, *Lettres à M. Léon de Rosny sur l'archipel japonais et la Tartarie orientale*, Paris, 1860; Vankattendijke, *Uittreksel uit het dagboek van . . . gedurende zijn verblijf in Japan 1857-1859*, Hague, 1860; Heine, *Japan und seine Bewohner*, Leipzig, 1860 (new edition, 1880); De Lynden, *Souvenir du Japon, vues d'après nature*, The Hague, 1860; Léon de Rosny, *La civilisation japonaise*, Paris, 1866; Rob. Fortune, *Yedo and Peking*, Lond., 1863; Alcock, *The Capital of the Yezoan*, Lond., 1863; Lindau, *Un Voy. autour du Japon*, Paris, 1864; Paape van Meerdewoort, *Vijf jaren in Japan 1851-63*, Leyden, 1867; Leou Pages, *Histoire de la religion Chrétienne au Japon 1598-1651*, Paris, 1867; *The Official Report of the Prussian Novara Expedition to East Asia*, Berlin, 1864, &c.; Henry Schilleman, *La Chine et Le Japon*, Paris, 1867; August Humbert, *Le Japon illustré*, Paris, 1870 (English transl., Lond., 1873); Griffiths, *The Mikado's Empire*, New York, 1870-1874; Mitford, *Tales of Old Japan*, Lond., 1871; Bayard Taylor, *Japan in Our Day*, New York, 1872; Adams, *History of Japan from the Earliest Times to the Present Day*, Lond., 1874-75; Savio, *Il Giappone al giorno d'oggi*, Milan, 1875; Metchnikoff, *L'Empire japonais*, Geneva, 1875; Le Gendre, *Progressive Japan, a Study of the Political and Social Needs of the Empire*, New York, 1879; I. L. Bird, *Unbeaten Tracks in Japan*, Lond., 1880; Sir Edward J. Reed, *Japan, its History, Traditions, and Religion*, Lond., 1880; J. J. Rehn, *Japan nach Reisen und Studien in Auftrag der K. Preuss. Regierung dargestellt*, vol. I, "Natur und Volk des Mikado-reiches," Leipzig, 1881. In Feb. 1881 appeared vol. I. of an elaborate and valuable *Handbook for Travellers in Japan*, by E. Satow and A. G. S. Hawes, arranged on the model of Murray's Handbooks. See further L. Page's *Bibliographie japonaise ou catalogue des ouvrages relatifs au Japon qui ont été publiés depuis le XVe siècle jusqu'à nos jours*, Paris, 1859; R. Gosch's Japanese bibliography up to 1862 in *Zeitschrift der Deutschen Morgenl. Gesellsch.* vol. xx., Supplement; and *Bibliotheca japonica, Verzeichniss einer Sammlung japanischer Bücher in 1408 Bänden*, Vienna, 1875. Much interesting information on Japanese matters will be found in *Annales de l'extrême Orient*; *Mittheil.* der Deutschen Ges. für Natur- u. Völkerkunde Ostasiens (Yokohama and Berlin), as well as in the *Transactions of the Asiatic Society of Japan and the Annuaire de la Société des Etudes japonaises*, *aktinotes*, &c., for 1878, &c., published with assistance of Em. Burnouf and other Orientalists of note.

tion of black and other marbles for chimney pieces, &c., and a modified form of japaning is employed for prepared enamelled, japan, or patent leather.

The beautiful lacquer work of Japan owes its hardness and durable qualities solely to the natural varnish which forms the basis of the lacquer. That varnish is simply an exudation from a tree (*Rhus vernicifera*) cultivated for the sake of this product throughout a wide area in Japan. The varnish is obtained by making incisions in the bark of the tree, from which a mingled clear and milky juice flows abundantly, which on exposure quickly darkens and blackens in colour. After resting in tubs for some time the juice becomes thick and viscous, the thicker portions settle at the bottom of the vessel, and from it the thinner stratum is separated by decanting. Both qualities are strained to free them from impurities, and when ready for use they have a rich brown-black appearance, which, however, in thin layers presents a yellow transparent aspect. This varnish when applied to any object becomes exceedingly hard and unalterable, and with it as a basis all the coloured lacquers of Japan are prepared. The black variety of the lacquer is prepared by stirring the crude varnish for a day or two in the open air, by which it becomes a deep brownish black. Towards the completion of the process a quantity of highly ferruginous water, or of an infusion of gall nuts darkened with iron, is mixed with the varnish, and the stirring and exposure are continued till the added water has entirely evaporated, leaving a rich jet black varnish of proper consistence. In preparing the fine qualities of Japanese lacquer, the material receives numerous coats, and between each coating the surface is carefully ground and smoothed. The final coating is highly polished by rubbing, and the manner in which such lacquered work is finished and ornamented presents endless variations. The durability of Japanese lacquer work is such that it can be used for vessels to contain hot tea and other food, and it is even unaffected by highly heated spirituous liquors.

JAPHETH (יָפֶֿתֿ), son of Noah. The most natural rendering of Gen. x. 21 is that which makes Shem the elder brother of Japheth, though the opposite view of the passage in the A. V. follows the Hebrew accents. Interpreters are not agreed whether the sacred text regards Japheth as the second or third son of Noah. In Gen. ix. 24 "youngest" is an easier rendering than "younger," but the name of Ham is always placed between those of his brothers. The whole Biblical importance of the sons of Noah is geographical or ethnographical; even in the narrative of Gen. ix. 20-27 the point lies in the blessings assigned to the nations or groups of nations named after each. The distribution of the Japhetic group is sketched in Gen. x. 2-4 from the geographical standpoint of the Levitical narrator, that is, according to the most recent criticism, of the 6th century B.C. The seven sons of Japheth are the nations lying north of the Semitic group or westward across the Mediterranean. The details are in part obscure. Madai certainly means the Medians and Javan the Ionians, but in our passage the latter name is used in an extended sense, not so much for the Greeks proper—a common Eastern usage of the word—as for the inhabitants of the trading ports and coast-lands of the Mediterranean known to Phœnician commerce. Thus Javan includes Elishah (probably Carthage), Tarshish (Tartessus in Spain), Kittim (Cyprus), and Dodanim, for which we must rather read Rodanim (Rhodes), with the LXX. in our passage and the Hebrew of 1 Chron. i. 7. Tubal and Meshech appear in Ezek. xxvii. 13 as associated with Javan in exporting slaves and bronze to Tyre, and the same nations along with Gomer occur in Ezek. xxxviii. in the great army of Magog which issues from the "extreme north" (A. V. "north quarters," vv. 6, 15). Magog in fact means the Scythians, and whatever doubt there may be as to the identification of the associated names (Gomer, Cimmericians or Cappadocians, and with the subdivisions Ascanians, Paphlagonians, and perhaps Teuthranians; Tubal, Tibareni; Meshech, Moschi), the whole group appears to be connected with the shores of the Black Sea or to be known from Phœnician voyages in that direction. The seventh son Tiras is quite unidentified; Thracians and Tyrsenians are mere guesses. The wide range of the Japhetic lands sufficiently explains the blessing in Gen. ix. 27, "May God enlarge Japheth." In the succeeding clause, "and let him dwell in the tents of Shem" it is disputed whether the subject is God or Japheth. In the latter case the allusion must be to friendly intercommunication and common settlements on equal terms, in contrast to the position of the subjugated Hamites (Canaan) under the lordship of the victorious Semites (Israel). The precise point of view from which the northern nations, and particularly those over the sea (Gen. x. 5), came to be grouped as sons of Japheth is the more obscure because the etymology of the name is quite uncertain. The resemblance in sound to the Greek Iapetos has been often noticed, but leads to nothing.

Compare, in addition to Bechart's *Phœnx et Canaan* and the commentaries on Genesis, Knobel, *Völkertafel*, Giessen, 1850; Kiepert in *Monatsber. der Berl. Ac. d. Wiss.*, February 1869; Lagarde, *Abhandlungen*, Leipzig, 1866; Stade, *Javan*, Giessen, 1880; Delitzsch, *Wo lag das Paradies*, p. 245 sq., 1881.

JARCHI. See RASHI.

JARNAC, chief town of a canton in the arrondissement of Cognac, in the department of Charente, France, is situated on the right bank of the river Charente, about 8 miles east of Cognac, and 18 miles west of Angoulême. The town is well built; and a handsome avenue, planted with poplar trees, leads to the striking suspension bridge. The church contains an interesting ogival crypt. Brandy, wine, and wine-casks are made in the town. At the battle of Jarnac, fought in 1569 between 26,000 Catholics under the Duc

d'Anjou and 15,000 Protestants under Coligny and Condé, the last was treacherously shot after surrendering. A pyramid marks the spot where he fell. In the vicinity of the town are some Roman remains. Jarnac gave name to an old French family, of which the best known member is Gui Chabot, baron de Jarnac (d. cir. 1575), who gave rise to the proverbial phrase *coup de Jarnac* by a sudden thrust during a duel. The population in 1876 was 4390.

JAROMIERZ, a town in the department of Königinhof, Bohemia, situated at the junction of the Aupa and Elbe. It possesses a district court, a suspension-bridge, a pretty church, and a hospital, and manufactures beet-root sugar. On June 29, 1866, a skirmish between the Austrians and Prussians took place in the neighbourhood. The population in 1869 was 5442.

JARRAH WOOD is the product of a large tree (*Eucalyptus marginata*) found in western Australia, where it is said to be very abundant. The trees grow straight in the stem to a great size, and yield squared timber up to 40 feet in length and 24 inches in diameter. The wood is very hard, heavy (sp. gr. 1010), and close-grained, with a mahogany-red colour, and sometimes sufficient "figure" to render it suitable for cabinetmakers' use. The timber possesses several useful characteristics; and great expectations have been formed as to its value for shipbuilding and general constructive purposes. These expectations have not, however, been realized, and the exclusive possession of the tree has not proved that source of wealth to western Australia which was at one time expected. Its greatest merit for shipbuilding and marine purposes is due to the fact that it resists, better than any other timber, the attacks of the *Teredo navalis* and other marine borers, and on land it is equally exempt, in tropical countries, from the ravages of white ants. When felled with the sap at its lowest point and well seasoned, the wood stands exposure in the air, earth, or sea remarkably well, on which account it is in request for railway sleepers, telegraph poles, and piles in the British colonies and India. The wood, however, frequently shows longitudinal blisters, or lacunæ, filled with resin, the same as may be observed in spruce fir timber; and it is deficient in fibre, breaking with a short fracture under comparatively moderate pressure. It has been classed at Lloyd's for shipbuilding purposes in line three, table A, of the registry rules. †

JARROW-ON-TYNE, a town and municipal burgh of Durham, is situated on the south bank of the Tyne, 3 miles south-west by west of South Shields, and 7 miles south-east of Newcastle, with which it is connected by rail. The parish church of St Paul, rebuilt in 1783 and again in 1866, still retains some fragments of the original Saxon edifice founded about 685. Close by are the scattered ruins of the monastery begun by the pious Bishop in 681, and consecrated with the church by Cædfrid in 685. Within the walls of this monastery the Venerable Bede spent his life from childhood; and his body was at first buried within the church, whither, until it was removed under Edward the Confessor to Durham, it attracted many pilgrims. The other chief buildings are the various chapels, the mechanics' institute, and the hospital. Jarrow Slake is a river bay, 1 mile long by ½ mile broad, in which it is said the fleet of King Egfrid found a station. On its banks are the new-Tyne docks, formed at a great expense by the North-Eastern Railway Company. These with the quays and adjacencies cover about 300 acres, of which 50 are water surface with a tidal basin of 10 acres. The erection of the docks gave a great impetus to the trade of Jarrow. In 1877, 4,000,000 tons of coal were shipped thence. Iron shipbuilding (one yard employing 5000 hands), iron-founding, and the manufacture of paper and chemicals are the chief sources of wealth, in addition to coal-mining. In



1875 Jarrow was constituted a municipal borough, with an extent of 851 acres. The population in 1881 was 25,296. Previous to 1875 Jarrow had been a local board district; this had a population in 1871 of 18,115.

**JASHAR**, BOOK OF. See HEBREW LANGUAGE AND LITERATURE, vol. xi. p. 598.

**JASHPUR**, a tributary state of Chutiá Nágpur, Bengal, between 22° 17' 5" and 23° 15' 30" N. lat., and between 83° 32' 50" and 84° 26' 15" E. long., with an area of 1947 square miles, is bounded on the N. and W. by the tributary state of Sargújá, on the S. by Gángpur and Udáipur, and on the E. by Lohárdagá district. The state of Jashpur consists in almost equal proportions of highland and lowland areas. On its eastern side the tableland of the Uparghát (2200 feet above the sea) forms an integral part of the plateau of Chutiá Nágpur; towards the west it springs abruptly from the Hetghát, with a wall buttressed at places by projecting masses of rock. The lowlands of Hetghát and of Jashpur proper lie to the south in successive steppes, broken by low hills. The plateau of Kburíá (3000-3700 feet) occupies the north-west corner of the state. The principal peaks in Jashpur are Rántíjúlá (3527 feet), Kohiar (3393 feet), Bharamurie (3390 feet). The chief river is the Ib, which flows through the state from north to south; but numerous rapids render it unnavigable. The small rivers to the north are feeders of the Kanhar. Iron and gold are found; *sál*, *sisú*, ebony, and other valuable timber trees abound. Lac, *tasar*-silk, and bees-wax, with cereals, oil-seeds, fibres, and cotton are produced. Jashpur, with the rest of the Sargújá group of states, was ceded to the British by the provisional engagement concluded with Madhují Bhoulsá (Apá Sáhí) in 1818. Although noticed as a separate state, it was at first treated as a fief of Sargújá. It is, however, dealt with as a distinct territory.

The chief of Jashpur's annual income is £2000; the tribute to Government is £77, 10s. The total population in 1872 was 66,926, comprising 34,648 males and 32,278 females,—the Dravidian aborigines numbering 40,935; Kolarian aborigines, 14,070; semi-Hinduized aborigines, 6374; Hindus, 5124; Mahometans, 423. The residence of the rájá is at Jagdispur or Jashpurnagar.

**JASMIN**, JACQUES (1798-1864), a noted Gascon poet, was born at Agen, March 6, 1798. His childhood was spent in the midst of privations and all the straits of poverty, and he boasted in after life that he had succeeded in breaking up the traditional chair in which the Jasmins had hitherto been carried to the workhouse in sickness and old age. His father, who was a tailor, had a certain facility for making doggerel verses, which he sang or recited at fairs and such like popular gatherings; and the younger Jasmin, who used generally to accompany him, was thus early familiarized with the double part which he afterwards so successfully filled himself. When sixteen years of age he found employment at a hairdresser's shop, and subsequently started a similar business of his own on the Gravier at Agen. It is opposite this scene of his ripening genius and daily work that a statue has been erected to his memory by public subscription. In 1835 he published his first volume of *Papillotos* ("Curl Papers"), containing poems in French (a language he used with a certain sense of restraint), and in the familiar Agen patois—the popular speech of the working classes—in which he was to achieve all his literary triumphs. Many of the pieces in this volume had already been printed and submitted to the public. The dialect which Jasmin spoke, though still harmonious and full of picturesque idioms, was now almost exclusively used by illiterate persons, and was greatly modified by a daily contact with French. It was, however, his native speech—the one in which he found spontaneous and adequate expression, and he lost no opportunity of making himself complete master of it

by intercourse with the rural population in outlying districts where it was spoken with less admixture. He rehabilitated, disencumbered, and in a measure reconstructed his literary medium, and then, fully realizing that his poems needed other exposition than the mere printed text, he began these numerous public recitations which so largely added to his reputation. His real poetic gift, and his flexible voice and action, fitted him admirably for this double rôle of troubadour and jongleur. In 1835 he recited his "Blind Girl of Castel-Cuillé" at Bordeaux, in 1836 at Toulouse; and he met with an enthusiastic reception in both those important cities. Most of his public recitations were given for benevolent purposes,—1,500,000 francs, the proceeds of his poetical rounds, being contributed by him to the restoration of the church of Vergt and other good works. Four successive volumes of *Papillotos* were published during his lifetime, and contained amongst others the following remarkable poems, quoted in order: "The Charivari," "My Recollections" (supplemented after an interval of many years), "The Blind Girl," "François-netto," "Martha the Simple," and "The Twin Brothers." With the exception of the "Charivari," these are all touching pictures of humble life,—in most cases real episodes,—carefully elaborated by the poet till the graphic descriptions, full of light and colour, and the admirably varied and melodious verse, seem too spontaneous and easy to have cost an effort. Jasmin was not a prolific writer, and, in spite of his impetuous nature, would work a long time at one poem, striving to realize every feeling he wished to describe, and give it its most lucid and natural expression. A verse from his spirited poem, "The Third of May," written in honour of Henry IV., and published in the first volume of *Papillotos*, is engraved on the base of the statue erected to that king at Nérac. In 1852 Jasmin's works were crowned by the Académie Française, and a pension was awarded him. The medal struck on the occasion bore the inscription "Au poète moral et populaire." His title of "Maître es Jeux" is a distinction only conferred by the academy of Toulouse on illustrious writers. Pius IX. sent him the insignia of a knight of St Gregory the Great, and he was made chevalier of the legion of honour. He spent the latter years of his life on a small estate which he had bought near Agen and named "Papillotos," and which he describes in *Ma Bigno* ("My Vine"). Though invited to represent his native city, he refused to do so, preferring the pleasures and leisure of a country life, and wisely judging that he was no really eligible candidate for electoral honours. He died October 4, 1864. His last poem, an answer to Renan, was placed between his folded hands in his coffin.

The linguistic and literary revival in the south of France, which received such lustre from the genius of Jasmin, has now become a well-organized movement, and has extended from Gascoy to Languedoc, and to Provence, where it is most marked.

**JASMINE**, or **JESSAMINE**, botanically *Jasminum*, a genus of shrubs or climbers constituting the principal part of the natural order *Jasminaceæ*, and comprising about sixty species, of which forty or more occur in the gardens of Britain. The plants of the genus are mostly natives of the warmer regions of the Old World, but there are one or two South American species. The leaves are pinnate or ternate, or sometimes apparently simple, consisting of one leaflet, articulated to the petiole. The flowers, usually white or yellow, are arranged in terminal or axillary panicles, and have a tubular 5- or 8-cleft calyx, and a cylindrical corolla-tube, with a spreading limb, two included stamens, and a two-celled ovary.

The name is derived from the Persian *yásmín*. Linnæus obtained a fancied etymology from *ia*, violets, and *δσμή*,

smell, but the odour of its flowers bears no resemblance to that of the violet; it is in fact so peculiar as to be incomparable, and is probably the only floral perfume which cannot be imitated by art. The common white jasmine, *Jasminum officinale*, one of the best known and most highly esteemed of British hardy ligneous climbers, is said to be a native of India, and to have been introduced about the middle of the 16th century. In the centre and south of Europa it is thoroughly acclimatized. Although it grows to the height of 12 and sometimes 20 feet, its stem is feeble and requires support; its leaves are opposite, pinnated, and dark green, the leaflets are in three pairs, with an odd one, and are pointed, the terminal one larger and with a tapering point. The fragrant white flowers bloom from June to October; and, as they are found chiefly on the young shoots, the plant should only be pruned in the autumn. Varieties with golden and silver-edged leaves and one with double flowers are known.



FIG. 1.—*Jasminum grandiflorum*, half nat. size; flower, natural size.

The Zambak or Arabian jasmine, *Jasminum Sambac*, is an evergreen white-flowered climber, 6 or 8 feet high, introduced into Britain in the latter part of the 17th century. Two varieties introduced somewhat later are respectively 3-leaved and double-flowered, and these, as well as that with normal flowers, bloom throughout the greater part of the year. On account of their exquisite fragrance the flowers are highly esteemed in the East, and are frequently referred to by the Persian and Arabian poets. An oil obtained by boiling the leaves is used to anoint the head for complaints of the eye, and an oil obtained from the roots is used medicinally to arrest the secretion of milk. The flowers of one of the double varieties, known as "Moogree," are held sacred to Vishnu, and used as votive offerings in Hindu religious ceremonies. In China the flowers of this plant, under the name of "Mo-le-hwa," are used for scenting tea. The Spanish, or Catalonian jasmine, *J. grandiflorum* (fig. 2), which grows wild on the island of Tobago, is very like *J. officinale*, but differs in the size of the leaflets; the branches are shorter and stouter, and the flowers very

much larger, and reddish underneath. By grafting it on two-year-old plants of *J. officinale*, an erect bush about 3 feet high is obtained, requiring no supports. In this way it is very extensively cultivated at Cannes and Grasse, in the south of France; the plants are set in rows, fully exposed to the sun; they come into full bearing the second year after grafting; the blossoms, which are very large and intensely fragrant, are produced from July till the end of October, but those of August and September are the most odoriferous. An acre of land is said to yield about 500 lb of blossoms during the season, value £25 to £35. The aroma is extracted by the process known as "enfleurage," i.e., absorption by a fatty body, such as purified lard or olive oil. Square glass trays framed with wood about 3 inches deep are spread over with grease about half an inch thick, in which ridges are made to facilitate absorption, and sprinkled with freshly gathered flowers, which are renewed every morning during the whole time the plant remains in blossom; the trays are piled up in stacks to prevent the evaporation of the aroma; and finally the pomade is scraped off the glass, melted at as low a temperature as possible, and strained. When oil is employed as the absorbent, coarse cotton cloths previously saturated with the finest olive oil are laid on wire-gauze frames, and repeatedly covered in the same manner with fresh flowers; they are then squeezed under a press, yielding what is termed "huile antique au jasmin." 3 lb of flowers will perfume 1 lb of grease,—this is exhausted by maceration in 1 pint of rectified spirit to form the "extract."

An essential oil is distilled from jasmine in Tunis and Algeria, but its high price prevents its being used to any extent. The East Indian oil of jasmine is a compound largely contaminated with sandalwood-oil. The distinguishing characters of *J. odoratissimum* consist principally in the alternate, obtuse, ternate, and pinnate leaves, the 3-flowered terminal peduncles, and the 5-cleft yellow corolla with obtuse segments. The flowers have the advantage of retaining when dry their natural perfume, which is suggestive of a mixture of jasmine, jonquille, and orange-blossom. In China the *J. paniculatum* is cultivated as an erect shrub, known as *Sieu-hing-hwa*; it is valued for its flowers, which are used with those of *J. Sambac*, in the proportion of 10 lb of the former to 30 lb of the latter, for scenting tea—40 lb of the mixture being required for 100 lb of tea. The "narrow leaved jasmine," *J. angustifolium*, is a beautiful evergreen climber 10 to 12 feet high, found in the Coromandel forests, and introduced into Britain during the present century. Its leaves are of a bright shining green; its large terminal flowers are white with a faint tinge of red, fragrant, and blooming throughout the year. The bitter root, ground small and mixed with lime-juice and root of *Acorus Calamus*, is considered in India a good remedy for ringworm and herpes. In Cochin China a decoction of the leaves and branches of *J. nervosum* is taken as a blood-purifier; and the bitter leaves of *J. floribundum* (called in Abyssinia "Habbez-zelim") mixed with Kousso is considered a powerful anthelmintic, especially for tape-worm; the leaves and branches are added to some fermented liquors to increase their intoxicating quality. In Sierra Leone a poultice made with the leaves of *J. noctiflorum* is applied to ulcers. The leaves of *J. hirsutum* boiled in oil are applied in India and China in cases of ophthalmia, and its root is said to be a really good remedy for snake bites. In Catalonia and in Turkey the wood of the jasmine is made into long, slender pipe-stems, highly prized by the Moors and Turks. Syrup of jasmine is made by placing in a jar alternate layers of the flowers and sugar, covering the whole with wet cloths and standing it in a cool place; the perfume is absorbed by the sugar, which is converted into a very palatable syrup.



The plant known in America as the "Carolina jasmine" (fig. 2) is not a true jasmine (see *GELSENIUM*). Other hardy species commonly cultivated in gardens are the low or Italian yellow-flowered jasmine, *J. humile*, an erect shrub 3 or 4 feet high, with angular branches, alternate and



FIG. 2.—*Gelsemium*, half natural size; flower, nat. size.

mostly ternate leaves, blossoming from June to September; the common yellow jasmine, *J. fruticosum*, a hardy deciduous shrub, 10 to 12 feet high, with weak, slender stems requiring support, and bearing yellow, odourless flowers from spring to autumn; and *J. nudiflorum*, which flowers before the leaves appear. (J. CH. S.)

JASON, grandson of the god Poseidon or of the king Crætheus, is by this descent as by his name (*Ἰάσων*, *Ἰάσος*, *Ἰάσων*, &c., can hardly be separated from *Ἰάσ*, *Ἰαστί*, *Ἰάσος* &c., see Curt., *Gr. Gesch.*, i., note 34) connected with the seafaring Ionians and their Poseidon religion. He was the leader of the Argonautic expedition, for the details of which see ARGONAUTS. After he returned from it he lived at Corinth with his wife Medea for many years. At last he put away Medea, in order to marry Glauce, daughter of the Corinthian king Creon. The revenge which Medea took on Jason's new wife and on her own children by him, is the subject of Euripides's greatest play. The story of Jason is one of the most famous in Greek mythology, and has run through a long course of development. Stripping off the later embellishments of poetic fancy, we find that the main outlines were not completed till the voyages of the Eubœan mariners to the Hellespont and the Euxine determined the order of the incidents of the outward voyage. Beneath this outward form we find that the scenes of Jason's life are the places where Ionian mariners exerted most influence—the coasts of Thessaly and Bœotia, the Ægean islands, Corinth, and the Adriatic shores; moreover, the Minyæ, who supplied most of the Argo's crew, are closely connected with the old Ionians. The myth therefore was an accompaniment of the religion carried with them by these mariners, and preserves to us the memory of a genuine connexion once existing between these widely separate places. We can analyse the legend still further, determining the religious centre round which this historical framework has been constructed; this we shall find to be one of the commonest naturalistic myths. The sun, the ram with the golden fleece, flies through the air to the land at once of setting and of rising sun; there he is sacrificed on the shore in the fire of sunset; his skin is hung upon the tree of the nightly heaven, and guarded by

the envious power, the dragon, till it is captured by the solar hero, by whom the darkness is dispelled and the dragon slain.

JASPER, an opaque close-grained variety of quartz, variously tinted, but usually either red or brown,—the colour being due in the former case to the presence of peroxide of iron, and in the latter to the same oxide in a hydrated condition. Frequently the colour is not uniform, and if the tints be disposed in stripes or bands the mineral is termed *riband jasper*. A brown jasper occurring in nodules, and exhibiting variations of tint arranged in zones, is termed, from its locality, *Egyptian jasper*. Although the term jasper is now restricted to such varieties of quartz as present opacity, it is certain from the descriptions of classical writers that their *jaspis* or *Ἰασπίς* was a stone of considerable translucency. The original jasper appears to have been green, inasmuch as it is often compared with the emerald and other green objects. Probably the jasper of the ancients included stones which we should now class as chalcedony and agate, while our jasper was then known as the *achates*. The emerald-like jasper appears to have been a green chalcedony, like the plasma and chrysoprase of modern mineralogists.

See Rev. C. W. King's *Natural History of Precious Stones*, 1865.

JASSY, JASIL, or JASCHI, formerly the capital of the principality of Moldavia, and now the chief town of a district in Roumania, is situated in the valley of the Bahlui (a tributary of the Pruth), in 47° 10' N. lat. and 27° 30' E. long., about 200 miles to the north of Bucharest. The surrounding country consists of hill and dale, and the town with its widely scattered houses intermingled with trees occupies two eminences, of which the one has a rapid and the other a very gradual ascent. The exterior aspect of the place is decidedly attractive and imposing; but the character and condition of the interior is disappointing. A large number of the houses are built of wood, the streets are irregular and dirty, and there is no satisfactory drainage. Since 1873, however, the principal streets have been paved with asphalt, &c. by W. O. Callender of London, at a cost to the town of £200,000. Jassy is the residence of a prefect, and the see of the archbishop of Moldavia; and it has a court of the first instance, a court of appeal, a number of synagogues, and about forty-seven Greek churches, including the cathedral and the church of the monastery of St Spiridion, a museum with a public library, a fine hall, and a theatre. Besides the university (which has three faculties—law, letters, and philosophy—and in 1876 numbered 23 professors and 146 pupils), there are two gymnasia in the town, one academy, several national schools (both girls' and boys'), and upwards of twenty private schools. The foundation of St Spiridion (due to the liberality of Gregorius Ghika in 1727, and available for the sick of all countries and creeds) has an income of nearly £50,000 per annum, and maintains hospitals in several towns of Moldavia. The main hospital in Jassy is a large building, and possesses a maternity institution, a midwifery school, and other auxiliaries. A society of physicians and naturalists has existed in Jassy since the early part of the century, and a number of periodicals are published in the town. In the vicinity are Belvedere Castle (the residence formerly of Stourza Citacnie), the mineral springs and convent of Galata, the water-cure establishment of Rapide, and the great ecclesiastical college of Socola. The industrial activity of Jassy is but slight,—a tobacco factory, a flour-mill, a brewery, and two or three small manufactories of aerated water making the total sum in 1878. The trade of the town is mainly in the hands of the Jews, who form a large and increasing proportion of its 90,000 inhabitants. By a branch line to Pascani, Jassy communicates with the Austrian railway system, and by a

fine to Unghani with that of Russia. The town is governed by a mayor and council. Its income is to a considerable extent derived from a tax on the wines.

<sup>d</sup> The inscription by which the existence of a *Jassiorum municipium* in the time of the Roman empire is sought to be proved lies open to grave suspicion; but the town is mentioned as early as the 14th century, and probably does derive its name from the Jassians, or Jazygians, who accompanied the Cumanian invaders. About 1564 it was made the capital of Moldavia, instead of Suczava, by Alexander Lapusenu. It was reduced to ashes by Sultan Soliman in 1533, and by Sobieski in 1686. By the peace of Jassy the second Russo-Turkish war was brought to a close in 1792. A Greek insurrection under Ypsilanti in 1821 led to the storming of the town by the Turks in 1822. In 1844 there was a severe conflagration. For the loss caused to the town in 1861 by the removal of the seat of government to Bucharest the constituent assembly voted £148,150, to be paid in ten annual instalments, but no payment has been made.

JÁSZ-BERÉNY, a corporate town of Hungary, and formerly capital of the Jászság (Jazygiá) district (since 1876 incorporated with the Cis-Tisian county of Jász-Nagy-Kun-Szolnok), is pleasantly situated on both banks of the Zagyva, crossed there by a stone bridge, and on the Hatvan-Szolnok line of railway, 39 miles east of Budapest, 47° 29' N. lat., 19° 57' E. long. It is the seat of a royal court of law and a circuit court, and has several churches, one of which is large and handsome, a Franciscan monastery, a Roman Catholic gymnasium, a high school, a guard house, and an elegant town-hall, in which are preserved archives of considerable importance. In the centre of the town the channels of the Zagyva form two islands, which are planted with trees and laid out as promenades. On one of these stands a marble bust erected (1797) in honour of the Palatine Archduke Joseph. Not far from the same place are the ruins of a fortress, where it is popularly believed that Attila, king of the Huns, was buried (453). The inhabitants of the town and neighbourhood are much engaged in agricultural pursuits and in pasturing horses, cattle, and sheep on the vast communal lands. Fairs are periodically held in the town, and the trade in field produce, fruit, grain, and cattle is generally brisk. The population at the end of 1880 amounted to 21,781, chiefly Magyars by nationality, and Roman Catholics by creed.

JÁTIVA, or SAN FELIPE DE JÁTIVA, according to the old orthography XÁTIVA, a city of Spain in the province of Valencia, is picturesquely situated on the margin of a beautiful and fertile huerta or plain, at the foot of an overhanging eminence, on the right bank of the Albáida, a tributary of the Júcar. The principal public building is the collegiate church, begun in 1414; it has a fine dome. There are three parish churches besides, and twelve religious houses, also a hospital. The manufactures of the place are unimportant, and its trade purely local. The population in 1877 was 14,534.

<sup>b</sup> Játiva, the *Sctabis* of Pliuy and Martial, was celebrated in the time of the Romans for its linen manufactures. It was then known also as *Valeria Augusta*. It is believed to have been of Phœnician origin. During the time of the Moors, who knew how to utilize its fine situation and fertile neighbourhood, it enjoyed great prosperity. It was taken in 1224 by Jaime I. of Valencia; and in 1347 it received the rank of a city. In the succession war it sustained a long siege with great firmness and bravery, and, when taken at last, received from its captors the name of San Felipe. Játiva was the birthplace of the painter Ribera (1588), and to it also the historical family of the Borgias or Borjas originally belonged.

JÁTS, an Indian people estimated to form two-fifths of the entire population of the Punjab and half that of the Rájput states. They are also widely spread through Sind, Baluchistan, and the North-Western Provinces. Their traditions indicate an immigration from Ghazni or Kandahar, but writers of authority have identified them with the ancient Getae,<sup>1</sup> and there is strong reason to

believe them a degraded tribe of Rájputs, whose Scythic origin has also been maintained. Dr Trumpp,<sup>2</sup> however, regards them as the first Aryan settlers in the valley of the Indus, and their language strongly favours this view. The Játaki, or Ját vernacular, retained by them with singular tenacity, is a variety of Siadhi, and a pure Sanskrit tongue, exhibiting unusually early grammatical forms. Hindu legends point to a prehistoric occupation of the Indus valley by this people, and at the time of the Mahometan conquest of Sind (712 A.D.) they, with a cognate tribe called Meds, constituted the bulk of the population. They enlisted under the banners of Mohammed Kásim, but at a later date offered a vigorous resistance to the Arab invaders. In 836 they were overthrown by Amran, who imposed on them a tribute of dogs, and used their arms to vanquish the Meds. In 1025, however, they had gathered audacity, not only to invade Mansura, and compel the abjuration of the Mussulman emir, but to attack the victorious army of Mahmúd, laden with the spoil of Semnánh. Chastisement duly ensued: a formidable flotilla, collected at Múltán, shattered in thousands the comparatively defenceless Ját boats on the Indus, and annihilated their national pretensions. In recent times the valour of the race showed itself in the two sieges of Bhartpur, the seat of a Ját dynasty, in 1805 and 1826, and has long been conspicuous in the military qualities of the Sikhs. They are a migratory stock. We hear of early Ját settlements on the shores of the Persian Gulf; there was in the 9th century a Ját quarter in Antioch; and a colony established in the Chaldean marshes defied during twenty-four years the power of the caliphs, and was finally vanquished and deported to the Cilician frontier in 834. The Játts are now mainly agriculturists and cattle breeders, rearing with extraordinary skill and care large flocks of camels, in the Mekran and the desert tracts of Sind. In their settlements on the Ganges and Jumna, extending as far east as Bareilly, they are divided into two great clans, the Dhe and the Hele; while in the Punjab there are said to be one hundred different tribes. Their religion varies with locality. East of the Rávi they profess a modified Brahmanism, discarding the restrictions of caste; in the Punjab they have largely embraced Sikh tenets; while in Siad and Baluchistan they are Mahometans. They are in general a harmless, industrious people, preserving in songs and legends the memory of better times. Under favourable conditions, however, old predatory habits revive, and their wandering instinct leads them, in the guise of itinerant traders, far into Central Asia. Indeed, there is plausible though not conclusive evidence that the Gipsies owned them as progenitors.<sup>3</sup> In appearance they are not ill-favoured, though extremely dark; they have good teeth, and large beards, sometimes stained with indigo. Their inferiority of social position, however, to some extent betrays itself in their aspect, and tends to be perpetuated by their intellectual apathy.

JAUBERT, PIERRE AMÉDÉE EMILIE PROBE (1779–1847), French Orientalist, was born at Aix in Provence, June 3, 1779. He was one of the most distinguished pupils of the Orientalist Silvestre de Sacy, whose funeral *Discours* he pronounced in 1838. Jaubert acted as interpreter to Napoleon in Egypt in 1798–99, and on his return to Paris held various posts under Government. In 1802 he accompanied Sebastiani on his Eastern mission; and in 1804 he was with General Brune at Constantinople. Next year he was despatched to Persia to arrange an

<sup>2</sup> *Zeitschrift d. Deutsch. Morg. Gesellschaft*, xv. p. 690, and "Die heutige Bevölkerung des Panjab," in *Mittheilungen d. anthropol. Gesellsch. in Wien*, 1872.

<sup>3</sup> See GIPSIES, vol. x. p. 617; also *Edinburgh Review*, No. 303–p. 131.

<sup>1</sup> See article *INDIA*, vol. xii. p. 789.



alliance with the shah; but on the way he was seized and imprisoned in a dry cistern for four months by the pasha of Bayazid. The pasha's death freed Jaubert, who successfully accomplished his mission, and rejoined Napoleon at Warsaw in 1807. In 1818 he undertook a journey with Government aid to Tibet, whence he succeeded in introducing into France 400 Cashmere goats. The rest of his life Jaubert spent in study, in writing, and in teaching. He became professor of Persian in the Collège de France, and in 1830 was elected member of the Académie des Inscriptions. In 1841 his erudite services were still further rewarded by admission to the peerage of France, and by the rank of counsellor of state. He died at Paris, January 27, 1847.

Besides articles in the *Journal Asiatique*, we have from Jaubert *Voyage en Arménie et en Perse, fait dans les années 1805-6, 1821* (the edition of 1860 has a notice of Jaubert, by M. Süßmilch); *Éléments de la Grammaire Turque*, 1823; *Géographie d'Édrise*, 1824; *Vie de Djenghiz Khan*, 1841; and *Relation de l'ambassade de Mohammed Seid Wahil Effendi (Tartar Turque)*, 1843. He also revised Meyendorff's *Voyage d'Orskanbourg à Boukhara*, 1826; and abridged Venturo's "*Grammaire et Dictionnaire de la langue Berbère*," 1824 (in *Recueil de Voyages de la Société de Géographie*, tome vii.). See notices in the *Journal Asiatique*, January 1847, and the *Journal des Débats*, January 30, 1847.

JAUER, chief town of a circle in the government district of Liegnitz, in the province of Silesia, Prussia, is situated on the Wüthende Neisse. St Martin's church, recently renovated, dates from 1267-90, and the evangelical church from 1655. The castle has been a penitentiary since 1746; and in the town there is a Protestant gymnasium and a hospital. Jauer manufactures leather, buckskin, carpets, cigars, carriages, and gloves, and is specially famous for its sausages. Its weekly grain and cattle market was instituted in 1404. The population in 1875 was 10,404.

Jauer was formerly the capital of a principality embracing 1200 square miles of the principality of Schweidnitz, now occupied by the circles of Jauer, Bunzlau, Löwenberg, Hirschberg, and Schönau. It was separated from Schweidnitz in 1314, but lapsed to the Bohemian crown in 1392. Jauer was formerly the prosperous seat of the Silesian linen trade, but the troubles of the Thirty Years' War, in the course of which it was burned down three times, permanently injured it.

JAUHARY. Abu Nasr Isma'il ibn Hammád el-Jauhary of Fáráb, a district beyond the Jaxartes, on the borders of Turkestan, is one of the fathers of Arabic lexicography. After the fashion of the older Arabic philologists he completed his studies by a residence among the tribes of the Arabian desert, and finally established himself at Naisápúr, where he died by a fall from the roof of his house, leaving the revision of his great lexicon, the *Sihâh fi'l-Lughah*, incomplete. According to some accounts he committed suicide in a fit of insanity. Hájji Khalifa (iv. 91) places his death 303 A.H. (1002-3 A.D.); others give 398 or 400.

The *Sihâh* has been repeatedly printed in the East, as at Bülák 1282 (1865), and again in 1875. Of the edition projected by Ev. Scheidius, only one part appeared in 1776. See Hamaker, *Spec. Cat.*, p. 48; Dozy, *Leyden Catalogue*, i. 67; Pertsch, *Gotha Cat.*, No. 378; H. Khalifa, *ut supra*.

JAULNA. See JÁLNA.

JAUNDICE (Fr. *Jaunisse*, from *jaune*, yellow), or ICTERUS (from its resemblance to the colour of the golden oriole, of which Plioy relates that if a jaundiced person looks upon it he recovers but the bird dies), a term in medicine applied to a yellow coloration of the skin and other parts of the body, depending in most instances on some derangement affecting the liver. This yellow colour is due to the presence in the blood of bile or of some of the elements of that secretion. Jaundice, however, must be regarded more as a symptom of some morbid condition previously existing than as a disease *per se*.

The manner in which jaundice is produced is still a

matter of debate among physicians, but it is generally admitted that there are two classes of causes, either of which may bring about this condition. In the first place any obstruction to the passage of bile from the liver into the intestinal canal is sooner or later followed by the appearance of jaundice, which in such circumstances is due to the excessive absorption of bile into the blood. To this variety the term *obstructive* jaundice is applied. But secondly, a form of jaundice may be produced by causes not embracing obstruction, but including a variety of morbid conditions affecting either the secreting structure of the liver or the state of the blood, and to this the term *non-obstructive* jaundice is applied.

*Obstructive jaundice* may be due to the following causes:—(1) simple catarrh of the hepatic and common bile duct (see DIGESTIVE ORGANS), whereby the calibre of these channels is narrowed (this is frequently the result of cold or of temporary gastric disturbance, but it may become a chronic condition); (2) impaction of gall stones or plugs of hardened mucus in the ducts; (3) general congestion of the liver, either alone or in connexion with pre-existing disease in the heart or lungs; and (4) pressure of morbid growths either external to the liver or in its substance.

Obstruction from these causes may be partial or complete, and the degree of jaundice will vary accordingly, but it is to be noted that extensive organic disease of the liver may exist without the evidence of obstructive jaundice.

The effect upon the liver of impediments to the outflow of bile such as those above indicated is in the first place an increase in its size, the whole biliary passages and the liver cells being distended with retained bile. This enlargement, however, speedily subsides when the obstruction is removed, but should it persist the liver ultimately shrinks and undergoes atrophy in its whole texture. The bile thus retained is absorbed into the system, and shows itself by the yellow staining seen to a greater or less extent in all the tissues and many of the fluids of the body. The kidneys, which in such circumstances act in some measure vicariously to the liver and excrete a portion of the retained bile, are apt to become affected in their structure by the long continuance of jaundice.

The symptoms of obstructive jaundice necessarily vary according to the nature of the exciting cause, but there generally exists evidence of some morbid condition before the yellow coloration appears. Thus, if the obstruction be due to an impacted gall stone in the common or hepatic duct, there will probably be the symptoms of intense suffering characterizing "hepatic colic" (see COLIC), after which the jaundice appears. In the cases most frequently seen—those, namely, arising from simple catarrh of the bile ducts due to gastro-duodenal irritation spreading on to the liver through the common duct—the first sign to attract attention is the yellow appearance of the white of the eye, which is speedily followed by a similar colour on the skin over the body generally. The yellow tinge is most distinct where the skin is thin, as on the forehead, breast, elbows, &c. It may be also well seen in the roof of the mouth, but in the lips and gums the colour is not observed till the blood is first pressed from them. The tint varies, being in the milder cases faint, in the more severe a deep saffron yellow, while in extreme degrees of obstruction it may be of dark brown or greenish hue. The colour can scarcely, if at all, be observed in artificial light.

The urine exhibits well marked and characteristic changes in jaundice which exist even before any evidence can be detected on the skin or elsewhere. It is always of dark brown colour resembling porter, but after standing in the air it acquires a greenish tint. Its froth is greenish-yellow, and it stains with this colour any white substance. It contains not only the bile colouring matter but also the

bile acids. The former is detected by the play of colours yielded on the addition of nitric acid, the latter by the purple colour produced by placing a piece of lump sugar in the urine tested, and adding thereto a few drops of strong sulphuric acid. This test for the bile acids is dwelt upon by Dr George Harley as an important point in serving to distinguish jaundice with obstruction from jaundice without obstruction, in the latter of which, although there is bile pigment in the urine, the bile acids are absent.

The contents of the bowels also undergo changes, being characterized chiefly by their pale clay colour, which is in proportion to the amount of hepatic obstruction, and to their consequent want of admixture with bile. For the same reason they contain a large amount of unabsorbed fatty matter, and have an extremely offensive odour.

Constitutional symptoms always attend jaundice with obstruction. The patient becomes languid, drowsy, and irritable, and has generally a slow pulse. The appetite is usually but not always diminished, a bitter taste in the mouth is complained of, while flatulent eructations arise from the stomach. Intolerable itching of the skin is a common accompaniment of jaundice, and cutaneous eruptions or boils are occasionally seen. Yellow vision appears to be present in some very rare cases. Should the jaundice depend on advancing organic disease of the liver, such as cancer, the tinge becomes gradually deeper, and the emaciation and debility more marked towards the fatal termination, which in such cases is seldom long postponed. Apart from this, however, jaundice from obstruction may exist for many years, as in those instances where the walls of the bile ducts are thickened from chronic catarrh, but where they are only partially occluded. In the common cases of acute catarrhal jaundice recovery usually takes place in two or three weeks.

The treatment of this form of jaundice bears reference to the cause giving rise to the obstruction. In the ordinary cases of simple catarrhal jaundice, or that following the passing of gall stones, a light nutritious diet (milk, soups, &c., avoiding saccharine and farinaceous substances and alcoholic stimulants), along with counter-irritation applied over the right side, and after a few days the use of laxatives which tend to promote the flow of bile, will be found to be advantageous. Rhubarb, taraxacum, podophyllum, mercury, are among the remedies which have long been employed for this purpose, but the recent researches of Professor Rutherford have brought to light certain other agents (euonymin, iridin, leptandrin, &c.), which exercise a powerful influence as cholagogues, and are now coming into use. Diaphoretics and diuretics to promote the action of the skin and kidneys are useful in jaundice. In the more chronic forms, besides the remedies above named, the waters of Carlsbad are of special efficacy. Where the jaundice depends on changes in the substance of the liver, altering its structure, such as cancerous deposit, all that can be accomplished is the palliation of symptoms, including the jaundice, which may be mitigated by the treatment already indicated. With the view of supplying bile to the alimentary canal, Dr Harley recommends the use of inspissated ox-gall in doses of 5 to 10 grains administered in capsules of gelatin.

2. *Jaundice without obstruction* is observed to occur as a symptom in certain fevers, e.g., yellow fever, ague, and relapsing fever, and in pyæmia (blood poisoning), also as the effect of the action of certain poisonous substances, such as copper, mercury, antimony, phosphorus, &c., and the venom of snake bites. It is occasionally seen in new-born infants. It is sometimes suddenly induced as the result of strong mental excitement or emotion. Much difficulty has always been felt to account for this form of jaundice, and numerous theories have been advanced to explain its

occurrence. Many of such cases might probably, as Virchow observes, be found on careful investigation to depend on some obstruction in the biliary passages; but there can be no doubt that many others admit of no such explanation, and as regards these it is generally held that they are probably connected with some alteration in the colouring matter of the blood, the source, it is believed, of the bile pigment. Others suppose this form of jaundice to be due to an excess in the normal reabsorption of bile into the blood. The pathology, however, is still unsettled. Jaundice of this kind is almost always slight, and neither the urine nor the discharges from the bowels exhibit changes in appearance to such a degree as in the obstructive variety. Grave constitutional symptoms are often present, but they are less to be ascribed to the jaundice than to the disease with which it is associated.

The name *malignant jaundice* is sometimes applied to that very fatal form of disease otherwise termed acute yellow atrophy of the liver. See ATROPHY. (J. O. A.)

JAUNPUR, a British district in the lieutenant governorship of the North-Western Provinces, India, lying between 25° 23' 15" and 26° 12' N. lat., and between 82° 10' and 83° 7' 45" E. long. It forms the north-eastern district of the Allahâbâd division, and is bounded on the N. and N.W. by the Oudh districts of Faizâbâd, Partabgarh, and Sultanpur, on the E. and N.E. by Ghâzipur and Azamgarh, on the S. by Benares and Mirzâpur, and on the W. by Allahâbâd.

The district of Jaunpur forms part of the wide Gangetic plain, and its surface is accordingly composed of a thick alluvial deposit. The whole country is closely tilled, and no waste lands break the continuous prospect of cultivated fields. The northern and central positions are richly wooded. The district is divided into two unequal parts by the sinuous channel of the Gumti, a tributary of the Ganges, which flows past the city of Jaunpur. Its total course within the district is about 90 miles, and it is nowhere fordable. It is crossed by two famous bridges, one at Jaunpur and the other 2 miles lower down. The other rivers are the Sai, Barna, Pili, and Basohi. Lakes are numerous in the north and south; the largest has a length of 8 miles.

The census of 1872 was taken upon an area of 1556 square miles, and it disclosed a total population of 1,025,961, of whom 545,752 were males and 480,209 females. Jaunpur is essentially a Hindu district, in spite of its long subjection to Mahometan rulers. The returns show 929,525 Hindus to 96,319 Mahometans; the Christian population (European and native) numbers 117. There are only two towns with more than 5000 inhabitants.—Jaunpur, 23,327, and Machhlisahr, 8715.

The ordinary soil of Jaunpur is a mixture of mould, clay, and sand; but in old river beds and the basins of temporary lakes a rich black alluvial deposit may occasionally be found. The harvests are those common to the rest of Upper India. The crops yielded are cotton, rice, *bâjra*, *jow*, *moh*, wheat, barley, oats, pease, and other pulses. Sugar yields the greatest profit, but it requires great care. Indigo, poppy, tobacco, and vegetables are also cultivated. The Gumti is liable to sudden inundations during the rainy season, owing to the high banks it has piled up at its entrance into the Ganges, which act as dams to prevent the prompt outflow of its flooded waters. These inundations extend to its tributary the Saf. Much damage was thus effected in 1774; but the greatest recorded flood took place in September 1871, when 4000 houses in the city were swept away, besides 9000 more in villages along its banks. On the other hand, Jaunpur has been comparatively free from drought, the great plague of the north-west generally, as of the rest of India. The district is almost entirely devoted to agriculture, and its trade is confined to raw materials and food-stuffs. The principal fairs are held at Mariâhu in September, and at Karchuli in March; they are attended by from 20,000 to 25,000 pilgrims and traders. The Oudh and Rohilkhand railway passes through the district. There are 145 miles of metalled and 364 of unmetalled roads. The Gumti and Saf are navigable for boats of moderate burden. The climate is moist, and the temperature is more equable, and the rain more evenly distributed throughout the year, than in most districts of the North-Western Provinces. The average rainfall for 1861-70 was



43 inches; during that period the maximum was 51·6 inches, the minimum 22 inches. There are two charitable dispensaries.

In prehistoric times Jaunpur seems to have formed a portion of the Ajodhya principality, and when it first makes an appearance in authentic history it was subject to the rulers of Benares. With the rest of their dominions it fell under the yoke of the Musalmán invaders in 1194. From that time the district appears to have been ruled by a prince of the Kanauj dynasty, as a tributary of the Mahometan suzerain. In 1388 Malik Sarwar Khwája was sent by Mahammad Tughlak to govern the eastern province. He fixed his residence at Jaunpur, made himself independent of the Delhi court, and assumed the title of Sultán-us-Shark, or eastern emperor. For nearly a century the Sbariki dynasty ruled at Jaunpur, and proved formidable rivals to the sovereigns of Delhi. The last of the dynasty was Sultán Hussien, who passed his life in a fierce and cherished struggle for supremacy with Bahlol Lodi, then actual emperor at Delhi. At length, in 1478, Bahlol succeeded in defeating his rival in a series of decisive engagements. He took the city of Jaunpur, but permitted the conquered Hussien to reside there, and to complete the building of his great mosque, the Jamá Masjid, which now forms the chief ornament of the town. Many other architectural works in the district still bear witness to its greatness under its independent Musalmán rulers. Under the Lodi dynasty the history of Jaunpur contains nothing more than the stereotyped narrative of provincial intrigue, constant revolt, and bloody repression. When the last of that line was killed, a local kingdom was once more established for a short time in the district, but after the fall of Agra and Delhi Jaunpur was recovered, and the district thenceforward formed a portion of the Mughal empire. Nothing worthy of note occurred in connexion with this district until 1722, when it was transferred, with Benares, Gházipur, and Clunár, to the nawáb wazir of Oudh, who appointed a commander to the districts with the title of rájá of Benares. The first connexion of the British with the district arose in 1765, when it passed for a short time into their hands after the battle of Baxar. In 1775 it was finally made over

to them by the treaty of Lucknow. From that time nothing occurred which calls for notice till the date of the mutiny. On the 5th June 1857, when the news of the Benares revolt reached Jaunpur, the Sikhs mutinied. The district continued in a state of complete anarchy till the arrival of the Gurkhá force from Azangarh in September. In November the surrounding country was lost again, and it was not till May 1858 that the last smouldering embers of disaffection were stifled by the repulse of the insurgent leader at the hands of the people themselves.

JAUNPUR, a municipal town and the administrative headquarters of the above district, situated in 25° 41' 31" N. lat. and 82° 43' 38" E. long., on the northern bank of the river Gumti. Jaunpur is a very ancient city, the former capital of a considerable Mahometan kingdom, which once extended from Budáun and Etáwah to Behar. It abounds in splendid architectural monuments, most of which belong to the Pathán period, when the rulers of Jaunpur made themselves independent of Delhi. Among the remains are the fort of Firoz, the *hammams* or baths, the Atála Masjid and the Juijiri Masjid, mosques built by Ibráhím, the Dariba mosque constructed by two of Ibráhím's governors, the Lal Darwáza erected by the queen of Mahmud, the Jamá Masjid or great mosque of Hussien, and the splendid bridge over the Gumti, erected by Mumzin Khán, governor under the Mughals, in 1569-73. During the mutiny of 1857 Jaunpur formed a centre of great disaffection. The town still possesses a considerable trade. There are two railway stations there. The population in 1872 was 23,327, comprising 12,369 Hindus and 10,949 Mahometans and 9 "others."

## J A V A

PLATE VIII. **J**A MONG the islands of the Indian archipelago Java is not the largest, being surpassed in this regard by Borneo, New Guinea, Sumatra, and Celebes; but in every other respect it is the most important of them all. It has passed through the most remarkable vicissitudes, has been the scene of the most eventful occurrences, and possesses the noblest memorials of bygone splendour. It supports a larger population than all the other islands of the Indian Ocean together, a population as dense indeed as that of the most populous of European countries. In natural beauty it rivals the most favoured regions of the world. Through the mildness of its climate and the industry of its people it possesses a richer store of valuable productions than almost any country of equal extent can boast: its rice-fields make it the granary of the East Indian islands, and its coffee and sugar plantations are a perpetual source of wealth to Holland, the country which has the good fortune to claim its allegiance.<sup>1</sup>

Java lies between 105° 10' and 114° 34' E. long., and between 5° 52' and 8° 46' S. lat. Its greatest length—measured from Pepper Bay in the west to Banyuwangi in the east—amounts to no less than 622 miles; its greatest breadth—from Cape Bugel in Japara to the south coast of Jokjokarta—is only 121. The area is estimated at 49,176 square miles, nearly four times that of Holland (12,731 square miles). Both physically and administratively the island of Madura, separated from the main island by a narrow strait, must be taken along with Java; and the same is more or less the case with a number of smaller islands—Pulo Panitan or Princes' Island, lying off the most western promontory, the Thousand Islands, the Karimon-Djawa (Carimon Java) archipelago, about 50 miles to the north of Japara, Bawean (Bavean), a little further to the north of Madura, the Sumanap islands to the north-east of Madura, and Deli, Tindjil, Nusa Kambangan, Sempu, and Nusa Barung off the south coast. These all being

included, the area of what is officially known as Java and Madura amounts to 51,961 square miles.<sup>2</sup>

There is a striking difference between western and eastern Java in the main features of relief. The western portion, exclusive of the northern alluvial coast-land, is a compact mass of mountains culminating in volcanic peaks nowhere interrupted by plains or lowland valleys. In the eastern and larger portion the volcanoes rise in independent clusters, and the valleys between open out into wide champaigns. Even in the east the number of volcanic eminences is exceptionally large; and, if the whole island be taken into view, there is scarcely any region of the world of equal extent which can boast of so many. The following are those which are still in a state of activity:—Gedé (the most western), Tangkuban Prahu, Guntur, Pepandayan, Telaga Bodas, Galung-gung, Tjermé, the Slamát (sometimes called Gedé), Sendará, Sumbing, Merapi, Lawu, Wilis (I), Kelut, Ardjuná, Kawi (I), Tenger, Smeru or Semeru, Lamongan, Rawun, and Idjen. The loftiest of them all is Semeru, with a height of 12,238 English feet.<sup>3</sup>

<sup>2</sup> The orthography of East Indian names is far from constant. Even in the same Dutch book Madura and Madoera, Jokjakarta, Djokjokarta, and Djokdjokarta are to be found. In the present article the *Dj* or *J* is usually given in the more English form of *J*, the *oe* as *u*, and so on.

<sup>3</sup> See Junghuhn's *Java*. Chronological lists of the eruptive and seismic phenomena of the island, and indeed of all the Indian archipelago, are given from time to time in the *Nat. Tijds. voor Ned. Ind.* From Dr Bergsma's report in the volume for 1880 it appears that in 1878 there were sixteen distinct earthquakes registered throughout the island. That both volcanoes and earthquakes are not without present importance among the physical agencies engaged in the new shaping of the land is shown by such facts as the following:—in 1843, according to Junghuhn's estimate, Mount Guntur flung forth ashes and sand to the extent of 30 million tons; by the great eruption of Mount Galung-gung in 1822, no fewer than 114 villages were laid waste and 4000 persons destroyed; in 1867 an earthquake caused the death of 1000 people in the town of Jokjokarta alone; in 1872 the eruption of Merapi (one of the most active of the volcanoes) proved fatal to many of the inhabitants of Kadu; and the damage to be feared from the ashes thrown out by the same mountain interferes with the

<sup>1</sup> The above general description is taken from the *Java* of Professor Veth of Leyden, the standard work on the subject.

The central ridge, in which, with the single exception of Muriá, all the volcanic peaks are situated, contains a large number of other summits upwards of 6000 feet in height, and several—such as Wallet, Pangerangu, Merbabu, Gunung Butak, G. Weliran, G. Argowulan, the Yang (Jang) mountains, G. Rante—rise beyond 9000 feet. On both the north and south sides the volcanic chain is flanked by ranges composed of Tertiary rocks; these attain an elevation on the south frequently of between 2000 and 4000 feet, and occasionally in the Preanger Regencies of 5000 or 6000 feet. To the northern flanking range belongs the whole of the island of Madura, which has its highest point in Gunung Tambuko (1541 feet). The northern versant of Java differs from the southern in the great development of its alluvial border, which in one or two places widens out into considerable plains, and from this it naturally results that the streams flowing into the Sea of Java are both in length of course and volume of water more important than those that fall into the Indian Ocean. Their number in both cases is very great; but none even of the northern streams are navigable for vessels of burden, and only a few for boats beyond the reach of the tide. They are all more or less obstructed by mud or sandbanks at their mouths. In the Sunda lands the river names are usually introduced by *Tji*; the Sunda word for river; the equivalent *Kali* is prefixed less frequently to the names in the Javanese portions of the island. The largest and in some aspects the most useful of all the rivers is the Bengawan, or river of Solo, so called from Solo, the popular name of the city of Surakarta. It is in the residency of Surakarta that it takes its rise in the plain bounded by Merapi on the W., by Lawu on the E., and by Gunung Kidul on the S., and it flows through the residencies of Madiun, Rembang, and Surabaya. Except for the last three months of the dry season it is navigable for large boats, and during the whole year for small ones. Next in magnitude to the Solo is the Brantas, called in its lower part the Kalimas, and by Europeans the river of Surabaya. Both rivers debouch into the strait of Madura, and the rapid formation of alluvial deposits in the neighbourhood of their mouths gives abundant proof of their disintegrating agency. In 1818 the largest vessels were able to anchor in the roadstead of Surabaya; by 1825 considerable caution had to be observed; and it speedily became evident that the northern approach would soon be completely closed. Between 1850 and 1854 the lower part of the Solo river was diverted into a new channel, and a permanent fairway seemed to be secured. But the condition of the strait has again been the object of solicitude, and two different schemes have been under consideration for the removal of the lower course of the river still further to the north. All along the north coast of Java similar accretions of land are taking place; and steam dredgers have to be kept at work in all the important harbours.

The endless disturbances produced in the original condition of the strata by the continued activity of the volcanic forces render the task of the geologist peculiarly difficult. The volcanic rocks for the most part appear to rest on sedimentary rocks, and these in their turn are pretty certainly supported by granite and syenite. That the sedimentary rocks should all (the modern alluvium of course being excluded) be assigned to the Tertiary period was argued by Junghuhn from the fact that in spite of

planting of coffee in the districts of Proboling and Remaneh. In 1879 the Preanger Regencies were visited by several severe shocks, and a number of persons were killed. Besides the volcanoes themselves, there are a number of striking forms of volcanic activity to be observed in the island, such as the so-called mud-volcano at Brobogang, the gas-fountains or holy-fires of Melati Derat, and the Pakaraman or Gnja Upas (Valley of Poison) in Banyumas on the Dieng mountains. Hot springs are common.

their difference in composition and character they all contain the same class of fossils; but a few striking examples of fossils and formations that must belong to the diluvial division of the Quaternary period have been pointed out by Staring and Verbeek. Throughout the rocks remains of vertebrates are exceedingly scarce; but of invertebrates there is a great profusion.<sup>1</sup>

In keeping with its geological structure, Java appears in general to be in the matter of economic minerals the poorest of the great islands of the archipelago.<sup>2</sup> Coal is very common, in thin strata and small "pockets," both in Java itself and in Madura and the lesser islands, but it has hitherto been found impossible to turn it to any considerable account. A variety of clays fit for bricks, earthenware, and porcelain, a peculiar kind of clay (*ampo*) eaten as a dainty by the natives, good limestone and marble, petroleum, and sulphur have been more or less regularly worked. Salt is obtained from the mud wells of Kuwu and Selo (Samarang), and saltpetre at Sutji in the department of Gresik.

*Climate.*—Java being situated but a short distance from the equator, with the wide expanse of the Indian Ocean extending to the south, the climate is one of tropical heat and moisture.

At Batavia, the only place where a long series of meteorological observations is available, the greatest maximum temperature of the air between 1866 and 1878 was 96.08 Fahr., in November 1877, and the lowest minimum 66.02, in September of the same year. The mean temperature during the same period was 78.69. Taking the monthly means we find January 77.48, February 77.52, March 78.24, April 79.34, May 79.59, June 78.83, July 78.25, August 79.14, September 79.35, October 79.50, November 79.23, December 77.86. It is this long unbroken continuity of high temperatures which proves trying to the European constitution, for the new-comer seldom feels himself much oppressed by the heat. The maximum daily temperature occurs in January, June, and July at 2 o'clock and in the other months at 1 o'clock p.m. The highest maximum of barometric pressure recorded between 1866 and 1878 was 30 inches in July 1877, and the lowest minimum 29.64 inches in December 1870. In the ten years 1866–1875 the difference between the highest daily mean and the lowest was only 0.295 of an inch.

Java is situated in the region of the south-east trade wind, and that is the prevailing direction of the wind during one half of the year, from April to October. During the other half of the year a north-west or west wind (the physical continuation of the north-east trade wind) blows with nearly equal steadiness. The former period is known as the dry season or east monsoon, and the latter as the rainy season or the west monsoon. The distinction between the dry and the rainy seasons is most marked in the eastern portion of the island; and indeed when we come as far west as Batavia it cannot be said that there is any part of the year altogether free from rain. During the dry season the well-known phenomenon of land and sea breezes is very distinctly exhibited; during the rainy season, through obvious causes, the alternation becomes much less regular.

<sup>1</sup> See Staring, "Sur l'existence du terrain diluvien à Java," in *Archives Néerlandaises*, 1867, and "Voorkomen van dil. gronden op Java," in *Vers. of Kon. Akad. van Wet., Afdel. Natuurk.*, 1865; Verbeek, "Geologie van Java" in *Tijdschr. van het Aardk. Genoot.*, part i.; Loric, *Bijdrage tot de kennis der Jav. eruptiefgesteenten*, Rotterdam, 1879; Martin, *Die Tertiärschichten auf Java nach den Entdeckungen von Fr. Junghuhn*, Leyden, 1879; "Sur les volcans de l'île de Java et leurs rapports avec le réseau pentagonal," in *Comptes Rendus*, tom. lxxix. pp. 1058–1061. There has as yet been no regular geological survey of Java; and much new light may be expected from the labours which the Government has at last determined to prosecute. From Verbeek and Fannema's "Nouv. faits géol. observes à Java," in *Arch. Néerland.*, 1881, we learn that the existence of granite and other pre-Tertiary rocks, the absence of which has long been regarded as one of the chief points of difference between Java and Sumatra, is now ascertained beyond all dispute.

<sup>2</sup> See Verbeek. *De Mijnwelken in Ned. Ind.*, Batavia, 1879.



In a country of such bold and varied relief as Java, the rainfall naturally differs very strikingly according to locality both in annual amount and in distribution in time. In 1878, for example, the number of rainy days (*Natuurk. Tijds. voor Ned. Ind.*, 1880) was for Batavia (at 23 feet above the sea-level) 131, at Buitenzorg (1969 feet) 220, at Wirodessa in Pekalongan (at the sea-level) 118, and so on. According to the Batavian observations for 1864-1878, the following figures show the annual rainfall:—

Inches.		Inches.		Inches.	
1864	61.57	1869	76.22	1874	77.75
1865	79.33	1870	80.78	1875	75.52
1866	84.88	1871	89.40	1876	96.57
1867	91.45	1872	93.58	1877	65.95
1868	54.21	1873	50.77	1878	59.00

This gives a mean annual fall of 75.89 inches. During these fifteen years the largest amount registered for any twenty-four hours was 6.9 inches; and during the thirteen years from 1866 to 1878 the largest amount registered in any single hour was 3.6 inches. More than half of the annual amount of rain on an average falls in the three months December, January, and February. The following figures are the percentages for all the months according to the 1864-1878 observations:—

January	.....21.0	May	.....14.1	September	.....2.8
February	.....18.5	June	.....4.9	October	.....6.2
March	.....9.4	July	.....2.1	November	.....6.4
April	.....5.9	August	.....2.5	December	.....14.2

Between 1867 and 1877 1041 thunderstorms were observed at Batavia,—November, December, and January being the months with the greatest number, and June, July, and August those with the least.<sup>1</sup>

**Vegetation.**—The vegetation of Java is rich and diversified. Few of the plants being deciduous, the island at all times presents the same appearance as the most fertile temperate regions at the height of summer. The villages and even the smaller towns are in great measure concealed from view by the abundant and abiding verdure; and their position in the landscape is to be recognized mainly by the different appearance presented by their groves and orchards. The character of the vegetation as a matter of course varies with the character of the soil; but at once more obvious and more general are the modifications conditioned by increase of elevation. Jungkuhn divided the island into four botanical zones, and his division has been commonly adopted by his successors. The first or tropical zone extends from the seaboard to a height of 2000 feet; the second or that of moderate heat has its upper limit at a height of about 4500 feet; the third or comparatively cool region reaches a height of 7500 feet; and the fourth or coldest region comprises all that lies above that elevation. It need hardly be added that the lines of demarcation are far from rigid, and, if they were to follow the actual appearance of certain definite vegetable forms, would dip and rise at every advance. It is at once evident also that from the structure of the island the lowest zone has by far the most extensive area; the second indeed is only a fiftieth of the first, and the third is only a five-thousandth. The lowest zone is the region of the rice-fields and sugar plantations, of cocoa-nuts, cinnamon, and cotton. According to their character the coasts are fringed with mangroves, nipah, and other palm trees, and the kayu gabas (*Alstonia scholaris*); the ponds and lakelets are covered with *Utricularia* and lotus flowers; vast prairies are clothed with the silvery alang-alang grass, broken by thickets of bamboos and patches of the taller cri grass and glagah. The second zone is the region more especially of the coffee and the tea plantations, of the areng or sugar palm, and of maize. In the forests there is a great profusion of woody lianas, rotangs, and cissna varieties. In the third zone, which consists mainly of the slopes of volcanic mountains, but also comprises a few plateaus, there is little cultivation except in the Tenger mountains, where the natives raise Indian corn, cabbage, and potatoes, and at Sempungan

(the highest village in Java, 6680 feet) on the Dieng plateau, where even tobacco is most successfully cultivated. The fourth zone, so far as planerogamous plants are concerned, has a very restricted vegetation, somewhere about one hundred species being known; but there is a corresponding abundance of cryptogams: fungi are common, and mosses cover the ground and invest the trees. The whole flora of this upper region bears a strong European cast.

According to a writer in the *Tijdschrift van Nijverheid en Landbouw*, 1879, not less than one-fourth to one-fifth of the area of Java is still covered with forest, in spite of the fact that in various quarters reckless destruction has been allowed to go on. The abundant moisture of the vegetation happily prevents the spread of the fires by which the natives often clear the prairies or jungles. Extensive tracts of virgin forest exist, more particularly in the south of the residencies of Bantam, the Preanger Regencies, Banyuwass, Pasuruan, Kediri, Probolinggo, Besuki, and Banyuwangi; and many of the principal mountains—G. Ayang, G. Tjeimé, G. Slamet, G. Wilis, G. Ardjuna, G. Raon, &c.—still preserve their natural covering of luxuriant foliage. In the first zone the forests are largely composed of *Magnoliaceæ* and *Anonaceæ*; but the loftiest trees are rather the *Mimosa acuminata*, the *Spathodea gigantea*, and the *Irina glabra*, which reach a height of 120 feet. In the second zone the first rank must be given to the rasauala (*Liquidambar altissima*), the trunks of which run straight up for 90 or 100 feet before they break into branches. The tree, however, is only found in the Preanger Regencies and the contiguous portions of Buitenzorg. Among the other trees more generally characteristic of the zone are the paupa (*Schinus Molle*), yielding fine, red, heavy timber, the ki sapi (*Gordonia excoecata*), the gadok (*Bischofia javanica*), the bayur (*Pterospermum Blumeanum*), and *Epiclavis densiflora*. Throughout the greater part of both the lower regions the banyan-tree and several closely allied forms are extremely common.

Hitherto comparatively little advantage has been taken of the Javanese wealth of timber. If the native states and Madura be left out of account, all the woods and forest, with the exception of such portions as have been formally disposed of to private possessors, are considered as Government property, and are managed under a new system introduced in 1874. By this the teak forests or plantations are singled out for particular treatment. They exist in the residencies of Tagal, Samarang, Japara, Surabaya, Madiun, Kediri, and are estimated to occupy 2300 square miles. The seaports where the timber trade is chiefly carried on are Batavia, Samarang, Surabaya, and Gresik. The net profit realized by the Government from the forest department was only £58,000 in 1879.

Reforestation has been commenced in various places—more particularly on the Sumbing, Sendara, Merbabu, and Unarang. The *Eucalyptus globulus*, the jar (*Cassia florida*, Vahl), a rapidly growing tree indigenous to Sumatra, and the surian (*Cedrela feltrijuga*, Bl.), are being largely employed by the Government for this purpose.

**Zoology.**—In respect of its fauna, Java differs from Borneo, Sumatra, and the Malay peninsula far more than these differ among themselves; and at the same time it shows close resemblances—not exhibited by Borneo and Sumatra—to the Siamese peninsula and also to the Himalayas. No genus and only five or six of the ninety species of Javanese mammals are confined to the island, and of the two hundred and seventy species of land birds only forty are peculiar. Thirteen genera of mammals, including the elephant, the tapir, and the Malay bear, found in the rest of the Malay region, are altogether absent; and twenty five Malayan genera of birds—comprising jays, gapers, bee-eaters, woodpeckers, hornbills, cuckoos, pheasants, and partridges—are in like case.<sup>2</sup>

The Javanese rhinoceros, the largest of the mammals in the island, differs from that of Sumatra in having only one horn instead of two. It ranges over the highest mountains, and its regular paths—down into deep channels—may be traced up the steepest slopes and round the rims of even active volcanoes. Of wild swine there are two species, *Sus vittatus* in the hot region and *Sus verrucosus* in the temperate. Both are extremely abundant, and their depredations are the cause of much loss; in the residency of Japara, for instance, upwards of five thousand have been killed in two months! Not much less than the rhinoceros is the banting or *Bos sondaicus*, to be found in all the uninhabited districts between 2000 and 7000 feet of elevation. The kidang or muntjac (*Cervulus muntjac*) and the rusa (*Rusa hippelaphus*) are the chief representatives of the deer

<sup>1</sup> See *Observations made at the Magnetical and Meteorological Observatory at Batavia* (vol. i., 1871; vol. iv., 1879).

See A. R. Wallace, *Island Life*, 1881.

kind; the former is a delicate little creature occurring singly or in pairs both in the mountains and in the coast districts; the latter, living in herds of from fifty to one hundred in the grassy "oijons," gives excellent sport to the native hunters. The kantjil (*Tragulus javanicus*) is little bigger than a hare. The royal tiger—the same species as that of India—is still frequent enough in the forests to make a tiger-hunt a characteristic Javanese scene, and to permit the native princes to exhibit at times a tiger and buffalo fight.<sup>1</sup> The leopard is also common: in the warm region specimens are occasionally found in which the coat is almost uniformly black, the spots, however, being visible on inspection. In the tree tops, the birds find a treacherous enemy in the matjan rempak or wild cat (*Felis minuta* or *Leopardus javanicus*), about the size of a common cat, with the markings of its larger namesake. The dog-tribe is represented by the fox-like adjang (*Canis rutilans*), which hunts in ferocious packs.

The *Chiroptera* hold a prominent place in the fauna. Remarkable especially for size is the kalong or flying-fox (*Pteropus edulis*), a fruit-eating bat, which may be seen hanging during the day in black clusters asleep on the trees, and in the evening basking in dark flocks to its favourite feeding grounds in the forest. The damage these do to the young-cocoa-nut trees, the maize, and the sugar-palm leads the natives to snare and shoot them; and their flesh is good to eat. Smaller kinds of bats are not less abundant,—perhaps the most common species being the *Nyctiejus Temminckii*. In certain places they congregate in myriads like seafowl on the hills, and their excrements produce extensive guano deposits, which the natives of Surakarta and Madium, for example, utilize as sources of saltpetre. The house of Camenan, near Besuki, is the chosen haunt of a monstrous colony which have successfully defied all efforts made to expel them. The creature known to the Europeans as a flying cat, and to the natives as the kubin, is the *Galopithecus variegatus*, marking a sort of transition from the bats to the lemuroids. Of these last Java has several species, held in awe by the natives for their supposed power of fascination. The apes are represented by the wou-wou (*Sylabates leuciscus*), the lutung, and kowi (*Presbytis maurus* and *pyrrhus*), the surili (*Presbytis mitratus*), and, most general of all, *Mucosa cynomolgus*. The existence of bands of the wou-wous is only too distinctly proved in the second zone by the loud and oecophonous outcry from which their name is derived. The lutung or black ape prefers the temperate region, though it is met with as high as 7000 feet above the sea and as low as 2900. The *Mucosa* keeps for the most part to the warm coast regions. Rats, mice, porcupines, a particular kind of hare (*Lepus signicollis*—confined to a very limited habitat), squirrels, flying squirrels, are the Javanese representatives of the *Rodentia*; and the *Insectivora* comprise a shrew mouse, three species of *Urodobates*, and *Aglomys suillus*, peculiar to Java and Sumatra.

**Agriculture.**—In the eyes of a Javanese to lack rice is to lack food. About the introduction of this divine cereal he tells strange legends, considering it the offspring of the body of Dewie Sri. The priesthood of this goddess is more influential often than that of the Prophet; at an autumn festival the worshippers may be heard uttering the Mahometan Bismillah, and following it up with the seven-fold repetition of her name. For a full harvest the choice of a lucky day is of greater importance than the careful tillage of the field; and to ensure a proper selection the Javanese must have the "windu," the year, the month, the day, the hour. In each of the eight years of the windu a special method of ploughing, of sacrificing, praying, &c., must be employed.<sup>2</sup> The Javanese is thus far from being an enlightened cultivator even of his one indispensable grain; and, though the ancestral custom must in many cases be really the result of ancient experience, the blindfold way in which it is applied results in very bad husbandry. The cultivation of the rice appears at present to be often carried on at a dead loss. The varieties of the cereal known to the Javanese are numerous; but they are commonly grouped as *Oryza sativa*, *precox*, *montana*, and *glutinosa*. The first is the kind mainly sown in the *sawahs* or irrigation-fields; the *montana*, on the other hand, is suited

for those in which there is no artificial irrigation,—either gogo-land, which has been only rudely cleared from the forest and brought under imperfect or temporary tillage, or the tagal, which is regularly subject year after year to the processes of husbandry.

Some idea may be formed of the extent of agricultural activity in Java from the following statement of the amount of land (in bouws,—the bouw or bahu being about 1½ acres) cultivated for their own use by the natives of Java and Madura, excluding the native states and the private properties:—

	Total, i. e. 2d and 3d Columns.	With Rice as First Crop.	With any other Plant as First Crop.	With Rice as Second Crop.	With any other Plant as Second Crop.
1874	2,481,702	2,182,146	299,556	22,302	732,849
1875	2,399,770	2,022,152	307,618	91,531	535,125
1876	2,551,597	2,247,490	334,317	98,210	879,725
1877	2,615,306	2,291,135	324,771	97,899	671,652
1878	2,810,356	2,417,480	423,376	106,252	950,372

In 1879, leaving out of view the native territories and the private estates, the area under cultivation was 2,929,644 bouws. Of this aggregate, 1,504,052 bouws were sawahs capable of irrigation, 813,153 sawahs dependent on the rains, 49,219 marsh-sawahs, and 563,220 tagal fields. The system of communal proprietorship and annual redivision of the soil largely holds throughout Java, especially in the case of the irrigated lands; in a large number of instances it has taken the place of individual ownership within quite recent years, and in other instances the opposite process has been carried through. There are villages where the redistribution is repeated regularly every year, others where this is only done as often as the number of legitimate share-takers is increased or diminished. In some to prevent the excessive parcelling of the land a certain quota of the claimants are kept in abeyance at each term of allotment. To the claimer of virgin land belongs the ownership of the same. Details will be found in the official *Eindresume van het onderzoek naar de rechten van den inlander op den grond*, of which an epitome appears in *De Indische Gids*, 1880.

Besides rice the Javanese cultivate for their own use, on a smaller scale, maize (*jagung*), ground nuts, yams, *Colocasia antiquorum*, *Coloca tuberosus*, and cassava. The gardens and orchards in which their huts are embowered contain a great variety of fruits. The cocoa-nut holds an increasingly important place,—the best of the many varieties being the idjo; and the banana is even more common. For an account of these as well as other fruits cultivated in the native orchards (*Artocarpus integrifolia*, &c.) see a paper by Gelpke in *De Indische Gids*, 1880.

The Javanese possess buffaloes, ordinary cattle, horses, dogs, and cats. Attempts made by the Government to introduce the ass (1841) and the camel (1843-45) were not successful. The buffalo was probably introduced by the Hindus. The ordinary cattle are of very mixed race; the Indian zebu having been crossed with the hunting and with European cattle of miscellaneous origin. The horses, though small, are of excellent character, and their masters, according to their own ideas, are extremely particular in regard to purity of race. Riding comes very naturally to the Javanese; horse-races and tournaments have been in vogue amongst them from early times. The native sheep are of no value for their wool, and the finest merinos, introduced by Holle in 1872, soon degenerated to the same condition.<sup>3</sup> Bees (apparently the small stingless *Melipona minuta*) are kept by the natives of the Preanger. The attempt to introduce the European varieties made in 1877-8 has proved very much of a failure. See *Buitenzorg Report*, 1879.

The production of rice is not of more importance to the native Javanese than the cultivation of the coffee-plant is to their European masters. The first coffee-plants grown in Java of which we have historical accounts were brought from Kananore on the coast of Malabar in 1696; but they perished in the earthquake and flood of 1699, and the honour of reintroducing the precious shrub belongs to Hendrik Zwaardekroon.<sup>4</sup> The first shipment of Javanese

<sup>1</sup> The number of buffaloes in Java (exclusive of Batavia, Surakarta, and Jokjokarta) in 1837 was 1,046,544; of cattle, 340,125; and of horses, 221,150. By 1876 the corresponding numbers were 2,235,613 buffaloes, 1,290,649 cattle, 532,612 horses. Since 1873 there are statistics for the whole island: in 1877 the buffaloes numbered 2,754,493; the cattle, 1,727,841; and the horses, 618,411. The cattle plague made its appearance in the island in 1879. See Kesteren, "Da Veestapel of Java," in *De Indische Gids*, 1880.

<sup>2</sup> See N. P. van den Berg, "Voortbrenging en Verbruik van Koffie" (*Tjidsch. voor Nijver. en Landb.*, 1879). Widji Kawah is mentioned in a Kawi inscription of 856, and "Bean-soup" is included in the list of Javanese beverages by David Tappen (1667-1682).

<sup>1</sup> See, in Beauvoir's *Voyage Round the World*, a description of the menagerie of the prince of Jokjokarta.

<sup>2</sup> In the first year, for example, of the windu, *Alip*, the work is begun on Friday, and the first furrow is drawn from south to north in the middle of the field. The sacrificial feast consists mainly of rice not cooked in steam (*Soga liwet*). For details as to rice culture, its superstitions, &c., see *Ejdr. tot de T. L. en V. Kunde van Ned. Ind.*, 1874.



coffee to the Netherlands was made in 1711-12; but it was not till after 1721 that the yearly exports reached any considerable amount. The aggregate quantity sold in the home market from 1711 to 1791 was 2,036,437 piculs (of 133 lb avoird.), and this must have represented nearly the whole production of the island. By the beginning of the 19th century the annual production was 120,000 piculs, and in spite of political interruptions this had increased by 1825 to 268,000 piculs. After the introduction of the Van den Bosch system a further augmentation was effected; and from the official reports it appears that from 1840 to 1873 the amount has ranged from 769,000 to 1,234,000 piculs. During the ten years 1869-1878 the average annual produce of the Government plantations was 878,000, that of the private planters 156,000 piculs. In 1878 the actual quantity of Government coffee was 831,515 piculs, and it was estimated that the total number of full grown plants in the island was 14,180,000. The collecting warehouses were 367.

Next in importance to the coffee plant is the sugar cane. Between 1853 and 1857 the average production of Java was 1,652,112 piculs; between 1869 and 1873, 2,869,968; and between 1875 and 1880, 3,438,912; the corresponding numbers for Brazil being 1,683,200, 2,176,000 and 2,110,256. The largest harvest in any single year in Java during all that period was that of 1877, 3,721,984 piculs. The cultivation of tea, commenced by Du Bus, has also attained a considerable development; in 1879 the production amounted to upwards of 5,700,000 lb. The plantations are private enterprises on lands leased or granted as freehold by the Government. Most of them are in Batavia (Depart. Buitenzorg) and the Preanger Regencies. Cinchona is largely grown by the Government, and to some extent by the private planters. In 1879 the Government had 1,678,670 trees; the production was about 115,000 lb. Ten distinct varieties are in cultivation, *Succiruba* and *Calisaya javanica* preponderating. The tobacco plant is grown in nearly all the residencies, but most extensively in Kediri and Besuki. The production for the foreign market amounted in 1879 to 7,050,000 lb.<sup>1</sup>

The cultivation of the great wealth-giving crops of Java has long been carried on in the interest of the Government, the native peasantry being obliged to devote so much of their soil and toil to satisfy the demands of their European masters. The system by which, in this regard, the relations of the Government to the native were for a long time determined is generally known as the "culture system." Introduced in 1830 by Van den Bosch, it continued in force till 1873, and has not altogether disappeared even yet. As far back as 1856 modifications of its arrangements were introduced by Duijmaer van Twist; and the position of the native was further improved by Sloet van de Beele. The reforms were for a time retarded by Governor Mijer; but in 1870, under the colonial minister Waal, a new agrarian law was passed which permitted the cession of uncultivated ground to Europeans on a lease of seventy-five years. The principal object of the "culture system" was the coffee plant, and it is only gradually that the restrictions of the older regulation have been relaxed. In 1872 a new regulation was introduced into the Preanger Regencies; in 1875 it was extended to the rest of the island with the exception of Pasuruan and the Tenger mountains; and in 1877 it was made applicable in Pasuruan likewise. By this new system the large plantations at a distance from the abodes of the "culture" peasants are to be replaced by smaller plantations near the villages; no service is demanded from those whose lands and gardens are below a definite minimum, and the people cannot be called out for field work *en masse*; fifty coffee plants is the greatest number that any one can be called on to plant in a year. The general scope of the newer legislation is to leave as much as possible to private initiative, native and European, but it will be a long time before the leading strings can be altogether dropped. In the words of Mr Kesteren:—

"The Javanese knows no freedom. His whole existence is 'regulated.' If he is bound to render 'culture'-service, the administration shows him to what department to apply himself, when and how he must plant. If he is not bound to render 'culture'-service, but has the position of a so-called free agriculturist, the administration prescribes the time and method of sowing and planting his land. If he wishes to fix his habitation outside his village, the village chief may prevent him. If he has a dwelling of his own, the administration decides for him what sort of materials he must use for the roof. If he has a hanging night lamp in his bamboo hut, he must not hang it against the wall."

It is not in the coffee plantations only that his service is demanded by the Government. In 1879 there were 2,030,136 persons subject to the *corvée*; and the actual days of work required were 32,197,561, the greatest number of days which can be exacted from any indivi-

<sup>1</sup> In regard to coffee, sugar, cinchona, &c., see K. W. van Gorkom, *De Oost-Indische Cultures in Betrekking tot Handel en Nijverheid*, Amsterdam, 1881.

dual being 52 per annum. To watch the Government warehouses, to escort prisoners, to keep the roads and bridges in repair, to give assistance to persons travelling in the public service, are some of the many tasks which the native is called on to perform.

*Mechanic Arts.*—In these the Javanese are in advance of the other peoples of the archipelago. Of thirty different crafts practised among them, the most important are those of the blacksmith or cutler, the carpenter, the kris-sheath-maker, the coppersmith, the goldsmith, and the potter. Their skill in the working of the metals is the more noteworthy as they have to import the raw materials. The most esteemed product of the blacksmith's skill is the kris; every man and boy above the age of fourteen wears one at least as part of his ordinary dress, and men of rank two and sometimes four. In the finishing and adornment of the finer weapons no expense is spared; and ancient kris-es of good workmanship sometimes fetch enormous prices.<sup>2</sup> The Javanese gold and silver work possesses considerable beauty, but there is nothing equal to the filigree of Sumatra; the brass musical instruments are of exceptional excellence. Both bricks and tiles are largely made, as well as a coarse unglazed pottery similar to that of Hindustan; but all the finer wares are imported from China. Cotton spinning, weaving, and dyeing are carried on for the most part as purely domestic operations by the women. The usual mode of giving variety of colour is by weaving in stripes with a succession of different-coloured yarns, but another mode is to cover with melted wax or damar the part of the cloth not intended to receive the dye. This process is naturally a slow one, and has to be repeated according to the number of colours required. As a consequence the "battiks," as the cloths thus treated are called, are in request by the wealthier classes. European imitations are easily detected, and do not pass muster; but a more rapid process of battiking by means of hand stamps has begun to be employed both by native and Chinese workers. For the most part quiet colours are preferred. To the Javanese of the present day the ancient buildings of the Hindu periods are the work of supernatural power. Except when employed by his European master he seldom builds anything more substantial than a bamboo or timber frame work; but in the details of such erections he exhibits both skill and taste. When Europeans first came to the island they found native vessels of large size well entitled to the name of ships; and, though ship-building proper is now carried on only under the direction of Europeans, boat-building is a very extensive native industry along the whole of the north coast—the boats sometimes reaching a burden of 50 tons.

The only one of the higher arts which the Javanese have carried to any degree of perfection is music; and in regard to the value of their efforts in this direction Europeans differ greatly. The orchestra (*gamelan*) consists of wind, string, and percussion instruments, the latter being in preponderance to the other two. (Details on the instruments will be found in Raffles, and a description of a performance in the *Tour du Monde*, 1880.) In connexion with this attention may be called to the wayangs or puppet plays, in which grotesque figures of gilded leather are moved by the performer, who recites the appropriate speeches, and as occasion demands plays the part of chorus. At least one Javanese, Raden Saleh, has attained eminence as a painter.

*Population.*—The data for tracing the increase of the population are far from satisfactory; and the returns even of the present time can only be accepted as rough approximations.<sup>3</sup> Of the following tables the first gives the totals for Java and Madura for several years, and the second the details for the individual provinces at December 31, 1878, according to the *Kolonial Verslag* of 1880.

	Europeans.	Chinese.	Arabs, &c.	Natives.
1868	28,466	167,620	15,712	15,265,931
1869	29,129	172,289	16,850	16,010,114
1870	27,585	174,540	16,943	16,452,163
1871	28,003	181,732	19,955	16,891,068
1877	28,672	198,233	13,340	18,567,075

<sup>2</sup> The reader will find drawings of a great variety of kris blades in Raffles, *Java*, vol. i.

<sup>3</sup> In 1781 Radermacher estimated the population of Java at 2,029,915 souls; in 1795 Nederburg gave it as at least three and a half millions, and Daendels in 1808-1811 as over 3,770,000. It was certainly not on the side of excess that these estimates erred. About 1815 the first real census of the population, carried out by Raffles, gave an aggregate of 4,615,270—Java 4,390,661, and Madura 224,609—of whom 4,499,250 were natives. According to Bleeker's estimates (*Tijdschr. voor Nederl. Indië*, 1847), the total about 1845 was 9,542,045, of whom 9,373,989 were natives. The only year since 1849 in which, according to the official returns, there has been a decrease in the population is 1850, due to the famine and pestilence that prevailed in Demak and Grobogan. There appears to be about the same preponderance of male over female births in Java as in Europe.

Residences.	Square Miles.	Euro-peans.	Chinese.	Arabs and other Orientals.	Natives.	Total.
Bantam.....	...	346	1,746	17	755,698	757,707
Batavia.....	2631	5,066	71,822	983	882,065	960,736
Krawang.....	1765	218	3,742	77	291,203	295,240
Preanger Regen- cies.....	...	948	1,693	73	1,248,953	1,251,667
Cheribon.....	2608	867	17,400	1,229	1,239,678	1,252,174
Tagal.....	1466	673	5,348	159	926,898	933,576
Pekalongan.....	891	490	4,687	743	506,554	612,454
Semarang.....	2002	4,072	14,133	2,927	1,254,991	1,276,143
Japara.....	1205	567	9,854	83	823,912	834,416
Rembang.....	2910	661	16,047	283	1,000,809	1,017,890
Surabaya.....	2091	5,329	12,165	1,489	1,812,026	1,631,009
Pasuruan.....	2066	1,277	4,721	1,474	649,433	656,965
Probolingó.....	1126	739	2,206	320	433,911	437,176
Besuki.....	...	478	959	513	412,843	414,793
Banyuwangi.....	...	179	227	349	61,383	62,129
Banyumas.....	2147	521	3,700	69	996,509	1,000,799
Bagelen.....	1324	453	2,599	90	1,198,490	1,201,632
Kedu.....	791	499	5,323	88	604,761	700,671
Jokjakarta.....	1192	1,472	1,837	168	444,650	448,127
Surakarta.....	2494	2,387	8,301	266*	927,430	936,884
Madun.....	2506	564	3,158	13	970,455	974,190
Kediri.....	2610	817	6,445	...	719,546	726,608
Madura.....	...	484	3,790	1,541	779,478	785,293
Total.....	...	29,598	200,303	9,610	18,824,574	19,067,829

The population has thus increased considerably since 1872, when the return showed a total of 17,291,200. The most densely peopled districts (those occupied by the Javanese proper) have a greater number of inhabitants to the square mile than Belgium; the Sunda lands,<sup>2</sup> on the other hand, and the Madurese districts have in comparison a sparse population.

The Government returns furnish the population of only the three largest towns. At the close of 1878 Batavia (town and suburbs) contained 97,585 inhabitants, of whom 4427 were Europeans, 23,466 Chinese, 68,822 natives, and 890 Arabs, &c.; the numbers for Samarang (total 79,443) were Europeans 2976, Chinese 7088, natives, 66,691, Arabs, &c., 2688, and for Surabaya (total 118,824), Europeans 4471, Chinese 6293, natives 106,599, Arabs, &c., 1461. It thus appears that in respect of population Batavia is only second. The great bulk of the population is distributed over the country in villages usually called by Europeans *dessas*, from the Low Javanese word *desá* (High Javanese *dusun*).<sup>3</sup> Every *desa*, however small (and those containing from 100 to 1000 families are exceptionally large), forms an independent community; and no sooner does it attain to any considerable size than it sends off a score of families or so to form a new *desa*. Each lies in the midst of its own area of cultivation. The general enclosure is formed by an impervious hedge of bamboo 40 to 70 feet high. Within this lie the houses, each with its own enclosure or garth, which, even when the fields are the communal property, belongs to the individual householder. In the centre of the alun-alun or forum there is usually a giant waringin or tjaringin tree (*Urostigma benjaminum*), and on the west side stands the mosque. The capital of a district is only a larger *desa*, and that of a regency (in Sundaese *dayuh*, in Low Javanese *negarâ*, hence the familiar *negerie*) has the same general type, but consists of several kampongs or villages. The houses in the strictly Javanese districts are always built on the ground; in the Sunda lands they are raised on piles.

**Administration.**—The principal local European authority is known as the *resident*, who exercises judicial, financial, and administrative functions. As president of the council (*landraad*) and judge of the residency court he deals both with civil and with criminal cases; and he also acts as police magistrate in his more immediate district. Each of the *assistant residents* administers under his supervision one of the territorial departments (*afdeelingen*) into which each residentship is divided. Next in rank is the European secretary of the resident, who, as occasion demands, acts as the resident's substitute as president of the council, and performs a great variety of duties as recorder, notary public, registrar, &c. Subject to the assistant resident is

the controller. "It is his first duty to look after the interests of the native population, and he may be considered as the link that connects the European with the native functionaries." His district is of so limited an extent that he is able to make a personal inspection of every portion of it once a month, and to become intimately acquainted with all the native officials within its boundaries. There is almost nothing which can be considered as affecting either the welfare of the population or the success of the Government administration which lies beyond the scope of his supervision. At the same time he is entrusted with a very small share of executive authority; his function is to observe, to advise, to report. Under the perpetual guidance of these residents, assistant residents, and controllers, a large part of the administration of the country is carried on by the native functionaries. Of these the highest is the *regent*, whose rank and right of precedence is superior even to that of all European officials below the resident. Always belonging to one of the ancient noble families, he maintains the state and retinue of an independent prince, with all the elaborate environment of Oriental etiquette. He receives a large salary from the Dutch Government, possesses, in virtue of his office, a landed estate, and exercises large authority over the people of his regency. By the European officials also he is treated with full respect and consideration. But, appointed by the governor-general, he, as much as any ordinary official in the civil service, holds his office by the good-will of the Dutch Government. Insubordination is followed by dismissal; and dismissal involves the forfeiture of all the wealth and prestige which he possessed as regent. The regent's substitute is known as *patih*. The several districts of the regency (there are usually five or six) are administered by a *wedânâ* (*wedono*) or *demang*; and secondary subdivisions by *assistant wedânâs* or *mantris* (salaried). The *wedânâ* has also at his disposal a considerable number of volunteer mantris not officially recognized.<sup>4</sup>

The following table shows the residentships and departments into which Java (with Madura) is divided:—

- Bantam*:<sup>5</sup> Anyer, Pandeleng, Tjiringin, Lebak.
- Batavia*: Batavia (town and suburbs), Meester-Cornelis, Tangerang, Buitenzorg, Krawang; two control departments.
- Preanger Regencies*: Bandung, Tjijulangka, Tji Andjur (Tjandjur), Sukabumi, Sumedang, Tasik-unalaya, Limbangan, Sukapura, Sukapura-kelot.
- Cheribon*: Cheribon, Indramayu (Demayun), Galuh, Madjalengka, Kuningan.
- Tagal*: Tagal (Tegal), Brebes, Pemalang.
- Pekalongan*: Pekalongan, Batang.
- Samarang*: Samarang (Semarang), Salatiga, Ambarawa (Embah-rowo or Bah-rowo), Unsurang (Oenarang), Demak, Grobogan, Kendal.
- Japara*: Japara (Djepara), Kudus, Joana (Juwana), Carimon Java (Karimuo Djawa).
- Rembang*: Rembang, Tuban, Bodjo-Negoro, Blora.
- Surabaya*: Surabaya, Grisee (Gresik), Modjokerto, Sidoarjo, Sidayu, Leman-gan, and the island of Bawean.
- Madura*: Pamkasan, Madura, Sumanap (Sumenep), Sampang.
- Pasuruan*: Pasuruan, Malang, Bangli.
- Probolingó*: Probolingó, Kraksaan (Kareksan), Lumadjang.
- Besuki*: Besuki, Panarukan, Bondowoso.
- Banyuwangi*: Banyuwangi, Buleleng, and Jembrana (the last two in Bali).
- Banyumas*: Banyumas, Tjilatjap, Purwokerto, Purbolingó, Bandjonegara.
- Bagelen*: Purworedjo, Kutoarjo, Ledok (Wonosobo), Kebumen, Karanganyer.
- Kedu* (*Kedu*): Magelang, Temanggung.
- Jokjakarta*: Sulans territory, with eight regencies, and Paku Alams territory, forming one regency.
- Surakarta*: Surakarta, Sragen, Boyolali, Klaten, Wonogiri.
- Madun*: Madun, Ngawi, Patjitan, Poncoro, Magetan.
- Kediri*: Kediri, Ngrowo, Berbe, Blitar.

There are thus (excluding the governor-general) 22 residents and 73 assistant residents. The normal number of controllers is 100, and of aspirant controllers 48, there being no controllers in Batavia, Jolkakarta, or Surakarta.

**Chief Towns.**—The principal town of the residency of Banfam is *Serang* (6° 6' 45" S. lat. and 106° 8' 37" E. long.), bearing the same relation to the town of Bantam (about 6 miles distant) as New Batavia bears to Old Batavia. It is only 100 feet above the sea-level, but even this elevation renders the climate much better for Europeans than that of Bantam, and it is owjog to this that Serang has come to supplant the older city. For BANTAM, see vol. iii. p. 347. Anyer lies on the coast at the narrowest part of the Sunda Straits, and vessels from Europa usually receive fresh

<sup>1</sup> These areas are the result of the Government survey begun in 1854. See Havenga, *Aperçu de l'origine et du développement des reconm. mil. à Java* (Bat., 1878).

<sup>2</sup> That is, the residences of Bantam, Batavia, Krawang, Cheribon, and the Preanger Regencies.

<sup>3</sup> This is really a Sanskrit word, known also in British India in the compounds *desai* (i. e., *desahipati*), *desmukh* (i. e., *desa-mukha*), equivalent to village chief. The Sundaese quasi-equivalent is *lembur*, and several *lembur* or kampongs compose a *kalurahan* or *lurah-ship*.

<sup>4</sup> See further in J. W. B. Money's *Java*, London, 1861.

<sup>5</sup> The correct form of this name, Bantén, is getting into use in Dutch works.



provisions and water there. *Pandeglang* is 787 feet above the sea; in the vicinity are sulphur springs, both hot and cold.

BATAVIA, the capital of Dutch India, has already been described in vol. iii. p. 431.<sup>1</sup> *Meester Cornelis*, between 6 and 7 miles from Batavia on the way to Buitenzorg, was the seat of a fort as early as the time of Valentijn. It was there that Daendels established his great entrenched camp, and it was there that the battle was fought (in 1811) which placed Java in the hands of the British. About 14 miles from Batavia lies *Tangerang*, a small but busy place, with several thousand Chinese among its inhabitants. In its vicinity is *Bergzicht* (*Berzigt*), formerly famous for its indigo. For BUITENZORG, see vol. iv. pp. 514-5.

The Krawang residency is one of the least populous in the whole island. The great post road does not enter the territory; the resident has less direct authority over his district than is enjoyed by his official coopeers, and has no assistant resident. *Krawang*, the old capital, has lost its importance since *Purwokarta* became the administrative centre. This place, laid out by the commissioner Du Bus, has a large native and Chinese population. At *Wanayasa*, a considerable *negara*, the first tea gardens on a large scale were attempted on the island.

The Preanger Regencies (*Bandung*, *Tjandjur*, *Sumedang*, *Limangan*, *Sukapura*) constitute the most important of all the residencies. *Bandung*, the capital of the residency since 1864, is a flourishing place, with a handsome mosque, and normal school for native teachers. *Tji Andjur*, which was the administrative centre up to 1864, is of similar character to *Bandung*, though the removal of the resident and his subordinates has produced a certain decline in its importance. *Tjitalengka*, in the very heart of the coffee districts, has developed greatly since the new system was introduced in 1870, and is certain to make further progress when the projected railways give it better communication with *Bandung* and *Batavia*. *Sumedang* is already a populous and prosperous *negara*. The ancient settlement of this name lay in another part of the regencies.

*Cheribon* (*Tjeribon*) is one of the most important places in Java, though the unhealthiness of the site has caused a number of the principal Europeans to settle about 2 miles to the north at *Tangkil*. The church erected in 1842, the regent's residence, large warehouses for coffee and salt, and a prison are among the principal buildings. The native part of the town is to some extent laid out in European style. The Chinese quarter, large and populous, possesses the finest Chinese temple in Java. *Cheribon* is the residence of the descendants of the old sultan of *Cheribon*. The palaces are not so extensive as those of *Surakarta* and *Jokjokarta*. By the mud bank at its mouth, the *Tjeribon* (*Shrimp* River) does more harm than good to the town. The harbour is only kept available by constant dredging, but the roadstead is very good all the year round. A strange pleasure palace of Sultan Sepuh, frequently described by travellers, lies about 2 miles from *Cheribon* near *Sunya Raja*. *Mundu*, a village 4 miles south-east of *Cheribon*, is remarkable as the only spot on the north coast of Java which is visited by the *ikan pirit* or belly fish, a species about as large as a cod, caught in thousands, and salted by the local fishermen. *Indramayu* lies on both sides of the *Tji Manuk*, about 8 miles from the coast. It is mentioned as *Dermayo* in the old Portuguese and Dutch travels. As a port for the rice of the district of *Indramayu*, and for the coffee of the Preanger and *Cheribon*, the town seemed at one time to have a great commercial future before it, but the roadstead was safe only during the east monsoon. The river has a tendency to send its waters by the channel of the *Kali Rambatan*, and a process of silting up is going on rapidly. In 1876 the Government began the construction of works to prevent the change of course.

*Tagal* has long been one of the chief towns in Java,—foreign commerce, and native trade, industry, and fisheries, being all well developed. About 1845 Dr Bleeker estimated its population at 29,536, and, if the growth of the town has been similar to that of the residency, the total may now be set down as about 80,000. Since 1871 the harbour has been the object of various improvements. The town is regularly and well built. The native stone-cutters, carpenters, dyers, and smiths of *Tagal* are particularly skilful. *Pamalany* is a thriving coast village, noteworthy for the quality of the oysters. *Pekalongan* ("abode of the kelongs") is, like *Tagal*, an important town. It possesses a large mosque, a Protestant church, a fort (now used as a prison and barracks), and a large number of European houses. The Chinese ward consists of neat stone or brick buildings. Dr Bleeker estimated the population at 15,000 in 1848; it must be now considerably more. The name of *Pekalongan* is associated with the smoked ducks prepared in the district. *Batang* is only 5 miles distant.

*Samarang* lies on the *Kali Ngaran* near the centre of the north coast. Round the market place are grouped the residences of the regent and his substitute, the mosque, the military hospital, the town-house (erected in 1854-1864), the Government warehouses, &c. The hospital, formerly the palace of the governor of the

north-east coast, has accommodation for 550 European patients. The town was formerly surrounded by a wall and ditch, but these were removed in 1824; and it is now protected by a fort and a coast battery. The old European portion of the town is almost the exact reproduction of a Dutch-town, without the slightest accommodation to the exigencies of the climate. A new impetus was given to *Samarang* by the opening of the railway to *Surakarta* and *Jokjokarta* (1873). As a seaport the place is unfortunately situated: the river is long since silted up; the roads are insecure during the west monsoon; it was only after many delays that in 1879 the artificial canal, commenced in 1858 as a substitute for the river, became available; and in the opinion of the Government commission of 1876 it would be useless to attempt the erection of works similar to those of *Batavia*. *Demak*, the chief town of a regency famous in the ancient Javanese history, lies 13 miles north-east of *Samarang*. The mosque, erected by the first sultan of *Demak*, was rebuilt in 1845, and only a small part of the old structure has been preserved; but the tombs of several of the sultans are to be seen near at hand. *Salutiya* (that is, "Three Stones," with allusion to three temples now destroyed) was in early times one of the regular resting-places for ambassadors proceeding from the coast to the court of *Mataram*: and in the European history of Java its name is associated with the peace of 1755 and the capitulation of 1811. It is the headquarters of the only regiment of cavalry in the Dutch East Indian army. Besides the garrison, the European population numbers some 400 or 500 persons. About the same number of Europeans are settled at *Ambarawa*, which consists of the contiguous villages *Pundjang*, *Ambarawa*, *Losari*, and *Kupang*, and lies about a mile north of the fortress *Willem I.*, which *Van den Bosch* intended to make the central point of the Javanese system of defensive works. *Ungaran* (1026 feet above the sea) was a place of importance as early as the time of *Valentijn*, and in modern times has become known as a sanatorium.

*Japara* was in *Valentijn's* days one of the most flourishing of the Javanese coast towns; and it was still a place of prosperous commerce during the British occupation; but the harbour has greatly deteriorated, and the town is declining. *Joana* has a strikingly Dutch appearance; it is often mentioned in the early narratives. *Kudus* is a place of more than 14,000 inhabitants. *Rembang*, a well-built town, contains a considerable European settlement and a number of European institutions; the population exceeds 10,000.

*Surabaya*, as already mentioned, is the largest town in Java, and ranks next to *Batavia* in the variety of its religious, educational, charitable, and commercial institutions. It owes this position to the fact that its harbour is the best in the island. Since 1849 it has been the seat of Government dockyards and arsenals; and there are also extensive barracks, a military hospital, &c. The population includes Javanese, Madurese, Indians from *Bengal*, *Moors*, and Chinese. *Grissee* (*Gresik*) has a fairly good harbour, and is of special interest in the early European history of Java. *Pasuruan* ranks as the fourth town in the island; it is well built, and has a considerable European settlement. *Probolingo* (called by the natives *Banger*), *Besuki*, and *Banyuwangi* are all prosperous places of from 7000 to 15,000 inhabitants. The residency of *Banyuwangi* is one of the least opened up of the whole island. *Banyumas* contains a population of about 10,000 inhabitants, but there are no objects worthy of particular notice. The name, equivalent to "gold-water," was bestowed by its founder *Arya Sureng Rana* from the auriferous character of the river *Serayu* on which it stands. *Tjilatjap*, though not the capital of the residency, is a much more important and interesting place. It possesses the best harbour of all the south coast, situated at the mouth of the canal *Kali Sesukan*, which runs between the *Serayu* and the sea, and protected by the island of *Nusa Kambangan*; and it has been chosen as the seat of a principal military establishment. A battery was erected close to the town in 1878, and on *Kambangan* lie the forts *Karang Bolong* and *Batu Njapa*. The pile-villages of the *Segara Anakan* (as the enclosed bay is called) and the stalactite and mephitic caves of the island are objects of much interest. *Purwodjo*, the chief town of *Bagelen*,<sup>2</sup> became of some importance during the Java war as a military establishment, and is still occupied by a considerable garrison. It is laid out in a spacious style; and both the native and the Chinese quarters are well kept. The population is large, and it is an important seat of native industry.

Very similar to each other are *Surakarta* and *Jokjokarta*, the chief towns of the independent states. The former contains the palace of the *suhunan* or emperor, the residence of the independent prince *Mangku Negara*, the fort of *Vastenburg*, a Protestant church, and a considerable number of European buildings.

*Inhabitants*.—Leaving out of view the Europeans and the Oriental immigrants—scarcely a seventh part of the

<sup>1</sup> A plan of the town will be found in *Jaarboek van het Nijnnwezen*, *Batavia*, 1880.

<sup>2</sup> The village from which the residency takes its name is situated in the district of *Tjangkreb* in the *Purwodjo* regency. It is so called from a "linga" pillar still revered by the natives.

population—the inhabitants of Java consist of the Javanese proper, the Sundanese, and the Madurese. All three belong to the Malay stock. Between Javanese and Sundanese the distinction is mainly due to the influence of the Hindus on the former and the absence of this on the latter. Between Javanese and Madurese the distinction—not so deeply wrought—is rather to be ascribed to difference of natural environment. The Sundanese have best retained the Malay type, both in physique and fashion of life. They occupy the five residencies of Bantam, Batavia, Krawang, Cheribon, and the Preanger Regencies. The limits of the Madurese area are not so easily given. Besides the island of Madura, the residencies to the east of Surabaya and Kediri are largely occupied by them. The residencies of Tagal, Pekalongan, Banyumas, Bagelen, Kadu, Samarang, Japara, Surakarta, Jokjokarta, Rembang, Madiun, Kediri, and Surabaya have an almost purely Javanese population. Professor Veth estimates the number of the Sundanese at about 4,000,000, the Madurese at 1,600,000, and the Javanese at 11,500,000. The Javanese are the most civilized of the three peoples.

The colour of the skin in all three cases presents various shades of yellowish-brown with a touch of olive-green; and it is observed that, owing perhaps to the Hindu strain, the Javanese are generally darker than the Sundanese. The eyes are always brown or black, the hair of the head black, long, lank, and coarse. Neither breast nor limbs are provided with hair, and there is hardly even the suggestion of a beard. In stature the Malay is usually less than the European. The Sundanese is less than the Javanese proper, being seldom 5 feet in height; at the same time he is more stoutly built. The Madurese is as tall as the Javanese, and as stout as the Sundanese. The eye is usually set straight in the head in the Javanese and Madurese; among the Sundanese it is often oblique. The nose is generally flat and small, with wide nostrils; but among the Javanese it not unfrequently becomes aquiline. The lips are thick but well formed; the teeth are naturally white, but often filed and stained. The cheek bones are well developed, more particularly with the Madurese. In expressiveness of countenance the Javanese and Madurese are far in advance of the Sundanese. The women are not so well made as the men, and among the lower classes especially soon grow absolutely ugly. In the eyes of the Javanese a golden yellow complexion is the perfection of female beauty:—"She shone bright even in the dark" is the highest compliment of poetic adulation (compare Raffles, *Java*, vol. i. p. 92). To judge by their early history, the Javanese must have been a warlike and vigorous people, with somewhat of ferocity to boot. At present they are peaceable, docile, sober, simple, and industrious. The practice of running amuck is of very rare occurrence among them.

*Religion.*—The Javanese are nominally Mahometans, as in former times they were Buddhists and Brahmins; but in reality, not only such exceptional groups as the Kalangs of Surakarta and Jokjokarta and the Baduwis or nomad tribes of Bantam, but the great mass of the people must be considered as believers rather in the primitive animism of their ancestors, and in the essence of their creed but little removed from their ruder brethren the Dayaks of Borneo and the Battaks of Sumatra. Into the original web indeed they have from time to time introduced fragments from every religious system with which they have come into contact; and no attempt has been made to rationalize into even superficial harmony the rudest of the resulting incongruities. The number of the spirits (Hyang or Yang, and with honorific prefix Saughyang) worshipped by the Javanese is limitless. Every village has its patron spirit, whose presence was the indispensable condition of its foundation; to his influence all the fortune, good or bad, of the village is ascribed. Under a great shadowy tree stands an altar on which the worshipper lays his offering of incense and flowers, uttering meanwhile in broken Arabic the alien formula—"There is no God but God, and Mahomet is his prophet." To every field likewise belongs its special patron spirit, to whom due reverence must be shown. Nor is protection the only office of the Hyang. Mentik causes a particular disease in the rice; Sawan produces convulsions in children; gout

and rheumatism are ascribed to the influence of Dengen, Ki or Kyai Belorong gives men wealth in exchange for their souls. Ratu Loro Kidul is princess of the southern sea, and has her seat among the caves and fiords of the southern coast. Within the region of her sway the Javanese will not speak loud lest he disturb the repose of her subject spirits. Near Rongkob in Jokjokarta, one of the places where edible nests are collected, the princess has a temple which none may enter save the priest alone; and similar temples exist in similar localities. The whole life of the Javanese, indeed, is enveloped in a mesh of mystery; not the stars only and the heavens rain influence, but from every object a spiritual emanation, invisible for the most part, but potent and exhaustless, flows forth to him for blessing or for curse. Even Mahometanism with its One God has done little more than increase the number of supersensual beings to whom he prays. To Joseph he presents offerings that he may obtain beautiful children, to Solomon for honour and rank, to Moses for bravery, to Jesus for learning. The ritual of his religion—and his whole round of life is part of his religion—is intricate almost beyond conception, and at the same time rigid and precise. Everything must be done by rule and rubric; the unwritten law handed down from father to son allows of no curtailment or modification. Each individual class of offering must be prepared in its own peculiar way; the rice, for example,—which is one of the chief sacrificial substances,—must now be white, now red, now hard, now soft.

As we ascend in the social scale we find the name of Mahometan more and more applicable; and consequently in spite of the paganism of the populace the influence of the Mahometan "priests" (this is their official title in Dutch) is widespread and real. Great prestige attaches to the name of Mecca pilgrim. In every considerable town there is a mosque. Compare *INDIAN ARCHIPELAGO*, vol. xii. p. 819.

For the Christianizing of the Javanese very little has been done. In East Java the chief mission stations are Modjo Waroo (with a population of 2327 souls in 1879, inclusive of seven out-stations), Kediri (698), and Malang (700), maintained by the Netherlands Missionary Society, and Japara maintained by the Dutch Baptist Society. In West Java the Netherlands Mission Union has seven stations—Tjandjur, Buitenzorg, Indramayu, Sukabumi, Samedang, Madjalengka, and Cheribon. At Depok, 18 miles from Batavia, the Batavian Missionary Society established in 1875 a seminary for native preachers. The native church of Depok was originated by Cornelis Chastelein, who left his estate to his slaves, whom he liberated on condition of their embracing Christianity. Mr Buckner of Samarang, appointed to Java in 1812 by the Netherlands Society, translated the New Testament into Javanese, but the work was confiscated by the Government. Gericks, an agent of the Netherlands Bible Society, was more fortunate; his versions of both the Old and the New Testament, as well as his grammar and dictionary (edited by Koorda, Amst., 1843, 1847), have seen more than one edition.<sup>1</sup>

*Language and Literature.*—Javanese, Sundanese, and Madurese are the three native languages of Java and Madura. To take the least important first,—Sundanese is only spoken in its purity in the Preanger Regencies and the neighbouring parts of Bantam, Buitenzorg, Krawang, and Cheribon, and it is gradually losing ground. To Javanese it stands in the relation that Scotch stood to English about a century ago.<sup>2</sup> The main body of Madurese is distinctly different from both old and new Javanese; but it has incor-

<sup>1</sup> See Bramund, *Evangelisatie van Java*, Amsterdam, 1854; H. C. Voorhoeve, *De Evangelische Zending op Oost Java*, Hague, 1864; and J. C. Neurdenburg, C. Poenson, &c., in *Mededeelingen van wege het Nederl. Zendinggenootschap*, Rotterdam, 1860.

<sup>2</sup> See Coolsma, *Handleiding tot de beoefening der Soendaneesche taal*; Grashuis, *Soendaneesche tolt. and Soend. lesboek*; Rigg, *Dictionary of Sundanese*, Batavia, 1862; Blussé and Kartawinata, *Hollandsch-Soendaasch woordenboek*, Samarang, 1877; Oostrog, *Soendasch-Nederlandsch woordenboek*, 1879.



porated a very large number of purely Javanese words.<sup>1</sup> In spite of these two languages and the intrusive Malay, Javanese has a full right to its name as the dominant speech of the island. It is not one language, but two. The nobles speak to the commonalty in the language of the commonalty, the commonalty to the nobles in the language of the nobles; and according to clearly understood regulations of etiquette every Javanese plays the part of nobleman or commoner to his interlocutor. The aristocratic form is known as *Krāmā* or court speech, the popular as *Ngoko*, or the "thou"-ing speech (Fr., *tuoyant*, Germ., *duzend*); and between the two forms there is a sort of compromise, the *Madja* or middle speech, employed by those who stand to each other on an equal and friendly footing, or by those who feel little constraint of etiquette. For every idea that can be expressed in the language *Krāmā* has one expression, *Ngoko* another, the two words being sometimes completely different, sometimes only differing in the termination, the beginning, or the middle. Thus every Javanese makes use of two languages, and, what is more difficult, of two languages delicately differentiated from each other. Javanese as now spoken is far from being the same as the language of the old inscriptions and manuscripts. The latter (which is usually called *Kawi*,<sup>2</sup> though some scholars

insist on the name Old Javanese) was probably based on the Javanese of Mādjakerto, while the *Krāmā* of the present day finds its type in that of Surakarta. It is easy to explain the existence of the *Krāmā* and the *Ngoko*. The Hindu conquerors of Java, in gradually adopting the speech of their Malay subjects modified it to suit their own taste and sense of superiority; and the subjects meanwhile continued to speak as they were wont. In its vocabulary Javanese *Krāmā* has a large number of words of Sanskrit origin; and in modern times there has been a considerable adoption of foreign words from and through the Dutch. *Krāmā* usually takes one form, *Ngoko* another; thus the word *particulier* appears in the former as *pedjahkelir*, in the other as *patikelir*.<sup>3</sup> Like all the alphabets of the Indian archipelago except the Malay, the Javanese is derived from the Devanagari. When Javanese is written in Arabic characters it is called *pégon*.

Though a considerable body of *Kawi* literature is still extant, nothing like a history of it is possible. The date and authorship of most of the works are totally unknown. The first place may be assigned to the *Brata Yudu* (that is Sansk., *Bharata Yudha*, the conflict of the Bharatas), an epic poem dealing with the struggle between the *Pandāwas* and the *Korāwas* for the throne of *Ngastina* celebrated in parwas 5-10 of the *Mahābhārata*. To the conception, however, of the modern Javanese it is a purely native poem;

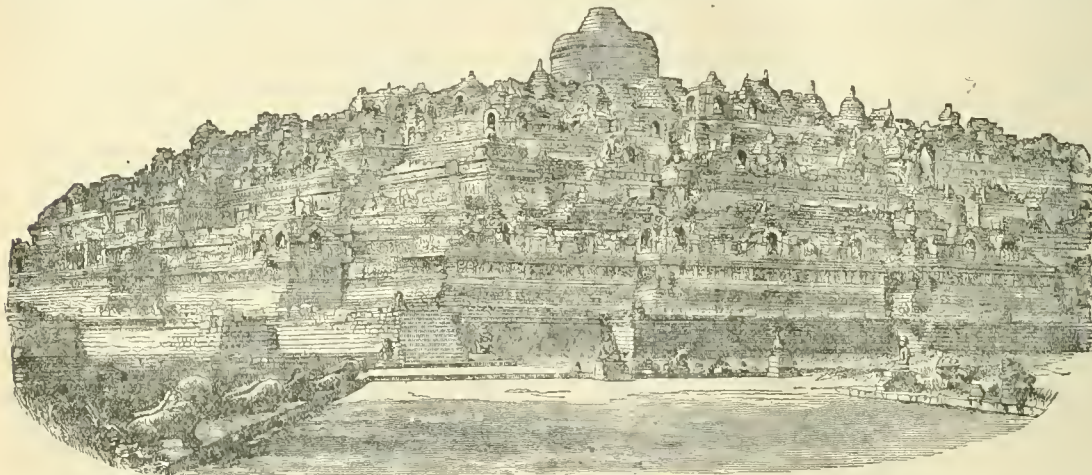

FIG. 1.—General View of Bōrā-Budur.

its kings and heroes find their place in the native history and serve as ancestors to their noble families. (Cohen Stuart published the modern Javanese version with a Dutch translation and notes, *Bratā-Joedā*, &c., Samarang, 1877. The *Kawi* text was lithographed at the Hague by S. Lankhout.) Of greater antiquity probably is the *Ardjuna Wiwāhā* (or marriage festival of *Ardjuna*), which Professor Kern thinks may be assigned to the first half of the 11th century of the Christian era. The very name indicates its *Mahābhārata* origin. (Friederich published the *Kawi* text from a Bali MS., and more recently we have from him *Wiwāhā Djarwa en Bratā Joedā Kawi*, lithographed facsimiles of two palm leaf MSS., Batavia, 1878. *Djarwa* is the name of the poetic diction of modern Javanese.) The oldest poem of which any trace is preserved is probably the mythological *Kāndā* (i.e., tradition); the contents are to some extent known from the modern Javanese version.

In the literature of modern Javanese there exists a great variety of so-called *babads* or chronicles. It is sufficient to mention the "history" of Baron Sakender, which appears to give an account—often hardly recognizable—of the settlement of Europeans in Java (Cohen Stuart has published text and translation; Professor Veth gives an analysis of the contents), and the *Babad Tanah Djawi* (Hague, 1874, 1877), giving the history of the island to 1647 of the Javanese era. Even more numerous are the puppet-plays

which usually take their subjects from the Hindu legends or from those relating to the kingdoms of *Madjapahit* and *Padjadjaram* (see, e.g., H. C. Humme, *Abisat, een Javaansche toneelstuk*, Hague, 1878).

Several Javanese specimens are also known of the beast fable, which plays so important a part in Sanskrit literature (W. Palmer van den Broek, *Javaansche Vertellingen, bevattende de lotgevallen van een kantjil, een reebok, &c.*, Hague, 1878). To the Hindu-Javanese literature there has naturally succeeded a Mahometan-Javanese literature consisting largely of translations or imitations of Arabic originals; it comprises religious romances, moral exhortations, and mystical treatises in great variety.

The reader may consult Rodet, *Études sur la littérature javanaise*; Van der Berg's account of the MSS. of the Batavian Society, Hague, 1877; and a series of papers by C. Poensen in *Meded. van-wege het Ned. Zendinggenootschap*, 1880.

*Antiquities*.—The ruins left by the early Hindu conquerors of Java are among the most remarkable objects of interest throughout the island. Temples (or *tjandis*; to

<sup>3</sup> Humboldt's study, *Ueber die Kawi Sprache*, is one of the celebrated works of modern philology; but in the absence of the necessary material it was to some extent a *tour de force*. Professor Kern's *Kawi Studien* form the most important of the more recent contributions to the investigation of the language. For modern Javanese the standard grammar is Groot and Gericke's *Javaasche Spraakkunst*, edited by Roorda (Amst., 1843).

<sup>1</sup> See A. C. Vrede, *Handleiding tot de beoefening der Madoeresche taal*, Leyden, 1874.

<sup>2</sup> In full form *tembung* or *bāsi Kawi*, i.e., the "language of poems."



nse the Javanese name) are common in both middle and eastern Java,—in Banyumas, Bagelen, Kadu, Jokjokarta, Surakarta, and Samarang, and in Surabaya, Kediri, Pasuruan, and Probolingo. They are absent from the Sunda lands in the one direction and from Madura in the other.

Most famous of all the temple ruins is that of Bâra-Budur. It lies a little to the west of the right bank of the Prâga, which falls into the Indian Ocean. A hill rising above the plain 154 feet afforded a ready site for the structure, and the lava blocks with which the ground was strewn supplied abundance of material. The accompanying view and ground plan will give some idea of the general arrangement and effect.<sup>1</sup> A square terrace, each side 497 feet long, encloses the hill at a height of 50 feet; 5 feet above this there is a second terrace, each side 365 feet; 11 feet higher comes a third terrace of similar shape; and then follow four other ramparts and

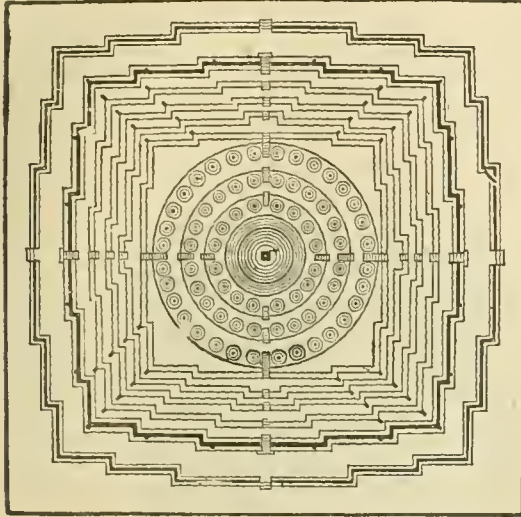

FIG. 2.—Ground Plan of Bâra-Budur.

four other terraces. The whole structure is crowned by a cupola 52 feet in diameter, surrounded by sixteen smaller bell-shaped cupolas. It is suggestive of the richness of the style to mention that on the outside of the wall of the second enclosure there are one hundred and four niches, each with its image of Buddha on a lotus throne hewn out of a single block 6 feet high; and between the niches are sitting figures, man and woman alternately. The inside of the same enclosure is even more richly adorned with at least five hundred and sixty-eight bas reliefs, representing scenes in the Buddha legend. Of the chronological date of the temple there is no certain knowledge, but it contains evidence enough in itself to fix its position in the historical movement of the Hindu creeds.

"The mixture of Buddhism and Brahmanism is best seen," says R. Friederich (*Tijdsch. der Ind. T. L. en Volkskunde*), "in the three upper and inner galleries of Boro Budur. In the first we see the history of Sakyami from the announcement of his descent from the heaven of Indra till his transformation into Buddha, with some scenes of his life. The thirteen first scenes in the second gallery likewise represent Buddha as a teacher with his pupils; after that it would seem as if a cocorad had been formed between the different cults; we have first in three separate scenes Buddha, Vishnu (Batara Guru), and Siva, all together, and other groups follow, Buddhistic and Sivaite without distinction. It is only in the fourth gallery that we again find Buddha dominant. . . . Already in the first gallery we also see Brahmanic divinities, Garuda for example, but not in separate scenes. In my opinion the cupola is the principal and the most ancient part of the temple of Boro Budur; it must have been intended to serve as a *dahogopa* (*dagoba*), i. e., a place for the enshrining of relics. I do not as yet know of any other *dagoba* in Java; but I should not be surprised at their discovery. The *dagobas* of Ceylon have an exterior resemblance to the Boro Budur cupola; but I prefer to classify it rather with the *topes* or *stupas* of Afghanistan."

The writer goes on to point out that the sculptures of the lower galleries are not so carefully finished; and the lions and some other subjects on the outside of the temple have never been completed. About 3 miles to the north-east of Bâra Budur, and probably belonging to the same period, stands another beautiful temple—Tjandi Mendut or Mundut—on the left bank of the Eila before it joins the Prâga. It was first discovered by Hartmann, the resident of Magelang, in 1834, under the sand and ashes with which the Merapi volcano had covered it. See O. W. Mieling's *Javansche Oudheden*, 1852 and 1856; and Colonel Yule's account of his visit in *Journ. Roy. As. Soc. Bengal*, 1862.

On the Dieng plateau in Bagelen, mentioned as a holy mountain

in the oldest known Javanese inscription, there exists a remarkable group of temples—which has been styled the Benares of Central Java. They stand 6500 feet above the sea; and roads and stairways (locally known as Buddha's roads) lead up from the lowlands of Bagelen and Pekalongan. The stairway between Lake Mendjer and Lake Tjebong alone consisted of upwards of 4700 steps. A great subterranean channel served to drain the plateau. The Tjandis are very numerous, the largest and most beautiful being Tjandi Binâ, but the best preserved the Ardjunâ group. The buildings are unfortunately covered to about a third of their height. In the same residency as Dieng are situated the temple caves of Kutâ Ardja discovered by Kinder in 1853. They are distributed in four groups, and apparently from the linga symbol belong to the worship of Siva. Near Râgâ Djampi (Banyuwangi) are the ruins of the town of Matjan Putih—of astonishing extent, but for the most part only shapeless mounds. The town walls were 12 feet high and 6 feet broad. A temple built of white limestone is the chief ruin. It seems to belong to the late Siva period of Javanese Hindu art. The much more famous city of Mâdjâpahit has left its ruins not far from Mâdjâkerto, in Surabaya.

Of the minor antiquities of Java the most valuable are the inscriptions on stone and copper, though, owing to the variety of the characters which have been employed, the task of deciphering and interpreting is peculiarly difficult. The proposal of the Batavian Society in 1843 to issue a *Corpus* of Javanese inscriptions came to nought; of private investigators the most successful are Friederich and Kera. The inscriptions of Batu Beragung (1847) and Payerayung (1856), that on an image of Buddha now in the Berlin Museum, that on a rock in the Dieng mountains discovered by Junghuhn, and that preserved at Minto House, in Scotland, are considered of special importance. At Sukuh and Tjeta, on the slope of Lawu, there is a peculiar series in a special character deciphered by Van der Vliet. The famous Menang Kebau inscriptions, being the work of Javanese settlers, belong rather to Java than Sumatra; but Professor Kern has shown that, instead of being, as at one time supposed, the oldest epigraphic monument in the Archipelago, they really belong to the most modern Hindu period (*cf.* Cohen Stuart in *Bijd. tot de T. L. en V. Kunde*, viii. 1, 1873). Of the Javanese copper plates the most important collection is Cohen Stuart's *Kawi Oorkonden in Facsimile*, 1875.

*The Name Java.*—The origin of this name is very doubtful. It is not improbable that it was first applied either to Sumatra or to what was known of the Indian archipelago—the insular character of the several parts not being at once recognized. Java Dwipa, or "land of millet," may have been the original form<sup>2</sup> and have given rise both to the Jaba diu of Ptolemy and to the Je-pho-thi of Fattien, the Chinese pilgrim of the 4th or 5th century. The oldest form of the name in Arabic is apparently Zâbej. The first epigraphic occurrence of Java is in an inscription of 1343. In Marco Polo the name is the common appellation of all the Sunda islands. The Java of Ibn Batuta is Sumatra; Java is his *Mul Jâwa* (i. e., possibly "original Java"). Jâwa is the modern Javanese name (in the court speech *Jawi*), sometimes with *Nusa*, "island," or *Tanah*, "country," prefixed.

*History.*—The history of Java in its main outlines can be very briefly given; in detail it is burdened with endless complications, inconsistent accounts, and imaginative adornments. It is impossible to extract a rational narrative from the earlier *babads* or native chronicles, and even the later are destitute of any satisfactory chronology. The first great moment in the history is the ascendancy of the Hindus, and that breaks up into three periods,—a period of Buddhism, a period of aggressive Sivaism, and a period of apparent compromise. Of the various Hindu states that were established in the island, that of Mâdjâpahit was the most widely dominant; its tributaries were many, and it even extended its sway into other parts of the archipelago.<sup>3</sup> The second moment of the history is the invasion of Islam in the beginning of the 15th century; and the third is the establishment of European and more particularly of Dutch influence and authority in the island. In its general features this last and most important section reads very much like the narrative of the British subjugation of India. At the time when the Dutch East Indian Company began to fix its trading factories on the coast towns, the chief native state was Mataram, which had in the 16th century succeeded to the overlordship possessed by the house of Demak—one of the states that rose after the fall of Mâdjâpahit. The "emperors of Java," as the princes of Mataram are called in the early accounts, had their capital at Kartasura, now an almost deserted place, 6 miles west of Surakarta. At first and for long the company had only forts and little fragments of territory at Jakatra (Batavia), &c.; but in 1705 it obtained definite possession of the Preanger by treaty with Mataram; and in 1745 its authority was extended over the whole north-east coast, from Cheribon to Banyuwangi. In 1755 the kingdom of Mataram

<sup>1</sup> See Leeman's *Bôrô Boedoor*, based on the MSS. of Wilsen and Brûmund, and accompanied by 394 plates on elephant folio, Leyden, 1873.

<sup>2</sup> Dwipa is also part of the names *Maldive* and *Laccadive*.

<sup>3</sup> The work entitled *Mâdjâpahit*, by Gramberg, is an historical romance based on the somewhat extravagant accounts of this kingdom.



was divided into the two states of Surakarta and Jokjokarta, which still retain nominal independence. The kingdom of Bantam was finally subjugated in 1808. By the English occupation of the island (1811-18) the European ascendancy was rather strengthened than weakened; and the great Java war (1825-30), in which Dipa Negarâ made a last great struggle to maintain the position of the native dynasty, resulted in the complete success of the Dutch.

The fullest account of Java is contained in Professor Veth's *Java: Geographisch, Ethnologisch, Historisch*, 3 vols., Haarlem, 1873-80. The first volume consists of a general description of the geography, flora, fauna, inhabitants, language, &c.; the second gives a history of the native states (during the growth of the Dutch power, already treated in detail by De Jonge, as much as possible out of view); and the third presents a topographical description of each of the

residences. The very existence of such a work implies the previous existence of a vast literature on its subject. Besides Jungblut, Buffon, and others referred to above, and under the heading *INDIEN ARCHIPELAGO*, we may mention Byckhoff van Groenou, *Javaansche Reys*, &c., in den Jaar 1656, Dordt, 1666; Hogendorp, *Coup d'œil sur l'île de Java*, Brussels, 1830; Pfyffer von Sencken, *Siziam van der Insel Java*, &c., 1829; Kussenbragen, *Natuur, en aardryksk. beschrijving van Java*, Groningen, 1841; W. H. van Hoevell, *Reis over Java*, Amsterdam, 1849, &c., and *Uit het Ind. Ieren*, Zaltbommel, 1869; D'Almeida, *Life in Java*; Pijnappel, *Geographie van Ned. Ind.*; Hollander, *Handleiding voor de land en volkenkunde van Nederlandsch Indië*; Gramberg's historical romances, and E. D. Dekker (Militair), *Marz Handel van d. Kogheringen der Nederlandsche Handelsmaatschappij*, Amsterdam, 1869, are of value for their pictures of Javanese life. Professor Veth's work contains physical, historical, and topographical maps. Others on a larger scale will be found in the *Atlas van Nederland en zyne Oerzeeische Bezittingen*, published by A. W. Sijthoff, 1879. (H. A. W.)

**JAWAROW**, the chief town of a district in the Austrian crown-land of Galicia, with extensive suburbs. It contains a nunnery, and has a good grain market. The town was a favourite residence of the Polish king John Sobieski, who there received the congratulations of the pope and the Venetian republic on his success against the Turks at Vienna (1683). At Jawarow Peter the Great was betrothed to Catherine I. The population in 1869 was 8699.

**JAXARTES.** See **SIE DARIA**.

**JAY** (French, *Géai*), a well-known and very beautiful European bird, the *Corvus glandarius* of Linnæus, the *Garrulus glandarius* of modern ornithologists. To this species are more or less closely allied numerous birds inhabiting the Palearctic and Indian Regions, as well as the greater part of America, but not occurring in the Antilles, in the southern portion of the Neotropical Region, or in the Ethiopian or Australian. All these birds are commonly called Jays, and form a group of the Crows or *Corvidæ*, which may fairly be considered a Subfamily, *Garrulina*. Indeed there are, or have been, systematists who would elevate the Jaya to the rank of a Family, *Garrulidæ*—a proceeding which seems unnecessary. Some of them have an unquestionable resemblance to the Pies, if the group now known by that name can be satisfactorily severed from the true *Corvinæ*. In structure the Jays are not readily differentiated from the Pies; but in habit, so far as is known of them, they are much more arboreal, delighting in thick coverts, seldom appearing in the open, and seeking their food on or under trees. They seem also never to walk or run when on the ground, but always to hop. The body-feathers are commonly loose and soft; and, gaily coloured as are most of the species, in few of them has the plumage the metallic glossiness it generally presents in the Pies, while the proverbial beauty of the "Jay's wing" is due to the vivid tints of blue—turquoise and cobalt, heightened by bars of jet-black, an indication of the same style of ornament being observable in the greater number of the other forms of the group, and in some predominating over nearly the whole surface. Of the many genera that have been proposed by ornithologists, perhaps about nine may be deemed sufficiently well established.

The ordinary European Jay, *Garrulus glandarius* (fig. 1), has of late years suffered so much persecution in the British Islands as to have become in many districts a rare bird. In Ireland it seems now to be indigenous to the southern half of the island only; in England generally, it is far less numerous than formerly; and Mr Lumsden (*Scottish Naturalist*, iii. pp. 230-240) has shewn that in Scotland its numbers have decreased with still greater rapidity. There is little doubt that it would have been exterminated by this time but for its stock being supplied in autumn by immigration, and for its shy and wary behaviour, especially at the breeding-season, when it becomes almost wholly mute, and thereby often escapes detection. No truthful man, however much he may love the bird, will gainsay the depredations on fruit and eggs that it at times commits; but the gardeners and gamekeepers of Britain fall into the usual

error of persons imperfectly acquainted with the ways of Nature, and, instead of taking a few simple steps to guard their charge from injury, or at most of punishing the individual birds from which they suffer, deliberately adopt methods of wholesale destruction—methods that in the case of this species are only too easy and too effectual—by proffering temptation to trespass which it is not in Jay-nature to resist, and accordingly the bird runs great chance of total extirpation. Notwithstanding the war carried on against the Jay, its varied cries and active gesticulations shew it to be a sprightly bird, and at a distance that renders its beauty-spots invisible, it is yet rendered conspicuous by its cinnamon-coloured body and pure white tail-coverts, which contrast with the deep black and rich chestnut that otherwise mark its plumage, and even the young at once assume a dress closely resembling that of the adult. The nest, generally concealed in a leafy tree or bush, is carefully built, with a lining formed of fine roots neatly interwoven. Herein from four to seven eggs, of a greenish-white closely speckled, so as to seem suffused with light olive, are laid in March or April, and the young on quitting it accompany their parents for some weeks.



FIG. 1.—European Jay.

Though the common Jay of Europe inhabits nearly the whole of this quarter of the globe south of 64° N. lat., its territory in the east of Russia is also occupied by *G. brandti*, a kindred form, which replaces it on the other side of the Ural, and ranges thence across Siberia to Japan; and again, on the Lower Danube and thence to Constantinople the nearly-allied *G. krynicki* (which alone is found in southern Russia, Caucasus, and Asia Minor) shares its haunts with it.<sup>1</sup> It also crosses the Mediterranean to Algeria and Morocco; but there, as in southern Spain, it is probably but a winter immigrant. The three forms just named have the widest range of any of the genus. Next to them come *G. atricapillus*, reaching from Syria to Beloochistan, *G. japonicus*, the ordinary Jay of southern Japan, and *G. sinensis*, the Chinese bird. Other forms have a much more

<sup>1</sup> Further information will possibly shew that these districts are not occupied at the same season of the year by the two forms.



limited area, as *G. cervicalis*, the local and resident Jay of Algeria, *G. hyrcanus*, found on the southern shores of the Caspian Sea, and *G. taevanus* confined to the island of Formosa. The most aberrant of the true Jays is *G. lidthi*, a very rare species, which seems to come from some part of Japan (*vide* Salvadori, *Atti Accad. Torino*, vii. p. 474), though its exact locality is not known.

Leaving the true Jays of the genus *Garrulus*, it is expedient next to consider those of a group named, in 1831, *Perisoreus* by Bonaparte (*Saggio, &c., Anim. Vertebrati*, p. 43) and *Dysornithia* by Swainson (*F. B.-Americana*, ii. p. 495).<sup>1</sup>

This group contains two species—one the *Lanius infaustus* of Linnæus and the Siberian Jay of English writers, which ranges throughout the pine-forests of the north of Europe and Asia, and the second the *Corvus canadensis* of the same author, or Canada Jay, occupying a similar station in America. The so-called Siberian Jay is one of the most entertaining birds in the world. Its versatile cries and actions, as seen and heard by those who penetrate the solitude of the northern forests it inhabits, can never

be forgotten by one who has had experience of them, any more than the pleasing sight of its rust-coloured tail, which an occasional gleam of sunshine will light up into a brilliancy quite unexpected by those who have only sur-



FIG. 2.—American Blue Jay.

veyed the bird's otherwise gloomy appearance in the glass-case of a museum. It seems scarcely to know fear, obtruding itself on the notice of any passenger who invades its haunts, and, should he halt, making itself at once a denizen of his bivouac. In confinement it speedily becomes friendly, but suitable food for it is not easily found. Linnæus seems to have been under a misapprehension when he applied to it the trivial epithet it bears; for by none of his countrymen is it deemed an unlucky bird, but rather the reverse. In fact, no one can listen to the cheery sound of its ordinary calls with any but a hopeful feeling. The Canada Jay, or "Whiskey-Jack" (the corruption probably of a Cree name), seems to be of a similar nature, but it presents a still more sombre coloration, its nestling plumage,<sup>2</sup> indeed, being thoroughly Corvine in appearance and suggestive of its being a pristine form.

As though to make amends for the dull plumage of the species last mentioned, North America offers some of the most brilliantly coloured of the Subfamily, and the common

Blue Jay of Canada and the Eastern States of the Union, *Cyanurus cristatus* (fig. 2), is one of the most conspicuous birds of the transatlantic woods. The account of its habits by Alexander Wilson is known to every student of ornithology, and Wilson's followers have had little to do but supplement his history with unimportant details.<sup>3</sup> In this bird and its many allied forms, coloration, though almost confined to various tints of blue, seems to reach its climax, but want of space forbids more particular notice of them, or of the members of the other genera *Cyanocitta*, *Cyanocorax*, *Xanthura*, *Psilorhinus*, and more, which inhabit various parts of the Western continent. It remains, however, to mention the genus *Cissa*, including many beautiful forms belonging to the Indian Region, and among them the *C. speciosa* and *C. sinensis*, so often represented in Oriental drawings, though doubts may be expressed whether these birds are not more nearly related to the Pies than to the Jays. (A. N.)

JAY, JOHN (1745–1829), American statesman, was the descendant of a refugee Huguenot family, and was born at New York, December 12, 1745. After three years spent in the house of the pastor of the French church at New Rochelle, followed by four under a private tutor at home, he entered King's (now Columbia) College in 1760. On graduating there, May 15, 1764, he entered the office of Mr Kissam, an eminent New York lawyer; and in 1768 he was called to the bar. He rapidly rose into a lucrative practice, and in 1774 was married to Sarah, youngest daughter of William Livingston, afterwards governor of New Jersey. The great crisis in the fate of the American colonies was fast approaching; and, like many other clever young lawyers, Jay took an eager, active part in the proceedings that resulted in the independence of the United States. He was one of the committee of fifty selected by the citizens of New York in 1774 to correspond with other colonial committees on the subject of the Boston Port Bill. He was returned as a delegate from New York city to the continental Congress held at Philadelphia in September 1774, and, though almost the youngest member, was entrusted with drawing up the *Address to the People of Great Britain*. The numerous committees and associations which were from time to time appointed to meet the exigencies of that troubled period almost always included Jay's name. Of the second Congress also, which met at Philadelphia on May 10, 1775, Jay was a member; and his able and eloquent pen was again useful in writing addresses to the peoples of Canada and Ireland. He was a member of the secret committee of Congress for corresponding with the friends of America in Europe. In April 1776, while still retaining his seat in Congress, Jay was returned to the provincial convention of New York by New York city and county; and his consequent absence from Philadelphia deprived him of the honour of affixing his signature to the declaration of independence issued on July 4, 1776. It was Jay who drafted the constitution that was finally adopted by the New York convention; and that statesman, after acting as one of the council of safety for some time, accepted a provisional appointment as chief justice of New York State, which was afterwards confirmed under the organized constitution, with the proviso that he could hold with his judicial post no other save that of delegate to Congress "on special occasion." Such occasion was found in the secession of what is now the State of Vermont from the jurisdiction of New Hampshire and New York. Jay was sent to Congress (December 7, 1778), of which he was immediately elected president. The follow-

<sup>1</sup> Recent writers have preferred the former name, though it was only used subgenerically by its author, who assigned to it no characters, which the inventor of the latter was careful to do, regarding it at the same time as a genus.

<sup>2</sup> In this it was described and figured (*F. B. Americana*, ii. p. 296, pl. 55, as a distinct species, *G. brachyrhynchus*).

<sup>3</sup> The "Blue Jay" of a recent American humorist would, however, from the locality assigned to his imitable story, appear to be, not this species, but one of its western kindred—American ornithologists must determine which.



ing September his letter, written in the name of Congress, was addressed to the people of the States on the subject of currency and finance; and before the end of the year, having previously resigned his chief-justiceship and his presidency, he was despatched as plenipotentiary to Spain, where he lauded January 22, 1780. The results of the mission were unsatisfactory. In addition to the fact that he was not received by the Spanish court in a formally diplomatic character, he was seriously embarrassed by the action of Congress in drawing bills upon him for more than half a million dollars, in the hope apparently that he would have received a subsidy from Spain before the bills fell due. Although by stooping to the humiliation of importuning the Spanish minister, and by accepting a number on his own personal responsibility, Jay was able to meet some of the bills, he was at length forced to protest others; and the credit of the new country was only saved by a timely subsidy from France, out of which Franklin was enabled to remit from Paris the sum required to meet the bills then due. In 1781 Jay was commissioned to act with Franklin, Adams, Jefferson, and Laurens in negotiating a peace with Great Britain. He arrived in Paris from Spain, June 23, 1782; and after a variety of negotiations, in the course of which Jay evinced a jealous suspicion of the disinterestedness of France and a punctilious attention to the dignity of his country, the provisional articles were signed on November 30, 1782, and the formal treaty on September 3, 1783. Jay resigned his commissions, and on July 24, 1784, landed as a private citizen in New York, where he was presented with the freedom of the city, and elected a delegate to Congress. On May 7th the last-named body had already chosen him to be foreign secretary; and in that post he remained till the beginning of the Federal Government in 1789. In the question of the institution of such a government he had taken a keen interest: he joined Hamilton and Madison in issuing the *Federalist*; he published anonymously (though without succeeding in concealing the authorship) *An Address to the People of New York*, in vindication of the constitution; and he ably seconded Hamilton in inducing his native State to adopt it. On September 26, 1789, he became the first chief-justice of the supreme court of the United States. During one of his circuits Harvard University conferred on him the degree of LL.D. In 1792 he consented to stand for the governorship of New York State; but the "canvassers" who scrutinized the votes disqualified the returns of three counties; and, though Jay had received an actual majority of votes, his opponent General Clinton was declared elected.

During the war between Great Britain and France, the relations between the former and the American States became critical; a definite commercial treaty seemed the only means of averting war. Chief-Justice Jay was chosen envoy to England, though not without strong opposition. He landed at Falmouth in June 1794, signed a treaty with Lord Grenville on November 19, and disembarked again at New York, May 28, 1795. Several of the articles of "Jay's Treaty," especially that which declared that a free ship did not make free cargo, were hailed at home with furious denunciation. Jay was accused of having betrayed his country; his effigy was burnt along with copies of the treaty, and even after Washington signed the ratification in August, the States were in a ferment that prevented for a time the really beneficial action of the treaty. Two days before he landed, and before the particulars of the treaty had been published, Jay had been triumphantly returned as governor of his native State, and, notwithstanding his temporary unpopularity, he was re-elected in April 1798. With the close of this second term of office in 1801, he closed his public career. Although not yet fifty-six years old, he refused all offers of office, and

retiring to his estate near Bedford in Westchester county, New York, spent the rest of his life in rarely interrupted seclusion. His public utterances from 1821 till 1828 were mostly as president of the American Bible Society. On May 17, 1829, John Jay, in his eighty-fourth year, ended a life whose purity and integrity are commemorated in a sentence by Daniel Webster: "When the spotless ermine of the judicial robe fell on John Jay, it touched nothing less spotless than itself."

*The Life of John Jay, with Selections from his Correspondence and Miscellaneous Papers*, was published in 2 vols. by his son William Jay in 1833.

JAY, WILLIAM (1769-1853), dissenting preacher and religious author, was born at Tisbury in Wiltshire on May 6, 1769. The son of a stone mason, he had adopted his father's calling, when his appearance attracted the attention of the Rev. Cornelius Winter, the dissenting minister. Mr Winter at that time presided over a religious seminary at Marlborough, in which, with his advice and assistance, the young mason became a student in 1785. During the three years and a half that Jay spent at Marlborough, the wonderful preaching powers which distinguished him till the day of his death were rapidly developed. His first sermon was delivered in his seventeenth year; and before his majority he had preached nearly a thousand times. In 1788 he had even for a season occupied Rowland Hill's pulpit in London. But his youth warned him to seek more time for study, and he therefore accepted the humble pastorate of Christian Malford, near Chippenham, where he remained about two years. He had hardly spent a year in his next charge at the Hot Wells, Clifton, when he was unanimously chosen to be minister of Argyle Independent Chapel in Bath; and on January 30, 1791, he entered the sphere in which he was to spend the rest of his active life, attracting to his chapel hearers of every religious denomination and of every social and literary rank, and winning for himself a wide and solid reputation as a brilliant pulpit orator, as an earnest religious author, and as a pious minister. In 1841 the jubilee of his pastorate was celebrated; in 1852 he was requested to retire; and the connexion of sixty-three years formally ended in January 1853. He died on December 27, 1853.

As a preacher Jay was eloquent and impressive; but his expressions and style at times wanted refinement and delicacy. His sermons were often so practical and direct as to excite suspicion, though quite unfounded, of being aimed at individuals. He was fond of peculiar texts, and did not always restrain his sense of humour when in the pulpit. The popularity which his writings, especially his devotional writings, have found with a wide circle of readers vouches for their worth. In his books he is always earnest, homely, and practical, and at times attains a certain neatness of diction and aptness of illustration. Perhaps the best known of his works are his *Morning and Evening Exercises*; *The Christian Contemplated*; *The Domestic Minister's Assistant*; and his *Discourses*. For his *Short Discourses for the Use of Families* the diploma of D.D. was conferred upon him by the college of New Jersey; but he did not avail himself of the title. Jay also wrote an excellent *Life of Rev. Cornelius Winter*, and *Memoirs of Rev. John Clarke*. An edition of Jay's Works in 12 vols. 8vo, revised by himself, was issued in 1842-44; again, reduced in price, in 1856. A new edition, in 8 vols. 8vo, was announced in 1876. For further particulars see Jay's *Autobiography*, 1854; Rev. S. Wilson's *Memoir of Jay*, 1854; Wallace's *Portraiture of Jay*, 1854; and Cyrus Jay's *Recollections of William Jay*, 1859.

JEAN D'ANGÉLY, SAINT, chief town of an arrondissement in the department of Charente-Inférieure, France, is situated in a fertile vine-bearing district on the right bank of the river Boutonne, 16 miles south-east of La Rochelle. The most interesting buildings are the ruined abbey, destroyed in 1568, two large towers used as a prison and forming the remains of a 17th century church, an embattled clock-tower dating from 1276, a handsome colonnaded market-place, and a hospital. The inhabitants are engaged in distilling brandy, wool-spinning, and the

manufacture of cast-iron tools, agricultural implements, serges, &c.; and a trade in spirits, wines, cereals, and oil seeds is carried on. The population in 1876 was 6309.

St Jean d'Angély (*Angericum*) owes its origin to Pippin the Short, who founded a monastery on the spot about 768. The report that the head of John the Baptist was deposited there attracted crowds of pilgrims, for whose accommodation a town gradually grew up. In 1572 the duke of Anjou captured it from the Huguenots; but they retook it soon after. Its fortifications were razed under Louis XIII.

JEBEIL, JÜBETL, or DJEBAIL, an ancient town of Syria, is pleasantly situated on a slight eminence near the sea, about 20 miles north of Beyrout. It is surrounded by a wall, a mile and a half in circumference, with square towers at the angles, which along with the old castle at the south-east corner are attributed to the crusaders. In the gardens and vineyards that surround the town lie numerous broken granite columns,—these, with the number of ruined houses within the walls, testifying to its former importance. The stele of Jehawmelek, king of Gebal, found here is one of the most important of Phœnician monuments.<sup>1</sup> The small port is almost choked up with sand and ruins. The place has dwindled to a village of some 600 inhabitants.

Jebel is the Phœnician Gebal and the Byblos of the Greeks. Its inhabitants were renowned as stone-cutters (1 Kings v. 18, margin) and as shipbuilders (Ezekiel xxvii. 9); while Arrian (ii. 20, 1) represents Nylus, king of Byblös, as joining Alexander with a fleet, after that monarch had captured the city. Philo of Byblos makes it the most ancient city of Phœnicia, founded by Kronos, z. c., the Moloch (Melek) who appears from the stele of Jehawmelek to have been with Baaltis (בעלת נבל) the chief deity of the city. Baaltis on this stele has the characteristics of Isis-Hathor. Compare the legend that the ark with the corpse of Osiris was cast ashore at Byblos, and there found by Isis (Plut., *Mor.*, 357). The orgies of Adonis in the temple of Baaltis (Aphrodite Byblia) are described by Pseudo-Lucian, *De Dea Syr.*, cap. vi. The river Adonis is the Ibráhîm river, which flows near the town. The crusaders, after failing before it in 1099, captured "Giblet" in 1103, but lost it again to Saladin in 1189. Under Mahometan rule it has gradually decayed. See Renan, *Miss. de Phen.*; Meyers, *Phönizier*, ii. 1, 107; Bäderer-Socin's *Handbook*.

JEDBURGH, a royal and parliamentary burgh of Scotland, the county town of Roxburghshire, is situated on the river Jed, a tributary of the Teviot, 49 miles south-east of Edinburgh, and 10 miles north of the English border. The town consists mainly of four well-paved streets diverging at right angles from the central market-square. Next to the abbey in point of historical interest is Queen Mary's house, where she resided for some time in 1566. The county prison occupies the site of the ancient castle of Jedburgh, destroyed in 1409. The abbey, one of the grandest ecclesiastical ruins in Scotland, was founded in 1118 by Prince David, afterwards David I., for the reception of certain Austin canons from St Quentin's at Beauvais. The nave, an exquisite example of the transition from Norman to Early English, measures 133½ feet by 59½ feet. With the exception of the north piers and a small portion of the wall above, which are Norman, the whole of the tower, 30 feet square and 86 feet high, belongs to the end of the 15th century. In the choir there is some very early Norman work; the south chapel of the choir affords good specimens of the Decorated period. The total length of the magnificent pile, reduced to ruins by the conflicts of which Jedburgh was so often the scene, is 235 feet. Jedburgh, one of the first Scottish towns to take up the woollen manufacture (its first mill began in 1728), at present has five factories, employing 200 hands, and producing goods—chiefly tweeds—to the annual value of about £70,000. The burgh unites with Haddington, Dunbar, North Berwick, and Lauder in returning a member to parliament. The population in 1881 was 3400.

<sup>1</sup> See the recent discussions by Enting (*Z. D. M. G.*, 1876), Halévy, (*Journ. As.*, 1879), and Ganneau (*Ét. d'Arch. Or.*, i., 1880).

Jedburgh, the final form of a name of which eighty-two variations have been collected, does not appear before the 15th century; Jedworth, still lingering among the lower ranks as Jethart, is much more ancient; Egred, bishop of Lindisfarne (830-838), gifted that see with the village and lands of Geddewrð. Before the end of the 11th century the village had become a burgh; and under David I. (1124-1153) it was a royal residence, and the chief town of the Middle Marches. The town received a charter from Robert I., and another in 1566 from Mary. During the troublous times on the borders in the Middle Ages, Jedburgh was an important place, and often experienced the disastrous effects of fire and sword. The phrase "Jethart Justice," meaning hanging a man and trying him afterwards, has passed into a proverb.

JEFFERSON, THOMAS (1743-1826), the third president of the United States, and the most conspicuous apostle of Democracy in America, was born April 2, 1743, at Shadwell, Albemarle county, in the State of Virginia, a region of which his father Peter Jefferson, an obscure and unlettered planter, was the third or fourth settler.

At the early age of five years Thomas was sent to an English school, and from that time until he finished his studies at William and Mary's College in 1762 appears to have enjoyed superior educational advantages, and to have turned them all to good account. He carried with him from college, at nineteen, a tolerably thorough reading knowledge of the Latin, Greek, and French languages, to which he added a familiarity with the higher mathematics and natural sciences only possessed at his age by men who have, as he had, a rare natural faculty for the prosecution of those studies. Soon after leaving college he entered the law office of Mr George Wythe, then at the head of the Virginia bar, and withal, Jefferson being judge, "the best Latin and Greek scholar in the State." In Mr Wythe he found a "faithful and beloved mentor in youth and most affectionate friend through life." In 1767, after five years' close application to the study of his profession, he was admitted to the bar. The death of his father in 1757 left Thomas, who was the eldest son, heir to the estate on which he was born, and which yielded him an income of about £400 a year, a sum in those days sufficient to gratify all his tastes, and to give him, as he matured, the position of an independent country gentleman. At the time of his admission to the bar he is described by his contemporaries as 6 feet 2 inches in height, slim, erect as an arrow, with angular features, a very ruddy complexion, an extremely delicate skin, full deep-set hazel eyes, and sandy hair, an expert musician (the violin being his favourite instrument), a good dancer, a dashing rider, and a proficient in all manly exercises. He was, and continued through life, frank, earnest, cordial, and sympathetic in his manner, full of confidence in men, and sanguine in his views of life.

Though mostly known to fame as a statesman, Jefferson's success as a lawyer showed that the bar had no rewards which were not fairly within his reach. He had sixty-eight cases before the chief court of the province the first year of his practice, and nearly twice that number the second. In the fourth, his register shows that he was employed in four hundred and thirty cases. During the eight years that he continued in active practice his income had enabled him to live like a gentleman, and to add a few hundred acres to his landed estate from time to time, until his inheritance of 1900 acres had become, in 1774, 6000 acres, and all paid for. But, while fired with the Virginian passion of the period for acquiring land, Jefferson does not appear to have shared the passion which usually accompanied it, of multiplying slaves to clear and till it. He was one of the first of English-speaking statesmen with foresight enough to discover the thunders with which the dark cloud of slavery was charged, and with courage enough to warn his countrymen against them. It does not appear that he ever acquired any slaves by purchase and as an investment.

In 1767 Governor Fauquier, the colonial governor of Virginia, died. The arrival of the new governor, Baron de Botetourt, in October 1768, was followed, according to usage, by the dismissal of the House of Burgesses, and a new election was ordered. Jefferson, offering himself as a candidate, was elected from the county of Albemarle, and continued to be annually re-elected until the House of Burgesses was closed by the revolution. His public career began, like that of some of the greatest parliamentarians before



him, in a mortifying failure. In conformity with a usage brought from the mother country of selecting one of the younger members to draft the reply to the governor's speech, this complimentary duty was devolved upon Jefferson. He confined himself too closely for the taste of the committee to the language of the resolutions which he was expected to amplify and glorify. His address was rejected, and the duty of preparing a substitute was confided to another member. This humiliation doubtless had some share in giving to his pen the parliamentary distinction usually won only by the tongue; for he was no orator—indeed, though one of the foremost members of several deliberative bodies in his time, he can fairly be said to have never made a speech.

Jefferson's legislative duties were not destined to detain him long from his profession. The king having abandoned the policy of levying internal taxes, and directed instead that a duty upon certain leading articles of foreign commerce should be levied at the custom-houses in the colonies, in the spring of 1769 a messenger arrived at Williamsburg, then the seat of government of Virginia, announcing to the House of Burgesses the firm resolve of Massachusetts to resist these duties by all constitutional means, and asking the concurrence and co-operation of Virginia. On the third day of the session of the House of Burgesses four resolutions were adopted with substantial unanimity, in harmony with those adopted by Massachusetts. The first declared against taxation without representation; the second, that the colonies may concur and co-operate in seeking redress of grievances; the third, that sending accused persons away from their country for trial is an inexpressible complexity of wrong; the fourth, that they should send an address on these topics to the "father of all his people," beseeching his "royal interposition." On the following day, and without waiting for an official copy of these resolutions to reach him, Governor Botetourt dissolved the House of Burgesses.

Thus in five days terminated, for the present, Jefferson's career as a legislator. But, though brief and crowned with no results to satisfy his ambition, history does not pronounce his first experience as a legislator inglorious, for it was illustrated by an effort, which was not the less honourable to him because it was unsuccessful, to ameliorate the condition of the African bondmen in Virginia. The law of those days forbade the manumission of a slave, except upon the condition that he was immediately sent out of the State. Jefferson desired the repeal of this law. His efforts were not only unsuccessful, but they developed such a state of feeling upon the subject as to bring into grand relief the courage which even at that early day ventured to propose such a measure.

The day after the House of Burgesses dispersed, its members met at a public hall in the Raleigh Tavern in Williamsburg, and, following the example of Massachusetts, resolved, with a near approach to unanimity—(1) to be more saving and industrious; (2) never to buy any article taxed by parliament for revenue, except low qualities of paper which they could not dispense with, nor (3) to import any article from Britain or in British ships if they could help it, until the offensive Act was repealed; and (4) to save all their lambs for wool. Every man who signed the agreement was re-elected, and every man who refused lost his election.

On February 1, 1770, while Jefferson and his mother were absent from home, his house was burned down. He had, however, already begun clearing the grounds and preparing for the erection of a new residence at Monticello, which occupied no inconsiderable portion of his time and thoughts for the next two years, and which was destined to become, for more than half a century, the most distinguished seat of private hospitality in America. On the 1st of January 1772 he married Martha Skelton, a widowed daughter of a wealthy neighbour and associate at the bar of Williamsburg, of large fortune in lands and slaves. The lady was very handsome, childless, fond of music, twenty-three; she proved to him a loving and devoted wife, and was the centre of a domestic circle the joys of which seemed only to be intensified and consecrated by the distractions of his public life.

In the spring of 1773 Jefferson was appointed by the House of Burgesses a member of "a Committee of Correspondence and Inquiry for the Dissemination of Intelligence between the Colonies." The appointment of this committee responded to the necessity then beginning to be felt by all the colonies of making common cause against the pretensions of the Crown, and looked to a convention in which their united purposes might find expression. The resolutions which gave birth to this committee provoked an immediate dissolution of the House, but its members were all re-elected. Soon after they had resumed their sittings in the following spring, news reached them of what is known in history as "The Boston Port Bill," by which the chief port of Massachusetts was to be closed to commerce on the 1st of June of that year (1774). The House of Burgesses thereupon set apart that day for fasting, humiliation, and prayer, thereby provoking from the governor another dissolution, May 20, 1774. This immediately led to the selection of delegates from the several counties to meet at Williamsburg in August, to consider the state of the colony, and to provide for an annual congress of the colonies. Jefferson was chosen a dele-

gate to the State Convention, but, owing to sudden indisposition which overtook him on his way, was unable to attend. His influence there, however, was not to be wanting, for much of the interval between the dissolution of the House and the meeting of the Convention was devoted to the consideration and preparation of a series of instructions for the deputies who were to be sent to the General Congress, which was to meet at Philadelphia in September. In these instructions, which he had intended himself to propose, could he have been present, he maintained "that the relation between Great Britain and these colonies was exactly the same as that of England and Scotland after the accession of James and until the Union, and the same as her present relations with Hanover,—having the same executive chief, but no other necessary political connexion; and that our emigration to this country gave no more rights over us than the emigration of the Danes and Saxons gave to the present authorities of the mother country over England." These instructions, though too radical then for the purpose for which they were designed, were laid upon the table of the delegates, read by many, and published in a pamphlet entitled *A Summary View of the Rights of America*, and extensively circulated. It ran through edition after edition in England, after receiving such modifications (attributed to the pen of Burke) as adapted it to the purposes of the Opposition; and it procured for its author, to use his own language, "the honour of having his name inserted in a long list of proscriptions enrolled in a bill of attainder commenced in one of the two Houses of Parliament, but suppressed in embryo by the hasty course of events." This paper placed Jefferson among the leaders, if not at the head of the revolutionary movement in America—events rapidly ripening in the public mind its novel and startling doctrines. The Declaration of Independence two years later, of which he asked that his tombstone should testify as the greatest achievement of his life, was but a perfected transcript of the *Summary View*.

Jefferson was the leading spirit in the succeeding sessions of the Virginia Convention; he was one of a committee of thirteen appointed to report a plan for arming Virginia; he was named a delegate to the General Congress, where he took his seat eight days after Colonel George Washington had been appointed by Congress commander-in-chief of the armies of the colonies; and he was placed upon the committee to draw up a statement of the causes which had impelled the colonies to take up arms against the mother country, and upon another committee to report on Lord North's "conciliatory proposition." In the winter of 1775-6 disastrous news arrived from England. The king in opening parliament had denounced the colonists as rebels, and recommended decisive coercive measures against them; and this was promptly followed by a law authorizing the confiscation of American vessels and cargoes, and those of all nations found trading in American ports, and the impressment of American crews into the British navy. This measure and the huge vote by which it was passed instantly crystallized the colonies, and on the 11th June 1776 Congress appointed Jefferson, Adams, Franklin, Sherman, and Livingston to prepare a Declaration of Independence.

Jefferson at the request of his associates prepared a draft of the Declaration, which, after two or three verbal corrections by them, was taken up for consideration in the House on the 2d of July. In the debate on the Declaration Jefferson took no part, "thinking it a duty to be on that occasion a passive auditor of the opinions of others, more impartial judges than he could be of its merits and demerits." Two or three expressions had been used which gave offence to some members: the words "Scotch and other foreign auxiliaries" were resented by some delegates of Scottish birth; and the strictures on the king's repeated veto of colonial laws repealing the law which permitted the slave trade were disapproved by some of the southern delegates.

On the evening of the 4th of July 1776 the Declaration was reported back from the committee of the whole House, and agreed to. Circumstances have given an historical importance to this document somewhat disproportioned to its merits as a statement of the grievances of the colonies; for it seemed to be the weapon that dismembered a great empire, and that gave birth to a nation of unlimited possibilities; it gave guarantees for the fame of its author which are possessed by no other production of an American pen; for more than a century it has been read to assembled multitudes in every considerable town in the United States on the anniversary of its adoption; and its style and sentiments have been the model for every people which since that time has sought to assert for itself the right of self-government.

Jefferson continued to participate actively in the efforts to organize the government of the confederation, and prepare it for the life and death struggle which was impending, until the 2d of September, when he resigned, to take his seat in the legislature of Virginia, to which he had been elected, and where he thought his services would be most needed. "When I left Congress in '76," he says in his autobiography, "it was in the persuasion that our whole code must be reviewed, adapted to our republican form of government, and, now that we had no negatives of councils, gover-



rors, or kings to restrain us from doing right, that it be corrected in all its parts with a single eye to reason and the good of those for whose government it was framed." To this task he now devoted himself. Of the various measures introduced in furtherance of this purpose he says: "I considered four, passed or reported, as forming a system by which every fibre would be eradicated of ancient or future aristocracy, and a foundation laid for a government truly republican." These were—the repeal of the laws of entail, the abolition of primogeniture and equal partition of inheritances, the restoration of the rights of conscience and relief of the people from taxation for the support of a religion not theirs, and a system of general education. He tried to add to these, but without success, the introduction of trial by jury into the courts of chancery, and to provide for the gradual emancipation of the slaves. He did, however, introduce a bill, which passed without opposition, forbidding the further importation of slaves into the State—the only important change effected in the slave system of Virginia during the revolutionary period. The importance he attached to his work in Virginia at this time he showed by resigning his seat in Congress, and by declining the appointment tendered him by Congress in 1776, to go with Franklin to Paris, to assist in negotiating treaties of commerce and alliance with France.

In the third year of the war (1779), and just as the darkest and most threatening clouds were gathering over Virginia, Jefferson was elected governor. The enemy had decided to carry the war into the south. The commonwealth was almost defenceless, all her military resources having been exhausted in sustaining Washington's policy of driving the enemy out of the north. Arnold entered Richmond, recently become the capital, on the 5th of January 1781, and ravaged the place. The legislature, which had taken refuge at Charlottesville, were pursued and dispersed by Tarleton, who immediately sent a party to capture Jefferson at Monticello. He narrowly escaped, his pursuers being in sight of him as he mounted his horse and rode off to join his family. Though Monticello was spared by Tarleton's order, Jefferson's estate of Elk Hill, on the James river, was less fortunate. It was completely despoiled by the orders of Cornwallis. It was natural that the ineffectual resistance made to the enemy in Virginia should have exposed the governor's conduct to criticism, for few knew, as he did, that a more effective defence was impossible without weakening the northern army, and totally disarranging the plans upon which the commander-in-chief wisely relied for the ultimate success of the national defence. An investigation of his conduct was threatened; but when it was ascertained that he had been acting in harmony with the policy of Washington, the investigation was not only abandoned but the legislature shortly after the expiration of his term of office resolved unanimously "That the thanks of the general assembly be given to our former governor, Thomas Jefferson, for his impartial, upright, and attentive administration while in office. The assembly wish to declare in the strongest manner the high opinion which they entertain of Mr Jefferson's ability, rectitude, and integrity as chief magistrate in this commonwealth, and mean, by thus publicly avowing their opinion, to obviate and to remove all unmerited censure." Jefferson became sensible that in the exhausted condition of Virginia, without money, without equipment, without troops, without any currency except the products of the soil, no governor not a trained soldier could hope to retain the confidence of the people during the crisis, and therefore he determined to decline re-election.

In 1782 he was summoned by Congress to act as one of the plenipotentiaries to negotiate a treaty of peace with the mother country, but the business was found to be so far advanced before he was ready to sail that his appointment was recalled, and we find him at the following winter session again occupying his seat in Congress, where, as chairman of the committee to which it was referred, he reported the definitive treaty of peace with England. At the succeeding session he introduced an elaborate report, and secured the adoption of the system of coinage which is still in vogue in the United States. In the same session he drafted the report of a plan for the government of the vast territory lying to the northwest of the Ohio river, which Virginia had ceded to the Federal Government in 1780. Among other provisions which he suggested, and which were adopted, was one big with a rebellion of far more threatening proportions than that which its author had just assisted in bringing to a successful issue. The clause in question provided "that after the year 1800 of the Christian era there shall be neither slavery nor involuntary servitude in any of the said States, otherwise than in punishment of crimes whereof the party shall be duly convicted to have been personally guilty." It was the attempt to organize States from this territory in defiance of this restriction that led to the war of 1861, and to the final, though costly, vindication of Jefferson's sagacity and forecast in 1783.

In 1784 Jefferson was again commissioned by Congress as minister plenipotentiary, this time to assist Franklin and Adams in negotiating treaties of commerce with European states. He joined his associates in Paris in July. The mission upon which he was sent proved somewhat premature. Jefferson, wisely judging that further and more correct information about America must pre-

cede any successful attempts to deal with European states to advantage, printed at his own expense, and distributed among his friends, some *Notes on Virginia*, which he had prepared two years before. It was in these notes that the oft-quoted passage occurs: "I tremble for my country when I think that God is just; that his justice cannot sleep for ever; that, considering numbers, nature, and natural means only, a revolution of the wheel of fortune, an exchange of situations, is among possible events; that it may become probable by supernatural interference. The Almighty has no attributes that can take sides with us in such a contest." A very bad translation of a copy of the *Notes* which had found its way to France having made its appearance in Paris, Jefferson felt he had no longer any motive for trying to limit their usefulness to the few discreet friends to whom he had addressed them.<sup>1</sup>

In January 1785 Dr Franklin, after eight years' residence at the French court, pressed his application to be relieved, and Jefferson was selected, as he gracefully put it in presenting his letters of credence, "to succeed him, for no one could replace him." Jefferson was exceedingly popular as a minister, and was fortunate in securing several important modifications of the French tariff in the interests of American commerce.

In the summer of 1789 Washington, who had been elected president of the United States under the new constitution, gave Jefferson leave of absence, and soon after his arrival in America, "as well from motives of private regard as a conviction of public propriety," tendered him the office of secretary of state. Reluctant as Jefferson was to leave Paris, he yielded at once to the wishes of the president, and entered upon the duties of his new office in March 1790. Alexander Hamilton, who was the head of the Federal party as distinguished from the Democratic, of which Jefferson was the most conspicuous representative, was appointed the secretary of the treasury. They represented the two great schools of political thought which contended for mastery in American politics, not only during Washington's administration, but for the succeeding sixty years, and until their differences were merged in the graver and more absorbing issues that grew out of the conflict between free and servile labour. Jefferson was an advocate of State sovereignty and of decentralization. He was strongly opposed to the leading features of the British constitution, and in cordial sympathy with the new school of politics which had recently begun to be felt in the government of France. His five years' residence in that country had greatly strengthened him in these views, and they more or less affected his treatment of all questions that came before him as a cabinet minister. Hamilton's great fear, on the other hand, was that the central government under the new constitution would be too weak, and he favoured all measures that tended to exalt and strengthen the executive, and to bring the government more in harmony with that of England. Washington very prudently gave the victory to the partisan of neither theory, though his sympathies were supposed to be more frequently with the Federal than with the Republican leader.

The most perplexing questions which occupied Jefferson's attention as secretary of state grew out of the war declared by France in 1793 against Holland and Great Britain. What should be the neutral policy and what were to be insisted upon as the neutral rights of the United States? Upon this question both parties put forth their whole strength. The Republicans, under Jefferson's lead, pretty generally sympathized with the French, and were inclined to authorize privateers to be fitted out in American ports to cruise against English vessels. This policy was energetically and wisely resisted by the Federalists, who were for peace with all and entangling alliances with none. Jefferson advocated the propriety of receiving a diplomatic representative from the French republic. In this his advice prevailed, and Genet was promptly sent as minister. With more zeal than discretion he proceeded at once to fit out privateers, and empower French consuls in the United States to organize courts of admiralty to condemn prizes. This led to heated discussions in the cabinet, and finally to the recall of Genet. Partly from discontent with a position in which he did not feel that he enjoyed the absolute, which meant pretty much the exclusive, confidence of the president, and partly because of the embarrassed condition of his private affairs, due mainly to the ravages of war, Jefferson resigned his seat in the cabinet December 31, 1793, and retired to Monticello. There he remained till the fall of 1796, when he was made vice-president at the election which called John Adams to the presidency. The duties of this position being limited to presiding over the Senate during its sessions, Jefferson spent most of the four years of his official term in improving his estate, and by his counsels directing the policy of the party of which he was the acknowledged leader. The excesses of the

<sup>1</sup> Jefferson took a very modest view of this book, and in a purely literary point of view he could not afford to take any other; but it was so thoroughly saturated with democratic-republican ideas, of which he was then the most complete living exponent, with the possible exception of Franklin, that it was widely and eagerly read, and no doubt did much to relax the hold the doctrines of divine right and of passive obedience had upon the educated classes of France, and measurably contributed to precipitate the great popular uprising in that kingdom, which Europe was soon to be convulsed.



Reign of Terror had worked a formidable reaction in America against the sympathizers with revolutionists in France. This, with the aggressive policy of the Directory, and the insulting reception given to the American envoys in Paris, for a time paralysed the Republican party. President Adams, mistaking the resentment felt in the United States towards France for a popular reaction there against republicanism, was betrayed into a series of ill-considered measures, which were not long in telling upon the fortunes of his party. Among these measures the most unfortunate perhaps were the alien and sedition laws, the former empowering the president to expel from the country such aliens as he should deem dangerous, and the latter punishing as sedition, with fine and imprisonment, the printing or uttering malicious charges against the president or Congress. The Republicans commenced an active agitation against the laws throughout the country, which, co-operating with a strong and popular sympathy with the Republican doctrines, finally resulted in the election of Jefferson and Burr, the candidates of the Republican party, as president and vice-president, and the defeat of Adams and Pinckney the candidates of the Federalists. Washington having died only a few months before, this election proved the *coup de grace* of the Federal party, and established Jeffersonian Republicanism as the permanent policy of the country. Jefferson entered upon the duties of the presidency on the 4th of March 1801, and was re-elected for the term commencing March 4, 1805, by 143 out of 176 electoral votes. His administration of twice four years was characterized by the simplicity which distinguished his conduct in private life. He eschewed all pomp and ceremony designed artificially to distinguish the president from the people. His dress "was of plain cloth" on the day of his inauguration. Instead of driving to the capital in a coach and six as had been the practice, he rode there on horseback, without a guard or even a servant in his train, dismounted without assistance, and hitched the bridle of his horse to a fence. Instead of opening Congress in the English fashion, with a speech to which a formal reply was expected, he sent his message by a private hand. Court etiquette was practically abolished, and the weekly levee with it. The code of precedence was essentially modified. Titles of honour were not recognized as such. "Excellency," "Honourable," and even "Mr.," were distasteful to him. Between the President and governors of States he recognized no difference in rank, each being the supreme head of an independent state. "If it be possible," he said, "to be certainly conscious of anything, I am conscious of feeling no difference between writing to the highest and lowest being on earth."

In public official station he regarded himself purely as a trustee for the public. He discontinued the practice of sending ministers abroad in Government vessels, nor would he have his birthday celebrated by state balls; he refused to appoint days of fasting and thanksgiving on the ground that they were religious rites, and no recommendation from him, therefore, could make them more or less binding upon the conscience. To secularize and republicanize the Government were the paramount purpose and the distinguishing feature of his administration. His cabinet, of which Madison and Gallatin were the pillars, was in thorough sympathy with Jefferson in his general policy, and its perfect harmony was uninterrupted. He gave his ministers his entire confidence. "If I had the world to choose from," he once said, "I could not change one of my associates to my better satisfaction." The first important act of his administration was to send four of the six vessels constituting the so-called navy of the republic to the Mediterranean to exterminate the Algerine pirates who for half a century had preyed upon the commerce of the world, thus initiating a series of events which in a few years rendered the commerce of the Mediterranean as safe as that of the English Channel. Possessed with a conviction of the supreme commercial importance of New Orleans, he directed negotiations to be opened with the French Government, which resulted in the purchase for \$15,000,000 of the territory of Louisiana, which had been ceded by Spain to France. Though the constitutional power under which this important transaction was consummated was far from clear, neither its validity nor its wisdom was ever seriously questioned; and it is now justly regarded by his countrymen as the crowning achievement of his administration, and none the less meritorious for the responsibility he deliberately assumed in bringing it to pass. The remainder of his administration derives most of its historic importance from his unsuccessful attempt to convict Aaron Burr, the late vice-president, of having engaged in treasonable projects in the south-west, and from his efforts to maintain, without war, the rights of neutrals on the high seas. Among the less conspicuous though scarcely less important measures of his administration were the careful exploration of the Western Territories; reducing the public debt, and practically extirpating from the country the then not unpopular delusion that a national debt is a national blessing; fortifying the seaports; reorganizing and rearming the militia; diminishing the taxes; and extinguishing the Indians' titles by fair purchase, and promoting their emigration beyond the Mississippi. On the 4th of

March 1809 he retired from the presidency, after an almost continuous public service of over forty years. He was pressed to allow himself to be re-elected for a third term, but refused unconditionally, though the legislatures of five States formally requested him to be a candidate.

Jefferson, whose private fortune had been seriously compromised by the interruptions of foreign commerce before and during his administration, and by the expenses incident to his representative position, lived seventeen years after his retirement, and to the last was the most considerable personage in the United States. His immediate successors in the presidency for the next sixteen years were his pupils and devoted personal friends, and rarely ventured upon any important step without the support of his approval. The employments of his closing years were in harmony with the dignified and patriotic purposes of his active life. Nothing that concerned the welfare of the country was a matter of indifference to him. He urged successfully the foundation of a university, and became one of its most efficient trustees. His correspondence during this period is regarded as one of the most interesting and instructive contributions to the early literature of the United States. He had inherited a wonderful constitution and herculean strength, neither of which did he ever abuse.

In the spring of 1826 the decline of his strength, which had been gradually increasing for two or three years, became more rapid, and on the 4th of July he expired, in the eighty-third year of his age. John Adams, his predecessor in the presidency, by an impressive coincidence, died on the same day,—the fiftieth anniversary of an event imperishably associated with the names of both and with the fortunes of a nation.

See *The Writings, Correspondence, &c., of Thomas Jefferson*, edited by A. Washington, 9 vols., New York, 1853-54; *Memoir, Correspondence, &c., of Thomas Jefferson*, edited by T. J. Randolph, 4 vols., Charlottesville, 1829; George Tucker, *Life of Thomas Jefferson*, 2 vols., Philadelphia, 1837; Henry Randall, *Life of Thomas Jefferson*, 3 vols., New York, 1858; James Parton, *Life of Thomas Jefferson*, Boston, 1874; Sarah N. Randolph, *Domestic Life of Thomas Jefferson*, New York, 1871; H. Lee, *Observations upon the Writings of Jefferson*, Philadelphia, 1839; Cornelis De Witt, *Thomas Jefferson*, Paris, 1861. (J. B. L.)

JEFFERSON CITY, capital of the State of Missouri, occupies an elevated and picturesque site in Cole county, on the right bank of the Missouri river, 125 miles west of St Louis. The city is well built. It has an efficient school system, and is the seat of an Episcopal college, and of Lincoln Normal Institute, which is maintained by the State for the instruction of coloured youths of both sexes. The State library contains about 25,000 volumes. The manufactures comprise flour, furniture, carriages, farm implements, and iron goods. Population in 1880, 5271.

JEFFERSONVILLE, the county seat of Clark county, Indiana, U.S., is situated on the north bank of the Ohio river. The streets are of a uniform width of 60 feet. The falls of the Ohio afford a fine water-power, so that manufactories are numerous. Among them are locomotive and car works, plate-glass works, two ship-yards, and railway machine shops. The southern State penitentiary and an extensive Government depot of army supplies are situated here. Population in 1880, 9357.

JEFFREY, FRANCIS (1773-1850), a judge in the Scottish Court of Session, with the title of Lord Jeffrey, was the son of a depute-clerk in the supreme court of Scotland, and was born at Edinburgh, 23d October 1773. After attending the High School six years, he studied at the university of Glasgow from 1787 to May 1789; and at Oxford from September 1791 to June 1792. Having in the following winter begun the study of law at Edinburgh University, he became a member of the Speculative Society, in the debates of which he measured himself not disadvantageously with Scott, Brougham, Francis Horner, the marquis of Lansdowne, Lord Kinaird, and others.

He was admitted to the bar on December 18, 1794, but, having abandoned the Tory principles in which he had been educated, he of course found his father's connexion of little advantage to him; indeed the adoption of Whig politics was at this time almost a complete obstacle to legal success. His failure to obtain sufficient professional employment led him to the conception of a variety of schemes of "literary eminence," none of which were put into execution; and more than one attempt to obtain an

office which would secure him the advantage of a small but fixed salary likewise proved abortive. To the proposal made by Sydney Smith in Jeffrey's house to a company of young men, none of whom had yet achieved fame or occupied any professional position of importance, that they should start a review, Jeffrey was accordingly prepared to give a favourable reception; and, the scheme being received with acclamation, the result was the appearance on the 10th October 1802 of the first number of the *Edinburgh Review*. At the outset the *Review* was not under the charge of any special editor. The first three numbers were, however, practically edited by Sydney Smith, and on his leaving for England the work devolved chiefly on Jeffrey, who, after an arrangement with Constable the publisher, was appointed editor at a fixed salary. Most of those associated in the undertaking were Whigs in their political convictions; but, although the general bias of the *Review* was towards social and political reforms, it was so little of a party organ that for a time it numbered Sir Walter Scott among its contributors; and no distinct emphasis was given to its political leanings until the publication in 1808 of an article on the work of Don Pedro Cevallos on the *French Usurpation of Spain*, which led shortly afterwards to the appearance of the rival *Quarterly*. According to Lord Cockburn the effect of the first number of the *Edinburgh Review* was "electrical," and it is not difficult to understand why it should have been so, for, if its learning was far from being so omniscient as was then imagined, and if much of its speculation was superficial and rambling, and its literary criticisms greatly deficient in true subtlety and discernment, it certainly did not err on the side either of modesty or of dulness: Indeed, not only were its opinions generally expressed in telling and forcible language, but the clever vivacity and wit as well as the external glitter and brilliancy of many of the articles, and their easy and jaunty air, were fitted to produce an imposing impression of latent resources of many-sided talent and comprehensive erudition. The novelty, moreover, of such a voluminous and elaborate periodical, the anonymousness of its contributions, and the fact that it devoted its pages chiefly to extended criticisms—often by no means flattering or complimentary—of living authors, were all elements in its success. Of course, on the other hand, allowance must be made for its early deficiencies, not only on account of the literary inexperience of the writers, but from the fact that it was itself practically a hitherto untried experiment in literature. Its improvement as regards substantiality of matter and genuineness and depth of learning was very marked as soon as its success permitted Jeffrey to enlist in its service a staff of writers who had generally made a special study of the particular subjects on which they wrote, and who, instead of contenting themselves with a summary and an interspersed criticism of the works they reviewed, made them the occasion of an independent and original contribution, often having only a very remote connexion with the works which suggested it. Whatever deductions also it may be necessary to make in distinguishing between the merits of the *Review* and its reputation, its influence both as a literary and as a political organ has much exceeded that of any other English periodical, and its relation to the social, political, and literary history of England during the first half of the present century has been of no small importance. The period of Jeffrey's editorship extended to about twenty-six years, having ceased with the ninety-eighth number, published in June 1829. The *Macvey Napier Correspondence* gives some indication of what must have been the delicacy and difficulty of his task, and enables us to appreciate more intelligently the panegyric of his biographer in regard to the literary skill and practical discernment which gathered together such a brilliant galaxy of talent, the

suave firmness and wise prudence which controlled and utilized to such advantage their several idiosyncracies, and the tact and cleverness which arranged and adjusted their varied lights with such correct appreciation of harmonious unity.

Jeffrey's own contributions, according to a list which has the sanction of his authority, numbered two hundred, all except six being written before his resignation of the editorship, and two immediately subsequent to this. A selection from these contributions was published in 1843 in four volumes. The composition of eight *Review* articles in a year is not an excessive literary task, but the subjects on which Jeffrey elected to give his opinion were very multifarious, and he wrote with great rapidity, at odd moments of leisure, and with little special preparation. Although also he possessed a considerable accumulation of accurate information on a great variety of subjects, and had disciplined his taste by a wide and catholic acquaintance with English literature, he had given no thorough and systematic attention to any particular branch of study. Great fluency and ease of diction, considerable command of illustration, a certain superficial warmth of imagination and moral sentiment, a natural tendency towards mockery and ridicule, and a sharp eye to discover any oddity or peculiarity of style or violation of the accepted canons of good taste, were what lent to his criticisms the kind of pungency and effectiveness they possessed. It must, moreover, be added that, if he failed egregiously in the appreciation of the highest kinds of excellence both in style and in thought, the blemishes and defects which occupied so much of his attention, and which he magnified and distorted, had generally a real existence. Notwithstanding, however, his keen practical judgment and his liberal tendencies, both his political and his literary prognostications were generally falsified by the result. He never showed any proper comprehension of principles, or power of detecting and estimating latent forces either in politics or in matters strictly intellectual and moral; and certain of the higher spheres of reflexion and imagination, as for example, that of the "Lake Poets," his unhappy mistakes in regard to whom have earned for him such unenviable fame, were utterly remote from his understanding and sympathy. Had an adequate share of his attention been concentrated on some special branch of literature, had his fluency been held in check by a more thorough acquaintance with the subjects which engaged his interest, his regard for immediate impressiveness not been exaggerated by the influence of his professional duties, his artistic sense, which was keen and true so far as it went, not been mutilated and deteriorated by untoward circumstances, he would undoubtedly have earned for himself a high place among the writers of his epoch. As it is, his reputation is now unsubstantial and shadowy, and he is remembered chiefly from his accidental and not always gratifying and desirable relation to others who have gained an independent fame.

Notwithstanding the increasing success of the *Review*, Jeffrey always continued to look to the bar as the chief field of his ambition, and indeed he soon experienced that his literary reputation was a help and not an obstruction to professional advancement. Probably one reason of this was that his literary talents were supplemented by a personal character of the highest integrity and honour, and by fine social gifts rooted in true geniality and kindness, and adorned with an agreeable pleasantry and wit never tainted with the venom of bitterness. As an advocate his sharpness and rapidity of insight gave him a formidable advantage in the detection of the weaknesses of a witness and the vulnerable points of his opponent's case, while he grouped his own arguments with an admirable eye to effect, especially excelling in eloquent closing appeals to a jury,



more particularly when an opportunity presented itself for the introduction of the pathetic element. Probably but for his rapid utterance and affected accent, his weak physique, and his too copious command of language, he might have attained to the highest rank as an orator. Jeffrey was twice, in 1820 and 1822, elected lord rector of the university of Glasgow. In 1829 he was chosen dean of the faculty of advocates. On the Whigs obtaining office in 1831, he became lord advocate, and entered parliament as member for the Perth burghs. After the passing of the Reform Act, in the framing of which measure he had the principal charge so far as it related to Scotland, he was returned for Edinburgh; but his parliamentary career, which, though not so brilliantly successful as some expected, had won him high general esteem, was terminated by his elevation to the judicial bench as Lord Jeffrey in May 1834. He died at Edinburgh 26th June 1850.

*The Life of Lord Jeffrey, with a Selection from his Correspondence*, by Lord Cockburn, appeared in 1852 in two volumes. See also the *Selected Correspondence of Macvey Napier*, 1877, and the sketch of Jeffrey in Carlyle's *Reminiscences*, vol. ii., 1881. (T. F. H.)

JEFFREYS, GEORGE JEFFREYS, LORD (c. 1648-1689), lord chancellor of England, was born probably in 1648 at Acton in Denbighshire, of a respectable but not rich family. He was smitten with the desire of becoming a lawyer by seeing, when a boy at St Paul's school in London, the magnificent procession of the judges to the cathedral; and, although his family was hard put to it by the expense, he spent some time at Westminster school before entering the Inner Temple as a student at sixteen. The allowance he received from home was quite unequal to the demands of the dissolute habits into which he quickly fell, but it is said that the promise of future eminence, afforded by the fits of studiousness which divided his orgies, procured for the dissipated student both long credit and presents of money. He was exceedingly popular as a table companion, especially with the inferior attorneys and attorneys' clerks with whom, then as afterwards, he preferred to drink; and in the low practice which he began at Old Bailey and the London Sessions immediately on being called to the bar in November 1668, he found his boon companions very useful in procuring him briefs. Voluble, unscrupulous, and overbearing, he rapidly developed in his constant dealings with the most degraded criminals the coarse bullying manner which disgraced him throughout his whole career. He sought every means of ingratiating himself with the city aldermen, and in 1671, at the singularly early age of twenty-three, became their common serjeant, and in 1678 recorder of London. He had by that time pushed his way into the higher courts, where his marvellous address in speaking and cross-examination made up for, if it did not conceal, his shallow legal knowledge. Jeffreys had hitherto nominally belonged to the anti-court or liberal party; but, perceiving that they had but little patronage in their gift, he had opened secret negotiations with Charles II., and immediately on taking the oaths as recorder he openly declared himself a partisan of the court. The year before he had been knighted and appointed solicitor to the duke of York. To reward him for the servility which he displayed, especially in connexion with the Popish plot trials, he was appointed chief justice of Chester, and advanced to a baronetcy. His insolence and intemperance, already notorious, became in his chief-justiceship well nigh intolerable. He received a rebuff in 1680 when for his conduct in obstructing the assembling of parliament he was reprimanded on his knees by the speaker, and forced to resign his recordership in December of the same year. Such indignities were

merits in the eyes of the king, to whose favour Jeffreys laid additional claims by his efforts to abrogate the charter of London, and by his activity as counsel against the suspected Rye House conspirators. He received his reward. Lord Campbell remarks, "Jeffreys became chief-justice of England, as the only man fit to condemn Algernon Sidney." He was sworn in in November 1683, and shortly became privy councillor and member of the cabinet. In the court of the King's Bench, the new chief-justice let few considerations stand between him and his desire to satisfy the king. His iniquitous servility is to be traced in the *State Trials*. When Charles died in February 1685, Jeffreys exchanged a master who disliked him as a wretch "with no learning, no sense, no manners, and more impudence than ten carted street-walkers," for one who found in him a thoroughly congenial tool. In May 1685 Jeffreys was raised to the peerage by the style of Baron Jeffreys of Wem, and in August went into the western counties as president of a special commission appointed to try the numerous cases of treason arising from the duke of Monmouth's ill-fated rebellion. It was in this "bloody assize" that he was to deepen the stain that already tarnished his fame, and to make the name "Judge Jeffreys" a synonym for a monster of bloodthirsty cruelty, blasphemous rage, and brutish intemperance. In the "campaign" he gave the rein to his ferocity; he was maddened with slaughter, and his appetite for blood grew by what it fed on. The horrible glare of his eye, the savage lines of his face, his fierce shouts of wrath, terrified and confused guilty and innocent alike. With hateful cunning he let it be bruited that the only hope of mercy lay in pleading guilty, and by this cold-blooded artifice lightened his labours. He had a powerful incentive to active butchery: the vacant post of lord chancellor was to be won by good service. The estimates of the numbers of victims of the commission vary: 320 was the official return to the treasury; Lord Lonsdale says 700, and Burnet 600. Upwards of 800 were transported as slaves to the West Indies, while others only escaped by purchasing their pardons from the judge at most exorbitant rates. When the chief-justice returned to Windsor in September, the great seal of England was placed in his blood-stained hands. For the rest of his career the lord chancellor was an unresisting agent of King James in his most illegal schemes. Finding himself losing favour at court, he even revived the ecclesiastical court of High Commission, abolished in 1640 by an Act which forbade its revival, and himself engaged to act as president. In the attempt against the rights of the fellows of Magdalen College, Oxford, and in the trial of the seven bishops, Jeffreys was the king's right hand; but, when the proceedings of James had at last roused the indignation that cost him his crown, the lord chancellor was one of the first to advise concession. When the king fled in 1688, Jeffreys was in the utmost consternation. For him, he knew, there could be no mercy. Shaving off his shaggy eyebrows, and disguising himself as a common sailor, he attempted to escape to Hamburg in a small collier, but, while drinking in a low public-house at Wapping, he was recognized by a poor scrivener who had once encountered the wrath of the judge, and had never forgotten the glare of his eye. Jeffreys was only saved from being torn in pieces by the mob by the timely arrival of a strong guard, who conducted the trembling wretch to the Tower. There he lay for some months, tortured by anguish both of mind and body, which he endeavoured to drown in copious draughts of brandy. He died miserably on April 19, 1689. Jeffreys was twice married, and had ten children, but his title became extinct in 1703, in the person of his son John, notorious for having interrupted the funeral of Dryden. It is said that in 1688 Lord Jeffreys was about to be created earl of Flint; and, though

the patent never passed the great seal, a book was dedicated to him, giving him the title.

For the character of Jeffreys not even the most impartial historian can say a good word. Of strong intelligence and clear legal head, and, according to Roger North, when he was in temper and matters indifferent came before him, becoming his seat of justice better than any other that author had seen in his place, he might have risen to a high position among the learned luminaries of the bench, had he not prostituted his talents to unworthy ends, and swamped his faculties in the most brutal intemperance. He treated all from whom he had nothing to expect with coarse insolence, taking an especially malicious delight in giving, as he phrased it, "a lick with the rough side of his tongue" to those whom his maudlin caresses of the night before had encouraged to presume. No less was he pleased to revile at dissenters; "Show me," he said, "a Presbyterian, and I will engage to show a lying knave." He is remarkable as the only politically prominent lawyer of his century who never sat in the House of Commons, nor left a single publication behind him. In the House of Lords he once attempted to use the insolent abuse of his court habits, but was compelled humbly to apologize, in tears of maudlin chagrin, to all whom he had attacked.

The chief sources for particulars about Jeffreys are the *State Trials* and North's *Life of Lord Keeper Guildford*, together with contemporary pamphlets and squibs. These materials have been skilfully used by Lord Campbell in his *Lives of the Lord Chancellors*, and by Macaulay in his *History*. See also Woolrych's *Memoirs of Judge Jeffreys*, 1827.

JEHOL, or CHENG-TE-FU, a city of Mongolia, famous as the seat of the summer palace of the emperor of China, is situated near 118° E. long. and 41° N. lat., about 140 miles north-east of Peking, with which it is connected by an excellent line of road. Though not enclosed by walls, the town, which is about 2 miles long, bears the stamp of "a flourishing Chinese town of the same rank." The population is stated at 10,000. The palace, called *Pi-shu-shu-chuang*, or "mountain lodge for avoiding heat," was built in 1703 on the plan of the palace of Yuan-ming-yuan near Peking. A substantial brick wall 6 miles in circuit encloses several well-wooded heights and extensive gardens, rockeries, pavilions, temples, &c., after the usual Chinese style. In the vicinity of Jehol are numerous Lama monasteries and temples, the most remarkable being Putala-su, built on the model of the palace of the grand lama of Tibet at Putala. It is thus described by Mr Bushell (*Journ. R. Geog. Soc.*, Lond., 1874): "The principal building of this temple is a huge square erection with eleven rows of windows, the stories coloured alternately red, green, and yellow, surmounted by a row of five dagobas, and with the roof covered with enamelled tiles of a bright turquoise blue. The general effect is inexpressibly bizarre."

JEHOVAH is the current European transcription of the sacred tetragrammaton יהוה. This was punctuated by the Massorets with the vowels *ē* (for *ā*), *ō*, *ā* of the word Adonai which the later Jews habitually substituted in reading the ineffable name. It is now generally agreed that Jahwé (Yahwé) is the true pronunciation, a conclusion which is supported not only by the linguistic argument derived from the fact that the various contracted forms in which the name appears, either separately (Jah) or in compound proper names (Jô, Jêho, Jâhu) are all reducible to Jahw, but also by the testimony of ancient tradition (thus Theodoret ascribes the pronunciation 'Iaβé to the Samaritans, Epiphanius gives 'Iaβé or 'Iaué, and Clement apparently 'Iaové). Etymologically, Jahwé may be regarded as the imperfect either of Qal or Hiphil of יהוה; the former view seems to be that taken in the Pentateuch, but many critics now incline to the

other, according to which the name may be translated as meaning "He who causes to be." It seems to have come to be invested with new and richer meanings as the religion of Israel developed in spirituality and depth; but as the name of the national deity it must have been older than the time of Moses; at least the name of the mother of Moses is compounded with it. It is conceivable that in the earliest period of its history the word was not associated with any idea so high even as that of "creator"; the Hiphil of יהוה in the Aramaic sense of "fall" would give "he who causes (rain or lightning) to fall" as the nearest approach to the original meaning. For the later sense of the name Exod. iii. 14 is the *locus classicus*. The Palestinian tradition finds in this verse the assertion of God's eternity (comp. Rev. i. 8); and the Alexandrian exegesis refers it to his absolute existence. More probably the vague "I will be what I will be" (the emphasis lying on the first verb as in Exod. xxxiii. 19) is used to convey the idea of that all-sufficiency of God's grace which is wider than the widest faith (comp. Hos. i. 6, 7).

The literature of the subject is immense. Of older books it is enough to refer to the *Docus Exercitationum* collected by Reland (Utrecht, 1707); for the latest aspects of the questions involved, see Gesenius, *Thes.*, s.v.; Ewald, *Gesch.*, ii. 121 sq.; Lagarde, *Psalm. Hieron.* (1874), p. 153 sq., and *Orientalia*, ii. 27 sq.; Schrader in Schenkel's *Bib. Lex.*, s.v. "Jahve"; W. Aldis Wright in *Journ. of Philol.*, iv. p. 70. Against recent proposals to identify Jahwé with non-Israelite deities, see Baudissin, *Studien*, i. (Leipzig, 1876); and in favour of derivation from an Assyrian form of the Divine name *ia-u* (Accadian *ē*), see Delitzsch, *Wo lag das Paradies*, p. 158 sq., Leipzig, 1881. A summary of recent discussion is given by W. Robertson Smith in *Brit. and For. Evang. Rev.*, January 1876.

JEJEEBHOY, SIR JAMSETJEE (1783-1859), a Parsee merchant and great public benefactor, was born of poor parents in Bombay, July 15, 1783. Left an orphan while still very young, he had many difficulties to overcome at the outset of the mercantile career he chose for himself. On one occasion the ship in which he and all his goods were captured by the French, and the young merchant was landed penniless at the Cape of Good Hope. Thence he procured a passage to Bombay through the charity of some Dutch ladies; and, resolutely beginning life afresh, he rose to be one of the most opulent Parsee merchants in India. His lavish benevolence, which recognized no difference of nation, sect, or class, and extended even to the brute creation, has won him enduring honour. In 1822 he paid the debts of all the poor debtors in Bombay jail; he enriched his native city with a hospital and an educational establishment for Parsee children, a school of art and other benevolent institutions, and contributed largely to the Grant Medical College, while to the public works at Bombay, Nowsaree, and elsewhere he gave large grants, as well as to the patriotic fund and the Indian sufferers' fund after the mutiny. Eleven schools owe their foundation to his munificence, in which 2710 Parsee children are educated. It is estimated that he gave away upwards of 26 lakhs of rupees. Knighted in 1842, he was promoted to a baronetcy in 1857; a statue was voted to him in 1856, and was unveiled in Bombay town-hall on August 1, 1859. At his death on April 15, 1859, his property was estimated at 8,550,000 rupees. According to an act of the legislative council of India, the name Jamsetjee Jejeebhoy must be assumed by all his successors in the baronetcy. His son (1811-1877) was prominent as the head of the Parsee community in Bombay, and exercised a considerable influence among the Europeans. He was a member of the legislative council of Bombay.

JELÂL-ED DÎN, MOHAMMED ER-RÛMÎ (born at Balkh c. 1200 A.D., died at Iconium, 1273, as head of a college for mystic theology), one of the greatest poets and thinkers of Persia. See PERSIA.



**JEMMAPES**, or **JEMAPPES**, a village in the arrondissement and 3 miles west of the town of Mons, in the province of Hainault, Belgium, is situated on the Haîne, near the "Bassin du Flenn," one of the richest coal-fields in the province. It has manufactures of mining gear, salt, soap, brass, and leather. The population of the commune in 1876 was 10,816.

Jemmapes is famous as the scene of a sanguinary battle fought November 6, 1792, between the French under Dumouriez and the Austrians under the duke of Saxe-Teschén, in which the latter were defeated. The French gained temporary possession of Belgium, and Jemmapes gave its name to a French department, comprising most of Hainault.

**JENA**, a town in the department of Apolda, in the grand-duchy of Saxe-Weimar-Eisenach, Germany, is situated, about 56 miles south-west of Leipsic by rail, at the junction of the Leutra and Saale, in a beautiful valley, surrounded by romantic hills, and dotted over with villages. The town is tolerably well built, though the houses are quaint, and many of the streets narrow. Besides the university buildings, the more interesting edifices are the 15th century church of St Michael, with a tower 318 feet high, and containing the bronze statue of Luther, originally intended for his tomb; the college-church; the library; the old-fashioned town-house in the market-place; the castle, built in 1620, where Goethe wrote his *Hermann und Dorothea*; the Black Bear tavern (now a hotel), where Luther spent the night after his flight from the Wartburg; and Weigel's house. The *carcer*, or students' prison, ceased to be used for academic discipline in 1880. In 1858, the tercentenary of the inauguration of the university, the various houses in Jena that had been occupied by illustrious men were marked by memorial tablets. Close to the town are the Thuringian district court and the large lunatic asylum—both built in 1879. Of the old fortifications there remain only four towers and an ancient gateway; while the moat has been laid out as a promenade, adorned with busts and statues. On the Hausberg to the east rises the gaunt and legendary Fuchsthurm; and 2 miles to the west, on the Forstberg, is the tower raised to the students of Jena who fell in the war against France, 1870-71. Among the schools are a gymnasium opened in 1876, and a commercial school. Jena is the seat of an upper appeal court, of a statistical bureau for the Thuringian states, and of a chamber of commerce. The town owes what prosperity it now has to the presence of the university founded by the elector, John Frederick of Saxony, whose statue stands in the market-place. In 1547 that prince, while a captive in the hands of Charles V., conceived the plan of erecting a university at Jena, in place of that of Wittenberg, which he had forfeited. The academy, founded accordingly at Jena in 1548 by the elector's three sons, obtained the necessary charter from the emperor Ferdinand I., and on February 2, 1558, was formally inaugurated as a university. The students were most numerous about the middle of the 18th century, when some 3000 attended; but the most brilliant professoriate was under Duke Karl August, Goethe's patron (1787-1806), when in the different faculties Reinhold, Fichte, Schelling, Hegel, Schlegel, Oken, and Schöler read lectures. Founded as a home for the new religious opinions of the 16th century, Jena has always liberally granted a hearing to new teaching; and it distances perhaps every other German university in the extent to which it carries what are popularly regarded as the characteristics of German student-life,—duelling, and the sentimental passion for *Freiheit*. At the end of last and the beginning of the present century, the opening of new universities, co-operating with the suspicions of the various German Governments as to the democratic opinions which obtained at Jena, militated against it, and the university has never regained its former prosperity. In the

session 1880-81 the teaching-staff numbered 80 members; in the winter session 1879-80 the students numbered 481, and in the summer session 1880, 546. Amongst the numerous auxiliaries of the university may be mentioned the library with 180,000 volumes; the seminaries of philology, theology, and education; the institutes for chemistry, pharmacy, zoology, botany (with a botanical garden), and meteorology (with an observatory in the garden of which a bust of Schiller marks the spot where he wrote his *Wallenstein*); the veterinary and agricultural institutions; and the various physical and archaeological collections, which now occupy the castle. A clinical institute and the several hospitals assist the study of medicine. The *Jenaer Literaturzeitung*, whose issue in its present form began in 1874 under the patronage of the university, is the ultimate successor of the first *Literaturzeitung für Deutschland*, which appeared at Jena in 1785. The manufactures of Jena, which are not important, comprise cigars, pianos, cloth, woollens, cement, beer, and sausages. There is some activity in the book-trade and in vine-growing; and the traffic of wood-rafts on the Saale deserves mention. The population in 1875 was 9020.

Jena appears to have possessed town-rights in 1029. At the beginning of the 14th century it was in the possession of the margraves of Meissen, from whom it passed in 1423 to the elector of Saxony. Since 1455 it has remained in the Ernestine line of the house of Saxony. In 1662 it fell to Bernhard, youngest son of the duke of Weimar, and became the capital of a small separate duchy. Bernhard's line having become extinct in 1690, Jena was united with Eisenach, and in 1741 reverted with that duchy to Weimar. In more modern times Jena has been made famous by the defeat inflicted in the vicinity, on October 14, 1806, by Napoleon upon the Prussian army under the duke of Brunswick.

See Schweiber and Förber, *Jena von seinem Ursprung bis zur neuesten Zeit*, 2d ed., 1858; Orloff, *Jena und Umgegend*, 3d ed., 1875.

**JENGHIZ KHAN** (1162-1227) Mongol emperor, was born in a tent on the banks of the river Onon, in 1162. His father Yesukai was absent at the time of his birth, being engaged in a campaign against a Tatar chieftain named Temuchin. In this conflict the fortune of war favoured the side of Yesukai, who having slain his enemy returned to his encampment in triumph. Here he was met by the news that his wife Yulun had given birth to a son. On examining the child he observed in its clenched fist a clot of coagulated blood like a red stone. In the eyes of the superstitious Mongol this circumstance took the shape of a mysterious reference to his victory over the Tatar chieftain, and he therefore named the infant Temuchin. The death of Yesukai, which placed Temuchin, who was then only thirteen years old, on the Mongol throne, was the signal also for the dispersal of several tribes whose allegiance the old chieftain had retained by the exercise of an iron rule. When remonstrated with by Temuchin on their desertion of his banner, the rebels replied: "The deepest wells are sometimes dry, and the hardest stone is sometimes broken; why should we cling to thee?" But Yulun was by no means willing thus to see her son's power melt away, and seizing the national standard she led those retainers who remained faithful against the deserters, and succeeded in bringing back fully one half to their allegiance. With this doubtful material for the maintenance of his chieftainship, Temuchin succeeded in holding his ground against the insidious plots and open hostilities of the neighbouring tribes, more especially of the Naimans, Keraits, and Merkits. With one or other of these he maintained an almost unceasing warfare until the year 1206, when his power was so firmly established that he felt the time had arrived when he might proclaim himself the ruler of an empire. He therefore summoned the notables of his kingdom to an assembly on the banks of the Onon, and at their unanimous request adopted the name and title of Jenghiz Khan (Chinese

Ching-sze, or "perfect warrior"). At this time there remained to him but one open enemy on the Mongolian steppes, namely, Polo the Naiman khan. Against this chief he now led his troops, and in one battle so completely shattered his forces that Kushlek, the successor of Polo, who was left dead upon the field, fled with his ally Toto, the Merkit khan, to the river Irtysh. Having thus further consolidated his sovereignty, Jenghiz Khan now meditated an invasion of the empire of the Kin Tatars, who had wrested northern China from the emperors of the Sung dynasty. As a first step in this programme he invaded western Hea, and, having captured several strongholds, retired in the summer of 1208 to Lung-ting to escape the great heat of the plains. While there news reached him that Toto and Kushlek, the Merkit and Naiman khans, were preparing for war. He thereupon at once marched against them, and in a pitched battle on the river Irtysh overthrew them completely. Toto was amongst the slain, and Kushlek fled for refuge to the Khitan Tatars. Satisfied with his victory, Jenghiz again directed his forces against Hea. There also good fortune attended him, and, after having defeated the Kin army under the leadership of a son of the sovereign, he captured the Wu-leang-hai Pass in the Great Wall, and penetrated as far as Ning-hea Fu in Kansuh. With unceasing vigour he pushed on his troops into the country, and even established his sway over the province of Leaou-tung. The saying that nothing succeeds like success was eminently true in his case. Several of the Kin commanders, seeing how persistently victory attended his banners, deserted to him, and garrisons surrendered at his bidding. Having thus secured a firm footing within the Great Wall, he despatched three armies in the autumn of 1213 to overrun the empire. The right wing, under the command of his three sons Juji, Jagatai, and Oghotai, marched towards the south; the left wing under his brothers Hochar, Kwang-tsin Nuyen, and Chow-tse-tejo-shi, advanced eastward towards the sea; while Jenghiz and his son Tulci with the centre directed their course in a south-easterly direction. Complete success attended all three expeditions. The right wing advanced as far as Honan, and after having captured upwards of twenty-eight cities rejoined headquarters by the great western road. Hochar made himself master of the country as far as Leaou-se; and Jenghiz ceased his triumphal career only when he reached the cliffs of the Shan-tung promontory. But either because he was weary of the strife, or because it was necessary to gain a respite that he might revisit his Mongolian empire, he sent an envoy to the Kin emperor in the spring of the following year (1214), saying, "All your possessions in Shan-tung and the whole country north of the Yellow river are now mine with the solitary exception of Yenking (the modern Peking). By the decree of heaven you are now as weak as I am strong, but I am willing to retire from my conquests; as a condition of my doing so, however, it will be necessary that you distribute largess to my officers and men to appease their fierce hostility." These terms of safety the Kin emperor eagerly accepted, and as a peace offering he presented Jenghiz with a daughter of the late emperor, another princess of the imperial house, 500 youths and maidens, and 3000 horses. No sooner, however, had Jenghiz passed beyond the Great Wall than the Kin emperor, fearing to remain any longer so near the Mongol frontier, moved his court to Kai-fung Fu in Honan. This transfer of capital appearing to Jenghiz to indicate a hostile attitude, he again turned southward and once more marched his troops into the doomed empire.

While Jenghiz was thus adding city to city and province to province in China, Kushlek, the fugitive Naiman chief, was not idle. With characteristic treachery he requested

permission from his host, the Khitan khan, to collect the fragments of his army which had been scattered by Jenghiz at the battle on the Irtysh, and thus having collected a considerable force he leagued himself with Muhammed, the shah of Khwarezm, against the confiding khan. After a short but decisive campaign the allies remained masters of the position, and the khan was compelled to abdicate the throne in favour of his late guest.

With the power and prestige thus acquired, Kushlek prepared once again to measure swords with the Mongol chief. On receiving the news of his hostile preparations, Jenghiz at once took the field, and in the first battle routed the Naiman troops and made Kushlek a prisoner. A short shift was given to the treacherous Naiman, and his ill-gotten kingdom became an appanage of the Mongol empire. Jenghiz now held sway up to the Khwarezm frontier. Beyond this he had no immediate desire to go, and he therefore sent envoys to Muhammed, the shah, with presents, saying, "I send thee greeting; I know thy power and the vast extent of thine empire; I regard thee as my most cherished son. On my part thou must know that I have conquered China and all the Turkish nations north of it; thou knowest that my country is a magazine of warriors, a mine of silver, and that I have no need of other lands. I take it that we have an equal interest in encouraging trade between our subjects." This peaceful message was well received by the shah, and in all probability the Mongol armies would never have appeared in Europe but for an unfortunate occurrence which turned Jenghiz's friendly overtures into a declaration of war. Shortly after the despatch of this first mission Jenghiz sent a party of traders into Transoxiana who were seized and put to death as spies by Inaljuk, the governor of Otrar. As satisfaction for this outrage Jenghiz demanded the extradition of the offending governor. Far from yielding to this summons, however, Muhammed beheaded the chief of the Mongol envoys, and sent the others back without their beards. This insult made war inevitable, and in the spring of 1219 Jenghiz set out from Karakoram on a campaign which was destined to be as startling in its immediate results as its ulterior effects were far reaching. The invading force was in the first instance divided into two armies: one commanded by Jenghiz's second son Jagatai was directed to march against the Kankalis, the northern defenders of the Khwarezm empire; and the other, led by Juji, his eldest son, advanced by way of Signak against Jend. Against this latter force Muhammed led an army of 400,000 men, who after a bloody battle with the invaders were completely routed, leaving it is said 160,000 dead upon the field. With the remnant of his host Muhammed fled to Samarkand. Meanwhile Jagatai marched down upon the Jaxartes by the pass of Taras and invested Otrar, the offending city. After a siege of five months the citadel was taken by assault, and Inaljuk and his followers were put to the sword. To mark their sense of the crime of which it had been the scene, the conquerors levelled the walls with the ground, after having given the city over to pillage. At the same time a third army besieged and took Khogend on the Jaxartes; and yet a fourth, led by Jenghiz and his youngest son Tulci, advanced in the direction of Bokhara. Tashkend and Nur surrendered on their approach, and after a short siege Bokhara fell into their hands. On entering the town Jenghiz ascended the steps of the principal mosque, and shouted to his followers, "The hay is cut; give your horses fodder." No second invitation to plunder was needed; the city was sacked, and the inhabitants either escaped beyond the walls or were compelled to submit to infamies which were worse than death. As a final act of vengeance the town was fired, and before the last of the Mongols left the district, the great mosque and



certain palaces were the only buildings left to mark the spot where the "centre of science" once stood. From the ruins of Bokhara Jenghiz advanced along the valley of the Sogd to Samarkand, which, weakened by treachery, surrendered to him, as did also Balkh. But in neither case did submission save either the inhabitants from slaughter or the city from pillage. Beyond this point Jenghiz went no further westward, but sent Tulé, at the head of 70,000 men, to ravage Khorassan, and two flying columns under Chépé and Sabutai Bahadar to pursue after 'Muhammed, who had taken refuge in Nishapoor. Defeated and almost alone, Muhammed fled before his pursuers to the village of Astara on the shore of the Caspian Sea, where he died of an attack of pleurisy, leaving the cause of his empire to his son Jaláluddin. Meanwhile Tulé carried his arms into the fertile province of Khorassan, and after having captured Nessa by assault appeared before Merv. By an act of atrocious treachery the Mongols gained possession of the city, and, after their manner, sacked and burnt the town. From Merv Tulé marched upon Nishapoor, where he met with a most determined resistance. For four days the garrison fought desperately on the walls and in the streets, but at length they were overpowered, and, with the exception of 400 artisans who were sent into Mongolia, every man, woman, and child was slain. Herat escaped the fate which had overtaken Merv and Nishapoor by opening its gates to the Mongols. At this point of his victorious career Tulé received an order to join Jenghiz before Talikhan in Badakshan, where that chieftain was preparing to renew his pursuit of Jaláluddin, after a check he sustained in an engagement fought before Ghazni. As soon as sufficient reinforcements arrived Jenghiz advanced against Jaláluddin, who had taken up a position on the banks of the Indus. Here a desperate battle was fought. The Turks, though far outnumbered, defended their ground with undaunted courage, until, beaten at all points, they fled in confusion. Jaláluddin, seeing that all was lost, mounted a fresh horse and jumped into the river, which flowed 20 feet below. With admiring gaze Jenghiz watched the desperate venture of his enemy, and even saw without regret the dripping horseman mount the opposite bank. From the Indus Jenghiz sent in pursuit of Jaláluddin, who fled to Delhi, but failing to capture the fugitive the Mongols returned to Ghazni after having ravaged the provinces of Lahore, Peshawur, and Melikpoor. At this moment news reached Jenghiz that the inhabitants of Herat had deposed the governor whom Tulé had appointed over the city, and had placed one of their own choice in his room. To punish this act of rebellion Jenghiz sent an army of 80,000 men against the offending city, which after a siege of six months was taken by assault. For a whole week the Mongols ceased not to kill, burn, and destroy, and 1,600,000 persons are said to have been massacred within the walls. Having consummated this act of vengeance, Jenghiz returned to Mongolia by way of Balkh, Bokhara, and Samarkand.

Meanwhile Chépé and Sabutai marched through Azerbaijan, and in the spring of 1222 advanced into Georgia. Here they defeated a combined force of Lesghs, Circassians, and Kipchaks, and after taking Astrakhan followed the retreating Kipchaks to the Don. The news of the approach of the mysterious enemy of whose name even they were ignorant, was received by the Russian princes at Kief with dismay. At the instigation, however, of Mitislaf, prince of Galicia, they assembled an opposing force on the Dnieper. Here they received envoys from the Mongol camp, whom they barbarously put to death. "You have killed our envoys," was the answer made by the Mongols; "well, as you wish for war you shall have it. We have done you no harm. God is impartial; He will decide our quarrel." If

the arbitration was to be thus decided, the Russians must have been grievously in the wrong. In the first battle, on the river Kaleza, they were utterly routed, and fled before the invaders, who after ravaging Great Bulgaria retired, gorged with booty, through the country of Saksin, along the river Aktuba, on their way to Mongolia.

In China the same success had attended the Mongol arms as in western Asia. The whole of the country north of the Yellow river, with the exception of one or two cities, was added to the Mongol rule, and, on the death of the Kiu emperor Seuen Tsung in 1223, the Kiu empire virtually ceased to be, and Jenghiz's frontiers thus became continuous with those of the Sung emperors who held sway over the whole of central and southern China. After his return from central Asia, Jenghiz once more took the field in western China. While on this campaign the five planets appeared in a certain conjunction which to the superstitiously minded Mongol chief foretold that evil was awaiting him. With this presentiment strongly impressed upon him he turned his face homewards, and had advanced no farther than the Se-Keang river in Kansuh when he was seized with an illness of which he died a short time afterwards (1227) at his travelling palace at Ha-laou-tu, on the banks of the river Sale in Mongolia. By the terms of his will Oghotai was appointed his successor, but so essential was it considered to be that his death should remain a secret until Oghotai was proclaimed that, as the funeral procession moved northwards to the great ordu on the banks of the Kerulon, the escort killed every one they met. The body was then carried successively to the ordus of his several wives, and was finally laid to rest in the valley of Keleen.

Thus ended the career of one of the greatest conquerors the world has ever seen. Born and nurtured as the chief of a petty Mongolian tribe, he lived to see his armies victorious from the China Sea to the banks of the Dnieper; and, though the empire which he created ultimately dwindled away under the hands of his degenerate descendants, leaving not a wrack behind, we have in the presence of the Turks in Europe a consequence of his rule, since it was the advance of his armies which drove their Osmanli ancestors from their original home in northern Asia, and thus led to their invasion of Bithyolia under Othman, and finally their advance into Europe under Amurath I.

See H. H. Howorth, *The History of the Mongols*; Robert K. Douglas, *The Life of Jenghiz Khan*. (R. K. D.)

JENNER, EDWARD (1749-1823), the discoverer of vaccination, was born at Berkeley, Gloucestershire, on May 17, 1749. His father, the Rev. Stephen Jenner, rector of Rockhampton and vicar of Berkeley, came of a family that had been long established in that county, and was possessed of considerable landed property; he died when the subject of this notice was only six years old, but his place was admirably taken by his eldest son, the Rev. Stephen Jenner, who brought his brother up with paternal care and tenderness. Edward received his early education in local schools at Wotton-under-Edge and Cirencester, where he already showed a strong taste for natural history. The medical profession having been selected for him, he began his studies under Mr Ludlow, a surgeon of Sodbury near Bristol; but in his twenty-first year he proceeded to London, where he became a favourite pupil of the celebrated John Hunter, in whose house he resided for two years. During this period he was employed by Sir Joseph Banks to arrange and prepare the valuable zoological specimens which he had brought back from Captain Cook's first voyage in 1771. He must have acquitted himself satisfactorily in this task, since he was offered the post of naturalist in the second expedition, but declined it as well as other advantageous offers, preferring rather to practise

his profession in his native place, and near his eldest brother, to whom he was much attached. His speedy success in practice did not engross his intellectual activity. He was the principal founder of a local medical society, to which he contributed several papers of marked ability, in one of which he apparently anticipated later discoveries concerning the rheumatic inflammations of the heart. He maintained a correspondence with John Hunter, under whose direction he investigated various points in biology, particularly the hibernation of hedgehogs and the habits of the cuckoo; his paper on the latter subject was laid by Hunter before the Royal Society, and appeared in the *Philosophical Transactions* for 1788. He also devoted considerable attention to the varied geological character of the district in which he lived, collecting fossils from the Oolite and Lias, and constructed the first balloon seen in those parts. He was a great favourite in general society, from his agreeable and instructive conversation, and the many accomplishments he possessed. Thus he was a fair musician, both as a part-singer and as a performer on the violin and flute, and a very successful writer, after the fashion of that time, of fugitive pieces of verse, one of which—"The Signs of Rain"—has been frequently reprinted, and enumerates minutely all the signs of the weather in verse not unworthy of Crabbe. In 1788 he married Catherine Kingscote, a union destined to form a most important element in his happiness. In 1792 he resolved to confine himself to practising as a physician, and accordingly obtained the degree of doctor of medicine from St Andrews. Finding that Berkeley could not support a physician, he began, a few years later, to visit Cheltenham annually.

Meanwhile the discovery that was to immortalize his memory had been slowly maturing in his mind. When only an apprentice at Sodbury, his attention had been directed to the relations between cow-pox and small-pox in connexion with a popular belief which he found current in Gloucestershire, as to the antagonism between these two diseases. During his stay in London he appears to have mentioned the thing repeatedly to Hunter, who, being engrossed by other important pursuits, was not so strongly persuaded as Jenner was of its possible importance, yet spoke of it to his friends and in his lectures. After he began practice in Berkeley, Jenner was always accustomed to inquire what his professional brethren thought of it; but he found that, when medical men had noticed the popular report at all, they supposed it to be based on an imperfect induction of facts. His first careful investigation of the subject dates from about 1775, and five years elapsed before he had succeeded in clearing away the most perplexing difficulties by which it was surrounded. He first satisfied himself that two different forms of disease had been hitherto confounded under the term "cow-pox," only one of which protected against small-pox, and that many of the cases of failure were to be thus accounted for; and his next step was to ascertain that the true cow-pox itself only protects when communicated at a particular stage of the disease. At the same time he came to the conclusion that "the grease" of horses is the same disease as cow-pox and small-pox, each being modified by the organism in which it was developed—an opinion which is generally held at the present day. For many years, cow-pox being scarce in his county, he had no opportunity of inoculating the disease, and so putting his discovery to the test, but he did all he could in the way of collecting information and communicating what he had ascertained. Thus in 1788 he carried a drawing of the cow-pox, as seen on the hands of a milkmaid, to London, and showed it to Sir E. Home and others, who agreed that it was "an interesting and curious subject," but by no means realized its practical importance. At length, on the 14th of May 1796, he was able

to inoculate James Phipps, a boy about eight years old, with cow-pox matter. On the first of the following July the boy was carefully inoculated with variolous matter, but (as Jenner had predicted) no small-pox followed. The discovery was now complete, but he desired to act without precipitation, and was unable to repeat his experiment until 1798, owing to the disappearance of cow-pox from the dairies. He then repeated his inoculations with the utmost care, and prepared a pamphlet which should announce his discovery to the world. Before publishing it, however, he thought it well to visit London, so as to demonstrate the truth of his assertions to his friends; but he remained in London nearly three months, without being able to find any person who would submit to be vaccinated. Soon after he had returned home, however, Mr Cline, an eminent surgeon, inoculated some vaccine matter over the diseased hip-joint of a child, thinking the counter-irritation might be useful, and found the patient afterwards incapable of acquiring small-pox. In the autumn of the same year, Jenner met with the first opposition to vaccination; and this was the more formidable because it proceeded from Dr Ingenhousz, a celebrated physician and man of science. But meanwhile Mr Cline's case, and his advocacy of vaccination, brought it much more decidedly before the medical profession, of whom the majority were prudent enough to suspend their judgment until they had more ample information. But besides these there were two noisy and troublesome factious, the one of which opposed vaccination as an useless and dangerous practice, while the other endangered its success much more by their rash and self-seeking advocacy. At the head of the latter was one Dr Pearson, who in November 1798 published a pamphlet speculating upon the subject, before even seeing a case of cow-pox, and afterwards endeavoured, by lecturing on the subject, and supplying the virus, to put himself forward as the chief agent in the cause. The matter which he distributed, which had been derived from cows that were found to be infected in London, was found frequently to produce, not the slight disease described by Jenner, but more or less severe eruptions resembling small-pox. Jenner concluded at once that this was due to an accidental contamination of the vaccine with variolous matter, and a visit to London in the spring of 1799 convinced him that this was the case. In the course of this year the practice of vaccination spread over England, being urged principally by non-professional persons of position; and towards its close attempts were made to found institutions for gratuitous vaccination and for supplying lymph to all who might apply for it. Pearson proposed to establish one of these in London, without Jenner's knowledge, in which he offered him the post of honorary corresponding physician! On learning this scheme to supplant him, and to carry on an institution for public vaccination on principles which he knew to be partly erroneous, Jenner once more visited London early in 1800, when he had influence enough to secure the abandonment of the project. He was afterwards presented to the king, the queen, and the prince of Wales, whose encouragement materially aided the spread of vaccination in England. Meanwhile it had made rapid progress in the United States, where it was introduced by Dr Waterhouse, the professor of physic at Cambridge, Massachusetts, and on the continent of Europe, where it was at first diffused by Dr de Carro of Vienna, who practised it with the greatest zeal and discretion, and thence spread to Geneva. In consequence of the war between England and France, the discovery was later in reaching Paris; but, its importance once realized, it spread rapidly over France, Spain, and Italy. It would be tedious and unprofitable to dwell minutely on the extension of vaccination over the whole world; but a few of the inci-



dents connected with it are too remarkable to be omitted. Perhaps the most striking is the expedition which was sent out by the court of Spain in 1803, for the purpose of diffusing cow-pox through all the Spanish possessions in the Old and New Worlds, and which returned in three years, having circumnavigated the globe, and succeeded beyond its utmost expectations. Many of the expressions of enthusiasm seem to us strained and almost ridiculous. Thus we read with surprise how clergymen in Geneva and Holland urged vaccination upon their parishioners from the pulpit; how in Sicily, South America, and Naples religious processions were formed for the purpose of receiving it; how the anniversary of Jenner's birthday, or of the successful vaccination of James Phipps, was for many years celebrated as a feast in Germany; and how the empress of Russia caused the first child operated upon to receive the name of "Vaccinoff," and to be educated at the public expense. The truth is that we who live in that security from the horrible and universal plague of small-pox for which we are indebted to Jenner's immortal discovery cannot realize the greatness of the blessing he conferred upon mankind. This universal enthusiasm caused vaccination to spread over the whole world in the marvellously short period of six years, it being accepted with equal readiness by nations of the most diverse climes, habits, and religions. About the close of the year 1801 Jenner's friends in his native county of Gloucester presented him with a small service of plate as a testimonial of the esteem in which they held his discovery. This was intended merely as a preliminary to the presenting of a petition to Parliament for a grant. He was advised to apply for this, partly to obtain the formal approval of the highest court in this country for vaccination, but also for personal reasons. The premier, Mr Addington, approved fully of this step, and fixed the 17th of March 1802 for the presentation of his petition. This was referred to a committee, of which Admiral Berkeley, one of his warmest friends, was chairman, which examined carefully into the utility of vaccination, and Jenner's claims to its discovery. The investigations of this committee resulted in a report in favour of the grant, and ultimately in a vote of £10,000.

Towards the end of 1802 steps were taken to form a society for the proper spread of vaccination in London, and the "Royal Jennerian Society" was finally established, Jenner returning to town (having retired to Berkeley for three months) to preside at the first meeting. This institution began very prosperously, more than twelve thousand persons having been inoculated in the first eighteen months, and with such effect that the deaths from small-pox, which for the latter half of the last century had averaged 2018 annually, fell, in 1804, to 622. Unfortunately the chief resident inoculator soon set himself up as an authority opposed to Dr Jenner, and this led to such dissensions as caused the society to die out in 1808.

Jenner was led, by the language of the chancellor of the exchequer when his grant was proposed, to attempt practice in London, but after a year's trial he returned to Berkeley. His grant was not paid until 1804, and then, after the deduction of about £1000 for fees, it did little more than pay the expenses attendant upon his discovery. For he was so thoroughly known everywhere as the discoverer of vaccination, that the correspondence of the whole world on this subject was upon him. As he himself said, he was "the vaccine clerk of the whole world"; and, at the same time, he continued to vaccinate gratuitously all the poor who applied to him on certain days, so that he sometimes had as many as three hundred persons waiting at his door. Meanwhile honours began to shower upon him from abroad: he was elected a member of almost all the chief scientific societies on the Continent, the first being

that of Göttingen, where he was proposed by the illustrious Blumenbach. But perhaps the most flattering proof of his influence was derived from France. He endeavoured on several occasions to obtain the release of some of the unfortunate Englishmen who had been detained in France on the sudden termination of the peace of Amiens, but without success, until, in the case of two persons (Dr Williams, a Radcliffe travelling fellow, and a Mr Williams) he applied to the emperor Napoleon himself. It was on this or some such occasion (for he afterwards repeated his intercession) that Napoleon was about to reject the petition, when Josephine uttered the name of Jenner. The emperor paused and exclaimed—"Ah, we can refuse nothing to that name." Somewhat later he was of the same service to Englishmen confined in Mexico and in Austria; and during the latter part of the great war persons before leaving England would sometimes obtain certificates signed by him which served as passports. In his own country his merits were less recognized. His applications on behalf of French prisoners in England were less successful; he never shared in any of the patronage at the disposal of the Government, and was even unable to obtain a living for his nephew George.

In 1806 Lord Henry Petty (afterwards the marquis of Lansdowne) became chancellor of the exchequer, and was so convinced of the inadequacy of the former parliamentary grant that he proposed an address to the crown, praying that the college of physicians should be directed to report upon the success of vaccination. Their report being strongly in its favour, the then chancellor of the exchequer (Mr Spencer Perceval) proposed that a sum of £10,000 without any charge for fee or reward should be paid to Dr Jenner. The anti-vaccinationists found but one advocate in the House of Commons; and finally the sum was raised to £20,000. Jenner, however, at the same time had the mortification of learning that Government did not intend to take any steps towards checking small-pox inoculation, which so persistently kept up that disease. About the same time a subscription for his benefit was begun in India, where his discovery had been gratefully received, but the full amount of this (£7383) only reached him in 1812.

The Royal Jennerian Society having failed, the National Vaccine Establishment was founded, for the extension of vaccination, in 1808. Jenner spent five months in London for the purpose of organizing it, but was then obliged, by the dangerous illness of one of his sons, to return to Berkeley. He had been appointed director of the institution; but he had no sooner left London than Sir Lucas Pepys, the president of the college of physicians, neglected his recommendations, and formed the board out of the officials of that college and the college of surgeons. Jenner at once resigned his post as director, though he continued to give the benefit of his advice whenever it was needed, and this resignation was a bitter mortification to him. In 1810 his eldest son died, and Jenner's grief at his loss, and his incessant labours, materially affected his health. In the following year he happened to be in London when the town was much excited by the case of one of Lord Grosvenor's children, who took the small-pox severely, after having been vaccinated by Jenner himself ten years before. The boy's recovery was no doubt to be ascribed to his vaccination, but the occurrence revived for a time all the clamour with which the discovery had been from the first greeted.

In 1813 the university of Oxford conferred on Jenner the degree of M.D. It was believed that this would lead to his election into the college of physicians, but that learned body decided that he could not be admitted until he had undergone an examination in classics. This

Jenner at once refused: to brush up his classics would, he said, "be irksome beyond measure. I would not do it for a diadem. That indeed would be a hauble; I would not do it for John Hunter's museum."

He visited London for the last time in 1814, when he was presented to the allied sovereigns, and to most of the principal personages that accompanied them. In the next year his wife died after a long illness, and he felt her loss most acutely. It was the signal for him to retire from public life: he never left Berkeley again, except for a day or two, as long as he lived. He found sufficient occupation for the remainder of his life in collecting further evidence on some points connected with his great discovery, and in his engagements as a physician, a naturalist, and a magistrate. In 1818 a severe epidemic of small-pox prevailed, and fresh doubts were thrown on the efficacy of vaccination, in part, apparently, owing to the bad quality of the vaccine lymph employed. This caused Jenner much annoyance, which was relieved by an able defence of the practice, written by Sir Gilbert Blane. But this led him, in 1821, to send a circular letter to most of the medical men in the kingdom inquiring into the effect of other skin diseases in modifying the progress of cow-pox. A year later he published his last work, *On the Influence of Artificial Eruptions in certain Diseases*; and in 1823 he presented his last paper—"On the Migration of Birds"—to the Royal Society. In these pursuits the evening of his days passed happily away. On the 24th of January 1823 he retired to rest apparently as well as usual, and next morning rose and came down to his library, where he was found insensible on the floor, in a state of apoplexy, and with the right side paralysed. He never rallied, and died the following morning, January 26, 1823.

A public subscription was set on foot, shortly after his death, by the medical men of his county, for the purpose of erecting some memorial in his honour, and with much difficulty a sufficient sum was raised to enable a statue to be placed in Gloucester cathedral. In 1850 another attempt was made to set up a monument to him; this appears to have failed, but at length, in 1858, a statue of him was erected by public subscription in London.

Independently of that great discovery which will for ever render his name immortal, Jenner possessed talents of observation and reflexion that would have made him eminent as a naturalist and a physician. These qualities would have been more widely appreciated had not his tastes for rural scenes and domestic life led him to sacrifice such fame as is to be gained only amid the busy throng of men. This resolution was strengthened by his love for the simple pleasures of society, for which his varied accomplishments so well fitted him; indeed, there can be little doubt that he would never have had the perseverance to carry through his great discovery of vaccination had not his earnest benevolence pressed it on him, as a duty, to confer such a great and permanent benefit on the whole human race.

Jenner's life was written by the intimate friend of his later years, Dr Baron of Gloucester (2 vols. 1827, 1833), and this excellent work is almost the sole source from which the present and other biographies of him have been taken. (J. R. G.)

JENYNS, SOAME (1704-1787), author of the *Free Inquiry into the Nature and Origin of Evil*, was born at London, of a good family, in 1704. He enjoyed the best educational advantages, and studied at St John's College, Cambridge. In 1742 he was chosen M.P. for Cambridgeshire, in which his property lay, and he afterwards sat for the borough of Dunwich and the town of Cambridge. From 1755 to 1780 he was one of the commissioners of the board of trade. He died December 18, 1787.

For the measure of literary repute which he enjoyed during his life Jenyns was indebted as much to his wealth

and social standing as to his accomplishments and talents, though both were considerable. His poetical works, the *Art of Dancing*, 1727, and *Miscellanies*, 1770, contain many passages graceful and lively, though occasionally verging on licence. The first of his prose works was his *Free Inquiry into the Nature and Origin of Evil*, 1756. This essay was severely criticized on its appearance, especially by Dr Johnson in the *Literary Magazine*. Johnson in this critique—the very best paper of the kind he ever wrote—condemned the book strongly as a slight and shallow attempt to solve one of the most difficult of moral problems. Jenyns, a gentle and amiable man in the main, was extremely irritated by his failure. He put forth a second edition of his work with a vindictive prefix, and tried to take vengeance on Johnson after his death by a sarcastic epitaph. In 1776 Jenyns published his *View of the Internal Evidence of the Christian Religion*. Though at one period of his life he had affected a kind of deistic scepticism, he had now returned to the orthodox creed of his youth, and there seems no reason to doubt his sincerity, questioned at the time, in defending Christianity on the ground of its total variance with the principles of human reason. The work was deservedly praised in its day for its literary merits, but is so plainly the production of a dilettante in theology that as a scientific treatise it is valueless. A collected edition of the works of Jenyns appeared in 1790, with a biography by Charles Nelson Cole.

JEPHTHAH (יפתח, *Iephthae*), one of the "judges" of Israel, was an illegitimate son of "Gilead," and, being expelled from his father's house by his lawful brethren, took refuge in the Syrian land of Tob, where he gathered around him a powerful band of homeless men like himself. The Ammonites pressing hard on his countrymen, the "elders of Gilead" called for his help, which he consented to give on condition that in the event of victory the supremacy should be conferred upon him. The success of his arms was complete, and he became in consequence "judge" of Israel until his death six years afterwards. His name is best known in history and literature in connexion with his "vow," which led to the sacrifice of his daughter as a burnt offering on his return from the war. Much reluctance has been, and continues to be, shown by many writers in accepting the plain sense of the Scripture narrative on this point,—reluctance which proceeds to a large extent on unwarranted assumptions as to the stage of ethical development which had been reached in Israel in the period of the judges, or at the time when the narrative took shape. Several modern writers, on the other hand, are disposed to find a mythical element in the history of Jephthah. In this connexion weight has been laid on his name, "the opener," on the fact that Gilead is not a personal name, and particularly on the circumstance that what is related about his daughter appears to be the popular explanation of a ceremony closely allied to well-known rites connected with solar mythology. The story of Jephthah is told in *Judg.* x. 15-xii. 7; a great part of this section of that book, however, is occupied with an allocutio (xi. 14-27) to the children of Ammon which almost certainly belongs to a later hand.

See Wellhausen-Bleek, *Einführung*; Goldziher's *Mythologie der Hebräer*; and Studer and Bertheau's commentaries on *Judges*.

JERBOA, a family of rodent mammals (*Dipodidae*), chiefly characterized by the great length of the hind limbs as compared with those in front, the disproportion being, in most cases, greater even than in the kangaroos. Like the latter, the jerboas, or jumping mice, as they are also called, raise themselves when disturbed on their hind legs, and execute enormous leaps by the aid of a long muscular tail. When undisturbed, however, they make use of all their



limbs in walking, while the front pair are also employed by many species as hands for the conveyance of food to the mouth. The jerboas, of which there are three genera and twenty-two species known, occur chiefly throughout northern and central Africa, south-eastern Europe, and central and southern Asia, while one genus (*Pedetes*) is confined to South Africa and another (*Jaculus*) to North America. Of the third genus (*Dipus*) there are twenty known species, a typical example of which is the Egyptian jerboa (*Dipus aegyptius*). The length of its body is 8 inches, and of its tail, which is long, cylindrical, and covered with short hair, terminated by a tuft, 10 inches. Its front limbs are pentadactylous, and only 1 inch in length, the hind pair three-toed and six times as long. When about to spring, it raises its body by means of the hinder extremities, and supports itself at the same time upon its tail, while the fore feet are so closely pressed to the breast as to be scarcely visible. Hence probably the name *Dipus*, or two-footed. It then leaps into the air and alights upon its four feet, but instantaneously erecting itself, it makes another spring, and so on in such rapid succession as to appear as if rather flying than running. It is a gregarious animal, living in considerable colonies in burrows, which it excavates with its nails and teeth in the sandy soil of Egypt and Arabia. In these it remains during great part of the day, emerging at night in search of the herbs on which it feeds. It is exceedingly shy, and this, together with its extraordinary agility, renders it difficult to capture. The Arabs, however, succeed, it is said, in this by closing up all the exits from the burrows with a single exception, by which therefore they are forced to come, and over which a net is placed for their capture. When confined, they will gnaw through the hardest wood in order to make their escape. The Indian jerboa (*Dipus indicus*) is also a nocturnal burrowing animal, feeding chiefly on grain, which it stores up in underground repositories, closing these when full, and only drawing upon them when the supply of food above ground is exhausted. The natives in some parts of India are in the habit of searching for and robbing these granaries. The South African form, known as the spring haas or jumping hare of the colonists (*Pedetes capensis*), is the largest member of the family, measuring about a foot in length, exclusive of the tail, which is somewhat longer, and is bushy throughout. Its molar teeth are rootless, while its toes, which are three in number on each hind foot, are armed with long hoof-like nails. It is a powerful animal, nearly as large as a hare, and progresses when pursued by a series of leaps, each usually from 20 to 30 feet in length. Those jumping hares are found abundantly in the rocky plateaus of South Africa, where colonies of them form extensive burrowings somewhat similar to the rabbit warrens of Britain. Like other jerboas it is chiefly nocturnal, and occasionally it does considerable injury to the grain crops on which it feeds. Of the American genus (*Jaculus*) there is only a single species—the Labrador jumping mouse (*Jaculus hudsonius*). It occurs over a wide area of North America, extending from Missouri northward to Labrador, and from the Atlantic westward to the Pacific coast. It resembles the spring haas, and differs from all other jerboas in having the metatarsal bones separated, and also in having its feet five-toed. It is a small creature, measuring about 5 inches in length, exclusive of the much longer and very rat-like tail, and lives chiefly in the neighbourhood of woods and shrubby places, where it conceals itself by day but roams in companies at night. Its agility is extraordinary; one kept in confinement by General Davies took, he says, “progressive leaps of from 3 to 4 and sometimes of 5 yards”; while Audubon considered it as probably the most agile of all wild animals. On the approach of winter the American

jumping mouse retires into its burrow, and there encloses itself within a hollow ball of mud, in which it passes the cold season in a state of complete torpidity. The North American Indians neither eat its flesh nor make any use of its skin.

JERDAN, WILLIAM (1782–1869), journalist, was born April 16, 1782, at Kelso, Scotland. After leaving the parochial school of his native town, his erratic youth between the years 1799 and 1806 was spent in the successive spheres of a country lawyer's office, a London West India merchant's counting-house, an Edinburgh solicitor's chambers, and the position of surgeon's mate on board H.M. guardship “Gladiator” in Portsmouth harbour, under his uncle, who was surgeon. In 1806 the insertion of some verses of his in a Portsmouth paper determined Jerdan's choice of literature as a profession; and, proceeding to London, he found employment as a newspaper reporter. By 1812 he had become editor of *The Sun*, a semi-official Tory paper; but a quarrel with the chief proprietor brought that engagement to a close in 1817. He passed next to the editor's chair of *The Literary Gazette*, which he conducted with success for thirty-four years. Jerdan's position as editor introduced him into high social and literary circles; and it is not easy to account for the deference he met with, unless one is content to accept him at his own somewhat self-satisfied estimate, as contained in his *Autobiography* (4 vols., 1852–3), for which, however, there is no other warrant. An account of his acquaintance, among whom Canning was a special intimate, is to be found in his *Men I have Known* (1866). When Jerdan retired in 1850 from the editorship of the *Literary Gazette*, his pecuniary affairs, either through misfortune or imprudence, were far from satisfactory. A testimonial of over £900 was subscribed by his friends; and in 1852 a Government pension of 100 guineas was conferred on him by Lord Aberdeen. Among other works, including translations from the French, Jerdan contributed to *Fisher's National Portrait Gallery of Illustrious and Eminent Personages of the 19th Century*. He died July 11, 1869.

JEREMIAH. 1. *Life*.—The narrative portions of the Book of Jeremiah are singularly full and precise, and even apart from these the subjective, lyric tone of the prophet's mind enables us to form a more distinct idea of his character than we have of any other prophetic writer. He was the son of a priest named Hilkiah, and it has been held by many both in ancient and in modern times that this Hilkiah was the celebrated high priest of that name, who “found the book of the law (Torah) in the house of Jehovah” (2 Kings xxii. 8). This conjecture, indeed, is not a very probable one, for Hilkiah the high priest was of the house of Eleazar (1 Chron. ii. 13), and Anathoth, where Jeremiah's family lived, was occupied by priests of the line of Ithamar (1 Kings ii. 26). It is certain, however, that the prophet was treated by priests and officials with a consideration which seems to argue that he had high connexions. Jeremiah was still young when he was called to the prophetic career (i. 6); the year is stated by himself (i. 2, xxv. 3) to have been the 13th of Josiah (629 or 627 B.C.). This was before the memorable “discovery” of the Torah, but the year immediately following that in which Josiah “began to purge Judah and Jerusalem from the high places and the images of Asherah” (2 Chron. xxxiv. 3). As yet, it appeared as if Judah was enjoying the peace promised to faithful worshippers of Jehovah; but the punishment of the sins of Manasseh was not to be long delayed. The battle of Megiddo (609 B.C.), which cost Josiah his life, and that of Carchemish (605 B.C.), which determined the Babylonian predominance to the west of the Euphrates, were the heralds of a fatal turn in the fortunes of the kingdom of Judah. Jeremiah (the

Plurion of Judæa) saw this, and at once foretold the vast extension of Nebuchadnezzar's power. For the most part, his ministry was exercised in the capital, though from xi. 21 it may perhaps be inferred that he prophesied for some little time in his native place. It was during the reign of Jehoiakim that he went through that baptism of complicated suffering which has made him in a very high and true sense a type of One greater than he. King and people, priests and (official) prophets, were all against him, or at least the number of his supporters was too small to counterbalance the opposition. Only on one occasion, when accused of a capital crime as having "prophesied against this city," the "princes," supported by "certain of the elders" and "the people," were successful in quashing the accusation, and setting the prophet free. At a later time Jeremiah incurred a still greater danger, though he was providentially saved from the hands of his persecutors. In the fourth year of Jehoiakim (which, it is important to remember, was the first of Nebuchadnezzar) Jeremiah was commanded to write down "all the words that I have spoken unto thee against Israel, and against Judah, and against all the nations . . . from the days of Josiah even unto this day" (xxxvi. 2). The interpretation of this passage, clear as it seems at first sight, is by no means easy. "First of all, an historically accurate reproduction of the prophecies would not have suited Jeremiah's object, which was not historical but practical; he desired to give a salutary shock to the people, by bringing before them the fatal consequences of their evil deeds. And next, it appears from ver. 29 that the purport of the roll which the king burned was that the king of Babylon should 'come and destroy this land,' whereas it is clear that Jeremiah had uttered many other important declarations in the course of his already long ministry." The most probable view is that of Grätz, viz., that the roll simply contained chap. xxv., which is in fact (omitting the interpolations in vers. 12, 26) entirely concerned with the invasion of Nebuchadnezzar and its consequences, and which expressly claims to have been written in the fourth year of Jehoiakim. "Is not *this* the prophecy which Jeremiah dictated to Baruch, and is not ver. 2 a loose, inaccurate statement due to a later editor? That the prophetic as well as the historical books have passed through various phases (without detriment to their religious value) is becoming more and more evident. The 7th and 8th chapters of Isaiah, and the 37th and 38th of the same book, have demonstrably been brought into their present shape by an editor; is it not highly reasonable to conjecture that these narrative chapters of Jeremiah have, to a greater or less extent, passed through a similar process?" The "princes," on this as on the former occasion (chap. xxvi.), were disposed to be friendly to Jeremiah and his secretary; but for some reason they felt themselves bound (as they did not feel themselves bound before) to refer the matter to the king. Jehoiakim was enraged at the contents of the prophetic roll, cut it in pieces, and threw them into the fire. This time Jeremiah escaped; but under the weak-minded Zedekiah he was more than once imprisoned (chaps. xxxii., xxxiii., xxxvii., xxxviii.). It is remarkable that, in the tension of feeling, the "princes," who were formerly friendly to Jeremiah, now took up an attitude of decided hostility to him. At last they had him consigned to a miry dungeon, and it was the king who interfered for his relief, though he remained a prisoner till the fall of Jerusalem. Nebuchadnezzar, who had doubtless heard of Jeremiah's constant recommendations of submission, gave him the choice either of going to Babylon or of remaining in the country (chaps. xxxviii., xxxix.). He chose the latter, and resided with Gedaliah, the native governor, at Mizpah. On the murder of Gedaliah he was carried to Egypt against his will (chaps.

xl.-xliii.), where he predicted the approaching conquest and desolation of the Nile valley. A legendary tradition states that he suffered death by stoning.

2. *Character and Literary Style.*—It is interesting to compare Jeremiah with Isaiah. The earlier prophet had advantages which were denied to the latter; he lived at a period of comparative national prosperity, and his moral and intellectual gifts were of a stronger and more striking order. But Jeremiah has this noteworthy point in his favour that he overcame the natural shrinking of a somewhat feminine character, and showed himself able, in a strength not his own, to resist impediments which even Isaiah would have found terribly great. "When," as Ewald says, "the truth and the spirit of Jehovah call him or the resisting world provokes him to the contest," he then knows nothing of diffidence and fear, nothing of tenderness and pliability, he contends before the eyes of all with the most decisive energy against every false prophet who misleads the people (xxviii. 6 sq., xxix. 15 sq., 24 sq.); if the truth has not been proclaimed with due faithfulness to the king, he goes still, as Isaiah did in his day, without hesitancy, to the royal palace (xxii. 1-19, xxxiv. 2-7); and, although himself of a priestly family, he speaks from the very first with special emphasis against the growing degeneracy of the priests (i. 18, ii. 26, iv. 9), and is never weary of speaking against every kind of arbitrariness wherever and in whatever form it is found (xxxiv. 8-22, xxxvii. 14 sq.)." Another point of contrast is well worth noticing. Only five years after Jeremiah's first appearance as a prophet that great reform took place which was associated with the "discovery" of the Deuteronomic Torah. It is a highly probable conjecture (comp. chap. xi.) that Jeremiah was at the outset an ardent preacher of the contents of this great book; at any rate, his memory became surcharged with the ideas and even the phrases of Deuteronomy. The consequences of the reforming endeavours of what may be called the Deuteronomic party were both good and evil. The centralization of religion, and the emphasis laid on the moral duties, were steps of the highest importance. "But inasmuch as a sacred book was as such for the first time looked upon with greater reverence as a state authority, there arose thus early a kind of book-science with its pedantic pride and erroneous learned endeavours to interpret and apply the Scriptures; whilst at the same time there arose also a new kind of hypocrisy and idolatry of the letter, through the new protection which the state gave to the religion of the book acknowledged by the law. Thus scholastic wisdom came into conflict with genuine prophecy" (Ewald, *The Prophets*, iii. 63, 64). But something more than this was the result. "Hear ye the words of this covenant," was the address with which Jeremiah began his Deuteronomic preaching; but, as time went on, a deeper view of the covenant forced itself upon his mature mind, and the expression which it has found in xxxi. 31-34 is one of the passages which best deserve to be called "the gospel before Christ." It is sad that Jeremiah could not always keep his spirit under the calming influence of these high thoughts. No book of the Old Testament, except the Book of Job and the Psalms, contains so much which is difficult to reconcile with the character of a self-denying servant of Jehovah. Such expressions as those in xi. 20, xv. 15, and especially xviii. 21-23, contrast powerfully with Luke xxiii. 34, and show that the typical character of Jeremiah is not absolutely complete.

No wonder if Jeremiah's style is feeble compared with that of the "royal prophet" Isaiah,—if he gladly leans on older prophets, and copies or imitates more than a bolder genius would have permitted. His utterance is interrupted by sobs, and he is without the energy to soar to poetic



heights. His brevity is that of "the evening star of prophecy," and Ewald even remarks (with some exuberance, perhaps) that he has "great wealth of new figures with great delicacy of description, a literary facility that readily adapts itself to the most different subjects, . . . and with all this an unadorned simplicity which is very unlike the greater artificiality of his contemporary Habakkuk."

3. *Dates of the Prophecies.*—According to Bleek, the following prophecies belong in all probability to the reign of Josiah, (a) ii. 1–iii. 5, (b) iii. 6–vi. 30 (expressly referred to this period), (c) vii. 1–ix. 25, (d) xi. 1–17. Dated prophecies meet us again in the time of Jehoiakim. Chap. xxvi, according to its own statement arose in the beginning of his reign; and it is held by some that chap. vii. gives the same prophecy as xxvi. 2–6, only in a fuller form. The prophecy against Egypt in xlvi. 2–12, and the prophecy of the vast extension of the Babylonian power in chap. xxv., are both dated in the fourth year of Jehoiakim (the latter is evidently not free from interpolations). To the same eventful year, according to most scholars, belongs the writing of all Jeremiah's prophecies in the roll which was read before Jehoiakim; but we have already seen reason to doubt the soundness of this view. At any rate, chap. xxxv. belongs to this period, as the superscription and the contents combine to show. Bleek also refers several other prophecies to the reign of Jehoiakim, *e.g.*, (a) xvi. 1–xvii. 18, (b) xvii. 19–27, (c) xiv., xv., (d) xviii., (e) xi. 18–xii. 17. To the short reign of Jehoiachin, or to the last period of Jehoiakim's, we may refer x. 17–23, and perhaps chap. xiii., with its account of a strange symbolical action connected with the Euphrates or more probably (Hitzig) Ephrath, *i.e.*, Bethlehem. Zedekiah's reign is much more fully represented in the prophecies; see chaps. xxii.–xxiv., xxvii.<sup>1</sup>–xxix., and, if li. 59 is to be followed, chaps. l., li. A little later in the same reign we may place chaps. xix., xx., which describe some remarkable scenes in Jeremiah's history. Later still, at the beginning of the siege of Jerusalem, fall xxxiv. 1–7, chap. xxxi., and the group of chapters beginning at chap. xxxii., the important prophecies in chaps. xxx., xxxi., also perhaps belong to this period; and of course chap. xxxvii. and the two following chapters.

It should be mentioned here that there are some portions of the book the Jeremianic authorship of which has been entirely or in part denied. (a) Chap. x. 1–16 was written, according to Movers, Hitzig, Graf, Knobel, and Naegelsbach by a prophet of the captivity—Movers and Hitzig say, by the author of Isaiah xl.–lxvi. (b) Chaps. xxx.–xxxiii., according to Movers and Hitzig, have been brought into their present shape by the author of Isa. xl.–lxvi., though the basis is Jeremianic. (c) Chaps. l., li., which Bleek assigns to the fourth year of Zedekiah, was according to Movers and Hitzig brought into its present form by a captivity prophet, working on a Jeremianic basis, while Ewald and Knobel hold it to have been entirely written at the close of the captivity. (d) Chap. lii. evidently forms the close of a history of the kings of Judah, and no doubt of the history followed very closely by the editor of the Books of Kings.

We cannot here enter fully into this subject. But something may be said on chaps. l., li.<sup>2</sup> It is open to grave doubt whether Jeremiah wrote these chapters. That he composed a prophecy against Babylon may be granted, and that he gave it to Seraiah with the charge described in li. 61–64; but it does not follow that the present prophecy on Babylon was the one referred to in ver. 60. There are special reasons for the opposite view, and they are analogous

to these which lead so many students to doubt the Isaianic origin of Isa. xl.–lxvi. For example,—(1) the author of the latter prophecy (or the greater part thereof) writes as if he were living at the close of the Babylonian exile. So does the author of Jer. l., li. See chap. li. verses 33, 6 and 45, 11 and 28, 20–23. (2) Although the above statement is literally true of most of Isa. xl.–lxvi., yet there are some passages which are much more suggestive of a Palestinian than of a Babylonian origin (see ISAIAH). Precisely so in Jer. l., li., at least according to one prevalent interpretation of l. 5, li. 50 (which are thought to imply a residence in Jerusalem), l. 28, li. 11, 35, 51 (suggestive, perhaps, of the continuance of Jerusalem and the temple), l. 17, li. 34 (implying, as some think, that Nebuchadnezzar is still alive). Still there is so much doubt respecting the soundness of the inferences that it is hardly safe to rely too confidently upon them. The case of Jer. l., li. is therefore in so far rather less favourable to Jeremiah's authorship than that of Isa. xl.–lxvi. is to that of Isaiah. (3) Amongst much that is new and strange in the style and phraseology of Isa. xl.–lxvi., there is not a little that reminds one forcibly of the old Isaiah. Similarly with Jer. l., li. "Every impartial judge," says Kuenen, "must admit that the number of parallel passages is very large, and that the author of chaps. l., li. agrees with no one more than with Jeremiah." For instance, the formula, "Thus saith Jehovah Sabaoth, the God of Israel" (l. 18, li. 33) also occurs in vii. 3, ix. 15, and some twenty-six other passages; comp. also l. 3 with ix. 9; l. 5 with xxii. 40; l. 7 with ii. 3, xiv. 18, xvii. 13.

The probability would therefore appear to be that, whatever solution we adopt for the literary problems of Isa. xl.–lxvi., an analogous solution must be adopted for Jer. l., li. The whole question is so large, and connects itself with so many other problems, that the present writer declines to pronounce upon it here. Only it should be observed—(1) that both subject and tone remind us of Isa. xl.–lxvi., and the kindred prophecies scattered about in the first part of the Book of Isaiah, and more especially of Isa. xiii. and the closely related prophecy, Isa. xxxiv.; (2) that these two chapters, Jer. l. and li., present some striking points of contact with Ezekiel, who, though contemporary with Jeremiah, was still a late contemporary, and allusions to whom (since Ezekiel was a literary rather than an oratorical prophet) imply that his prophetic book was already in circulation—in other words, suggest a date well on in the exile for the prophet who alludes to him; (3) that, though there are many Jeremianic allusions in Jer. l., li., there are also several passages copied almost verbally from prophecies of Jeremiah and applied to Babylon and its assailants (it seems difficult to believe that Jeremiah should have been so economical of his literary work). It deserves to be added (4) that, though Jeremiah is a great student of the earlier prophetic writings, and makes numerous allusions to them (see especially chaps. xlvi.–xlix.), nothing approaching to the mosaic work in Jer. l., li. can be pointed to in the undoubted prophecies of Jeremiah. In fact, the author of these chapters has borrowed almost the whole of their contents from other prophets,—his own property, so to speak, being too insignificant to be worth mentioning.

4. *The Massoretic Text and the Septuagint Version.*—The Alexandrian version presents an unusually large amount of variation from the received Hebrew text. Even in the order of the prophecies there is one remarkable discrepancy, *viz.*, in the series of prophecies against foreign nations (chaps. xxv. 15–xlv. become in the LXX. chaps. xxxii.–li., the series of prophecies in question being transposed); and there is no doubt an approach to the truth in the LXX. arrangement. More important are the

<sup>1</sup> In xvii., all critics agree that for "Jehoiakim" we should substitute, with the Syriac version, "Zedekiah."

<sup>2</sup> Compare a paper by Budde in *Jahrb. f. D. Theol.*, 1879.

differences of reading. "The LXX. has very few additions, and these only single words or syllables: on the contrary, there are many omissions of words, sentences, verses, and whole passages (altogether about 2700 words are wanting, or the eighth part of the Massoretic text); also alterations of passages, sometimes not without influence on the sense" (Bleek): and these discrepancies are of extremely early date, for the state of the Greek text was already noticed by Origen (*Ep. ad Afric.*, p. 56, Migne). Three principal explanations have been offered:—(1) the error of copyists (Jerome, Grabe); (2) negligence and caprice on the part of the Greek translators (Spohn, Naegelsbach, Wichelhaus, Keil, Graf); (3) the existence of various (or at least two) recensions of the Hebrew, the recension used by LXX. being nearer to the original text than that of the Massorets (J. D. Michaelis, Movers, Hitzig, Bleek). A better view is that adopted by Ewald, Schrader, and Kuenen, according to which the Massoretic text is on the whole the best; but the Greek version, in spite of the manifold errors and caprices of the translator, sometimes approaches more nearly to the original than the Massoretic text.

*Modern Literature.*—Yeniema, *Comment. in librum prophet. Jeremiae*, 2 vols., Leuwarden, 1765; Blayney, *Jeremiah and Lamentations, a new translation, with notes critical, philological, and explanatory*, London, 1784; Spohn, *Jeremias vates e vers. Jud. Alexandr. ac reliquis. interp. Græc. encuditis. notisq. crit. illustratus*, 2 vols., Leipzig, 1794, 1824 (of little value); Koorda, *Comm. in aliquot Jer. loca*, Groningen, 1824; Movers, *De utriusque recensionis varietatibus Jeremiae, Græcæ Alexandrinæ et Hebraicæ Massoreticæ, indole et origine*, Hamburg, 1837; Küper, *Jeremias librorum sanctorum interpres atque vindex*, Berlin, 1837; Wichelhaus, *De Jeremiae versione Alexandrina*, Halle, 1847; Scholz, *Der Mis. Text und die LXX. Uebers. d. B. Jer.*, 1875; Unthe, *Dr. Fæderis notione Jeremiana*, 1877. Commentaries by Graf, Leipzig, 1862; Hitzig, 2d ed., Leipzig, 1866; Naegelsbach, Bielefeld and Leipzig, 1868; Keil, Leipzig, 1872; Payne Smith (*Speaker's Commentary*, vol. v.); London, 1875; Ewald (vol. iii. of English translation of *Die Propheten*), London, 1879; Scholz, 1880; Cheyne (*Pulpit Commentary*), in the press. (T. K. C.)

**JEREZ DE LA FRONTERA**, a city in the province of Cadiz, Spain, near the right bank of the Guadalquivir, 16 miles N.N.E. of Cadiz (28 by rail), and 67 S.S.E. of Seville. It is pleasantly situated on an undulating plain of much fertility, and covers a considerable extent of ground. The old crenated Moorish wall by which it was formerly surrounded, but which it has now quite outgrown, still partially exists, as also do some of the ancient gateways. The newer portions of the town are well built, having broad regular streets with numerous "plazas" or squares adorned with fruit trees. The principal buildings are the Alcázar, an old palace fortress belonging to the Moorish period, adjoining the modern "alameda" or promenade; the collegiate church (1695), which, however, though large, presents no attractive architectural features; and the municipal buildings, belonging to the end of the 16th century, which display considerable taste. There are numerous other churches, a theatre, an orphanage, four hospitals, an "institute," a library, and various schools. The bull ring (1875) is a large one, and enjoys a good repute in Andalusia. The staple article of trade is the wine grown in the neighbourhood, known from the name of the town as "sherris" (xeres) or sherry, of which in 1876 a total of 4,607,550 imperial gallons was exported. Of these Great Britain and Ireland took 4,024,114, British colonies 51,122, and other parts of the world 532,314. The population in 1877 was 64,533.

Jerez has sometimes been identified with the ancient *Asta Regia*, but is most probably the *Asido* ("que Cæsariana") of Pliny. The *Sherish* of the Arabs is said to have been a corruption from *Cæsaris Asido*. It was in this neighbourhood that the decisive battle of the Guadalquivir (July 711) was fought which practically made Tarik master of the entire Pyrenean peninsula. Jerez, which is frequently mentioned in the chronicles of the Spanish Arabs, was recovered by Alfonso the Wise in 1255.

**JEREZ DE LOS CABALLEROS**, a city in the province of Badajoz, Spain, is picturesquely situated 39 miles to the south of that city, on two heights near the Ardila, a tributary of the Guadiana. The old town is surrounded by a Moorish wall with six gates; the newer portion of the city is well and regularly built, and adorned with numerous orange and other fruit trees. It has linen and woollen manufactures to a limited extent and several tanneries; but its principal articles of trade are the various agricultural and other products of the district, especially the fine quality of pork which is reared in the oak forests of the neighbourhood. The town is said to have been founded by Alphonso IX. of Leon in 1229; in 1232 it was extended by his son Saint Ferdinand, who gave it to the Knights Templars, whence the name of *los Caballeros*. It was made a city by Charles V. The population in 1877 was 8463.

**JERICHO** (יְרִיחוֹ, יְרִיחוֹ, "fragrant," or perhaps, according to an old interpretation, "city of the moon") was the first city west of the Jordan occupied by the Israelites. The city was destroyed, and though it is mentioned from time to time under its usual name (2 Sam. x. 5) or by its epithet "city of palm trees" (Judg. i. 16, iii. 13; comp. Deut. xxxiv. 3), it was not rebuilt as a fortified place till the reign of Ahab (1 Kings xvi. 34), when it became the seat of a prophetic society, and appears in the history of the prophet Elisha (2 Kings ii.). The narrative of the healing of the waters by Elisha is referred by Josephus (*B. J.* iv. 8, 3) to the copious fountain now called the Sultan's Spring, which lies on the western margin of the Jordan valley, 700 feet below the Mediterranean level, and just under the cliffs of M. Quarantania. The mounds surrounding the spring are of sun-dried brick, and show no traces of ancient building. The position of the town, in a district of great fertility, with rose gardens (*Ecclus.* xxiv. 14), various species of date palms, and valuable cultivation of henna, opobalsamum, and myrobalan (*Jos.*, *ut supra*; Strabo, xvi. 2), secured its prosperity, while its situation at the gate of the great pass leading up from the Jordan valley to Jerusalem gave it strategical importance. Thus we find that it shared the calamities of the Babylonian exile (*Ezra* ii. 34), was re-occupied on the restoration (*Neh.* iii. 2), and was fortified by Bacchides in the Maccabean wars (1 Mac. ix. 50). In the time of Strabo there were two forts, Threx and Taurus, protecting the pass above Jericho. Antony gave the groves of Jericho as a rich gift to Cleopatra. From her they passed to Herod the Great, who made the city his winter residence, and adorned it with buildings, crowning the height above with a fortress named after his mother Cyprus. Here it was that the tyrant died. It appears, however, that the Jericho of Herod was not on the site of the old city (*Jos.*, *ut supra*) but a mile to the south, where there are also mounds and the remains of five aqueducts conveying water from three distant springs. A great tank, of which the ruins are still traced, has been conjectured to be the same in which Herod drowned Aristobulus (*Jos.*, *Ant.*, xv. 2, 3). In the time of Christ the pilgrims from Peræa and Galilee appear to have gathered at Jericho on their way to Jerusalem, and so the town is repeatedly mentioned in the Gospels. According to Eusebius (*Onom.*, ed. Lagarde, p. 265) Jericho was destroyed at the time of the fall of Jerusalem, and a new town sprang up, from which he distinguishes the ruins of two earlier cities as still visible. To the third Jericho, which was an episcopal city, may be referred the Byzantine remains immediately east of Tell es Sultan. The present village of Rihâ or Arihâ, which stands nearly half an hour south-east of the Sultan's Spring, is a still more modern site, with a square tower of crusading date. Yâkût, in the beginning of the 13th century, still speaks of Jericho as producing dates, bananas, and excellent sugar, but all these have disappeared with the gradual decay of



the place. The modern village is but a group of squalid huts, and the ancient groves are represented by a thicket of the *Spina Christi* and other trees between the village and the Sultan's Spring.

**JEROME, St** (**HERONYMUS**, in full **EUSEBIUS SOPHRONIUS HERONYMUS**), was born at Strido (modern Strigau?), a town on the border of Dalmatia fronting Pannonia, destroyed by the Goths in 377 A.D. Some authorities, following Prosper's chronicle, give 330 or 331 as the date of his birth, but from certain passages in his writings it is more probable that he was not born till 340 or 342. He says, for example, that he was a boy learning grammar when Julian died; but Julian died in 363, and Jerome would scarcely call himself a boy if he had been thirty-three years old. What is known of Jerome has mostly been recovered from his own writings, for he was a gossiping sort of man, and biographers have only to string together extracts from his epistles and prologues to get a very good account of his life. His parents were Christians, orthodox though living among people mostly Arians, and wealthy. He was at first educated at home, Bonosus, a life-long friend, sharing his boyish studies, and was afterwards sent to Rome to perfect his education. Donatus, whose Latin grammar was to be the plague of generations of mediæval school-boys from St Andrews to Prague till Corderius and the Reformation drove it out, taught him grammar and explained the Latin poets. Victorinus taught him rhetoric. He attended the law-courts, and listened to the Roman advocates pleading in the Forum. He went to the schools of philosophy, and heard lectures on Plato, Diogenes, Clitomachus, and Carneades; the conjunction of names shows how philosophy had become a dead tradition. His Sundays were spent in the catacombs in discovering graves of the martyrs and deciphering inscriptions. Pope Liberius baptized him in 360; three years later the news of the death of the emperor Julian the Apostate came to Rome, and Christians felt relieved from a great dread.

When his student days were over Jerome returned to Strido, but did not stay there long. His character was formed. He was a scholar, with a scholar's tastes and cravings for knowledge, easily excited, bent on scholarly discoveries. From Strido he went to Aquileia, where he formed some friendships among the monks of the large monastery there, the most notable being his acquaintance with Rufinus, with whom he was destined to quarrel bitterly over the question of Origen's orthodoxy and worth as a commentator; for Jerome was a man who always sacrificed a friend to an opinion, and when he changed sides in a controversy expected his acquaintances to follow him. From Aquileia he went to Gaul, visiting in turn the principal places in that country, from Narbonne and Toulouse in the south to Treves on the north-east frontier. He stayed some time at Treves studying and observing, and it was there that he first began to think seriously upon divine things. From Treves he returned to Strido, and from Strido to Aquileia. He settled down to literary work in Aquileia, and composed there his first original tract, *De Muliere septies percussa*, in the form of a letter to his friend Innocentius. Some quarrel, no one knows what, caused him to leave Aquileia suddenly; and with some companions, Innocentius, Evagrius, and Heliodorus being among them, he started for a long tour in the East. The epistle to Rufinus (3d in Vallarsi's enumeration) tells us the route. They went through Thrace, visiting Athens, Bithynia, Galatia, Pontus, Cappadocia, and Cilicia, to Antioch, Jerome observing and making notes as they went. He was interested in the theological disputes and schisms in Galatia, in the two languages spoken in Cilicia, &c. At Antioch the party remained some time. Innocentius died of a fever, and Jerome was dangerously ill. This illness brought him face

to face with death; he experienced conversion, and resolved to renounce whatever kept him back from God. His greatest temptation was the study of the literature of pagan Rome. In his dreams God reproached him with caring more to be a Ciceronian than a Christian. He disliked the uncouth style of the Scriptures. "O Lord," he prayed, "Thou knowest that whenever I have and study secular MSS. I deny Thee," and he made a resolve henceforth to devote his scholarship to the Holy Scripture. "David was to be henceforth his Simonides, Pindar, and Alcæus, his Flaccus, Catullus, and Severus." Fortified by these resolves he betook himself to a hermit life in the wastes of Chaleis. Chaleis was the Thebaid or the Marseilles of Syria. Great numbers of monks, each in solitary cell, spent lonely lives, scorched by the sun, ill-clad and scantily fed, pondering on portions of Scripture or copying MSS. to serve as objects of meditation. Jerome at once set himself to such scholarly work as the place afforded. He discovered and copied MSS., and began to study Hebrew. There also he wrote the life of St Paul of Thebes, probably an imaginary tale embodying the facts of the monkish life around him. Just then the Meletian schism, which had to do with the relation of the orthodox to Arian bishops and to those baptized by Arians, distressed the church at Antioch, and Jerome as usual eagerly joined the fray. Here as elsewhere he had but one rule to guide him in matters of doctrine and discipline,—the practice of Rome and the West; for it is singular to see how Jerome, who is daringly original in points of scholarly criticism, was simply a ruthless partisan in all other matters; and, having discovered what was the Western practice, he set tongue and pen to work with his usual bitterness (*Altercatio Luciferiani et Orthodoxi*). From Antioch he went to Constantinople, where he met with the great eastern scholar and theologian Gregory of Nazianzus, and with his aid tried to perfect himself in Greek. The result of his studies there was the translation of the *Chronicon* of Eusebius, with a continuation,<sup>1</sup> of twenty-eight homilies of Origen on Jeremiah and Ezekiel, and of nine homilies of Origen on the Visions of Isaiah.

In 381 Meletius died, and Pope Damasus interfered in the dispute at Antioch, hoping to end it. Jerome was called to Rome in 382 to give help in the matter, and was made secretary during the investigation. His work brought him into intercourse with this great pontiff, who soon saw what he could best do, and how his vast scholarship might be made of use to the church. Damasus suggested to him to revise the existing Latin translation of the Bible; and to this task he henceforth devoted his great abilities (see BIBLE). At Rome were published the Gospels (with a dedication to Pope Damasus, an explanatory introduction, and the canon of Eusebius), the rest of the New Testament, and the version of the Psalms from the LXX. text, known as the *Psalterium Romanum*, which was followed in 385 by the *Psalt. Gallicanum*, based on the Hexaplar Greek text. These scholarly labours, however, did not take up his whole time, and it was almost impossible for Jerome to be long anywhere without getting into a dispute. He was a zealous defender of that monastic life which was beginning to take such a large place in the church of the 4th century, and he found enthusiastic disciples among the Roman ladies. A number of widows and maidens met together in the house of Marcella to study the Scriptures with him; he taught them Hebrew, and preached the virtues of the celibate life. His arguments and exhortations may be gathered from many of his epistles and from his tract *Adversus Helvidium*, in which he defends the perpetual virginity of the Virgin Mary

<sup>1</sup> Comp. Schoene's critical edition (Berlin, 1866, 1876).

against Helvidius, who maintained that Mary bore children to Joseph. His influence over these ladies alarmed their relations, and excited the suspicions of the regular priesthood and of the populace, but while Pope Damasus lived Jerome remained secure. Damasus died, however, in 384, and was succeeded by Siricius, who did not show much friendship for Jerome. He found it expedient to leave Rome and set out for the East in 385. His letters (especially Ep. 45) are full of outcries against his enemies and of indignant protestations that he had done nothing unbecoming a Christian, that he had taken no money, nor gifts great nor small, that he had no delight in silken attire, sparkling gems, or gold ornaments, that no matron moved him unless by penitence and fasting, &c. His route is given in the third book *In Rufinum*; he went by Rhegium and Cyprus, where he was entertained by Bishop Epiphanius, to Antioch. There he was joined by two wealthy Roman ladies, Paula, a widow, and Eustochium her daughter, one of Jerome's Hebrew students. They came accompanied by a band of Roman maidens vowed to live a celibate life in a nunnery in Palestine. Accompanied by these ladies Jerome made the tour of Palestine, carefully noting with a scholar's keenness the various places mentioned in Holy Scripture. The results of this journey may be traced in his translation with emendations of the book of Eusebius on the situation and names of Hebrew places, written probably three years afterwards, when he had settled down at Bethlehem. From Palestine Jerome and his companions went to Egypt, remaining some time in Alexandria; and they visited the convents in the Nitrian desert. Jerome's mind was evidently full of anxiety about his translation of the Old Testament, for we find him in his letters recording the conversations he had with learned men about disputed readings and doubtful renderings; Didymus of Alexandria appears to have been most useful. When they returned to Palestine they all settled at Bethlehem, where Paula built four monasteries, three for nuns and one for monks. She was at the head of the nunneries until her death in 404, when Eustochium succeeded her; Jerome presided over the fourth monastery. In this monastery at Bethlehem Jerome did most of his literary work and, throwing aside his unfinished plan of a translation from Origen's Hexaplar text, translated the Old Testament directly from the Hebrew, with the aid of Jewish scholars. He mentions a rabbi from Lydda, a rabbi from Tiberias, and above all Rabbi Ben Anan, who came to him by night secretly for fear of the Jews. Jerome was not familiar enough with Hebrew to be able to dispense with such assistance, and he makes the synagogue responsible for the accuracy of his version: "Let him who would challenge aught in this translation," he says, "ask the Jews." The result of all this labour was the Latin translation of the Scriptures which, in spite of much opposition from the more conservative party in the church, afterwards became the Vulgate or authorized version; but the Vulgate as we have it now is not exactly Jerome's Vulgate, for it suffered a good deal from changes made under the influence of the older translations; the text became very corrupt during the Middle Ages, and in particular all the Apocrypha, except Tobit and Judith, which Jerome translated from the Chaldee, were added from the older versions.<sup>1</sup>

Notwithstanding the labour involved in translating the Scriptures, Jerome found time to do a great deal of literary work, and also to indulge in violent controversy. Earlier in life he had a great admiration for Origen, and translated many of his works, and this lasted after he had settled at

<sup>1</sup> See Vercellone, *Variæ Lectiones Vulgatæ*, Rome, 1860, 1864 (unfinished).

Bethlehem, for he translated in 389 Origen's homilies on Luke; but he came to change his opinion and wrote violently against the admirers of the great Alexandrian scholar, *Contra Joannem Hierosolymitanum*, and *Adversus Rufinum Lib. III.*, for both John, bishop of Jerusalem, and Rufinus, Jerome's old friend, were followers of Origen. At Bethlehem also he found time to finish *Didymi de Spiritu Sancto Liber*, a translation begun at Rome at the request of Pope Damasus, to denounce the revival of Gnostic heresies by Jovinianus and Vigilantius (*Adv. Jovinianum Lib. II.* and *Contra Vigilantium Liber*), and to repeat his admiration of the hermit life in his *Vita S. Hilarionis Eremitæ*, in his *Vita Malchi Monachi Captivi*, in his translation of the Rule of St Pachomius (the Benedict of Egypt), and in his *S. Pachonii et S. Theodorici Epistolæ et Verba Mystica*. He also wrote at Bethlehem *De Viris illustribus sive de Scriptoribus Ecclesiasticis*, a church history in biographies, ending with the life of the author; *De Nominibus Hebraicis*, compiled from Philo and Origen; and *De Situ et Nominibus Locorum Hebraicorum*.<sup>2</sup> At the same place, too, he wrote *Quæstiones Hebraicæ* on Genesis,<sup>3</sup> and a series of commentaries on Isaiah, Jeremiah, Ezekiel, Daniel, the Twelve Minor Prophets, Matthew, and the Epistles of St Paul. Jerome engaged in the Pelagian controversy with more than even his usual bitterness (*Dialogi contra Pelagianos*); and it is said that the violence of his invective so provoked his opponents that an armed mob attacked the monastery, and that Jerome was forced to flee and to remain in concealment for nearly two years. He returned to Bethlehem in 418, and after a lingering illness died on September 30, 420.

By far the best edition of Jerome's works is that of Vallarsi (Verona, 1734-42), which contains in prefaces and appendices almost all that is known of the great Western scholar. The student will find the article on "Hieronymus" by Colln in Ersch and Gruber's *Encyclopædie* very useful, and the English reader will find a succinct account of his writings taken from Vallarsi in Smith's *Dict. of Greek and Roman Biography and Mythology*, art. "Hieronymus." (T. M. L.)

JEROME OF PRAGUE (c. 1365-1416), the friend and disciple of John Huss, derives the surname by which he is best known from his native town, where he was born somewhere between 1360 and 1370. His family name is sometimes, but erroneously, said to have been Faulfisch. After completing his studies in the university of Prague, he proceeded (about 1396) to Oxford, where in course of a residence of some duration he became acquainted with the teaching and writings of Wycliffe, of which he became a zealous disseminator on his return to his native land. In 1398 he took his bachelor's degree at Prague, and then visited Paris, Heidelberg, and Cologne; at the first-mentioned university he seems to have graduated as master of arts. Returning about 1407 to Prague, he took a prominent part with Huss in the university disputes which led to the withdrawal of the German "nation." So great did his reputation for learning, energy, and sagacity become that he was employed by Ladislaus II., king of Poland, in 1410 to assist in placing the university of Cracow upon a proper footing, while by Sigismund, king of Hungary, he was, although not in orders, invited to preach before him at Ofen. His public discourses in Hungary, however, soon brought him under suspicion of Wycliffite heresy, and he found it necessary to fly the country; taking refuge in Vienna, he was there arrested and thrown into prison, but on the intervention of his friends in Prague obtained his release. He now again became closely asso-

<sup>2</sup> Compare the critical edition of these two works in Lagarde's *Oronastica Sacra*, Götting., 1870.

<sup>3</sup> See Lagarde's edition appended to his *Genesis Græce*, Leipzig, 1868.



ciated with Huss in his native city, to which he had once more returned, and where he remained after the expulsion of his friend. In 1415 he went spontaneously to Constance, determined to do what he could for Huss, who had meanwhile been imprisoned there; the news he received on his arrival were so discouraging, however, that, panic-stricken, he immediately again withdrew. Though without a safe conduct he would no doubt have reached Prague in safety had he only been able to hold his peace, but while resting at Hirschau he allowed his feelings to gain the mastery of him, and, in the presence of many clergy, broke out in vehement denunciation of the injustice of the council; the consequence was that he was forthwith arrested by order of the duke of Bavaria and sent back a prisoner to Constance (May 1415). There, after enduring the most rigorous confinement for some months, he was brought before a public session of the council on September 23, 1415, when he made a full retraction of all errors against the Catholic faith, especially those of Wycliffe and Huss. His enemies, however, were determined that not even thus should he escape their hands; by Michael de Causis and Stephen Palecz (who also had made themselves conspicuous in the persecution of Huss) it was declared that the recantation was ambiguous, and new articles were exhibited against their victim. Thrice again he was brought before a general congregation of the council. On the last of these occasions (May 26, 1416) all his timidity seems to have finally left him. In a bold and vigorous declamation he solemnly retracted the retraction which had been wrung from him eight months before; "of all the sins that I have committed since my youth, none weigh so heavily on my mind and cause me such keen remorse as that which I committed in this evil place when I approved of the iniquitous sentence given against Wycliffe and against the holy martyr John Huss, my master and friend." Four days afterwards he was condemned as a relapsed heretic; his reply was an appeal to the supreme Judge before whom he and his accusers alike were destined to stand. Two days later he marched with a cheerful countenance to the stake, bidding the executioner light the fire before his face; "had I the least fear, I should not be standing in this place." His ashes, like those of Huss, were gathered and thrown into the Rhine. Jerome owes his fame to his association with Huss, and particularly to the splendid heroism with which in his death he atoned for one moment of faltering in his loyalty to the doctrines to which he had faithfully devoted his life. No literary remains survive by which we might estimate with precision how far the claims to learning and superiority of intellect often made for him can be justified. Of absolute originality he obviously had none. The truth seems to be that, with considerable advantages of birth and early training, and with a mind more variously accomplished than that of Huss, he nevertheless wanted the moral weight which gave his master so great an ascendancy over the minds and hearts of men. Bold even to rashness, his courage was shown rather in bursts of furious vehemence than in the equable tenor of his life, and more than once failed him in critical moments. In this weakness he only reflected the turbulent and unruly spirit of the age he lived in; but it is also a weakness that sufficiently justifies history in assigning to him a comparatively subordinate though still highly honourable place among the pioneers of the Reformation.

See Heller, *Hieronimus von Prag*, 1835; Neander, *Church History*; and Lechler, *Johann von Wiclif u. die Vorgeschichte der Reformation*, 1873.

JERROLD, DOUGLAS WILLIAM (1803-1857), dramatist, satirist, and one of the most brilliant of the English wits who distinguished the first half of the 19th century, was

born in London, January 3, 1803. His father, Samuel Jerrold, actor, was at that time lessee of the little theatre of Wilsby near Cranbrook in Kent, but in 1807 he removed to Sheerness. There, among the blue jackets who swarmed in the port during the war with France, little Douglas grew into boyhood, a stout, well made, rōsy-cheeked, white-haired urchin, fond of reading and pugnacious withal. Familiarity with the tinsel and glitter of his father's profession robbed it of its chief attractions for the boy; but the glorious renown of Nelson and the anti-Gallic enthusiasm of his father's naval patrons filled his susceptible bosom, and wooed him to his majesty's uniform. From December 1813 till October 1815 Douglas Jerrold served his country as a midshipman. He saw nothing of the war save a cargo of maimed warriors from Waterloo, but till his dying day there lingered traces of his early passion for salt water. The peace of 1815 ruined poor Samuel Jerrold; there was no more prize money. On January 1, 1816, he removed with his family to London, where the plucky little ex-midshipman began the world again as a printer's apprentice, studying hard in the grey of the early morning at Latin, pinching himself to get the *Waverley Novels* from the library, and finding unspeakable delight in the pages of his *Shakespeare*. In 1819 Douglas Jerrold was a compositor in the printing-office of the *Sunday Monitor*. Several short papers and copies of verses by him had already appeared in the sixpenny magazines, but he aspired now to contribute to the *Monitor*; and stealthily one evening he dropped into the editor's box a critique of the opera *Der Freischütz*. Next morning he received his own copy to set up, together with a flattering note from the editor, requesting further contributions from the anonymous author. Thenceforward Jerrold was engaged in journalism.

He soon entered another field where he was to reap less honourable laurels. In 1821 he had the satisfaction of seeing a comedy that he had composed in his fifteenth year brought out at Sadler's Wells Theatre, under the title *More Frightened than Hurt*. Other pieces followed, and in 1825 the popular young dramatist was engaged for a few pounds weekly to produce dramas and farces to the order of Mr Davidge of the Coburg Theatre. By his marriage in the autumn of 1824 the "little Shakespeare in a camel cloak," as he was called, had found a less fitful incentive to industry than his mere ambition; and, while he was engaged with the drama at night, he was steadily pushing his way as a journalist by his daily labours. For a short while he was part proprietor of a small Sunday newspaper. In 1829, through a fortunate quarrel with the exacting Davidge, Jerrold left the "Coburg," and *Black-Eyed Susan* was brought out on the "Surrey" boards. The success of the piece was enormous. With its free gallant sea-flavour, it took the town by storm, and "all London went over the water to see it." On the three hundredth night the theatre was illuminated. Elliston, manager of the "Surrey," made thousands of pounds; T. P. Cooke, who played William, made his reputation; Jerrold received about £70. But his fame as a dramatist was achieved. In 1830 it was proposed that he should adapt something from the French for Drury Lane. "No," was his reply to the offer, "I shall come into this theatre as an original dramatist or not at all." In December of the following year he was received on his own terms; *The Bride of Ludgate* was the first of a number of plays which found their way to Drury Lane stage. The other patent houses threw their doors open to him also (the Adelphi had already done so); and in 1836 Jerrold himself became co-manager of the Strand Theatre with Mr Hammond his brother-in-law. The venture was not successful; and the partnership was dissolved. While it lasted Jerrold wrote his only tragedy, *The Painter of Ghent*, and appeared himself in the title rôle, without

any very marked success. His pen continued to be fruitful of sparkling comedies till 1854, when his last piece, *The Heart of Gold*, was written.

Meanwhile he had won his way to the pages of numerous periodicals,—before 1830 of the second-rate magazines only, but after that to those of more importance; and he had almost reached comfort and ease when an obligation, undertaken for an unfortunate friend, drove him forth to fresh years of hard toil. When at last he could settle in comfort he found himself the centre of a host of friends, whose affection was his no less than their admiration; and his last years were spent in peaceful happiness. The *Monthly Magazine*, *Blackwood's*, the *New Monthly*, and the *Athenæum*, all welcomed his brilliant articles. To *Punch*, the publication which of all others is associated with his name, he contributed from its second number in 1841 till within a few days of his death. He founded and edited for some time, though with indifferent success, the *Illuminated Magazine*, *Jerrold's Shilling Magazine*, and *Douglas Jerrold's Weekly Newspaper*, and under his editorship *Lloyd's Weekly Newspaper* rose from almost nonentity to a circulation of 182,000. The history of his later years is little more than a catalogue of his literary productions, interrupted now and again by brief flights to the Continent or to the country. Douglas Jerrold died at his house, Kilburn Priory, in London, on June 8, 1857.

Jerrold's figure was small and spare, and in later years bowed almost to deformity. His features were strongly marked and expressive from the thin humorous lips to the keen blue eyes gleaming from beneath the shaggy eyebrows. He was brisk and active, with the careless bluntness of a sailor. Open and sincere, he concealed neither his anger nor his pleasure; to his simple frankness all polite duplicity was distasteful. Hating the conventionalities of the town, he loved to make his home in some rural retreat where he could roam at ease, with loose coat and straw hat. To his house, always hospitable, he was especially fond of attracting young men, whom he encouraged with strong, cheery words, and often with more material aid. The cynical side of his nature he kept for his writings; in private life his hand was always open. In politics Jerrold was a Liberal, and he gave eager sympathy to Kosuth, Mazzini, and Louis Blanc. In social politics especially he took an eager part; he never tired of declaiming against the horrors of war, the luxury of bishops, and the iniquity of capital punishment.

Douglas Jerrold is now perhaps better known from his reputation as a brilliant wit in conversation than from his writings. In animated talk his retorts and fancies flew from his lips like a shower of sparks. His jests were unpremeditated and unforced; their spontaneity, which not seldom surprised Jerrold himself, was one of their most telling characteristics, and often robbed his sharpest retorts of their sting. For he let no sentimental or polite consideration stand in the way of a brilliant rejoinder. As Dr Charles Mackay expresses it, "when his jest came to the tip of his tongue, it had to explode though the heavens should crack, and his best friend should take it amiss." Yet no one can accuse Jerrold of being spiteful. Ill-advised and thoughtless, even unjust, his wit often was; but it was not barbed. It did not rankle in the wound. Jerrold's wit was of a tolerably high intellectual order. It is said that no pun is to be found in his writings. Their wit is the wit of burnished epigram and quaint conceit, of happy phrase and lightning retort. But the puns that abounded in his talk were often wise as well as witty. The well-known description of dogmatism as "puppyism come to maturity" is an excellent example of the flashing insight that gave life and meaning to his jests.

As a dramatist Jerrold was very popular, and struck out quite a line for himself in the domestic drama. Here he

dealt with rather humbler forms of social life than had commonly appeared on the stage; and it is worthy of note that plays of this kind have had the greatest run in modern times. Jerrold was one of the first and certainly one of the most successful of those who in defence of the native English drama endeavoured to stem the tide of translation from the French, which threatened early in the 19th century altogether to drown original native talent. Thoroughly English in motive, action, and atmosphere, his plays, whether comedy or domestic drama, are all effective from their freshness, point, and spirit. The author is at his best in construction as well as in sparkling epigram and brilliant dialogue in *Bubbles of the Day*, and *Time Works Wonders*. The latter perhaps excels in plot and human interest. The tales and sketches which form the bulk of Jerrold's collected works vary much in skill and interest; but, although the artistic symmetry is here and there marred by traces of their having been composed from week to week, they are always marked by keen satirical observation and pungent wit. While reading them it is well to remember that they have a higher aim than the beguiling an idle hour by the mere interest of the story; for the author is always trying to call attention to some wrong, to rouse pity for some hardship, to stir up indignation against some form of social oppression or abuse.

Jerrold's writings are scattered over all the periodical literature of his day; but perhaps his most important works are in the following list. *Men of Character* are seven sketches (collected in 1838), in which he throws sarcastic ridicule on various foibles and hypocrisies of every-day men; *Cakes and Ale*, a collection of short papers of all sorts made in 1842, contains whimsical tales directed against the tyranny of riches, the folly of judging by appearances, with similar thrusts at the weaknesses and vices of humanity; *The Story of a Feather*, which originally appeared in *Punch* in 1842-43, tracing the career of an ostrich feather as it passes to successive owners, affords the author opportunities of exposing shams, lashing vices, and gibbeting successful villainy in every rank of life. In *The Chronicles of Clovenhook* he ventilates his philosophy of life, and his objections to existing social and political institutions; in *A Man made of Money*, where the supernatural forms the basis for a story of an eminently matter-of-fact character, he fulminates against the blind worship of lucre; *St Giles and St James*, perhaps his best work of this class, is described in his own words as "an endeavour to show in the person of St Giles the victim of an ignorant disregard of the social claims of the poor upon the rich, . . . to present . . . the picture of the infant pauper reared in British ignorance." Of his professedly satirical papers the chief are *Punch's Letters to his Son*, *Punch's Complete Letter-Writer*, and *Sketches of the English*. *Mrs Caville's Curtain Lectures*, possibly the most widely known of all Jerrold's writings, explain themselves by their title. Besides the "Q Papers," which began in the second number of *Punch*, Jerrold wrote various political articles for his own and other newspapers.

Were a reader now to go to Jerrold's writings, he would find much that seems commonplace and trite. The fault is not with Jerrold, but with the host of his imitators who have sought with more or less success to reproduce in the pages of every magazine the social cynicism which is apt at first view to be taken for the essence of Jerrold's style. But Jerrold has his own happy knack of handling ordinary subjects, his own singular method of regarding things. His truths may sometimes be commonplaces, and his moralizings trite; his descriptions may sometimes drag on to tedium, and his characters stiffen into lay figures; even his passion may sometimes attenuate to fustian, but every paragraph is lit up by quaint phrase or happy conceit;



every page is illumined by some gleaming epigram or flash of originality. Jerrold seems to revel in the sarcastically satirical, perhaps the easiest and most directly effective of all satire. He appears to have reserved the softer side of his nature for his private life. He is far more at home in satirizing the foibles of men than in praising their good points. Here and there there are tender gleams of rarest pathos in his pages; but these do not occur in scenes elaborated to move pity, but in the simple half unconscious finishing touch to some little picture, drawn from the author's heart. That Jerrold has painted for us no full-length portrait of a thoroughly noble character is due to his ultra-clear perception of the bad in human nature. "Mr Capstick" in *St Giles and St James*, who is perhaps the most truly benevolent of all his personages, escapes the difficulty of revealing his excellence in consistent speech by becoming an amiable hypocrite, and poses as "the man with gall in his words and balm in his deeds."

A writer in the *Edinburgh Review* for 1859 accuses Jerrold of being a "sentimentalist,"—of writing "to gratify his sympathies and antipathies, and not to bring out the truth." That is an extreme statement, which has some foundation in fact. Jerrold often attacked what he considered an abuse without stopping to weigh the ultimate consequences, and without being swayed by very satisfactory or conclusive reasons. Sometimes too the epigram or the jest seems to have suggested the opinion, rather than the opinion the epigram. That he generally espoused the healthy side was due more to his instinct than to his reason, more to his heart than to his head. His keen feelings often carried him to great lengths in invective. He did not escape the besetting sin of all social reformers. He is tempted to elaborate and intensify the peculiar aspect of the question that best suits the lesson he seeks to read; and although it is impossible to doubt his perfect sincerity and honest intention, yet the darkening of the shadows has a disingenuous air, and we are tempted to suspect that he has been unconsciously impelled to exaggerate reality or distort fact in order to justify his diatribe. Such a suspicion is fatal to satire. It enlists our sympathies, on a most healthy principle, on the side of what is attacked; and it is the cause why so much of what Jerrold wrote has missed fire. This fault of colouring, which earnest social satire can scarcely escape, has been commonly translated by critics as "bitterness"; but bitterness is far too ill-natured a word to describe the vivid, quivering feeling in which there is not the faintest tincture of personal animus, and in which all the sharpness is on behalf of the poor and the oppressed, with whom his own life had taught him sympathy.

Douglas Jerrold's *Works* were collected by himself in 8 vols. 8vo., 1851-55, and again in 4 vols. 8vo in 1859. *The Life and Remains of Douglas Jerrold*, by his son Blanchard Jerrold, was published in 1858; 2d ed., 1869. (F. M.U.)

JERSEY, the largest and most important of the CHANNEL ISLANDS (*q.v.*), is situated between 49° 15' and 49° 10' N. lat., and between 2° 0' and 2° 15' W. long., 16 miles west of Normandy and 125 south of Southampton. The total area comprises 28,717 imperial acres, or about 45 square miles. It is of oblong form, with a length of about 11 miles from east to west, and an average breadth of about 5½ miles. Along the northern part of the island a belt of elevated land runs from east to west, displaying bold and picturesque cliffs towards the sea. The east, south, and west coasts consist of a continuous succession of large open bays with marshy or sandy shores terminated by rocky headlands. The principal bays are Grève au Lançon, Grève de Lecq, and Bouley Bay on the north coast; St Catherine's Bay and Grouville Bay on the east coast; St Clement's Bay, Samarez Bay, St Aubin's Bay, and St Brelade's Bay on the south coast: and St Owen's Bay on

the west coast. The sea in many places has encroached greatly on the land, and sand drifts have been found very troublesome, especially on the west coast. The surface of the country is broken by winding valleys having a general direction from north to south, and as they approach the south uniting so as to form small plains. The lofty hedges which bound the small enclosures into which Jersey is divided, the trees and shrubbery which line the roads and cluster round the uplands and in almost every nook of the valleys unutilized for pasturage or tillage, give the island a rich and luxuriant appearance, and completely neutralize the bare effect of the few sandy plains and sand-covered hills. Some of the coast scenery is grand and striking, presenting many features of special interest.

According to J. A. Bird ("Geology of the Channel Islands," in the *Geological Magazine*, London, 1878), Jersey rests on syenite rocks, which appear in three great masses in the north-west, south-west, and south-east of the island. Between these masses there is in the west an extensive formation of shale and schist, and in the north-west a formation variously composed of porphyries, limestone schist, altered sandstone, quartzite and quartzose conglomerate. In the neighbourhood of St Helier there is an accumulation of volcanic rocks consisting of trap, porphyry, and amygdaloid. China stone clay is obtained in large quantities. There are some veins of lead, and ironstone is occasionally found. The climate of Jersey is somewhat warmer in summer and colder in winter than that of Guernsey. The annual mean temperature is 51°, the annual rainfall about 30½ inches, and the number of days upon which rain falls about one hundred and fifty. The wettest season is from October to January, but rain seldom continues long. The island enjoys a very early spring and a lengthened autumn. Snow and frost are rare, but dense fogs frequently prevail. Fruits and flowers indigenous to warm climates grow freely in the open air. The land is rich and very productive, the soil being chiefly a deep loam, which is lighter upon syenite and granite than upon the other formations; the sandy portions in the vicinity of the bays have become very fruitful through cultivation. The lands are held either as freeholds or on a nine years' lease. On account of the Norman law of succession the farms have become very much subdivided. It is only rarely that they exceed 50 acres, and very many are less than 3 acres. The farmhouses and cottages are remarkably neat and comfortable; and the peasantry, who all farm their own land, are perhaps the most contented and prosperous in the United Kingdom. A five-course shift (turnips, potatoes or parsnips, wheat, hay, hay) is that usually followed. The frequency with which root crops are grown, and the abundant supply of sea manure, have greatly enriched the soil. The seaweed or *vraic* harvest occurs at certain seasons which are prescribed by law. It is only then that it is permissible to cut the *vraic* from rocks; but loose *vraic* is gathered in large quantities at all seasons. The implements of husbandry are generally old-fashioned. The peasantry take advantage of every bit of wall and every isolated nook of ground for growing fruit trees. Grapes are ripened under glass; oranges are grown in sheltered situations, but the most common fruits are apples, which are used for cider, and pears. The island is intersected by a network of roads. There is a railway line between St Helier and St Aubin's, and connects St Helier and Gorey.

According to the agricultural returns for 1880 the total area of arable land was 18,950 acres,—a percentage of 66.2 to the total area,—of which 2920 acres were under corn crops, 7456 under green crops, 4359 under rotation grasses, 4067 under permanent pasture, and 128 fallow. Under orchards there were 1345 acres, under market

gardens 186, and under nursery grounds 38. Wheat, which in 1880 occupied 2524 acres, is the principal and almost exclusive corn crop, the kinds grown being principally Velouzé and Petit Blanc. For the crop a manure of burnt seaweed is generally used. The area under potatoes in 1880 was 4671 acres. They are grown chiefly for the Covent Garden Market, the earliest crop being ready about the end of April or beginning of May. Only 1313 acres were under turnips. The pasturage is very rich, and is much improved by the application of seaweed to the surface. The mainstay of Jersey is cattle, which in 1880 numbered 11,022, or the large average of 58 to every 100 acres under cultivation, the average of the United Kingdom being only 20·7. The breed is that commonly known as the Alderney, and is kept pure by stringent laws against the importation of foreign animals. The number of cows was 5884, of other cattle above two years of age only 756, and of cattle below two years of age 4382. It will thus be seen that cattle are kept chiefly for dairy purposes. The milk is used almost exclusively to manufacture butter. The cattle are always housed in winter, but remain out at night from May till October. Horses in 1880 numbered 2261. Originally there was a small black breed of horses peculiar to the island, but now they are chiefly imported from France or England. Pigs form the staple food of the inhabitants, and numbered 5844. Only a few sheep are kept, 346 in 1880.

The number of ships that entered the ports of Jersey in 1879 was 2001, of 281,663 tons burden,—British vessels numbering 1659, of 275,990 tons, and foreign vessels 142, of 5673 tons. In the same year 2018 vessels, of 279,485 tons burden, cleared,—British vessels numbering 1876, of 273,319 tons, and foreign vessels 142, of 6166 tons. The number of vessels belonging to the island was 234, with a burden of 17,027 tons, in addition to which there is a large number of fishing boats. There is regular steam communication with England *via* Southampton, Weymouth, and Plymouth, and with France *via* Granville and St. Malo. The principal exports are granite, fruit and vegetables (especially potatoes), oysters, butter, and cattle; and the principal imports coal, wine, rum and other spirituous liquors, sugar, tea, wheat, and eggs. Kelp and iodine are manufactured from seaweed. Fish are not so plentiful as around the shores of Guernsey, but mackerel, turbot, cod, mullet, and especially the conger eel, are abundant at the Minquiers. There is a large oyster bed between Jersey and France, but partly on account of over-dredging the supply is not now so abundant as formerly. There is a great variety of other shell-fish. The islanders build their own ships.

Jersey is under a distinct and in several respects different form of administrative government from Guernsey and the smaller islands included in the bailiwick of Guernsey. The administration is under the superintendence of a lieutenant-governor appointed by the crown. The main business of legislature in Jersey is carried on by the "states," which consist of the bailiff or judge of the royal court elected by the crown, twelve jurats of the royal court elected for life by the ratepayers, the rectors of the twelve parishes, twelve constables elected every three years, and fourteen deputies elected every three years. The lieutenant-governor has a deliberative voice, and, though he has no vote, has the power of veto. The states have the power of passing *ordonnances* which unless they obtain the sanction of the sovereign of England are in force for only three years. English Acts of Parliament after registration become laws in Jersey. Taxation is very light in the island. The only legal tribunal is the royal court, composed of the bailiffs and twelve jurats. The lieutenant-governor has the superintendence of the militia, in which every male between seventeen and sixty-five years of age, who is medically fit, is liable for service. Jersey is divided into twelve parishes, and ecclesiastically it constitutes a deanery in the diocese of Winchester in England.

The only town of importance is St. Helier, situated on St. Aubin's Bay. It has rather a mean and uninteresting appearance, but beautiful views are obtained from various points. Although the streets are generally narrow and irregular, they are clean and well paved, and the Royal Square is spacious and airy. The town possesses an outer and an inner harbour. Fort Regent, a fortress completed in 1815 at a cost of £1,000,000, is situated on a lofty ridge of granite to the east of the harbour; and on the rocks to the west stands Elizabeth Castle, a disused stronghold erected in the time of Elizabeth on the site of an abbey founded in the 12th century. Closely adjoining it there is an ancient ruin called the hermitage. The other principal buildings are the parish church in

the Early Pointed style, dating from 1341, and lately completely renovated, the court-house, the Albert Hall for concerts and assemblies, Victoria College, the hospital, and the jail. The population of the town and parish in 1881 was 26,593.

The population of Jersey in 1806 was 22,855. From 1821, when it numbered 28,600, it increased rapidly till 1851, when it had reached 57,020. In 1861 it had declined to 55,613; and, although owing to the number of French who sought refuge in the island it increased in 1871 to 56,627, in 1881 it was only 52,372, of whom 23,415 were males and 28,957 females.

An historical account of Jersey will be found under CHANNEL ISLANDS. The principal objects of antiquarian interest are the cromlech near Mont Orgueil; the castle of Mont Orgueil, of very old date; St. Brelade's Church, the oldest church in the island, and dating from the 12th century; the remains of an old chapel on whose site Prince's Tower was erected at the close of the last century; and Bel Royal, a cottage near St. Helier, where Charles II. is said to have concealed himself.

See, in addition to the works mentioned under CHANNEL ISLANDS, T. Lyte, *Sketch of the History and Present State of the Island of Jersey*, 1808; *History of the Island of Jersey*, 1840; Charles le Quesne, *A Constitutional History of Jersey*, 1856; François-Victor Dugo, *La Normandie Insoumise*, 1857; *Report of the Commission appointed to Enquire into the Civil, Municipal, and Ecclesiastical Laws of Jersey*, 1861; Le Hericher, *Jersey monumental et historique*, 1862; Le Cerf, *L'Archipel des Isles Normandes*, 1864; Lefevre, "Channel Islands," in the *Fortnightly* for October 1879; "L'Île de Jersey," in the *Expédateur* for 1876; Pegot-Ogier, *Histoire des Îles de la Manche*, 1881.

JERSEY CITY, the chief city of Hudson county in the State of New Jersey, U.S., is situated on the west bank of the Hudson, opposite New York, to which it stands in a

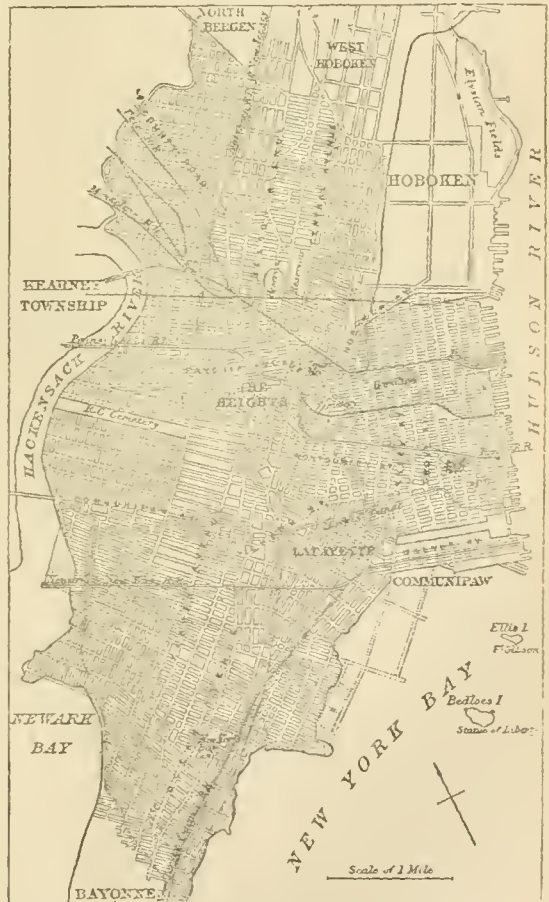

Plan of Jersey City.

relation similar to that of Birkenhead to Liverpool. It is laid out irregularly, owing to its being an aggregation of three formerly distinct municipalities. Many of the streets are broad and well paved, and the city is provided with efficient gas, water, and sewerage systems. It has few



striking buildings, the most prominent structures being the immense grain elevators near the river, three hospitals, an orphan's home, and the public school buildings, 21 in number. The public schools are supported by State and city taxes, and administered by a board of education. The trade of the city is very considerable; but, as it is embraced in the New York customs district, separate returns are not made. The fact that it is a terminus for three lines of ocean steamers, five trunk-lines of railways, seven lesser railways, and the Morris canal, greatly facilitates the transport of coal, iron, &c., and materially fosters its industries. Jersey City has iron-foundries, iron, steel, and zinc works, boiler yards, machine shops, railway plant

manufactories, tobacco factories, breweries, and other establishments which turn out watches, glass, crucibles, sugar, soap, candles, and a large variety of hardware and other articles. The extensive abattoirs at Long Dock are noteworthy for their excellent management. The "City of Jersey" was incorporated in 1829; but in 1851 it received another charter, under its present name. Its very rapid growth has been largely owing to its absorption of the townships and cities of Van Vorst in 1851, Hudson and Bergen in 1870, and Greenville in 1872. The population in 1850 was 6856; in 1870, 82,546; and in 1880, 120,722, making it the seventeenth city in point of population in the United States.

## J E R U S A L E M

**JERUSALEM** (Heb. יְרוּשָׁלַיִם, *Yerushalayim*, pronounced as a dual; but the old pronunciation seems to have been *Yerushalem*, whence, through the LXX., Ἱερουσαλὴμ, we have the common English form). The meaning of the name is obscure, none of the current interpretations, "vision of peace," "abode of peace," and the like, being free from difficulty. A later abbreviated form is יְרוּשָׁ, Salem (Ps. lxxvi. 2),<sup>1</sup> whence Σόλυμα, Solyma. The ordinary Greek and Latin forms are Ἱεροσόλυμα, Hierosolyma. Hadrian changed the name of the city to *Ælia Capitolina*, and *Ælia* long continued the official name, and even passed over into Arabic in the form *Ilīyā*. The Arabs, however, commonly designate Jerusalem by epithets expressive of its sanctity, *Beit el Makdis*, *El Mukaddas*, *El Mukaddis*,<sup>2</sup> or, in the modern vernacular, more briefly *El Kuds*, "the sanctuary."

### I. NATURAL TOPOGRAPHY AND RESULTS OF EXCAVATIONS.

The history of Jerusalem exploration dates from the year 1833, when Bonomi, Catherwood, and Arundale succeeded in obtaining admission into the Haram (Harām) enclosure and made the first survey of its buildings. In 1838 and 1852 the city was visited by the famous American traveller Dr Robinson, and his bold impeachment of the traditional topography, while raising a storm of controversy, laid the foundation of a truer understanding of the antiquities of Jerusalem. In 1849 Jerusalem was surveyed by Lieutenants Aldrich and Symonds of the Royal Engineers, and maps by Vandevelde, Thrupp, Barclay, and others were subsequently published. All these earlier attempts were, however, superseded in 1866 by the ordnance survey executed by Captain (now Colonel) Wilson, R.E., whose plans of the city and its environs, and of the Haram enclosure and other public buildings are the standard authorities on which all subsequent work has been based. During the years 1867-70 excavations of a most adventurous description were carried on by Captain (now Colonel) Warren, R.E. The results, especially in the vicinity of the Haram, were of primary importance, and many stoutly contested theories have now succumbed to the testimony of the spade. During 1872-75 some further explorations were carried on by Lieutenant Conder, R.E., while for many years a most valuable series of observations of the levels of the rock beneath the rubbish on which the modern city stands has been carried out by Mr C. Schick, architect.<sup>3</sup>

<sup>1</sup> Whether the narrator of Gen. xiv. 18 means Jerusalem by Salem, the city of Melchizedek, is still disputed, and the decision of the question is embarrassed by the uncertainty attaching to the date of his narrative. If the chapter is early, Salem can hardly mean Jerusalem, but many critics now assign to it a very late date.

<sup>2</sup> See Yāqūt, iv. 590; *Tāj el 'Arās*, iv. 214.

<sup>3</sup> See Zimmermann's *Karten und Pläne zur Top. d. alt. Jerus.*, based on Schick's measurements (Basel, 1876); *Quart. Stat. of P. E. F.*, 1880, p. 82.

The present account of the city is based on the results which have thus been obtained by actual exploration; but, although so much has been done during the last fifteen years to clear up disputed questions, much still remains to be accomplished.

The geographical situation of Jerusalem has now been determined by trigonometry to be 31° 46' 45" N. lat. and 35° 13' 25" E. long. of Greenwich (taken at the dome of the Holy Sepulchre church). The city stands at the extremity of a plateau which shelves down in a south-east direction from the watershed ridge of Judæa, which is here somewhat contorted. About a mile north of the town the ridge coming from the north is deflected towards the west at an elevation averaging 2600 feet above the Mediterranean, and thus passes clear of the city on its west side. From this ridge at the point of deflexion an important spur with steep and rugged eastern slopes runs out south-east for 1½ miles, and thence southwards for 1¼ miles more. The spur culminates in two principal summits, the most northerly 2725 feet above the sea, the second (now crowned with a village and a minaret) 2650 feet above the same level; and there is a third summit or knoll on the south terminating the spur and rising to an elevation of 2410 feet. To this chain (but more especially to the central summit with the minaret on it, now called *Jebel et Tûr*) the name *Olivet* applies. The plateau between this chain and the watershed ridge is drained by two flat open valley heads which form a junction about ½ mile north of the north-east angle of the modern city, and become a deep ravine with sides steep and in places precipitous, running immediately beneath and west of *Olivet* for a distance of 1½ miles from the junction to a well called *Bîr Eyûb*, where the bed is 1979 feet above the Mediterranean and 420 feet below the termination of the *Olivet* chain. This valley is the "brook" (*nahal* or *fumara*) *Kidron*, bounding the site of Jerusalem on the east: A second valley (*W.* or *Rabâby*) has its head in a shallow depression north-west of the city close to the watershed, whence it first runs south for about ½ mile, and then—rapidly deepening and flanked by low precipices—trends east for another ½ mile, joining the *Kidron* in an open plot close to the *Bîr Eyûb* above noticed. The second valley thus flanking Jerusalem on the west and south encloses an area half a mile wide and rudely quadrangular,—the seat of the city itself whether ancient or modern.

The site thus generally described—a natural fortress standing on spurs of hill surrounded on three sides by valleys 300 to 400 feet deep—is but imperfectly supplied with water. Only one spring exists anywhere near the city, namely, that in the *Kidron* valley, about 700 yards above the junction with the western ravine, now called the "spring with steps" (*Umm ed Derej*), or the "Virgin's spring." The vicinity of Jerusalem consists of strata of

the Eocene and Chalk formations, having a general dip down from the watershed of about 10° E.S.E. The action of denudation has left patches of the various strata, but generally speaking the oldest are on the west. The upper part of the Olivet chain consists of a soft white limestone, with fossils and flint bands belonging to the Upper Chalk; beneath this are—first, a hard silicious chalk, with flint bands; secondly, a soft white limestone, much used in the ancient buildings of the city; thirdly, a hard chalk, often pink and white in colour, and then known as Sta. Croce marble. The underlying beds belonging to the period of the Greensand are not visible, the lowest strata in the Kidron precipices belonging to the Lower Chalk epoch.

The actual position of the city at various times has differed but little in comparison with other capitals. The outline of the small spurs concerning which so many famous controversies have arisen is now much obscured by the accumulation of rubbish, which has been increasing ever since the time of Nehemiah (Neh. iv. 10). There is an average depth of from 30 to 40 feet of this debris throughout the town, and the foundations of the modern houses

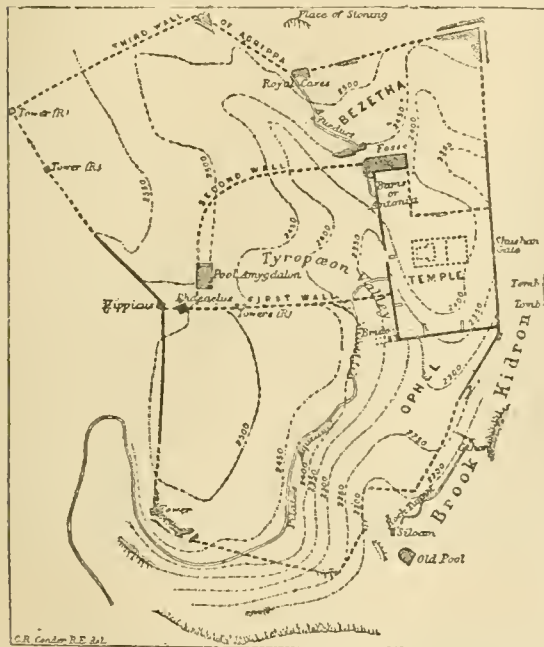

Contours of Ancient Jerusalem, with the line of the Walls, according to Lieut. Conder.

often stand upon it. In the valleys there is a depth of 70 feet, and east of the temple in one place shafts were sunk 120 feet before the rock was reached. The natural features of the ground, although unaltered and traceable to a practised eye, are thus less sharply accentuated than in the ancient period of the city's history. As, however, we have now more than two hundred and fifty actual observations of the rock levels in an area of 210 acres, there is no difficulty in recovering the general features of the ancient natural site of the town.

The quadrangle included between the two outer valleys above described is again split up by a valley, the Tyropæon of Josephus, which divides the plateau into two main spurs,—that on the east being the temple hill, that on the west the seat of the upper city. The Tyropæon is both shallower and broader than the boundary ravines already noticed, its depth averaging only from 100 to 150 feet below the crests of the ridges. Its real head is immediately outside the

present Damascus gate and the north wall of the modern city, whence it runs with a curved course southwards to join the Kidron just above the junction with the western boundary valley, a distance of about 1600 yards. There is, however, a second affluent or head of the central valley on the west side of its main course—a kind of dell or theatre-shaped depression extending westwards for more than 300 yards, and measuring not quite 200 yards north and south. Thus, while the eastern ridge is unbroken, the western is divided into two summits joined by a narrow saddle which separates the head of the broad central valley just described from the upper part of the western boundary valley.

Of the two western hill tops, that towards the south is the largest and most lofty. It has a trapezoid shape, and terminates on all sides in steep slopes, which are in places precipitous, and it is only joined to the watershed by the connecting saddle, which is scarcely 50 yards in width. This high southern hill measures 2000 feet north and south by about 1300 feet east and west. The highest part is towards the west, where the level of the flat broad summit is about 2520 feet above the Mediterranean. The smaller northern knoll or hill top, bounded on the east by the great central valley of Jerusalem, on the south by the theatre-shaped valley which separates it from the high southern hill, and on the west by a small subsidiary depression running north, rises to a summit not more than 2490 feet in elevation, or 30 feet below the flat top of the larger southern hill.

The eastern ridge, on which the temple stood, has a height towards the north of about 2500 feet; it then becomes narrower, and is artificially divided by a deep rock-cut trench running east and west. Its original form within the temple enclosure was that of a rounded top with a steep western slope and a more gentle gradient on the east, the level of the ridge falling from 2460 to 2300 feet in a length of about 500 yards. The end of this ridge is formed by a tongue of ground between the Kidron and the shallow central valley, falling rapidly in 400 yards to a level only 50 feet above the valley beds.

The identity of the present Haram (or sanctuary) with the ancient temple enclosure is undisputed, the only question which has arisen being whether the boundary walls now existing coincide with the outer ramparts of Herod's temple enclosure. The Haram is a quadrangle containing 35 acres, the interior surface roughly levelled, partly by filling up with earth the portions where the rock is lowest, partly by means of vaulted substructures of various ages. The most important results of Captain Warren's excavations were those connected with the exploration of the rampart walls, which measure 1601 feet on the west, 922 on south, 1530 on east, and 1042 feet on north, the south-west angle being 90° and the south-east 92° 30'. The height of the wall varies from 30 to 170 feet. On the west, on the south, and on the east for probably 1090 feet from the south-east corner, the masonry is all of one style, the stones being of great size with a marginal draft,—the imperfect finish of the faces in some of the lower courses apparently showing that the foundation-stones were never visible above the surface. The north part of the east wall consists, however, of masonry differing somewhat from the rest, the finish being rougher and the stone of inferior quality. It was found that this wall is continued for some distance beyond the north-east corner of the present area. The present north wall is of quite a different kind of masonry, and appears to be much more recent, the substructures immediately inside being only as old as the 12th century. The north-west angle is formed by a projecting scarp of rock measuring 350 feet east and west and 50 feet north and south, the height



above the interior court being about 30 feet. On this scarp the modern barracks stand, and a fosse 60 feet deep and 165 feet wide is still traceable outside the rock on the north. A valley bed 100 feet below the level of the Haram court ran across the north-east portion of the area into the Kidron; and south of this the remains of a scarp running east and west have been discovered, but are not as yet completely explored. The prolongation of this scarp eastwards cuts the east wall of the Haram at the point 1090 feet from the south angle, at which the change in the character of the masonry above explained probably occurs. The evidence thus obtained seems to indicate that an area of about  $7\frac{1}{2}$  acres has been added to the ancient enclosure on the north-east to give it the present quadrangular form, and the rougher masonry on the east appears to have belonged to the city wall constructed by Agrippa and not to the older wall of Herod's temple.

At the south-west angle of the Haram enclosure are the remains of an ancient arch (Robinson's arch), 42 feet span, belonging to a bridge across the Tyropœon, the west pier of which Captain Warren discovered, as well as the fallen voussoirs, lying on a pavement 40 feet beneath the surface, while under the pavement 20 feet lower was found the voussoir of a former bridge on the same site (*cf. Jos., B. J., i. 7, 2*). At the south-east angle of the enclosure Captain Warren found beneath the surface remains of an ancient wall of finely drafted masonry abutting on the east rampart of the Haram, and here some unexplained marks or letters in red paint were discovered on the lower stones. The buried wall runs southward for 250 yards at a height of 70 feet, and is held to be part of the wall of Ophel. The base of a great projecting tower was also laid bare, and identified by the discoverer with the tower of Neh. ii. 25. Another noticeable discovery was the fact that an ancient aqueduct is intersected by the west Haram wall, which must consequently be more recent than the rock tunnel thus destroyed.

The facts thus ascertained allow of the identification of the great walls still standing with those which supported the outer cloisters of the temple enclosure in the time of Herod's reconstruction of the edifice. The original area of Solomon's temple enclosure was doubled by Herod (*B. J., i. 21, 1*), who took away the ancient foundations and made a quadrangle extending from the fortress of Antonia to the royal cloister, to which a great bridge led from the upper city (*B. J., vi. 6, 2*), while the eastern limit was formed by the Kidron ravine, the Ophel wall joining the plateau of the temple at the south-east angle (*Ant., xv. 11, 5; B. J., v. 4, 2*).

The scarped rock at the north-west angle of the Haram, with its outer fosse dividing the temple hill from Bezetha, answers exactly to the description by Josephus of 'the tower of Antonia' (*B. J., v. 5, 8*) and thus serves to identify the north-west angle of the ancient enclosure with the corresponding angle of the modern Haram. The correspondence of the south-west angles of the two areas is established by the discovery of the great bridge, and that of the south-east angles of the same by the exploration of the Ophel wall. The northern boundary of Herod's temple probably coincided with the scarp already described, 1090 feet north of the south-east angle. The area was thus, roughly speaking, a quadrangle of 1000 feet side, from which the citadel of Antonia, as described by Josephus, projected on the north-west (*cf. B. J., vi. 5, 4*).

The natural water-supply of Jerusalem is from the Virgin's spring already noticed, which comes out from beneath the Ophel ridge in a rocky cave extending 12 feet from the face of the hill, and reached by flights of twenty-eight steps. The water flows with an intermittent action, rising from beneath the lowest steps, at intervals varying,

according to the season and the rainfall, from a few hours to one or even two days.

From this spring a rock-cut tunnel 1708 feet in length leads through the Ophel ridge to the Pool of Siloam (now *Birket Silwân*), which is a rock-cut reservoir with masonry retaining-walls measuring 52 feet by 18 feet, having a rock-cut channel leading away from it to a larger pool formed by damming up the flat valley bed with a thick wall of masonry close to the junction of the Kidron and the Tyropœon.<sup>1</sup> A rock-cut shaft—like the great tunnel a work of immense labour—leads from the spring westwards to an entrance from the surface of the ground 120 feet above and 180 feet west of the spring. The rock tunnel was known in the 17th century, but the shaft which formed a secret entrance to the one spring of Jerusalem was discovered by Captain Warren. The water of Siloam was originally sweet, but has been fouled and made bitter since the 12th century. From the reservoir it runs southwards to the *Bir Eyûb* already noticed, a well 125 feet deep.

The remaining reservoirs of Jerusalem are fed by aqueducts and by the rains. West of the city is the rock-cut Mamilla pool. In the upper part of the valley of Hinnom is *Birket es Sultân*, constructed in the 12th century. Since the 14th century these two tanks have been erroneously named the Upper and Lower Pools of Gihon. Inside the city is the Patriarch's Pool near the west (the ancient Amygdalon or "Tower Pool," *B. J., v. 11, 4*), while immediately north of the Haram are the Twin Pools made by roofing in part of the ancient fosse, and the *Birket Isrâîl*, measuring 360 by 130 feet, and apparently constructed after the great destruction of 70 A.D.

The Twin Pools were identified in the 4th century with Bethesda, but since the 12th that name has been given to the *Birket Isrâîl*. The site of Bethesda is still doubtful.

Three aqueducts supplied the city, one of which, constructed by Pilate (*Ant., xviii. 3, 2*), led from the so-called pools of Solomon, 7 miles distant, to the temple, and still conveys water when in repair. Its course appears on the map; the second from the same locality probably fed the *Birket Mamilla*, but is now lost; the third from the north collected surface drainage and led to the temple enclosure underground, a distance of 2000 feet only. The great reservoirs in this enclosure, about thirty in number, were capable of holding a total supply of 10 million gallons of water. (C. L. C.)

## II. ANCIENT JERUSALEM.

Up to the time of David the strong fortress of Jerusalem remained in the hands of the ancient Canaanite inhabitants who were known as Jebusites.<sup>2</sup>

The city was deemed impregnable, but its conquest was one of the first exploits of David, when he became king of all Israel, and had need of a capital that should serve as a base for his military operations and a centre of union for Judah and Israel. Lying on the frontier line between his own tribe of Judah and the difficult country of Benjamin, which had been the centre of the struggle with the Philistines since the fall of Shiloh, Jerusalem was admirably adapted for these purposes. The Jebusites were not expelled, but continued to live side by side with the Hebrews (*Josh. xv. 63; Judg. i. 21; 2 Sam. xxiv. 18;*

<sup>1</sup> A very ancient Hebrew inscription, referring to the construction of the tunnel, was discovered in June 1880. The date and many points in the reading and interpretation are still obscure.

<sup>2</sup> In *Judg. xix. 10, 1 Chron. xi. 4*, the city itself is called Jebus; but in this part of the Book of Judges (as well as *Josh. xv. 8, xviii. 28*) it is probably of late date, and the older records use the name Jerusalem. It is not safe to regard Jebus as the earliest name of the city. The reference to Jerusalem in *Judg. v. 7* seems to be an interpolation, and *Josh. xv. 63, Judg. i. 21* to refer to the time after David.

Zech. ix. 7). David himself occupied "the mountain fortress (הַר צִיּוֹן) of Zion," which was strengthened by new walls and received the name of the city of David. Here a palace was built by Tyrian architects, and the new capital was consecrated by the removal to it of the ark.

The site of the city of David forms the fundamental question of Jerusalem topography. The current traditional view (but not that of the most ancient tradition even in the Christian church) makes Zion the southern eminence of the western hill, and places David's fortress there. More recently Messrs Warren and Conder have contended that the city of David is identical with the Acra of Josephus, and place the latter on the northern summit of the western hill, between the two branches of the Tyropœon (see below). A third view places the city of David on the southern part of the Temple hill; and this opinion is not only conformed to the oldest post-Biblical tradition (1 Maccabees, Jerome, &c.), in which Zion certainly means the Temple hill, but is the only view that does justice to the language of the Old Testament.

It is necessary at the outset to clear away the popular idea that the capital of David was already a great town, occupying a site comparable in extent with that of the later city. Certainly if all the Levites and sacred ministers mentioned in Chronicles were actually assembled at Zion in David's time, we might conclude that the town was already a capital on a grand scale. But the Chronicler constantly carries back later institutions into primitive times, and the early history, which alone can be viewed as a safe guide, gives quite another picture. Zion was merely one of the "mountain fortresses" found all over Palestine as places of refuge in time of invasion, and was garrisoned by a handful of mercenaries (the *Gibborim*). The whole levy of Israel in David's time was but 30,000 men (2 Sam. vi. 1; comp. the 40,000 of Judg. v. 8), and before the development of trade among the Hebrews Jerusalem had not the natural conditions for the growth of a great city. In the first instance the town doubtless consisted mainly of the court and its dependants, with the Jebusite population, who must have been predominantly agricultural and limited in number by the limitation of their territory. Now it is quite incredible that the Temple hill was ever excluded from Zion. Throughout the Old Testament Zion appears as the holy mountain, the seat of the sanctuary. It is true at the same time that Zion and the site of Jerusalem are interchangeable ideas in Hebrew literature; but this only proves that the mountain of the sanctuary was essentially the mountain on which the city stood.<sup>1</sup> Further, it is clear from 1 Kings viii. 1 sq., 2 Sam. xxiv. 18, that the temple stood above the city of David, as elsewhere in Hebrew holy places the sanctuary crowned the hill on whose slopes the town stood. Moreover, the graves of the kings, which were certainly in the city of David, encroached on the temple enclosure (Ezek. xliv. 7, 8), which indeed at the time of the captivity was closely built up (*ibid.*), and stood in the middle of the city (Ezek. xi. 23). Again, Micah iv. 8 identifies the ancient "tower of the flock," the original seat of the kingdom, at Jerusalem, with "Ophel of the daughter of Zion." But Ophel is one of the few topographical names that can be traced down to the time of Josephus, whose description shows that it lay to the south-east of the temple. Still more precise is the determination given by references to the one fountain of Jerusalem, which, as we have seen, springs out under the temple hill on the east. According to Neh. iii. 15, xii. 37, the city of David was reached by a stair in the

vicinity of the fountain gate and the pool of Siloah.<sup>2</sup> This ascent led up above David's palace to the water gate, where in Nehemiah's time there was an open space in front of the temple (comp. Neh. viii. 1, 16 with Ezra x. 9). Thus we see that David's palace lay between the temple and the pool of Siloah or King's pool (Neh. ii. 14). These notices are the more important because the water system connected with the Virgin's spring forms almost the only quite certain part of Jerusalem's topography. The spring itself is Gihon, which from its name must have been a true spring, while 2 Chron. xxxiii. 14 teaches us to look for it in the Kidron valley (גִּיחֹן). The subterranean conduit which still exists had for its object to conduct the water inside the city, and appears to be that constructed by Hezekiah (2 Kings xx. 20). In Isa. xxiii. 8, 11 we read of a lower pool and an old pool (no doubt identical with the upper pool, Isa. vii. 3; 2 Kings xviii. 17), whose waters were collected in the time of Hezekiah, under apprehension of siege, in a reservoir between the two walls. From this passage, compared with Neh. iii. 15, we gather that Hezekiah's pool was protected by an outer line of fortification, and here lay the gate of the two walls (2 Kings xxv. 4), with the royal gardens beside them. The supplementary notices of the conduit and the outer wall, given in Chronicles, have not the weight of contemporary history, but they show the writer to have still possessed the same tradition as to the place of the city of David, for he describes its outer wall as running along the Kidron valley west of Gihon (*i.e.*, so as to leave the fountain outside, 2 Chron. xxxiii. 14; comp. xxxii. 3, 4), and tells us that Hezekiah's conduit brought the water of Gihon in a westerly direction to the city of David (chap. xxxii. 30).

According to the Bible, then, the city of David lay on the southern part of the hill which his son crowned with the temple.<sup>3</sup> The chief feature in the fortifications was a tower named Millo, perhaps on the site of the modern barracks, protecting the approach to Zion from the north. The town had but little splendour. The king occupied a wooden palace, the work of foreign craftsmen, and the ark still dwelt in curtains. Under Solomon, who had the true Oriental passion for building and luxury, and squandered enormous sums on his court, great improvements were made, especially by the erection of the twin palaces "the house of Jehovah and the house of the king," constructed of stonework strengthened by string courses of wooden beams in the still familiar style of Arabian building. The palace, which took nearly twice as long to erect as the temple, consisted of a great complex of buildings and porticos, including the porch of judgment, an armoury, and the palace of the queen.

The site of the palace has been variously assigned by topographers. But it lay above the old residence of David<sup>4</sup> (1 Kings ix. 24), and all the indications given in the Old Testament lead us to place it quite close to the temple, with which its porticos seem to have been connected (2 Kings xvi. 18; xxxiii. 11). Wellhausen indeed, from an examination of 1 Kings vi. vii., has made it probable that the royal buildings lay within the outer court of the temple (Well-Bleek, *Eint.*, p. 232). The clearest details are connected with a court of the palace called the prison court (Jer. xxxii. 2), where there was a gate called the prison gate, and a great projecting tower (Neh. iii. 25-27). This part of the building must have been close to the temple, for it was at the prison gate that the second choir in the

<sup>2</sup> The fountain gate is the gate beside Siloah, which is itself called the fountain (מִקְוֵה) by Josephus (*B. J.*, v. 4, 1).

<sup>3</sup> The statements of Josephus as to the topography of the city of David and Solomon are of no independent value. He possessed no sources except the Old Testament.

<sup>4</sup> So in Neh. iii. 25 it is called the upper palace in distinction from the house of David, chap. xii. 37.

<sup>1</sup> The explanatory note of an editor in 1 Kings viii. 1, "the city of David, which is Zion," cannot be strained to mean that the removal of the ark from the city of David to the temple was its removal from the mountain of Zion to another hill.



procession of Neh. xii. halted and stood "in the house of God," meeting the other choir, which ascended from Siloah by the stair above David's house and reached the temple at the water gate. It appears further from Neh. iii. 27 that the fortifications of the prison were adjacent to Ophel, so that the palace seems to have stood about the south-east corner of the temple area.<sup>1</sup>

After the division of the kingdoms Jerusalem was shorn of its political glory. The city itself was taken by Shishak in the reign of Rehoboam, and lost the riches accumulated by Solomon. The great houses of Omri and Jehu quite overshadowed the kingdom of Judah, which forgot its weakness in the reign of Amaziah only to receive signal chastisement from Jehoash, who took Jerusalem, and partly levelled the walls (2 Kings xiv.). The decline and fall of Samaria raised the relative importance of the southern capital; the writings of the prophets show that wealth had accumulated and luxury increased, and so we find King Jotham adding an upper gate in the northern or higher court of the temple (2 Kings xv. 35; Jer. xxxvi. 10; Ezek. ix. 2), while Hezekiah, as we have already seen, laboured for the improvement of the water supply, and so rendered the city more capable to resist siege. The later history in Chronicles adds details of fortifications erected by Uzziah and Manasseh, which probably express the oral tradition current in the author's day. In the later days of the monarchy Jerusalem had so far increased that we read of a second town or quarter (2 Kings xxii. 14; Zeph. i. 10, Heb.; comp. Neh. iii. 9). There was also a trading quarter called the Maktesh, inhabited by Canaanites or Tyrians (Zeph. i. 11), who still formed a large part of the mercantile population after the exile (Neh. xiii.; Zech. xiv. 21). Maktesh means *mortar*, so that we must suppose the traders to have lived in a hollow valley, perhaps the upper part of the Tyropœon. But the main part of the town was still grouped round the temple plateau, from which steep streets ran down the slope of the hill (Lam. iv. 1), the houses rising tier above tier, so that the roof tops commanded a view of the environs (Isa. xxii.). According to Eastern custom the handicrafts—*e.g.*, the bakers, Jer. xxxvii. 21—had their own streets or bazaars.

For the compass of the walls of Jerusalem at the time of its capture by Nebuchadnezzar the chief document is the account of the restoration of the fortifications by Nehemiah, who followed the old line, and speaks of the various gates and towers by their old names. His description presents many difficulties, the most intelligible part being that which deals with the eastern wall, from Siloah and the fountain gate to the point where the temple and the palace joined one another. The western boundary of the city is particularly obscure, and its position must be mainly determined by reference to the "valley gate" (Neh. ii. 13; iii. 13). The valley (*gay*) is used as a proper name, and is no doubt identical with the valley (*gayy*) of the son of Hinnom, the Kidron valley being always called *nahal* *i.e.*, *fumara*. The common opinion makes this *gay* the valley to the west of modern Jerusalem (Wady er Rababy), in which case the valley gate must necessarily have occupied much the same position as the modern Jaffa gate, and the whole of the later upper city on the south-west hill must already have been included within the walls. This view, however, is far from indisputable. A thousand cubits south of the valley gate was the dung gate, the gate before which the rubbish heaps of the city lay. This on the common theory must have been about the south-west corner

of the hill, near the present Protestant school. Between this point and the fountain gate in the vicinity of the pool of Siloah is nearly half a mile in a straight line, and the intervening wall must have been much longer if it followed the natural line of defence. Yet Nehemiah gives no account of this section of the ramparts (Neh. iii. 14, 15). His record seems to imply that the fountain gate was near the dung gate; and similarly in chap. xii. the procession which went southward to the dung gate is immediately afterwards found at the fountain gate. It is hardly possible that so important a part of the circuit should be twice omitted, and in fact the vast lacuna disappears at once if we suppose that the *gay* is the Tyropœon, and that the upper city of Josephus on the south-west hill was not enclosed in the circuit of Nehemiah's walls. In that case the valley gate lay on the Tyropœon, somewhere near the south-east angle of the Haram area, and the wall ran southward along the east side of the valley, till at the pool of Siloah an outwork was thrown out to protect the water supply.

Besides simplifying the topographical difficulties of Neh. iii., this view has several other advantages. On the received view the Tyropœon is nowhere mentioned in Scripture, though it lay in the heart of the city. This difficulty is removed by the view above suggested, and the third valley (W. er Rababy) appears to be quite out of relation to the circuit of the Biblical Jerusalem, so that one does not look for much mention of it. Again, we have seen that the Canaanite quarter of the city lay in a hollow—presumably in the Tyropœon, and it is very natural that the seat of Canaanite worship in the valley of Hinnom should be in the vicinity of this quarter. Once more, by placing the valley gate quite near the temple, we understand how it was in this neighbourhood that the sacred procession in Neh. xii. began its course. Even at a much later date the Temple hill was the real stronghold of Jerusalem, which Judas and his successors were concerned to fortify with walls. It would have been folly in Nehemiah to enclose a much vaster and less defensible circuit when the inhabitants were so few that it was necessary to draft one-tenth of the whole people into the capital (Neh. xi. 1).

The course of the wall north of the valley gate must still have skirted the base of the Temple hill east of the Tyropœon. It is not improbable that the Maktesh or Canaanite trading quarter lay outside the fortifications, a bazaar beyond the gate being a common feature in Eastern towns.<sup>2</sup> From the tower of furnaces or ovens the "broad wall" ran to the point where in the Persian time the governor of the Syrian provinces had his throne. The throne would stand in an open place by a gateway, and comparison of Neh. iii. 7 with xii. 39 shows that the gate must have been that of Ephraim, *i.e.*, the gate of the main road leading to the north, which then as now must almost of necessity have followed the upper course of the Tyropœon, and so would skirt the walls for some distance before entering the city. In fact there were 400 cubits between the gate of Ephraim and the corner gate (2 Kings xiv. 13). The corner gate is also named the first gate (Zech. xiv. 10), and so is probably identical with the old gate of Nehemiah. For obvious engineering reasons the eminence at the north-west of the Haram area must always have been a principal point in the fortifications, and here the old gate may very well be placed. It is indeed very likely that this was the site of the ancient bastion of Millo. From the corner gate the north line of the wall ran by the fish gate to the towers of Meah and Hananeel, the latter of which appears in Zech., *loc. cit.*, as the opposite extremity of the city from the royal wine vats in the gardens by Siloah, while in Jer. xxxi. 38 the line between it and the corner gate is named as the natural direction of extension for the city. The tower, therefore, must have stood very near the north-east corner of the wall, but not so far east as the angle of the Haram area, which is here built out, disguising the natural line of the hill side. From Zech., *loc. cit.*, we see that the Benjamin gate was at the east end of the north wall. There was a road into Benjaminite territory over the Kidron (1 Kings ii. 37), and to this there was a natural descent by a small valley now nearly obliterated, having its head a little south of the Birket Israil. Here too is the direct way to Anathoth, which was through the Benjamin gate (Jer. xxxvii. 13). In Nehemiah's record the sheep gate seems to have the same position. From the angle near the tower of Hananeel and the Benjamin gate the line of the hill runs southwards, trending to the east. At the extreme east point, beyond the present line of wall, and a little south of the modern

<sup>1</sup> Another view is that Solomon's palace stood on the western hill, and was connected with the temple by a bridge. But "the ascent" of the A. V. of 1 Kings x. 5 does not exist in the original, and seems to rest on a false reading in Chronicles. In Ezek. xlv. the sovereign enters the temple from the east.

<sup>2</sup> In fact at the siege of Titus the wool and clothes market and the brassworkers' bazaar still lay in much the same quarter, in the new city, outside the old line of fortification, though within the second wall (*B. J.*, v. 8, 1).









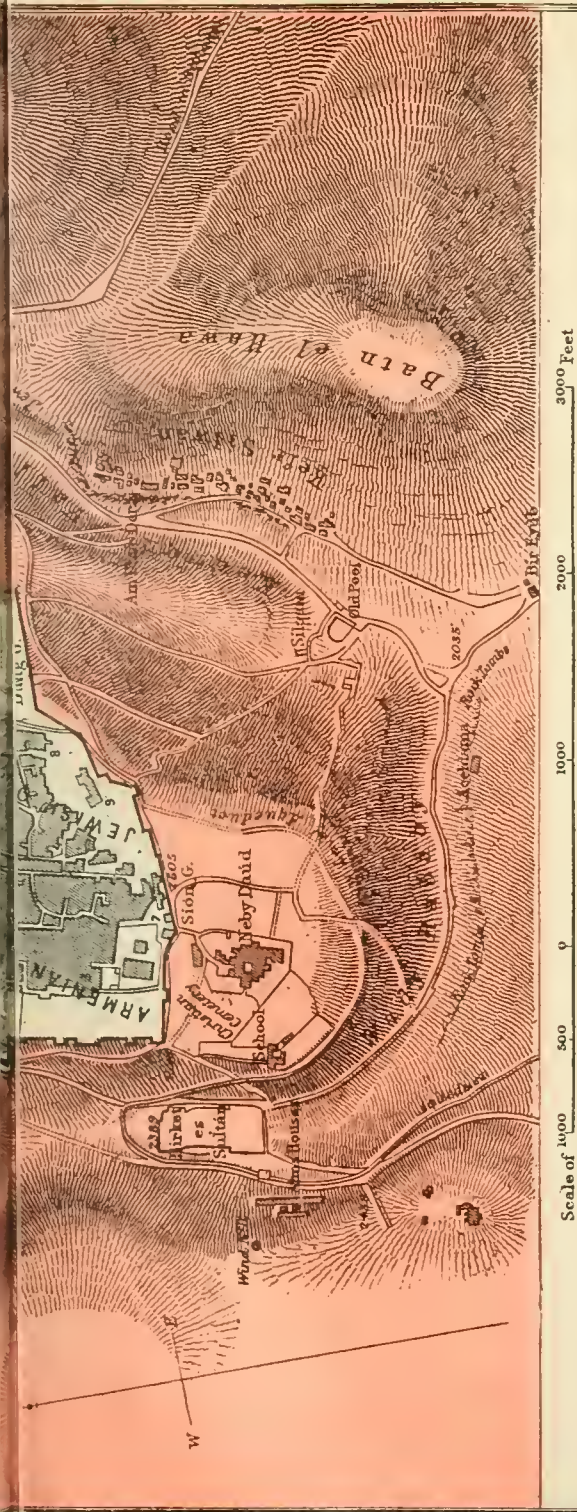

### Ground plan of Modern Jerusalem

- |                       |                    |                      |                             |
|-----------------------|--------------------|----------------------|-----------------------------|
| 1 Tower of David      | 7 Lepers' Huts     | 13 Old Serai         | 19 Chapel of Flagellation   |
| 2 Protestant Church   | 8 Jewish Hospital  | 14 New Serai         | 20 Ecce Homo Arch           |
| 3 Church of St. James | 9 " Hospice        | 15 Waiting Place     | 21 Madelene Church (ruined) |
| 4 Latin Cathedral     | 10 Tyropean Bridge | 16 Austrian Hospice  | 22 German Hospice           |
| 5 " Patriarchate      | 11 Double Gate     | 17 British Consulate | 23 Damascus Hotel           |
| 6 Mediterranean Hotel | 12 Triple Gate     | 18 Sisters of Sion   | 24 Bab ez Zuhrah            |





golden gate, must be placed the horse gate (Jer. xxxi. 40). South of this again came the fortifications of Ophel and the upper palace, and from this point the enceinte swept round to the pool of Siloah. The lower wall of Manasseh in 2 Chron. xxxiii. 14 is described as an outwork in the Kidron valley extending all along the eastern side of the town and round the north-east corner.

The long blank in the history of the Jews which follows the time of Nehemiah makes it impossible to trace the progress of Jerusalem in any detail. Under the Persian empire the Jews enjoyed little prosperity. Alexander spared the city, but in 320 its walls were rased by Ptolemy I. (Appian, *Syr.*, 50). A period of comparative prosperity followed, culminating in the high priesthood of Simon II (219-199 B.C.), who repaired the temple and strengthened its defences and fortified the city. The walls were again destroyed and the city burned by the army of Antiochus Epiphanes in 168 B.C. When Judas Maccabeus reconsecrated the temple (165) he also fortified the holy mountain of Zion (the Temple hill) with wall and towers. Once more rased by the Greeks, the walls of the city were renewed with hewn stone by Jonathan.

It is plain from 1 Macc. iv. 60, vi. 7, x. 11, that up to this time the fortified city was still identical with the Temple hill; but a new topographical problem is raised by what is related of the citadel (Akra) erected by Epiphanes to dominate the town. The Akra is identified by the author with the city of David. It continued to be held by the Greeks after the town was fortified by the Maccabees, and indeed was ultimately reduced by the erection of a special wall cutting off the Greek garrison from access to the city and market (xii. 36). The natural inference from all this is that the Greek citadel lay on the Temple hill, and presumably on the site of the later Antonia. That hill is certainly the Zion of 1 Macc.; and the city of David, with which the Akra is identified, had always meant the fortress of Zion. The same result seems to follow from the language of Josephus. When Josephus lived Jerusalem was almost a new town. Under the Maccabees, and again under Herod, the prosperity of the Jews was greater than at any previous time. The sanctuary was a centre of pilgrimage from the most distant lands, and the sovereigns of Jerusalem had an empire greater than any of the kings after Solomon. The growth of the city must have been enormous, and the great buildings of Herod and his successors had wholly changed its aspect, especially in the quarter of the temple and on the western hill where the royal palace stood. These changes were very apt to mislead an uncritical writer with regard to the ancient topography, and in fact Josephus falls into a radical blunder by assuming that the fortress of David belonged to the upper city, like the royal castle of his own day,<sup>1</sup> and that the western hill had always been part of Jerusalem. But of Jerusalem as he himself saw it he gives a vivid description (*B. J.*, v. 4, 1). The city stood on two hills divided by the Tyropœon valley, into which the houses descended tier beneath tier. The higher western hill was called the upper market, the lower hill across the Tyropœon was the citadel hill, and was called indifferently the Akra or the lower city. That this Akra included the ridge south of the temple is clear from several marks: the hill was ἀμφικύρτος, "hog-backed"; it was cut off by ravines on the outer side, and had a continuous approach to the temple, which stood on the higher ground; finally, it extended to Siloah at the mouth of the Tyropœon.<sup>2</sup> Thus we see that, though Josephus himself has lost the true tradition as to the city of David, he furnishes additional proof that the citadel hill, still identified with it by the author of 1 Macc., was no other than the eastern hill.

A different view of the Akra was maintained by Robinson, and has been elaborated by Messrs Warren and Conder<sup>3</sup> in connexion with recent better observations as to the two heads of the Tyropœon valley. It is maintained that the Akra was a knoll, west of the Temple hill and north of the traditional Zion, between the two heads of the Tyropœon. To gain any show of plausibility for this view it is necessary to lay great weight on a statement of Josephus that the Temple hill was once a third eminence lower than the Akra, and divided from it by a broad ravine, and that Simon after taking the Akra destroyed the citadel and laboured for three years to reduce its site below the level of the temple plateau and fill up the intervening hollow (*B. J.*, v. 4; *Ant.*, xiii. 6, 6). This story is pro-

bably exaggerated, for according to the early and trustworthy evidence of 1 Macc. xiii. the Akra was not destroyed, but only purged, and strengthened by additional fortifications on the sacred mountain. And in any case we know that the Akra was opposite the temple, and that in the time of Josephus there was no longer a ravine between, whereas the city opposite the temple to the west was still cut off by the deep Tyropœon (*Ant.*, xv. 11, 5), except where a bridge led to the palace on the western hill. Nor is it possible that the western head of the Tyropœon can be the deep ravine which, according to Josephus, separated the upper and lower city, for that head is the theatre-shaped basin described in *Ant.*, xv. 11, 5 as facing the temple across the ravine.

Under the Hasmonean dynasty we meet with the first unambiguous evidence that the city had extended to the loftier western hill, where a new palace was erected overlooking the temple (*Ant.*, xx. 8, 11). This continued to be the royal quarter, and was raised to great splendour by Herod, who covered a vast extent of ground with his palace, its courts and pleasure grounds. The palace of Herod embraced two edifices transcending the temple in magnificence, and the three enormous adjoining towers, Hippicus, Phasael, and Mariamne, made the upper city the strongest part of Jerusalem. Here also in Herod's days stood the xystus or gymnasium, beneath the Hasmonean palace, where a bridge spanned the Tyropœon. The bridge already existed under the later Hasmonæans, when the new quarter had as yet minor importance and the Temple hill was still the only citadel. Here the warlike high priest Hyrcanus usually dwelt in the castle (*Bâpis*, בריה) which Herod afterwards converted into the fortress of Antonia in the north-west corner of the enceinte of the temple (*Ant.*, xv. 11, 4; *B. J.*, v. 5, 8). Antonia had the form of a square keep, with loftier towers rising pinnacle-like at the corners. It commanded the temple and therefore the whole lower city, and by its two staircases the Roman soldiers descended into the porticoes of the temple to keep order among the worshippers (comp. Acts xxi. 35).

When Pompey besieged the Temple hill in 65 B.C., the bridge was broken down, and the Tyropœon afforded a complete defence on the west. His assault was made from the north, where there was a strong wall with towers and a deep fosse which was with difficulty filled up to permit the advance of his siege train. This fosse must be identified with the rock cut trench north of the Haram area, and from Josephus's description seems to have been still the northern limit of the town. The walls destroyed by Pompey were restored by Antipater, and ten years later yielded, after an obstinate resistance, to Herod and the Romans (37 B.C.). The Baris, occupied by Antigonus, was not surrendered till the temple and the rest of the city had been carried by storm, and we now read of two walls which had to be reduced successively.

The most important buildings erected by Herod have already been alluded to, and his reconstruction of the temple will be considered under that heading. But the walls of the city as they existed at the time of the siege by Titus must still be described. They were three in number. The first wall consisted of a rampart to the north of Herod's palace, connecting Hippicus in the citadel of the upper city with the western porch of the temple, and of another line skirting the face of the western hill from Hippicus southward, thence curving round beyond Siloah, and joining the eastern wall of the temple enclosure at Ophel. Several traces of this wall still exist. The second wall, connecting a point in the northern line of the first wall with Antonia, enclosed the new town or trading quarter. Outside both these walls, on the hill side sloping southwards towards the temple, a suburb called Bezetha had grown up, which Agrippa I. in the time of Claudius Cæsar began to protect with a third wall conceived on a gigantic scale, but never altogether finished. The precise compass of this wall, which began at Hippicus and rejoined the first wall in the

<sup>1</sup> A perpetuation of this blunder gives the current name Tower of David to the Herodian tower, probably Phasael, which still stands by the Jaffa gate. On this tower compare a paper by Schick in *Zeitschr. d. Deut. Palästina-Vereins*, vol. i.

<sup>2</sup> *B. J.*, vi. 7, 2; comp. v. 4, 1, and the association of Siloah and the Akra in v. 6, 1.

<sup>3</sup> See Warren, *The Temple or the Tomb*, London, 1880; and Conder, *Tent Work in Palestine*, London, 1878, vol. i.



Kidron valley, has been much disputed,—the great tower of Psephinus, which stood on very high ground, and formed its north-west angle, being supposed by some to have stood near the modern castle of Goliath (Kaṣr Jalūd), while others place it as far north as the Russian cathedral. The measurements by which it has been proposed to decide the northern limits of Jerusalem are the distance of 3 stadia from the city to the tomb of Queen Helena of Adiabene (commonly identified with the Tombs of the Kings, *Kub̄r es Salāṭin*), and the circuit of 33 stadia assigned by Josephus to the whole city. These measurements would seem to imply that the ancient city stretched further north than the modern walls, but they can hardly claim to be taken as mathematically accurate; the estimates of the compass of the city vary, and Eusebius places it at 27 stadia. This again would imply a line closely coincident with the north wall of the modern town, agreeing with the remains of ancient scarping still visible, and with the express statement of Josephus that the line of the third wall passed through the royal caves, *i.e.*, the catacombs, or the cotton grotto and grotto of Jeremiah, which are separated by a kind of fosse cut through the live rock, and manifestly forming part of the old wall line.<sup>1</sup> In the siege under Titus the Romans successively carried the third and second walls. They then occupied Antonia, which was levelled to facilitate the approach of the forces for the attack on the temple stronghold. The temple was opened by fire rather than force, and, the Jewish leaders having retired to the upper city, the lower town from the temple to Siloah was burned by the Romans. The capture of the upper city was effected by a regular approach with mounds and battering rams (September 70 A.D.), and even then the huge citadel of Herod could only have yielded to famine had it not been abandoned by the Jewish leaders in a vain attempt at escape. Its three great towers, with a portion of the western wall, were left as a memorial, and of this group the so-called tower of David (Phasael) still stands.

The rebuilding of Jerusalem by Hadrian seems to have been originally conceived in a spirit friendly to the Jews, and there is even some evidence that the restoration of the temple was contemplated or commenced. After the great revolt, however, *Ælia Capitolina* was transformed into a purely pagan town with seven quarters and many buildings of heathen fashion.<sup>2</sup> The spread of Christianity and the rise of the practice of pilgrimage gave a new importance to the city of the crucifixion and resurrection, and in the time of Constantine the discovery of the Holy Sepulchre and the erection of the magnificent church of the Anastasis (dedicated 336 A.D.) again made Jerusalem a great religious centre. In the pagan reaction under Julian an attempt was made to rebuild the temple, but was frustrated by an outburst of fire from the foundations (362). The unfortunate empress Eudocia spent her last years at Jerusalem (c. 350–360), repaired the walls, built the church of St Stephen, founded monasteries and hospitals, and enriched the churches. The next great builder was Justinian, part of whose splendid church of St Mary perhaps still remains in or to the east of the mosque El-Akṣa. In 614 Jerusalem was taken by Chosroes, and the churches and sepulchre were burned, but the patriarch Modestus restored them as soon as the Persians retired. In 637 Jerusalem capitulated to the caliph Omar, who gave directions for the erection of a place of worship on the site of the “remotest shrine,” *i.e.*, the temple, to which Mahomet, according to Kor. xvii. 1, was transported from Mecca in his famous night journey. From this verse the great sanctuary of Jerusalem received the name El-

Akṣa, now generally confined to the building at the south end of the Haram. The original mosque as described by Arculfus (670) was a rude edifice of wood capable of containing 3000 worshippers; but soon after the sanctuary was reconstructed in a style of great magnificence by the caliph ‘Abd el Malik, whose date (72 A.H. = 691 A.D.) is still read on a Cufic inscription on the Dome of the Rock, though the name of the caliph seems to have been changed to that of El-Mamūn, who restored the buildings after a great earthquake, which, according to Mokaddasy left nothing standing except the part around the *mihrāb* or niche indicating the direction of Mecca. In their present condition the buildings of the sanctuary show features of very various styles from the Byzantine downwards. The architectural problems which they suggest are closely connected with controversies as to the topography of the temple and the true site of the Holy Sepulchre, both of which subjects will be more conveniently discussed under TEMPLE. Apart from the question of the holy sites, the later topography of Jerusalem presents no feature that need detain us, and the subsequent fortunes of the city belong to the general history of Palestine and the crusades. (W. R. S.)

### III. MODERN JERUSALEM.

It appears probable that the crusading wall ran Plate X. just outside the present one on the north-west side of the town—the remains of mediæval masonry existing all along this line. In 1192 Saladin fortified the same quarter with a second wall and a fosse, and, as remains of an interior wall are still traceable at the ruined tower called *Kal'at Jalūd*, it appears that the two ramparts must have run about 60 yards apart on this side of the town. Dismantled in 1219 and restored again in 1229, the fortifications were again destroyed in 1239, and the present walls were built in 1542 by Suleimān the Magnificent, as witnessed by inscriptions over the present Jaffa and other gates. The following is a conspectus of the gates at different times in consecutive order:—

Modern Name.	Twelfth Century.	Fourth to Eighth Centuries.	Position.
1. St Stephen's Gate, <i>Bāb Sitti Marjām</i> .....	Gate of Valley of Jehoshaphat.....	Gate of Valley of Jehoshaphat.....	E. wall.
2. Herod's Gate, <i>Bāb ez Zahrāh</i> .....	Postern of the Magdalen.....	Gate of Benjamin.....	N. "
3. Damascus Gate, <i>Bāb el 'Amūd</i> .....	St Stephen's Gate.....	Gate of Galilee.....	N. "
4.	Postern of St Lazarus, <i>Bāb es Sūb</i> .....	Gate of Fuller's Field Gate of Judgment.....	N. "
5. Jaffa Gate, <i>Bāb el K'nā'il</i> .....	Gate of David.....	Gate of David.....	W. "
6. Sion Gate, <i>Bāb Nēy Dāūd</i> .....	Sion Gate.....	Sion Gate.....	S. "
7. Dung Gate, <i>Bāb el Mughāribeh</i> .....	Postern of Tannery.....	Gate of Tekoa.....	S. "
8. Golden Gate, <i>Bāb el Dahriyeh</i> .....	Golden Gate.....		E. "

In 680 the city had eighty-four towers. In the 12th century the two principal ones were—first, Tancred's tower on the north-west, the present *Kal'at Jalūd* (Goliath's castle), where remains of a mediæval square tower of 80 feet side still exist, and, second, David's tower, still so called (the ancient Phasaelus), forming part of the castle of the Pisans, as the present citadel was called in the 16th century.

The walls of the modern city enclose an area of 210 acres, the greater part thickly crowded with houses, although on the north-east and south there are plots of ground near the ramparts not occupied by buildings. The houses are of stone, with flat stone roofs having small domes supported on arches in the middle, and the aspect of the city is specially colourless and stony. The streets are only narrow lanes running at right angles to one another. The principal streets are the same as in the 12th century, and

<sup>1</sup> The eminence over the grotto of Jeremiah (El Heidmiyeh in Plate X.) is supposed by Lieutenant Conder to be Calvary.

<sup>2</sup> Details in *Chron. Pasch.*, Ol. 224, 3.

in many cases retain Arabic names at least four hundred years old. They are arched over here and there, and the bazaars, with portions of the Via Dolorosa and of other streets, are entirely covered in. There are now four quarters:—that of the Moslems (including the Haram) on the north-east, the Jewish quarter on the south-east, the Armenian quarter on the south-west, the Christian on the north-west. The quarters are bounded by David (or Temple) Street, running east from the Jaffa gate, and by the street running north and south immediately east of the Holy Sepulchre (called *Hārat el Yehūd* on the south and *Tarīk Bāb el 'Amūd* on the north). The quarters are not, however, exclusively occupied by any nationality, many rich Jews having houses in the Armenian and even in the Moslem quarter. In the 12th century the present Moslem quarter was occupied by the Jews, and called the *Juiverie*.

Viewed from the Mount of Olives, the most conspicuous object is the Haram enclosure, occupying nearly one-sixth of the city, with the Dome of the Rock rising in the centre and the Aksa mosque extending to the southern wall, while between these two buildings are the tall cypresses which surround the fountain *El Kās*. Arcades with pointed arches stand on the flights of steps leading to the platform surrounding the Dome of the Rock, and three minarets rise from the west and north walls, while the great eastern rampart is unbroken save by the projecting tower of the Golden gate. In the Jewish quarter two large synagogues with domes—one painted green—are conspicuous, while the church and convent of St James is the special feature of the Armenian quarter. Close to the Jaffa gate rise the square tower of David and a minaret within the citadel, while immediately east of this fortress stands the Protestant English church and the large palace of the Anglo-German Protestant bishop. North-east of these are seen the two domes of the rotunda and choir of the Holy Sepulchre, and immediately south of them the minaret of Omar's mosque on the site of the great hospital of St John. The modern Latin cathedral and patriarchate appear behind the Holy Sepulchre church, while the highest ground outside the city on the north-west is occupied by the Russian cathedral, hospice, and consulate, only completed in 1866.

The country round the city is barren and stony. Olive groves exist on the north, and the white slopes of Olivet are dotted with the trees whence it is named. Vineyards also exist on the west, but since the destruction of the fruit trees by Titus (*B. J.*, v. 3, 2) the vicinity of Jerusalem seems always to have presented a sterile appearance.

The number of churches and monasteries in the modern city, without counting many crusading chapels now either in ruins or else converted into mosques, is very large. There are 18 monasteries of the Greek Orthodox sect, 8 Catholic (or Latin), including the patriarchate, 3 Armenian, 2 Coptic, 1 Syrian, 1 Armenian Catholic, 1 Greek Catholic, and 1 Abyssinian. The Protestant institutions, including schools, &c., number 14 in all. In the Jewish quarter there are no less than 14 synagogues and 2 schools. There are also many charitable institutions in and near the city, of which the principal are Rothschild's hospital near the south wall, founded in 1855, and Sir Moses Montefiore's alms-houses, west of the great reservoir called *Birket es Sultān*. In the centre of the city excavations have been carried on by the German Government (to whom the site was given by the sultan) in the grounds of the crusading convent of Sta. Maria Magna (now called *El Mārīstān*) immediately east of the hospital of St John; a Lutheran chapel is now established in the ruins. The Moslem buildings of the city date principally from the 13th, 14th, and 15th centuries, and some of the ancient Moslem schools near the Haram are remarkably solid structures. There are two barracks, one on the scarped rock (Antonia) north

of the Haram, the other in the citadel on the south-west. The *serai* or court-house is near the former. All the European powers are represented by resident consuls, and every nationality has some kind of hospice or hotel for the reception of pilgrims. The market-places have remained unchanged from very early times, the upper or vegetable market being in the upper city opposite the tower of David, and the bazaars or lower markets in the valley north of David Street. The money-changers occupy the site of the old exchange of the 12th century (first established by Charlemagne) in the western portion of David Street.

Jerusalem under the Turks is the capital of southern Palestine (about 2000 square miles), and the seat of a *mutasarrif* under the *vāly* of Syria. The *mejlis* or town council consists of 8 members:—4 Moslem, 3 Christian, 1 Jewish, the latter being the chief rabbi of the Sephardim. The export trade of the city consists chiefly of oil, corn, saffron, cotton (of poor quality), and soap, also of rosaries, crucifixes, and cameos, carved in olive wood and mother of pearl. The imports in 1871 amounted to £72,000, including cotton, wool, hardware, timber, silk, and glass from England and Austria; wines and spirits from France; and £3500 value of flour from Russia. Rice is imported in coasting vessels from Egypt; wine, spirits, dried fish, &c., from Cyprus and the Greek islands; carpets and shawls are brought by the Moslem and Christian pilgrims. There are also a few potteries in the city.

The present cemeteries of Jerusalem are six in number. The Moslem inhabitants bury immediately outside the east wall of the Haram, especially beside and north of the Golden gate, while a second Moslem cemetery exists on the knoll of Jeremiah's grotto, and a third (on the site of the old *Carnarium Leonis*) is close to the Mamilla pool west of the city. The Christians have cemeteries on the south-west of the brow of Sion, and the Jews are buried on Olivet opposite the temple, excepting the Karaites who have a cemetery on the south-east part of Sion.

The remains of an old Christian cemetery, including tombs belonging to the old church of St Sion, are found in the southern boundary valley, and there are a few sepulchres of crusading date near the north-east corner of Jerusalem on the outside. Of the ancient Jewish tombs the most striking are that known as the Tombs of the Kings, and the monument called Absalom's tomb on the east of the Kidron valley, which is perhaps the tomb of Alexander Jannæus (*B. J.*, v. 7, 2).

The climate of Jerusalem is healthy in comparison with that of the plains beneath it. A fresh sea breeze blows throughout the day in summer, and the average daily maximum temperature is 86° F. August is the hottest month, but in May the prevalence of dry east winds is specially trying. The autumn months are very unhealthy. In winter there are occasionally heavy falls of snow, which lies on the hills for several days. The waters of the *Bir Eyūb* overflow annually through a hole in the ground near the well, and a running stream then flows for many days down the Kidron valley. This overflow is a cause of rejoicing to the inhabitants, who make it a holiday occasion. The annual rainfall averages about 18 inches. Years of drought occasionally occur, when the inhabitants of the city suffer much from want of water. The repair of the aqueduct from Bethlehem and of the large reservoirs in the city would, however, be sufficient to ensure a plentiful supply. The present supply is obtained principally from cisterns under the houses. Slight shocks of earthquake are occasionally experienced (as for instance in 1874), and appear to have been specially prevalent in the 8th and 11th centuries (*cf.* Zech. xiv. 5).

The population of Jerusalem, stated in 1838 at about 11,000, has increased rapidly of late years, owing to a



great increase in the Jewish population, which has risen in that time from 3000 to over 10,000 souls. According to a consular estimate in 1872, the population was as follows, the total agreeing very closely with an independent estimate by Frère Lievin the Franciscan:—Jews (Sephardim, 4600; Ashkenazim, 6000), 10,600; Moslems, 5000; Christians, 5300; total, 20,900.

At Easter this population is increased by about 5000 pilgrims, who crowd the narrow streets until they are almost impassable. Throughout the year there are generally about 100 pilgrims in the Russian hospice. The number of Jews is said to be increasing at the rate of 1200 to 1500 souls per annum, chiefly though fresh arrivals from Russia and Poland. A building-club has been established and 130 houses erected in four years by the Jews, outside the walls. Along the Jaffa road many country villas have also been erected of late by European residents as summer abodes.

A very large majority of the Christians in Jerusalem are either priests, monks, or nuns. The majority belong to the Greek Orthodox church (about 2800 souls). The Greek patriarch has a province including all Palestine, with ten bishops, viz., of Nazareth, Acre, Kerak, Tabor, Bethlehem, Lydda, Gaza, Nablus, Es Salt, and Sebastieh, the last five being residents in Jerusalem. The Russian cathedral is presided over by an archimandrite with two assistant priests and a deacon.

The Latins in Palestine are not numerous, the country villages when Christian belonging generally to the Greek church. The Latin priests and monks are principally Jesuits and Franciscans. The number of Latins in Jerusalem is about 1500. Their churches are the cathedral of St Saviour, close to the patriarchate on the west, and the chapel of the Flagellation. They have established also many useful institutions, including a boys' school for 150 and a girls' school for 100 pupils.

The number of Armenian and Greek Catholics together does not exceed 50 souls. The orthodox Armenians are the richest sect in the city, numbering about 500. Great numbers of Armenian pilgrims visit the city, and their hospice (for 2000) is the largest in Jerusalem. Their principal church is that of St James on Zion. The Protestants (about 300) belong to the English Church and the Lutheran. The bishopric was established by England and Prussia in 1841. The mission to the Jews was established in 1824, and supports a hospital and church with resident chaplain and parsonage, a boys' school, and other institutions. There are also several German institu-

tions, including a girls' school and an orphanage outside the walls. The remaining Christian sects, Copts, Syrians, and Abyssinians, number only about 200 souls. For the Jews in Jerusalem see Jews, page 686 of the present volume.

The streets of Jerusalem at Easter present a strange spectacle from the numerous national costumes seen together. The European tourist, the Turkish nizam, the hooded Armenian, the long-haired Greek monk, are mingled with the native peasants in yellow turbans and striped mantles, with Armenian pilgrims wearing broad red sashes, Jews in Oriental costume or with the fur cap and velvets of the Pharisee, Russians in knee boots and padded robes, and native ladies in white mantles with black face veils. The architecture of the city, Oriental, Gothic, Byzantine, or Italian, tells the same story—that Jerusalem has been for eighteen centuries a holy city in the eyes of Jew, Christian, and Moslem alike, and the religious centre of half the world. (C. R. C.)

*Literature.*—For the oldest period the Bible is the only source; for the city of Herod Josephus, to whom classical authors (Strabo, Tacitus) add little. The Talmudic material has been collected by Neubauer, *Geographie du Talmud*, Paris, 1868; comp. Schwarz's *Palestine* (תולדות הארץ), 1845; Eng. transl., Philadelphia, 1850; German transl., 1852). The materials for Christian Jerusalem in patristic literature, histories, and pilgrimages are immense. The best list is Tobler's *Bibliographia Geographica Palestinae*, Leips., 1867, with the supplement (1875) for 383-1000 A.D. See also A. B. McGrigor's *Index of Passages bearing upon the Topography from Writings prior to the 11th century*, Glasgow, 1876. The Arabic sources have hitherto been imperfectly utilized. Of the more ancient Istakhry and Mokaddasy (988 A.D.), on whom Yakūt and Kazwīnī mainly depend, deserve special notice. For Arabic works on Jerusalem see H. Khalifa, ii. 139. Recent writers have chiefly followed two very modern works, the *Uns Jallil* of Mujir ed Din (1494 A.D., see H. Kh., i. 453), of which extracts are given by Williams (vol. i., app. 2), and by Sauvaire (*Hist. de Jerusalem et d'Hebron*, 1876), and the *Itāf el Ahissā* of Kemāl ed Din (1470 A.D., see H. Kh., i. 148), which through an error of the translator Reynolds (Lond., 1836) is often ascribed to the famous Jelāl ed Din (Soyūtī). This book by no means deserves the authority attached to it by English writers. Results of recent research are embodied in the ordnance survey map, 1865; Zimmermann's maps, 1876, 1880; Warren's *Recovery of Jerusalem*, 1871. Of the innumerable topographical discussions (excluding works specially devoted to the Temple and Holy Sepulchre) may be named Reland, *Palestina*, 1714; Olshausen, *Zur Topographie des alten Jerusalem*, 1833; Fergusson, *Topography of Jerusalem*, 1847; Robinson, *Biblical Researches*; Thrupp, *Ancient Jerusalem*, 1855; Lewin, *Siege of Jerusalem by Titus*, 1863; Williams, *The Holy City*, 2d ed., 1849; Furrer, *Wanderungen*, 1865; Id., "Jerusalem" in Schenkel's *Bib. Lex.* For the history see Williams, *op. cit.*, and Besant and Palmer, *Jerusalem*, 1871 (from crusading and Arabic sources). Socin-Badeker's *Handbook* deserves special notice.

JESI, a city in the circle and province of Ancona, Italy, is situated on a slight eminence on the left bank of the Esino, 17 miles west-south-west of Ancona, with which it is connected by rail. It is surrounded by a wall with towers. The streets, of which the Corso is the finest, are fairly good, and contain several noteworthy buildings, including a theatre and several churches. The cathedral, restored in the 18th century, is dedicated to St Septimius the martyr, who was first bishop of the see in 308. Jesi possesses a hospital and several benevolent institutions, besides a seminary, a lyceum, a communal college, and other educational establishments. It is one of the most active industrial towns of the province. Its manufactures include silk and woollen stockings, paper, cordage, leather, &c.; and it carries on trade in wine, oil, and grain. Jesi takes its title of "royal" city from having been the birthplace of the emperor Frederick II. in 1194. The population is 11,469.

Jesi represents the Roman colony and municipium *Æsis* (in Strabo, *Æsium*), which traces a traditional origin to the Pelasgi. Vestiges of Roman remains render improbable the opinion that, after being destroyed during the barbarian invasion of Italy, the town was removed to a new site. Jesi was a bone of contention between the Longobardi and the Byzantine exarchs, who alternately possessed it. Ultimately it fell into the hands of the Franks. During the early Middle Ages it enjoyed prosperity under Frederick II. and his immediate successors; but about the beginning of the 14th century it began to have its full share of internal and external troubles. It passed into the power of the Holy See in the pontificate of Nicholas V. (1447-1455); under Napoleon it figured as a vice-prefecture; and in 1860 it was incorporated with the kingdom of Italy.

JESSE, EDWARD (1780-1868), a writer on natural history, was born 14th January 1780, at Hutton Cranswick, Yorkshire, where his father was vicar. He became clerk in one of the Government offices in 1798, and for a time was secretary to Lord Dartmouth, when president of the Board of Control, through whom he also received an office at court. In 1812 he was appointed commissioner of

hackney coaches, and not long afterwards he became deputy surveyor-general of the royal parks and palaces. On the abolition of this office he retired on a pension, and he died at Brighton 28th March 1868. The office which Mr Jesse filled in connexion with the royal parks induced him to take a considerable interest in the habits and characteristics of animals, the result of which was seen in a series of pleasant and popular books on natural history, the principal of which are *Gleanings in Natural History*, 3 vols., 1832-35; *An Angler's Rambles*, 1836; *Anecdotes of Dogs*, 1846; and *Lectures on Natural History*, 1863. He also edited Walton's *Complete Angler*, White's *Selborne*, and Ritchie's *Windsor Castle*, and wrote a number of handbooks to places of interest, including Windsor and Hampton Court.

JESSE, JOHN HENEAGE (1808-1874), son of Edward Jesse noticed above, was born in 1808. From his early manhood he held an office in the secretary's department of the Admiralty at Whitehall. His first contribution to literature, a poem on Mary Queen of Scots, which he dedicated to Sir Walter Scott, was published in 1829, and this was followed in 1830 by a collection of poems entitled *Tales of the Dead*. Among his other efforts in verse were a drama (*Richard III.*) and a fragmentary poem entitled *London*, dedicated to Mr Rogers the poet. None of these ventures achieved any success, but his series of historical works, which together form a continuous narrative from the reign of Richard III. to that of George III. inclusive, are written with vivacity and interest, and in their own style are a not unimportant contribution to the history of England. His *Memoirs of the Court of England during the Reign of the Stuarts* was published in 1839-40, *Memoirs of the Court of London from the Revolution of 1688 to the Death of George II.* in 1843, *George Selwyn and his Contemporaries* in 1844, *Memoirs of the Pretenders and their Adherents* in 1845, *Richard the Third and his Contemporaries* in 1861, and *Memoirs of the Life and Reign of King George the Third* in 1867. The titles of these works are sufficiently indicative of their character. They are sketches of the principal personages and of the social details of various periods in the history of England rather than complete and comprehensive historical narratives. In addition to these works, Mr Jesse wrote *Literary and Historical Memoirs of London*, 1847, and *London and its Celebrities*, 1871. His *Memoirs of Celebrated Etonians* appeared in 1875. He died July 7, 1874.

JESSELMERE, a form of JÁISALMIR (*q.v.*).

JESSOR, or JESSORE, a British district in the lieutenant-governorship of Bengal, lying between 22° 25' 50" and 23° 47' N. lat., and between 88° 57' 33" and 90° 0' 13" E. long., with an area (1878) of 3658 square miles, forms the eastern portion of the presidency division. It is bounded on the N. and W. by Nadiyá district, on the S. by the Sundarbans, and on the E. by the district of Faridpur.

Jessor forms the central portion of the delta between the Hooghly and the united Ganges and Brahmaputra. It is a vast alluvial plain intersected by rivers and watercourses, which at places in the southern portion of the district spread out into large marshes. The northern part of the district is verdant, with extensive groves of date-palms; villages are numerous and large; and the people are prosperous. In the central portion the population is sparse, the only part of the tract suitable for dwellings being the high land on the banks of rivers. The principal rivers of Jessor are the Madhumati (which forms the eastern boundary of the district), with its tributaries the Nabagangá, Chitra, and Bhairab; the Kumár, Kabadak, Katkí, Harihar, Bhadrá, and Atharábánká. Within the last century the rivers in the interior of Jessor have ceased to be true deltaic rivers; and, whereas the northern portion of the district formerly

lay under water for several months every year, it is now reached only by unusual inundations. The tide reaches as far north as the latitude of Jessor town.

The population of Jessor in 1872 numbered 2,075,021, of whom 1,051,126 were males and 1,023,895 females. The inhabitants of the district are all Bengalis; the better classes are Hindus, the lower orders being principally Mahometans. The Hindus number 915,413, the Musalmáns 1,151,936, and the Christians 1142. The Bráhma Samáj has a few adherents. Among the lower ranks, the fishing and boating castes deserve attention, the fisheries in the rivers and deeper swamps being very valuable, and the right to fish being a regular tenure paid for like the right to cultivate land. Jessor is noted for a colony of pure Kulin Bráhmans, who live at Lakshmipása, a village on the Nabagangá. These Kulin trace their origin to Ramánand Chakrabartí, who five generations ago emigrated from Sarmangal in Bákarganj, a great Kulin settlement. The only place with a population exceeding 5000 is Jessor town, which has 8152.

The principal staple in Jessor is rice; among other crops are barley, Indian corn, pease, mustard, jute, tobacco, potatoes, sugarcane, indigo, *pan*, dates, &c. The total cultivated area is about 1,381,500 acres, more than a million of which are said to be under rice. The estimated area covered by date-palms for the manufacture of sugar is 17,500 acres. The area under indigo is 31,333 acres. The total produce in 1872-73 was 203 tons, valued at £114,400. There are about fifty-five European factories, besides fifty worked in the interest of native proprietors under European or native management. Blights occur occasionally. The district is subject to heavy floods, which have sometimes been immediately followed by disastrous cyclones. Several inundations have taken place, causing famine.

The trade of Jessor is carried on chiefly by means of permanent markets, but there is also a considerable traffic at the numerous fairs and religious gatherings held throughout the district. The chief exports are sugar, indigo, rice, pulse, timber, honey, shells, &c.; the chief imports are salt, English goods, and cloth. The principal manufactures are date-sugar and indigo. The police-force consisted in 1871 of 590 officers and men, maintained at a cost of £13,548. In 1871 the number of Government and aided schools was 390, with 12,349 pupils. The climate does not differ from that of the other districts of Lower Bengal. April, May, and June are very trying, their average mean temperature being 83°·6 Fahr. The average rainfall is about 65 inches. Malarious diseases are very prevalent, intermittent fever being common throughout the year. Cholera breaks out every hot season.

British administration was completely established in the district in 1761, when the governor-general ordered the opening of a court at Muráli near Jessor. Before that, however, the fiscal administration of the district had been in the hands of the English, having been transferred to the East India Company with that of the rest of Bengal in 1765. The changes in jurisdiction in Jessor have been very numerous. After many transfers and rectifications, the district was in 1863 finally constituted as it at present stands. The rájás of Jessor or Chánchrá trace their origin to Bhábésvar Rái, a soldier in the army of Khán-i-Azam, an imperial general, who deposed Rájá Pratápádiya, the popular hero of the Sundarbans, of several fiscal divisions, and conferred them on Bhábésvar. But Manohar Rái (1649-1705) is regarded as the principal founder of the family. The estate when he inherited it was of moderate size, but he acquired one parganá after another, until, at his death, the property was by far the largest in the neighbourhood.

JESUITS. The "Company of Jesus," in its original conception, and in its avowed or ostensible objects, does not at the first glance appear as more than one of many similar communities which have grown up in the bosom of Latin Christianity. Like several of them, it is a congregation of ecclesiastics living in accordance with a definite rule, whence technically called "Clerks Regular"; like the Templars, Hospitallers, and Teutonic Knights, military ideas have entered largely into its plans; like Benedictines, Dominicans, and Franciscans, its spiritual labours have been those of teaching the young by schools and catechizings, conducting home missions by such agencies as sermons, retreats, and the like, combating heresy with the pulpit and the pen, and converting the heathen. In each and all of these peculiarities and occupations it comes late into a field where its precursors had been busy for centuries, and it might seem to differ from them merely by a more careful selection of instruments, a more skillful organization, and a more perfect discipline.

But such a view is entirely misleading. On closer



examination the Jesuit body proves to resemble those other religious societies only in external and separable accidents, differing from them and from all others in its essential character,—and that not in degree merely, but in kind also, so as to be an institution absolutely unique in history.

In the first place, all the earlier associations of the kind, even the military orders themselves, have their origin in a desire to withdraw so far as possible from contact with the world and its concerns, to seek spiritual perfection in a retired life of contemplation and prayer, to concentrate efforts for this end chiefly within the cloister where each such group is collected, and to act only indirectly, and as it were with the mere surplus overflow of religious energy, on their more immediate neighbours around, and even then chiefly with the idea of persuading all the most devout and fervent amongst them to forsake the world in a similar fashion. Contrariwise, the Jesuit system is to withdraw religious men from precisely this sort of retirement, except as a mere temporary preparation for later activity, and to make habitual intercourse with society a prime duty, rigidly suppressing all such external regulations of dress, rule, and austerities as tend to put obstacles in the way, so leaving the members of the "Company" free to act as emissaries, agents, or missionaries in the most various places and circumstances. Next, the constitution of the elder societies was for the most part democratic. Allowing for special exceptions, the normal scheme of government was this. Each house of an order had a separate life and partial independence of its own. It elected its own superior and officers, usually by ballot, for a short term of years, it discussed its business, and its members confessed their faults, in open chapter. Each group of houses elected a provincial; the provincials, or delegates from among them, elected the general, whose authority was strictly constitutional, and limited as definitely by the rule and statutes as the rights of the youngest novice. Further, admission was seldom difficult; the noviciate rarely exceeded two years, and the novice, professed at the close of that probation, at once entered on a share in the government of the society, and became eligible for its highest offices. Unlike this method in every respect, the Jesuit polity is almost a pure despotism, guarded, no doubt, with certain checks, but even those of an oligarchical kind. The general is indeed elected by the congregation of the society; but, once appointed, it is for life, and with powers lodged in his hands, partly due to the original constitutions, and partly to special faculties and privileges conferred by various popes, which enormously exceed, as regards enactment and repeal of laws, as to restraint and dispensation, and both in kind and degree, those wielded by the heads of any other communities. He alone nominates to every office in the society (with certain significant exceptions to be named presently) and appoints the superiors of all the houses and colleges. The vow of obedience is taken directly to him, and not, as in the older orders, to the rule, as distinguished from the mere chief of the executive. The admission or dismissal of every member depends on his absolute fiat; and, by a simple provision for reports to him, he holds in his hands the threads of the entire business of the society in its most minute and distant ramifications.

Once more, the distinguishing peculiarity of the earlier communities, dating from the origin of the Benedictine rule, is their hostility to local change. The vow of *stability*, soon added to the three customary pledges of poverty, chastity, and obedience, was designed to impede, not merely itinerancy without settled abode, such as had brought discredit on those ancient monks who were styled *circumcellions*, nor even easy transition from one religious community to another; unless in search of greater austerity,

but even facility of transfer from one house to another of the very same order. Where the profession was made, there, in the absence of exceptional reasons, the life should be spent; and this rule of course tended to nationalism in the monasteries of every country, even in the great military orders, which, though accepting recruits from all quarters, yet grouped them into *tongues*. But mobility and cosmopolitanism are of the very essence of the Jesuit programme. The founder of the society has excluded the possibility of doubt on this subject, for having chosen the military term "Company," rather than "Order" or "Congregation" to describe his new institute, he explained its meaning to Paul III. as being that, whereas the ancient monastic communities were, so to speak, the infantry of the church, whose duty was to stand firmly in one place on the battlefield, the Jesuits, contrariwise, were to be the "light horse," capable of going anywhere at a moment's notice, but especially apt and designed for scouting or skirmishing. And, to carry out this view, it was one of his plans to send foreigners as superiors or officers to the Jesuit houses of each country, requiring of these envoys, however, to use invariably the language of their new place of residence, and to study it both in speaking and writing till entire mastery of it had been acquired,—thus by degrees making all the parts of his vast system mutually interchangeable, and so largely increasing the number of persons eligible to fill any given post, without reference to locality.

Further, the object of the elder monastic societies was the sanctification of their individual members. In truth, community life was only a later development of the original system, as exhibited in the Thebaid, in accordance with which solitary hermits began to draw near to each other, until the collection of separate huts gradually assumed the form of a *laura* or hamlet of cells, grouped under an abbot, and with a common place of worship—a model still surviving in the Camaldolese order. Their obedience to a superior, and the observance of some kind of fixed rule, had no further intention than the improvement of the spiritual character of each person who entered such a community; and, with certain qualifications, this has continued the ideal of the older orders,—modified chiefly by the natural desire of each such body to gain influence and credit from the personal character of all its members and the efficiency of its active operations. But the founder of Jesuitism started at once with a totally different purpose. To him, from the first, the society was everything, and the individual nothing, except so far as he might prove a useful instrument for carrying out the society's objects. In a MS. collection of sayings by Loyola, whose genuineness is accepted by the Bollandists, themselves Jesuits, and by his biographer F. Genelli, he is stated to have said to his secretary, Polanco, that "in those who offered themselves he looked less to purely natural goodness than to firmness of character and ability for business, for he was of opinion that those who were not fit for public business were not adapted for filling offices in the society." He went even further than this, and laid down that even exceptional qualities and endowments in a candidate were valuable in his eyes only on the condition of their being brought into play or held in abeyance strictly at the command of a superior. On this principle, he raised obedience to a position it had never held before, even amongst monastic virtues. His letter on this subject, addressed to the Jesuits of Coimbra in 1553, is still one of the standard formularies of the society, ranking with those two other products of his pen, the *Spiritual Exercises* and the *Constitutions*; and it is evident that his views differ very seriously from the older theories on the subject, as formulated in other rules. In them the superior is head of a local family, endowed with paternal authority, no doubt as

understood by the old civil code of the Roman empire, centuries after the very memory of freedom had been lost, yet having fixed limits, alike traditional and prescribed, besides being exercised only within a limited area and for certain specified purposes. Loyola, true to his military training and instincts, clothes the general with the powers of a commander-in-chief of an army in time of war, giving him the absolute disposal of all members of the society in every place and for every purpose. Not only so, but he pushes the claim much further, requiring, besides entire outward submission to command, also the complete identification of the inferior's will with that of the superior. He lays down that this superior is to be obeyed simply as such, and as standing in the place of God, without reference to his personal wisdom, piety, or discretion; that any obedience which falls short of making the superior's will one's own in inward affection as well as in palpable effect, is lax and imperfect; that going beyond the letter of command, even in things abstractly good and praiseworthy, is disobedience; and that the "sacrifice of the intellect"—a familiar Jesuit watchword—is the third and highest grade of obedience, well-pleasing to God, when the inferior not only wills what the superior wills, but thinks what he thinks, submitting his judgment so far as it is possible for the will to influence and lead the judgment. So far-reaching and dangerous are these maxims that the *Letter on Obedience* was formally condemned, not long after Loyola's death, by the Inquisition in Spain and Portugal, and it tasked all the skill and learning of Bellarmine as its apologist, together with the whole influence of the company, to avert the ratification of the sentence at Rome.

It has, however, been alleged in defence that this very strong language must be glossed and limited by two other maxims penned by Loyola: (1) "Preserve your freedom of mind, and do not relinquish it by the authority of any person, or in any circumstances whatever"; and (2) "In all things *except sin* I ought to do the will of my superior, and not my own." But the value of these checks is seriously diminished when it is added that the former of them occurs in the introductory part of the *Spiritual Exercises*, a manual expressly designed and used for the purpose of breaking down the will of those who pass through its appointed ordeal under a director; while the latter is qualified in its turn, not only by the whole principle of probabilism, the special doctrine of the society, which can attenuate and even defend any kind of sin, but by the four following maxims, in close juxtaposition to itself in the very same document: "I ought to desire to be ruled by a superior who endeavours to subjugate my judgment or subdue my understanding"; "When it seems to me that I am commanded by my superior to do a thing against which my conscience revolts as sinful, and my superior judges otherwise, it is my duty to yield my doubts to him, unless I am otherwise constrained by evident reasons"; "If submission do not appease my conscience, I must impart my doubts to two or three persons of discretion, and abide by their decision"; "I ought not to be my own, but His who created me, and his too by whose means God governs me, yielding myself to be moulded in his hands like so much wax. . . . I ought to be like a corpse, which has neither will nor understanding, or like a small crucifix, which is turned about at the will of him that holds it, or like a staff in the hands of an old man, who uses it as my best assist or please him." And one master-stroke of Loyola's policy was to insure the permanence of this submission by barring access to all independent positions on the part of members of the society, through means of a special constitution that no Jesuit can accept a cardinal's hat, a bishopric other than missionary, an abbacy, or any similar dignity, save with permission of the general, not to

be accorded unless and until the pope has commanded its acceptance under pain of sin.

The next matter for consideration is the machinery by which the society is constituted and governed, so as to enable this principle to become a living energy, and not a mere abstract theory. The society, then, is distributed into six grades:—novices, scholastics, temporal coadjutors, spiritual coadjutors, professed of the three vows, and professed of the four vows. The novice cannot become a postulant for admission to the society till fourteen years old, unless by special dispensation, and is at once classified according as his destination is the priesthood or lay brotherhood, while a third class of "indifferents" receives such as are reserved for further inquiry before a decision of this kind is made. They first undergo a strict retreat of a month in what is practically solitary confinement, during which they go through the *Spiritual Exercises*, and make a general confession of their whole previous life; after which the first noviciate, of two years' duration, begins. This is spent partly in daily study, partly in hospital work, and partly in teaching the rudiments of religious doctrine to children and the poor. They may leave or be dismissed at any time during this noviciate, but if approved are advanced into the grade of scholastics, corresponding in some degree to that of undergraduates at a university. The ordinary course for these is five years in arts, when, without discontinuing their own studies, they must pass five or six years more in teaching junior classes, not reaching the study of theology till the age of twenty-eight or thirty, when, after another year of noviciate, a further course of from four to six years is imposed, and not till this has been completed can the scholastic be ordained as a priest of the society, and enter on the grade of spiritual coadjutor, assuming that he is not confined to that of temporal coadjutor, who discharges only such functions as are open to lay-brothers, and who must be ten years in the society before being admitted to the vows. The time can be shortened at the general's pleasure, but such is the normal arrangement. Even this rank confers no share in the government, nor eligibility for the offices of the society. That is reserved for the professed, themselves subdivided into those of the three vows and of the four vows. It is these last alone, forming only a small percentage of the entire body, who constitute the real core of the society, whence its officers are all taken, and their fourth vow is one of special allegiance to the pope, promising to go in obedience to him for missionary purposes whenever and whithersoever he may order,—a pledge seriously qualified in practice, however, by the power given to the general of alone sending out or recalling any missionary. The constitutions enjoin, by a rule seldom dispensed with, that this final grade cannot be attained till the candidate has reached his forty-fifth year, which involves a probation of no fewer than thirty-one years for even such as have entered on the noviciate at the earliest legal age. These various members of the society are distributed in its noviciate houses, its colleges, its professed houses, and its mission residences. The question has long been hotly debated whether, in addition to these six avowed grades, there be not a seventh, answering in some degree to the Tertiaries of the Franciscan and Dominican orders, secretly affiliated to the society, and acting as its unsuspected emissaries in various lay positions. This class is styled in France "Jesuits of the short robe," and some evidence in support of its actual existence was alleged during the lawsuits against the company under Louis XV. The Jesuits themselves deny the existence of any such body, and are able to adduce the negative disproof that no provision for it is to be found in their constitutions. On the other hand, there are clauses therein which make the creation of such



a class perfectly feasible if thought expedient. One is the power given to the general to receive candidates secretly, and to conceal their admission, for which there is a remarkable precedent in the case of Francis Borgia, duke of Gandia, afterwards himself general of the society; the other is an even more singular clause, providing for the admission of candidates to the company by persons who are not themselves members of it. The known facts on either side are insufficient for a decisive verdict, and "Not proven" is the only impartial judgment possible. The general, who should by the statutes of the society reside permanently at Rome, holds in his hands the right of appointment, not only to the office of provincial over each of the great districts into which the houses are mapped, but to the offices of each house in particular, no shadow of electoral right or even suggestion being recognized.

The superiors and rectors of all houses and colleges in Europe must report weekly to their provincial on all matters concerning the members of the society and all outsiders with whom they may have had dealings of any sort. Those employed in district missions report at such longer intervals as the provincial may fix. The provincial, for his part, must report monthly to the general, giving him a summary of all details which have reached himself. But, as a check on him, all superiors of houses in his province are to make separate reports directly to the general once in three months, and further to communicate with him without delay every time any matter of importance occurs, irrespective of any information which the provincial may have forwarded. Nor is this all; an elaborate system of espionage and delation forms part of the recognized order of every house, and, in direct contrast to the ancient indictment and confession of faults in open conventual chapter, every inmate of a house is liable to secret accusation to its superior, while the superior himself may be similarly delated to the provincial or the general.

Nor is the general himself exempt from control on the part of the society, lest by any possibility he might prove, from disaffection or error, unfaithful to its interests. A consultative council is imposed on him by the general congregation, consisting of six persons, whom he may neither select nor remove,—namely, four assistants, each representing a nation, an admonisher or adviser (resembling the *adlatus* of a military commander) to warn him of any faults or mistakes, and his confessor. One of these must be in constant attendance on him; and, while he is not at liberty to abdicate his office, nor to accept any dignity or office outside it without the assent of the society, he may yet be suspended or deposed by its authority. No such instance, however, has yet occurred in Jesuit history, although steps in this direction were once taken in the case of a general who had set himself against the current feeling of the society. With so widely ramifying and complex a system in full working order, controlled by the hand of one man, the Company of Jesus has been aptly defined as "a naked sword, whose hilt is at Rome, and whose point is everywhere."

There would seem at first to be an effectual external check provided, however, in the fact that, while all the officers of the society, except the council aforesaid, hold of the general, he in turn holds of the pope, and is his liegeman directly, as well as in virtue of the fourth vow, which he has taken in common with the other professed. But such is the extraordinary skill with which the relations of the society to the papacy were originally drafted by Loyola, and subsequently worked by his successors, that it has always remained organically independent, and might very conceivably break with Rome without imperilling its own existence. The general has usually stood towards the pope much as a powerful grand feudatory of the Middle Ages

did towards a weak titular lord paramount, or perhaps as the captain of a splendid host of "Free Companions" did towards a potentate with whom he chose to take temporary and precarious service; and the shrewd Roman populace have long shown their recognition of this fact by styling these two great personages severally the "White Pope" and the "Black Pope." In truth, the society has never, from the very first, obeyed the pope, whenever its will and his happened to run counter to each other. Even in the very infancy of the company, Loyola himself used supplications and arguments to the pope to dissuade him from enforcing injunctions likely to prove incompatible with the original plan, and on each occasion succeeded in carrying his point; while his immediate successors more openly resisted Paul IV. when attempting to enforce the daily recitation of the breviary on the clerks of the society, and to limit the tenure of the generalship to three years, and Pius V. when following his predecessor's example in the former respect. Sixtus V. having undertaken with a high hand the wholesale reform of the company, including the change of its name from "Society of Jesus" to "Society of Ignatius," met with strenuous opposition, and the fulfilment of Bellarmine's prophecy that he would not survive the year 1590 was looked on less as the accomplishment of a prediction than of a threat,—an impression deepened by the sudden death of his successor, Urban VII., eleven days after his election, who, as Cardinal Castagna, had been actively co-operating with Sixtus in his plans. The accuracy of a similar forecast made by Bellarmine as to Clement VIII., who was also at feud with the society, and who died before he could carry out his intended measures, confirmed popular suspicion. Urban VIII., Innocent XI., Alexander VIII., and Clement XII. vainly contended against the doctrines taught in Jesuit books and colleges, and could effect no change. Nine popes fruitlessly condemned the "Chinese rites," whereby the Jesuit missionaries had virtually assimilated Christianity to heathenism, and the practical reply of the latter was to obtain in 1700 an edict from the emperor of China, in opposition to the papal decree, declaring that there was nothing idolatrous or superstitious in the inculcated usages, while in 1710 they flung Cardinal Tournon, legate of Clement XI., into the prison of the Inquisition at Macao, where he perished; and finally, they disobeyed the brief of suppression issued by Clement XIV. in 1773, which enjoined them to disperse at once, to send back all novices to their houses, and to receive no more members. It is thus clear that the society has always regarded itself as an independent power, ready indeed to co-operate with the papacy so long as their roads and interests are the same, and to avail itself to the uttermost of the many pontifical decrees in its own favour, but drawing the line far short of practical submission when their interests diverge.

So constituted, with a skilful combination of strictness and laxity, of complex organization with the minimum of friction in working, the society was admirably devised for its purpose of introducing a new power into the church and the world, and for carrying out effectively every part of its vast programme. Thus equipped, its services to Roman Catholicism have been incalculable. The Jesuits alone rolled back the tide of Protestant advance when that half of Europe which had not already shaken off its allegiance to the papacy was threatening to do so, and the whole honours of the counter-Reformation are theirs singly. They had the sagacity to see, and to admit in their correspondence with their superiors, that the Reformation, as a popular movement, was fully justified by the gross ignorance, negligence, and open vice of the Catholic clergy, whether secular or monastic; and they were shrewd enough to discern the only possible remedies. At a time when primary and even secondary education had in most places

become a mere effete and pedantic adherence to obsolete methods, they were bold enough to innovate, less in system than in materials, and, putting fresh spirit and devotion into the work, not merely taught and catechized in a new, fresh, and attractive manner, besides establishing free schools of good quality, but provided new manuals and schoolbooks for their pupils, which were an enormous advance on those they found in use, so that for nearly three centuries the Jesuits were accounted the best schoolmasters in Europe, as they were, till their forcible suppression the other day, confessedly the best in France,—besides having always conciliated the good will of their pupils by mingled firmness and gentleness as teachers. And, although their own methods have in time given way to further improvements, yet they revolutionized instruction as completely as Frederick the Great did modern warfare, and have thus acted, whether they meant it or not, as pioneers of human progress. Again, when the regular clergy had sunk into the moral and intellectual slough which is pictured for us in the writings of Erasmus and in the powerful satire *Epistole Obscurorum Virorum*, while there was little of a better kind visible in the lives of the parochial priesthood, the Jesuits won back respect for the clerical calling by their personal culture and the unimpeachable purity of their lives. These are qualities which they have all along carefully maintained, and probably no body of men in the world has been so free from the reproach of discreditable members, or has kept up an equally high average level of intelligence and conduct. As preachers, too, they delivered the pulpit from the bondage of an effete scholasticism, and reached at once a clearness and simplicity of treatment such as the English pulpit scarcely begins to exhibit till after the days of Tillotson: while in literature and theology they count a far larger number of respectable writers than any other religious society can boast. It is in the mission-field, however, that their achievements have been most remarkable, which might fully justify their taking as their motto—

“*Que regio in terris nostri non plena laboris!*”

Whether toiling amongst the teeming millions of Hindustan and China, labouring amongst the Hurons and Iroquois of North America, governing and civilizing the natives of Brazil and Paraguay, in the missions and “reductions,” or ministering, at the hourly risk of his life, to his coreligionists in England under Elizabeth and James I., the Jesuit appears alike devoted, indefatigable, cheerful, and worthy of hearty admiration and respect.

Nevertheless, two most startling and indisputable facts meet the student who pursues the history of this unique society. The first is the universal suspicion and hostility it has incurred,—not, as might reasonably be expected, merely from those Protestants whose avowed and most successful foe it has been, nor yet from the enemies of all clericalism and religious dogma, to whom it is naturally the embodiment of all they most detest, but from every Roman Catholic state and nation in the world, with perhaps the insignificant exception of Belgium. Next is the brand of ultimate failure which has invariably been stamped on all its most promising schemes and efforts. It controlled the policy of Spain, when Spain was aiming, with good reason to hope for success, at the hegemony of Europe, and Spain came out of the struggle well-nigh the last amongst the nations. It secured the monopoly of religious teaching and influence in France under Louis XIV. and XV. only to see an atheistic revolution break out under Louis XVI. and sweep over the nation after a century of such training. It guided the action of James II., lost the crown of England for the house of Stuart, and brought about the limitation of the throne to the Protestant succession. Its Japanese and Red Indian missions have vanished without

leaving a trace behind; its labours in Hindustan did but prepare the way for the English empire there; it was swept out of its Paraguayan domains without power of defence; and, having in our own day concentrated its efforts on the maintenance of the temporal power of the popes, and raised it almost to the rank of a dogma of the Catholic faith, it has seen Rome proclaimed as the capital of united Italy, and a Piedmontese sovereign enthroned in the Quirinal. These two phenomena demand some inquiry and analysis. As regards the former of them, the hostility the Jesuits have encountered has been twofold, political and moral or religious. There has been, from a very early date in their annals, a strong conviction prevalent that the famous motto of the society, “*A.M.D.G.*” (*Ad majorem Dei gloriam*), did not adequately represent its policy and motives, that its first and last aim was its own aggrandizement in power and wealth (for Julius II. had dispensed the general from the vow of poverty, and the colleges also were allowed to hold property), and that it spared no efforts to compass this end, even to the extent of embroiling cabinets, concocting conspiracies, kindling wars, and procuring assassinations. In several of these cases, notably as regards the charges which led to their first expulsion from France and Portugal, inclusive in the latter instance of their exile from Paraguay, the Jesuits are able to make one very telling reply, pleading that motives of statecraft alone, of an unworthy kind, and the evidence of untrustworthy and disreputable agents of their enemies, were suffered to decide the matter. In other cases, as for example the assassination of Henry IV. by Ravallac, they deny all complicity, and no sufficient proof has ever been adduced against them. But, when full allowance has been made for such rejoinders, there remain several counts of the indictment which are but too clearly made out: as, for instance, their large share, as preachers, in fanning the flames of polemical hatred against the Huguenots under the last two Valois kings, their complicity in the plots against the life of Queen Elizabeth which followed on her excommunication by Pius V.; their responsibility for kindling the Thirty Years' War; the part they took in prompting and directing the cruelties which marked the overthrow of Protestantism in Bohemia; their decisive influence in causing the revocation of the Edict of Nantes, and the expulsion of the Huguenots from the French dominions; and their accountability for precipitating the Franco-German war of 1870. And in regard to a large number of other cases where the evidence against them is defective, it is at least an unfortunate coincidence that there is always direct proof of some Jesuit having been in communication with the actual agents engaged. So it was with the massacre of St Bartholomew, almost immediately preceded by a visit of the Jesuit general, Francis Borgia, to the French court, though there is no further evidence to connect him therewith; so with Châtel and Ravallac, the unsuccessful and successful assassins of Henry IV.; so with Janreguay and Balthasar Gerard, who held the like relation to William the Silent, prince of Orange; so (as is more familiarly known) with the accomplices in the Gunpowder Plot. In all these and several other instances, the precautions which would naturally, and even inevitably, be taken by skilled and wary diplomatists for their own protection are sufficient to account for the lack of direct proof against them, but it is not easy to explain the invariable presence of a Jesuit in the background, on any hypothesis which will secure the complete acquittal of the society from charges of the sort. It is sufficient to say here in illustration that the English Roman Catholics under Elizabeth, addressing the pope with regard to the severe penal laws which oppressed them, laid the whole blame of the Government's action on the Jesuits, as having provoked



it by their conspiracies; while the secular priests in England issued in 1601 by the pen of one of their number, William Watson (afterwards executed in 1603), a pamphlet known as *Important Considerations*, to the same effect.

The merited odium which has overtaken the Inquisition, usually officered by Dominicans, has induced the Jesuits, whose own controversial method has for the most part been different, to disclaim all connexion with that tribunal, and to represent their society as free from complicity in its acts. But, in truth, it was Ignatius Loyola himself who procured its erection in Portugal in 1545-6, and F. Nithard, one of the very few cardinals of the society, was inquisitor-general of that kingdom in 1655.

The charges against the Jesuits on moral and doctrinal grounds are not less precise, early, numerous, and weighty. Their founder himself was arrested more than once by the Inquisition, and required to give account of his belief and conduct. But Loyola, with all his powerful gifts of intellect, was entirely practical and ethical in his range, and had no turn whatever for speculation, nor desire to reason on, much less question, any of the received dogmas of his church. He was therefore acquitted on every occasion, and sagaciously applied for and obtained each time a formally attested certificate of his orthodoxy, knowing well that, in default of such documents, the fact of his arrest as a suspected heretic would be more distinctly recollected by opponents than that of his honourable dismissal from custody. His successors, however, have not been so fortunate. On doctrinal questions indeed, though their teaching on grace, especially in the form given it by Molina, one of their number, was directly Pelagian (the result of reaction from Luther's teaching, which they had combated in Germany), and condemned by several popes, yet their pertinacity in the long run carried the day, and gained a footing for their opinions which was denied to the opposite tenets of the Jansenists. But the accusations against their moral theology and their action as guides of conduct, nay, as themselves involved in many doubtful transactions, have not been so appeased. They were censured by the Sorbonne as early as 1554, chiefly at the instance of Eustache de Bellay, bishop of Paris, on grounds of which some were quite true, though others appear to have been at least exaggerations; but they can plead that no other theological faculty of the time joined in the condemnation. Melchior Cano, one of the ablest divines of the 16th century, never ceased to lift up his testimony against them, from their first beginnings till his own death in 1560, and, unmollified by the bribe of the bishopric of the Canaries, which their interest procured for him, succeeded in banishing them from the university of Salamanca. St Charles Borromeo, to whose original advocacy they owed much, and especially the exception made in their favour by the council of Trent (Sess. XXV., xvi.) from the restrictions it laid on other communities, retracted his protection, and expelled them from the colleges and churches which they occupied in his diocese and province of Milan,—a policy wherein he was followed in 1604 by his cousin and successor, the equally saintly Cardinal Frederick Borromeo. The credit of the society was, however, far more seriously damaged by the publication at Cracow in 1612 of an ingenious forgery (whose authorship has been variously ascribed to John Zaorowsky or to Cambilone and Schloss, all ex-Jesuits) entitled *Monita Secreta*, professing to be the authoritative secret instructions drawn up by the general Acquaviva and given by the superiors of the company to its various officers and members, and to have been discovered in MS. by Christian of Brunswick in the Jesuit college at Prague. It is full of suggestions for extending the influence of the Jesuits in various ways, for securing a footing in fresh places, for acquiring wealth, and so forth, all marked with

ambition, craft, and unscrupulousness. It had a wide success and popularity, passing through several editions, and, though declared a forgery by a congregation of cardinals specially appointed to examine into it, has not ceased to be reprinted and credited down to the present day. The truth seems to be that, although both caricature and libel, it was drafted by a shrewd and keen observer, who, seeing what the fathers actually did, travelled analytically backwards to find how they did it, and on what methodical system, conjecturally reconstructing the process, and probably coming very near the mark in not a few details. Later on, a formidable assault was made on their moral theology in the famous *Provincial Letters* of Blaise Pascal, eighteen in number, issued under the pen-name of Louis de Montalte, from January 1656 to March 1657. Their wit, irony, eloquence, and finished style have kept them alive as one of the great French classics,—a destiny more fortunate than that of two kindred works by Antoine Arnauld, his collaborator in the *Provincial Letters*, namely, *Théologie Morale des Jésuites*, consisting of extracts from writings of members of the society, and *Moyale Pratique des Jésuites*, made up of narratives exhibiting the manner in which they carried out their own maxims in their personal action. The reply on behalf of the society to Pascal's charges of lax morality, apart from mere general denials (such as that embodied in F. Ravignan's name for the *Provinciales*, "Le Dictionnaire de la Calomnie"), is broadly as follows. (1) Ignatius Loyola himself, the founder of the society, had a special aversion from untruthfulness in all its forms, from quibbling, equivocation, or even studied obscurity of language, and it would be contrary to the spirit of conformity with his example and institutions for his followers to think and act otherwise. (2) Several of the cases cited by Pascal are mere abstract hypotheses, many of them now obsolete, argued on simply as matter of intellectual exercise, but having no practical bearing whatever. (3) Even such as do belong to the sphere of actual life are of the nature of counsel to spiritual physicians, how to deal with exceptional maladies, and were never intended to fix the standard of moral obligation for the general public. (4) The theory that they were intended for this latter purpose, and do represent the normal teaching of the Jesuit body, becomes more untenable in exact proportion as this immorality is insisted on, because it is matter of notoriety that the Jesuits themselves have been singularly free from personal, as distinguished from corporate, evil repute, and no one pretends that the large numbers of lay-folk whom they have educated or influenced exhibit any great moral inferiority to their neighbours. The third of these replies is the most cogent as regards Pascal, but the real weakness of his attack lies in that nervous dread of appeal to first principles and their logical results which has been the besetting snare of Gallianism. Afraid to deal with the fact that the society was on the whole what its founder meant it to be, and was merely carrying out his programme, because that admission would have involved challenging Loyola's position as a canonized saint, and the action of the Holy See in approving his institute, Pascal was obliged to go on the historically untenable ground that the Jesuits of his day had degenerated from their original standard; and thus he was not at liberty to go down to that principle which underlies the whole theory of probabilism, namely, the substitution of external authority for the voice of conscience. Hence the ultimate failure of his brilliant attack. The same error of complaining against integral parts of the original system as though they were departures from its spirit marks the treatise of the Jesuit Mariana on certain faults in the government of the society, which was published at Bordeaux soon after his death, in Spanish, French, Latin,

and Italian, from a MS. taken from him when he was in prison. The evils he specifies are the spy system (which he declares to be carried so far that, if the general's archives at Rome should be searched, not one Jesuit's character would be found to escape), the monopoly of the higher offices in the hands of a small clique, the narrow range of study, and the absence of encouragement and recompense for the best men of the society. But any fair examination of the constitutions will show that all these belong to the original scheme of government, and should have been challenged on that ground, if at all. Yet, on the broad issue, Pascal's censures have in the main been justified by the subsequent teaching of the society, for the lax casuistry which he held up to ridicule has been formally reproduced in the most modern and popular Jesuit text book on the subject, that of F. Gury, while the works of Liguori and Scavini, though not of direct Jesuit origin, are yet interpenetrated with the same opinions. And the result of dispassionate examination of these and kindred works—always bearing in mind that no Jesuit writings can be published without special licence from the general, after careful scrutiny and review—is that the three principles of probabilism, of mental reservation, and of justification of means by ends, which collectively make up what educated men intend by the term "Jesuitry," are recognized maxims of the society. As the last of these three is at once the most odious in itself and the charge which is most anxiously repelled, it is well to cite three leading Jesuit theologians in proof. Busenbaum, whose *Medulla Theologicæ* has been more than fifty times printed, and lately by the Propaganda itself, lays down the maxim in the following terms: "Cum finis est licitus, etiam media sunt licita," and, "Cui licitus est finis, etiam licent media." Layman, similarly, in his *Theologia Moralis*, "Cui concessus est finis, concessa etiam sunt media ad finem ordinata;" and Wagenmann, in his *Synopsis Theologicæ Moralis*, yet more tersely, "Finis determinat probitatem actus." In point of fact, many rules of conduct based on these three principles have gradually percolated, as might have been expected, into popular catechisms, and so have weakened the plea that we are dealing only with technical manuals for a professional class; while the plausible defence from the fair average honesty and morality of the lay-folk taught by a clergy which uses these manuals, amounts simply to a confession that the ordinary secular conscience is a safer guide in morals than a Jesuit casuist, since the more nearly the code deducible from his text-books is conformed to the more widely must the pupil diverge from all accredited ethics.

Two causes have been at work to produce the universal failure of the great company in all its plans and efforts. And first stands its lack of powerful intellects. Nothing can be wider from the truth than the popular conception of the ordinary Jesuit as a being of almost superhuman abilities and universal knowledge. The company is without doubt a *corps d'élite*, and an average member of it is of choicer quality than the average member of any equally large body, besides being disciplined by a far more perfect drill. But it takes great men to carry out great plans, and of great men the company has been markedly barren from almost the first. Apart from its mighty founder, and his early colleague Francis Xavier, there are absolutely none who stand in the very first rank. They have had, no doubt, able administrators, like Acquaviva: methodical and lucid compilers, like the Rollandists and Cornelius a Lapide; learned and plausible controversialists, like Bellarmine; elegant preachers, as Bourdaloue, Segneri, and Vieyra; distinguished mathematicians, like Le Seur, Jâcquier, and more lately Sechi; but even their one boldest and most original thinker, Denis Petau, has produced no permanent influence

over the current of human thought. They have had no Aquinas, no Anselm, no Bacon, no Richelieu. Men whom they trained and who broke loose from their teaching, Pascal, Descartes, Voltaire, have powerfully affected the philosophical and religious beliefs of great masses of mankind, but respectable mediocrity is the brand on the long list of Jesuit names in the catalogues of Alegambe and De Backer. This result is due chiefly to the destructive process of scooping out the will of the Jesuit novice, to replace it with that of his superior (as a watchmaker might fit a new movement into a case), and thereby annihilating in all instances those subtle qualities of individuality and originality which are essential to genius. Men of the highest stamp will either refuse to submit to the process, or will come forth from the mill with their finest qualities pulverized and useless. Nor is this all. The *Ratio Studiorum*, as devised by Acquaviva, and still followed in the colleges of the society, lays down rules which are incompatible with all breadth and progress in the higher forms of education. True to the anti-speculative and traditional side of Loyola's mind, it prescribes that even where religious topics are not in question, the teacher is not to permit any novel opinions or discussions to be mooted; nor to cite himself, or allow others to cite, the opinion of an author not of known repute; nor to teach or suffer to be taught anything contrary to the prevalent opinions of acknowledged doctors current in the schools. Obsolete and false opinions are not to be mentioned at all, even for refutation, nor are objections to received teaching to be dwelt on at any length. The professor of Biblical literature is always to support and defend the Vulgate reading, and to cite the Hebrew and Greek only when they can at least be reconciled therewith; while all versions except the LXX. (which is to be spoken of respectfully) are to be passed over entirely, save when they help to confirm the Vulgate text. In philosophy, Aristotle is to be always followed, and Aquinas generally, care being taken to speak respectfully of him even when abandoning his opinion. It is not wonderful that, under such a method of training, highly cultivated commonplace should be the inevitable average result, and that in proportion as Jesuit power has become dominant in Latin Christendom, the same doom of intellectual sterility, and consequent loss of influence with the higher and thoughtful classes, has spread from the part to the whole. The second cause which has blighted the efforts of the company is the lesson, too faithfully learnt and practised, of making its corporate interests the first object at all times and in all places. The most brilliant exception to this rule is found in some of the foreign missions of the society, and notably in that of St Francis Xavier. But Xavier quitted Europe in 1541, before the new society had hardened into its final mould, and never returned. His work, so far as we can gather from contemporary accounts, was not done on the true Jesuit lines, though the company has reaped all its credit; and it is even possible that had he succeeded Loyola as general of the Jesuits the institute might have been seriously and healthfully modified. It would almost seem that careful selection was made of the men of greatest piety and enthusiasm, such as Anchieta, Baraza, and Erebeuf, whose unworldliness made them less apt for the diplomatic intrigues of the society in Europe, to break new ground in the various foreign missions, where their successes would throw lustre on the society, and their scruples need never come into play. But such men are rare, and as they died off, their places had to be filled with more sophisticated and ordinary characters, whose one aim was to increase the power and resources of the society. Hence the condescension to heathen rites in Hindustan and China. The first successes of the Indian mission were entirely amongst the lowest class; but when Robert de Nobili, to win the



Brahmans, adopted their insignia and mode of life in 1605—a step sanctioned by Gregory XV. in 1623—the fathers who followed his example pushed the new caste-feeling so far as absolutely to refuse the ministrations and sacraments of religion to the pariahs, lest the Brahman converts should take offence,—an attempt which was reported to Rome by Norbert, a Capuchin, and by the bishop of Rosalia, and was vainly censured in the pontifical briefs of Innocent X. in 1645, Clement IX. in 1669, Clement XII. in 1734 and 1739, and Benedict XIV. in 1745. The Chinese rites, assailed with equal unsuccess by one pope after another, were not finally put down until 1744, by a bull of Benedict XIV. For Japan, where their side of the story is that best known, we have a remarkable letter, printed by Wadding, addressed to Paul V. by Soletto, a Franciscan missionary, who was martyred in 1624, in which he complains to the pope that the Jesuits had systematically postponed the spiritual welfare of the native Christians to their own convenience and advantage, while, as regards the test of martyrdom, no such result had followed on their teaching, but only on that of the other orders who had undertaken missionary work in Japan. Again, even in Paraguay, the most promising of all Jesuit undertakings, the evidence shows that the fathers, though civilizing the Guarani population just sufficiently to make them useful and docile servants, happier, no doubt, than they were before or after, stopped short there, and employed them simply in raising produce to be traded with for the interests of the society, in accordance with a privilege conferred on them by Gregory XIII., licensing them to engage in commerce.

These examples are sufficient to explain the final collapse of so many promising efforts. The individual Jesuit might be, and often was, a hero, saint, and martyr, but the system of which he was a part, and which he was obliged to administer, is fundamentally unsound, and in contravention of inevitable laws of nature, so that his noblest toils were foredoomed to failure, save in so far as they tended to ennoble and perfect himself, and offered a model for others to imitate.

The influence of the society since its revival in Latin Christendom has not been beneficial. It presents the seeming paradox of the strictest and most irreproachable body amongst the Roman clergy doing nothing to raise the general standard of clerical morals; of that which is collectively the best educated order setting itself to popularize merely emotional and material cults, to the practical neglect and disparagement of more spiritual agencies; of the most intellectual religious teachers deliberately eviscerating the understanding, and endeavouring to substitute mechanical submission to a word of command for intelligent and spontaneous assent to reasonable argument. And yet in all this they are but carrying out the fatal principles of the original institute. True to the teaching of that remarkable panegyric on the society, the *Imago Primi Sæculi Societatis Jesu* (probably written by John Tollenarius in 1640), they have identified the church with their own society, and have considered only what mode of action would make it more easily governed in the same spirit. It is thus for the advantage of such a scheme that laymen should reason as little as possible on questions of theology, that the fathers of the company should hold an acknowledged position of moral and intellectual superiority to the ordinary secular clergy, that all the threads of ecclesiastical authority should be gathered up into one hand, and that one hand in the stronger grasp of the society—a policy modelled exactly on the lines of the concordat of Napoleon I. with Pius VII. Hence the long preparation and elaborate intrigues which issued in the Vatican decrees of papal infallibility and immediate jurisdiction in all dioceses, the ultimate issues of which are still hidden in futurity.

## HISTORY.

Such being in outline the constitution and character of the Company of Jesus, it remains to summarize its historical career. Don Inigo de Loyola, a nobleman of Guipuzcoa, brave and accomplished, but unversed in letters, was severely wounded at the siege of Pampluna in 1521, when he was thirty years of age. Sent to his father's castle by his chivalrous captors, he was induced by the reading of some pious books, intended to divert the tedium of illness, to devote himself to a religious life. Quitting his home, he betook himself first to Montserrat and thence, in the garb of a pilgrim, to Mauresa, a small town near Barcelona, whence, after sojourn for a time in the hospital, he withdrew to a cavern close at hand, where, amidst the practice of various austerities, he made the first draft of his famous *Spiritual Exercises*, a work which, often retouched and amplified in his later years, is one of the chief authoritative formularies of his society. Thence he proceeded by way of Barcelona to sail for Italy, and, after visiting Rome and Venice, he made a pilgrimage to Jerusalem, intending if possible to establish a missionary society there for the conversion of the Mahometans. Compelled to withdraw by the provincial of the Franciscans, who feared a collision with the Turkish authorities, Loyola returned to Spain, and at thirty-three years of age attended school at Barcelona to acquire the rudiments of Latin, spending two years there between his studies and such missionary work as was possible for him. He then removed in 1526 to the newly founded university of Alcalá, where he first began to gather round him a little band of fellow-workers, holding religious conferences amongst the students, and giving private instruction besides to various townfolk. This conduct drew on him the suspicions of the Inquisition, but after a short imprisonment he was released, and migrated to Salamanca, whither two of his friends had preceded him. Here he was again thrown into prison on suspicion of heresy, and formed the plan of going to Paris on recovering his liberty as a place where he could have more freedom of action, superior teaching, and a greater likelihood of finding able recruits in so central and populous a city for the society he was preparing to found. He reached Paris in 1528, and entered at the college of St Barbara in the university. Not until his sixth year of residence did he attempt the regular organization of the most promising of the young men whom he drew around him. It was in July 1534 that he opened his plans to them for starting a missionary society to work in the Holy Land, and the actual vows, binding the new companions to one another and to the sort of life they contemplated, or to direct service of the pope, should that prove impracticable, were taken in the crypt of Notre Dame de Montmartre on August 15, 1534, by Ignatius Loyola himself; Peter Faber or Le Fèvre, a Savoyard; Francis Xavier, Diego Laynez, Alfonso Salmeron, Nicolas Alfonso de Bobadilla, Spaniards; and Simon Rodriguez, a Portuguese. With his usual practical foresight, Loyola postponed the execution of their scheme till January 25, 1537, and provided for its possible modification or abandonment. Three more disciples speedily joined the infant society, Jean Colme, Claude le Jay, and Paschase Brouet. In March 1535 Loyola quitted Paris, committing his society to Faber, the eldest, and betook himself to Spain, where he remained a few months, and then proceeded to Venice, whence he wrote to summon his companions to join him. They left Paris on November 15, 1536, and reached Venice on January 6, 1537, where their leader had already gained three fresh recruits, Hozoz and the two brothers D'Eguia. Remaining in Venice himself for prudential reasons, he sent all the others to Rome to solicit from Paul III. leave to go as missionaries to Jerusalem. They were aided in their application by Pedro Ortiz, the emperor's envoy, and readily obtained the desired permission, with further licence to be ordained priests by any bishop, on being duly qualified.

Returning to Venice, they were ordained on St John Baptist's Day, 1537, along with Loyola himself, by Vincenzo (or Antonio) Niguanti, bishop of Arba. A war which broke out between Turkey and Venice made the intended journey to Palestine impracticable; and accordingly Loyola, Faber, and Laynez betook themselves to Rome, while the others dispersed themselves through the chief university towns of North Italy, and began their work as home missionary preachers; and it was immediately before they separated on this occasion, at Vicenza in November 1537, that Loyola announced his intention that their fellowship should henceforward be known as the "Company of Jesus," and that, abandoning their original plan of a purely Oriental mission, they should offer themselves to the pope as a special militia. It may be here remarked that the more popular name "Jesuits" seems to have been first used by Calvin, and it appears also in the register of the parliament of Paris as early as 1552, while the enemies of the society in Spain usually spoke of its members as "Injigistas," after the name of its founder.

On their arrival at Rome, the three Jesuits were favourably received by Paul III., who at once appointed Faber to the chair of Biblical exegesis, and Laynez to that of scholastic theology, in the college of Sapienza. But they encountered much opposition, and were even charged with heresy, nay, when this accusation had been disposed of, there still were difficulties in the way of starting any

new order. Despite the approval of Contarini, and the goodwill of the pope himself (who is said to have exclaimed, on perusing Loyola's papers, "The finger of God is here"), there was a strong and general feeling that the monastic system had broken down utterly, and could not be wisely developed further. Cardinal Guidicioni, one of a committee of three appointed to examine the draft constitutions, was known to advocate the abolition of all existing orders save four, which were to be remodelled and put under strict control. And it was that very year, 1533, that a committee of cardinals, consisting of Reginald Pole, Contarini, Sadolet, Caraffa (afterwards Paul IV.), Fregoso, Alseander, and Badia, had just reported to the pope that the conventual orders were such a scandal to Christendom that they should be all abolished—"abolentis putamus omnes." Not only so, but, when greater strictness of rule and of enclosure seemed the most needful reforms in communities which had become too secular in tone, the proposal of Loyola to make it a first principle that the members of his new institute should mix freely with the world, and be as little marked off as possible externally from secular life and usages, ran counter to all tradition and prejudice, save that Caraffa's then recent order of Theatines, from which Loyola copied some details, had taken some steps in the same direction.

Loyola and his companions, however, had little doubt of ultimate success, and so bound themselves, on April 15, 1539, to obey any superior chosen from amongst their body, and added on May 4 certain other rules, the most important of which was the vow of special allegiance to the pope for mission purposes, to be taken by all members of the society. But Guidicioni, on a careful study of the papers, changed his mind,—partly, it is supposed, because of the strong interest in the new scheme exhibited by the king of Portugal, who instructed his ambassador to press it on the pope, and to ask Loyola himself for some priests of his society for mission work in Portugal and its Indian possessions, and accordingly Xavier and Rodriguez were sent to the king in March 1540. And on September 27, 1540, the bull *Regimini militantis ecclesie* was published, confirming the new order, but limiting its members to sixty, a restriction which was removed by a later bull in March 1543. In the Latin translation of the original draft constitution, approved by the pope, the word *compania* was represented by *societas*, though *cohors* or some such military term would have more exactly reproduced the founder's idea, and thus the Jesuit body is known indifferently as "Company" or "Society," while the title "Order" is never officially given to it. This title was finally settled by Gregory XIV. in a bull of June 28, 1594.

On April 7, 1541, Loyola was unanimously chosen superior. His refusal of this post was overruled, so he entered on his new office on April 13, and on April 15 the newly constituted society took its formal corporate vows as a religious order in the church of St Paul-without-the-Walls. The general entered on his duties by holding public catechizings in Sta Maria in Strata for eight and forty days, a precedent followed ever since by his successors in office. Scarcely was the society launched when its members dispersed in various directions to their new tasks. Salmeron and Brouet were sent, clothed with the powers of papal legates, on a secret mission to Ireland, to encourage the native clergy and people in resistance to the religious changes introduced by Henry VIII.; Bobadilla went to Naples; Faber, first to the diet of Worms, and then to Spain; Laynez and Le Jay to Germany, while their general busied himself in founding the convent of St Martha at Rome for female penitents, and that of St Catherine for unprotected young women, as also in perfecting the original draft of the constitutions, a task he did not finish till 1550. Success crowned these first efforts, and the earliest college of the society was founded at Coimbra in 1542 by King John III. of Portugal, who secured the appointment of Simon Rodriguez as its rector. It was designed as a training-school to feed the Indian mission, of which Francis Xavier had already taken the oversight, while a seminary at Goa was the second institution founded out of Rome in connexion with the society. In Spain, national pride in the founder aided their cause almost as much as royal patronage in Portugal, and the next house of the society after Goa was opened at Gandia under the protection of its duke, Francis Borgia; in Germany they were eagerly welcomed as the only persons able to meet the Lutherans on equal terms; and only in France, of the countries still belonging to the Roman communion, was their advance checked, owing to political distrust of their Spanish origin, together with the hostility of the Sorbonne and the bishop of Paris. However, after many difficulties, they succeeded in getting a footing through the help of Duprat, bishop of Clermont, who founded a college for them in 1545 in the town of Billom, besides making over to them his house at Paris, the Hôtel de Clermont, which became the nucleus of the afterwards famous college of Louis-le-Grand, while a formal legalization was granted to them by the states-general at Poissy in 1561.

In Rome, Paul III.'s favour did not lessen. He bestowed on them the church of St Andrea, where now Cardinal Alessandro Farnese's stately erection, the Gesù, stands, and conferred on them at the same time the more valuable privilege of altering their own statutes.

besides two others procured in 1546, which Loyola had still more at heart, as touching the very essence of his institute, namely, exemption from ecclesiastical offices and dignities, and from the task of acting as directors and confessors to convents of nuns. The former of these measures effectually stopped any drain of the best numbers away from the society, and limited their hopes within its bounds, by putting them more fully at the general's disposal, especially as it was provided that the final vows could not be annulled, and that only the joint action of the general and the pope could dismiss a professed member from the society. The regulation as to convents seems due partly to a desire to avoid the worry and expenditure of time involved in the discharge of such offices, and partly to a conviction that penitents of the kind would be of no effectual use to the society; whereas Loyola, against the wishes of several of his companions, laid much stress on the duty of accepting the post of confessor to kings, queens, and women of high rank, when opportunity presented itself. And the year 1546 is notable in the annals of the society as that in which it embarked on its great educational career, especially by the annexation of free day-schools to all its colleges.

The council of Trent did much to increase the reputation of the new society, for the pope chose three of its members, Laynez, Faber, and Salmeron, to act as his theologians in that assembly, and they had no little influence in framing its dogmatic definitions and decrees. In 1548 the company received a valuable recruit in the person of Francis Borgia, duke of Gandia, afterwards third general, while two important events marked 1550,—the foundation of the Collegio Romano, and a fresh confirmation of the society by pope Julius III. The German college, for the children of poor nobles, was founded in 1552, and in the same year Loyola finally settled the discipline of the society by putting down with promptness and severity some attempts at independent action on the part of Rodriguez at Coimbra; while 1553 saw the despatch of a mission to Abyssinia, and the first quarrel of the society with the pope, who thought that the Spanish Jesuits were taking part with the emperor against the Holy See, but was reconciled by the good offices of Ferdinand, king of the Romans. Paul IV. (whose election at first alarmed the Jesuits, for they had found him not very friendly as Cardinal Caraffa) proved as favourable to them as his predecessors; and when Ignatius Loyola died in 1556 under his pontificate, the society already counted forty-five professed fathers and two thousand ordinary members, distributed over twelve provinces, with more than a hundred colleges and houses. After two years' interregnum, Laynez, who had acted as vicar in the meanwhile, was elected general in 1558, and was successful in a struggle with the pope, who desired to enforce the recitation of the breviary on the society, and to limit the tenure of the generalship to a term of three years, but could effect neither object. Laynez also succeeded in increasing further the already enormous powers of the general, by adding these four clauses to the constitutions:—that the general alone can make contracts binding the society; that he can authoritatively gloss and interpret the rules and laws, can enact new or repeal old laws, and may have prisons for the incarceration of refractory members. He took a leading part in the colloquy of Poissy in 1561 between the Catholics and Huguenots, and obtained, as already said, a legal footing from the states-general for colleges of the society in France. He died in 1564, leaving the society increased to eighteen provinces, with a hundred and thirty colleges, and was succeeded by Francis Borgia. It was during his generalship that the greatest favour yet vouchsafed the company was bestowed by Pius V., who not only confirmed by bull all former privileges, and extended to it further every privilege that had been or might afterwards be granted to any order with vows of poverty, but also decreed that these letters should at no time be capable of being revoked, limited, or derogated from by the Holy See, nor be included within any revocation of similar or dissimilar privileges, but be for ever excepted therefrom. It was a trifling set-off to such a grant that the pope in 1567 again enjoined the fathers to recite the canonical hours in choir, and to admit only the professed to priest's orders, especially as Gregory XIII. rescinded both these injunctions in 1573; and indeed, as regards the hours, all that Pius V. was able to obtain was the nominal concession that the breviary should be recited in the professed houses only, and that not of necessity by more than two persons at a time. Eberhard Mercurian, a Fleming, succeeded Borgia in 1572 (being forced on the company by the pope, in preference to Polanco, Loyola's secretary and then vicar-general, who was rejected partly as a Spaniard, and still more because he was a "New Christian" of Jewish origin, and therefore objected to in Spain itself), and was in turn followed by Claudio Acquaviva, an able and strong-willed man, who sat from 1581 to 1615, a time almost exactly coinciding with the high tide of the great and successful counter-Reformation movement, chiefly due to the Jesuits, which had begun under Borgia. It was, however, during his generalship that the company's evil reputation began to eclipse its good report, that they first had the pope their avowed enemy, and that they were driven from England (whither they had come chiefly from the seminary founded at Douay by Cardinal Allen in 1568),



once in 1581, and again in 1601, as conspirators against the life of Queen Elizabeth, and later again for their share in the Gunpowder Plot; from France as accomplices in the attempt of Châtel to assassinate Henry IV.; and from Antwerp as having resisted the pacification of Ghent. It is true that the edict of the parliament of Paris in 1594, which banished them from France, was revoked in 1603, by desire of Henry IV., who permitted them to return under conditions; and this fact has been much relied on by Jesuit writers in proof of their innocence of all complicity in Châtel's plot. But as Sully has recorded for us that Henry declared his only motive to be the expediency of not driving them into a corner, and so inducing them to murder him through despair or revenge, and that his only hope of tranquillity lay in appeasing them, his conduct does not tell much in their favour.

It was also during Acquaviva's generalship that Philip II. of Spain complained bitterly of the company to Pope Sixtus V., and encouraged him in those plans of reform which were cut short by his death in 1590, and also that the long-protracted discussions on grace, wherein the Dominicans contended against the Jesuits, were carried on at Rome, with little practical result, by the Congregation *De Auxiliis*, which began to sit in 1598, and continued till 1607. He saw too the expulsion of the Jesuits from Venice in 1606 for siding with Paul V. when he placed the republic under an interdict, but did not live to see their recall, which took place at the intercession of Louis XIV. in 1657. But the concessions made to the company by Gregory XIV., successor of Sixtus V., during his short reign of twelve months, almost seemed to compensate for all these troubles; for he not only confirmed all existing privileges, but conferred also that of being able to expel members of the society without any form of trial, or even documentary procedure, besides denouncing excommunication against every one save the pope or his legates who directly or indirectly infringed the constitutions of the society, or attempted to bring about any change therein.

Under Vitelleschi, Acquaviva's successor, the first centenary of the society was held on September 25, 1639, the hundredth anniversary of the verb *I* approbation given to the draft constitutions by Paul III., and there were then thirty-six provinces, with eight hundred houses, containing fifteen thousand Jesuits. It was in the following year that the great controversy which raged for a century in the Latin Church broke out by the posthumous publication of the *Augustinus* of Cornelius Jansen, bishop of Ypres, in which the Jesuits took the leading part, and finally secured the victory for their teaching throughout the Roman obedience. It was in this same year 1640 that, considering themselves ill-used by the count-duke Olivarez, prime minister of Philip IV. of Spain, they powerfully aided the revolution which placed the duke of Braganza on the throne of Portugal, and their services were rewarded with a practical control of ecclesiastical and almost of civil affairs in that kingdom, which lasted for more than a hundred years.

The society also gained ground steadily in France, for, though held in check during Richelieu's life, and little more favoured by Mazarin, yet from the moment Louis XIV. assumed the reins of government, their star was in the ascendant, and Jesuit confessors, the most celebrated of whom were La Chaise and Letellier, guided the policy of the king, not hesitating to take his side in his quarrel with the Holy See, which nearly resulted in a schism, nor to sign the Gallican articles. How their hostility to the Huguenots forced on the revocation of the Edict of Nantes in 1685, and their war against Jansenism did not cease till the very walls of Port Royal were demolished in 1710, even to the abbey church itself, and the bodies of the holy dead taken with every mark of insult from their graves, and literally flung to the dogs to devour, is well known. But, while thus gaining power in one direction, the company was losing it in others. The Japanese mission had vanished in blood by 1651, and, though many Jesuit fathers and their converts died bravely as martyrs for the faith, yet it is impossible to acquit them of a large share in the causes of that overthrow. And it was about this same period that the grave scandal of the Chinese and Malabar rites, already referred to, began to attract attention in Europe, and to make thinking men ask seriously whether the Jesuit missionaries taught anything which could be fairly called Christianity at all. When it is remembered, too, that they decided in a council at Lima that it was inexpedient to impose any act of Christian devotion except baptism on their South American converts, without the greatest precautions, on the ground of intellectual difficulties, it is not wonderful that this doubt was not satisfactorily cleared up, notably in face of the charges brought against the society by Bernardin de Cardenas, bishop of Paraguay, and the saintly Palafox, bishop of Angelopolis in Mexico, whom they persecuted till he had to fly for his life, and could be protected by the pope himself only by his translation to a European see. As regards their North American work, the Abbé Badiche, continuator of Helyot, pays the Jesuits the doubtful compliment of saying that the Red Indian tribes which accepted the gospel with joy, "learned to mingle Jesus Christ and France together in their affection."

The seeds of decay were already germinating within the company itself. A succession of devout but incapable generals after the death

of Acquaviva saw the gradual secularization of tone by the flocking in of recruits of rank and wealth, desirous to share in the glories and influence of the company, but not well adapted to increase them, and too readily admitted on merely temporal grounds; while the old strict discipline was relaxed, as the professed fathers gradually encroached on the general's authority, till they went the length, in 1661, of appointing a vicar-general with powers which practically superseded those of the general, Goswin Nickel, whom they did not think it expedient to depose formally. And, though the political weight of the company continued to increase in the cabinets of Europe, yet it was being steadily weakened internally. They abandoned, too, the system of free education, which had won them so much influence and honour; by attaching themselves exclusively to the interests of courts, they lost favour with the middle and lower classes; and, above all, their monopoly of power and patronage in France, with the fatal use they had made of it, drew down the bitterest hostility upon them. It was indeed to their credit that the Encyclopedists attacked them as the foremost representatives of Christianity, but they are accountable in no small degree for the unfavourable opinion of the nature and merits of Christianity itself which their opponents entertained. But that part of the policy of the company which proved most fatal to it, and served as the pretext of the attacks before which it fell, was its activity, wealth, and importance as a great trading firm, with branch houses scattered over the richest producing countries in the world. Its founder, with a wise instinct, had forbidden the accumulation of wealth; its own constitutions, as revised in the eighty-fourth decree of the sixth general congregation, had forbidden all pursuits of a commercial nature, as also had various popes, rescinding the decree of Gregory XIII.; but nevertheless, the trade went on unceasingly. The first mutterings of the storm which was soon to break were heard in a severe brief issued in 1741 by Benedict XIV., the most learned and able of the later popes, wherein he denounced the Jesuits as "disobedient, contumacious, captious, and reprobate persons," and enacted many stringent regulations for their better government; and this was followed up by two bulls, *Ex quo singulari* in 1742, and *Omnia sollicitudinem* in 1744, striking at their continued insubordination in the matter of the Chinese rites, which, however, did not save them from an edict of banishment from China itself in 1753, and the last of them disappeared thence in 1774.

The first serious attack came from a country where they had been long dominant. In 1753 Spain and Portugal exchanged certain American provinces with each other, which involved a transfer of sovereign rights over Paraguay, but it was provided that the populations should severally migrate also, that the subjects of each crown might remain the same as before. The inhabitants of the "reductions," whom the Jesuits had trained in the use of European arms and discipline, rose in revolt, and attacked the troops and authorities. Their previous docility, and their entire submission to the Jesuit missionaries, left no doubt possible as to the source of their rebellion, though direct proof was, as usual, lacking; and the matter was not soon forgotten. In 1757 Carvalho, marquis of Pombal, prime minister of Joseph I. of Portugal, dismissed the three Jesuit chaplains of the king, and named three secular priests in their stead. He next complained to Benedict XIV. that the trading operations of the society hampered the commercial prosperity of the nation, and asked for remedial measures. The pope granted a visitation of the society, and committed it to Cardinal Saldanha, a close intimate of Pombal's. He issued a severe decree against the Jesuits, and ordered the confiscation of all their merchandise.

But at this juncture Benedict XIV. died, and was succeeded, much as had happened on several previous occasions, by a pope strongly in favour of the Jesuits, Cardinal Rezzonico, who took the title of Clement XIII. Pombal, finding that no help was to be expected from this quarter, adopted other means. The king was fired at and wounded on returning from an assignation with his mistress, the marchioness of Tavora, September 3, 1758. The duke of Aveiro, the marquis of Tavora, and other persons of high rank were tried and executed for conspiracy, while some of the Jesuits, who had undoubtedly been in communication with them, were charged, on evidence whose value there are no certain means of testing, but which seems very doubtful, with complicity in the attempted assassination. Pombal charged the whole society with its guilt, and, unwilling to await the dubious issue of an application he had made to the pope for licence to try them in the civil courts, whence they were exempt, issued a decree on September 1, 1759, ordering their immediate deportation from Portugal and all its dependencies, and their supersession by the bishops in the schools and universities. Those in Portugal were at once shipped to Italy, and such as were in the colonies expelled speedily after. In France, Madame de Pompadour was their enemy,—it is said, because they endeavoured to make her break off her connexion with Louis XV., and refused her absolution on any other terms; but the immediate cause of their ruin was the bankruptcy of F. Lavalette, the Jesuit administrator of Martinique, a daring speculator, who failed for 2,400,000 francs, and ruined some French commercial houses of note. Ricci, then general of the Jesuits, repudiated the debt,



alleging lack of authority on Lavalette's part to pledge the credit of the society, and was sued by the creditors. Losing his cause, he appealed to the parliament of Paris, and it, to decide the issue raised by Ricci, required the constitutions of the Jesuits to be produced in evidence, and affirmed the judgment of the courts below. But the publicity given to a document scarcely known till then (indeed the first authoritative edition of the *Constitutions* is that of Prague in 1757) raised the utmost indignation against the company. A royal commission, appointed by the duke of Choiseul to examine the constitutions, convoked a private assembly of fifty-one archbishops and bishops under the presidency of Cardinal de Luynes, all of whom except six voted that the unlimited authority of the general was incompatible with the laws of France, and that the appointment of a resident vicar, subject to those laws, was the only solution of the question fair on all sides. Ricci replied with the historical answer, "Sint ut sunt, aut non sint"; and after some further delay, during which much interest was exerted in their favour, the Jesuits were suppressed by an edict in November 1764, but suffered to remain on the footing of secular priests, a grace withdrawn in 1767, when they were expelled from the kingdom. In the very same year, Charles III. of Spain, a monarch known for personal devoutness, convinced, on evidence not now forthcoming, that the Jesuits were plotting against his authority, prepared, through his minister D'Aranda, a decree suppressing the society in every part of his dominions. Sealed despatches were sent to every Spanish colony, to be opened on the same day, April 2, 1767, when the measure was to take effect in Spain itself, and the expulsion was relentlessly carried out, nearly six thousand priests being deported from Spain alone, and sent to the Italian coast, whence, however, they were repelled by the orders of the pope and Ricci himself, finding a refuge at Corta in Corsica, after some months' suffering in overcrowded vessels at sea. The general's object may probably have been to accentuate the harshness with which the fathers had been treated, and so to increase public sympathy, but the actual result of his policy was blame for the cruelty with which he enhanced their misfortunes, for the poverty of Corsica made even a bare subsistence scarcely procurable for them there. The Bourbon courts of Naples and Parma followed the example of France and Spain, and Clement XIII. retorted with a bull launched at the weakest adversary, and declaring the rank and title of the duke of Parma forfeit. The Bourbon sovereigns threatened to make war on the pope in return (France, indeed, seizing on the county of Avignon), and a joint note demanding a retraction, and the abolition of the Jesuits, was presented by the French ambassador at Rome on December 10, 1768, in the name of France, Spain, and the Two Sicilies. The pope, a man of eighty-two, died of apoplexy, brought on by the shock, early in 1769. Cardinal Lorenzo Ganganelli, a Franciscan, was chosen to succeed him, and took the name of Clement XIV. He endeavoured to avert the decision forced upon him, but, as Portugal joined the Bourbon league, and Maria Theresa with her son the emperor Joseph II. ceased to protect the Jesuits, there remained only the petty kingdom of Sardinia in their favour, though the fall of Choiseul in France raised the hopes of the society for a time. The pope began with some preliminary measures, permitting first the renewal of lawsuits against the society, which had been suspended by papal authority, and which, indeed, had in no case been ever successful at Rome. He then closed the Collegio Romano, on the plea of its insolvency, seized on the houses at Frascati and Tivoli, and broke up the establishments in Bologna and the Legations at large. Finally, on July 21, 1773, the famous brief *Dominus ac Redemptor* appeared, suppressing the Society of Jesus. This remarkable document opens by citing a long series of precedents for the suppression of religious orders by the Holy See, amongst which occurs the ill-omened instance of the Templars. It then briefly sketches the objects and history of the Jesuits themselves. It speaks of their defiance of their own constitution, expressly revived by Paul V., forbidding them to meddle in politics; of the great ruin to souls caused by their quarrels with local ordinaries and the other religious orders, their conformity to heathen usages in the East, and the disturbances, resulting in persecutions of the church, which they had stirred up even in Catholic countries, so that several popes had been obliged to punish them. Seeing then that the Catholic sovereigns had been forced to expel them, that many bishops and other eminent persons demanded their extinction, and that the society had ceased to fulfil the intention of its institute, the pope declares it necessary for the peace of the church that it should be suppressed, extinguished, abolished, and abrogated for ever, with all its ritea, houses, colleges, schools, and hospitals; transfers all the authority of its general or officers to the local ordinaries; forbids the reception of any more novices, directing that such as were actually in probation should be dismissed, and declaring that profession in the society should not serve as a title to holy orders. Priests of the society are given the option of either joining other orders or remaining as secular clergy, under obedience to the ordinaries, who are empowered to grant or withhold from them licences to hear confessions. Such of the fathers as are engaged in the work of education are permitted to continue, on condition of abstaining from lax and question-

able doctrines, apt to cause strife and trouble. The question of missions is reserved, and the relaxations granted to the society in such matters as fasting, reciting the hours, and reading heretical books, are withdrawn; while the brief ends with clauses carefully drawn to bar any legal exceptions that might be taken against its full validity and obligation. It has been necessary to cite these heads of the brief, because the apologists of the society allege that no motive influenced the pope save the desire of peace at any price, and that he did not believe in the culpability of the fathers. The categorical charges made in the document, and that in the most solemn fashion, rebut this plea. The pope followed up this brief by appointing a congregation of cardinals to take possession of the temporalities of the society, and armed it with summary powers against all who should attempt to retain or conceal any of the property. He also threw Lorenzo Ricci, the general, into prison in the castle of St Angelo, where he died in 1775, under the pontificate of Pius VI., who, though not unfavourable to the company, and owing his own advancement to it, dared not release him, probably because his continued imprisonment was made a condition by the powers who enjoyed a right of veto in papal elections. In September 1774 Clement XIV. died after much suffering, and the question has been hotly debated ever since whether poison administered by the Jesuits was the cause of his death. It is impossible to decide the doubt, as the opinions and evidence on each side are nearly balanced. On the one hand, Salicetti, the pope's physician, denied that the body showed signs of poisoning, and Tauucci, Neapolitan ambassador at Rome, who had a large share in procuring the brief of suppression, entirely acquits the Jesuits, while F. Theiner, no friend to the company, does the like. On the other hand, Scipio de' Ricci, bishop of Pistoia, nephew and heir of the unfortunate general, distinctly charges the Jesuits with the crime, as also does Cardinal de Bernis; and the report by the Spanish minister to the court of Madrid, printed by De Potter in his *Vie et Memoires de Scipion de Ricci*, vol. iii. pp. 151-74, contains the noteworthy fact that the date of the pope's death was predicted beforehand, notably in a statement made by the vicar-general of Padua to the secretary of the congregation for Jesuit affairs, that several members of the company, believing him to be one of their friends, told him that the pope would die before the end of September.

At the date of this suppression, the company had 41 provinces and 22,589 members, of whom 11,295 were priests. Far from submitting to the papal brief, the Jesuits, after some ineffectual attempts at direct resistance, withdrew into the territories of the non-Roman-Catholic sovereigns of Russia and Prussia, Frederick II. and Catherine II., both of them freethinkers, who became their active friends and protectors; and the fathers alleged as a principle, in so far as their theology is concerned, that no papal bull is binding in a state whose sovereign has not approved and authorized its publication and execution. Russia formed the headquarters of the company; and two forged briefs were speedily circulated, being dated June 9 and June 29, 1774, approving their establishment in Russia, and implying the repeal of the brief of suppression. But these are contradicted by the tenor of five genuine briefs, all issued in September of that year to the archbishop of Gnesen, and making certain assurances to the Jesuits, on condition of their complete obedience to the injunctions already laid on them. They also pleaded a verbal approbation by Pius VI., technically known as an *Oraculum vive vocis*, but no proof of either its existence or its validity is forthcoming.

They elected three Poles successively as generals, taking, however, only the title of vicars, till on March 7, 1801, Pius VII. granted them liberty to reconstitute themselves in North Russia, and permitted Karen, then vicar, to exercise full authority as general. On July 30, 1804, a similar brief restored the Jesuits in the Two Sicilies, at the express desire of Ferdinand IV., the pope thus anticipating the further action of 1814, when, by the brief *Sollicitudo omnium Ecclesiarum*, he revoked the action of Clement XIV., and formally restored the society to corporate legal existence, yet not only omitted any censure of his predecessor's conduct, but all vindication of the Jesuits from the heavy charges in the brief *Dominus ac Redemptor*. In France, even after their expulsion in 1765, they had maintained a precarious footing in the country under the partial disguise and names of "Fathers of the Faith," or "Clerks of the Sacred Heart," but were obliged by Napoleon I. to retire in 1804. They reappeared under their true name in 1814, and obtained formal licence in 1822, but became the objects of so much hostility that Charles X. deprived them by ordinance of the right of instruction, and obliged all applicants for licences as teachers to make oath that they did not belong to any community unrecognized by the laws. They were dispersed again by the revolution of July 1830, but soon reappeared, and, though put to much inconvenience during the latter years of Louis Philippe's reign, notably in 1845, maintained their footing, recovered the right to teach freely after the revolution of 1848, and gradually became the leading educational and ecclesiastical power in France, notably under the second empire, till they were once more expelled.



by the Ferry laws of 1830, though they have been quietly returning since the execution of those measures. In Spain they came back with Ferdinand VII., but were expelled at the constitutional rising in 1820, returning in 1823, when the duke of Angoulême's army replaced Ferdinand on his throne; they were driven out once more by Epartero in 1835, and have had no legal position since. In Portugal, ranging themselves on the side of Don Miguel, they fell with his cause, and were exiled in 1834. Russia; which had been their warmest patron, drove them from St Petersburg and Moscow in 1813, and from the whole empire in 1820, mainly on the plea of attempted proselytizing in the imperial army. Holland drove them out in 1816, and, by giving them thus a valid excuse for aiding the Belgian revolution of 1830, secured them the strong position they have ever since held in Belgium. They were expelled from Switzerland in 1847-48 for the part they had taken in exciting the war of the Sonderbund. In South Germany, inclusive of Austria and Bavaria, their annals since their restoration have been uneventful; but in North Germany, owing to the footing Frederick II. had given them in Prussia, they became very powerful, especially in the Rhine provinces, and, gradually moulding the younger generation of clergy after the close of the War of Liberation, succeeded in spreading Ultramontane views amongst them, and so leading up to the difficulties with the civil Government which issued in the Falk laws, and their own expulsion by decree of the German parliament, June 19, 1872. In Great Britain, whither they began to straggle over during the revolutionary troubles at the close of the last century, and where, practically unaffected by the clause directed against them in the Emancipation Act of 1829, their chief settlement has been at Stonyhurst in Lancashire, an estate conferred on them by Mr Weld in 1795, they have been unmolested; but there has been little affinity to the order in the British temperament, and the English province has consequently never risen to numerical or intellectual importance in the society. In Rome itself, its progress after the restoration was at first slow, and it was not till the reign of Leo XII. (1823-29) that it recovered its place as the chief educational body there. It advanced steadily under Gregory XVI., and, though it was at first shunned by Pius IX., it secured his entire confidence after his return from Gaeta in 1843, and obtained from him a special brief erecting the staff of its literary journal, the *Civiltà Cattolica*, into a perpetual college under the general of the Jesuits, for the purpose of teaching and propagating the faith in its pages. How, with this pope's support throughout his long reign, and the gradual filling of nearly all the sees of Latin Christendom with bishops of their own selection, they contrived to stamp out the last remains of independence everywhere, and to crown the Ultramontane triumph with the Vatican decrees, is matter of familiar knowledge.

The society has been ruled by twenty-two generals and four vicars from its foundation to the present day; and the most notable fact to

signalize with reference to them is that, of all the various nationalities represented in the company, France, its original cradle, has never given it a head, while Spain, Italy, Holland, Belgium, Germany, and Poland were all represented. The numbers of the society at present are not accurately known, but are estimated at about 6000 in all parts of the world.

The generals of the Jesuits have been as follows:—

1. Inigo de Loyola (Spaniard).....	1541-1556
2. Diego Laynez (Spaniard).....	1558-1565
3. Francisco Borgia (Spaniard).....	1565-1572
4. Eberhard Mercurian (Belgian).....	1573-1580
5. Claudio Acquaviva (Neapolitan).....	1581-1615
6. Mutio Vitelleschi (Roman).....	1615-1645
7. Vincenzo Caraffa (Neapolitan).....	1646-1649
8. Francesco Piccolomini (Florentine).....	1649-1651
9. Alessandro Gottofredi (Roman).....	1652
10. Goswin Nickel (German).....	1652-1664
11. Giovanni Paolo Oliva (Genoese) vicar-general and coadjutor, 1661; general.....	1664-1681
12. Charles von Noyelle (Belgian).....	1682-1686
13. Tirso Gonzalez (Spaniard).....	1687-1705
14. Michele Angelo Tamburini (Modenese).....	1706-1730
15. Franz Retz (Bohemian).....	1730-1750
16. Ignazio Visconti (Milanese).....	1751-1755
17. Alessandro Centurioni (Genoese).....	1755-1757
18. Lorenzo Ricci (Florentine).....	1758-1775
a. Stanislaus Czerniewicz (Pole), vicar-general.....	1782-1785
b. Gabriel Lienkiewicz (Pole), ".....	1785-1798
c. Francisus Xavier Karcu (Pole), (general in Russia, 7th March 1801).....	1799-1802
d. Gabriel Gruber (German).....	1802-1805
19. Thaddæus Brzozowski (Pole).....	1805-1820
20. Aloysio Fortis (Veronese).....	1820-1829
21. Johannes Rootbaan (Dutchman).....	1829-1853
22. Peter Johannes Beckx (Belgian).....	1853

The bibliography of Jesuitism is of enormous extent, and it is impracticable to cite more than a few of the most important works. They are as follows:—*Institutum Societatis Jesu*, 7 vols., Avignon, 1830-38; Orlandini, *Historia Societatis Jesu*, Aatwerp, 1620; *Inago Primi Seculi Societatis Jesu*, Antwerp, 1640; Nieckenberg, *Vita de San Ignatio de Loyola*, 9 vols. fol., Madrid, 1645-1736; Genelli, *Life of St Ignatius of Loyola*, London, 1872; Becker, *Bibliothèque des Ecritures de la Compagnie de Jésus*, 7 vols., Paris, 1853-61; Créneau Joly, *Histoire de la Compagnie de Jésus*, 6 vols., Paris, 1844; Guettée, *Histoire des Jésuites*, 3 vols., Paris, 1858-59; Stewart Rese, *Ignatius Loyola and the Early Jesuits*, London, 1871; Wolf, *Allgemeine Geschichte der Jesuiten*, 4 vols., Zurich, 1789-92; Parkman, *Pioneers of France in the New World*, and *The Jesuits in North America*, Boston, 1863; *Lettres Édifiantes et Curieuses, écrites des Missions Étrangères, avec les Annales de la Propagation de la Foi*, 40 vols., Lyons, 1819-54; Saint-Priest, *Histoire de la Chute des Jésuites au XVIII<sup>e</sup> Siècle*, Paris, 1844; Ranke, *Römische Papste*, 3 vols., Berlin, 1838; and Cartwright, *The Jesuits, their Constitution and Teaching*, London, 1876. (R. F. L.)

## J E S U S C H R I S T

THE Christian religion, besides its natural and spiritual elements, has also an historical element. It believes that, in accordance with a Divine purpose, prophesied at the very dawn of human life, God was manifest in the flesh in the man Christ Jesus. The actual life of Jesus on earth is but the central part of a scheme which, in the belief of Christians, extends through all the ages. Our present object is merely to furnish a brief sketch of that life as it appears in the full light of history, without entering into the numberless collateral questions which it offers for consideration, a task which in these limits is obviously impossible.

I. The word Jesus is the form assumed in Latin by the Greek *Iesous*, which is the transliterated form of the Hebrew Jehoshua, Jeshua, or Joshua, meaning "Jehovah is salvation." In one or other of its forms the name is found in many passages of the Old Testament. It was not, however, borne by any person who rose to historic eminence between the days of Joshua the son of Nun and the high priest Joshua who was the colleague of Zerubbabel at the return from the exile. The prominent position held by Joshua in the later prophetic books seems to have made the name popular. We find frequent traces of it after the exile.<sup>1</sup> During the Hellenizing period, which excited so deep an indignation among patriotic Jews, many of the

bearers of the name preferred to adopt the purely Greek analogon Jason,<sup>2</sup> and the name occurs in this form in the New Testament also.<sup>3</sup> Later on it became one of the commonest Jewish names which we find in the New Testament,<sup>4</sup> and again and again in Josephus.<sup>5</sup> There is some reason for believing that the name of Bar Abbas was also "Jesus," although it may have disappeared from the chief manuscripts, partly from feelings of reverence, partly from the mistaken fancy of Origen that we find no sinner among all those who had borne the name.<sup>6</sup> But the name, though common, was meant to be deeply significant of the work for which Jesus was born into the world—namely, to save His people from their sins; and for this reason, in the account of the Annunciation, as given by St Luke (i. 31), His mother is expressly bidden to call her babe by this name.<sup>7</sup>

<sup>1</sup> 1 Macc. viii. 17, xii. 16; 2 Macc. ii. 19, iv. 7; Jos., *Ant.*, xii. 10, 6. The Greek Jason was connected with *Idemai*, and the Greek fathers by a play on words—of which traces may be found even in the New Testament (Acts iv. 34, x. 38)—connect the name Jesus with the same root (Euseb., *Dem. Evang.*, iv.).

<sup>2</sup> Acts xvii. 5; Rom. xvi. 21.

<sup>3</sup> Acts xiii. 6, xvii. 5, xviii. 7; Rom. xvi. 21; Col. iv. 11.

<sup>4</sup> Jos., *Ant.*, xv. 9, 2, xvii. 13, 1, xx. 9, 1; *B. J.*, iii. 9, 7, iv. 3, 9, vi. 5, 5; *Vit.*, 22.

<sup>5</sup> In MS. S. the reading is said to be found in "exceedingly ancient MSS." It is now chiefly found in some cursive MSS., and the Armenian and Syriac versions. See Origen on Matt. xxvii. 16.

<sup>7</sup> In Matt. i. 21 the same command is given to Joseph. For the

<sup>1</sup> Jos., *Ant.* xii. 5, 1 and 10, 6, xv. 3, 1; *Eclus.*, prol., l. 27, &c.

On the other hand, the word Christ was not originally a name but a title.<sup>1</sup> In the Gospels we scarcely ever read of Christ, but always of "the Christ."<sup>2</sup> It was only after the resurrection that the title gradually passed into a name, and "Jesus Christ," or later still "Christ Jesus," becomes one designation. The Greek word means "anointed," and is a translation of the Hebrew "Messiah." The coming Deliverer for whom the Jews had yearned for so many centuries was spoken of as the "anointed one," with special reference to the prophecies of Isaiah (lxi. 1) and Daniel (ix. 24-26), which again referred backward to the language of the Psalms (ii. 2, xx. 6, xlv. 7). The anointing of Jesus was the special outpouring of the Holy Spirit upon Him, not only throughout His life (Acts x. 38), but specially at His baptism (John i. 32). Unction was the recognized mode of consecrating any one to the offices of priest (Ex. xxix. 29; Lev. iv. 3) and king (1 Sam. x. 1, xxiv. 6); and prophets were supposed to be anointed by God's grace for the fulfilment of their task (Isa. lxi. 1). The Messiah combined in His office the threefold dignity. He was a prophet to reveal (John vi. 14; Matt. xiii. 57; Luke xiii. 33, xxiv. 19), a king to reign and to judge (Luke xxiii. 2; Acts xvii. 7; 1 Cor. xv. 24; Rev. xv. 3), and a high priest to offer up the sacrifice of Himself (Heb. ii. 17 and *passim*).

Since these, however, were distinctively Jewish conceptions, it was natural that they should be but little understood by the Greeks and Romans. The word "anointed" conveyed to them no sacred conceptions, and it was restamped (*surfrappe*) by them into accordance with their own notions. They fancied that the real name of the founder of the new religion must be *Chrestus* or "excellent,"<sup>3</sup> and they constantly spoke of the Christians as "Chrestians." Suetonius says that the Jews were expelled from Rome by Claudius because they were raising seditions at the constant instigation of "Chrestus"; and he cared so little to inform himself on the subject that he made no distinction between Jews and Christians, and seems to have imagined that "Chrestus" was some leader of sedition then living at Rome.<sup>4</sup> On the other hand the Christians in no wise objected to the mistaken designation. "If you call us Christians," said Tertullian, if you bear witness to the name of our master; if you call us 'Chrestians,' you testify to the blamelessness of our lives."<sup>5</sup>

II. The designation of "the Christ" given to Jesus shows that His followers saw in Him the long-promised Messiah of Judaism; and the rapidity with which the title developed into a name proves the strength and permanence

of this conviction. And this much at least is conceded by all, that Jesus more than fulfilled the conditions for which the Jews had hoped in the Deliverer of whom so many prophets had spoken, and that He fulfilled them in a manner transcendently wider, deeper, and more permanent than even the prophets had fully foreseen. Even the most advanced sceptic cannot deny that by His life and teaching He has altered the entire current of human history, and raised the standard of human morality. He was, says Renan, "the individual who had made the species take the greatest step towards the divine."<sup>6</sup> But as His life was passed and His work accomplished, not in a corner,<sup>7</sup> but on the open stage and under the full light of a civilized epoch, it becomes a matter of great importance to estimate the value of the sources from which our knowledge of His life is derived. Those sources are (1) heathen, (2) Jewish, and (3) Christian.

1. The knowledge derivable from heathen sources, if much smaller than we could have desired, or *a priori* expected, is not smaller than is fully accounted for in the simple and unsophisticated narratives preserved for us by the evangelists and apostles. They show us that Christianity began from the most humble origin, and was regarded by the whole non-Christian world—alike Jewish and pagan—with unconcealed hatred, largely mingled with a contempt which ultimately passed into terror and exasperation. They faithfully record for us the obscure position, the extreme poverty, the persecuted lives, the unlearned training of the apostles, and the disdain to which they were on all sides subjected. The silence of contemporary Gentile and Jewish writers, which would be otherwise inexplicable, finds its undesigned explanation in the New Testament itself, which never attempts to conceal the contemptuous indignation of the Jewish aristocracy, and the lordly indifference of the higher Gentile authorities.

Accordingly, from heathen writers we do not learn a single *new* fact respecting Jesus Christ, while yet all that they do tell us, even when expressed in language of calumny and abhorrence, proves the historical reality of the facts which the Gospels record. If it be true that Napoleon once asked Herder whether Jesus ever lived at all, such a passing phase of incredulity is so perfectly unreasonable that it has long been abandoned even by the most destructive critics. Whether there ever existed any authentic census tables of Quirinius, or any official report of Pilate to the emperor Tiberius or not,<sup>8</sup> Tacitus tells us with perfect accuracy that the founder of Christianity had been put to death in the reign of Tiberius by the procurator Pontius Pilate, and that his religion, which Tacitus calls a "deadly superstition," "though crushed for a time, burst forth again, not only throughout Judæa, in which it sprung up, but even in Rome, the common reservoir for all the streams of wickedness and infamy." He further tells us that Nero diverted from himself the odium of the burning of Rome by charging the crime upon the Christians; and, though he implies that their fate was not undeserved because of their universal misanthropy, he yet honestly admits that they were not guilty of this crime of incendiarism, on pretence of which they were subjected to the most awful forms of martyrdom.<sup>9</sup> It is clear that Tacitus, in common with all his contemporaries, confounded the Christians with the Jews, only regarding them as being Jews whose belief was more than usually abject. How little information could be expected from this eminent historian appears from the credulity with which he accepted

significance of the name see Eccles. xlvi. 1, where it is said of Joshua that, "according to his name, he was made great for the saving of the elect of God."

<sup>1</sup> "Non proprium nomen est, sed nuncupatio potestatis et regni," Lactant., *Div. Inst.*, iv. 7.

<sup>2</sup> The only exceptions are Matt. i. 1, 18, Mark i. 1, John i. 17 (which are all in the headings and prefaces), and John xvii. 3, where we find "Jesus Christ." The only other passages in which the article is omitted before "Christ" in the Gospels are Mark ix. 41, Luke ii. 11, xxiii. 2, John ix. 22. Thus Matt. ii. 4 is "where the Christ should be born"; Matt. xi. 2 is "John hearing in prison the works of the Christ," i.e., Messianic works; and Matt. xxii. 42 is "what think ye of the Messiah?"

<sup>3</sup> There is a possible allusion to the similar sound of the two words in 1 Pet. ii. 3, ὅτι χριστὸς ὁ Κύριος.

<sup>4</sup> The Romans did not fully learn to discriminate Jews from Christians, and to recognize the latter as members of an entirely distinct religion, until the savage attacks upon Christians by the Jewish false Messiah Barcochba, in the reign of Hadrian, 132 A. D.

<sup>5</sup> Χριστιανὸν γὰρ εἶναι κατηγοροῦμεθα, τὸ δὲ χριστὸν μισοῦσθαι οὐ δικαίον, Tert. Mart., *Apol.*, i. 4; Ἀδρῖκα οἱ εἰς Χριστὸν πεπιστευκότες χριστοὶ τε εἶσι καὶ λέγονται, Clem. Alex., *Strom.*, ii. 4, § 18. *Christianus vero* . . . de nocturne deducitur, sed et cum perperam *christianus* pronunciatur a vobis (nam nec nominis certa est notitia peus vos) de euvaitate et benignitate compositum est," Tert., *Adv. Gentes*, ii., comp. Lactantius, *Div. Inst.*, iv. 7, 5; Jerome on Gal. v. 22.

<sup>6</sup> *Life of Jesus*, p. 457.

<sup>7</sup> Acts xxvi. 26.

<sup>8</sup> A writing called "the Acts of Pilate" existed in the 2d century (Justin, *Apol.*, i. 35), and long continued to be used in heathen schools to warn boys against the belief of the Christians (Euseb., *H. E.*, i. 9, ix. 5).

<sup>9</sup> Tac., *Ann.*, xv. 44.



the most foolish legends and calumnies about the origin and early history even of the Jews.<sup>1</sup> His contemporary Suetonius evidently held the same opinions. He seems to regard Nero as a public benefactor because he punished the Christians, "a class of men of a strange and pestilent superstition."<sup>2</sup> In his life of Claudius, as we have already seen, he ignorantly confuses Christ with some Chrestus whom he supposes to have been at that time living at Rome.<sup>3</sup> From the younger Pliny, who wrote to the emperor Trajan for advice how to deal with Christians,<sup>4</sup> we learn the valuable fact that they lived lives confessedly innocent, since he was unable to establish against them any crime beyond that of the belief which, like his contemporaries, he regarded as a perverse and extravagant superstition. We learn also from this celebrated letter that nothing could shake the allegiance of Christians to Christ, and that they were accustomed to meet early in the morning to celebrate Him as God with hymns of praise. Later in the 2d century the scoffer Lucian, in his *Death of Peregrinus*, and his *Philopseudes*,<sup>5</sup> spoke with bitter sneers both of Christ and Christians. He alludes to the fact of the crucifixion of Christ, to His miracles, to the mutual love and help which prevailed among His followers, and their belief in Him as a divine person. Passing over the asserted allusions to Christ by Numenius,<sup>6</sup> to His parables in Galerius, and to the earthquake at the crucifixion in Phlegon,<sup>7</sup> we come to the "True Word"<sup>8</sup> of Celsus the Platonist, towards the close of the second century. We only know this by the quotations and refutation of Origen, but it furnishes us with indisputable testimony that in his day the facts of the Gospels from first to last were current in the exact form in which we now possess them (see CELSUS). Thus, from the scanty notices of heathens even, we can derive a confirmation of the main external facts in the life of Christ:—His miracles, His parables, His crucifixion, His claim to divine honour, the devotion, innocence, heroic constancy, and mutual affection of His followers, and the progressive victories won by His religion in despite of overwhelming opposition alike physical and intellectual.

2. From Jewish writers we can glean similar confirmation of the gospel story. Philo indeed is silent. The legends preserved by Eusebius<sup>9</sup>—that Philo had met St Peter in Rome during his mission to the emperor Cains, and that in his book on the contemplative life he is describing not the life of the Essenes and Therapeutæ, but, those of the Christian church in Alexandria founded by St Mark<sup>10</sup>—are valueless. It is extremely probable that Philo had scarcely heard either of Christ or of the Christians.<sup>11</sup> He died after 40 A.D., but at that period Christianity had hardly emerged into the recognition claimed by prominent historical phenomena. The writings of Philo are valuable, not for any light which they throw on the gospel histories, but for the evidence which they afford of prevalent modes of thought and phraseology, in which some even of the apostles shared. When, however, we turn to Josephus, we find in his writings, as now extant, no less than three allusions to events in the gospel history. It cannot be decided with certainty whether two of these passages are genuine as they now stand, but modern opinion tends to the view that in each of the actual allusions to Jesus there is a genuine basis with later Christian interpolations. The passage in which

ne speaks of the preaching and execution of John the Baptist is not disputed,<sup>12</sup> and it is very important as showing that Josephus must have been perfectly well acquainted with the facts of Christ's life, and that he has passed them over, in his usual unscrupulous way, with a reticence due only to dislike or perplexity. For in speaking of St John's preaching he deliberately, and it must be feared dishonestly, excludes the Messianic element from which it derived its main power and significance. In another passage he mentions with strong disapproval the judicial murder by the younger Annas of James the Just, "the brother of Jesus, called the Christ."<sup>13</sup> The passage was early tampered with by Christian interpolators who wished to make it a more emphatic testimony in favour of Christ, but in its present form its genuineness is undisputed.<sup>14</sup> Respecting the third passage, in which Josephus speaks directly of Jesus, the only question is whether it be partly or entirely spurious. Placing in brackets the words which are undoubtedly interpolated, it runs as follows:—

At this time appeared a certain <sup>15</sup> Jesus, a wise man [He indeed He may be called a man, for He was a worker of miracles, a teacher of such men as receive the truth with joy], and He drew to himself many Jews [and many also of the Greeks. This was the Christ]. And when at the instigation of our chief men Pilate condemned Him to the cross, those who had first loved Him did not fall away. [For He appeared to them alive again on the third day, according as the holy prophets had declared this and countless other marvels of Him.] To this day the sect of Christians, called after Him, still exists."<sup>16</sup>

That Josephus wrote the whole passage as it now stands no sane critic can believe. Vespasian, not Jesus, was the Messiah of the "ambiguous oracle" of that apostate Jew.<sup>17</sup> There are, however, two reasons which are alone sufficient to prove that the whole passage is spurious,—one that it was unknown to Origen and the earlier fathers, the other that its place in the text is uncertain. It is now found after the historian's notices of Pilate, but the remarks of Eusebius show that in his time it was found before them.<sup>18</sup> We must conclude then that Josephus preserved a politic silence respecting Christ and the Christians, confining himself to remote allusions; and this was quite possible, because he was writing mainly for Greeks and Romans who were profoundly ignorant of the whole subject. That Josephus knew a great deal more than he chose to say is evident. There is reason to suspect that his account of his own juvenile precocity before the leading teachers of his nation is borrowed from the Gospels,<sup>19</sup> and that his account of his shipwreck on the journey to Rome is not uncoloured by the facts of St Paul's shipwreck about that very time.<sup>20</sup> But the most striking indication of his hostile reticence is found in the chapter of his *Antiquities* which follows the supposed allusion to Jesus.<sup>21</sup> He there breaks his narrative in the most arbitrary manner to drag in a disgusting story of a trick played by the priests of Isis on a Roman lady; and no one who is acquainted with the Jewish calumnies about the incarnation can doubt that in this story we have an oblique and malignant anticipation of the falsehood which ultimately took form in the Talmud and the anti-Christian writings of the later Jews.

From other Jewish sources not a single fact about Jesus can be gleaned. In the unexpurgated editions of the

<sup>1</sup> Tac., *Hist.*, v. 3, 4.

<sup>2</sup> Suet., *Nero*, 16.

<sup>3</sup> Suet., *Claud.*, 16.

<sup>4</sup> Pliny, *Ep.*, x. 97, 98.

<sup>5</sup> See *Philops.*, §§ 13, 16, which have been thought to imply ridicule of Christian miracles.

<sup>6</sup> In Origen, *Cont. Cels.*, iv. 51.

<sup>7</sup> *Ibid.*, ii. 14.

<sup>8</sup> *Λόγος ἀληθής*.

<sup>9</sup> Euseb., *H. E.*, ii. 4.

<sup>10</sup> See also Photius, *Bibl.*, cod. cv.: Jerome, *Cat. Script. Eccl.*; and Suidas.

<sup>11</sup> Philo only mentions a single visit which he paid to Jerusalem (in a fragment *ap. Euseb., Præp. Evang.*, viii. 14).

<sup>12</sup> Jos., *Ant.*, xviii. 5, 2.

<sup>13</sup> *Ant.*, xx. 9, 1.

<sup>14</sup> Origen, *C. Cels.*, i. 47; Euseb., *H. E.*, ii. 23.

<sup>15</sup> *Ἰησοῦς τῆς* is the reading in Euseb., i. 11; and, if the passage be genuine at all, there can be no doubt that this is the true reading.

<sup>16</sup> *Ant.*, xviii. 3, 3.

<sup>17</sup> Jos., *B. J.*, vi. 5, 4,—a passage which, as Hansrath says (*Neutest. Zeitgesch.*, iv. § 4), must have been penned at a peculiarly shameless hour.

<sup>18</sup> Euseb., ii. 6. See Keim, *Jesu von Nazara*, i.

<sup>19</sup> *Vit.*, 2.

<sup>20</sup> *Vit.*, 3.

<sup>21</sup> *Ant.*, xviii. 3. 4

Talmud there are about twenty allusions to Christ and the Christians characterized by intense hatred. He is usually spoken of indirectly as "that man," "the Nazarene," "the fool," "Absalom," "the hung," "the son of Stada," "the son of Pandera." Many allusions to Him are veiled in cryptographs of which the key is in the possession of but few. All the grossest fictions respecting him—that He was a seducer (*mesith*) who had learned magic in Egypt, and had been excommunicated by Rabbi Joshua ben Perachia in the reign of Alexander Jannæus (nearly a century before His birth), and that He was crucified at Lydda, because no one, during forty days, came forward to give any evidence in His favour—are collected in a miserable Jewish tract called the *Toldoth Jeshu*, which may be consigned to oblivion, because even the Jews now regard it with contempt and shame.<sup>1</sup> It is, however, remarkable that from these intensely embittered Jewish sources we derive an absolute confirmation of Christ's stay in Egypt, of His Davidic descent,<sup>2</sup> of His miracles, of His disciples, of His excommunication by the Sanhedrin, of His crucifixion on the evening before the Passover, and even of His innocence,—for not a single crime but that of working miracles by magic, and claiming divine honour, is, even in these sources, laid to His charge. And thus even from pagan and Jewish enemies we derive all that we want and all that we could expect in the recognition of the historic personality of Christ, and of the chief facts in His outward life.

3. If we had nothing to help us but these allusions, the two great facts of Christianity and Christendom would be an inexplicable enigma. In the Christian sources of information all becomes intelligible. Of these we may dismiss for practical purposes all but the New Testament. From the fathers we derive surprisingly little. A few sayings—of which some are very dubious,<sup>3</sup> and of which the most valuable are only variations of those in the Gospels—and one or two highly uncertain incidents,<sup>4</sup> are all that we can glean from them. The Apocryphal Gospels help us still less. They are for the most part heavy fictions, the inventions of an indiscriminate curiosity, often grossly heretical, abounding in coarsely-conceived and even pernicious miracles, and dwelling chiefly on imaginary details of the nativity, the infancy, or the last scenes.<sup>5</sup> Their chief value is to set forth by contrast the immeasurable superiority of the canonical Gospels, by showing us what these also might have been if they had been the products of human invention. But it is not the Gospels alone on which we have to depend. We have four works of which the authenticity has never even been assailed by any serious writer, namely, St Paul's four epistles to the Galatians, Romans, and Corinthians. These may truly be regarded as a fifth Gospel, of which the testimony is all the more valuable because it is undesigned and incidental. It is also earlier than that of any Gospel, and is the testimony of one whose personality stands forth with absolute clearness in the light of history. Further than this, it is the

testimony of a man of commanding intellect, and of the highest Jewish culture, who, after the death of Christ, was converted from the most bitter hostility to the most intense devotion, and who bears his witness within twenty-five years of the events respecting which he speaks. And yet, if we had the epistles of St Paul alone, we could find a contemporary testimony to almost every single fact of primary importance in the life of Christ.—His birth of the seed of David, His poverty, His Messiahship, His moral teaching, His proclamation of the kingdom of God, His calling of the apostles, His supernatural power, His divine claims, His betrayal, His founding of the Last Supper, His passion, crucifixion, burial, resurrection, and repeated appearances.<sup>6</sup> If we add the testimony of the other epistles, we have further testimonies to almost every fact of importance in the Gospels, as we have also in the catholic epistles and in the Revelation of St John.

It is, however, from the Gospels that our fullest light is derived. They are not, and do not profess to be, full biographies written for the gratification of curiosity, but they preserve for us all that is necessary to explain the origin of Christianity in the life of its Founder. In the first three Gospels, called Synoptic, we have sketches of the life and teaching of Christ of which the latest was probably written within forty years of the crucifixion. No one has ever denied that the representation of Christ in these three Gospels is essentially the same. The view of Him presented in the Fourth Gospel, which was not published till towards the close of the 1st century, is more subjective. It is the spiritual Gospel, the Gospel for the church, and even those critics who deny its Johannine authorship admit its value as a very ancient document written by a Jewish Christian of extraordinary genius who had access to the most valuable sources of contemporary information.

III. Since, then, it may be regarded as a truth for which the close investigations of historical criticism have only secured more universal admission that the life of Jesus was a life of which the main outlines are historically certain, we must now glance at its chronology and duration.

It must be admitted that we cannot demonstrate the exact year of the nativity, but critics of all schools are verging more and more towards the acceptance of 4 B.C. as the probable year of Christ's birth. Our present era was fixed (525 A.D.) by a learned Scythian, Dionysius Exiguus, who was an abbot at Rome, and died about 550; but it is now admitted to be erroneous by at least four years. Many methods have been adopted to arrive at the true date; but all attempts to fix it by the enrolment of Quirinius, the order of the Jewish courses of priests, the consulships mentioned by Tertullian, and the extremely remarkable astronomical conjunction of Mars, Jupiter, and Saturn in Pisces in the spring of A.U.C. 748,<sup>7</sup> have led to nothing but highly dubious results. We are left with two data which furnish us with an approximation to the accurate date. One of these is the death of Herod the Great. Josephus tells us that he died thirty-seven years after he had been declared king by the Romans.<sup>8</sup> Now this took place A.U.C. 714, and therefore—by the Jewish mode of reckoning the year from Nisan to Nisan, and counting fractional parts of a year as a whole year—he must have died between 4 B.C. and 3 B.C. Further, we know that there was an eclipse of the moon on March 12, 4 B.C., on which night Herod ordered some Jewish rabbis to be burnt

<sup>1</sup> See Grätz, iii. 243; Jost, *Gesch. des Judenth.*, i. 405, 414; Wagenseil, *Tela Ignea Satanae* (where it is published with a translation); Schöttgen, *Hor. Heb.*, ii. 697.

<sup>2</sup> Sanhedr., 43, 1. See Derenbourg, *L'Hist. de la Palestine*, p. 349; Farrar, *Life of Christ*, Exc. ii. (vol. ii. p. 475).

<sup>3</sup> These are collected in Fabricius, *Cod. Apoc.*, i. 322 sq.; Hoffmann, *Leben Jesu nach d. Apokryphen*, 317-329; Westcott, *Introduction to the Gospels*. Append. C; and Farrar, *Life of Christ*, ii. 499.

<sup>4</sup> *E.g.*, that the nativity took place in a cave; that a fire was kindled in Jordan at the time of Christ's baptism; that the vilest sinners were chosen as apostles; that there was a statue at Paneas of the woman with the issue of blood, &c.

<sup>5</sup> They are collected by Fabricius, *Cod. Apoc. N. T.*, 1743; Thilo, *Cod. Apoc. N. T.*, 1832; and Tischendorf, *Ev. Apocryph.*, 1853. They have been excellently translated by Mr B. Harris Cowper (*The Apocryphal Gospels*), and Hoffmann has written the life of Jesus as represented in these late and worthless forgeries (*Das Leben Jesu nach d. Apokryphen*, 1851).

<sup>6</sup> See Rom. i. 3, 4, v. 12, viii. 2, 3, 32, ix. 5, xv. 8; Gal. ii. 7, iii. 13, iv. 4, v. 21; 1 Cor. vi. 9, vii. 10, xi. 25, xv. *passim*; 2 Cor. iii. 17, iv. 4, xii. 12, xiii. 4, &c. See Stanley's *Corinthians*, pp. 580-589.

<sup>7</sup> As calculated by Kepler. According to more recent investigations it occurred in A.U.C. 747.

<sup>8</sup> *Ant.*, xvii. 8, 1.



for urging their pupils to destroy his golden eagle,<sup>1</sup> and that he was dead before the passover which took place on April 12, 4 B.C.<sup>2</sup> Christ must therefore have been born before February, 4 B.C. Again, St Luke tells us that John the Baptist began to preach in the fifteenth year of Tiberius, and as the reign of Tiberius was usually reckoned in the provinces from the date of his association with Augustus in the empire, this gives us A.U.C. 780 for the baptism of John, at which period Jesus was about thirty years old.<sup>3</sup> As to the day and month of the nativity it is certain that they can never be recovered; they were absolutely unknown to the early fathers, and there is scarcely one month in the year which has not been fixed upon as probable by modern critics.<sup>4</sup> The date now observed—December 25—cannot be traced further back than the middle of the 4th century, but was adopted by St Jerome, St Augustine, Orsius, and Sulpicius Severus, and in the East by St Chrysostom and St Gregory of Nyssa.<sup>5</sup> If 4 B.C. be accepted as the date for the nativity, which has most probability in its favour, the question of the date of the crucifixion depends mainly on that of the duration of the ministry. Now on this point the data of the evangelists have been disturbed by a prevalent early tradition that Christ's public ministry only lasted one year, and by another tradition that Jesus did not die till the age of fifty. The first of these notions is a mistaken inference drawn by Clement of Alexandria,<sup>6</sup> Origen, and other fathers, as also by the Valentinians, from Luke iv. 15; and it was by no means universal even in early days, for Irenæus<sup>7</sup> says that Christ taught for three years. The other notion was a mistaken inference from John viii. 57. That both views are mistakes appears from the positive testimony of St Luke that Jesus was about thirty years old when he began His ministry, and from the clear indications given by St John (ii. 13, vi. 4, xi. 55) that there were at least three passovers during the public ministry. On other grounds it is probable that there was one passover during the ministry which our Lord did not attend; and if so, we see the grounds for the ancient tradition that His public preaching lasted upwards of three years, and that Jesus died at the age of thirty-three.<sup>8</sup> He died during the reign of Tiberius, the procuratorship of Pontius Pilate, the tetrarchy of Antipas, and the high priesthood of Joseph Caiaphas. Now Tiberius died on March 16, 37 A.D., and Pilate ceased to be procurator before, and Caiaphas to be high priest immediately after, the passover of 36 A.D.; the date therefore cannot be later than 35 A.D. We may set aside dubious considerations derived from the allusion to an eclipse and earthquake by the pagan historian Phlegon, and may regard it as highly probable that the crucifixion took place at the passover of March 30 A.D.<sup>9</sup>

IV. The circumstances of the nativity are only related by St Matthew and St Luke, and by each of them in a manner so absolutely independent that facts known to the one may

have been unknown to the other. There is no difficulty in reconciling their fragmentary intimations if we suppose that Nazareth was the native place of Joseph and Mary,<sup>1</sup> and that there the coming nativity was announced to the Virgin, but that the exigences of the enrolment undertaken by Quirinius for imperial purposes required Joseph to register his name at Bethlehem, the native town of David, from whom both he and, probably, his espoused wife were descended.<sup>10</sup>

Assuming that there was an enrolment of Quirinius in 4 B.C., the difficulties which have been raised about the registration taking place at the home of the family and not at the place of residence are *a priori* objections which have but little weight against testimony. The Jews clung to their genealogies and tribal relations, and in consequence of the settled habits of Oriental life most families would be naturally resident at their native place. The inconvenience to those who were not resident would be but slight in comparison with the danger of exciting tumults by needlessly forcing the Roman methods of registration on a reluctant people. The smallness of Palestine, and the regular custom of attending a yearly passover, would tend to minimize any inconvenience; and, if the attendance of Mary was not obligatory (which is uncertain), nothing is more natural than that at such a time of trial and danger she should have accompanied the only person who could protect her. Those who charge St Luke with a gross chronological error in antedating by ten years the registration of Quirinius should remember that in every other instance in which his statements have been challenged on grounds open to historic decision his accuracy has been triumphantly vindicated.<sup>11</sup> And since the celebrated treatise of A. W. Zumpt (*Das Geburtsjahr Christi*, 1869) it has been all but demonstrated that Quirinius—although the fact is not distinctly mentioned by any ancient author—was twice legate of Syria, viz., A.U.C. 750–753 and again A.U.C. 760–765. Neither the sneers nor the attacks of critics have in the slightest degree shaken this probability; and, since Justin Martyr appeals to the census table of Quirinius, and Tertullian to those of Sentina Saturninus,<sup>12</sup> there is no critical unlikelihood in the conjecture that the census may have been ordered by Sentina Saturninus, begun by Publ. Sulpic. Quirinius during his first term of office as legate of Syria, and completed during his second.

V. It is not of course our object to narrate or even to touch upon all the events and teachings which occupy the four Gospels, but only to glance at their general bearing. The life of Jesus naturally falls into five epochs:—(1) the infancy and childhood; (2) the youth and early manhood; (3) the public ministry, including (4) the closing scenes and crucifixion, and (5) the resurrection and ascension. These epochs are well marked in the Gospels.

I. The two who alone preserve for us any details of the infancy and childhood are St Matthew and St Luke, and they relate four events. Of these the circumcision and the presentation in the temple present no difficulties. The circumcision, at which the name was always publicly given, took place on the eighth day after the birth, and was performed in the presence of the nearest friends. It illustrated the truths that Christ was "born under the law" which he came "not to destroy but to fulfil." Thirty-three days after the circumcision was the purification in the temple, and St Luke tells us how the aged Simeon and Anna welcomed the infant Saviour with words of prophecy. The third event, the visit of the Magi, is known as the Epiphany or manifestation of Christ to the Gentiles.

It rests on the sole authority of St Matthew, but there is no feature in his account which is out of keeping with known events and possibilities. The Magi, Persian or Chaldean astrologers, were a class extremely common at that epoch, and under different names are repeatedly mentioned by the contemporary historians and satirists.<sup>13</sup> That they were accustomed to wander to various countries, and to interest themselves in horoscopes, we know from the story of Diogenes Laertius that a Syrian magus had foretold his

<sup>10</sup> The descent of Mary from David is implied in the New Testament (Acts ii. 36, xiii. 23; Rom. i. 3; Luke i. 32), and traditionally asserted by Justin Martyr and Irenæus.

<sup>11</sup> Such are the tetrarchs of Abilene, the ethnarchs under Aretas, the "asiarchs" of Ephesus, the "pretors" of Philippi, the "politarchs" of Thessalonica, the "protos" of Malta, the "proprator" of Cyprus, the "preconsul" of Achaia, the Italian band, and many more.

<sup>12</sup> *Adv. Marc.*, v. 19. — <sup>13</sup> Magi, Chaldei, mathematici, &c.

<sup>1</sup> *Ant.*, xvii. 6, 4.

<sup>2</sup> *Ibid.*, xvii. 8, 4.

<sup>3</sup> Luke iii. 23.

<sup>4</sup> *Εἰσὶ δὲ οἱ περιεργότερον τῆ γενέσει τοῦ Σωτῆρος ἡμῶν οὐ μόνον τὸ ἔτος ἀλλὰ καὶ τὴν ἡμέραν προστιθέντες*, Clem. Alex., *Strom.*, i. 21, § 145.

<sup>5</sup> See Keim, *Jesu von Nazara*, i. 410; Gieseler, *Kirchengesch.*, i. § 20; and on the whole subject Wieseler, *Chron. Synops.*, 1843; Ideler, *Chronolog.*, ii.; Zumpt, *Geburtsjahr Christi*, 1869; Caspari, *Chronol.-Geogr. Einleit.*, 1869; Sanclemente, *De vulg. æræ enendatione*, 1793. Mûnter, Wurm, Anger, Piper, and many others have devoted special works to this subject.

<sup>6</sup> Clem. Alex., *Strom.*, i. xxi., § 145; Origen, *De Princip.*, iv. 5 (but compare *C. Cels.*, ii. 397; and on Matt. xxiv. 15); Tert., *C. Jud.*, 8; Lact., *Inst. Div.*, iv. 10; Aug., *De Civ. Dei*, xviii. 54.

<sup>7</sup> Iren., *Hær.*, ii. 38, 39; and so too Melito, St Hippolytus, St Jerome, &c.

<sup>8</sup> Hippolytus on Dan. iv.; Euseb., *H. E.*, i. 10; Theodoret and Jerome on Dan. ix. 27.

<sup>9</sup> Sevin *Chronol. d. Leb. Jesu*, 23; Keim, *Jesu von Nazara*, iii. 435.

death to Socrates,<sup>1</sup> and from Seneca's statement that magi, "who then chanced to be at Athens," had visited the tomb of Plato and offered incense to him as to a divine being.<sup>2</sup> That they should have been deeply interested in any sidereal phenomenon is in accordance with what we know of their studies, and that a sidereal phenomenon of the rarest kind,<sup>3</sup> and one which by the recognized rules of astrology was of stupendous significance, actually did occur at this very epoch we know by the independent and, so to speak, accidental investigations of the great Kepler:<sup>4</sup> The conjunction of planets which occurred on December 17, 1613, was followed the next year by the appearance of a new evanescent star of the first magnitude in the foot of Ophiuchus, which first attracted the notice of Kepler's pupil Brurowski, and continued to shine for a whole year. Such a phenomena may have some bearing on the "star of the wise men," although taken alone it will not minutely correspond with the language of St Matthew.<sup>5</sup> But that such an astrological event would naturally turn the thoughts of these Chaldeans to some great birth, and that its occurrence in the sign of the zodiac which astrology connected with the fortunes of Judæa should turn their inquiries thitherward, is again in accordance with the tension of Messianic expectations in those days, which especially affected the East, but which has left deep traces even on the pages of the Roman writers.<sup>6</sup> Again, the answer of the Jewish rabbis to these inquirers is in exact accordance with their own anticipations.

The sequel of the story—Herod's jealousy and the massacre of the innocents—has been mainly doubted because it is not mentioned in Josephus. But there must have been hundreds of events of that day of which the Jewish historian has taken no notice, though they were far more sanguinary than the murder of a handful of infants in a little village. The act corresponds to the jealousy and cruelty which were the master passions of the Idumæan usurper, and, if Josephus here follows Nicolaus of Damascus, we may be quite sure that he would not have mentioned a fact so damaging to the character of his patron. There are, however, two allusions in Josephus, which, if they do not specifically indicate this event, yet may well allude to it, or at least show how consonant it was with Herod's impulses.<sup>7</sup> Further, Macrobius speaks of "the boys under two years of age (comp. Matt. ii. 16) whom Herod ordered to be slain in Syria," and, although he confuses this with the sentence upon Herod's sons, of whom Antipater was executed within five days of Herod's death, his words may well point to the murder of the children of Bethlehem.<sup>8</sup> Thus, while this event is not recognizable in other histories, it meets with unexpected confirmations of its possibility from many quarters. That Joseph should have fled with Mary and the child into Egypt was exactly what would have been done by every Jew similarly circumstanced. Three days journey, as far as the Wady Rhinocolura, would have placed the fugitives beyond the reach of Herod's jurisdiction.

The sojourn of the holy family in Egypt was probably very short, nor indeed would there have been any temptation to stay a day longer than was necessary. Joseph's first intention was to return to Bethlehem when the news that Herod the Great was dead seemed to open the prospect of happier times. But when he was met on the way by the intelligence that Judæa had fallen by his father's

<sup>1</sup> Diog. Laert., ii. 45.

<sup>2</sup> Sen., *Ep.* 58.

<sup>3</sup> The conjunction of the three planets in the same constellation of the same trigon only occurs once in 794 years.

<sup>4</sup> He found that the three planets Jupiter, Mars, and Saturn had been conjoined in Pisces in A. U. C. 748, *De nova stella in pede Serpentarii*, 1606; Ideler, *Chronol.*, ii. 406; Münter, *Stern der Weisen*, 1827; Pfaff, *Das Licht und die Weltgegenden*, 1821.

<sup>5</sup> According to the Chinese astronomical tables, if Wieseler's account of them (*Chronol.*, p. 61) can be relied on, a new star actually did appear in the heavens at this very epoch.

<sup>6</sup> Virgil, *Ecl.*, ix. 47; Sueton., *Vespas.*, 4; Tac., *Hist.*, v. 13; Jos., *Ant.*, vi. 5, 4.

<sup>7</sup> Jos., *Ant.*, xvi. 11, 7, where he speaks of Pharisees and others massacred for a prediction that Herod's posterity should not enjoy his crown; and xvii. 2, 4, where he speaks of a clamour of "the mothers (comp. Matt. ii. 18) of those who had been slain by him."

<sup>8</sup> Macroh., *Saturnal.*, ii. 4.

will to the share of the cruel Archelaus<sup>9</sup> he was afraid to establish himself so near to the palæe of that jealous tyrant, and "retired" (*ἀνεχώρησεν*) to the mountain seclusion of remote and despised Nazareth. How deep was the impression which these events had made on the memory of the people, and how little likely it was that a contemporary evangelist could fall into a mistake about them, is shown by the fact which has only recently been noticed, that fully thirty years afterwards Jesus made the events which happened at the succession of Archelaus even in minute particulars the groundwork of a striking parable.<sup>10</sup>

2. At Nazareth He who, even as a mere matter of history, was to influence for ever the entire development of human civilization grew up in extreme seclusion. A single anecdote and two or three incidental expressions comprise every glimpse of Him which we can obtain. We learn that "He was subject to His parents"<sup>11</sup> at Nazareth; that "He grew and waxed strong in spirit, filled with wisdom, and the grace of God was upon Him";<sup>12</sup> that "He gradually advanced (*πρόεκοπτε*) in wisdom and stature, and in favour with God and man."<sup>13</sup> We further learn that He was not subjected to the training of any of the rabbinic schools. He had never learned that complicated system of oral tradition which was known by the Jews as "letters."<sup>14</sup> It is doubtful whether the schools which afterwards became common existed at this early period in country villages. Schools for infants are said to have been first founded by the son of Gamaliel, but possibly by this time the custom had begun of employing the scribes and lower officers of the synagogue (*chazanim*) to teach the boys of each village. We can trace proofs that Jesus was wonderfully familiar with the sights and sounds of nature, as well as with the habits of men of all classes, for He drew His illustrations in abundance from both sources. It is also certain that He knew both Greek and Aramaic, which were at that time universally spoken throughout Palestine; and there are slight indications that He was acquainted with Latin and with Hebrew, though the latter had now become a dead and learned language. We also find that He was acquainted with the then by no means common art of writing. It is certain that in His home He must, like other Jewish children, have learned first the Shema (Deut. vi. 4), then the Hallel (Psalms cxiv. to cxviii.), and then the Scriptures generally, to all parts of which, and especially to the Psalms and prophetic books, He constantly referred. The certainty that He never passed through the ordinary training of the learned classes nullifies the suggestion that any part of His wisdom was borrowed from such writers as Philo and such rabbis as Hillel and Shammai. His methods and His whole moral conception differ fundamentally from those of the Alexandrian philosopher and the Jerusalem Pharisees. His teachers, humanly speaking, were the books of God,—the books of Scripture, of nature, and of life,—and the voice of God within His soul.

At the age of twelve a Jewish boy was held to have finished the elementary stages of his education, and became a "son of the law." At this age He was presected by His father in the synagogue, began to wear the phylacteries, learnt a trade for His own support, and "advanced," as the Jews phrased it, from the study of the Scriptures to

<sup>9</sup> St Matthew uses the word βασιλεύει, and Archelaus, having been saluted "king" by the army, actually did wear that title for a short time after his father's death (Jos., *B. J.*, ii. 1, § 1; *Ant.*, xvii. 9, § 2) until Augustus ordered him to be called only "ethnarch."

<sup>10</sup> The "parable of the pounds," Luke xix. 11-27. St Luke does not himself allude to the fact that this parable is a veiled sketch of what had happened to the ethnarch thirty years before, and that the circumstance may well have been recalled to the memory alike of the Speaker and the hearers by the vicinity of the splendid palace which Archelaus had built at Jericho (see Jos., *Ant.*, xvii. 13, § 1, 2).

<sup>11</sup> Luke ii. 51.

<sup>12</sup> Luke ii. 40.

<sup>13</sup> Luke ii. 52.

<sup>14</sup> Mark vi. 2; John vi. 42, vii. 15.



that of the oral law. At this age Joseph and Mary took Jesus for the first time to Jerusalem, and there occurred the memorable incident of the temporary loss of Him by His mother and Joseph, and their discovery of Him in the Temple seated among the doctors, "both hearing, and asking them questions." His answer to the astonished inquiry "Why dost thou treat us thus?" was, "Why is it that ye looked for me?" ; "Did ye not know that I must be in my Father's house?"<sup>1</sup> These are His first recorded words, and their beauty and simplicity give them such a stamp of truthfulness as no art could imitate. They are the first gleam of that character and personality which has transcended anything of which the world has had any experience during all the former or subsequent ages. The evangelists record no further particulars of these early years.

Of the remaining life of Jesus during the period between this visit to Jerusalem and His baptism one word alone remains to us. It is in the question, "Is not this the carpenter?"<sup>2</sup> in Mark. vi. 3. It shows us that these eighteen years of youth and opening manhood were spent, not only in the obscurity of a despised provincial village, but also in the manual toils of a humble trade.<sup>3</sup> It shows us that Jesus worked with His hands for His own support, and that of His mother and brethren. The fact is so entirely unlike anything which we should *a priori* have expected in the life of Him whom Christians adore as the Son of God and the Saviour of the world, that we once more see the faithfulness of the narrators, who do not attempt to break by unauthorized inventions the deep silence of those long unknown years in which He consecrated the common lot of toil and poverty, and thereby showed the inherent dignity of manhood and the intrinsic sacredness of human life.

3. Before entering on the third epoch of the life of Jesus,—the baptism and public ministry,—we must pause for a moment to touch on the political and religious aspect of the world during the brief period of His Messianic activity.

Politically the world was passing through a bad epoch. Rome under the emperors, as she attained the zenith of her apparent power and splendour, sank almost to the nadir of her real degradation. The genius of Julius Cæsar, the astute policy of Augustus, could not delay the ever-deepening degeneracy which revealed itself in its worst colours in the reign of Tiberius. The condition of the Roman world during the later years of Tiberius, when he was hiding at Capree, the infamies of his sanguinary lust, was that condition of terror and despair which Tacitus has portrayed with such unequalled power. The words in which he describes the characteristics of a somewhat later period apply also to this ; it was "rich in disasters, terrible in battles, rent by seditions, savage even in its peace."<sup>4</sup> The murder of princes, the outbreaks of rebellion and civil war, the prevalence of alarming rumours, the decimation of the noblest families by means of spies and informers, the conflagrations of temples and cities, the oppression of provinces by the greed and cruelty of legates and procurators, the horrible degradation of private morals, the awful tragedies of impurity and bloodshed which were enacted in various courts, the multiplications of banishments, even the terror of famines, storms, and earthquakes, combined to render

the early years of the Christian era a period of gloom and anguish throughout large portions of the Roman empire. Judæa was the scene of special miseries, because it groaned under the ruthless and hypocritical tyranny of Idumæan usurpers.

Meanwhile the religious condition of the world and of the nation was no less unsatisfactory. Throughout the Roman empire the belief in the popular mythology had died away, and, while a few of the noblest spirits took refuge in the hard and despairing dogmas of Stoicism, the mass of the people was plunged in practical atheism or abject superstition. Such religion as there was among the people usually took the form of Egyptian and Phrygian worship, which were often connected with the vilest immorality. In Judæa the dominant religion consisted in scrupulous devotion to the petty external ordinances of the oral law.

Thus at the epoch of Christ's birth the heathen world had sunk into practical atheism, and the Jewish world was deeply corroded by formalism and hypocrisy. In the heathen world religion had almost ceased to exist ; in the Jewish world it was tainted at its source.

It was no doubt due to the darkness of the religious and political horizon, and to the sense of despair and weariness which was prevalent in the hearts alike of Jews and Gentiles, that the Messianic hope, fostered by generations of prophets, gained a powerful hold on the hearts of all sincere Israelites, and even found its expression in secular literature. Virgil, Tacitus, and Suetonius, no less than Josephus, show that the thoughts of the civilized world were turned to the East in expectation of some great deliverer. But the character of their hope was utterly mistaken. Overlooking the prophetic passages which told of a suffering Messiah, a servant of Jehovah, who should bear the sorrows of His people, the Jews were anticipating the advent of some temporal sovereign who would rule their enemies with a rod of iron, and dash them in pieces like a potter's vessel, while He raised Israel to the summit of earthly prosperity and luxury.<sup>5</sup> The Messiah, the son of David, was to be a conquering warrior, which accounts for the grossly unspiritual conceptions which induced one party to represent Herod as the promised Messiah, and which enabled Josephus to pretend that he found a fulfilment of the Messianic prophecies in the elevation to the empire of Vespasian, the bourgeois soldier who had crushed his country under the iron heel of the Roman legionaries.

At this time of extreme trouble and expectation the Baptist began his preaching. It was confessedly preparatory. The coming of the Messiah was always declared to depend on the "righteousness" of the nation, that is—in ordinary Jewish phraseology—their rigid observance of the Mosaic law. But John saw that what was needful was morality, not legalism, and his cry "Repent ye, for the kingdom of heaven is at hand," was explained to each of the great classes which applied to him for advice by practical directions as to their daily duties. John created an intense though transitory impression by his dress and appearance, which recalled the memory of ancient prophets, and specially of Elijah, and still more by the burning sincerity and reality of a style of teaching which presented so strong a contrast to the ordinary teaching of the scribes. He adopted the rigid seclusion and asceticism of the Essenes, and his language rang with denunciations clothed in the imagery of the desert. Refusing all the titles which the people wished to force upon him, he described himself as "a voice of one crying in the wilderness," and announced the coming of one greater than himself, who would found

<sup>1</sup> Luke ii. 49. This and not "about my Father's business" is the correct rendering of *ἐν τοῖς τοῦ πατρὸς μου*, as has been conclusively proved in an unpublished paper of Dr Field. See the present writer's St Luke (in Camb. Bibl. for schools) *ad loc.*

<sup>2</sup> This is the true reading, though a false feeling of reverence and a wrong dogmatic bias have led the copyists of the later MSS. to alter it into "the son of the carpenter."

<sup>3</sup> Justin, *C. Tryph.*, 88, says that He specially made "ploughs and

<sup>4</sup> Tac., *Hist.*, l. 2.

<sup>5</sup> See Bartolucci, *Bibl. Rabbin.*, i. 511-514 : Lightfoot, *Hor. Heb.* p. 552 ; Buxtorf, *Synag. Jud.*, p. 52

the kingdom which he only announced. The submission to the simple rite of baptism, a rite already familiar to the Jews in the admission of proselytes, was the only sign of the acceptance of his mission which he required; and the multitudes were so deeply moved by his preaching that they thronged to be baptized of him in Jordan, confessing their sins. It was in order to receive this baptism, and to ratify the mission of the great forerunner, that Jesus left the deep provincial seclusion in which He had hitherto lived. The staidness of personality of his Kinsman overawed the bold and mighty spirit of the desert preacher. He shrank from baptizing one in whom he at once recognized that "royalty of inward happiness," and purity of sinless life, which he could not himself claim. Jesus, however, though He had no sins to confess, bade John to baptize Him, "for thus it becometh us," He said, "to fulfil all righteousness." He received the baptism, as a representative of the people whom He came to save, as a beautiful symbol of moral purification, and as the fit inauguration of a ministry which came not to destroy the law but to fulfil. And during the baptism John saw the overshadowing radiance and heard the voice from heaven which revealed to him that the promised Messiah had now come, and that this Messiah was the Son of God.

After this great crisis, which finally closed the private period of the life of Jesus, He was "driven" by the spirit into the wilderness for His mysterious temptation. The details of what occurred could of course only have been derived from what He Himself made known to His apostles. What is clear is that in that region of Quarantania, in the desert of Jericho, He was divinely strengthened for this mission by victoriously wrestling with every suggestion of the powers of evil which could have altered the character of His work. Although this was not His only temptation<sup>1</sup>, it was evidently the most deadly. The first temptation appealed subtly and powerfully to the exhaustion of His physical nature; the second to spiritual pride, as it would have been manifested by an unwarranted challenge of the providence of God; the third to unhalloved personal ambition. In the two greatest temptations of His life—in the wilderness and at Gethsemane—He was tempted both positively and negatively,—positively by allurements to a lower line of action, and negatively by the seductive pleas which would have drawn Him aside from the path of suffering. But He won the perfect victory because temptation never passed into even the thought of sin, but was so wrestled with and overcome that it made no determining impression upon His heart.<sup>2</sup>

After this victory over the power of evil, Jesus returned to the fords of Jordan. It will not of course be possible or needful to dwell on the narratives of His ministry in all their details; but, since these narratives are confessedly fragmentary, we shall endeavour to furnish from the four Gospels in rapid outline a sketch of the general events of His ministry before touching upon its eternal significance. The events described in the Gospels are often grouped together by subjective considerations, and it was the evident object of St John to dwell preponderantly on the Judean ministry, and on those discourses which brought out the deeper and more mysterious side of the being of Christ, while the Synoptists chiefly describe the work in Galilee, and preserve what may be called the more exoteric discourses. The combination of these disintegrated records into one harmonious and consecutive whole is a task which can never be accomplished with absolute certainty; but it is possible, without a single arbitrary conjecture, to construct a continuous narrative which shall simply follow the indication of our authorities without doing violence to them

in any instance. In this scheme the ministry of Christ falls into the following epochs:—(1) the early scenes, narrated by St John alone, until the beginning of the public preaching in Galilee; (2) the Galilean ministry till the murder of the Baptist; (3) the period of decided opposition; (4) the period of flight and peril until the final farewell to Galilee; (5) from the great journey to Jerusalem till the retirement to Ephraim; (6) from this retirement to the Passover; (7) the last supper, passion, trial, and crucifixion; (8) the resurrection and ascension.

(1) The scenes of the first period are related by St John with a beauty and simplicity which can only be called idyllic. He tells us how the Baptist, on the banks of the Jordan, saw Jesus pass by, and exclaimed, in language of deep significance, "Behold the Lamb of God, that taketh away the sin of the world!" Whether the prominent thought in the Baptist's mind was the paschal lamb, or the lamb of morning and evening sacrifice, or the lamb which Issiah and Jeremiah had used as an emblem of patient and suffering innocence, it is clear that in the spirit of prophecy he saw in Jesus one who was predestined to a life of sorrows which should be for the salvation of the world. The next day the Baptist repeated the same emphatic testimony in the presence of two Galilean youths, St Andrew and St John, who were so deeply impressed by it that they followed Jesus, saw Him in the place where He was then dwelling, and became His first disciples. Andrew then brought to Jesus his brother Simon, who also recognized in Him the promised Messiah. Three days afterwards Jesus called Philip, another young fisherman of Galilee, who in his turn brought to Jesus his friend Nathanael, the guileless Israelite who is known in the Gospels as Bartholomew, or the son of Tholmai. Accompanied by these pure and warmhearted young men, and also by His mother, Jesus was a guest at the simple wedding feast of Cana in Galilee, at which He first displayed His possession of supernatural power by turning the water into wine. Then, after a brief stay at Capernaum, He went to the Passover at Jerusalem. His first visit to the temple as a recognized teacher was signalized by an authoritative Messianic act. He cleansed the temple of its mean and desecrating traffic, although neither priests nor Pharisees nor the Roman authorities had ever taken a step in that direction. When His right to act thus was challenged, He answered in mysterious words, of which the meaning was not thoroughly understood till long afterwards, "Destroy this temple, and in three days I will raise it up"—speaking of the spiritual temple of His body.<sup>3</sup> The words created so deep an impression that after being distorted both in form and meaning they formed one of the chief charges against Him at His trial. Even at this early phase of His work Jesus touched the heart and won the secret allegiance of Nicodemus, with whom He held at night the memorable discourse on the new birth. But He was met from the first by such signs of opposition that He went with His disciples into Judæa, and there allowed them to baptize. The work of the Baptist was not yet over, and, until it was, Jesus both permitted the disciples to adopt the symbol of purification which had been used by His forerunner, and Himself similarly preached "Repent, for the kingdom of heaven is at hand." Some Jew<sup>4</sup> raised a discussion with the disciples of John about purification, and they in their perplexity and jealousy applied to their great master with the complaint that his ministry was being eclipsed by that of Him whom he had baptized beyond Jordan. John, with noble self-suppression, pointed out that he must

<sup>1</sup> Luke iv. 13; John vi. 4; Heb. ii. 10, 18, iv. 15.

<sup>2</sup> See Ullmann, *Sinlessness of Jesus* (Eng. tr.), pp. 30, 140.

<sup>3</sup> John ii. 19. That "the Jews," as St John calls the opponents of Christ, were not so entirely ignorant of His meaning as they chose to appear res<sup>t</sup> from Matt. xxvii. 63.

<sup>4</sup> *Μαθητὸν Ἰουδαίου* is the true reading in John iii. 25.



thenceforth decrease; and shortly after this time he was thrown into prison by Herod Antipas. In consequence of this event Jesus withdrew into Galilee. He chose the route through Samaria, and it was to a poor frail woman by Jacob's well that He seems first to have distinctly revealed His Messiahship. His acceptance of the invitation of the Samaritans to stay a few days with them was a rebuke to the spirit of fanatical hatred and exclusiveness, which in that day so filled the minds of His countrymen that they regarded any intercourse with Samaritans as involving pollution.

(2) Although Jesus was aware that a prophet is often least known in his own country and among his own kindred, He made His way, preaching as He went in various synagogues, direct to Nazareth.<sup>1</sup> There, in the synagogue, He read aloud part of Isaiah lxi., and amid deep silence applied it to Himself. But He had not proceeded far when the spell of His divine teaching was broken by the pride and ignorance of the Nazarenes, who began to murmur among themselves about His humble birth and occupation, and to demand that He should do some deed of power among them. It was on His reminding them that Elijah and Elisha had wrought their miracles of healing upon strangers that they rose in fury, and dragged Him to the brow of the hill on which their city was built. Something, however, in the majesty of His bearing seems to have created in their minds a supernatural awe, so that, as on later occasions, He was able "to pass through the midst of them, and go on His way." To the place of His birth He seems never to have returned.

From this time His home, so far as He could in any sense be said to have a home, was at the bright little city of Capernaum on the shores of the Sea of Galilee, to which, perhaps in consequence of the churlishness of the Nazarenes, His mother and brethren also migrated. At this point begins the period of His brightest activity, the year which was in a pre-eminent sense "the acceptable year of the Lord." The scene of that ministry was mainly the beautiful and populous plain of Gennesaret through which passed "the way of the sea," the great caravan road which led to Damascus. It was the manufacturing district of Palestine, thronged by men of all nationalities, and therefore pre-eminently suited for the proclamation of the kingdom. At the same time it was a scene of infinite charm, and the opportunities of sailing from place to place, and of earning a livelihood, which were afforded by the inland lake, rendered it specially appropriate. On the way to Capernaum Jesus healed by His word the son of the courtier of Herod,<sup>2</sup> who in consequence believed with his whole house. Much of the brief story of the Gospels is made up of the records of single days which stood out with marked prominence. One such day was the first Sabbath at Capernaum. Christ began with a sermon in the synagogue, during which He wrought one of His great exorcisms on a raving demoniac who was present in the audience. Retiring to the house of Peter, He healed Peter's mother-in-law of a fever, and at sunset, when the Sabbath ended, wrought many cures upon a multitude of sufferers. The fame of this day rang even to Syria, and, finding that even temporary seclusion was now impossible, Jesus went from village to village preaching the kingdom of God.<sup>3</sup> It was at this time that He preached to the multitude from Peter's boat, and after the miraculous draught of fishes called Andrew, Peter, and the sons of Zebedee<sup>4</sup> to a closer and

more unremitting discipleship. Matthew the publican was the next to "leave all" and follow Christ. The choice of the full number of twelve to be apostles took place just before the sermon on the mount, and nothing can more decisively show the wisdom and insight of Jesus than the fact that among the twelve were characters so opposite as a zealot and a publican. Judas, the "man of Kerioth," was probably the only Judæan in the little band of Galilæans. The great discourse known as the Sermon on the Mount was delivered primarily to the disciples, but was intended also for the multitude. The hill by the Galilean lake<sup>5</sup> was the Sinai of the new dispensation, but it was a mount not of terrors but of beatitudes. The sermon first sketched the character of the citizens of the new kingdom both absolutely and relatively.<sup>6</sup> It proceeded to sketch the new law in contrast, both general and special, with the old.<sup>7</sup> The last great section of it was occupied with the characteristics of the new life—its devotion, its duties, and its dangers.<sup>8</sup> It ended with the contrast between doers and mere hearers.<sup>9</sup> The grandeur, originality, independence, and authoritative tone of the sermon, with its vivid illustrations and divine idealism, produced a very deep and wide impression. The inauguration of the doctrine was followed by deeds of mercy and power. From this time He was constantly surrounded by thronging multitudes, and was constantly appealed to for miracles of compassion. We are told in quick succession of the healing of a leper by a touch, of the centurion's servant by a word, and the raising from the dead of the widow's son at Nain; and so incessant was His activity that His mother and His brethren began to be alarmed. Soon after the miracle at Nain He received the deputation from John the Baptist, then in his gloomy prison at Machærus, to ask whether He were indeed the Messiah. He bade the messengers take back no other answer than the works which they had witnessed or heard, and pre-eminent among them was the preaching the gospel to the poor. It was after their departure that He pronounced the unequalled eulogy on John as the greatest of the prophets, while yet "the least in the kingdom of heaven" was, in spiritual privileges, greater than He. It was in this discourse that He contrasted the glad and natural geniality of His own example—as one who came "eating and drinking"—with the asceticism and gloom of the Baptist. He never refused the invitations even of the Pharisees, and it was at the banquet of a Pharisee named Simon that He accepted the pathetic devotion of the "woman that was a sinner" (whom Christian tradition persistently identifies with Mary of Magdala), and rebuked the haughty and untender formalism of His host. His life during this period, as He wandered about Gennesaret and its vicinity, preaching to rejoicing crowds, was a life of poverty, toil, and simplicity, but it was also a life of exalted joy from the rapturous gratitude of the people and the faith which enabled Him to work many deeds of mercy among them. Of one episode of the period many details are preserved. After one of the missionary tours in Galilee, Jesus, finding Himself surrounded by a vast throng, began for the first time to preach to them in those parables which were the most characteristic form of His subsequent teaching, and which had the additional advantage of testing the moral and spiritual qualities of His hearers. He began with the parable of the sower, and this method of instruction naturally stimulated to such an extent the eagerness of His hearers that He was kept teaching till evening came. A second ill-judged attempt of His mother and brethren to control His proceedings probably combined with the sense of deep weariness

<sup>1</sup> Luke iv. 15.

<sup>2</sup> Not improbably Chuza, Herod's steward, whose wife Joanna was one of the "ministering women."

<sup>3</sup> Three such circuits in Galilee are faintly traceable; but it is not possible to mark their separate incidents.

<sup>4</sup> They were probably first cousins of Jesus, for it seems probable from Mark xv. 40, John xix. 25, that Salome the wife of Zebedee was a sister of the Virgin Mary.

<sup>5</sup> Probably Karm Hattin.

<sup>6</sup> Matt. v. 1-16.

<sup>7</sup> Matt. v. 17-48.

<sup>8</sup> Matt. vi. 1 to vii. 23.

<sup>9</sup> Matt. vii. 24-27.

ness to create a desire for brief rest and retirement, and He urged His disciples to a hasty departure to the lonelier eastern shores of the lake. During the sail of about 6 miles there rose one of the violent sudden storms to which the Sea of Galilee is specially liable. He was sleeping on the leather cushion of the steersman the deep sleep of fatigue, which not even the waves now dashing into the boat could disturb. The disciples woke Him in wild alarm, and the calm majesty with which He hushed the storm made an indelible impression on their minds. No sooner had they landed on the other side than they were met by a naked and raving maniac, whose dwelling was in the tombs which are still visible on the neighbouring hillsides. Jesus healed him, and (as we are told in a narrative which evidently touches on things entirely beyond our cognizance) suffered the demons to enter into a herd of swine hard by, which immediately rushed violently over a steep place into the sea. The semi-heathen inhabitants of the district, alarmed by His presence, and vexed at the loss of their swine, entreated Him to depart out of their coasts. He granted their evil petition, but left the healed demoniac to lead them to a better frame of mind. The people on the other side recognized the sail of His returning vessel, and were waiting in multitudes to meet Him. While preaching to them in a house at Capernaum, the friends of a paralytic, who had been unable to get near Him for the press, let down the sick man through the roof in front of Him, and He healed him, exciting some murmurs from the Scribes, who had already begun to watch Him with suspicion, by first using the formula "Thy sins are forgiven thee." From the house He adjourned to the shore, and after another brief time of teaching there went to the farewell feast which Matthew gave to the "publicans and sinners" who had been his friends. The Pharisees, afraid as yet to find fault with Him directly, asked the disciples in great displeasure why their Master ate with publicans and sinners, whose very touch they regarded as a pollution. The answer of Jesus was given in the memorable quotation, to which He more than once referred, "Go ye and learn what that meaneth, I will have mercy and not sacrifice."<sup>1</sup> He answered the inquiry of St John's disciples about fasting by pointing out to them that the glad initiation of the marriage feast of the kingdom of heaven was no time for fasting,<sup>2</sup> and that the embodiment of a new spirit in old form was like putting new wine in worn skins, or a new patch on an old garment. It seems to have been immediately after the banquet that He received the heartrending appeal of Jairus that He would come and heal his little daughter. On the way He healed the woman with the issue who secretly touched the fringe of His garment.<sup>3</sup> By the time He reached the house of Jairus the little maid was dead, and His three most chosen disciples—Peter, James, and John—were alone admitted with the father and mother to witness this second instance in which He recalled the dead to life.

It was probably at this point of the ministry that there occurred the visit to that unnamed feast at Jerusalem,<sup>4</sup> which was almost certainly the Feast of Purim. Perhaps with a view to this absence from Galilee He sent out the twelve, two and two, to preach and perform works of mercy in His name, sending them "like lambs among wolves," and bidding them set the example of the most absolute contentment and simplicity. During His visit to Jerusalem,

<sup>1</sup> Hos. vi. 6.

<sup>2</sup> His reference to the days "when the bridegroom should be taken away from them" (*ἀπαρθῆναι*) is one of those early intimations of His death of which one hint had already been given in the night discourse to Nicodemus (John iii. 16).

<sup>3</sup> An interesting indication that he observed even the minute particulars of the Mosaic law (Numb. xv. 37-40; Deut. xxii. 12).

<sup>4</sup> John v. 1.

where—as we learn from St John, whose facts are incidentally confirmed by allusions in the Synoptists—He had many friends and followers, He healed the impotent man at the Pool of Bethesda, and excited the bitter enmity of the Jews by deliberately ignoring the exaggerated minutiae of the traditional law which made them regard it as a heinous crime to carry even the smallest burden on the Sabbath. The simple command to the healed man to take up the mat on which he lay and walk aroused the Jews to fury; and from that incident, as St John expressly tells us, the overt persecution of Jesus began.<sup>5</sup> He seems to have been summoned before some committee of the Sanhedrin, but on this occasion they did not dare to punish His violation of their traditions, and on the contrary had to listen in unavailing wrath, not only to His irresistible defence of what He had done on the Sabbath, but to Divine claims which they declared to be blasphemy. They did not dare to touch Him, knowing His power with the people, but from that day the leading authorities of Jerusalem seem to have determined on His death, and their hostility was so bitter and persistent that He left Jerusalem without waiting for the approaching Passover.

(3) It was from this moment that the period of determined opposition began. Hitherto the local Pharisees and Scribes of Galilee might disapprove and murmur, but they had not dared to set themselves in distinct and public antagonism against Him. They were now encouraged to do so by the fact that the leading authorities of the capital had repudiated His claims. The high priests and Pharisees even sent some of their number to act as spies upon His words and actions, and see how they might contrive occasions for His ruin. He returned to Galilee with the full knowledge that His human day was beginning to fade into evening, and that the sentence of violent death hung over Him. It was at this solemn time that the murder of John thrilled men's hearts with horror. Jesus retired with the disciples to a desert plain near the town at the northern end of the lake known as Bethsaida Julias, which was in the dominion of the milder Philip, and beyond the jurisdiction of the blood-stained Antipas. Even to this retirement, however, the multitude followed Him, and here it was that, moved with deep compassion, He fed the five thousand with five barley loaves and two small fishes. Then urging the departure of His disciples by boat to Capernaum, He dismissed the multitude in the gathering dusk, and at last fled from thence<sup>6</sup> to the top of a neighbouring hill where He spent the night in prayer. During the night a terrible storm arose, and He came to His disciples walking upon the sea, and rescued St Peter as with a half faith he endeavoured to meet Him on the water. The next day at Capernaum He uttered that memorable discourse about Himself as the bread of life, and the necessity of "eating the flesh of the Son of Man and drinking His blood," which was expressly designed to dissipate idle chiliastic and material delusions, and to test the sincerity of a spiritual faith. The discourse created deep discontent, and from that time many forsook Him. He even foresaw that one of His chosen apostles was "a devil"; but Peter spoke the conviction of the rest in the noble words, "Lord, to whom shall we go? Thou hast the words of eternal life."

But henceforth opposition became more marked and more fearless. It had already been stirred up in the hearts of all Jewish formalists by His claiming to forgive sins, by His disapproval of asceticism, by His intercourse with publicans and sinners. It gathered force from His consistent depreciation of the petty traditional superstitions which had degraded the Sabbath from a delight and a blessing into a mere fetish of servitude. When the incident at Bethesda had attracted the notice of the Sanhedrin, the

<sup>5</sup> John v. 16.

<sup>6</sup> *ἦν* (Vulg.) *φύγει*, John vi. 22.



Pharisaic spies from Jerusalem especially watched His Sabbath proceedings. Again and again their hatred was kindled on this point. Now they indignantly challenged the conduct of the hungry disciples for plucking ears of corn and rubbing them in their hands on the Sabbath day; on another occasion they attacked Him for healing on the Sabbath day the man with the withered hand, and later on for healing the bowed woman, and the blind man at Jerusalem. On each of these occasions He exposed with irresistible demonstration their inconsistency and hypocrisy, but thereby only deepened their anger against Him. On other occasions He came into violent collision with their whole system of traditional ceremonialism by pouring contempt on their superfluous and meaningless ablutions, by showing how comparatively meaningless was their scrupulosity about clean and unclean meats, and generally by denouncing the spirit which had led them to place the cumbrous pettinesses of their oral law above the word of God and the inmost spirit of all true religion. The rage of His Pharisaic opponents culminated on one day of open and final rupture between Himself and the spies of the Sanhedrin. Finding Him standing in silent prayer, the disciples had asked Him to teach them to pray, and in reply He had taught them "the Lord's prayer," and told them, in such accents as man had never heard before, about the fatherhood of God, and the consequent efficacy of prayer. Shortly afterwards He had wrought one of His most marvellous cures upon a poor wretch who was at once blind, dumb, and mad. The Pharisees felt bound to check the astonished admiration which this act had once more excited, and with impotent and stupid malignity had tried to teach their followers that He cast out devils by Beelzebub the prince of the devils. This blasphemous folly had drawn down upon their heads words of rebuke more intense and stern than they had ever heard. Such words, addressed to men accustomed to unbounded admiration as infallible teachers, aroused them to the deadliest hostility, and they soon found a weapon of annoyance and injury by demanding on every possible occasion that "sign from heaven" which Jesus always refused to give. Their exacerbation seems to have alarmed His mother and brethren into the third of their ill-timed interferences, which Jesus had once more to check by declaring that the day had now come on which human relationships were as nothing compared to the spiritual. The time for the mid-day meal had now arrived, and Jesus accepted, though it seems to have been given in no good spirit, the invitation of a Pharisee to break bread in his house. On entering He at once sat down at table, since it was but a brief and trivial meal, perhaps of bread and fruits, and the multitude were waiting outside to hear the word of God. Instantly He recognized that He was alone in the midst of enemies, and, moved to deep indignation by their hypocrisy and baseness, He delivered a terrible denunciation of the whole system and religion of the legalists and Pharisees. The feast broke up in confusion, and the guests began to surround Jesus with vehement, taunting, and threatening demonstrations.<sup>1</sup> Passing from amongst them He found the multitude actually treading on each other in their haste and eagerness, and perhaps it was to their presence that He owed His safety. He preached to them a sermon, characterized throughout by the deep emotions by which His spirit had been agitated, of which the main topic was the awful peril of hypocrisy and greed; and then—as though some solemn agony had passed over His spirit—He warned them of the signs of the times, and of the awful consequences of rejecting His teaching.

(4) With that day of conflict ended the second and darker stage of His work in Galilee. The remainder of His life

was mainly passed in flight, in peril, and in concealment, only broken by brief occasional appearances in Galilee and Jerusalem. He departed from Capernaum, and went into the heathen region of Tyre and Sidon. But few particulars of this period are recorded. Somewhere in those regions He tested the strong faith of the Syro-Phœnician woman, and healed her demoniac daughter. From Tyre and Sidon He wandered southwards again, keeping mainly to the eastward and less inhabited region, only now and then healing a sufferer, but gradually attracting crowds once more. Somewhere on the Perea side of the lake He fed the four thousand. After this period of wandering and absence He once more sailed to Magdala, but was met immediately by the ominous conjunction of Herodians and Pharisees with their hostile demand for a sign. Turning away from them, He uttered His last sad farewell and prophecy to the cities in which He had laboured, and once more journeyed northwards. During this journey they came near to Cæsarea Philippi, and, after standing in silent prayer, He asked His disciples "Whom do men say that I the Son of man am?" The sorrowful confession had to be made that, though they recognized Him as a prophet, they had not recognized Him as the Messiah. Then came the momentous question, which was to test how much of His task was accomplished in the hearts of those apostles whose training had now for some time been His principal work, "But whom say ye that I am?" Then it was that Peter won the immortal glory of giving that which has thenceforth been the answer of all the Christian world, "Thou art the Christ, the son of the living God." That answer is the inauguration, in human convictions, of Christianity and of Christendom; and it was rewarded by the promise of the power of the keys, and the power to bind and loose, and the foundation of the Christian church upon a rock. Whatever may be the difficulties of the passage, we see that Jesus meant to confer on His church the teaching power of which the key was the symbol, the power of legislative action indicated by binding and loosing, and the prophetic insight on which depended the ability to absolve in God's name. But to obviate all delusions He at once revealed to them the dark abyss of suffering down which He had first to tread; and, as though to prove how little claim His words gave to sacerdotal usurpations, He proceeded to rebuke in the sternest words the presumption of Peter, who ventured to set aside His predictions as to His coming sufferings and death. It was six days after this that He took the three most chosen apostles with Him up the snowy slopes of Hermon, where they witnessed the transfiguration, as though to strengthen their faith in the dark hours to come. On descending the hill, He healed the demoniac boy whom the apostles had vainly tried to help, and built on this exorcism the lesson of faith which He was never weary of inculcating on His followers. Having now reached the northern limit of the Holy Land, He turned His footsteps southwards by the most secluded paths, omitting no opportunity to train the apostles, now teaching them humility by the example of a little child, and now warning them by significant parables of the need of self-sacrifice and of the spirit of forgiveness.

(5) At the ensuing Feast of Tabernacles we find Him once more at Jerusalem, where He appeared suddenly in the temple. St John records His teachings, drawn from the various incidents of the feast, and also the divided opinions of the people, and the almost unanimous opposition of the ruling classes. This visit to the Holy City was marked by the incident of the woman taken in adultery, in which He showed such sovereign wisdom and tenderness, and by the Sabbatarian disputes which arose from the healing of the blind man. On one occasion Jesus had to leave the temple amid a burst of fury in which the Jews threatened

<sup>1</sup> Luke xi. 53.

to stone Him, and when He left Jerusalem it was under the direct ban of excommunication. Under these circumstances He returned for one more brief visit to Galilee. The news which He received of the murder of some Galileans in the temple by Pilate, and of Herod's designs against His safety, show how surrounded by perils was His human life. But He now calmly ended His work in Galilee by the mission of seventy disciples to prepare for His great last journey southwards. His words of farewell to the cities which had rejected Him were full of sadness and solemnity, as He started from the land which had refused His mission to the city in which He was to be crucified.

We now enter on the last great phase of His work, the incidents of His final journey and the close of His ministry. First He was refused shelter by the rude villagers of Engannim, and had to change his route. Next came the healing of the ten lepers, of whom but one showed gratitude, and he was a Samaritan. The Sabbath healings of the bowed woman and of the man with the dropsy are the two chief miracles of the journey, during which He also delivered many most memorable discourses, and some of His divinest parables—such as those of the good Samaritan and the prodigal son. So we trace His steps to the house of Martha and Mary at Bethany, and to Jerusalem, which He visited at the Feast of the Dedication. His appearance in the temple was always the signal for the fiercest opposition of Sadducees and Pharisees, who watched with jealousy and hatred the eagerness of the multitude to hear Him. After serious conflicts He retired to the other Bethany, beyond Jordan. Among the few recorded incidents of His stay in Peræa are the attempts to entangle Him with Herod and the Jewish schools by questions about divorce, the beautiful scene of blessing the little children, and the discourse about riches on the occasion of the test which He applied to the rich young ruler who "made the great refusal." The death of Lazarus summoned Him to Bethany, and the most signal miracle which He there wrought by raising Lazarus from the dead excited such notice that the Sanhedrin now met under the presidency of Caiaphas, and came to the deliberate conclusion that they must put Him to death, lest the populace should raise tumults on His behalf which might precipitate the final intervention of Rome in the affairs of their nation. But, as His time was not yet come, Jesus avoided the peril of public arrest or private assassination by retiring to an obscure village called Ephraim, on the edge of the wilderness.

(6) He did not leave Ephraim till He could join the great caravan of Galilean pilgrims with whom He could proceed in safety to His last passover. His apostles, both from His own warnings and from the visible grandeur of His transfiguration of self-sacrifice, were well aware that a crisis of His career had now arrived; and nothing can show more clearly the mistaken character of their Messianic hopes than the fact that, though He now distinctly told them the crowning horror that He should be crucified, the sons of Zebedee came with their mother Salome to beg for places at His right hand and His left in His kingdom. Jesus made their ambitious request a theme for rich and solemn teachings on the beatitude of suffering for the cause of God and man. As they approached Jericho, accompanied by excited multitudes, He healed the blind Bartimæus, and in Jericho He excited the murmurs of the crowd by accepting the hospitality of the publican Zacchæus. On the road between Jericho and Bethany He delivered the parable of the pounds. He arrived at Bethany probably on Friday, Nisan 8, A. D. C. 783 (March 31, 30 A. D.), six days before the passover, and before the sunset had begun the Sabbath hours. The Sabbath was spent in quiet. In the evening Martha and Mary gave him a banquet in the house of Simon the leper, at which Mary, in her devotion and

gratitude, broke the slabaster of precious ointment over His head and feet, and so awoke the deadly avarice of Judas that he seems on that very evening to have communed with the Jewish priests for the paltry blood-money of thirty pieces of silver (less than £4) for which he was willing to betray Him. On the morning of Palm Sunday Jesus made His triumphant entry into Jerusalem amid the palm-waving throngs, who shouted "Hosanna to the son of David," and at the point of the road where the city first bursts upon the view He paused to weep over it and prophesy its doom. After once more cleansing the temple, and protecting from the anger of the priests and Pharisees the children who still shouted Hosanna, He spoke to Philip about the Greeks (probably from Edessa) who wished to see Him, and, strengthened by a voice from heaven, spent the rest of the day in teaching. At evening He retired for safety with the twelve outside the city walls in the direction of Bethany. On the Monday morning, as He went to Jerusalem, He pronounced the symbolic doom upon the fig tree which had only leaves. On entering the temple He was met by a formidable deputation of priests, scribes, and rabbis, who demanded "by what authority He was acting,"—a question which He declined to answer until they proved their right to ask it, by giving a definite opinion respecting the baptism of John. Their confession of inability to do this was so marked a proof of their incompetence to claim the function of religious teachers, that He refused to meet their challenge. The day may be called "a day of parables," for during His teaching He spoke the parables of the two sons, the rebellious husbandmen, the builders and the corner stone, and the marriage of the king's son. These parables were so obviously aimed at the hypocrisy, malevolence, and presumption of the Jewish authorities that fear alone restrained them from immediately seizing Him. At evening He again retired from the city. The next day, the Tuesday in Passion week, may be called the day of temptations, for it was marked by three deliberate attempts to undermine His authority by involving Him in some difficulty either with the rulers or the people. In the morning walk to Jerusalem He taught to His disciples a lesson of faith from the withered fig-tree. In the temple He was first met by the plot of the Herodians and Pharisees to embroil Him either with the Romans or the populace by a question as to the lawfulness of paying tribute, then by a piece of poor casuistry on the part of the Sadducees concerning the resurrection, then by the question of a Scribe as to the great commandment of the law. In each instance the divine and ready wisdom of His answers not only entirely defeated the stratagems of the Sanhedrists, but showed His immeasurable superiority to them in knowledge and insight. Then, to prove how easily He might have turned the tables on them, had He desired their humiliation, He exposed their complete ignorance respecting the very subject on which they claimed the fullest knowledge by reducing them to a confession of their inability to explain why David in the spirit had given the name of Lord to the Messiah who was to be his son. And then, knowing that the time had come when their degradation of religion into a mere tyranny and semblance should be set forth, He delivered the terrible denunciation which, with its eightfold "Woe unto you, Scribes and Pharisees, hypocrites," was intended to leave them utterly inexcusable. The Jewish authorities felt that this was a final rupture, that they must now, at all costs, bring about His immediate death.

Before He left the temple for ever He taught the lesson of true charity as illustrated by the widow's mite, and then went and sat on the green slopes of the Mount of Olives. There He pronounced to His disciples that great eschatological discourse which was suggested by their admiration of the temple buildings, destined so soon to sink in blood



and ashes. In the cool of evening they walked to Bethany, perhaps at the very time that Judas was arranging with the priests the final details of His betrayal and arrest. The Wednesday was spent in deep retirement at Bethany, and not a single word or incident is recorded on that day. On the Thursday morning He woke never to sleep again.

(7) On the evening of Thursday Jesus went with His disciples to Jerusalem to keep that quasi-paschal feast at which He instituted the sacrament of the Eucharist. Even then the apostles had jealousies about precedence, and it was to cure them of their fatal tendency to selfish pride and ambition that He washed the disciples' feet. During the supper He first indicated to John, and through him to Peter, that He knew who the traitor was. He clearly told them that this was the last meal which He should eat with them, and bade them henceforth "eat bread and drink wine" in sacramental memory of Him. It was after Judas had gone forth into the night that He began those last discourses preserved for us by St John alone, which are so "rarely mixed of sadness and joys, and studded with mysteries as with emeralds." There is a matchless beauty and tenderness in the records of His gentle words of warning and help to Peter, Thomas, Philip, and Jude, and of that familiar intercourse with his dearest followers, whose sinking spirits He sustained by the promise of the Comforter. Then they sang a hymn, probably the Psalm known to the Jews as the Great Hallel, and in the darkness walked to the olive garden of Gethsemane, where Jesus passed through His hour of mysterious agony and passion, while even His most beloved apostles could not watch with Him. Then torches suddenly flashed upon the night as the traitor, accompanied by priests and their servants, and Levites of the temple guard, and Roman soldiers, made their way across the valley of the Kidron to the slope of Olivet on which the garden lay. There Judas betrayed Him with a kiss; and, in spite of the supernatural awe which His presence inspired even into His enemies, He resigned Himself into their hands, rebuked the rash blow of Peter, and by one last act of mercy healed the slight wound of Malchus. "Then all His disciples forsook Him and fled."

(a) He was taken first to the astute and aged Annas, who was regarded as high priest *de jure*, though not *de facto*. From this time forward it was the priestly party—the Sadducees, not the Pharisees—who were almost exclusively responsible for His death. On His refusal to plead before this disorderly midnight tribunal, He was struck on the mouth; and, failing to extort anything from Him, Annas sent Him bound across the courtyard to his son-in-law Caiaphas, the *de facto* high priest.

(β) It was still night, and here took place the second irregular and illegal trial, before His worst enemies among the priests and Sadducees. The false witnesses who endeavoured to convict Him of having threatened to destroy the temple failed, and He preserved unbroken silence until Caiaphas adjured Him by the living God to tell them whether He was the Messiah, the Son of God. In answer to this appeal He said "I am," and told them that they should see His return hereafter in the clouds. Then Caiaphas rent his robes with the cry of blasphemy, and this committee of the Sanhedrin declared Him "guilty of death."

(γ) After this second examination Jesus was remanded to the guardroom until break of day, before which time the whole Sanhedrin could not meet. As He was led past the brazier in the courtyard, His one glance broke into penitence the heart of His backsliding apostle, who had just denied Him with oaths. As He waited, He was insulted by the coarse derision and brutal violence of the priestly menials. When the Sanhedrin met, they once more entirely failed to fix any charge upon Him, until He renewed in their presence His claim to be the Son of God. He was

then formally condemned to death, and underwent a second derision at the hands of the assembled elders. It was after this condemnation that remorse seized the dark soul of Judas. He flung down the blood-money before his tempters, and with an agonized confession of guilt rushed out to his terrible suicide.

At this period the Jews had lost all legal right to put any one to death, and they were further anxious to avoid personal responsibility, and danger of vengeance from the followers of Jesus, by handing Him over for execution to the Roman procurator. Accordingly they led Him bound to Pilate in imposing procession. They were, however, mistaken in supposing that Pilate would crucify Jesus at their bare word without seeing whether He was guilty; and, as they could not enter the Herodian palace, in which the Gentile ruler lived, without pollution, which would have prevented them from partaking in the passover that evening, Pilate went out to them. In every line of the brief colloquy which ensued we trace the haughty contempt of the Roman, and the burning hatred of the Jews. Failing to arrive at any definite charge, Pilate questioned Jesus alone inside the prætorium, and after a brief examination came out to the Jews with the declaration of complete acquittal.

In the wild clamour which ensued he caught the word Galilee, and, understanding that Jesus had chiefly taught in Galilee, eagerly seized the opportunity of getting rid of the matter by sending Him to Herod. But before Herod as before Pilate Jesus retained His majestic silence, and, unable to condemn Him, Herod contented himself with arraying Him in a white festive robe, setting Him at naught with his myrmidons, and sending Him back with a second practical acquittal to the procurator.

Then, in three stages, began the third and most agonizing phase of the public trial. Pilate, seated on his bema upon the marble pavement, declared that, as His innocence was now certain, He would merely scourge and dismiss Him. It was a disgraceful proposal, due partly to his desire to save the life of one whom he saw to be innocent, but dictated by fear of a new riot. Further than this, the warning of his wife, and the awful majesty of the sufferer, had created a strong presentiment in Pilate's mind. But his actions were practically controlled by the past guilt which made him tremble at the thought of the complaints which Jews, Samaritans, and Galileans could alike prefer against him. He did not therefore venture to refuse the cry of the mob—hounded on as they were by the priests and Sanhedrists—for the passover boon of having a prisoner liberated to them; and he vainly tried to induce them to ask for the liberation of Jesus. They demanded the rebel and murderer Bar Abbas, and began to shout for the crucifixion of Jesus. Bar Abbas was set free, and Jesus underwent the horrible Roman scourging, which was followed by the ruthless mockery of the soldiers, who arrayed Him in an old crimson robe and placed a crown of thorns on His head, and a reed in his hand as a sceptre, and so paid Him mock homage as a king of the Jews.

When He came forth after this hour of agony, Pilate made one more appeal to their compassion in the words "Behold the man!" and on hearing that He claimed to be "a Son of God"—for since the charge of treason had broken down, the priests now substituted for it a charge of blasphemy—he became still more alarmed, and once more questioned Jesus in a private interview. For some time Jesus would not speak. When He did, it was to say that He regarded Pilate as less guilty than the Jews. As Pilate led Him forth, and saw Him stand before that shameful yelling multitude in His majesty of solemn woe, he broke forth into the involuntary exclamation, "Behold your King!" That word raised among the multitude some

very ominous allusions to Cæsar, and Pilate, after publicly washing his hands, in token that he was innocent of this death, pronounced the fatal order for His crucifixion.

Jesus was then clad in His own garments and led forth with two robbers to be crucified. As He was unable to bear the weight of His cross, Simon of Cyrene was impressed for that service. On His way Jesus gently consoled the weeping daughters of Jerusalem, and, when they reached the fatal spot of Golgotha, He refused the stupefying potion which was offered to Him, and prayed for His murderers even as they drove the nails through His hands. Pilate managed to insult the Jews by putting over the cross the title "The King of the Jews," in three languages, which thus in the presence of the vast passover multitude testified to the truth. On the cross Jesus hung for three hours in agony. The soldiers parted His garments, and cast lots for His seamless robe. The mob, the priests, even the crucified malefactors, joined in taunting Him. But He answered not. After His prayer for His murderers He only spoke to promise paradise to the penitent robber; to assign His mother to the care of the beloved disciple; to quote in the lowest depth of His agony the first words of the 22d Psalm; to give vent to the sole expression of physical anguish which He uttered, "I thirst"; to commend His spirit into His Father's hands; and lastly, in the one victorious word *Τετέλειται*, "it is finished," to end His work on earth. The bearing of Jesus on the cross, together with the circumstances which accompanied the crucifixion—the darkness, earthquake, and rending of the temple veil—produced a deep impression even on the mind of the heathen centurion. They so powerfully affected the multitude that they returned to Jerusalem wailing and beating on their breasts, at once with a feeling of guilt and a presentiment of future retribution.

(8) At evening the soldiers despatched the two crucified robbers by breaking their legs, in order that their bodies might be removed before the passover. But they found Jesus already dead, and the certainty of His death was assured by one of the soldiers driving his spear into the region of the heart, whence came out blood and water. As very little time was left before the sunset marked the beginning of the Sabbath, and rendered labour impossible, the body of Jesus was hastily buried by Nicodemus and by Joseph of Arimathæa, who had obtained the requisite permission. They wrapped it in fine linen and spices, and laid it in the rockhewn garden-grave of Joseph, rolling a great stone to the aperture, which was further guarded by soldiers sent by the Jews to prevent its removal for purposes of fraud. This was on Friday evening. Very early on the morning of Sunday, while it was yet dark, the two Marys were met at the sepulchre by a vision of angels which announced His resurrection. Of that resurrection, in spite of their original doubts and misgivings, the whole body of the disciples became unalterably convinced, and on their unalterable conviction, and the subsequent witness of history to the blessed truth of their doctrines, has rested in great measure the belief of the Christian church. Uniting the contemporary testimony of St Paul, who must have been in personal communication with many of the five hundred witnesses to whose evidence he appeals, with those of the Gospels, we find ten recorded appearances:—(1) to Mary Magdalene (John xx. 17); (2) to other women (Matt. xxviii. 9, 10); (3) to Peter (Luke xxiv. 34; 1 Cor. xv. 5); (4) to the two disciples on their way to Emmaus (Luke xxiv. 13-32); (5) to the ten apostles. All these appearances occurred on the first Easter day. On the following Sunday Jesus appeared (6) to the eleven apostles, Thomas having been absent on the previous occasion. He further appeared (7) to seven apostles by the Sea of Galilee (John xxi. 1-24);

(8) to more than five hundred at once on a mountain in Galilee; (9) to James (1 Cor. xv. 3, 8); and (10) at the ascension. These appearances continued for forty days. On the last occasion Jesus led His disciples towards Bethany, gave them His last command, blessed them, and as He blessed them passed away, and "a cloud received Him out of their sight."

VI. Such, in briefest outline, are the main recorded events of the life of Jesus Christ on earth. It only remains to say a few words concerning His person and His work, regarded here in their historical rather than in their theological aspect.

As regards His person, Christians who accept the New Testament as the record of inspired teaching, and who believe it to be evidenced, not only by inward and supernatural revelation, but also by the subsequent history of the church and the world, believe that Jesus Christ was (in the words of what is probably a very ancient Christian hymn quoted by St Paul) the only begotten Son of God, "manifest in the flesh, justified by the Spirit, seen of angels, preached unto the Gentiles, believed on in the world, received up into glory";<sup>1</sup> and as a part of this belief they hold that, just as Adam the first man was not born but created, so the second Adam, who came to redeem our nature, was not born by ordinary generation but was "incarnate by the Holy Ghost of the Virgin Mary." But even those who do not accept this faith see in Jesus a unique and sinless personality, one with whom no other human being can even distantly be compared, either in His character, His teaching, or the results which He accomplished by His brief ministry. He taught but for three years, and not continuously even during them. He accepted the most ordinary customs of the teachers of His day. He wore no broad phylacterics like the Pharisees; He was not emaciated with asceticism like the Essenes; He preached the kingdom of God, not, as John had done, between the gloomy precipices of the wilderness, but from the homely platform of the synagogue, to give the Midrash when the Torah had been read.<sup>2</sup> He appeared before the people, not in the hairy mantle of a prophet, but "in the ordinary dress of a Jewish man, at the four ends of which the customary tassels were not wanting."<sup>3</sup> He came "eating and drinking"; He had no human learning; His rank was but that of a village carpenter; He checked all political excitement; He directed that respect should be paid to all the recognized rulers, whether heathen or Jewish, and even to the religious teachers of the nation; He was obedient to the Mosaic law; His followers were "unlearned and ignorant men" chosen from the humblest of the people. Yet He has, as a simple matter of fact, altered the whole current of the stream of history; He closed all the history of the past, and inaugurated all the history of the future, and all the most brilliant and civilized nations of the world worship Him as God. Kant testifies to His ideal perfection.<sup>4</sup> Hegel saw in Him the union of the human and the divine. Even the most advanced of sceptics do Him homage. Spinoza spoke of Him as the truest symbol of heavenly wisdom. The beauty and grandeur of His life overawed even the flippant soul of Voltaire.<sup>5</sup> "Between Him and whoever else in the world," said Napoleon I. at St Helena, "there is no possible term of comparison."<sup>6</sup> "If the life and death of Socrates are

<sup>1</sup> 1 Tim. iii. 16.

<sup>2</sup> See Hausrath, *Neutest. Zeitgesch.*, vi. § 8 *ad fin.*

<sup>3</sup> Matt. ix. 20; Mark vi. 56; Luke viii. 44.

<sup>4</sup> When Borowski rashly placed too near to each other the names of Christ and of Kant, Kant nobly said, "The one name is holy; the other is that of a poor bungler doing his best to interpret Him."—*Anden Kirchenrath Borowski*, Works, xi. 131.

<sup>5</sup> See *Dict. Philos.*, art. "Religion."

<sup>6</sup> Montholon, *Récit de la Captivité de l'Emp. Napoléon*.



those of a sage," said Rousseau, "the life and death of Jesus are those of a God."<sup>1</sup> "He is," says Strauss, "the highest object we can possibly imagine with respect to religion, the Being without whose presence in the mind perfect piety is impossible."<sup>2</sup> "The Christ of the Gospels," says Renan, "is the most beautiful incarnation of God in the most beautiful of forms. His beauty is eternal; His reign will never end."<sup>3</sup> John Stuart Mill spoke of Him as "a man charged with a special, express, and unique commission from God to lead mankind to truth and virtue."<sup>4</sup>

The transcendent power of His personality, which is betokened in such expressions as those quoted above, is due, not only to His devotion and self-sacrifice, but to His absolute sinlessness. This constitutes the unique character of His individuality. He alone of mankind has claimed to be sinless, and has had the claim granted by unanimous consent both in His lifetime and in subsequent ages. He alone among men has never even been assailed by the breath of moral calumny, and never even in His most sacred utterances and prayers betrayed the faintest consciousness of any evil as present in His soul. He therefore alone has furnished mankind with a perfect ideal; and, though no saint has ever even distantly attained to the perfectness of that ideal, yet those who have done so in greatest measure have always said that they have done so solely by the aid of His grace, and the imitation of His example.

Nor was His teaching less unique than His personality. It was marked by a tone of sovereign authority; "Ye have heard that it was said—but I say unto you." In this it was the very opposite to the teaching of His own day and of centuries afterwards, which relied exclusively upon precedent. It was also marked by absolute originality. The test of its originality is the world's acceptance of it as specifically His. Isolated fragments of it may be compared with truths uttered by others; but it stands alone in its breadth and in its power, in its absence of narrow exclusiveness and scholastic system and abstract speculation. It was fresh, simple, natural, abounding in illustrations at once the most beautiful and the most intelligible, drawn from all the common sights and sounds of nature, and all the daily incidents and objects of social and domestic life. It flowed forth without reserve to all and on every fitting occasion,—on the road, on the hillside, on the lake, or by the lonely well, or at the banquet whether of the Pharisee or the publican. Expressed in the form of parables, it has seized the imagination of mankind with a force and tenacity which is not distantly approached even by the sacred writers, and even when not directly parabolic it was so full of picturesqueness and directness that there is not one recorded sentence of it which has not been treasured up in the memory of mankind. His utterances not only rival and surpass all that preceded and all that has followed them, but "they complement all beginnings." Sometimes they consist of short suggestive sayings (gnomes), full of depth, yet free from all affectation or obscurity,<sup>5</sup> which make even what is most mysterious and spiritual humanly perceptible, throwing over it the glamour both of poetry and of a longing presentiment, and incessantly enticing man towards something yet higher. There is never in them a lurking fallacy nor a superfluous word, but all is "vivacity, nature, intelligibility, directly enlightening grace," intended only to convince and to save. And while such was the incompar-

able form of His teaching, its force was even more remarkable. It is all centred in the two great truths of the Fatherhood of God and the brotherhood of man; from the former springs every truth of theology, from the latter every application of morals. Judaism had sunk into a religion of hatreds; the one message of Jesus was love. In this He differs even from John the Baptist and the prophets. "Their emblem is the storms, His the sun."

Once more,—as regards the work of Jesus, the Christian believer contemplates it in that aspect in which it is presented by St Paul as a work of atonement, the redemption of a guilty race;<sup>6</sup> but even apart from this the mere historical student must admit that Christ elevated both the individual and the race as none have ever done before or since. His doctrine purified the world from the loathly degradation of lust and luxury into which society had fallen. By convincing men of the inherent dignity of manhood, He added to the value of human life. He made holiness a common possession. Heathen morality had reached its loftiest point in the Stoic philosophy; but Stoicism was scornful, ineffectual, despairing, and Christ gave a moral system infinitely more perfect, more hopeful, and more tender to all mankind. To Him is alone due the Christian significance of such words as charity, humility, and humanity. He first taught the sacredness of the body as a temple of the Holy Ghost. He has inspired the aims of the noblest culture, while at the same time He has restored the souls of men, and made the care of the moral and spiritual being the supreme end of life. The gradual emancipation of the world from the tyrannies of sensuality, cruelty, and serfdom has been won step after step from His principles. The supremacy of the spiritual, the solidarity of nations, the universality of God's love, the essential equality of all men in His sight, are but a few of the great and fruitful conceptions which have sprung directly from His teaching, and which still have an unexhausted force, to bring about, in ever-increasing measure, the amelioration of the world.

VII. It only remains to touch on the growth and progress of Christian doctrine relative to the Person of Christ. It would have been impossible for the Christian world to have drawn from the teaching of the apostles and evangelists any other conclusion respecting Jesus than that He was more than man,—that He was "God manifest in the flesh." The Gospels spoke of His incarnation, His sinlessness, His miraculous power, His claims far loftier than would have been possible to simple man, His fearless conjunction of His own name with that of the Eternal Creator. Alike the Gospels and the Epistles testify to His pre-existence (John i. 15, vi. 52, viii. 58), His eternal existence (1 Pet. iii. 18-20; Phil. ii. 6, 7; Rev. i. 11), His part in the creation of the world (Heb. i. 11), His miracles of power; and they speak of Him in terms incompatible with simple humanity.<sup>7</sup> It is indisputable that no Christian, who accepted as divine revelations the writings of St John and of St Paul, could possibly suppose that the Saviour, in whom he was taught to trust, and into whose name he was baptized, was a mere human being like himself. And yet, that Jesus was perfectly human, as well as divine, they could not for a single moment doubt. He was born of a woman. He grew like other children. He suffered hunger, and thirst, and weariness, and pain, and wounds, and death. He had flesh and bones like all other men, and passed through the stages of life as others do. And His soul was a human soul no less than His body was a human body; for He increased gradually in wisdom no less than in stature; and felt sorrow and sympathy, and was subject to temptation, and was liable to the common emotions of our mortal nature.

With these facts the earliest teachers of the church were content. When they had asserted that Christ was both human and divine, "born and unborn, God in flesh, life in death, born of Mary and born of God" (Iren., *Ep. ad Ephes.*, 7), they entered into no speculations respecting the mode and definition of that union of natures. But such reticence soon became impossible. The doctrine of a God-man was openly assailed or secretly undermined by twofold

<sup>1</sup> *Émile*.

<sup>2</sup> *Vergängl. u. Bleibendes in Christenthum*, 132. In his *Leben Jesu*, ii. 229, he says that Jesus "in His all but perfect life stood alone and unapproached in history."

<sup>3</sup> *Études d'Hist. Rel.*, 213, 214.

<sup>4</sup> *Three Essays*, p. 254, where he also speaks of Christ as "the ideal representative and guide of humanity."

<sup>5</sup> See Keim, *Jesu von Nazara*, ii. 1, 3.

<sup>6</sup> For St Paul's two most elaborate and concentrated statements of his theology see Rom. iii. 20-26; 1 Tim. ii.-5, 6 (iii. 16). See also 2 Tim. i. 8, 10.

<sup>7</sup> Col. ii. 9; John xii. 41; Matt. xxviii. 18; 1 Thess. iii. 2; 2 Thess. ii. 16, 17; Phil. iii. 21; 1 Cor. iv. 5; 2 Cor. v. 10; 2 Tim. iv. 1; the Gospel and Epistles of St John, the Epistles to the Colossians and Ephesians, and the Apocalypse *passim*, &c.



forms of heresy—partly by Jewish Ebionites, partly by Gentile Docete. The Ebionites, the Nazarenes, the followers of Artemon, the Alogi, and many sects allied to them in their main principle, denied the true divinity of Christ. In the opposite direction many of the Gnostic sects entirely explained away His humanity, either with the Basilidians supposing that He only became divine at His baptism, or holding with the Valentinians that Mary was only the channel by which He entered the world. To both these conflicting fancies the orthodox fathers opposed the simple statement of St John that “the Logos became flesh.” But, as was natural, their opinions were as yet vague and even in some instances erroneous. Thus Justin Martyr thought that in Christ the Logos took the place of the human intelligence (*Apol. min.*, ch. x.). Clement of Alexandria thought that the human needs and sufferings were only apparent, or by way of “accommodation” (*Pæd.*, i. 5, p. 112; *Strom.*, vi. 9, p. 775, ed. Syb.). Origen had clearer views, and was the first to use the term God-man (*θεοάνθρωπος*), as well as to guard against the double error of excluding the Logos from Christ, or of confounding the Logos with the existence of the human Christ (*Hom. in Ezech.* iii. 3; *C. Cels.*, iii. 29). It is, however, important to observe that the existence of technical errors of theology in the modes of expressing this doctrine adopted by the Ante-Nicene fathers was freely admitted, and was not regarded as formal heresy. Their individual insight was not sufficient to enable them to arrive at those careful scholastic definitions to which the church was only guided by the collective wisdom of oecumenical councils after periods of long and painful conflict. The remarks of St Jerome on the real orthodoxy of the early fathers are both charitable and explicit. “It may be,” he says, “that they erred in simplicity, and that they wrote in another sense, or that their writings were gradually corrupted by unskilful transcribers; and, certainly, before Arius like ‘the destruction that wasteth at noonday’ was born in Alexandria, they made statements incautiously which are open to the misinterpretations of the perverse.” We find a remarkable illustration of the extent to which the terminology was as yet unsettled in the fact that the council at Antioch which condemned Paul of Samosata in 269 also condemned the expression *homoousios* (“consubstantial”), which a century afterwards became the very watchword of Nicene orthodoxy.<sup>1</sup>

By the 3d century the Ebionizing heresies were practically dead, but the Docetic were still flourishing in various forms. Two sects had arisen; one was that of the Patripassians, who so completely obliterated all real distinction between the first and second person of the Trinity as to lay themselves open to the charge of teaching that the Supreme Father had been crucified. Thus Praxeas taught that the same God is at once the Father and Son. Noetus of Smyrna, when banished from Ephesus, taught these notions at Rome, and even the Popes Zephyrinus and Callistus seem to have been imbued with them. Sabellius, a presbyter of Ptolemais, elaborated these opinions into a system in which Father, Son, and Holy Spirit were only three modes of manifestation, three names, three aspects of the divine monad revealing itself under three different forms (*Greg. Nyss.*, *Orat. e. Arian. et Sabell.*). The Monarchians, on the other hand, in their equal anxiety to avoid all danger of Ditheism and Tritheism, admitted the supernatural birth of Christ, but only saw in Him the holiest of the prophets; these views were expounded at Rome by Theodotus of Byzantium, who was consequently expelled from the church by Pope Victor. The heresies of Paul of Samosata, the vain and brilliant patriarch of Antioch, seem to have originated in an unhappy attempt to reconcile the views of these Monarchian sects by teaching that not the whole divine substance was manifested in Christ, but only one single divine power. He thus distinguished between the Logos and the human Son of God. He was banished and died in obscurity, but the sect, which was generally called Patripassian in the West and Sabellian in the East, continued to linger on for a time.

All these controversies were but preludes to the great struggle of the church against Arianism. Hitherto she had condemned the Noetians and Sabellians for denying the hypostasis of the Son as distinct from the Father, and the Theodotians and Ebionites for denying His divinity. Arius, a presbyter of Alexandria, admitted both the divine and the human nature of Christ, but by making Him subordinate to God denied His divinity in its highest sense. He was led to this error by the reaction against Sabellianism, and he ranked the Son among created beings, saying that “there was (a time) when He was not.” Arius was deposed and excommunicated by a council at Alexandria, but since many bishops, and among them the distinguished Eusebius of Cæsarea, and Eusebius of Nicomedia, interceded in his favour, the dispute assumed such wide proportions that Constantine was compelled to intervene by summoning in 325 the first oecumenical council of Nice. By this council the doctrine of Arius was condemned, and it was declared to be a matter of the Catholic faith that the Son was not only of like essence (*homoousios*) but of the same essence (*homoousios*) with the Father.

It was long, however, before the voice of controversy was silenced.

Many bishops still continued to be on the one hand Arian or Semi-Arian, while on the other hand men of great power and enlightenment, like Marcellus of Ancyra and Photinus of Sirmium, slid back into dangerous affinity to Sabellianism. It was in consequence of a similar reaction that Apollinaris, bishop of Laodicea, in the desire to maintain the glory of Christ, fell into a new heresy and revived an old error, by arguing that in Jesus the Logos supplied the place of the reasonable soul. It is obvious that such a view undermined the doctrine of the example and atonement of Christ, and it was condemned in 381 at the council of Constantinople.

The next great controversy arose from the refusal of Nestorius, patriarch of Constantinople, to apply to the Virgin Mary the term *Theotokos* or mother of God. In his endeavour to avoid the extremes which had already been condemned, he spoke of the union of the two natures in Christ as a connexion (*συνάφεια*) or indwelling (*ἐνοίκησις*), but denied that there was any communication of attributes (*κοινωνία ἰδιωμάτων*). He maintained, in fact, a mechanical rather than a supernatural union of the two natures. He was condemned in the council of Ephesus, 431, and died in exile; but the schools of Edessa and Nisibis still maintained the Nestorian doctrine, which has continued in the East even till the present day.

The last great controversy on the two natures was raised by Eutyches, archimandrita of Constantinople, who confounded together the two natures which Nestorius had separated, thus inaugurating what is known as the Monophysite heresy, which was condemned in the council of Chalcedon, 451. It is needless to explain the obscure heresies of Theopaschites, Phthartolatri, Aphthartodocetæ, or to do more than name the views of the Monothelites, who strove to put an end to controversy by maintaining that though there were two natures in Christ there was only one will. The main results at which the church arrived cannot be better summed up than they are in an admirable passage of Hooker (*Ecol. Pol.*, v. 54, 10): “There are but four things which concur to make complete the whole state of our Lord Jesus Christ. His deity, His manhood, the conjunction of both, and the distinction of the one from the other being joined in one. Four principal heresies there are which have in those things withstood the truth: Arians by bending themselves against the deity of Christ; Apollinarians by maiming and misinterpreting that which belongeth to His human nature; Nestorians by rending Christ asunder and dividing Him into two persons; the followers of Eutyches by confounding in His person those natures which they could distinguish. Against these there have been four most ancient general councils: the council of Nice to define against Arians; against Apollinarians the council of Constantinople; the council of Ephesus against Nestorians; against Eutychians the Chalcedon council. In four words *ἀληθώς, τελώς, ἀδιαίρετως, ἀσυνχύτως*, truly, perfectly, indivisibly, distinctly—the first applied to His being God, the second to His being man, the third to His being of both One, and the fourth to His still continuing of that one Both—we may fully, by way of abridgement, comprise whatever antiquity hath at large handled either in declaration of Christian belief, or in refutation of the fore-said heresies.” The result of these centuries of controversy was enshrined in the so-called Nicene creed—“the holy symbol declared at Nice, established at Constantinople, strengthened at Ephesus, sealed at Chalcedon.”

When the church had thus rigidly defined the limits of Catholic orthodoxy, the decisions of the four oecumenical councils were accepted, and no further controversies rose on these subjects for about 800 years. The disputes between the Nominalists and the Realists, and the speculations of the Schoolmen generally as regards this subject, turned rather on the proofs or illustrations of the doctrine of the Trinity than on theories respecting the two natures of Christ. There are remarks and illustrations not only in the Schoolmen but even in the Reformers which might be regarded as questionable, but none of them were intended to diverge from the Catholic verity. Passing over the crude system of Servetus, we hear of Unitarian communities in Poland as early as 1563. In 1544 Lælius Socinus had been obliged to leave Italy because his opinions were known to be unfavourable to the divinity of Christ. - On his death at Zurich in 1562 his nephew Faustus Socinus openly taught the opinions which he had learnt from his uncle's papers, and acquired a considerable following in Poland. The exegetic methods of Socinianism were so weak, and its rupture with Christian history so absolute, that the special views of the Socini—which were that Christ, though miraculously born, was only the highest of men, and was deified after His death as a reward for His virtue—have had an indirect rather than a direct influence. In 1611 three men were burnt in England for denying the doctrine of the Trinity, but in the middle of the 17th century we find John Biddle recognized as a leader of the Unitarians, and the spread of Unitarian doctrines led Bull to write his celebrated *Defensio Fidei Nicenæ* in 1685. The first Unitarian church in England was founded in 1773 by Lindsay. The writings of Spinoza and of the English deists—Herbert, Toland, Shaftesbury, Chubb, Bolingbroke—helped largely to weaken the orthodox faith. But in later periods it has been rather undermined than denied.

<sup>1</sup> Mansi, I 1001; Euseb., *H. E.*, vii. 27-30; Epiphani., *Hæres.*, lxx. 1.



While nominally accepted it has been understood and explained in a manner of which the ancient church never so much as dreamt. Kant used all the traditional formulae, but they do not appear to have been more to him than symbolic expressions. Similarly Scobell spoke of the Three Persons of the creeds as three *Momentums*, for which he substituted in later years the word *Potenzen*, and the language of Fichte and Hegel practically sublimates to nothing the doctrine of Christ's divinity.

But this "dispersive analysis" of the later centuries has shown itself most markedly in some of the Lives of Jesus, and these prove very conclusively that many Christians have not preserved the Nicene faith, but find an insuperable stumbling block in the miracles. Even in the treatment of the life of Jesus by Hess (1768) there is a spirit of concession to modern doubt which becomes still more marked in the similar sketches of Herder (1796), who leans, wherever he can, to the natural or the symbolic view of miracles. The *Leben Jesu* of Paulus was written with the avowed object of explaining away the supernatural elements in the Gospels while yet the evangelists themselves were accepted as faithful witnesses,—an attempt which at once fell to the ground under the weight of its own absurdity. Far different was the line adopted by Schleiermacher in his *Lectures on the Life of Jesus* (published from notes by Rüttenik in 1864). Schleiermacher wished to steer between the Ebionitic and the Docetic views of Christ, but while maintaining the divinity he systematically endeavours to reduce the miracles within the scope of natural laws, and treats even the resurrection in a rationalizing manner, as though Jesus had not really died. Hess, in his *Leben Jesu* (1829), leans in the same direction, supposing that Jesus possessed some unknown power and a sort of sanative magnetism. None of these writers have, however, produced so deep an impression as Strauss and Renan. Strauss, instead of endeavouring to eliminate the supernatural, or to invest it in some sort with a natural appearance, treated the Gospel narratives as myths from which it was hardly possible to understand the historic personality of Christ. In his *Leben Jesu* (1835) he rejected the Fourth Gospel altogether; in his second edition, in deference to Neander, he left the question neutral. In this earlier phase he regarded Jesus as merely "the idea of the identity of God and man, and the mission of humanity" built up on Messianic prophecy; but he afterwards, as in his *Life of Christ for the People* (1864), attached more importance to the tendency-theory of Baur, and in his later writings (*The Old Faith and the New*, 1873) treated the existence of Christianity in as disdainful a tone as though it were hardly worthy of any explanation at all. Renan (*Vie de Jésus*, 1863) entirely abandoned all faith in Christ's divinity, and, while speaking of Him as one "whom His death had made divine," treated Him from the point of view of an amiable rabbi who, beginning as an innocent enthusiast, developed into something hardly if at all removed from common impotence. Meanwhile these negotiations had provoked a strong reaction; and writers like Neander (1837), Ebrard (1842), Lange (1843), Olshausen (1853), Weisse (1856), Riggenbach (1858), and above all Ewald (1855), maintained with abundant learning the truth of the Gospel narratives, though the works of all of them betray, in a greater or less degree, the signs, to which Neander so touchingly alludes, that they were produced "in an age of crisis, of isolation, of pain, and of throes." The most important recent contribution to the literature of this subject is the *Jesu von Nazara* of Keim (1867). He writes in a reverent spirit and a powerful style, with abundant learning and patient research. He takes his stand on the sinlessness of Jesus, and presents Him as human indeed but still divine in the exaltation of His humanity. Keim attributes the Fourth Gospel to a late and post-apostolic author, and when he gives it as his conclusion that "in the life of Jesus, where the most genuine and unadulterated humanity dwelt, was revealed at the same time not only a religious genius, but the miracle of God and His presence upon earth," and

that "the person itself and nothing else is the miracle," he shows by how vast a space modern opinion has receded from the views of the Catholic church. The English works on the *Life of Christ* have been very numerous of late years, and have been marked with few exceptions by their fidelity to Christian faith.

*Literature.*—The bibliography of the life of Christ is immense, and the monographs on isolated questions which bear upon it may be counted by hundreds. The reader will find a fairly adequate account of the results of a comprehensive critical survey of the whole field in Hase's *Geschichte Jesu*, 1875. So far as the patristic and mediæval periods are concerned, the gospel-harmonies of Tatian, Ammonius of Alexandria, Victor of Capua, Gerson, and the poetical compositions based upon the Gospel narratives by Prudentius, Sedullus, Nonnus, Cædmon, the author of the *Heliand*, Otfrid of Weissenburg, and others, may be dismissed with a mere reference. Of greater importance as early examples of a large class of works, designed for religious edification rather than for historical portraiture, are the *Vita Christi* of Bonaventura (first printed in 1496, and often since, the latest English translation bearing so recent a date as 1880), and the *Vita Jesu Christi* of Ludolphus Saxo (written about the middle of the 14th century, and first printed at Strasburg in 1470). After the Reformation the harmony of the Gospels continued to absorb much of the attention of scholars, and many able works in this field, from that of Oslander (1637) to that of Bengel (1736), appeared, all of them, however, unnaturally restricted by the limitations of a conventional orthodoxy, and marked by a characteristic absence of the critical spirit. The only work belonging to this early period which can be said still to possess permanent value is the *Life of Christ* by Jeremy Taylor, 1653. Such works as the *Messiah* of Klopstock, 1748, belong to literary rather than to theological history. The beginnings of a new historical method can be traced in the writings of the English deists, such as Woolston and Chubb, a method which somewhat later was taken up by Reimarus and Lessing, and gave rise on the other side to the apologetic works of Lardner, Paley, and others in England, and in Germany to those of Herder (*Vom Erlöser des Menschen, oder unsere drei ersten Evangelien*, and *Von Gottes Sohn der Welt Heiland nach Johannes*) and of Hess (*Geschichte der drei letzten Lebensjahre Jesu*, 1768; 7th ed., 1823, with the title *Lebensgeschichte Jesu*). In chronological order, the names of Schleiermacher and Hase come next. The lecture of the former, first delivered in Berlin in 1819, and frequently repeated in subsequent years, had almost expended their great influence before their publication by Rüttenik (*Vorlesungen über das Leben Jesu*, 1864); those of the latter, begun at Tübingen in 1823-4, first saw the light as a *Leben Jesu* in 1829 (6th ed., 1865), and in a still more expanded form entitled *Geschichte Jesu* in 1875. Their publication was preceded and occasioned by that of the *Leben Jesu als Grundzüge einer reinen Geschichte des Urchristenthums* of Paulus in 1829. A new phase of negative criticism was introduced by the publication in 1835 of the *Leben Jesu* of Stauss, further developments of which are to be found in his *Leben Jesu für das deutsche Volk bearbeitet* (1865; Eng. transl., 1865), and in the writings of his followers, among whom may be mentioned C. H. Weisse (*Das Leben Jesu kritisch u. philosophisch bearbeitet*, 1838), Salvaor (*Jesús Christ et sa doctrine*, 1858), and Gfrörer (*Geschichte des Urchristenthums*, 1838). Among the very numerous works controverting these in the interests of Christian apologetics, the most important are those of Tholuck (*Die Glaubwürdigkeit der Evangelischen Geschichte*, 1837), Neander (*Das Leben Jesu Christi*, 1837; 7th ed., 1873; Eng. transl., 1846), Ebrard (*Wissenschaftliche Kritik der Evangelischen Geschichte*, 1842), Wieseler (*Chronologische Synopse der vier Evangelien*, 1843), Lange (*Leben Jesu*, 1844-47; Eng. transl., 1864, 1871), from the Protestant standpoint; and those of Kuhn (*Leben Jesu*, vol. 1, 1838), Sepp (*Leben Christi*, 1843), and Bucher (*Das Leben Jesu Christi*, 1859), from the catholic. The writings of the Tübingen school (Bruno Bauer, *Kritik der Evangelischen Geschichte des Johannes*, 1840; *Krit. d. Ev. Gesch. der Synoptiker*, 1841; *Krit. d. Ev. Gesch. der Synopt. u. d. Johannes*, 1842; *Krit. der Evangelien u. Gesch. ihr. Ursprungs*, 1850; F. C. Baur, *Krit. Untersuchungen ü. d. Kanon. Evangelien*, 1847; *Das Christenthum u. d. Christliche Kirche der drei ersten Jahrhunderte*, 1853) on the other hand occasioned Ewald's *Geschichte Christus u. seiner Zeit* (1855), and the similar works of Lichtensteln (*Lebensgeschichte Jesu Christi in chronol. Uebersicht*, 1856), Hüggenbach (*Vorlesungen ü. d. Leben d. H. Jesu*, 1858), Baumgarten (*Die Geschichte Jesu*, 1859), Ellicott (*Historical Lectures on the Life of our Lord Jesus Christ*, 1860). Renan's *Vie de Jésus* appeared in 1863, Schenke's *Characteristia Jesu* in 1864 (compare the *Christusbild der Apostel u. der nachapostolischen Zeit* of the same author, 1878), Keim's *Der Geschichtliche Christ* in 1865, his *Jesu von Nazara* in 1867-72, Hausrath's "Die Zeit Jesu" in the *NTliche Zeitgeschichte* in 1870, Wiltchen's *Leben Jesu* in 1876, and Volkmar's *Jesu Nazarenus n. d. Schriftzeugen d. Iten Jhdts.*, p. 1, in 1881. With these may be contrasted, amongst many others which might be named, the following well-known works:—Pressensé, *Jésus Christ, son temps, sa vie, son œuvre*, 1865; Wilsäcker, *Untersuchungen ü. d. Evangelische Geschichte*, 1864; Gess, *Christ Person u. Werk*, 1870-73; Dupanloup, *Hist. de Notre Seigneur Jésus Christ*, 1870; Andrews, *Life of our Lord upon Earth*, 1863; F. W. Farrar, *Life of Christ*, 1874, 23d ed., 1881; Gellike, *Life and Words of Christ*, 1877; See Itono, a survey of the life and work of Christ, an anonymous work, which attracted much attention in its time, is also worthy of mention here. From Catholic sources we have the second volume of Bougaud's *Le Christianisme et les temps présents*, entitled *Jésus Christ*, 1871; also Grimm's *Leben Jesu nach den vier Evangelien*, of which as yet only two volumes have appeared, 1876-78. On Christology the standard work is Dörner's *Darstellung der Lehre von der Person Christi*, 1845-56; Eng. transl., 1862. (F. W. F.)

JESUS, THE SON OF SIRACH (Sirachides), the author of the book of Ecclesiasticus, was a native of Jerusalem, of whose personal life, apart from this one fact, vouchered for by himself (Ecclus. 1. 27), nothing is known, except that it was devoted to the study of the sacred literature. According to indications contained in chaps. xxxiv. 11, 12, xxxix. 4, 5, li. 1 sq., he seems to have travelled abroad, associated with princes, and once at least been placed in danger of his life by intrigues against him at a royal court. His collection of moral sayings (σφάια Ἰησοῦ υἱοῦ Σιράχ, LXX.; *Ecclesiasticus*, sc. *Liber, Vulg.*), originally written in Hebrew, and bearing according to Jerome the title of "Proverbs," was translated into Greek by his grandson, who came to Egypt in the thirty-eighth year of Ptolemy Euergetes (see the Prologue). By this Ptolemy Euergetes

we can only understand the second of that name, who began to reign as king of Libya and Cyrene in 170 B.C. Reckoning two generations back from 132 B.C., we reach the high priesthood of Simon II. (219-199 B.C.), to whom, and not to Simon I., the eulogy spoken in Ecclus. 1 is most probably to be assigned. The book was thus originally composed about 180 B.C.

JET, a mineral substance belonging to the carbonaceous group, and generally regarded as a compact variety of lignite, or wood-coal, impregnated with bitumen. The word *jet* (German *Gagat*) is corrupted from *gagates*, the name applied to it, or to a similar substance, by Greek and Roman writers, and derived, according to Pliny (*II. N.*, xxxvi. 34), from the river Gagas in Lycia, where the mineral was originally found. Its occurrence in Britain is



mentioned by Solinus; but it was certainly used there in pre-Roman times. Barrows of the Bronze Age have yielded beads, buttons, rings, armlets, and other personal ornaments of jet. The early supply was probably obtained from the Yorkshire coast, near Whitby—a locality which still yields the finest varieties. The Whitby jet occurs in isolated masses, of irregular shape, but frequently more or less lenticular, imbedded in bituminous shales near the base of the Upper Lias. The particular horizon of the jet-rock is known to geologists as the zone of *Ammonites serpentinus*. Opinion is divided as to the exact nature and origin of the jet: some regard it as a variety of lignite, others as a kind of cannel coal, and others again, as a hardened form of bitumen. There is little doubt that the jet has in all cases resulted from the decay of organic matter. Microscopic sections of jet frequently reveal a ligneous structure, in most cases of coniferous type. It has been suggested that masses of wood brought down by a river have drifted out to sea, where, becoming water logged, they have sunk and have gradually been covered with a deposit of fine black mud, beneath which the decay has slowly proceeded. Possibly bituminous matter may have been distilled from this decaying vegetation, and deposited between the layers of shale in its neighbourhood. Drops of liquid bitumen are frequently found in the fossils of the jet-rock, and inflammable gas, derived from the bituminous shales, is not uncommon in the jet-mines. Moreover, scales of fish and other fossils of the jet-rock are frequently converted into jet, the bituminous matter having replaced the original tissues. When jet is heated, it betrays its bituminous character by burning with a dense pungent smoke, which was formerly reputed to possess powerful medicinal virtues. At present the material is used only for trivial ornaments, principally for mourning jewellery. To obtain jet, the shale is systematically mined not only at its outcrop in the cliffs but in the inland dales of the Cleveland district. It is now rare to find washed jet upon the sea-shore, but formerly a considerable quantity was thus obtained. The best hard jet is exceedingly tough, and may be readily carved or turned on the lathe, while its compact texture allows it to receive a high polish. The final polish is given by means of rouge, which produces a beautiful velvety surface. The softer kinds, not capable of being freely worked, are known as bastard jet. From the estuarine beds of the Lower Oolites of Yorkshire, a soft jet is obtained; but, though occasionally used for ornamental purposes, it is far inferior to the true Whitby jet. Spanish jet has been largely imported into Whitby, but is deficient in hardness and lustre. Cannel coal from Scotland is occasionally used in the place of jet; and it is not uncommon for brooches to be made of a carving of Whitby jet set in a plain polished rim of either Spanish jet or cannel.

For descriptions of jet and jet-working see *The Yorkshire Lias*, by Ralph Tate and J. F. Blake, 1876; and a paper on *Whitby Jet*, by J. A. Bower, in *Jour. Soc. Arts*, December 19, 1873.

**JEW, THE WANDERING.** The legend of a Jew doomed to wander until the day of judgment, for an insult offered to Christ, is first mentioned by Roger of Wendover in the *Chronicle* completed by Matthew Paris, who received the story from an Armenian bishop, who visited England in the year 1228. As told in Matthew's *Historia Major*, the legend runs that the wanderer's name was Cartaphilus, that he was doorkeeper of Pilate's palace, and that as Jesus was led out to be crucified he struck him on the neck, saying, "Go, Jesus, go on faster; why dost thou linger?" Jesus replied, "I go, but thou shalt remain waiting till I return." The Armenian bishop, if his French servant and interpreter is to be trusted, said that this wanderer had dined with him shortly before his leaving home, and that he was now a penitent man and had

been baptized by Ananias, who also baptized Paul, under the name of Joseph. At the time of the crucifixion he was thirty years of age; whenever he reaches the age of one hundred he becomes faint, and when he becomes conscious again he is as young as when his doom was pronounced. He never smiles, refuses all gifts, and narrates many ancient events to those who come from far and near to listen. On the same authority rests the somewhat later account by Philippe de Mousket in his *Chronique rimée*. The English chronicler states that the bishop's statement was in reply to a question whether he had seen or heard of one Joseph, said to have been present at the crucifixion to be preserved in the world as a witness of that event. It would appear, therefore, that there was already in existence a legend of an undying Jew, although nothing was intimated of his insult to Christ. The idea of wandering did not enter into the legend until a later period, when persons pretending to be the undying Jew appeared in various parts of Europe. Near the middle of the 16th century the legend appears in Germany, brought there by a man who professed to be the "Ewige Jude" himself. He appeared at Hamburg, in 1547, giving his name as Ahasuerus, and stating that he had been a shoemaker in Jerusalem who would not suffer Christ to rest at his door when fainting under the weight of the cross. He struck Jesus, and bade him move on. Jesus said, "I will stand here and rest, but thou shalt go on until the last day." This story, however, also rests upon the authority of an irresponsible reporter. It is attributed to Dr Paulus von Eizen, bishop of Schleswig, whose long conversations with Ahasuerus are given, in a work by one Chrysostomus Dudulaeus Westphalus,—probably a pseudonym. This was published some years after the death of Paulus von Eizen, which occurred in 1598, and its aim is to make the story as sensational as possible as a "warning." This earliest known book on the legend, published at Leipsic, 1602, professes to be derived from a previous one:—*Strange Report of a Jew born at Jerusalem, who pretends he was present at the crucifixion of Christ; newly printed at Leyden*. Other small works appeared somewhat later, as at "Augsburg, 1619," and elsewhere, and were continued throughout the 17th century, these containing rumours of the Jew's appearance in Hamburg, Dantzic, Naumburg, Lübeck, Brussels, Moscow, and Madrid. Rudolph Botoreus, parliamentary advocate of Paris (*Comm. histor.*, 1604), mentions contemptuously the rumours of the appearance of this Jew in Germany, Spain, and Italy, and the popular credulity. The most important account of any of these monomaniacs or pretenders is that given of one in Paris (1644) by *The Turkish Spy* (book iii., letter i.). "One day I had the curiosity to discourse with him in several languages; and I found him master of all those I could speak. I conversed with him five or six hours together in Arabic." "The common people are ready to adore him; and the very fear of the multitude restrains the magistrates from offering any violence to this impostor." From a letter of Madame de Mazarin to Madame de Bouillon, it appears that an individual appeared in England in the beginning of the 18th century professing to have been an officer of rank in Jerusalem who for an insult given to Jesus was doomed to live and wander. It is said that the universities sent professors to cross-examine him, and that many were satisfied of the truth of his story. Several pretenders of the kind appeared in England in the last century. Brand remembered to have seen one going about the streets of Newcastle muttering "Poor John alone." It is difficult, however, to discover whether in all these cases the rôle of the Wandering Jew was assumed or was added to aged beggars by popular credulity.

The names given to these wanderers are various. Cartaphilus is probably *κάρτα φίλος*, the "much beloved,"



in allusion to St John, who was believed to "tarry" until the coming of Christ. Joseph was perhaps caught from the legend of Joseph of Arimathea, who was said to have wandered into Britain in the year 63, when his flowering staff indicated the spot where Glastonbury abbey should be built. *The Turkish Spy* in Paris gives his name as Michob Ader; Libavins (*Praxis Alchymix*) as Butadæus. In Brussels he was called Isaac Laquedem, a name believed by Grasse to be the French *la* combined with *kedem*, Heb. for "aforetime." Mr Karl Blind has suggested that his name in Germany, Ahasuerus, may have been formed out of a corruption of As-Vidar, "god Vidar,"—the Teutonic deity who was to survive the destruction of the world and conquer the wolf Fenris by thrusting his foot covered with an enormous shoe down the monster's throat (*Gentleman's Magazine*, July 1880). This ingenious suggestion would account for the transformation of the wanderer between 1228, when the Armenian bishop described him as Pilate's doorkeeper, and 1547, when he claims to have been a shoemaker. For a long time there were kept at Bern and also at Ulm enormous pairs of shoes said to have been left by the Wandering Jew on his visits to those places.

The legend of the Wandering Jew seems clearly related to a class of myths, found in every part of the world, in which certain saints or heroes are represented as having never died. Many of these myths,—as those of King Arthur, Charlemagne, Barbarossa, Tell,—are no doubt ethnically connected; but the corresponding myths found among the Incas, and among various American tribes, may lead us to seek for a common root of them all in human nature,—in the unwillingness of men to believe that their heroes can be really dead. In a primitive race, which had not yet conceived the idea of animistic immortality, the notion of a continued existence in happy isles, valleys, or grottoes, would naturally arise. The earliest instance of this earthly immortality would appear to be that of the Persian Yima, king of the Golden Age, who, in the Zend-Avesta, "gathers around him men and animals in flocks, and fills the earth with them, and after the evils of winter had come over his territories leads a select number of the beings of the good creation to a secluded spot, where they enjoy uninterrupted happiness" (*Haug's Essays*, &c., p. 277). In a corresponding phase of development the Semitic races ascribed a similar terrestrial immortality to Enoch, Elijah, and some others. The Arabs have very particular accounts of the secret abodes of these; and there are indications that in Eastern folklore Moses was believed to be sleeping in his unknown sepulchre.

By the action of religious dualism on this belief there arose evil counterparts of the immortal heroes, who instead of dwelling in blissful retreats were doomed to wander without finding even the repose of the grave. Of this class Cain was the most conspicuous, and the Bedouin still feels his presence in the feverish desert-winds (Cain-winds), as the Picardy peasant says of a destructive gale, *C'est le juif errant qui passe*. Esau, Ishmael, and others have been evil wanderers in the superstitions of various localities; but there is one tradition of high antiquity which would appear to have especially prepared the way for our legend. It is related by G. Weil (*The Bible, the Koran, and the Talmud*, p. 127) that, according to this tradition, the golden calf was made by Al Samiri. Moses was about to put this man to death when Allah declared he should be banished. "Ever since that time he (Samiri) roams like a wild beast throughout the world; every one shuns him, and purifies the ground on which his feet have stood; and he himself, whenever he approaches men, exclaims, Touch me not!" There also arose a belief that this monster dwelt with his progeny on a rocky island in the Arabian

Gulf. from which emanated the plague (Sale, *Koran*, xx.).

These traditions were inherited by the folklore of Christendom. The mantle of Enoch and Elijah, and other saintly sleepers, fell upon the seven supposed to be slumbering in a cave near Ephesus, near to the slumbering St John, belief in whose earthly immortality is mentioned in the New Testament (John xxi. 23). On the other hand, the mantle of Cain and other evil wanderers would seem to have fallen on Nero, who for some time after his death was believed by friend and foe to be still living. At a later period, after Rome had been Christianized, the idea of a perpetual enemy of the Messiah was temporarily detached from any one man and personified as Antichrist,—a restless invisible spirit appointed by the adversary to resist the rival kingdom. This more abstract conception was prolific of evil wanderers. When, in course of the diffusion of Christianity throughout Europe, its missionaries came in contact with popular beliefs in deities which in many cases had been developed from traditional heroes and warriors,—such as Odin, Waldemar, Vidar,—these imaginary potentates were degraded into phantoms, demons; the brand of Cain was set on their names by solemn anathema, and thenceforth all regions of space had their doomed wanderers,—the Wild Huntsman in the air, the Flying Dutchman on the sea, and various forest phantasms like the Gros Veneur of Fontainebleau and Diedrich of Bern on the earth. The Jewish race, however, was the one race which did not yield to Christianity; its special identification with Antichrist was therefore inevitable. Many superstitions affecting them had long been accumulating. There was a belief that the seven whistlers—plovers or sometimes wild geese—were Jews that had been transformed because they had assisted in the crucifixion of Christ, and to see or hear those birds was regarded as ominous of disaster. The Witch Sabbaths were so called because the Jews were supposed to assemble at them. Their wealth was believed to be obtained from Satan. There was also a belief that they carried about plagues. This idea may partly have been derived from the tradition of Samiri and his island, already mentioned, but possibly derived some confirmation from the actual results of crowding the Jews into the confined and neglected quarters of cities, in disregard of sanitary laws. From innumerable sources like these gathered the cloud of fanaticism which sent its thunderbolts upon the Jewish people. The legend of the Wandering Jew, when it was pieced together, represented precisely the popular belief that this race, having betrayed its supernatural mission, had received a supernatural doom. The legendary figure was invested with the fatal associations of most of the demons which Christianity had degraded. He passed in the storm, presided at orgies, diffused diseases, instigated revolutions, burned cities. He was not only associated with European demons but with those of the Jewish race also. There was a wild fable about Judas,—that he had fulfilled a fearful dream of his mother before his birth, living, despite her throwing him into the sea, to "kill his father and sell his God,"—which reappears in our legend. Judas was said to have become page to Pilate, as Cartaphilus was his doorkeeper. Death refused to touch Judas until his doom had been fulfilled, as it spared the Wandering Jew. In the familiar legend of the discovery of the True Cross, the Jew who, after torture, points out its place of concealment to Helena is named Judas; and M. Magnin has plausibly suggested that the story of the Wandering Jew grew up in connexion with the True Cross legend. As Cain was a prototype of Judas, so was Judas of such doomed wanderers as Malchus in Italy and Ahasuerus in Germany. M. Gaston Paris believes the legend of

Malchus to be the earlier. He was said to have struck Jesus with an iron bar, and to have been condemned to walk until judgment-day around a subterranean column, against which he often dashes his head in the vain hope of death.

The respect shown by peasants to persons pretending to be the Wandering Jew was such as might have been expected for Cain with a mark upon his brow defending him from the hand of man. Such a mark was indeed supposed to be on the Wandering Jew's forehead. Xenola says it was a red cross concealed by a black bandage, on which account the Inquisition vainly tried to find him. While persecuting actual Jews, the peasantry had some compassion for this imaginary one, and in some parts of Germany two harrows were sometimes left in the field, set up together with teeth downward, it being believed that so the wanderer might obtain a night's rest.

The Wandering Jew has been a favourite subject of poetry and romance. Goethe (*Dichtung und Wahrheit*, xv.) has given the scheme of a dramatic poem on the theme which he had contemplated. It has been dealt with by C. F. D. Schubart, *Der ewige Jude*, 1787; A. W. Schlegel, *Warnung*, 1811; Aloys Schreiber, *Der ewige Jude*, 1807; W. Müller, *Wanderliedern*, 1830; Edgar Quinet, *Ahasuerus*, 1833; Chamisso, *Neuer Ahasuer*, 1836; F. Hauntral, *Ahasuerus*, 1838; Julius Mosen, *Ahasuer*, 1838; Ludwig Kohler, *Der neue Ahasuer*, 1841; Nicolas Lenau, *Ahasuer*, 1843. H. C. Andersen, *Ahasuerus*, 1847; E. Grenier, *La mort du Juif-Errant*, 1857. Béranger (1831) and Wordsworth have written lyrical poems on the subject. Shelley evokes the Wandering Jew six times, notably in his *Queen Mab*. In 1812 a comedy based on the legend by Craignez was performed in Paris. Klingemann's tragedy *Ahasuerus* (1827) was successful as a play. Eugene Sue's romance (1844), which stimulated popular interest in the legend, has also been often acted. Several German novels have been founded on the legend, the most important being those of Franz Horn, Th. Oelekers, and F. Laun. In England, where the legend had been made familiar by the ballad in *Perey's Reliques*, there was acted at Drury Lane, in 1797, a comedy by Andrew Franklin, entitled *The Wandering Jew*, or *Lord's Misprudence*. George Croly's novel *Salathiel* is on this subject. See Dr J. G. Th. Grässe, *Die Sage vom Ewigen Juden, historisch entwickelt*, &c., Dresd. and Leipsic, 1844; Herzog's *Real-Encyclopädie*; Friedrich Helbig, *Die Sage vom "Ewigen Juden," ihre praktische Wandlung und Fortbildung*, Berlin, 1874; C. Schoebel, *La légende du Juif-Errant*, Paris, 1877; Gaston Paris, *Le Juif-Errant*, Paris, 1880. (M. D. C.)

JEWEL, or JEWELL, JOHN (1522-1571), bishop of Salisbury, was born May 24th 1522, at Berry Narbor, near Ilfracombe, Devonshire. At the age of thirteen he entered Merton College, Oxford, where he had for tutor John Parkhurst, afterwards bishop of Norwich, from whom his mind received a bias towards Protestantism. Becoming tutor in Corpus Christi College in 1539, he in his turn took the opportunity of inculcating Protestant principles on his pupils; and in 1546 he received an allowance from a private fund instituted for the benefit of indigent scholars who publicly professed the doctrines of the Reformed faith. After the accession of Mary in 1553 he was expelled by the fellows from the college on account of his opinions, and in a moment of weakness he was induced to sign his adherence to a form of doctrine essentially Romanistic. He, however, speedily repented of his momentary faithlessness to his convictions, and in order to escape the penalties of martyrdom he fled in 1555 to Frankfort, where he publicly abjured his former recantation. On the death of Mary he returned to England. He was one of the learned Protestant doctors appointed to dispute before Elizabeth at Westminster with a like number of Catholics. In the beginning of 1560 he was created bishop of Salisbury, and in the same year he published, with the sanction of the queen and bishops, his *Apologia Ecclesie Anglicanae*, which was in fact an argument against the decision of the pope to exclude the Reformers, from the council of Trent, convoked to be held in December of that year. The work, as was to be expected, excited very great

attention at the time; it was condemned at the meeting of the council, who appointed two divines to reply to its arguments. It was translated into English by Anna, wife of Sir Nicholas Bacon, and Elizabeth ordered that a copy of it should be chained in every parish church in England. Its chief English opponent was Thomas Harding, who in 1565 published a *Confutation of the Apology*, to which Jewel replied in 1567 by the *Defence of the Apology*. The general argument of Jewel is that unity or predominance of opinion is not a test of truth, and, although he denied that Rome had the support of the fathers, he rested his general case on the fact that the foundation on which the Church of England was built was not that of the fathers but of the apostles and Jesus Christ. His views were strongly anti-sacramental, as he held that the Lord's Supper had nothing more than a commemorative use. Jewel died suddenly at Monkton Farleigh, a small village in his diocese, September 22, 1571.

*Joannis Juelli vita et mors*, T. Humphredo autore, was published at London in 1573. The *Apology*, translated with notes and life by Isaacson, appeared in 1823, and the other biographies of Jewel are one by Le Bas in the Theological Library, 1835, and a short sketch published by the Society for the Promotion of Christian Knowledge, 1850. His works, which are mostly controversial, were collected by Dr R. W. Jelf, and published in 8 vols. at Oxford, 1848.

JEWELLERY (Latin, *gaudium*; French, *jewel*, *joyau*). Plates Personal ornaments appear to have been among the very XI, XII first objects on which the invention and ingenuity of man were exercised; and there is no record of any people so rude as not to employ some kind of personal decoration. Natural objects, such as small shells, dried berries, small perforated stones, feathers of variegated colours, were combined by stringing or tying together to ornament the head, neck, arms, and legs, the fingers, and even the toes, whilst the cartilages of the nose and ears were frequently perforated for the more ready suspension of suitable ornaments.

Amongst modern Oriental nations we find almost every kind of personal decoration, from the simple caste mark on the forehead of the Hindu to the gorgeous examples of beaten gold and silver work of the various cities and provinces of India. Nor are such decorations mere ornaments without use or meaning. The hook with its corresponding perforation or eye, the clasp, the buckle, the button, grew step by step into a special ornament, according to the rank, means, taste, and wants of the wearer, or became an evidence of the dignity of office. That these ornaments were considered to have some representative purpose even after death is abundantly proved; for it is in truth to the tombs of the various ancient peoples that we must look for evidence of the early existence of the jeweller's art.

That the Assyrians used personal decorations of a very distinct character, and possibly made of precious materials, is proved by the bas reliefs. In the British Museum we have a representation of Samsi Vul IV., king of Assyria (825 B.C.). He wears a cross (Plate XI. fig. 1) very similar to the Maltese cross of modern times. The still more ancient Egyptian jewellery is distinctly brought before us by the objects themselves, placed with the embalmed bodies of the former wearers in sarcophagi, only to be opened in our own time. The most remarkable collection of Egyptian art in this direction is to be found in the jewellery taken from the coffin of Queen Aah-hotep, discovered by M. Mariette in the entrance to the valley of the Tombs of the Kings in 1859, and now preserved in the Bulak museum. In these objects we find the same ingenuity and perfect mastery of the materials as characterize the monumental work of the Egyptians. Hammered work, incised and chased work, the evidence of soldering, the combination of layers of gold plates, together with coloured stones, are all there,—the handicraft being complete in every respect.



A diadem of gold and enamel, found at the back of the head of the mummy of the queen (fig. 2), was fixed in the back hair, showing the cartouche in front. The box holding this cartouche has on the upper surface the titles of the king, "the son of the sun, Aahmes, living for ever and ever," in gold on a ground of lapis lazuli, with a chequered ornament in blue and red pastes, and a sphinx couchant on each side. A necklace of the order or decoration of the Fly (fig. 3) is entirely of gold, having a hook and loop to fasten it round the neck. A small porcelain cylinder (fig. 4) is ornamented with interlaced lotus flowers in intaglio, having a ring for suspension, and fig. 5 is a gold drop, inlaid with turquoise or blue paste, in the shape of a fig. A gold chain (fig. 7) is formed of wires closely plaited and very flexible, the ends terminating in the heads of water fowl, and having small rings to secure the collar behind. To the centre is suspended by a small ring a scarabeus of solid gold inlaid with lapis lazuli. These scarabei were in constant use in Egyptian ornaments, and were worn in rings by the military caste. We have an example of a bracelet, similar to those in modern use (fig. 6), and worn by all persons of rank. It is formed of two pieces joined by a hinge, and is decorated with figures in repoussé with a ground inlaid with lapis lazuli. A signet ring (fig. 8) has a square revolving bezel on which are four serpents interlaced.

The discoveries of Dr Schliemann at Mycenæ and at Hissarlik, the assumed site of ancient Troy, supply further illustrations of ancient jewellery and gold work. In extent and in the wonderful character of the design and workmanship, the relics found at Mycenæ present the most perfect examples, although some of the objects brought from the "burnt city" at Hissarlik give evidence of singular skill and ingenuity in the methods of combining the various portions of an ornament and finesse in working the gold. From Mycenæ the objects ranged over most of the personal ornaments still in use: necklaces with gold beads and pendants, butterflies (fig. 16), cuttlefish (fig. 10), single and concentric circles, rosettes, and leafage, with perforations for attachment to clothing, crosses (fig. 9), and stars formed of combined crosses, with crosses in the centre forming spikes,—all elaborately ornamented in detail. The spiral forms an incessant decoration from its facile production and repetition by means of twisted gold wire. Grasshoppers or tree crickets in gold repoussé suspended by chains and probably used for the decoration of the hair, and a griffin (fig. 17), having the upper part of the body of an eagle and the lower parts of a lion, with wings decorated with spirals, are among the more remarkable examples of perforated ornaments for attachment to the clothing. There are also perforated ornaments belonging to necklaces, with intaglio engravings of such subjects as Hercules and the Nemean lion, and a duel of two warriors, possibly Hector and Achilles, one of whom stabs his antagonist in the throat. Another has a representation of a lion, very archaic in treatment, the style resembling that of the fore part of the lion found on the statue of Sardis, attributed to Croesus, 560 B.C. There are also pinheads and brooches formed of two stags lying down (fig. 15), the bodies and necks crossing each other, and the horns meeting symmetrically above the heads, forming a finial. The heads of these ornaments were of gold, with silver blades or pointed pins inserted for use. The bodies of the two stags rest on fronds of the date-palm growing out of the stem which receives the pin. Another remarkable series is composed of figures of women with doves (fig. 20). Some have one dove resting on the head; others have three doves, one on the head and the others resting on arms. The arms in both instances are extended to the elbow, the hands being

placed on the breasts. These ornaments are also perforated, and were evidently sewed on the dresses, although there is some evidence that an example with three doves has been fastened with a pin.

Mention must be made of an extraordinary diadem found upon the head of one of the bodies discovered in the same tomb with many objects similar to those noticed above. It is 25 inches in length, covered with shield-like or rosette ornaments in repoussé, the relief being very low but perfectly distinct, and further ornamented by thirty-six large leaves of repoussé gold attached to it. As an example of design and perfection of detail, another smaller diadem found in another tomb may be noted (fig. 11). It is of gold plate, so thick as to require no "piping" at the back to sustain it; but in general the repoussé examples have a piping of copper wire. Diadems of similar form are found on statues of Aphrodite, and also on statuettes of Hercules in ivory, in the Assyrian collection at the British Museum. Fig. 13 represents a remarkably elegant pendant ornament, the design being of an exceptionally beautiful character. A cross of thin gold work formed of four leaves (fig. 18), a finial-like ornament (fig. 19), and the head of a pin or brooch evidently suggested by a butterfly (fig. 14), are all characteristic of the gold work of Mycenæ.

The gold ornaments found at Hissarlik, in what Dr Schliemann calls the "Treasury of Priam," partake in most instances of the same characteristics as those found in the sepulchres at Mycenæ. There are necklaces, brooches, bracelets (fig. 29), hair-pins (fig. 23), earrings (figs. 21, 22, 25, 26, 27, 28), with and without pendants, beads, and twisted wire drops. The majority of these are ornamented with spirals of twisted wire, or small rosettes, with fragments of stones in the centres. The twisted wire ornaments were evidently portions of necklaces. A circular plaque decorated with a rosette (fig. 30) is very similar to those found at Mycenæ, and a conventionalized eagle (fig. 31) is characteristic of much of the detail found at that place as well as at Hissarlik. They were all of pure gold, and the wire must have been drawn through a plate of harder metal—probably bronze. The principal ornaments differing from those found at Mycenæ are diadems or head fillets of pure hammered gold (fig. 24) cut into thin plates, attached to rings by double gold wires, and fastened together at the back with thin twisted wire. To these pendants (of which those at the two ends are nearly three times the length of those forming the central portions) are attached small figures, probably of idols. It has been assumed that these were worn across the forehead by women, the long pendants falling on each side of the face. If, however, the position on which they were found was formerly part of a temple instead of a palace, it may be suggested that they were used as veils for the priests when giving forth the oracles from the shrine.

Jewellery and gold work of a very similar character has been found at Cyprus within the last few years by Major Cesnola. The rings (Plate XII figs. 5 and 6) have a great resemblance to the Greek, whilst the beetle, which is of green stone set in gold (fig. 6), has a very Egyptian-like appearance. The great similarity in design and workmanship between these Eastern examples and the gold jewellery and personal ornaments found in Peru and Mexico (figs. 1, 2, 3, 4) is not a little remarkable. These, however, are more rude in design, though equally good in workmanship.

Greek, Etruscan, and Roman ornaments partake of very similar characteristics. Of course there is variety in design and sometimes in treatment, but it does not rise to any special individuality. A fretwork is a distinguishing feature of all, together with the wave ornament, the





ASSYRIAN

EGYPTIAN

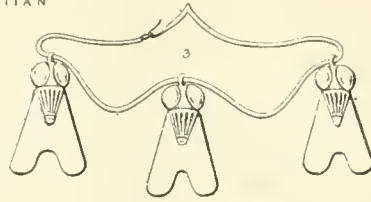
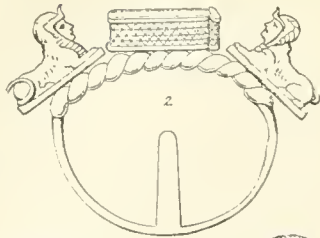
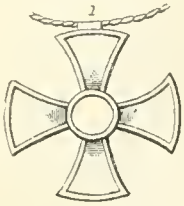

MYCENÆAN

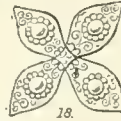
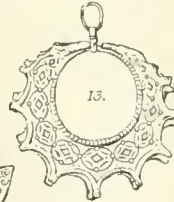
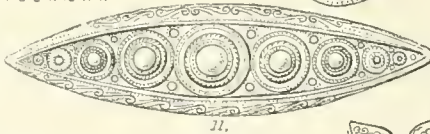

TROJAN

ROJAN

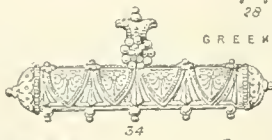
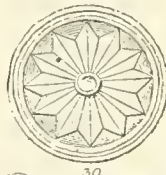
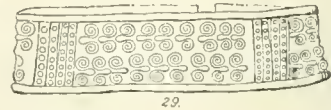
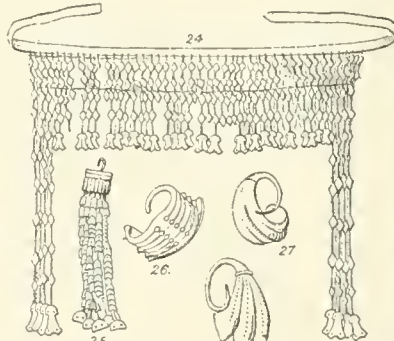

ETRUSCAN

ETRUSCAN

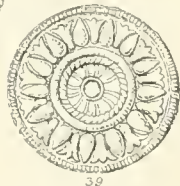

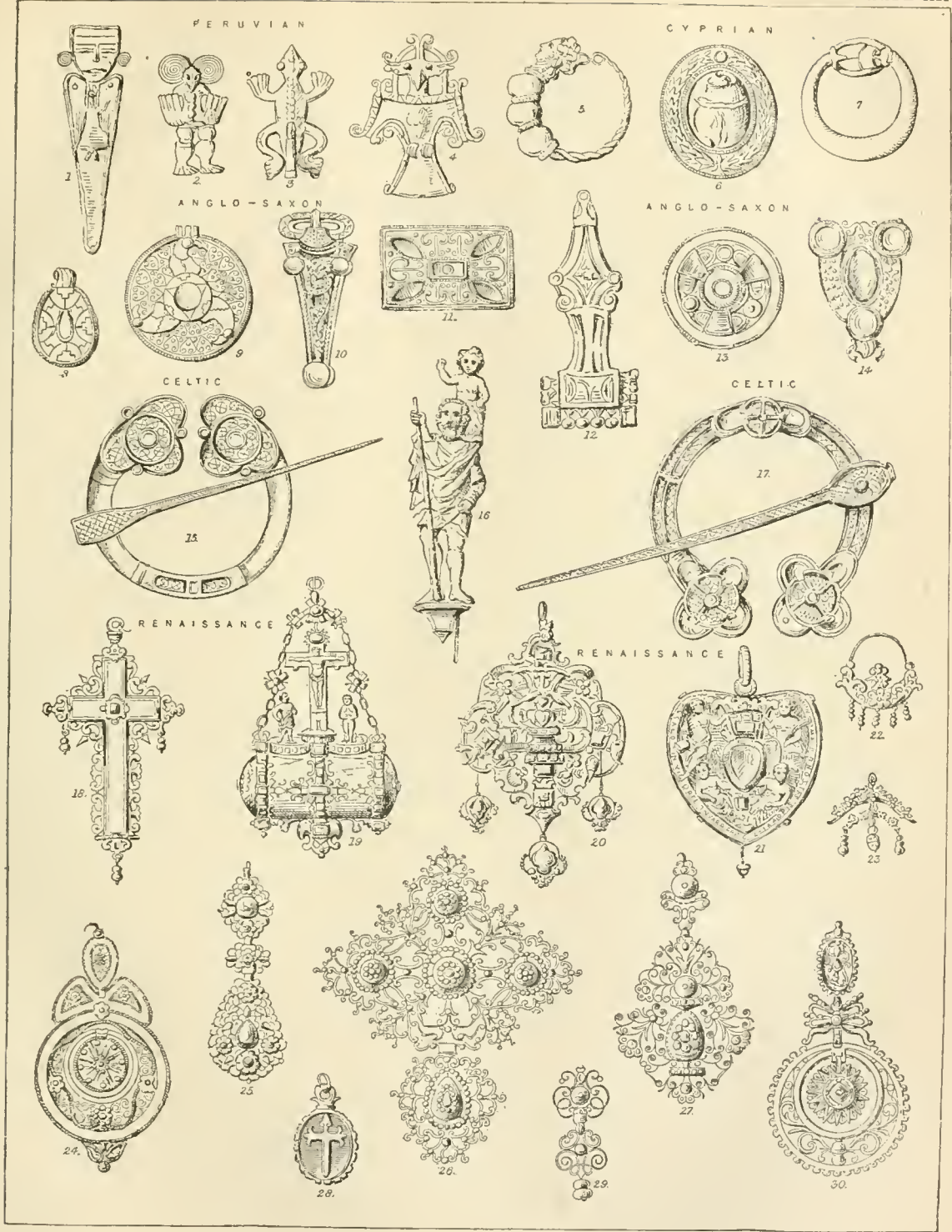





goldsmiths, and the occasional use of the human figure. The workmanship is often of a character which modern gold workers can only rival with their best skill, and can never surpass. The pendant oblong ornament for containing a scroll (Plate XI. fig. 34) is an example of this, as also the Italo-Greek earring (fig. 32). The earring (fig. 36) is an exquisite illustration of Greek skill in the introduction of the human figure; the rosette for concealing the hook and the winged ornament at the back of the Cupid are beautifully wrought. The other earrings (figs. 33, 35, 37) are all characteristic. The Etruscan examples are of the same character. The pendant (fig. 40), the rosette (fig. 38), and the plaque of gold (fig. 38) repeat some of the forms found at Mycenæ, with possibly a little more classic grace of detail and refinement of workmanship. The brooch (fig. 41) is perhaps the most characteristic example of purely classic design, essentially Greek in its principal details, whilst the workmanship is all that can be desired.

The granulation of surfaces practised by the Etruscans was long a puzzle and a problem to the modern jeweller, until Signor Castellani of Rome discovered gold workers in the Abruzzi to whom the method had descended through many generations, and, by inducing some of these men to go to Naples, revived the art, of which he contributed examples to the London Exhibition of 1872, successfully applied to modern designs.

The Merovingian jewellery of the 5th century, the Anglo-Saxon of a later date, and the Celtic as leading to the Gothic or mediæval, have each distinguishing features. In the first two the characteristics are thin plates of gold, decorated with thin slabs of garnet, set in walls of gold soldered vertically like the lines of cloisonné enamel, with the addition of very decorative details of filigree work, beading, and twisted gold. In Plate XII. figs. 9 and 13 we have examples of Anglo-Saxon fibule, the first being decorated with a species of cloisonné, in which garnets are inserted, while the other is in hammered work in relief. A pendant (fig. 8) is also set with garnets. The buckles (figs. 10, 11, 12) are remarkably characteristic examples, and very elegant in design. A girdle ornament in gold, set with garnets (fig. 14), is an example of Carolingian design of a high class. The Celtic ornaments are of hammered work, adapted to uses now comparatively unknown, but display another style of workmanship,—details in reponssé, fillings in with amber, rock crystal with a smooth rounded surface cut *en cabochon*, with the addition of vitreous pastes. The minute filigree and plaited work, in combination with niello and enamel, communicate to the ornaments of this class found in Ireland and Scotland an unmistakable Oriental spirit alike in design and workmanship.

In figs. 15 and 17 are illustrations of two brooches. The first is 13th century; the latter is probably 12th century, and is set with paste, amber, and blue. The brooch in the form of a figure of St Christopher bearing the infant Saviour, and supported by his staff (fig. 16), is of silver gilt. Chancer mentions such a brooch as worn by the yeoman:—"A Cristofre on his brest of silvyr schene."

Rings are the chief specimens now seen of mediæval jewellery from the 10th to the 13th century. They are generally massive and simple. Through the 16th century a variety of changes arose; in the traditions and designs of the *Cinquecento* we have plenty of evidence that the workmen used their own designs, and the results culminated in the triumphs of Albert Dürer, Benvenuto Cellini, and Hans Holbein. The goldsmiths of the Italian republics must have produced works of surpassing excellence in workmanship, and reaching the highest point in design as applied to handicrafts of any kind. The use of enamels,

precious stones, niello work, and engraving, in combination with skilful execution of the human figure and animal life, produced effects which modern art in this direction is not likely to approach, still less to rival.

In Plate XII. illustrations are given of various characteristic specimens of the Renaissance, and later forms of jewellery. A crystal cross set in enamelled gold (fig. 18) is German work of the 16th century. The pendant reliquary (fig. 19), enamelled and jewelled, is of 16th century Italian work, and so probably is the jewel (fig. 20) of gold set with diamonds and rubies.

The Darnley or Lenox jewel (fig. 21), now in the possession of the Queen, was made about 1576-7 for Lady Margaret Douglas, countess of Lenox, the mother of Henry Darnley. It is a pendant golden heart set with a heart-shaped sapphire, richly jewelled and enamelled with emblematic figures and devices. It also has Scottish mottoes around and within it. The earring (fig. 22) of gold, enamelled, hung with small pearls, is an example of 17th century Russian work, and another (fig. 23) is Italian of the same period, being of gold and filigree with enamel, also with pendant pearls. A Spanish earring, of 18th century work (fig. 24), is a combination of ribbon, cord, and filigree in gold; and another (fig. 25) is Flemish, of probably the same period; it is of gold open work set with diamonds in projecting collets. The old French-Normandy pendant cross and locket (fig. 26) presents a characteristic example of peasant jewellery; it is of branched open work set with bosses and ridged ornaments of crystal. The earring (fig. 27) is French of 17th century, also of gold open work set with crystals. A small pendant locket (fig. 28) is of rock crystal, with the cross of Santiago in gold and translucent crimson enamel; it is 16th or 17th century Spanish work. A pretty earring of gold open scroll work (fig. 29), set with minute diamonds and three pendant pearls, is Portuguese of 17th century, and another earring (fig. 30) of gold circular open work, set also with minute diamonds, is Portuguese work of 18th century. These examples fairly illustrate the general features of the most characteristic jewellery of the dates quoted.

During the 17th and 18th centuries we see only a mechanical kind of excellence, the results of the mere tradition of the workshop,—the lingering of the power which when wisely directed had done so much and so well, but now simply living on traditional forms, often combined in a most incongruous fashion. Gorgeous effects were aimed at by massing the gold, and introducing stones elaborately cut in themselves, or clustered in groups. Thus diamonds were clustered in rosettes and bouquets; rubies, pearls, emeralds, and other colored special stones were brought together for little other purpose than to get them into a given space in conjunction with a certain quantity of gold. The question was not of design in its relation to use as personal decoration, but of the value which could be got into a given space to produce the most striking effect.

The traditions of Oriental design as they had come down through the various periods quoted, were comparatively lost in the wretched results of the *rococo* of Louis XIV. and the inanities of what modern revivalists of the Anglo-Dutch call "Queen Anne." In the London Exhibition of 1851, the extravagances of modern jewellery had to stand a comparison with the Oriental examples contributed from India. Since then we have learnt more about these works, and have been compelled to acknowledge, in spite of what is sometimes called inferiority of workmanship, how completely the Oriental jeweller understood his work, and with what singular simplicity of method he carried it out. The combinations are always



harmonious, the result aimed at always achieved; and, if in attempting to work to European ideas the jeweller failed, this was rather the fault of the forms he had to follow, than due to any want of skill in making the most of a subject in which half the thought and the intended use were foreign to his experience.

A collection of peasant jewellery got together by Castellani for the Paris Exhibition of 1867, and now in the South Kensington Museum, illustrates in an admirable manner the traditional jewellery and personal ornaments of a wide range of peoples in Europe. This collection, and the additions made to it since its acquisition by the nation, show the forms in which these objects existed over several generations among the peasantry of France (chiefly Normandy), Spain, Portugal, Holland, Denmark, Germany, and Switzerland, and also show how the forms popular in one country are followed and adopted in another, almost invariably because of their perfect adaptation to the purpose for which they were designed.

So far we have gone over the progress and results of the jeweller's art in the past. We have now to speak of the production of jewellery as a modern art industry, in which large numbers of men and women are employed in the larger cities of Europe, but which also has its special localities in which it flourishes, and out of which an important national commerce arises.

Nearly all the great capitals of Europe produce jewellery, but Paris, Vienna, London, and Birmingham are the most important centres. An illustration of methods and processes and the various kinds of jewellery produced at the present day in the manufacture as carried on in London and Birmingham will be sufficient for all practical purposes, and as giving an insight into the technique and artistic manipulation of this branch of art industry; but, by way of contrast, it may be interesting to give in the first place a description of the native working jeweller of Hindustan. Travelling very much after the fashion of a tinker in England, his "budget" contains tools, materials, fire pots, and all the requisites of his handicraft. The gold to be used is generally supplied by the patron or employer, and is frequently in gold coin, which the travelling jeweller undertakes to convert into the ornaments required. He squats down in the corner of a courtyard, or under cover of a veranda, lights his fire, cuts up the gold pieces entrusted to him, hammers, cuts, shapes, drills, solders with the blow-pipe, files, scrapes, and burnishes until he has produced the desired effect. If he has stones to set or coloured enamels to introduce, he never seems to make a mistake; his instinct for harmony of colour, like that of his brother craftsman the weaver, is as unerring as that of the bird in the construction of its nest. Whether the materials are common or rich and rare, he invariably does the very best possible with them, according to native ideas of beauty in design and combination. It is only when he is interfered with by European dictation that he ever vulgarizes his art or makes a mistake. The result may appear rude in its finish, but the design and the thought are invariably right. We thus see how a trade in the working of which the "plant" is so simple and wants are so readily met could spread itself, as in years past it did at Clerkenwell and at Birmingham, before gigantic factories were invented for producing everything under the sun.

It is impossible to find any date at which the systematic production of jewellery was introduced into England. Probably the Clerkenwell trade dates its origin from the revocation of the Edict of Nantes, as the skilled artisans in the jewellery, clock and watch, and trinket trades appear to have been descendants of the emigrant Huguenots, as the Spitalfields weavers were. The Birmingham trade

would appear to have had its origin in the skill to which the workers in fine steel had attained towards the middle and end of last century, a branch of industry which collapsed after the French Revolution.

Modern jewellery may be classified under three heads:—(1) objects in which gems and stones form the principal portions, and in which the gold work is really only a means for carrying out the design by fixing the gems or stones in the position arranged by the designer, the gold being visible only as a "setting"; (2) when gold work plays an important part in the development of the design, being itself ornamented by engraving or enamelling or both, the stones and gems being arranged in subordination to the gold work in such positions as to give a decorative effect to the whole; (3) when gold or other metal is alone used, the design being wrought out by hammering in repoussé, casting, engraving, or chasing, or the surfaces left absolutely plain but polished and highly finished.

Of course the most ancient and primitive methods are those wholly dependent upon the craft of the workman; but gradually various ingenious processes were invented, by which greater accuracy in the portions to be repeated in a design could be produced with certainty and economy: hence the various methods of stamping used in the production of hand-made jewellery, which are in themselves as much mechanical in relation to the end in view as if the whole object were stamped out at a blow, twisted into its proper position as regards the detail, or the various stamped portions fitted into each other for the mechanical completion of the work. It is therefore rather difficult to draw an absolute line between hand-made and machine-made jewellery, except in extreme cases of hand-made, when everything is worked, so to speak, from the solid, or of machine-made, when the hand has only to give the ornament a few touches of a tool, or fit the parts together if of more than one piece.

The best and most costly hand-made jewellery produced in England, whether as regards gold work, gems, enamelling, or engraving, is made in London, and chiefly at Clerkenwell. A design is first made on paper, or drawn and coloured, and when needful with separate enlargement of details, everything in short to make the drawing thoroughly intelligible to the working jeweller. According to the nature and purpose of the design, he cuts out, hammers, files, and brings into shape the constructive portions of the work as a basis. Upon this, as each detail is wrought out, he solders, or fixes by rivets, &c., the ornamentation necessary to the effect. The human figure, representations of animal life, leaves, fruit, &c., are modelled in wax, moulded, and cast in gold, to be chased up and finished. As the hammering goes on the metal becomes brittle and hard, and then it is passed through the fire to anneal or soften it, in fact to restore the particles of gold to their original position. In the case of elaborate examples of repoussé, after the general forms are beaten up, the interior is filled with a resinous compound, pitch mixed with fire-brick dust; and this, forming a solid but pliable body underneath the metal, allows of the finished details being wrought out on the front of the design, and being finally completed by chasing. When stones are to be set, or when they form the principal portions of the design, the gold has to be wrought by hand so as to receive them in little cup-like orifices, these walls of gold enclosing the stone and allowing the edges to be bent over to secure it. Setting is never effected by cement in well-made jewellery. Machine-made settings have in recent years been made, but these are simply cheap imitations of the true hand-made setting. Even strips of gold have been used, serrated at the edges to allow of being easily bent over, for the retention of the stones, true or false.

Great skill and experience are necessary in the proper setting of stones and gems of high value, in order to bring out the greatest amount of brilliancy and colour, and the angle at which a diamond (say) shall be set, in order that the light shall penetrate at the proper point to bring out the "spark" or "flash," is a subject of grave consideration to the setter. Stones set in a haphazard, slovenly manner, however brilliant in themselves, will look commonplace by the side of skilfully set gems of much less fine quality and water. Enamelling has of late years largely taken the place of "paste" or false stones. This may be divided into two kinds—*champlevé* and *cloisonné*. In *champlevé* the enamelling substance is applied to the surface of the gold as ornamental details, and is "fired" in a muffle or furnace under the eye of the enameller. Here the metallic oxides play an important part in imparting variety of colour, as in the case of the "strass" of which "paste" or false stones are made. *Cloisonné* enamelling is effected by walls of gold wire being fastened to the surface to be decorated, upon which surface the design has been already drawn in outline. Within these walls or "cloisons" the various-coloured enamels are placed, and the whole fixed together by firing until the surface is more than filled up. The surface is levelled by grinding down with pumice stone, and then polished. One kind of *champlevé* closely approaches in its character to *cloisonné*. It is when the gold is thick enough to allow of portions to be cut away by the graver, and in these incised parts the coloured enamels are fused as in the manner of the true *cloisonné*.

Enamelled subjects or paintings, portraits, landscapes, animals' heads, &c., are sometimes used as a setting for pins, brooches, pendants, bracelets, &c. These are of course true *champlevé*; and formerly very able artists, such as Bone, Essex, and others, were employed in the production of costly works of this kind.

Engraving is a simple process in itself, and diversity of effect can be produced by skilful manipulation. An interesting variety in the effect of a single ornament is often produced by the combination of coloured gold of various tints. This colouring is a chemical process of great delicacy, and requires much skill and experience in the manipulation, according to the quality of the gold and the amount of silver alloy in it. Of general colouring it may be said that the object aimed at is to enhance the appearance of the gold by removing the particles of alloy on the surface, and thus allowing the pure gold only to remain visible to the eye.

The application of machinery to the economical production of certain classes of jewellery, not necessarily imitations, but as much "real gold" work, to use a trade phrase, as the best hand-made, has been on the increase for many years. Nearly every kind of gold chain now made is manufactured by machinery, and nothing like the beauty of design or perfection of workmanship could be obtained by hand at, probably, any cost. The question therefore in relation to chains is not the mode of manufacture, but the quality of the metal. Eighteen carat gold is of course always affected by those who wear chains, but this is only gold in the proportion of 18 to 24; pure gold being represented by 24. The gold coin of the realm is 22 carat; that is, it contains one-twelfth of alloy to harden it to stand wear and tear. Thus 18 carat gold has one-fourth of alloy, and so on with lower qualities down to 12, which is in reality only gold by courtesy.

The application of machinery to the production of personal ornaments in gold and silver can only be economically and successfully carried on when there is a large demand for similar objects, that is to say, objects of precisely the same design and decoration throughout. In

hand-made jewellery, so-called, mechanical appliances are only used to economize time and reduce the necessity for the handicraftsman doing that which can be done as well, perhaps better, by some simple mechanical method applied under the hand. In machine-made jewellery everything is stereotyped, so to speak, and the only work required for the hand is to fit the parts together,—in some instances scarcely that. A design is made, and from it steel dies are sunk for stamping out as rapidly as possible from a plate of rolled metal the portion represented by each die. It is in these steel dies that the skill of the artist die-sinker is manifested. Brooches, earrings, pinheads, bracelets, lockets, pendants, &c., are struck out by the gross. This is more especially the case in silver and in plated work,—that is, imitation jewellery,—the base of which is an alloy, afterwards gilt by the electro-plating process. With these ornaments imitation stones in paste and glass, pearls, &c., are used as setting, and it is remarkable that of late years some of the best designs, the most simple, appropriate, and artistic, have appeared in imitation jewellery. It is only just to those engaged in this manufacture to state distinctly that their work is never sold wholesale for anything else than what it is. The worker in gold only makes gold, or real jewellery, and he only makes of a quality well known to his customers. The producer of silver work only manufactures silver ornaments, and so on throughout the whole class of plated goods. It is the unprincipled retailer who, taking advantage of the ignorance of the buyer, sells for gold that which is in reality an imitation, and which he bought as such.

Space will not permit of any notice of various kinds of personal ornaments coming under the head of jewellery, such as the elegantly designed hand-made pearl ornaments, Whitby jet, coral, &c., nor can we allude to the methods adopted in the workshops where gold and silver alone are used to economize the metal that would be wasted without proper precautions. Even the minute quantities of the material which adhere to the hands of the workman are washed off before he leaves the premises, carried into a proper receptacle, and recovered by chemical agency.

The special localities of the jewellery trade proper, in England, are Clerkenwell and Pentonville in London, and Birmingham. In Clerkenwell an inquiry made some years ago showed that from 1600 to 2000 persons were employed in the trades connected with the production of jewellery and personal ornaments. In Birmingham at least 8000 were thus occupied, chiefly in production of what may be considered as purely mechanical work. Among the higher class of jewellers in Birmingham some of the best work sold in the London shops is produced, the mechanical means employed being so ingenious, and the handicraft power so skilfully applied in fitting, setting, and finishing, as to leave little or nothing to desire, when compared with hand-made work of the same class. (G. W.)

JEWELRY, MODERN. An outline of the mediæval history of the Jews is given in the article ISRAEL. The modern history of the race in its political and intellectual emancipation begins with Moses Mendelssohn, who flourished at Berlin in the latter part of the 18th century. The persecutions of the Middle Ages had produced their natural effect. Cut off from their fellow-citizens, excluded by oppressive laws from all trades except that of peddling in old clothes and even from buying certain classes of these, specially taxed, confined to Ghettos and Judengassen, strictly prohibited from entering some towns, limited in numbers in others, forbidden to marry except under restrictions designed to check the growth of the Jewish population, disabled from employing Christian servants or being members of trade guilds, the Jews seemed by their abject condition to deserve the evils which were its cause.



There were always, it is true, exceptions to the general degradation of the race. The exiles from the Spanish peninsula (who in western Europe were found chiefly in Amsterdam, Bordeaux, Paris, and London, and also in Hamburg and Copenhagen) were in many cases persons of distinguished culture and intelligence, having been enabled, while protected by their disguise of Christianity, to live a life more worthy of freemen than was that of their oppressed and pillaged brethren in the north. In Germany itself Frederick William, the great elector of Brandenburg (1640 to 1688), was indebted for zealous service to Gompertz and Solomon Elias. Beckman of Frankfurt-on-the-Oder obtained permission in 1696 to print the Talmud. In Austria Wolf Schlessinger was personally exempted from the decree which banished the Jews from Vienna in the time of Leopold I. The Oppenheimers had sufficient influence in Austria to prevent the publication there of Eisenmenger's libels on their race; the Arnsteins, Sinzheimers, and other families earned the favour of Maria Theresa, and were decorated with titles of nobility. But the general condition of the multitude was shown by the excommunication of Spinoza at Amsterdam, by the rise of the Chasidim and of Frank, and the marvellous history of Sabbathai Zebi. The German Jews grew distrustful of their knowledge of their own religion, and instructed their children by the aid of long-ringed rabbis from Poland, who overspread the country, inculcating contempt for all except the too subtle dialectics of their peculiar school of disputation. Led by these blind guides, the German Jews continued to speak their own jargon of Hebrew and German, to correspond and even endorse their commercial bills in Hebrew characters, and abandoned the hopeless attempt to enter into the general life of their country. Fortunately the hereditary desire of learning still survived, though the selection of subjects for study helped to isolate them from their happier neighbours. Moses Mendelssohn (1729-1786), who did so much to induce the Jews to become at one with the spirit of the age, and the Christians to tolerate them, was at three years old taught by his father, a professional copyist of Hebrew religious manuscripts, to repeat the wise sayings of the Talmud. Later on he found in the rabbi Fränkel, of his native town of Dessau in Anhalt, a capable and enlightened teacher. When Fränkel was promoted, the young Mendelssohn followed him, at the age of fourteen, to Berlin. In Prussia the condition of the Jews had been comparatively favoured. Forty or fifty respectable families fleeing from persecutions in Austria had been admitted to Berlin towards the end of the 17th century. The colony increased, and was specially patronized in his own grotesque and tyrannical fashion by the half-mad sovereign Frederick William I. Frederick the Great held the maxim that "to oppress the Jews never brought prosperity to any Government," but his "general privilege," issued in 1750, while it abolished some old restrictions, was only a halting step in advance. It divided the Jews into two classes,—the hereditarily and the personally tolerated. In the first were those who were actually engaged in commerce or who occupied some office in connexion with the synagogue. Their right of abode extended to merely one child of the family. Those who were personally tolerated were men who had means of independent subsistence, though not engaged in commerce, and their right did not descend to their children. The right to residence for a second child of each family of hereditary inhabitants was purchased by the Jews for 70,000 thalers. The restrictions imposed by Frederick on marriage were severe; poor Jews could not marry at all. No Jew was permitted to own land in fee or to possess more than forty houses. Their business was confined to trade in money or goods. — Frederick the Great,

penetrated as he was by the sentiments of Voltaire, yet struck out Mendelssohn's name when it was put forward for election into the Berlin Academy. Mendelssohn was with difficulty admitted into Berlin when he presented himself at its gates as a poor boy, having no friend but his teacher Fränkel. He went into a silk manufacturer's house as teacher to the children, and became a clerk and afterwards a partner in the firm. He formed a warm friendship with Lessing, and inspired the drama of *Nathan the Wise*, in which the Jew was for the first time in modern literature represented in a benevolent light. He translated the Pentateuch into German, and issued his translation in Hebrew characters, added to it a commentary in Hebrew (incorporating the rational as distinguished from the Agadistic interpretations of former Hebrew commentators), partly by himself and partly by others, whom he associated with himself, and by this and other works introduced the Jews to modern culture. At the same time he gained a distinguished place in the world of letters by the pure and exalted tone, and the charming style, of his *Philosophical Dialogues*, his *Phædo*, or *the Immortality of the Soul*, and other works, which showed him to be at the height of the philosophy of that time. He remained warmly attached in feeling and practice to the synagogue, and was requested by the chief rabbi of Berlin, Hirschel Levin, who for a brief period had been chief rabbi in London, to prepare the German digest of the ritual laws of the Jews, which was ordered by Frederick the Great. Every visitor to Berlin, Jew or Gentile, sought to make his acquaintance at a kind of *salon* which he held in the afternoons. By the great majority of the orthodox Jews the writings of Mendelssohn were received with delight, and it was only by exception (as in Hamburg, Prague, Fürth, and Poland) that they were fiercely denounced as rationalistic in tendency. The times were favourable to the development to which he led the way. The ideas of the great writers who preceded the French Revolution were teaching the abolition of privilege and of religious persecution. Although neither Voltaire nor Bayle wrote in a kindly spirit of the degraded Hebrew race, the general tendency of their teaching was in the direction of toleration, and so it happened that just at the moment when the Jews were become more than ever willing and ready to enter into the national life of Germany, the country was being prepared to receive them. The civil restrictions were only gradually abolished; painful revivals of hatred recurred from time to time, but henceforth the name of Jew grew year by year to mean less a distinction of nationality, and became more exclusively a denomination referring merely to ancestry and religious belief.

Among the friends and disciples of Mendelssohn who continued his work were Wessely (the father of modern Hebrew poetry), David Friedländer (founder of the Jews' Free School in Berlin), Joel Löwe (professor at the Jewish Wilhelmschule in Breslau), Herz Homberg (tutor in the house of Moses Mendelssohn, and inspector of German schools of the Jews in Galicia), Aaron Wolfsohn (teacher at Breslau), Baruch Lindau (writer on physics), Marcus Herz (Mendelssohn's family doctor, whose more famous wife, afterwards converted to Christianity, received at her house a brilliant society, the two Humboldts, Count Bernstorff, Gentz, and Börne), Isaac Euchel (translator of the Jewish prayer-book), Lazarus Bendavid (who was specially concerned with education). All these and others contributed to the Hebrew periodical *Massef* ("The Gatherer"), published at Königsberg and Berlin, 1783-1790; Breslau, 1794-1797; Berlin, Altona, Dessau, 1809-1811. The activity of the literary period which followed appears from the long list of rabbinical reprints, some with valuable notes, or translations, issued immediately before the close of the 18th century from the Jews' Free School printing-press at Berlin, under the direction of Isaac Satanow.

From minimizing differences in religion some were led to give up their distinctive religion altogether, and adopt a nominal, sometimes a real, Christianity, and thus the famous names of Heine, Börne, Edward Gans the jurist, Rabel, the younger Mendelssohn the composer, and Neander

The historian pass out of the scope of this article. These celebrated persons belong rather to the general history of German culture than to that of the race from which they sprang. Among the general body of the Jews, the removal of political restrictions and a closer communion with modern thought worked noticeable, though less radical, changes. The old system of preaching in the synagogue was revived, and led to the excision of some of the interminable prayers and sacred poems which the piety of preceding ages had accumulated in embarrassing profusion. After the establishment of the consistory in the (French) kingdom of Westphalia, German lectures were held in Cassel, Dessau, Berlin, Hamburg, &c.; and now there is scarcely anywhere an important Jewish community without a preacher. Organs were introduced into some synagogues. The alterations brought about disputes in several communities and even secessions, as at Hamburg in 1819. In Prussia the Government, acting on the principles urged in Mendelssohn's time by his friend Delm, but vigorously combated by the Jewish philosopher, gave the sanction of state authority to the resolutions of the orthodox. The private synagogue founded in Berlin by Israel Jakobsohn, after the breaking up of the Westphalian consistory, on principles similar to those of the reformed Hamburg Temple, was closed, and suffered the same fate when reopened as a public synagogue in 1817 and again in 1823. Even choirs and sermons were prohibited as un-Jewish innovations. Such regulations tended to disgust many educated persons who might otherwise have continued to remain attached to the faith of their fathers. They felt themselves isolated in the midst of their less advanced brethren, and were tempted to identify themselves even in religion with their more cultured Christian associates. Besides, a change of faith offered an escape from humiliating legal restrictions, and opened the way to more dignified careers than those permitted to the conforming Jews. The smaller German states appointed rabbis who were more or less state officials. When the Government restrictions were removed, considerable divergences manifested themselves, which the assemblies of rabbis and synods, beginning in 1844, and continued from time to time to the present day, did little to heal. There now exist in most German towns an orthodox and a reform congregation, which differ in their mode of conducting public service, in the prominence given to the belief in the Messiah and the return to the Holy Land, and in their greater or less adherence to the laws of the Sabbath, and laws concerning diet, &c. One reformed congregation in Berlin keeps the Sabbath on the first day of the week.

More remarkable examples of sectarian dissent were the movements known by the names of Sabbathai Zebi, of Frank, and of the Chasidim. Sabbathai's career had Turkey for its theatre, but the influence of his strange pretensions was felt in Poland and Germany, as well as throughout the East. Sabbathai Zebi was born at Smyrna in 1626. He announced himself the Messiah in Jerusalem, named his brothers kings of Judah and Israel, took the title for himself of king of the kings of the earth. Miracles were related of him; from Poland, Hamburg, and Amsterdam treasures poured into his court; in the Levant young men and maidens prophesied before him; the Persian Jews refused to till the fields. "We shall pay no more tribute," they said, "our Messiah is come." The pretender, whom so many unhappy people were ready to acclaim as their deliverer from unendurable evils, afterwards embraced Mahometanism to escape death from the Porte. Some of his followers went over with him to Islam; others treated his conversion as forced, and still proclaimed themselves Jews and his disciples. Their faith was nearer to immortality than their Messiah, and he was still believed in and his return expected after his death. Out of the wrecks of the Sabbathai party Jacob Frank formed in Podolia the Zoharites, whose Bible was the Cabbalistic work called *Zohar*. Persecuted by the orthodox, he put himself under the protection of the bishop of Kaminiak, and burnt the Talmud in public. When his protector died he migrated with hundreds of followers, and afterwards lived in royal state at Vienna, Brünn, and Offenbach, ending by becoming a Roman Catholic. He died in 1791, and his sect perished with him. Very different was the fate of the Chasidim ("the pious"),

who preceded Frank and have survived him. They also swear by the *Zohar*, and revere as their founder Israel Baal Shem ("possessor of the wonder-working name"), or Besht, who flourished at Miedzibozh in Podolia in 1740. Besht pretended to be the promised child foretold by the prophet Elijah, and named by him Israel before his birth. A long sojourn in solitary places, much fasting and physical torment, the tortures of rolling in thorns in summer and of bathing in half-frozen rivers at midnight in the winter, gave this prophet the faculty of seeing visions, the power to heal diseases, and to release souls held captive in the bodies of brutes. Like the older Kabbalists he treated the Talmud with contempt; he exhorted his followers not to lead a gloomy ascetic life, but praised gaiety and enjoyment as tending to a career agreeable to God. Joyful religious worship was to be induced by drinking, jumping, clapping of hands, making noises and screaming, to which were added ablutions according to the fashion of the Essenes of old, and the wearing of a peculiar dress. Amongst his followers many found out how to derive advantage from the superstition and ignorance of the masses. Dob Beer (Bernsh) of Mizricz seldom showed himself but to his disciples, and had reports of his wondrous works spread by them; many sick and lame went to him for cure; offerings of money came in and supplied the Zaddik with means to lead a princely life. The Chasidim still flourish in Russia and Jerusalem, and the Zaddikin (or "righteous") and Rebbe's, as their leaders are called, live in magnificence upon the contributions of the most ignorant of the people.

While this and cognate heresies were driven back into the over-crowded Jewish communities of Russia and Poland from which they came, in Germany Talmudic studies were pursued with undiminished zeal, though carried on in gradually narrowing circles, and largely owing to the knowledge of the Talmud being a qualification for appointments in large congregations. Gradually the Talmud, which had been once the common pabulum of all education, passed out of the knowledge of the laity, and was abandoned almost entirely to candidates for the rabbinate. In the earlier part of this period, the rabbis received their education at the Yeshiboth ("sessions" of academies devoted to the Talmud, the *Shulchan Aruch*, and their commentators). As the spirit kindled by Mendelssohn penetrated the various sections of the Jews, it was felt that this mode of instruction would not suffice, and institutions were founded, not confined exclusively to these studies, but embracing the whole domain of Hebrew theology, philosophy, and history. Jonas Fränkel in 1854 established the Judæo-theological seminary at Breslau, an institution which has provided Germany and Austria as well as England and the United States with many rabbis. Its first director was Zacharias Fränkel (1801-1875), predecessor of Graetz in editing the *Monatschrift*, and author of works on the Septuagint, the Mishna, and the Talmud of Jerusalem. Of later date are the high school for the study of Judaism, founded in 1872, and the "seminary for rabbis for orthodox Judaism," under Dr Hildesheimer, established at Berlin in 1877. Israel Jakobsohn, president of the Westphalian consistory (1768-1823), did good service in improving teaching. He founded in Seesen (Brunswick) an educational and normal institution, bearing his name, for Jews and Christians, which still flourishes. A similar college was instituted by his brother-in-law Isaac Samson, and directed by S. M. Ehrenberg, amongst whose pupils were Jost and Zunz. Schools of a more elementary character were the Berlin Free School, already referred to, and others. In Dessau, Moses Mendelssohn's birthplace, the free school fostered by the duke, and called after him *Franzschule*, flourished under David Fränkel (1779-1865), editor of the journal *Sulamit*; in Frankfort-on-the-Main was the Philanthropin, now converted into a technical school. In almost all Jewish communities we now find institutions teaching religion. After a first and unsuccessful attempt, Dr Moritz Veit founded a normal school, which existed under Zunz in Berlin from 1840 to 1852, and was revived by Dr Veit and the famous preacher and author Dr M. Sachs. Similar schools were founded in other places—Hanover, Münster, Düsseldorf, Cassel,—with more or less success. The union



for the culture and science of Judaism (1823) and the Culturverein had a brief existence. Instead of receiving support and thanks, the chief workers were regarded as heretics.

The modern historical study of Judaism was inaugurated by Rapoport and Zunz. Solomon Juda (Löb) Rapoport, sprung from an old family boasting many learned Talmudists, was born in Lemberg in 1790, and was rabbi at Tarnopol and in Prague, where he died in 1867. His published essays in various periodicals or in the form of prefaces are largely biographical, and display a great range of reading and power of combining distant references. Of his projected Talmudic encyclopedia but one part appeared, and his scheme for a biographical series under the title of *Men of Renown* remained unrealized, except some fragments. Nachman Krochmal (1780-1840) was not less learned than Rapoport, and perhaps surpassed him in philosophical acuteness.<sup>1</sup>

Of greater importance and influence were the writings of the patriarch of living Jewish scholars, Leopold Zunz, especially his epoch-making work *Die Gottesdienstlichen Vorträge der Juden* (Berlin, 1832).<sup>2</sup> Among other historical writers may be named Isaac Marcus Jost (1793-1860), teacher in the Jewish normal school at Frankfurt, editor of a valuable edition of the Mishna with a German translation (1832-34), and author of several important histories of Judaism and its sects, A. GEIGER (*q.v.*), and H. Graetz of Breslau, who has composed the most comprehensive history of the Israelites that has yet appeared. To the names of these scholars may be added Fürst the lexicographer (*q.v.*), M. Steinschneider the bibliographer, Herxheimer the translator of the Bible (*Pent.*, 1841; *Proph. and Hag.*, 1841-48), and Herzfeld the historian (*Gesch. d. V. Jis.*, 1847). In modern German-Jewish literature Philippon of Bonn and Lehmann of Mainz are leading representatives in journalism of reform and orthodoxy. German Jews have also distinguished themselves in general public life, claiming such names as Lasker in politics, Auerbach in literature, Rübenstein and Joachim in music, Traube in medicine, Lazarus in psychology. Especially famous have been the Jewish linguists, pre-eminent among whom are T. Benfey of Göttingen (1809-1881), the most original of modern comparative philologists and the greatest Sanskrit scholar of our day, and the admirable Greek scholar and critic Jacob Bernays of Bonn (1824-1881).

Within the last year or two the success of the Hebrew race in commerce and the professions has led in Germany to a singular revival of old-world prejudices. A series of leagues of "Germans" were formed against the "Semites." Stöcker, a "Christian Socialist" and court preacher to the emperor, gave importance to the movement by placing himself at its head. Its weapon is social ostracism: meetings are held at which the Jews are loudly denounced; and members of the "German" leagues vow to have no commerce with the hated race. Occasionally the two parties came to blows, some Jewish houses were wrecked, and a synagogue at Neu-Stettin burnt. At this point the Government interfered.

The universal admission of the Jews to public posts only dates from the establishment of the empire. In the German states the spiritual emancipation of the Jews was not immediately followed by political emancipation. They were freed in Germany by the French law as a result of the conquests of Napoleon, but lost their civil equality when the French retired, to regain it bit by bit in succeeding years.

The Leibzoll, the odious tax imposed upon a Jew as often as he crossed the boundary of a city or petty state, even if he went in and out twenty times in the day, was

<sup>1</sup> His fragmentary works were collected by Zunz, under the title *More Nebocho ha-seman*, 1851.

<sup>2</sup> A collected edition of Zunz's scattered essays was commenced by the "Zunzfund" in honour of his eightieth birthday, 1874.

removed in Prussia in 1790, and in other German states in 1803. In 1812 the royal edict declared all Jews in Prussia to be citizens, and gave them equal rights and privileges with their Christian fellow countrymen. They fought in the war of liberation, but after its success there was a reaction, and the new privileges (more particularly free admission to academic posts) were in part withdrawn. The Jews who had been promoted to the rank of officers during the war had to quit military service to escape the degradation of losing their commissions. The national parliament, which met at Frankfort in 1848, adopted resolutions in favour of the removal of religious disabilities. The Prussian constitution of 1850 declared that the enjoyment of civil rights was independent of religious confession. The legislation with which the empire was inaugurated in 1871 at length gave political and civil equality to the Jews throughout Germany.

The number of the Jews in the German empire is now 520,575, or 1 per cent. of the whole population (census of 1875). The Gemeindefund, or union of congregations for some religious and charitable purposes, has recently been established at Leipsic. The Jews are engaged in all the occupations which other citizens pursue in Germany. While they show a marked predilection for and success in commerce and the learned professions, a few are farmers and sailors. Being subject to the ordinary military laws, they serve in the army, and many Jews hold commissions in those regiments in which noble descent is not a necessary qualification.

While the spiritual awakening of the Jews was essentially a German movement, having its centre in Prussia, the most powerful impulse to their political liberation came from France. The Jews had been banished from France by Charles VI., but a few had returned. Some Portuguese fugitives had taken up their residence at Bordeaux and Bayonne. Others had settled at Avignon under papal protection, and at Carpentras there was a congregation with a liturgy in some respects peculiar. To Paris the Jews began to return in 1550, but held the privilege of domicile by a precarious tenure till Pereyre, the founder of the institution for deaf mutes, obtained in 1776 formal confirmation of the leave given to the Portuguese Jews to reside in the capital. There were already several hundred German Jews resident in an unlawful way, and protected chiefly through the influence of a German Jew named Calmer, who had been naturalized for services to the Government. The conquest of Alsace had added largely to the Jewish subjects of France. In 1780 the Alsatian Jews presented to the king a petition complaining of the seigniorial dues exacted of them, of the restrictions on their trade, and the efforts of the priests to convert their children. The complaint was not without effect. The capitation tax was abolished in 1784, projects of enfranchisement began to be broached, and a commission was appointed for the revision of the laws about the Jews, but its work was interrupted by the Revolution. The Jews addressed themselves with better hopes to the national assembly, and those of Paris distinguished themselves by demanding the withdrawal of the authority of the synagogue over its members. In 1790 the French Jews united in sending into the assembly a petition demanding their admission to full and equal rights with other citizens. This requisition at first met with some serious opposition even among the advocates of universal liberty; the ancient prejudice against this people had not been entirely eradicated. But the exertions and influence of Mirabeau and Rabaut St Étienne prevailed. In 1790 the Portuguese Jews, and in 1791 the whole Hebrew population of France, were admitted to complete rights of citizenship. The constitution of 1795 confirmed the declarations of the assembly.

The gratitude of the Jews was shown by their patriotic devotion in the wars of the Revolution.

One of the most remarkable events in modern Jewish history was the convocation of the Sanhedrin (Synedriion) by Napoleon. It was preceded by the session of a general assembly of one hundred and eleven delegates, held in Paris in 1806 under the presidency of Abraham Furtado, merchant, author, and scientific agriculturist, the delegate of the Portuguese congregation in the port of the Gironde. To this assembly twelve questions were submitted by the emperor, and its principal answers were afterwards confirmed and formulated in nine propositions of law by a Sanhedrin formally elected by the synagogues in France and Italy. The Sanhedrin commenced its sittings on February 9, 1807, under the presidency of Rabbi David Sintzheim of Strasburg, with a Piedmontese rabbi as first, and an ex-legislator of Italy as second assessor. The forms of the old Sanhedrin were observed as far as possible; the responses are couched in the form of statutes binding the constituents of the Sanhedrin, and these decisions have usually been treated with much respect even by communities which sent no delegates, while the Jews of Frankfort and Holland formally accepted them.

The following are the nine decrees:—(1) polygamy is forbidden, according to a decree of the synod of Worms in 1050; (2) divorce is allowed to the Jews if and so far as it is confirmatory of a legal divorce pronounced by the authority of the civil law of the land in which they live; (3) no Jew may perform the ceremony of marriage unless civil formalities have been fulfilled,—intermarriages with Christians are valid civilly, and, although they cannot be solemnized with any religious celebration, they involve the parties to them in no ban; (4) the Jews of France recognize in the fullest sense the French people as their brethren; (5) acts of justice and charity are to be performed towards all mankind who recognize the Creator, irrespective of their religion; (6) Jews born in France and treated by its laws as citizens consider it their native country,—they are bound to obey the laws of the land; Jews are dispensed from ceremonial observances during service in the army; (7) the Sanhedrin exhorts the Jews to train their children to laborious lives in useful and liberal arts, to acquire landed property as a means of becoming more firmly attached to their fatherland, to renounce occupations which render men odious and contemptible in the eyes of their fellow-citizens, and to do all in their power to acquire their neighbours' esteem and good wishes; (8) interest is not allowed to be taken when money is lent for the support of a family, but interest is permitted when money is lent for commercial purposes, if the lender runs any risk, and if the legal rate is not exceeded; (9) the above declarations concerning interest, and the texts of the Holy Scripture on the same subject, apply between Jews and fellow-citizens in precisely the same way as between Jews and Jews. Usury is altogether forbidden. At the close of the Sanhedrin, the emperor established the consistorial organization which in its main features still exists in France. Every two thousand Jews were to form a synagogue and a consistory consisting of one chief rabbi, and two rabbis with three laymen householders belonging to the capital town of the consistory. Bankrupts and usurers were excluded from the consistory, which was to watch over the conduct of the rabbis, to maintain order in the synagogues, and to admonish the Jews of the district to follow handicrafts and obey the laws of the conscription. The central consistory, sitting at Paris, had power to appoint and depose the rabbis. The rabbis were to publish the decrees of the Sanhedrin, to preach obedience to the laws, and to pray in the synagogues for the imperial house. Many Hebrew hymns of praise were composed in honour of the despot who had framed this organization, although at the same time the emperor issued a decree which made considerable concessions to the popular prejudices against the Jews in Alsace and eastern France generally, forbade the Jews to change their domicile or enter into occupation without special permission, framed stringent precautions against usury, and excepted the Alsatian Jews from the right to provide substitutes for military service. The laws of 1814, 1819, and 1823 made some beneficial changes in the position of the Israelites, and in 1829 Charles X. established at Metz a central school for the instruction of candidates for the rabbinate. It was subsequently removed to Paris. In 1831 the Government definitively decided, in accordance with the ideas of Napoleon, that the rabbis should be state functionaries. From that year they have been paid by the state. In 1833 the French Government suspended relations with a Swiss canton which had denied equal rights to a French subject on the ground that he was a Jew.

In France the absence of political restrictions has been unfavourable to the separate development of Judaism. The ministers Crémieux (1796–1879), Fould, and Gouchaux, the archaeologists and philologists Jules Oppert and Halévy and the Darnesteters, the composer Meyerbeer, and many others, are well-known names in the general history of their country. Many Israelites have occupied high civil and military posts. Other Israelites by race have become

indistinguishable by religious practice from the main body of the citizens; and the principal contributions in France to Hebrew literature have been from writers born in Germany, like Munk (1802–1867) and Derenbourg, like Samuel Cohen and Franck.

Before the year 1860, an outbreak against the Jews in Russia, the accusations at Damascus, the Mortara abduction case in Italy, and about this time the sufferings of the Jews in Morocco, had vividly excited the sympathies of the Jews in western Europe; they had joined together to make contributions of money for relief of distress at Königsberg and in the Holy Land, and had even made representations to the Governments of the various countries in which they resided in order to bring political means to bear to alleviate the fate of their unfortunate co-religionists. An English Jew, Sir Moses Montefiore, took the lead in these efforts. But there was no regular provision for prompt and concerted action in defence of outlying and oppressed communities of Jews till, in 1860, an organization was established in Paris which was destined to exert a permanent watchfulness over the oppressions practised in the less civilized countries upon Jews, as well as to improve the backward communities of Hebrews by education. This was the Alliance Israélite Universelle, which on January 1, 1881, had 24,000 subscribers in all parts of the world, though Israelites are by no means unanimous in supporting it.

The connexion between the local committees and the central body is not very intimate, but a correspondence is constantly kept up, and subscriptions for public objects flow from one to the other according to their respective wants and wealth. The Alliance and similar societies of a more strictly national character which exist in London and Vienna made representations at the Berlin conference in 1878, and helped to procure some alleviations of the state of the Jews in Roumania and Servia. The exertions of the same bodies had previously arrested, by making them known to Europe, the atrocities practised upon the Roumanian Jews in 1872. Similar action was brought to bear at the Madrid conference in 1880 in favour of the Jews in Morocco. Another part of the work of the Alliance is to maintain or assist schools for boys and girls in North Africa and in the Turkish empire, &c. In this task it co-operates with the Anglo-Jewish association formed for similar objects in England, the Board of Deputies in London, and the Alliance in Vienna. The Alliance has also an organization for apprenticing Jewish children to useful trades in eleven Eastern towns. Other Jewish public institutions at Paris are the rabbinical seminary under chief rabbi Wogne, schools and an industrial school for girls, the hospital founded by the late Baron James de Rothschild, the orphanage established by the late Baron Salomon de Rothschild, the ladies' committee and house of refuge, a central committee for Jerusalem schools, the society of Talmudical studies, and many burial and mutual aid societies. At Lyons and Marseilles there are similar institutions.

The distinction between reform and orthodox congregations, which has been noticed in Germany, and reappears elsewhere, is not found in France. The older distinction between the Spanish and Portuguese Jews (Sephardim) on the one hand, and the Polish and German Jews (Ashkenazim) on the other, is, however, still made. They have different synagogues, in which a somewhat different ritual and a different pronunciation of Hebrew are employed. No doctrinal distinction, however, exists between the two divisions, and they now freely intermarry and associate with each other, although at their first meeting in France and England, about a century ago, and for some time later, the rich and polished emigrés from the south refused to mix with their uncultured northern brethren. The Jews of German rite are now much more numerous and wealthy in western Europe than the Sephardim.

The number of Jews in France in 1880 was about 60,000, of whom 34,000 were in the consistorial circumscription of Paris, 8860 in that of Nancy, 2200 in Lyons, 4000 in Bordeaux, 2200 in Bayonne, 4000 in Marseilles. The Jewish population in France (including northern Italy, and Treves, Mainz, Colmar, &c.) in 1808 was 77,000; it had risen to 155,994 (without including Italy or Treves and its sister cities) when the census of 1866 was taken, but fell to 49,439 in the census of 1872, owing to the loss of Alsace



Lorraine, the part of France in which the most numerous Jewish population existed. The Jewish inhabitants of the Paris circumscription were in 1808 only 3585 in number, about a tenth of their number in 1880. Two Jewish newspapers are published in the French language at Paris, and one at Avignon. The Jewish population of Algeria in 1880 was (according to the *Annuaire Israélite*) 72,800, of whom 52,000 were in the consistorial circumscription of Oran. These figures show a large increase in the population in recent years. M. Cremieux by a stroke of the pen obliged the Israelites in Algiers to become French citizens, a step that had previously involved certain formalities which their conservative feeling resisted. The measure, however, led to an outbreak of the Arabs. In Versailles exertions were made to cancel it, and its operation was suspended, but finally the decree was sustained, and the Jews, who form the class among the native population most fitted for civilization, retain the franchise.

England. The Jews were readmitted into England by Cromwell on the application of Manassch ben Israel; and the Spanish and Portuguese Jews from Amsterdam took a lease of ground for a burying-place at Stepney in February 1657. The first recorded interment was in 1658. The city of London, which was afterwards to aid so powerfully in the emancipation of the Jews, petitioned the council in the first years of the restoration to remove the competing Jewish merchants, but, this and other petitions being unsuccessful, a synagogue was built and the copyhold of the cemetery was acquired, although up to fifty years ago doubt was sometimes expressed whether Israelites even if born in the country could hold land in England. The right of Jewish charities to hold land was clearly established by an Act passed in 1846. The Jews were too few in number to be visited with special disabilities, but suffered from the general operation of the Tests Acts, which excluded them from political, civil, and municipal offices, from the bar, &c., and could be invoked to prevent them from voting at parliamentary elections. Jacob Abendana and David Nieto are rabbinical writers who flourished in England in the 17th and early in the 18th centuries. In 1725 Sarmento, a mathematician, was (like Gompertz and others after him) made a Fellow of the Royal Society. Emanuel Mendes da Costa was secretary and librarian of the society a few years later (died 1769). Sir Solomon Medina financed the commissariat in the duke of Marlborough's campaigns. But the Sephardic immigration is best known by the converts to Christianity whom it supplied, as Isaac Disraeli, and his son Lord Beaconsfield (who was baptized at the age of twelve), David Ricardo, the Lopes family, and others. Conversion to Christianity was encouraged by a statute of Anne (repealed in 1846), which compelled Jewish parents to make an allowance to their children who embraced the dominant faith. German Jews began to immigrate in large numbers after the accession of the house of Hanover. English statesmen soon perceived what important contributions the business ability of the Jews was capable of rendering to the wealth of the country in which they settled, but the enlightened appreciation of the governing class was long in making its way among the electors. In 1753 Mr Pelham passed his Jewish Naturalization Act, which was repealed the next year owing to popular clamour, "No more Jews, no wooden shoes," becoming as influential a refrain as *Lilliburlero*. This premature emancipation supplied an argument which afterwards assisted to retard the political liberation of the Jews. The Jews were excepted from the benefit of the Irish Naturalization Act in 1783; the exception was abolished in 1816; in that year also the obsolete statute *De Judaismo*, which prescribed a special dress for Jews, &c., was formally repealed. It had been disregarded ever since the return of the Jews under Cromwell. The Reform Act of 1832 gave the right of voting for members of parliament in all constituencies to Jews who possessed the property or other qualification required. Mr Robert Grant, M.P. for Inverness, in 1830 proposed to admit Jewish members to the House of Commons, Mr Huskisson having pre-

viously presented a petition asking for this concession. The bill was carried on the first reading by eighteen votes, but lost on the second by sixty-three. The Board of Deputies had been appointed in 1760 to watch over the interests of the "Portuguese nation" as the Sephardic Jews called themselves in England and France; it was shortly afterwards joined by delegates of the German congregation, and now represents the orthodox congregations in the principal towns of the United Kingdom. Through this board the House of Commons was frequently petitioned in the next thirty years to grant political equality to the Jews, and the claim was supported by eminent statesmen, notably by Macaulay and by Lord Russell, the latter of whom brought in an annual bill on the subject. Baron Lionel de Rothschild was elected five times by the city of London before he was allowed to vote, and was eleven years a member of the House of Commons without taking the oath. Alderman Salomons was returned for Greenwich in 1851, and took his seat, spoke, and voted, having in repeating the oath omitted the words "on the true faith of a Christian." He was fined £500 by the court of exchequer, and was obliged to retire from parliament. The enabling bills had been passed year after year in the House of Commons, but as often rejected by the Lords, until in 1858 a compromise was effected, and Jews were permitted by the joint operation of an Act of Parliament and a resolution of the House of Commons to omit on taking the oath required of a member of the Lower House the words to which they conscientiously objected. In 1866 and 1868 Acts were passed which prescribed an oath in a form unobjectionable to Jews to be used in the Houses of Lords and Commons alike, but no Jew by religion has yet been raised to the peerage. Remarkable legislative provisions in favour of the Jews are the exceptions by which they have enjoyed since 1870 under the Factories Acts the right to labour on Sunday in certain factories if they rest on their own Sabbath. Till 1828 only twelve Jewish brokers were permitted to carry on business in the city of London, and the patent was purchased for large sums when vacancies occurred. No Jew could open a shop in the city till 1832, because that permission was only accorded to freemen. Even baptized Jews were not admitted to the freedom of the city between 1785 and 1828. The first Jewish sheriff of London, Sir D. Salomons, was unable to take the oath till a special Act was passed by Lord Campbell in 1835, and, although he was followed two years later by another Jewish sheriff, Sir Moses Montefiore, it was not until ten years after his election as alderman that Lord Lyndhurst's Act (1845) enabled him to perform the duties of that office. Among the names of Jews in England distinguished in science and literature are the mathematician Sylvester, the Sanskrit scholar Goldstücker, and the Orientalists Zedner and Deutsch. The first Jewish barrister (Sir F. Goldsmid) was called to the bar in 1833.

The Jews' Free School in London is probably the largest and most efficient elementary school in England. Two Jewish newspapers are published in London. The Jewish community in England maintains many charitable and other public institutions. The most important are the boards of guardians in London and Manchester, which are chiefly occupied in the relief of penniless emigrants from Russian Poland. Dr Benisch, the late editor of the *Jewish Chronicle*, founded in 1871 the Anglo-Jewish association to co-operate with the Alliance Israélite de Paris, which has been already described. The association has nearly 3000 members, chiefly in England and the colonies, but also at Alexandria and Tangiers. The Jews' college in London and the Aria college at Portsea are designed for the training of ministers and teachers: Three societies for the promotion of Hebrew literature have been formed. The only one which still exists is the Society of Hebrew Literature, to which Christian scholars have contributed equally with the Jewish students of the same subject. The principal religious movement has been the formation of the West London congregation of British Jews, a body of dissenters, who have simplified the ritual, only keep one day of the festivals, and do not acknowledge the spiritual ascendancy of the chief rabbis



They seceded in 1840. Congregations at Manchester and Bradford worship with the same rites. The Sephardim and Ashkenazim still differ in liturgy and in pronunciation of Hebrew. The principal London synagogues of the latter body were federated by private Act of Parliament in 1870 under the name of the United Synagogue, which now consists of ten London congregations. Its liturgy was modified in the direction of brevity in 1880. Forty provincial orthodox synagogues are recognized by the Board of Deputies, which under the Marriage Acts certifies the secretaries of orthodox synagogues entitled to register marriages.

The Jewish population of Great Britain is estimated (in the absence of a census by religions) to be 62,000, of whom 40,000 are reckoned to be in London. There were 453 Jews in Ireland at the census of 1881.

In the British colonies Jews are numerous and their congregations flourishing. There are nearly 2000 Jews in Gibraltar, who carry on an active commerce with their brethren in Morocco, sending Manchester and Sheffield goods, and receiving corn, hides, and other produce. Their settlement dates from the British occupation in 1704, which allowed the unhappy Spanish refugees in Morocco to return to a corner of Spain. Jews have been law-officers, ministers, members of the legislatures, and magistrates in the Australasian colonies, Cape Colony, the West Indies, &c. In Victoria there were 3571 Jews in 1870, and a Jewish newspaper is published at Melbourne; in West Australia there were 62 only in 1870; in Tasmania they formed only 0.23 per cent. of the total population of 99,323.

A remarkable settlement exists in Bombay under the name of the Beni Israel. They are 5000 in number, and are for the most part artisans, some of them soldiers. They support a school to which the Anglo-Jewish association in London and Manchester contribute. The Beni Israel have a tradition that they were shipwrecked on that coast more than one thousand years ago. They have always strictly observed the Sabbath, refraining from cooking their food or doing any other work on that day. They do not eat unclean fish or flesh; they observe the great feasts, and have a Jewish type of countenance. The Beni Israel are found not only in Bombay itself but in other towns on the coast not beneath the direct rule of the British Government. They relate that David Rababia, a Jew either of Baghdad or Cochim, came to that part of India about nine hundred years ago, and, having discovered that the Beni Israel were observing the Jewish code, was convinced of their Jewish origin, and established a Hebrew school. Before his death he gave a written order to two of his scholars to succeed him as religious ministers. This office has been retained to this day by their descendants. These ministers are called *kajees*, and are considered superior to the ordinary religious ministers who receive payment for officiating in the synagogues. They are in some respects like high priests and civil heads of the community; and in the outlying villages ecclesiastical and civil matters are investigated and settled by them with the aid of a council. With these *kajees* may be compared the *cohanim* (*priests*) in the Western Jewish communities, who are reputed to be descendants of Aaron, and enjoy the prerogative of blessing the people, and a certain precedence in synagogue. In Bombay judicial and other civil functions for the Beni Israel are performed by a person called *Nassi* or head, aided by a council. The Beni Israel have been settled in Bombay itself for upwards of one hundred and fifty years. Their first synagogue was built in 1796 by Samuel Ezekiel, a native commandant in the British army sent against Tipoo Sahib. The Sephardic daily prayer-book, Dr Hermann Adler's sermons, and some other works have been translated by the Beni Israel into Marathi. Some of them know Hebrew, although Marathi is their ordinary language, and their knowledge of Hebrew is probably rather due to frequent intercommunication with the Jews of Baghdad and Europe than to independent tradition. The Beni Israel rarely intermarry with the ordinary Jews. They have a literature in Marathi. They tie a golden band ("munny") with black glass beads round the bride's neck during marriage to show that the bride is a married woman; when she is stripped of it she is considered a widow. They say that they adopted the title of Beni Israel because that of Jehudim or Jews was hateful to the Mussulmans. The Baghdad and Cochim Jews attend their synagogues and eat with them, and *vice versa*. They have among them a class of Beni Israel whom they designate *Kala Israel* or *Black Israel*. Between them and the white Beni Israel no intermarriages are ever solemnized. They are descendants of Beni Israel by heathen wives, or are proselytes or their descendants. They have separate burying-grounds.

The Jews of Cochim, found in that British port of the Madras presidency and elsewhere on the Malabar coast, have the tradition that they arrived at Cranganore in the sixty-eighth year of the Christian era, and received a written charter from the native ruler, and that when the Portuguese came they suffered oppression and removed to Cochim, where the rajah granted them places to build their synagogues and houses. They again suffered from the Portuguese, but the Dutch conquest in 1662 gave them protection. At Cochim there are black and white Jews. The white Jews consider

themselves as immigrants from Palestine. The black Jews are regarded as proselytes and emancipated slaves of the white Jews. The black and white do not intermarry with each other, and the black Jews do not observe all the ceremonies of the law.

The history and condition of the Jews in three important Austria countries and their colonies having been somewhat fully sketched, a shorter account of their situation elsewhere will be sufficient. The Austrian Jews participated in all the intellectual movements of their brethren in Germany. Their chief writers are Kompet (the brilliant author of *Tales of the Ghetto*), Frankl the poet, G. Wolf, historian, Mesenthal, dramatist, Dukes, Kayserling, Mannheimer, Jellinek, Gudemann, Kanfmann, Letters. The chief training establishment for rabbis is the Budapest seminary established with the proceeds of the fine imposed upon the Jews for participation in the insurrection in 1848. Austria was long notorious for ill-treatment of the Jews, but Joseph II. made in 1783 a new departure in his policy towards this class of his subjects. He abolished the *Leibzoll*, night-notices, passport regulations, and gave the Jews permission to learn trades, art, science, and, under certain restrictions, agriculture. The doors of the universities and academies were opened to them. He founded Jewish elementary and normal schools, and also compelled the adults to learn the language of the country. In spite of these reforms, considerable restrictions were still imposed upon the Jews with regard to right of residence, &c., and the successors of the philosophic emperor, Leopold II. and Francis I., restored many of the old humiliating regulations. The Jews in Austria remained during the greater part of the present century subject to special restrictions. To remove from province to province they required the permission of the central Government. In many parts of the empire they were not allowed to rent or purchase lands beyond their own dwellings. The Magyar nobles, however, employed them largely as bailiffs, gave them great freedom of tenure, and actually fought under their lead as military officers in the struggle for independence. After 1848 the Jewish capitation tax was reduced except in Vienna; but, as many Jews had taken part in the revolutionary movement in Hungary, a heavy exaction was imposed upon them after its suppression. The reforms inaugurated by the constitution of 1860 for Austria and in 1861 for the rest of the empire, and completed in 1868, at length gave the Austrian Jews the freedom which they now enjoy, which makes them influential and respected in Vienna and the other great towns, and even in the backward province of Galicia a striking contrast to their less favoured brethren in the neighbouring country of Russian Poland. Several Jews, two of them rabbis, sit in the legislatures. The Israelitish Alliance was founded in Vienna in 1872. The number of the Jews in the empire of Austria-Hungary is 1,372,333, or more than 3 per cent. of the total population. Of the total number, 820,200 are found in Austria (including 575,433, or more than a tenth of the total population in Galicia), and 552,133 in Hungary.

In Italy, while Venice and Leghorn sheltered large and comparatively flourishing colonies, the Roman Jews had long an unenviable pre-eminence in suffering. Till 1847 they were not permitted to leave the Ghetto, and their conversion was sought by most oppressive means. It was in the papal states after this date that the young Mortara, secretly baptized by his nurse, was torn from his parents, and trained to be a monk. The kingdom of Italy brought freedom and political equality to the Jews. The most celebrated of recent Jewish scholars in Italy was S. D. Luzzatto (1800-1865). The rabbinical college at Padua, founded by J. S. Reggio di Görz (1784-1855), fell with the Austrian domination in 1866. The number of Jews in Italy was in 1876 estimated to be 53,000, of whom 5000 were in Rome, 2800 in Modena, 3000 in Venice, 2000 in Sicily, 7688 in Leghorn, 2500 in Turin, 2000 in Padua.

The census of 1870 gave 2582 as the number of the Jews in Greece. They enjoy perfect freedom of worship, and live on terms of friendship and equality with their neighbours in the kingdom of Greece, although at Alexandria, Smyrna, and other towns of the Levant, quarrels sometimes occur between the two races.

The liberal institutions established during the last few years in Spain. Spain have permitted the Jews to return to a country in which their ancestors enjoyed a glorious period of literary and social activity. In 1881 the Spanish representative at Constantinople was authorized to assure some distressed Jews who fled into Turkey to escape the persecutions of Russia that the Government of Spain would welcome them to that country, in which, he added, all Jews could now settle. At Seville Jewish worship is regularly held, and meat killed according to Jewish rites can be bought. At Madrid a congregation assembles on the most solemn fast in a private house.

Since the commencement of this century foreign Jews of Portuguese origin from Gibraltar and Africa have immigrated into Portugal and been permitted to solemnize religious service there. There are three synagogues at Lisbon and one in Oporto. On the Day of Atonement, unknown persons from a distance in the interior have been observed to join these congregations; they were members of Jewish families who had secretly preserved their religion and the tradition of their origin during the whole time of the exclusion of



the Jews from Portugal. In 1821 the cortes abolished the Inquisition, and resolved that all rights and privileges which had been accorded to the Jews by former sovereigns should be renewed, and that all Jews who dwelt in any part of the world might settle in Portugal. About 1000 Jews reside in this country.

**Holland.** In Holland, which was long the refuge of the Jews, and was the cradle of a flourishing Jewish literature, the Israelite immigrants were not entirely without restrictions, although Mendelssohn pointed to Amsterdam as a commercial paradise where all men were allowed free interchange of commodities. The 50,000 Jews of Holland, 20,000 of whom resided in Amsterdam, were first admitted to political equality in 1796, and the closer union with France which followed completed the work of liberation. At first this gift was not willingly received by the leaders of the Jewish community. They enjoyed great power over individuals, could levy large fines upon those members of the congregation who incurred their displeasure, and feared that the new duty of serving as soldiers and the new right of filling all the employments of the state would alienate their flocks. The Portuguese (or Sephardic) Jews, who were regarded as the aristocracy of their race, were especially conservative, and ultimately the discussions about emancipation led to the secession of the neutering party under the name of 'Adat Jeshurun. The number of Jews in Holland is now 68,000, to whom 665 may be added for Luxembourg.

**Belgium.** In Belgium there are about 2000 Jews, who enjoy freedom and state subvention for their worship as in France.

**Switzerland.** In Switzerland the Jews were long treated with great severity, and the French domination brought them only temporary relief. It was only in 1874 that full religious equality was conceded to the Swiss Jews. Their number is now 6996.

**Denmark.** In Denmark the number of Jews does not exceed 4500. Since 1814 they have been eligible as magistrates.

**Sweden.** The archives of the Sephardic synagogue in London contain a curious printed invitation from the king of Sweden, sent in the year 1746, in which wealthy Jews are invited to Sweden, while the poor are warned that their residence will be unwelcome. The London Jews declined this calculating hospitality. There are now 1835 Jews in Sweden, and an insignificant number in Norway.

**Russia.** In Russia the Jews are more numerous and more harshly treated than in any other country in the world. From Russia proper the Jews were long and still are excluded, but the conquests of the Muscovites brought them face to face with large numbers of Israelites who, driven out of Germany by persecution, had taken refuge in Poland under the sway of Casimir the Great. The half Hebrew half German patois (Jüdisch-Deutsch) which Jews still speak in Russia and Roumania preserves this part of their history. A literature exists in this language: journals are printed in it with Hebrew characters; theatrical representations are given in it, and two companies in London lately played dramas in it, in which the main point of the action was the misery of the religious Jew, who is dragged away from the study of his favourite Talmudical books to serve in the army, where he can hope, as a Jew, for no promotion. The flourishing factories, agriculture, and commerce of the Polish and Lithuanian Jews were wrecked by the intolerance of the successors of Casimir, and Russian oppression completed the ruin. The Jews are still confined to a few over-populated provinces, and loaded with special taxes and restrictions. Under Alexander II. the condition of the Jews was in some respects improved, and the permission accorded for three Jews to settle at each railway station has enabled a few to escape from the old overcrowded settlements and find a new sphere for their commercial activity. They are still, however, largely at the mercy of the official class, and popular risings against them have been repeatedly permitted or encouraged. They are excluded from many vocations, or practise them only by the connivance of bribed officials. For some purposes they are still subject to the jurisdiction of the rabbis. Harkavy, Pinsker, Mandelstamm, Reifman, and Levinsohn are among their most learned writers; Baron Günzburg is at the head of a society for spreading culture among the masses. In spite of their disabilities, there are among the Russian Jews enterprising contractors, skilful doctors, and successful lawyers. The number of Jews in European Russia was returned for 1876 as 2,612,179. In Russia in Asia they are estimated to number 25,000. For the KARAITES in Russia see that article.

**Moldavia and Roumania.** At the beginning of the present century the Jews were found in Moldavia everywhere keeping the village inns and forming the centres for the commerce of their districts. Engaged in this occupation, or travelling through the country to buy or advance money upon the crops, and to sell foreign merchandise, were Jews, some of whom had come from Poland or Russia, while the families of others, resident chiefly at Bucharest, had been in the country from time immemorial. They also exercised many handicrafts. They were glaziers, locksmiths, tinmen, tailors, &c. The metal roofs and pinnacles of churches were all the work of Jews. In the great towns of Moldavia, and also in the Wallachian city of Bucharest, there were established wealthy communities belonging to both divisions of the modern Jews, Ashkenazim and Sephardim. Of the

Sephardim or Spanish Jews it is known beyond a doubt that they settled in the country many centuries ago. They belonged to the families driven from Spain by the Inquisition. The principal bankers of Roumania are Jews. Their children have been in the habit of attending the same schools as the wealthy native families, and the parents held a good position in society. In Jassy, the principal city of Moldavia, 30,000 or 40,000 out of the 80,000 inhabitants are Jews. In 1804 the practice of the neighbouring states began to creep into Roumania. In that year an ordinance of Prince Mourousi of Moldavia deprived the Jews of the right to hold farms except when attached to village inns. Since that time there have been a series of laws and edicts limiting the freedom of the Jews to hold land and engage in various professions and trades; the Jews have also had much to suffer from popular outbreaks, and even the treaty of Berlin, which abolished all incapacitation on grounds of religion, has been interpreted by the Roumanian Government as not applying to the Jews, who are regarded as foreigners, and only naturalized in small numbers and by special acts of the legislature. There are 200,000 Jews in Roumania, and perhaps two or three thousand may have been admitted to naturalization.

In Servia there are 2000 Jews. They have suffered from occasional orders of expulsion from the country districts, but on the whole their condition is comparatively favoured, and they are believed to be on the eve of being admitted, if not already admitted, to political rights.

The Jews in European Turkey before the war which ended with Turkey, the treaty of 1878 were estimated to number 72,000 (in Adrianople 15,000, Shumla 1500, Widdin 1200, Varna 300, Tatar Bazardjik 1050, Dardanelles 2000, Philippopolis 2100, Rustshuk 2500, &c.). There are some thousands in eastern Roumelia, and others in Bulgaria, who have been very fairly treated by the authorities of the new principality, having grants for their schools, &c. The exertions of Dr Allatini of Salonica have provided the community of that town (25,000 to 30,000 persons) with excellent means of education. Here is published the *Epoca*, a Spanish newspaper in Hebrew characters, which recalls the fact that this, like so many of the Jewish communities on the shores of the Mediterranean, sprang from exiles from Spain. The Jewish population of Constantinople consists of about 30,000 souls. Most of the Jews are Sephardim. Two thousand follow the German rite, and are principally to be found in Galata. The Jews in Constantinople are chiefly engaged in traffic. They are governed by a *caim-macan* appointed by themselves, and salaried by the Government. There are forty-two synagogues in the suburbs. Besides the schools of the Alliance, there are 2287 pupils in the wretched Talmud Torah schools. There are also three infant schools. The number of Jews in Asiatic Turkey is stated to be from 106,000 to 130,000. The Smyrna Jews number 25,000. In Baghdad, where there are 30,000 Jews, and where the wealthy family of Sassoon first became known, there are twenty-one synagogues. Pilgrimages are made to the tombs of Ezra, Ezekiel, Joshua the priest, and Sheikh Isaac. There are 500 families in Aidin, 400 in Magnesia, 250 in Casaba, 130 in Pergamos, 516 in Canea in Crete, 200 in Candia, 1200 in Beyrout, 2000 in Damascus, 10,200 in Aleppo. Outbreaks of religious hatred between the Greeks and the Jews, and even between the Mahometans and the Jews, have occasionally occurred at Smyrna, Rhodes, &c. The Jews on each occasion have been accused of using Christian blood at the passover. The falsity of this charge was publicly established in 1840, owing to the efforts of Sir Moses Montefiore, who journeyed to the East, accompanied by Crémieux and Munk, to vindicate the innocence of those of his coreligionists who had been put to death, and to liberate those who were imprisoned. The sultan then issued, at the request of Sir Moses Montefiore, a firman declaring the innocence of the Jews, and their title to his equal protection. They now suffer under no disabilities, and are admissible to office.

There are 15,000 Jews in Jerusalem (forming half the population), whose chief occupation is to study the Talmud. To maintain them in this hallowed indolence their brethren throughout the world send annual contributions (*haluka*) amounting to about £50,000 a year, or five-sevenths of the total revenue of Palestine. The rabbis who administer these large funds, and also wield the dreaded weapon of excommunication (*herem*), have set their faces against secular education, regarding Jerusalem as the one great rabbinical college of the world, where the contributors of the *haluka* fulfil the sacred duty of studying the law by proxy. Both Ashkenazim and Sephardim (whose leaders, more liberal than the Ashkenazim, permit Arabic to be taught), both Chasidim and Karaites, are represented here; the Sephardim dress as Orientals; the Russians and Poles wear their long silk or cloth gowns and fur caps, the Germans the quaintly cut coat and flattened wideawake of the early part of this century. All cultivate the long love-locks brought down in front of the ears in obedience to Lev. xix. 27. Boys often marry at fifteen, girls at thirteen. There are two weekly Hebrew newspapers. The synagogues are very numerous; around them cluster the Talmud schools. There are three hospitals for Jews, one of which is maintained by a Christian mission, numerous almshouses, of which the *Juda Touro* house is the principal, and several endowed schools.



Jewish agricultural colonies have been formed at Lydda and elsewhere, and an excellent agricultural school at Jaffa receives thirty pupils. Jews are found at Hebron, Tiberias (1100 in number), Ramleh, Safed (6366), and elsewhere in the Holy Land.

Persia.

In the mountains of Kurdistan and on the plain of Urmiah there are Jews who speak an Aramaic dialect—"the language of the Taqum." The Jews in Persia, as in many other countries, write their vernacular in Hebrew characters. They are engaged as peddlers in petty trades or in larger commerce, or enter into partnership with Kurdish farmers, to whom they supply capital, receiving half the produce. As a rule monogamy prevails, but exceptions are frequent when the marriage proves childless, or when the levirate law comes into operation. Jews settle their differences with each other by applying to the *malum* (i.e., the rabbi) of the place, who together with his *beth din* forms the authorized court of justice. Boys are taught reading, writing, the Scriptures, and sometimes the Mishna. Every man and woman wears charms as safeguards against the evil eye, as protections both from ailments and from the attacks of enemies. The fear of infidelity is one of the causes which deter parents from letting their children learn secular subjects. Yet as each congregation requires the services of a *dayan* or religious chief, the necessity of cultivating some kind of knowledge cannot be entirely ignored. Persons desirous of pursuing a course of studies have had to resort to Urmiah and to Baghdad. There are ten synagogues, and 300 families in Teheran, partly engaged in skilled trades and professions. Jews are also found in Isfahan and other towns, &c. They are very poor, the majority in Isfahan being day-labourers and porters. The total number of the Jews in Persia is estimated to be 16,000.

Central and Eastern Asia.

In Bokhara (13,000), in Samarkand (10,000), in Merv, throughout Central Asia, Jews are scattered. The small colonies of Jews in Kai-fung-foo, Hansho, Ningpo, and Peking are regarded by the Chinese as a sect of Mahometans. They are termed Taou-Kin-Kedou ("separators of the sinew from the flesh"). These colonies, of ancient settlement, are not to be confounded with the European Jewish merchants, who under European protection now trade in the ports. The Jews of Kai-fung-foo have parted with their sacred scrolls, and their synagogues are ruined.

Arabia.

The Jews in Yemen have a long history, but the present Jewish population is stated by the latest observer (a correspondent of the Alliance Israélite, writing in 1881) to be only 15,000 in number. An older estimate (1876) made them number 200,000. They are chiefly found in Sanaa, the capital (where they are from 2000 to 3000 in number, and have thirteen synagogues under a Chacham Bashi), and also in the mountain villages. For upwards of eighty years the Jews of Sanaa have been the victims of repeated persecutions, false accusations, and exactions; and until twelve years ago to these were added the duties of scavengers and night-men, imposed even upon the rabbis, and not redeemable by money payments. The assumption of sovereignty by the Porte much improved their position. They are artisans, labourers, and merchants.

Africa.

Wealthy Jews reside at Cairo (3000), others at Alexandria (where the odious blood accusations were recently revived against them) and Port Said. There are in all about 8000 Jews in Egypt.

In Abyssinia are found the Falashas, whose Jewish descent is doubted by some ethnologists. See FALASHAS, and Halevy in *Misc. Soc. Heb. Lit.*, 2d ser., vol. ii., 1877.

The Jews in Tripoli are estimated at 100,000. Tunis is variously said to contain 40,000 or 60,000 Jews. Those in the ports are European, chiefly Spanish, in recent origin. In the interior Jews live in tents, carry on agriculture on a communal basis, dress like their neighbours, bear long matchlocks, and rove from place to place like them; many, however, are goldsmiths. They conform strictly to the Jewish ceremonial laws.

The number of the Jews in Morocco was stated by the deputation which petitioned the British foreign office on their behalf in 1880 to be 300,000. There are 1200 in Larache, 1400 in Alcazar, 6000 in Tetuan, 8000 in Tangiers. Many are of Spanish origin. Jews have frequently been chosen, in bygone times, to represent the sultan as envoys. They now suffer from the fanaticism of the Mahometans, and are compelled to go barefoot in sign of their submission in nearly all the cities. Robbers plunder them almost with impunity, and murders of Jews are frequent. About a hundred enjoy protection from Christian powers, which was confirmed at the conference of Madrid in 1880, but is impatiently submitted to by the sultan.

Jews in the interior or beyond the boundary of Morocco live a nomad life like the Jewish tribes of Arabia, and conduct caravans across the desert as far as Timbuctoo. Mardocheé, a member of the first Israelite family who settled in Timbuctoo, has described the Daggatoun (merchants), a tribe of Jews who have forgotten their religion, but cherish the tradition of their descent, and proclaim it by their fair complexions and the character of their features; they live in the Sahara in the midst of a Mussulman race, with whom they do not intermarry.

America.

There are several thousands of Jews in Brazil; a Dutch Jewish colony was founded at Savannas in Surinam, but has lost its distinc-

tive character; a few Jews are scattered in Mexico and the South American parts.

In the United States Jews are numerous, and enjoy full equality of rights and great material prosperity. A Jewish colony was founded by Judge Mordecai Noah, sheriff of New York, in 1825, at Grand Island in the Niagara river, but did not long endure. The Jews of the United States organize themselves in great friendly societies. Of these there are four principal orders—the B'nai Berith (Sons of the Covenant), which in 1878 had 22,814 members, had paid \$1,000,000 in benefits, and retained \$570,000 in hand; the Independent Order of Free Sons of Israel, with 8604 members; the Keaher shel Barzel (Iron Link), with 10,000 members and \$112,000; the Improved Order Free Sons of Israel, with 2849 members. Jewish hospitals, orphan asylums, free schools, benevolent institutions, exist in very many cities. The union of American congregations comprises 118 congregations, and has for its objects (1) to promote religious instruction, and (2) to co-operate with similar associations throughout the world to relieve and elevate oppressed Jews. Many ways of interpreting Scripture prevail among the Jews in the United States. Some keep Sabbath on Sunday, others pray in English without any use of Hebrew; there is much laxity in observance, but all sects agree in building magnificent synagogues. In 1878 there were in the United States 278 congregations with 12,546 members, owning in their corporate capacity real estate worth \$4,778,700 and other property worth \$1,860,030, sending 12,886 children to their schools, and forming a population of about 250,000.

Some further particulars may be given regarding the Jewish press. There are, according to Lippe, 86 Jewish periodicals, as follows:—18 in the Hebrew language, published at Vienna (2), Warsaw (2), Wilna, St Petersburg, Königsberg (2), Lyck (2), Mainz, Jerusalem (3), and 4 in Galicia (at Brody, Kolomea, Tarnopol, and Lemberg); 14 in Jüdisch-Deutsch, published at Vienna (2), Bucharest (3), Mainz, New York, Pressburg, Chicago, Königsberg, Lemberg, Budapest (2); 22 in German, published at Würzburg, Breslau, Berlin (4), Frankfurt-on-the-Main, Leipsic (3), Bromberg, Krottschin, Mainz, Magdeburg, Lemberg, Budapest (2), Melnik (Bohemia), Bilni (Bohemia), Vienna, Cincinnati, and Milwaukee; 4 in French (reckoning the bulletin of the Alliance as one) at Paris (3), Avignon; 14 in English, at London (2), New York (4), Cincinnati (2), San Francisco (partly in German), Chicago, Philadelphia, Atlanta, St Louis, and Melbourne; 3 in Italian, at Trieste, Casale Monferrato, and Corfu; 3 in Dutch, at Rotterdam (2), Amsterdam; 2 in Russian, both at St Petersburg; 2 in Polish, at Warsaw and Tarnopol in Galicia; 1 in Hungarian, at Budapest; 6 in Spanish (5 of them in Hebrew characters), at Vienna (2), Constantinople (2), Salonica, and Smyrna. In addition to these, Lippe gives 8 annuals:—1 in Roumanian at Bucharest, 1 in French at Paris, 1 in Russian at St Petersburg, 1 partly in German and partly in Hebrew at Bamberg, and 4 in German at Brody, Frankfurt-on-the-Main, Halberstadt and Prague. Two Jewish calendars appear annually in London.

From the numbers of the Jewish population which we have given it results that there are about 5,000,000 Jews in Europe. In Asia 200,000, in Africa 700,000, may be approximately correct totals, in America 300,000, in Australia 20,000. The total Jewish population of the world would thus be 6,200,000. It may be added that the vital statistics of the Jews differ a little from those of the nations with which they have been compared. The Jews have a somewhat greater average longevity, which is attributed to their abstinence, comparative freedom from phthisis, &c., and to their not often following employments which shorten life. Their dietary laws and ceremonial abolutions have an influence in preserving them from epidemics.

*Literature.*—Graetz, *Geschichte der Juden*; Cassel, *Lehrbuch der Jüdischen Geschichte und Literatur*; Jost, *Geschichte der Israeliten*, and *Gesch. des Judenthums*; Stern, *Gesch. des Judenthums von Mendelsohn bis auf die Gegenwart*; Rieck, *Gesch. des jüdischen Volkes*; Kayserling, *Menasseh b. Israel, und Juden in Portugal*; Mendelssohn, *Gesammelte Schriften*; Loewenstein, *Damascia*; Lippe, *Cassel, Juden-Gesch.*; Gelger (Ludwig), *Gesch. der Juden in Königsberg*; Giedemann, *Gesch. der Juden in Magdeburg*; Haarblicher, *Gesch. der Juden in Berlin*; Giedemann, *Gemeinde in Hamburg*; Jolowicz, *Gesch. der Juden in Königsberg*; Giedemann, *Gesch. der Juden in Posen*; Wolf, *Gesch. der Juden in Worms u. Wien*; Auerbach, *Gesch. der isr. Gemeinde z. Halberstadt*; Donath, *Gesch. der Juden in Merseburg*; Engelbert, *Statistik der Juden im deutschen Reich*; Schimmer, *Statistik der Juden in den Oesterreichischen Ländern*; Friedländer, *Zur Gesch. der Juden in Wilna*; Schulman, *Toldot Chachme Israel*; Bédarride, *Les Juifs en France, en Italie et en Espagne*; Carmoly, *La France Israélite*; Loeb, *Albert Cohn, Situation en Serbie en Roumanie*; Beugnot, *Les Juifs d'Occident*; Hollandaiski, *Les Israélites de Pologne*; Halphen, *Recueil des Lois concernant les Israélites*; Collection des actes de l'Assemblée des Israélites; Detchéverry, *Israélites de Bordeaux*; Mardocheé, *Les Daggatoun*; Saphir, *Travels*; Milman, *History of the Jews*; Picciotto, *Sketches of Anglo-Jewish History*; Sydney Samuels, *History of the Jews* (reprinted from Jewish Chronicle); Morais, *Eminent Israelites of 19th Century*; Davis, *Jews in Roumania*; Koenen, *Eminent Israelites of 19th Century*; Davis, *Jews in England*; Koenen, *Society of Hebrew Literature*; *Misc. Heb. Lit.*, i., ii.; Archives of the Spanish and Portuguese Jews' synagogue, London (MS.); Hermann Adler, *Jews in England*; Koenen, *Geschiedenis de Joden*; J. Miller and A. Löwy, in *Tr. Soc. Bib. Arch.*, 1876; Reports of Anglo-Jewish Association, Alliance Israélite, Board of Deputies, Union of American Hebrew Congregations, Allianz in Wien, &c.; Jewish newspapers (see list in Lippe). (I. D.)

The leader of the most advanced school is Dr Felix Adler, who, in his discourses, *Creed and Deed*, advocates the supersession of religion by ethical culture.



**JEW'S HARP**, or **JEW'S TRUMP** (Fr. *Trompe*), a small musical instrument, known for centuries all over Europe, and consisting of a metal frame with two branches, between which a slender tongue of steel, fastened at one end, and free at the other, is made to vibrate by twitching with the finger, while the frame is held between the teeth. The English name "Jew's harp," seems to be merely a corruption of the French words *jeu* and *trompe*. Prefixed to the Rev. Patrick Macdonald's *Collection of Highland Airs* (1781) is a dissertation by the Rev. Walter Young, in which he states that the natives of the island of St Kilda, "being great lovers of dancing, have a number of reels, which are either sung, or played on the Jew's harp or trump, their only musical instrument" (p. 11). In the Himalaya journals one of the travellers mentions that he procured a Jew's harp from Tibet. At the commencement of the present century this instrument was improved, and several Jew's harps were combined, it being thus possible by using several instruments in different keys to obtain a complete scale. Eulenstein, a native of Würtemberg, made a sensation in London in 1827 by playing on no less than sixteen Jew's harps. No. 30 of the *Leipsic Musical Gazette* (1816) contains an account of the compound Jew's harp, with pieces of music suited for it.

**JEYPORE**, or **JÁIPUR**, a native state in Rájputána, under the political superintendence of the Rájputána agency and the Government of India, lies between 25° 41' and 28° 27' N. lat. and between 74° 55' and 77° 15' E. long. It is bounded on the N. by Bikauer, Loháru Jhajar, and Patála; on the E. by Alwar, Bhartpur, and Karáli; on the S. by Gwalior, Bundi, Tonk, and Údáipur; on the W. by Kishangarh, Jodhpur, and Bikaner. Its area is 14,465 square miles. The country is tolerably level and open, although its surface is diversified by groups and ranges of hills and by isolated peaks. The centre of the state is an elevated triangular table-land from 1400 to 1600 feet above sea-level, whose eastern limit is formed by ranges running north and south. On the north and west it is bounded by a broken chain of hills, an offshoot from the Aravalli mountains, which forms the apex of the triangle. To the east, beyond the hills, the country becomes gradually more open as it spreads out towards the alluvial flats of the Jumna. On the north-west stretches the sandy and desert tract of Shaikhawati (or the country of the Shaikhawati clan). The general drainage of Jeypore from the central table-land is to the east and south-east, though a few streams follow the slope to the north-west. Those flowing south are the Banás and the Bangangá, the tributary of the Jumna, and their tributaries, the Amanisháh, Bándi, Moril, Dúnd, and Khari. The Sabi and Kátli flow north. In the south of the state, water is everywhere found at a depth varying from a few feet to 30 or 40 feet; but in Shaikhawati water is always at a great depth, averaging from 80 to 100 feet. The soil is generally sandy. The hills are more or less covered with jungle trees, of no value except for fuel. The hill ranges are said to consist in the north chiefly of granite, and in the south and east of sandstones, mixed sometimes with white and black marble, and occasionally with mica. Copper ore and cobalt are found. Salt is largely manufactured and exported from the Sambhar Lake, the average yearly turn-out amounting to nearly 40,000 tons.

In Shaikhawati there is generally but one crop in the year, consisting chiefly of *bájra*, *mung*, and *moth*. In the north, besides these, a little wheat and barley are grown. Towards the south and east, as the soil becomes richer and firmer, *jóár*, Indian corn, cotton, *tíl*, wheat, barley, gram, sugar-cane, opium, tobacco, *dál*, and linseed are extensively grown. Since 1868 the state has spent £5000 annually on irrigation.

In the absence of a census the population has been roughly estimated at about 1½ millions for the whole territory, with the following proportions of the various classes:—Rájputs,  $\frac{1}{2}$ ; Hindus,  $\frac{1}{2}$ ; Mahometans,  $\frac{1}{10}$ ; Jains  $\frac{1}{10}$ . The most notable feature in the commerce of the state is the large banking and exchange business carried on at the capital and in the large towns. The chief manufactures are marble sculpture, enamel work done on gold, woollen cloths and fabrics. Education has made great progress in the state. Jeypore city is the site of a college, with a daily attendance (1876) of 800 students; also of a school for the sons of thakurs and higher officials, and a Sanskrit college and industrial school. In the district there are 33 elementary schools, wholly supported by the state, and 379 indigenous schools, with an aggregate attendance of nearly 8000. The coins minted at Jeypore are distinguished from those of other independent states by the *ghar* or sprig on the reverse. The Rájputána State Railway on the metre gauge runs from Agra to Jeypore city, and thence to Ajmir and Nusserabad. The military force of the state consists of 824 artillerymen, 4450 cavalry, and 15,858 infantry. The number of forts is 38, with an aggregate of 220 guns of all calibres. Some £700,000 from the revenues of the state are alienated in *yágrs* and religion grants, but the available receipts are about £475,000. The climate is dry and healthy. The average temperature, taken from a record of five years, is 81° Fahr. The average rainfall is 25½ inches.

The maharájá of Jeypore belongs to the Kachhwha tribe of Rájputs, and claims descent from Rána, king of Ajodhya in Oudh. Jeypore state was founded in 967 by Dhola Ráo, who, along with his Kachhwhas, is said to have absorbed or driven out the petty chiefs. On the irruption of the Mahometans, Jeypore state had very soon to succumb to them, and the Jeypore house furnished some of their most distinguished generals. Among them were Mám Sinh, who fought in Orissa and Assam, Jái Sinh, commonly known by his imperial title of Mirza Rájá, whose name appears in all the wars of Aurangzeb in the Deccan, and Jái Sinh II., the famous mathematician and astronomer, and the founder of Jeypore city. Towards the end of the 18th century the Jits of Bhartpur annexed a portion of the state. The chief of Alwar reduced the territory of Jeypore. By the end of the century the state was in great confusion, distracted by internal broils, and impoverished by the exactions of the Marhattás. The disputes between the chiefs of Jeypore and Jodhpur had brought both states to the verge of ruin, and Amír Khán, with the Pindhárís, was exhausting the country. By a treaty in 1818 the protection of the British was extended to Jeypore, and an annual tribute fixed. In 1835, on the accession of the maharájá, then two years old, there was a serious disturbance in the city, after which the British Government took measures to insist upon order, and to reform administration as well as to support its effective action; and the state has become gradually well governed and prosperous. When the mutiny broke out in 1857, the maharájá assisted the British in every way that lay in his power.

**JEYPORE**, or **JÁIPUR**, capital of the state of the same name, is situated in 26° 55' N. lat. and 75° 52' E. long., on the Rájputána State Railway and the Agra and Ajmere trunk road. It is the largest town and the chief commercial centre of Rájputána, and in many respects the finest of modern Hindu cities. The city, which takes its name (Jáinagar or Jáipur) from the famous Maharájá Siwái Jái Sinh II., by whom it was founded in 1728, stands on a small plain surrounded on all sides except the south by rugged hills, the summits of which are at all important points crowned with forts. At the end of the ridge, overhanging the city on the north-west, is the chief defensive work, the *Nahargarh*, or "Tiger Fort," the rock face of which is so scarped as to be inaccessible on the south or city side. Jeypore is remarkable for the regularity and wideness of its streets, and the architectural beauty of the mosques, temples, and private residences which adorn them. From east to west the town is a little over 2 miles in length, with a breadth of about 1½ miles. The main streets are paved, and the city is lighted by gas. The houses of the nobility and the citizens are in the suburbs, while the maharájá's palace with its pleasure-grounds occupies the centre of the town. In Jeypore there are as many as seven banking firms, whose aggregate annual business amounts to about £2,500,000, and which possess a capital of upwards of £6,000,000 sterling. Besides these, there are several minor houses, whose collective business may be estimated at £500,000 a year. Exchange and banking form the greater portion of the business of

the place. The city is well provided with hospitals, dispensaries, alms-houses, and schools. One of the most interesting antiquities of the state is the Hindu observatory in the capital, erected by the founder of the city.<sup>1</sup> The population in 1870 was 137,847.

**JEZREEL** (צֶרְעֵל), the well-known capital of the Israelite monarchy under Ahab. Its site has never been lost, and the present village *Zer'in* retains the name radically unchanged. In Greek the name appears under the form Ἐσδραῖά (*Strudelu* in the *Itiner. Hieros.*); and to the crusaders the place was known as Parvum Gerinum. The modern village stands at the north extremity of a long ledge terminating in steep cliffs forming part of the chain of Mount Gilboa, east of the plain of Esdraelon. The top of the swell is 500 feet above the broad northern valley; the knoll on which the stone village is built is bare and rocky; the buildings are apparently modern, but numerous ancient cisterns and scattered sarcophagi, lying on the hill side, mark the antiquity of the site. The view over the plains from Beisan on the east to Carmel on the west, and from the Samaritan hills on the south to the mountains of Galilee on the north, is fine and extensive. No vineyards now exist, but rock-cut wine presses occur east of the village, perhaps marking the site of Naboth's vineyard (1 Kings xxi. 1). The fountain mentioned in the Bible (1 Sam. xxix. 1) is very probably the fine spring 'Ain el Meiyeth north of the village, a shallow pool of good water full of small fish, rising between black basalt boulders. A very large spring, 'Ain Jahud or Jahut (Yakut, iii. 760), exists in the valley of Jezreel (Josh. xvii. 16) north of the hill. A second city called Jezreel existed in the tribe of Judah, somewhere near Hebron (Josh. xv. 56).

**JHĀLĀWĀR**, a state in Rājputāna, under the political superintendence of the Rājputāna agency and the Government of India, mainly consisting of two separate areas. The larger is bounded on the N. by the state of Kotah; on the E. by Sindhia's territory and a detached district of the Tonk state; on the S. by the petty state of Rājgarh, a detached district of the Dewas state, and the state of Jaora; and on the W. by detached tracts belonging to Sindhia and Holkar. This portion lies between 23° 48' and 24° 48' N. lat., and between 75° 55' and 77° E. long. The lesser detached area is bounded on the N., E., and S. by the Gwalior state, and on the W. by Kotah, and lies between 25° 5' and 25° 25' N. lat., and 76° 55' and 77° 25' E. long. The main portion of Jhālāwār is situated on a raised plateau. The northern, eastern, and part of the southern portions are very hilly, and intersected by numerous streams. The hills are for the most part covered with timber and grass, and frequently enclose lakes. The rest of this tract is a rich undulating plain, dotted with evergreen trees. The soil generally is very rich, consisting in great part of dark clayey mould, which produces valuable crops. Of the many streams running through the territory, the most important are—the Parwan, with its tributary the Newāj; the Kāli Sind, with its tributary the Aū; and the Chhōta Kāli Sind. The population in 1875 was 226,000, of whom the majority were Hindus. The area of the whole state is 2500 square miles.

In Jhālāwār all the ordinary Indian grains are cultivated, and in the southern districts opium is extensively grown. In the rest of the state wheat and opium are the chief crops, except in Shāhābād,

where *bajra* is chiefly produced. Irrigation is principally carried on by means of wells. Near Jhālra Patan, the capital, there is a large artificial lake, from which water is drawn by a channel 2 miles long. In 1876, 507,418 acres, or barely two-fifths of the total area, were cultivated. The total revenue for 1876 was £174,719. The police number 100 horse and 2000 foot. Education is at present very backward in the state. In the districts the village priest teaches the young people. In the capital and cantonment there are schools in which Hindī, Urdu, and English are taught. The only metalled roads in the state are in the cantonment. All other roads are simply cart tracks, which in the rains are useless for wheel traffic. Opium is exported; the imports are English cloths and grain. The chief towns are Jhālra Patan and the chhāoni or cantonment, Shāhābād, and Kailwara. The climate resembles that of Central India, and is generally healthy. In the hot weather the thermometer ranges during the day from 85° to 88° Fahr. The temperature during the rains is cool and pleasant, and in the cold weather it is occasionally frosty.

The ruling family of Jhālāwār belongs to the Jhālā clan of Rājputs, and their ancestors were petty chiefs of Halwad in the district of Jhālāwār, in Kāthiāwār. About 1709 one of the younger sons of the head of the clan left his country with his son to try his fortunes at Delhi. At Kotah he left his son Madhu Sinh, who soon got into great favour with the mahārājā, and got from him an important post, which became hereditary. On the death of one of the Kotah rājās, the country was left to the charge of Zalim Sinh, a descendant of Madhu Sinh. From that time Zalim Sinh was the real ruler of Kotah. He brought it to a wonderful state of prosperity, and under his administration, which lasted over forty-five years, the Kotah territory was respected by all parties. In 1838 it was resolved, with the consent of the chief of Kotah, to dismember the state, and to create the new principality of Jhālāwār as a separate provision for the descendants of Zalim Sinh. The districts then severed from Kotah were considered to represent one-third (£120,000) of the income of Kotah; by treaty they acknowledged the supremacy of the British, and agreed to pay an annual tribute of £8000. Madan Sinh received the title of mahārājā rānā, and was placed on the same footing as the other chiefs in Rājputāna. The present mahārājā rānā of Jhālāwār has a force of 20 field and 75 other guns, 150 artillerymen, 425 cavalry, and 4400 infantry.

**JHANG**, a British district in the lieutenant-governorship of the Punjab, India, between 30° 35' and 32° 4' N. lat., and between 71° 39' and 73° 38' E. long., with an area of 5712 square miles. It forms the northern district of the Mūltān division, and is bounded on the N. by Shāhpur and Gujrānwāla, on the W. by Derā Ismāil Khān, and on the S.E. by Montgomery. It comprises an irregular triangle, artificially constituted for administrative purposes from portions of three separate tracts. Its eastern half embraces a large part of the high dorsal bridge in the Rechna Doāb; thence it stretches across the Chenab into the wedge of land between that stream and the Jhelum, whose waters unite a few miles below the town of Jhang; while westward again the boundary runs beyond the joint river, far into the heart of the Sind Sāgar Doāb. The Ravi also bounds the district for a few miles along its southern edge. So artificial a tract can hardly be said to possess any common natural features of its own. Along the banks of the river strips of comparatively fertile lowland support a dense population.

At the census of 1868 the population was 348,027 (193,624 males and 154,403 females). The Mahometans numbered 270,819; Hindus, 57,297; Sikhs, 2994; and "others," 16,917. Only three towns contain a population exceeding 5000—Jhang, 9124; Maghāna, 10,525; and Chinot, 11,477. The area under cultivation in 1873 amounted to 241,325 acres, out of an assessed total of 3,650,867 acres. No crops can anywhere be grown without irrigation. Wheat, barley, gram, *sarson*, *chima*, *joār*, maize, and cotton form the staples of the district. Grain is imported. Country cloth is manufactured at Jhang and Maghāna, and bought up by the Poindah merchants of Afghanistan. Manufactures of gold and silver lace also exist. The principal road from Mūltān to Wazirābād passes through the chief towns in the district. A bridge of boats is in course of construction (1875) across the united stream of the Jhelum and the Chenab. Both rivers are navigable. The total revenue for 1873 was £49,302. The police force in 1872 numbered 503 men. In 1872 there were 32 Government and 123 native schools, with a joint roll of 3696 pupils. The district bears a good reputation for healthiness. Small-pox and fever form the most prevalent diseases. The average rainfall for the seven years ending 1872-73 was 10 inches. There are seven charitable dispensaries.

<sup>1</sup> On the summit of a range of hills, about a mile and a half east of Jeypore town, is a sacred shrine called the "Gulta," where there is a temple dedicated to "Surya," or the Sun-god. Below the platform a spring issues, which pours over the rock by a fall of 70 feet into the valley below. The water of this spring is considered peculiarly sacred by the Brāhmins.



The district of Jhang possesses unusual historical interest from the presence within its borders of the ruins which crown the rocky eminence of Sānglavāla Tība. This site has been identified with the Sākala of the Brāhmins, the Sigal of Buddhism, and the Sāngala of Alexander's historians. In modern times the history of Jhang centres in the famous family of Sials, who exercised an extensive sway over a large tract between Shāhpur and Mūltān, with little dependence on the imperial court at Delhi, until they finally fell before the all-absorbing power of Ranjit Sinh. The Sials of Jhang are Mahometans of Rajput descent, whose ancestor, Rai Shankar of Dāranagar, emigrated early in the 13th century from the Gangetic Doāb to Jaunpur. In the beginning of the present century the mahārāja Ranjit Sinh invaded Jhang, and captured the Sial chieftain's territories. He recovered a small portion afterwards, which he was allowed to retain on payment of a yearly tribute. In 1847, after the establishment of the British agency at Lahore, the district came under the charge of the British Government; and in 1848 Ismāil Khān, the Sial leader, rendered important services against the rebel chiefs, for which he received a pension. During the mutiny of 1857 the Sial leader again proved his loyalty by serving in person on the British side. His pension was afterwards increased, and he obtained the title of Khān Bahādūr, with a small *jāgir* for life.

**JHANG**, a municipal town in the above district. The sister town of Maghāna, containing the civil station for the district, lies 3 miles south of Jhang, and has a population of 10,525 persons. They form together a single municipality, and may be regarded as practically one town, situated in 31° 16' 16" N. lat., and 72° 21' 45" E. long., about 3½ miles to the west of the present bed of the Chenab. Jhang itself lies on the lowland, a little apart from the regular lines of trade, and since the removal of the Government offices to Maghāna, has yielded its commerce and importance to its younger rival. Founded by Mal Khān, a Sial chieftain, in 1462, it long formed the capital of a native Mahometan state. The population of Jhang proper in 1868 was 9124, comprising 4568 Hindus, 4244 Mahometans, 129 Sikhs, 12 Christians, and 171 "others." Population of the united towns, 19,649.

**JHĀNSI**, a British district in the lieutenant-governorship of the North-Western Provinces, India, between 25° 3' 45" and 25° 48' 45" N. lat., and between 78° 21' 15" and 79° 27' 30" E. long. It forms the central district in the division<sup>1</sup> of the same name, and is bounded on the N. by the Gwalior and Samthar states, on the E. by the river Dhasān, on the S. by the district of Lalitpur and the Orchha state, and on the W. by the Datiyā, Gwalior, and Khaniya Dānā states. Jhānsi forms a portion of the hill country of Bundelkhand, sloping down from the outliers of the Vindhyan range on the south to the tributaries of the Jumna on the north. The extreme south is composed of parallel rows of long and narrow-ridged hills. Through the intervening valleys the rivers of the district flow down impetuously over ledges of granite or quartz. North of the hilly region, the rocky granite chains gradually lose themselves in clusters of smaller hills. The northern portion consists of the level plain of Bundelkhand, distinguished for its deep black soil, known as *mār*, and admirably adapted for the cultivation of cotton. The district is intersected or bounded by three principal rivers—the Pabūj, Betwa, and Dhasān. There are many minor streams, most of which are feeders of the Dhasān. The district is much cut up, and portions of it are insulated by the surrounding native states.

The census of 1872, taken over an area of 1567 square miles, returned a population of 317,826, of whom (exclusive of non-Asiatics) 167,519 were males and 150,216 females. As regards religion, 305,151 were Hindus, while only 12,417 were Mahometans. Five towns have a population exceeding 5000:—Alhwa, 15,065; Rānipur, 6326; Gārsani, 5897; Barwa Sagar, 5556; and Bhānder, 5141. Jhānsi, in the nature of its soil, the character of its people, the poor

means of irrigation, and the want of good communication, is worse off than any other district in the North-Western Provinces, except Lalitpur. Out of a total area of 1,002,734 acres, only 428,348 acres were under cultivation. The principal crops are *jaṛ*, *bājra*, cotton, *tīli* or oilseed, *kodon* (a kind of pulse), wheat, gram, and barley. The most important product is the *al dye*, procured from the root of the *Morinda citrifolia*, which is only dug up every third year. The destructive *kāns* grass has proved as great a pest here as elsewhere in Bundelkhand. Jhānsi is specially exposed to blights, droughts, floods, hailstorms, epidemics, and their natural consequence—famine. It is considered that famine may be feared on an average every five years. The district imports grain, and in return exports the *al dye* and cotton. The 110 schools in 1870 taught 2235 pupils at a cost of £1247. The climate is hot and very dry, but not unhealthy. The mean annual temperature for 1871 was 81°·7 Fahr. The average rainfall for the ten years ending 1870 was 31 inches. The population are habitually underfed, and consequently succumb readily to slight diseases.

Nothing is known with certainty as to the history of this district before the period of Chandel rule, about the 11th century of our era. To this epoch must be referred the artificial reservoirs and architectural remains of the hilly region. The Chandels were succeeded by their servants the Khāngars, who built the fort of Karār, lying just outside the British lines. About the 14th century the Bundelas poured down upon the plains, and gradually spread themselves over the whole region which now bears their name. The Mahometan *subahdars* were constantly making irruptions into the Bundela country; and in 1732 Chhatarsāl, the Bundela chieftain, called in the aid of the Marhattās. They came to his assistance with their accustomed promptitude, and were rewarded, on the rājā's death in 1734, by one-third of his dominions. Their general founded the city of Jhānsi, and peopled it with inhabitants from Orchha state. In 1806 the British protection was promised to the Marhattā viceroy, and in 1814 the peshwā ceded to the East India Company his rights over Bundelkhand. In 1853 Gangadhar Rao died childless, and his territories lapsed to the British. The Jhānsi state and the Jalān and Chandel districts were then formed into a superintendency. The widow of the late rājā considered herself aggrieved because she was not allowed to adopt an heir, and because the slaughter of cattle was permitted in the Jhānsi territory. Reports were spread which excited the religious prejudices of the Hindus. The events of 1857 accordingly found Jhānsi ripe for mutiny. In June a few men of the 12th native infantry seized the fort containing the treasure and magazine, and massacred the European officers of the garrison. Everywhere the usual anarchic quarrels rose among the rebels, and the country was plundered mercilessly. The rani put herself at the head of the rebels, and died bravely in battle. It was not till November 1858, after a series of sharp contests with various guerilla leaders, that the work of reorganization was fairly set on foot. Since that time Jhānsi has remained a British district, and famines and floods alone have disturbed the prosperous course of civil administration.

**JHĀNSI**, a city and fort in Gwalior state, North-Western Provinces, India, in 25° 27' 30" N. lat. and 78° 37' E. long. A stone fort crowns a neighbouring rock, and commands the town, as well as the British outpost, Jhānsi Naoābād, which adjoins the city. It lapsed to the British in 1853, and during the mutiny was the scene of insurrection and massacre. In 1861 the town, fort, and surrounding territory beyond the Pabūj were handed over to Gwalior state. The administrative headquarters of Jhānsi district is Jhānsi Naoābād, which had a population in 1872 of 536 persons. The estimated population of Jhānsi proper is 30,000.

**JHELMUM**, or **JHĪLAM**, a district in the lieutenant-governorship of the Punjab, India, between 32° 26' and 33° 15' N. lat., and between 71° 51' and 73° 50' E. long., bounded on the N. by Rāwal Pindi district, E by the Jhelum river, S. by Shālpur district, and W. by Bannu district. It forms the south-eastern portion of a rugged Himālayan spur, extending between the Indus and Jhelum to the borders of the Sind Sāgar Doāb. Its scenery is very picturesque, although not of so wild a character as the mountain region of Rāwal Pindi to the north, and is lighted up in places by smiling patches of cultivated valley. The backbone of the district is formed by the Salt Range, a treble line of parallel hills running in three long forks from east to west throughout its whole breadth. The range rises in bold and striking precipices, broken by gorges,

<sup>1</sup> The division of Jhānsi is under a commissioner in the North-Western Provinces, and comprises the three districts of Jhānsi, Jalān, and Lalitpur, which contain a large portion of the tract known as Bundelkhand. The area in 1872 was 5067 square miles, the population 934,943.

clothed with green brushwood and traversed by trickling streams, at first pure and fresh, but soon impregnated with the saline matter over which they pass. Between the line of hills lies a picturesque table-land, in which the beautiful little lake of Kallar Kahár nestles amongst the minor ridges. North of the Salt Range, the country extends upwards in an elevated plateau, diversified by countless ravines and fissures, until it loses itself in the tangled masses of the Ráwal Pindí mountains. In this rugged tract cultivation is rare and difficult, the soil being choked with saline matter. At the foot of the Salt Hills, however, lies a small strip of level soil, lying along the banks of the Jhelum, and thickly dotted with prosperous villages. The drainage of the district is determined by a low central watershed running north and south at right angles to the Salt Range. The waters of the western portion find their way into the Sobán, and finally into the Indus; these of the opposite slope collect themselves into small torrents, and empty themselves into the Jhelum.

The census of 1868 returned the population of Jhelum district at 500,988, inhabiting 113,010 houses, and spread over an area of 3910 square miles. The Mahometans numbered 434,157; Hindus, 49,111; Sikhs, 13,865; and "others," 3855. Five towns contained in 1868 a population exceeding 5000:—Pind Dálan Khán, 15,740; Chakwál, 5767; Taligang, 5767; Lawa, 5256; and Jhelum, 5148. Of a total area of 2,502,290 acres, but 763,845 acres are under cultivation, and only 258,825 acres more are returned as capable of tillage. The staple crops are wheat and *bajra*. Trade is chiefly concentrated in the town of Pind Dálan Khán. The exports are salt, silk and cotton goods, brass and copper wares; the imports, English piece goods and metals, and woollen fabrics from Kashmir and from Central Asia *via* Pesháwar. Salt is procured in immense quantities from the central hills of the Salt Range; the net revenue from this source in 1871-72 amounted to £362,193. The total revenue in 1872-73, excluding salt, was £70,299, of which £59,766 was derived from the land tax. The police force consisted in 1873 of 527 men. For fiscal and administrative purposes the district is subdivided into 4 *tahsils* and 10 *parganas*, containing 939 estates, and owned by 49,866 proprietors.

The history of the district dates back from the semi-mythical period of the *Mahábhárata*. Hindu tradition represents the Salt Range as the refuge of the five Pándava brethren during the period of their exile, and every salient point in its scenery is connected with some legend of the national heroes. Modern research has fixed the site of the conflict between Alexander and Porus as within Jhelum district, although the exact point at which the Macedonian king effected the passage of the Jhelum (or Hydaspes) is disputed. After this event, we have little information with regard to the condition of the district until the Mahometan conquest brought back literature and history to Upper India. The Jaujáh and Játs, who now hold the Salt Range and its northern plateau respectively, appear to have been the earliest inhabitants. The Ghakkars seem to represent an early wave of conquest from the east, and they still inhabit the whole eastern slope of the district; while the Awans, who now cluster in the western plain, are apparently later invaders from the opposite quarter. The Ghakkars were the dominant race at the period of the first Mahometan incursions, and long continued to retain their independence. During the flourishing period of the Mughal dynasty, the Ghakkar chieftains were among the most prosperous and loyal vassals of the house of Bábúr; but after the collapse of the Delhi empire Jhelum fell, like its neighbours, under the sway of the Sikhs. In 1765 Gújar Sính defeated the last independent Ghakkar prince, and reduced the wild mountaineers to subjection. His son succeeded to his dominions, until 1810, when he fell before the irresistible power of Ranjít Sính. In 1849 the district passed, with the rest of the Sikh territories, into the hands of the British. Ranjít Sính, however, had so thoroughly subjugated the wild mountain tribes that little difficulty was experienced in reducing it to working order, and the subsequent history of Jhelum has been purely fiscal and administrative.

JHELUM, the headquarters of the above district, situated on the north bank of the Jhelum river, in 32° 55' 26" N. lat. and 73° 46' 36" E. long. The town is quite of modern origin, and in 1868 contained a population of 5148, viz., Mahometans, 2831; Hindus, 1858; Sikhs, 442; Christians, 3; and "others," 14. The civil lines and cantonments for a regiment of native infantry lie about a mile north of the town, which is noted for boat building.

JHIND, or JIND, a native state in the Pannjab, India, consisting of three or four isolated tracts to the east of the Sutlej. The area is 1236 square miles, and the estimated population 311,000. The principality was founded in 1763 by a Sikh of the Sidhu Jat tribe, and the chief was recognized as rájá by the Mughal emperor in 1768. The family have always been loyal supporters of the British Government. On the overthrow of the Marhattá power in northern India in 1804-5, the Jhind rájá was among the foremost to tender his allegiance to Lord Lake, who confirmed him in the possession of the estates he had held under the Mughal emperors and the Marhattás. After the Sutlej campaign a further grant of land was awarded the chief in recognition of his services. In 1857 Rájá Swarúp Sính of Jhind was the first to march against the mutineers at Delhi. His troops acted as the vanguard of the army, and he himself remained in the British camp until the reoccupation of the city, a portion of his soldiers aiding in the assault. For these services he received a grant of additional territory, yielding £11,681 per annum. The rájá enjoys an estimated revenue of between £60,000 and £70,000, and maintains a force of 10 guns, 79 artillerymen, 200 cavalry, and 1600 infantry. No tribute is paid by the state, but a contingent of twenty-five horsemen is furnished to the British Government.

JIDDAH, or JUDDAH,<sup>1</sup> also written Jeddah, Djiddah, or Djeddah, a town of Arabia, on the eastern coast of the Red Sea, in 21° 28' N. lat. and 39° 17' E. long., is of importance mainly as the principal landing-place of the pilgrims to Mecca. Its distance from that city is estimated at 44 or 46 miles. Built on a slight eminence, with a purple background of distant hills, Jiddah as seen from the sea presents an attractive aspect. The white tower-like houses, fancifully enriched with balconies, cornices, and lattices of rich-toned woodwork, shine out from an environment of grey sand and blue-green sea with startling effect. The town extends along the beach for about a mile, and is surrounded by a high wall of modern date and in bad repair, with towers at intervals. At the northern end of the sea-face stand the prison and other public buildings, and at the southern end a small fort no longer available for the defence of the harbour. There are three landward gates, the Mecca gate to the east, through which all caravans pass; and where toll is levied on the transit of camels, the Medina gate to the north, and the Yemen gate to the south. In front of the Mecca gate is a rambling suburb, with shops, coffeehouses, and an open market-place. Before the Medina gate are the Turkish barracks, and beyond them the great holy place of Jiddah, the singular tomb of "our mother Eve," surrounded by the principal cemetery.

The tomb is a walled enclosure said to represent the dimensions of the body, about two hundred paces long and 15 feet broad. At the head is a small erection where gifts are deposited, and rather more than half-way down a whitewashed dome encloses a small dark chapel within which is the black stone known as *El-surráh*, the navel. The grave of Eve is mentioned by Edrisi, but except the black stone nothing bears any aspect of antiquity. Further details in Burton's *Pilgrimage*, vol. ii. p. 298, and a view in Mrs. Burton's *A. E. I.* 41

Beyond the immediate suburbs the country as far as the foot of the hill is desert, with scanty pasturage and a few villages of Arab huts. The inhabitants (Harb, Huteym, Zebeid) are engaged in camel transport, slave running, and mother of pearl fishery.

The town itself, which consists of four quarters, is well built, with a good bazaar and many lofty and spacious houses, built of the madreporé rock of the district. The best dwellings are near the Medina gate; the mosques are not remarkable, and the streets are narrow and in part very filthy. The wretched huts which formerly occupied part

<sup>1</sup> The form Juddah has the authority of Yákit, but is not now used.



of the enceinte have been almost entirely removed since the frightful outbreak of cholera among the pilgrims in 1864-65, and the lowest strata of the population now occupy a village without the walls. The sanitary condition of Jiddah still, however, leaves much to be desired, especially in the pilgrim season. The chief defect is the scanty water supply derived from cisterns and wells outside the town. A conduit from the hills has been projected, and would yield a copious stream of excellent water, but the scheme is opposed by the owners of the cisterns, who drive a lucrative trade, a camel-load of water (16 skins of about 7 pints each) costing as much as sixteenpence, or after protracted drought much more. The permanent population of Jiddah is very variously estimated. Mr Beyts (*Consular Reports*, 1875) places it at 30,000, including 2000 Indian settlers, 100 Greeks, Syrians, and Maltese, and 25 Franks; but the Dutch consul in 1879 allows a total of 15,000 only. The native population is of very mixed blood.

Jiddah is said to have been founded by Persian merchants in the caliphate of Othman, but its great commercial prosperity dates from the beginning of the 15th century, when it became the centre of trade between Egypt and India. Down to the time of Burckhardt the Suez ships went no farther than Jiddah, where they were met by Indian vessels. The introduction of steamers in the Red Sea has deprived Jiddah of its place as an emporium not only for Indian goods but for the products of the Red Sea, which formerly were collected here, but are now largely exported direct by steamer from Hodeida, Suákin, and other ports, though coffee from Yemen and gums from the African coast still pass in considerable quantities through the hands of the Jiddah merchants. The chief exports apart from these are mother of pearl (fished by slave divers) and hides. The chief local manufactures are a coarse cotton fabric, embroideries in gold and silver, lacquer work, beads in black coral, and the like. Boat-building is carried on with great skill. The baggalas of from 50 to 60 tons are built of East Indian wood, and are excellent sailers. The imports of Jiddah are considerable, as the town supplies the interior not only with manufactured goods but with grain and other provisions. See full details of the trade in a valuable paper by the Dutch consul, Mr Kruyt, in *Tijdsch. v. h. Aardr. Genootschap* (Amsterdam, 1880, No. 5). The total exports and imports for 1879 are valued at £2,204,030. In the same year the port was visited by 421 steamships (213,295 tons) and 1156 sailing vessels (55,932 tons). The harbour is not convenient of access, but the roadstead when entered is well protected by coral reefs.

The introduction of steam traffic, while fatal to other local interests, has given a great impulse to the pilgrim trade, which is now regarded as the annual harvest of Jiddah. The pilgrim steamers are usually chartered by European merchants in conjunction with native capitalists and persons of religious influence. The average number of pilgrims annually landed at the port is not much short of 40,000. For 1879 Mr Kruyt enumerates 7995 Turks, 2286 from the Barbary states, 3459 Egyptians, 8787 Malaysians and Javanese, 10,894 Indians, 3506 Persians, 3300 Arabs from Yemen, the Súdán, and other places.

In the early years of the present century Jiddah resisted with success repeated attacks of the Wahhábités, and remained in the hands of the grand sheriff when he had lost the rest of the Hijáz. It was governed by Egypt during the Arabian wars of Mehemet Ali, but since 1840 has been again occupied by the Turks. There is a Turkish *caim-macam* under the wály of the Hijáz and a Turkish *cadí*, but the sheriff through his resident agent exercises an authority practically superior to that of these officials. In 1858 the attempts of England to suppress the slave

trade and a supposed insult to the Ottoman flag led to a plot to murder all the Christians in town, which was executed with fatal success (15th June), the English consul Page and the French consul Evéillard being among the victims. This outrage was followed by the bombardment of the town by the English man-of-war "Cyclops," and the authorities were compelled publicly to execute the Turkish governor and two leading citizens involved in the plot.

For further details see, in addition to the works already cited, Niebuhr's *Voyage*; Burckhardt's *Travels in Arabia*, vol. i., London, 1829; Von Maltzan's *Reise nach Südarabien*, Brunswick, 1873. See also Ritter, *Erkunde von Arabien*, 1847; Zehme, *Arabien und die Araber*, Halle, 1875.

JILOLO, GILOLO, or DJILOLO (properly Jailolo or Djailolo, and in the native tongue *Halmahera* or *Halema-hera*, i.e., the mother or great land), is one of the larger islands of the East Indian archipelago, forming part administratively of the Dutch residency of Ternate. The equator cuts across the southern peninsula, the most northerly point of the island lying in 2° 13' N. lat., and the southern extremity in 0° 52' S. A large proportion of Jilolo is practically *terra incognita*, though information has somewhat accumulated since Wallace complained in 1856 of the smallness of our knowledge in regard to it. The area is stated at 6410 square miles; the extreme irregularity of the outline, however, renders the estimate a peculiarly precarious one. Jilolo may be said to consist of four peninsulas so arranged as to enclose three great bays (Kaou, Bitjoli, Weda), all opening towards the east,—the northern peninsula being connected with the others by an isthmus only 5 miles wide. On the western side of the isthmus lies another bay, that of Dodinga, in the mouth of which are situated the two islands Ternate and Tidore, whose political celebrity so far exceeds that of their larger neighbour Jilolo. To the north-east of the northern peninsula we have the considerable island of Morotai, and to the west of the southern peninsula the far more important island of Batchian. The northern peninsula is full of mountain chains, which give clear evidence of former volcanic activity; and at least one of the summits, Telo or Gunong Api (3000 feet), was not quite extinct in the 16th century according to Valentijn's report. At present the crater, as described by Bernstein, is 200 feet deep, and contains a small lake. Gunong Tabetlo is higher than Telo, and Gunong Mamuya has a similar altitude. In the south of the peninsula lies a lake, Talaga Lamo (the Telagalina of Bernstein's account), about 4 or 5 miles long. The principal village is Galela, situated on a bay of the same name on the east coast, in a well-cultivated plain which extends southward and inland. The three remaining peninsulas, which have been less explored, seem to be hardly so mountainous. The whole island is clothed with a prolific vegetation, some of the more important features of which will be found described in Teysmann's paper in the Report of the Botanic Garden at Buitenzorg. Rice is grown by the natives, but the sago tree is of far greater importance to them.

The people of Jilolo are for the most part pagans, living in a very backward state of civilization. Attempts to Christianise them have been made with but small success by the missionaries of the Utrecht Society, who have their chief stations at Swakenora and Dokelamo, near Lake Talaga Lamo (see *Berigten der Utrechtsche Zendingsvereniging*, 1869). M. Achille Raffray gives the following description of the Halmaherians in *Tour du Monde*, 1879, where photographs of a number of the natives will be found. "They are as unlike the Malays as we are, excelling them in tallness of stature and elegance of shape, and being perfectly distinguished by their oval face, with a fairly high and open brow, their aquiline nose, and their horizontally placed eyes. Their beards are sometimes thick; their limbs are muscular; the colour of their skins is cinnamon brown. Spears of iron-wood, abundantly barbed, and small bows and bamboo arrows free from

poison are their principal weapons." According to Teysmann they have temples (*sabaus*) in which they suspend images of serpents and other monsters as well as the trophies procured by war. They believe, in a better life hereafter, but have no idea of a hell or a devil, their evil spirits only tormenting them in the present state.

The Portuguese and Spaniards were better acquainted with Jilolo than with many other parts of the archipelago; they called it sometimes Batu China and sometimes Moro. It was circumnavigated by one of their vessels in 1525, and the general outline of the coasts is correctly given in their maps at a time when separate portions of Celebes, such as Macassar and Menado, are represented as distinct islands. The current name of the island (Jilolo) was really that of a native state, the sultan of which had the chief rank among the princes of the Moluccas before he was supplanted by the sultan of Ternate about 1380. His capital, Jilolo, lay on the west coast on the first bay to the north of that of Dollinga. In 1876 Don Hassan, a descendant of the sultans of Jilolo, raised an insurrection in the island for the purpose of throwing off the authority of the sultans of Tidore and Ternate; and his efforts would probably have been successful but for the intervention of the Dutch.

See J. P. C. Camblér, "Rapport over Tidore-och-Balmahera (1825): "Tekno-*da* Woordenlijst van Talen op Tidore-och-Balmahera"; and "Baldé van der Aa," "Vluchtige Opmerkingen over de Talen der Balmahera groep"—all three in *Bijdr. tot de T. L. en V. Kunde van X. Ind.*, 1873; Meibeker, "Dr. Bensteh's Reise in den Nördl. Mollukken," in Petermann's *Mittheilungen*, 1873; Dr. Baum, "Les Alfonsos de Gilolo," in *Bull. de la Soc. de Geogr.*, 1877 (based on information from Raffray); Teysmann, in *Bijdr. tot de T. L. en V. Kunde*, 1878, translated in *Annales de l'Extrême Orient*, 1879.

JIMENES, or XIMENES, DE CISNEROS, FRANCISCO (1436-1517), cardinal and statesman, was born in 1436 at Torrelaguna in Castile, of good but poor family. He studied at Alcalá de Henares and afterwards at Salamanca; and in 1459, having entered holy orders, he went to Rome. Returning to Spain in 1465, he brought with him an "expective" letter from the pope, in virtue of which he took possession of the archpriestship of Uzeda in the diocese of Toledo in 1473. Carrillo archbishop of Toledo, opposed him, and on his obstinate refusal to give way threw him into prison. For six years Jimenes held out, and at length in 1480 Carrillo restored him to his benefice. This Jimenes exchanged almost at once for a chaplaincy at Sigüenza, under Cardinal Mendoza, bishop of Sigüenza, who shortly appointed him vicar-general of the diocese. In that position Jimenes won golden opinions from ecclesiastic and layman; and he seemed to be on the sure road to distinction among the secular clergy, when he abruptly resolved to become a monk. Throwing up all his benefices, and changing his baptismal name Gonzales for that of Francisco, he entered the Franciscan monastery of San Juan de los Reyes, recently founded by Ferdinand and Isabella at Toledo. Not content with the ordinary severities of the novitiate, he added voluntary austerities. He slept on the bare ground, wore a hair-shirt, doubled his fasts, and scourged himself with much fervour; indeed throughout his whole life, even when at the acme of his greatness, his private life was most rigorously ascetic. The report of his sanctity brought crowds to confess to him; but from them he retired to the lonely monastery of Our Lady of Castañar; and he even built with his own hands a rude hut in the neighbouring woods, in which he lived at times as an anchorite. He was afterwards guardian of a monastery at Salzeda. Meanwhile Mendoza (now archbishop of Toledo) had not forgotten him; and in 1492 he recommended him to Isabella as her confessor. The queen sent for Jimenes, was pleased with him, and to his great reluctance forced the office upon him. The post was politically important, for Isabella submitted to the judgment of her father-confessor not only her private affairs but also matters of state. Jimenes's severe sanctity soon won him considerable influence over Isabella; and thus it was that he first emerged into political life. In 1494 the queen's confessor was appointed provincial of the order of St Francis, and at once set about reducing the laxity of the *Conventual* to the strictness of the *Observantine* Franciscans. As was to be expected, intense opposition was offered, and continued even after Jimenes became arch-

bishop of Toledo. The general of the order himself came from Rome to interfere with the archbishop's measures of reform, but the stern inflexibility of Jimenes, backed by the influence of the queen, met and subdued every obstacle. Cardinal Mendoza had died in 1495, and Isabella had secretly procured a papal bull nominating her confessor to his diocese of Toledo, the richest and most powerful in Spain, second perhaps to no other dignity of the Roman church save the papacy. Long and sincerely Jimenes strove to evade the honour; but his *nolo episcopari* was after six months overcome by a second bull ordering him to accept consecration. With the primacy of Spain was associated the lofty dignity of high chancellor of Castile; but Jimenes still maintained his lowly life; and, although a message from Rome required him to live in a style befitting his rank, the outward pomp only concealed his private asceticism, just as his splendid robes covered his monk's frock. In 1499 Jimenes accompanied the court to Granada, and there eagerly joined the mild and pious Archbishop Talavera in his efforts to convert the Moors. Talavera had begun with gentle measures, but Jimenes preferred to proceed by haranguing the *fakihis*, or doctors of religion, and loading them with gifts. Outwardly the latter method was successful; in two months the converts were so numerous that they had to be baptized by aspersion. The indignation of the unconverted Moors swelled into open revolt. Jimenes was besieged in his house, and the utmost difficulty was found in quieting the city. Baptism or exile was offered to the Moors as a punishment for rebellion. The majority accepted baptism; and Isabella, who had been momentarily annoyed at her archbishop's imprudence, was satisfied that he had done good service to Christianity. On November 26, 1504, Isabella died. Ferdinand at once resigned the title of king of Castile in favour of his daughter Joan and her husband the archduke Philip, assuming instead that of regent. Philip was keenly jealous of Ferdinand's pretensions to the regency; and it required all the tact of Jimenes to bring about a friendly interview between the princes. Ferdinand finally retired from Castile; and, though Jimenes remained, his political weight was less than before. The sudden death of Philip in September 1506 quite upset the already tottering intellect of his wife; his son and heir Charles was still a child; and Ferdinand was at Naples. The nobles of Castile, mutually jealous, agreed to entrust affairs to the archbishop of Toledo, who, moved more by patriotic regard for his country's welfare than by special friendship for Ferdinand, strove to establish the final influence of that king in Castile. Ferdinand did not return till August 1507; and with him he brought a cardinal's hat for Jimenes. Shortly afterwards the new cardinal of Spain was appointed grand inquisitor-general for Castile and Leon. See INQUISITION.

The next great event in the cardinal's life was the expedition against the Moorish city of Oran in the north of Africa, in which his religious zeal was supported by the prospect of the political and material gain that would accrue to Spain from the possession of such a station. A preliminary expedition, equipped, like the following, at the expense of Jimenes, captured the port of Mers-el-Kebir in 1506; and in 1509 a strong force, accompanied by the cardinal in person (now in his seventy-second year), set sail for Africa, and in one day the wealthy city was taken by storm. Though the army remained to make fresh conquests, Jimenes returned to Spain, and occupied himself with the administration of his diocese, and in endeavouring to recover from the regent the expenses of his Oran expedition. On January 23, 1516, Ferdinand died, leaving Jimenes as regent of Castile for Charles (afterwards Charles V.), then a youth of sixteen in the Netherlands. Though Jimenes at once took firm hold of the reins of government, and ruled



in a determined and even autocratic manner, the haughty and turbulent Castilian nobility and the jealous intriguing Flemish councillors of Charles combined to render his position peculiarly difficult; while the evils consequent upon the unlimited demands of Charles for money threw much undeserved odium upon the regent. In violation of the laws, Jimenes acceded to Charles's desire to be proclaimed king; he secured the person of Charles's younger brother Ferdinand; he fixed the seat of the cortes at Madrid; and he established a standing army by drilling the citizens of the great towns. Immediately on Ferdinand's death, Adrian, dean of Louvain, afterwards pope, produced a commission from Charles appointing him regent. Jimenes admitted him to a nominal equality, but took care that neither he nor the subsequent commissioners of Charles ever had any real share of the power. In September 1517 Charles landed in the province of Acturias, and Jimenes hastened to meet him. On the way, however, he fell ill, not without a suspicion of poison. While thus feeble, he received a letter from Charles coldly thanking him for his services, and giving him leave to retire to his diocese. A few hours after this virtual dismissal, which some, however, say the cardinal never saw, Francisco Jimenes died at Roa, November 8, 1517.

Jimenes was a bold and determined statesman. Sternly and inflexibly, with a confidence that became at times overbearing, he carried through what he had decided to be right, with as little regard for the convenience of others as for his own. In the midst of a corrupt clergy his morals were irreproachable. He was liberal to all, and founded and maintained very many benevolent institutions in his diocese. His whole time was devoted either to the state or to religion; his only recreation was in theological or scholastic discussion. Perhaps one of the most noteworthy points about the cardinal is the advanced period of life at which he entered upon the stage where he was to play such leading parts. Whether his abrupt change from the secular to the regular clergy was the fervid outcome of religious enthusiasm or the far-seeing move of a wily schemer has been disputed; but the constant austerity of his life, his unvarying superiority to small personal aims, are arguments for the former alternative that are not to be met by merely pointing to the actual honours and power he at last attained.

His services to learning and literature have yet to be noted. In 1500 was founded, and in 1508 was opened the university of Alcalá de Henares, which, fostered by Cardinal Jimenes, at whose sole expense it was raised, attained a great pitch of outward magnificence and internal worth. At one time 7000 students met within its walls. In 1836 the university was removed to Madrid, and the costly buildings were left vacant. In the hopes of supplanting the romances generally found in the hands of the young, Jimenes caused to be published religious treatises by himself and others. He revived also the Mozarabic liturgy, and endowed a chapel at Toledo, in which it was to be used. But his most famous literary service was the printing at Alcalá (in Latin *Complutum*) of the Complutensian Polyglott, the first edition of the Christian Scriptures in the original text.<sup>1</sup>

<sup>1</sup> In this work, on which he is said to have expended half a million of ducats, the cardinal was aided by the celebrated Stunica (D. Lopez de Zuñiga), the Greek scholar Nuñez de Guzman (Pincianus), the Hebraist Vergara, and the humanist Nebrija, by a Cretan Greek Demetrius Ducas, and by three Jewish converts, of whom Zamora edited the Targum to the Pentateuch. The other Targums are not included. In the Old Testament Jerome's version stands between the Greek and Hebrew. The synagogue and the Eastern Church, as the preface expresses it, are set like the thieves on this side and on that, with Jesus (that is, the Roman Church) in the midst. The text occupies five volumes, and a sixth contains a Hebrew lexicon, &c. The work commenced in 1502. The New Testament was finished in January 1514, and the whole in April 1517. It was dedicated to Leo X.

The work by Alvaro Gómez de Castro, *De Rebus Gestis Francisci Ximenii* (folio, 1659, Alcalá), is the quarry whence have come the materials for biographies of Jimenes—in Spanish by Robles (1604) and Quintanilla (1633); in French by Baudier (1635), Marsollier (1684), Fléchier (1694), and Richard (1704); in German by Heffel (1844, translated into English by Canon Dalton, 1860) and Have-mann (1848); and in English by Barrett (1813). See also Prescott's *Ferdinand and Isabella*; *Revue des Deux Mondes*, May 1841; and *Mém. de l'Acad. d'hist. de Madrid*, vol. iv.

JITOMIR. See ZIMTOMIR.

JOACHIM (c. 1145–1202), abbot of Floris, has a place of considerable prominence in the category of those mystics who, like St Hildegard or the abbess Elizabeth, on behalf of a sounder morality protested in prophetic denunciation against the many and gross abuses connected with the ecclesiasticism which prevailed in Europe towards the close of the 12th century. The few details of his life that can be given are neither very precise nor quite trustworthy; but it appears that he was born about 1145 at a village in the neighbourhood of Cosenza, and that when a youth he had attended the Sicilian court; afterwards he made a pilgrimage to Palestine, and, having (whether previously or subsequently to his return is not stated) become a monk, he ultimately attained to the dignity of abbot of the monastery of Corace in Calabria (onwards from 1178). Here his studies in prophecy and apocalyptic brought him into great repute, and successive popes—Lucius III., Urban III., and Clement III.—manifested an interest in them. The last-named especially, in the first year of his pontificate (1188), urged Joachim to the completion of his commentary on the Apocalypse and also of his *Concordia utriusque Testamenti*. Soon afterwards the abbot, accompanied by a friend named Rainerius, leaving Corace in search of a more solitary life, set up among the lonely hills of Sylæ near Cosenza a new establishment, named "Sancti Joannis in Flori," for which he drew up a new and stringent rule, afterwards sanctioned (in 1196) by Celestine III. From this cloister ultimately sprang a whole congregation,—the so-called "Ordo Florentis." The only work published during his lifetime was the *Concordia*, which had been duly submitted to the judgment of the Holy See; and before his death (which occurred between September 1201 and June 1202) he left in writing a memorandum with reference to his other compositions,—the *Expositio in Apocalypsin*, the *Psalterium decem-chordarum*, *Contra Judæos*, and *Contra cathol. fidei adversarios*,—intimating his desire and intention that these should also be subject to the same censorship.

His study of apocalyptic prophecy had resulted in the construction of an elaborate scheme of the past and future course of the divine kingdom which is as interesting as it is curious. He distinguished three stages or ages of the world corresponding to the three persons of the Trinity, the three conditions of married persons, clergy, and monks, the three periods of the Old Testament, the New Testament, and the final dispensation. The advent of the last of these periods, that of the Holy Spirit, the "spiritualis intelligentia," proceeding from the Old and New Testaments, he regarded as imminent. It was to be the period of perfect freedom from the letter, of monastic contemplation, adoration, and jubilation, and of the widest possible diffusion of the gospel (even to the Jews); but it was to be preceded by fearful judgments, in which Antichrist should become manifest. He regarded the Church of Rome as having been typified by the kingdom of Judah, while the Eastern Church corresponded to that of Israel. The way in which he worked out this analogy gave him scope for pointing out the manifold errors and corruptions into which he believed the Church of the West to have fallen, yet in no spirit of hostility to that organization as such. His eschatology found great currency and much acceptance amongst the stricter members of the Franciscan order,—the "Zelatores" as they were called,—and gradually gave rise to a cognate literature more manifestly opposed to Rome and whose permission to publish was so tardy that the book did not come before the public till 1522. The MSS. on which the Hebrew text was based are still at Madrid; the history of these used for the New Testament has long been a problem, but the story that they were sold to a fireworks maker appears to be a fable. See Delitzsch's unfinished studies on the subject (London, 1872, and Leipsic, 1878).

even to ecclesiasticism of any kind.' Among this class of compositions the greatest historical importance belongs to the *Liber introductorius in Evangelium æternum*, now no longer extant, except in some excerpts. The work was censured as heretical by the university of Paris, and the order for its destruction was obtained from Alexander IV. in 1255; this, however, only stimulated the public interest in the books of Joachim himself, which now began to be circulated and read more widely than ever. That interest died a natural death, however, when the year 1260, which Joachim had fixed as the time of the end, had come and gone, leaving the old and evil world practically unchanged.

See Engelhardt, *Kirchengeschichtliche Abhandlungen*, 1832; Neander, *Gesch. d. christl. Religion u. Kirche* (English translation, vol. vii., 1852); Reuan, "Joachim de Flore et l'Évangile éternel," in the *Revue des Deux Mondes* for 1866; Preger, *Gesch. d. deutschen Mystik*, vol. i., 1875; and Moller's art. "Joachim von Floris," in Herzog-Bitt's *Real-Encyc.*, vol. vi.

JOACHIMSTHAL (Boh., *Jáchimov*), a mining town of Bohemia, in the circle of Eger, is favourably situated in a valley on the southern slopes of the Erzgebirge, about 10 miles north of Carlsbad, and 3 miles from the Saxon frontier, at an elevation of 2000 feet above the level of the sea, 50° 23' N. lat., 12° 54' E. long. It is the seat of a circuit court and board of mines, and has two commercial schools and establishments for teaching lace-making and straw-plaiting. The inhabitants are chiefly employed in mining, and in the manufacture of white and red lead, vermilion, cobalt, smalt, uranium yellow, bismuth, and nickel; also of thread, lace, basket-work, cutlery, paper, and cigars. The town owes its celebrity to the silver, lead, tin, and iron mines in its vicinity. During the 16th century the silver mines reached a very high point of productiveness, but since that period the yield has considerably declined. Population in 1870, 6586.

In place of the present town of Joachimsthal, which dates from the year 1516, there stood formerly the village of Conradgrün. This was ceded by the kings of Bohemia to the counts of Schlick, from whom it passed by feudal tenure to the knights of Haslava. It is from the silver guldengroschen, first coined in 1518 by order of Count Schlick, and afterwards known as Joachimsthaler, that the German term *thaler* is derived. In 1547, during the Smalkald war, the town was besieged by William Thunshirn, general of John Frederick, elector of Saxony, but the siege was soon raised. In 1579 certain special privileges and additional lands were granted to Joachimsthal by the emperor Rudolph II. The last emigration of Protestants from the neighbourhood to Saxony took place in 1663. Three-fourths of the town was destroyed by fire on the 31st March 1873. The large church of St Joachim, which was also burned, was rebuilt and restored in 1876. In the neighbourhood are the ruins of the castle of Freudenstein.

JOAN, the name given to a female pope, now regarded as a fictitious personage, who under the title of John VII. or VIII. was said, according to the most general accounts, to have occupied the papal chair between the pontificate of Leo IV. and Benedict III., although various other dates are given. Tradition represents her as of English descent, but born in Ingelheim or Mainz. By some her original name is given as Gilberta, by others as Agnes. She was credited with having fallen in love with a young Benedictine monk, and with having on that account assumed the male monastic habit and lived for some time in the monastery of Fulda. Her lover, it is affirmed, died while they were pursuing their studies together at Athens, and after his death she went to Rome, where, according to the most approved version of the story, she became a very successful professor. So high indeed became her reputation for piety and learning that the cardinals with one consent elected the supposed young monk the successor of Pope Leo IV. In this position she comported herself so as entirely to justify their choice until the catastrophe of giving birth to a male child during a procession to the Lateran palace suddenly and irrevocably blasted her reputation. She is said either to have died in childbirth or to have been stoned to death.

The story of the pontificate of Joan was received as fact from the 13th to the 15th century, but it has been discredited by later researches. The circumstantial evidence around which it clung, and which may have aided in suggesting it, was the observance of

a circuit by the papal processions so as to avoid passing through a certain street (a statue at one time standing in that street, said to represent a woman and child, with a monumental stone near it having a peculiar inscription), and the use of a pierced seat at the enthronement of the popes. Of these facts other and more credible explanations have, however, been given, although there is no sufficient evidence to demonstrate beyond dispute the manner in which the story originated. According to Dr Dollinger, who gives an elaborate analysis of the story in *Die Papst-Edeln des Mittelalters*, Munich, 1863, the tradition finds no support in the original text either of Marianns Scotus, Sigebert of Gemblours, or Otto of Freysingen. She is first mentioned by Stephen de Bourbon, who died in 1261, and who took his information probably from the chronicle of the Dominican Jean de Mailly, no copy of which is now known to be in existence. The story is not found in any of the original manuscripts of Martinus Polus, and according to Dollinger was interpolated in that chronicle some time between 1278 and 1312. He attributes the propagation of the myth chiefly to its insertion in Martinus Polus, from which it was copied into the *Flores Temporum*, a chronicle founded on Martinus, and its real originators he supposes to have been the Dominicans and Minorites, who had a grudge against the papacy on account of the persecutions they were experiencing at the hands of Benedict VIII. So rapidly did the tradition spread that in 1400 a bust of the popess was placed in the cathedral of Siena along with the other popes, having the inscription "John VIII., a woman from England." The statue occupied this position till the beginning of the 17th century.

See the work of Dollinger above mentioned, which has been translated into English both in England and in America, and the authorities therein referred to.

JOAN OF ARC, or more properly Joanneta Darc, afterwards known in France as Jeanne d'Arc,<sup>1</sup> the Maid of Orleans, was born about 1411, the daughter of Jacques Darc, peasant proprietor of Domremy, a small village partly in Champagne and partly in Lorraine, and of his wife Isabeau de Vouthon, who from having made a pilgrimage to Rome had received the usual surname of Romée. Joan never learned to read or write, and received her sole religious instruction from her mother, who taught her to recite the Pater Noster, Ave Maria, and Credo. In her childhood she was noted for her abounding physical energy; but her vivacity, so far from being tainted by any coarse or unfeminine trait, was the direct outcome of intense mental activity and an abnormally sensitive nervous temperament. Towards her parents her conduct was uniformly exemplary, and the charm of her unselfish kindness made her the special favourite of many in the village. In all household work she was specially proficient, her skill in the use of the needle not being excelled by that of any matron even of Rouen. As she grew to womanhood she became inclined to silence, and spent much of her time in solitude and prayer. All advances made by the young men of her acquaintance with the view of winning her attention or favour she decisively repelled; and, while active in the performance of her usual round of duties, and apparently finding her mode of life quite pleasant and congenial, inwardly she was engrossed with thoughts reaching far beyond the circle of her daily concerns.

At this time, through the alliance and support of Philip of Burgundy, the English had extended their conquest over the whole of France north of the Loire as well as Guienne; and, while the infant Henry VI. of England had in 1422 been proclaimed king of France at his father's grave at St Denis, Charles the dauphin, devoted only to present ease and pleasure, was almost passively contemplating the slow dismemberment of his kingdom by internal confusion and misery, and by the progressive encroachments of the English rule. The fact that the hard straits to which the kingdom was reduced were greatly owing to the conduct of Isabella, the dauphin's mother, who disinherited her son

<sup>1</sup> In the Act of ennoblement the name is spelt *Day*, due probably to the peculiar current pronunciation. It has been disputed whether the name was written originally d'Arc or Darc. It is beyond doubt that the father of Joan was not of noble origin, but Bouteiller suggests that at that period the apostrophe did not indicate nobility.



in favour of Henry V. of England, the husband of her daughter Catherine, supplied an opportunity for the fulfilment of the ancient prophecy of the enchanter Merlin, that the calamities which should fall upon France through the depravity of a woman would be removed by the instrumentality of a chaste virgin. To the imagination of the time there was, moreover, nothing strange in such a mode of deliverance, for it was no uncommon occurrence for damsels to accompany their lovers to the wars, and, disguised as pages, to share to some extent in their dangers and adventures. In the country of Joan the tradition was current that this virgin should come out of the forest of Domremy, where Joan was accustomed in her childhood to tend her father's sheep. How it therefore became fixed in her mind that she was the destined deliverer of her country there is little difficulty in understanding. She possessed a nature strongly sympathetic, and it was kindled to ardent patriotism by the sad condition of her country; her imagination was so overpoweringly vivid that it frequently deceived her reason; and her consciousness of endowments which could find no proper scope for their activity within her narrow sphere must have confirmed if they did not originate her prognostications that she was appointed to some high destiny. Gradually her whole attention became so engrossed with her country's wrongs that all her waking hours were one continued and prolonged prayer for its deliverance. The result was that, owing to a peculiarity in her nervous constitution, her own thoughts and hopes seemed to take audible voice, and returned to her as assurances and commands spoken to her by the saints. At last, when in 1428 Orleans, the key to the south of France, was invested by the English under the earl of Salisbury, the voices became so peremptory and urgent as to overcome all pretences for delay on account of previous discouragements and rebuffs. Notwithstanding the strong remonstrances of her parents, who viewed her resolve with poignant grief and dismay, she now renewed with increased determination her efforts to win from Robert de Baudricourt, governor of Vaucouleurs, an introduction to the dauphin Charles. In all her subsequent acts she professed to be guided by the voices of the saints, who had set before her the twofold task of relieving Orleans and crowning the young dauphin at Rheims. By persistent importunity, the effect of which was increased by the simplicity of her demeanour and her calm assurance of success, she at last prevailed on the governor to grant her request; and in February 1429, accompanied by two knights, she set out on her perilous journey to the court of the dauphin at Chinon. At first Charles refused to see her, but the rising tide of popular feeling in her favour induced his advisers to persuade him after three days to grant her an interview. Of the divinity of her commission she is said to have persuaded him by discovering him though disguised in the crowd of his courtiers, and by assuring him regarding his secret doubts as to his legitimacy. Accordingly, after a commission of doctors had reported that they had found in her nothing of evil or contrary to the Catholic faith, and a council of matrons had reported on her chastity and virginity, she was permitted to set forth with an army of 4000 or 5000 men designed for the relief of Orleans. At the head of the army she rode clothed in a coat of mail, armed with an ancient sword which she had divined to be hidden near the altar of St Catherine de Fierbois, and carrying a white standard of her own design embroidered with lilies and having on the one side the image of God seated on the clouds and holding the world in his hand, and on the other a representation of the annunciation. Joan was of medium height, stoutly built, but finely proportioned: and her frame was capable of enduring great fatigue. Notwithstanding

subsequent traditions, she does not appear to have been strikingly handsome. Conventional beauty of the highest type could not be expected in one accustomed to her mode of life, but the most authentic testimonies represent her as less comely than many in her own station. Her features were, moreover, expressive rather of rustic honesty and innocence than of mental power, although she is said to have possessed grand melancholy eyes which, probably on account of the high and noble purpose which animated them, exercised an indescribable charm.<sup>1</sup> Her voice was powerful, but at the same time of great sweetness, and her manner possessed a fine natural dignity and grace, which, while it repelled familiarity, softened and subdued even the rudest of the soldiers. Nominally she had been entrusted with the command of the army, but in reality it was under the direction of experienced generals; and it cannot be pretended that the victories accomplished in consequence of her co-operation were the result of brilliant military genius. Indeed, the blind obstinacy with which in the face of overwhelming odds she refused to acknowledge defeat placed it beyond doubt that she was unable to estimate the elements of success in battle, and was actuated throughout by a fatalistic persuasion that victory was inevitable if she persevered unflinchingly in her efforts to obtain it. At the same time she possessed a shrewd and penetrating judgment both as to men and things, and the manner in which she conducted herself amid the varied difficulties of her career indicated extraordinary force of character and high and noble prudence. What, however, she chiefly supplied to the French cause was concentrated energy and resolution. Above all, she inspired the soldiery with a fanatic enthusiasm armed with the sanctions and ennobled by the influences of religion; and she overawed the enemy by the superstitious fear that she was in league with supernatural powers.

By a remarkable stroke of good luck Joan succeeded in entering Orleans on the 29th April 1429, and through the vigorous and unremitting attacks of the French the English gradually became so discouraged that on the 8th of May they raised the siege. By the capture of Jargeau and Beaugency, followed by the great victory of Patay, where Talbot was taken prisoner, the English were driven beyond the Loire. With some difficulty the king was then persuaded to set out towards Rheims, which he entered with an army of 12,000 men on July 16th, Troyes having on the way been taken by assault at the sole instigation of the Maid. On the following day, holding the sacred banner, she stood next to Charles at his coronation in the cathedral. After an endeavour to detach Burgundy from the English cause, the king at last agreed to attempt the capture of Paris, but on account of the disastrous result of an attack made on the 8th September, in which Joan was wounded, he resolved, notwithstanding her passionate remonstrance, to withdraw from the city, and disbanded his troops. Joan went into Normandy to assist the duke of Alençon, but in December returned to the court, and on the 29th she and her family were ennobled with the surname of du Lis. Unconsoled by such honours, she rode away from the court in March, to assist in the defence of Compiègne against the duke of Burgundy; and on the 24th May she led an unsuccessful sortie against the besiegers, when on account of her determination to fight to the last she was surrounded and taken prisoner. Charles, partly perhaps on account of his natural indolence, partly on account of the intrigues at the court, made no effort to effect her ransom, and never showed any sign of interest in her fate. Probably he had found her so difficult to

<sup>1</sup> On the personal appearance of the Maid, see especially E. de Bouteiller, *Notes Jeanographiques sur Jeanne d'Arc*, 1879, containing engravings of the most authentic statues.

manage and control that he as well as his generals regarded her presence with the army as more embarrassing than helpful; and doubtless her capture dissipated the bale of supernatural power that had surrounded her. By means of negotiations instigated and prosecuted with great perseverance by the university of Paris and the Inquisition, and through the persistent scheming of Pierre Cauchon, the ejected bishop of Beauvais, she was sold in November by Luxembourg and Burgundy to the English, who on January 3, 1431, at the instance of the university of Paris, delivered her over to the Inquisition for trial. After a public examination, begun on the 9th January and lasting six days, and another conducted in the prison, she was, on the 20th March, publicly accused as a heretic and sorcerer, and, being in the end found guilty, she made her submission at the scaffold on the 24th May, and received pardon. She was still, however, the prisoner of the English, and, having been induced by those who had her in charge to resume her male clothes, she was on this account judged to have relapsed, was sentenced to death, and burned at the stake on the streets of Rouen, May 30, 1431. The sentence was revoked by the pope on the 7th July 1456, and since then it has been the custom of Catholic writers to uphold the reality of her divine inspiration. In 1436 an imposter appeared, professing to be Joan of Arc escaped from the flames, who succeeding in inducing many people to believe in her statement, but afterwards confessed her imposture.

There is no doubt that Joan herself believed in her supernatural guidance, and her judges, notwithstanding all their efforts, were unable to bring to light the smallest semblance of a sign of conscious dishonesty on her part. At the same time the nobility of her purpose was unstained by the faintest symptom of selfish regard to her own fame and glorification. Indeed the greatness of her career did not consist in her military achievements, but in her pure, true, and ardent character, which made her a pathetic victim to the mean and grovelling aims of those in whose cause she fought with such simple sincerity of faith, and to the cruelties of a superstitious age.

*Literature.*—All previous works on Joan of Arc were deprived of a great part of their critical value by the publication, in 5 vols., 1841-49, of the *Procès de condamnation et de réhabilitation de Jeanne d'Arc*, edited by J. Quicherat. The record of the *Procès de condamnation* consisted originally of the official notes of the trial, afterwards edited in Latin by P. Cauchon, and bears internal marks of general truthfulness. The original French minute does not exist except in a fragment which has been reproduced by M. Vallet de Viriville in his French translation of the Latin version, published in 1867. A French translation of the *Procès de condamnation* and *Procès de réhabilitation* by E. O'Reilly appeared in 1868. The 4th vol. of Quicherat is occupied with old chronicles and histories, the principal of which are those of *Pereval de Cagny*, a retainer of the duke of Alençon, never before published; *Jacques le Bouvier* (Berri), that from 1402-1411 first published in 1653 as part of a history of Charles VI., and the remainder, 1411-1444, in the collection of Denis Godefroy, 1661; *Jean Chartier*, only contemporaneous from 1437, before which it borrows chiefly from the *Chronique de la Pucelle* and Le Bouvier, what it does not borrow being utterly untrustworthy, published 1476-77, 1493, 1514, 1517-18, by Denis Godefroy, 1661, and Vallet de Viriville, with notes, 1858; *Journal du Siège d'Orléans*, founded on the chronicles of Berri and Jean Chartier, with a few other documents, published 1576, 1606, 1611, 1619, 1621, and reprinted with notes by Jacob in 1855; *la Geste des nobles François*, or *Chronique de Cousinot*, which closes with 1429, but some years afterwards was completed by a nephew of Cousinot to the siege of Paris so as to form the *Chronique de la Pucelle*, published by Denis Godefroy, 1661, by M. Petitot, 1825, in vol. viii. of *Mémoires relatifs à l'histoire de France*, and with notes by Vallet de Viriville, 1859; *Chronique d'Enguerran de Monstrelet*, first published about 1500 and very frequently afterwards, English translation by Thomas Johnes, 1840, the last and best French edition, that of L. Douët d'Arce, 6 vols., 1857-62. The principal other contemporary authorities are Basin's *Histoire des Règnes de Charles VII. et de Louis XI.*, first published in a complete form by Quicherat, with notes and life, 4 vols., 1855-1859; the *Chronique Normande* of Pierre Cochin, the part referring to Joan published along with *Chronique de la Pucelle* by Vallet de Viriville, 1859, the

whole by De Robillard de Beaurepaire, 1870; *Chronique de Robert Blondel*, first published by Vallet de Viriville, 1859; *Chronique de Jean Raoull*, or *Chronique anonyme de Charles VII.*, first published by Vallet de Viriville, 1858; *Abregé d'Histoire chronologique*, by Denis Godefroy, 1661; *Le mystère du Siège d'Orléans*, in verse, published from a manuscript in the Vatican in *Collection de Documents inédits sur l'Histoire de France*, 1862; a Latin poem by Valesan Vasanius, 1501; an anonymous Latin poem, manuscript 5970 of the Imperial Library of Paris; a poem by Christine de Pisan, 1429, printed in 1865; Martial Auvergne, *Les Vigilles du roy Charle*, in verse, 1505—one hundred copies of the portion relating to Joan of Arc printed at Orleans, 1866, of which one copy is in the British Museum.

The earliest life by other than contemporaries is that in Latin by Jean Hordal, 1612. Edmond Richer, who had procured the original documents of the *Procès*, finished a life of Joan in 1628 which was never published, but of which Lenglet-Dufresnoy made use to correct his own work, published in 1754 in two volumes. Charles du Lys, a descendant of her kin, published *D'attraction et parenté de la Pucelle d'Orléans*, 1611, enlarged edition 1612, 3d in 1628, all of which were republished by Vallet de Viriville in *Trésor des pièces rares et anciennes*, 1856. In 1790 L'Averdy published an analysis of the manuscript of the *Procès* in the 3d vol. of *Mémoires* of the Academy or Inscriptions. The principal other works previous to the publication of the *Procès* are those of Lebrun des Charmettes, 1817, 4 vols.; Saint-Prix, 1817; Lemaire, 1818; Jollois, 1821; Dumas, 1843; De Beauregard, 1847; and the accounts by De Barante, Michelet, and Sismondi in their several histories. Since the publication of the *Procès* the works of original critical value are *Aperçus Nouveaux* by J. Quicherat, 1850; the lives by B. Henri Martin, last ed., 1875; Walloo, 1860; and Villiaumé, 1863. Other lives have been written by Lamartino, 1852; Lafaontaine, 1854; Desjardins, 1854; Michaud, 1861; Sepet, 1869. See also Vallet de Viriville, *Recherches sur la famille de Jeanne d'Arc*, 1854; *Histoire de Charles VII.*, by the same, 3 vols., 1862-65; De Robillard de Beaurepaire, *Recherches sur le procès de condamnation de Jeanne d'Arc*, 1869; Boucher de Molandon, *Première Expédition de Jeanne d'Arc*, 1874; E. de Bouteiller, *Jeanne d'Arc dans les chroniques Missines de P. Fignucilles*, 1878; and E. de Bouteiller and G. de Brax, *La famille de Jeanne d'Arc*, 1878, *Nouvelles Recherches sur la famille de Jean d'Arc*, 1879, and *Notes Iconographiques*, 1879. The principal German works are those of Görres, 2d ed., 1835 (French transl., 1848); Hase, 1861; Eysell, 1861; and Hirzel, 1877. In English, in addition to the essays of De Quincey and Lord Mahon, there are lives by Harriet Parr, 1866; Mrs Bray, 1874; and Janet Tuckey, 1880. Of the numerous dramas and poems of which Joan of Arc has been the subject, mention can only be made of *Die Jungfrau von Orléans* of Schiller, the *Joan of Arc* of Southey, and the scandalous burlesque-epic of Voltaire. A drama in verse by Jules Barbier has been set to music by C. Gounod, 1873.

JOB. The book of Job (Heb. *יִּיְבֹּֿב* *Iyyob*, Gr. *Ἰώβ*), the most splendid creation of the Hebrew poetry, is so called from the name of the man whose history and afflictions and sayings form the theme of it.

*Contents.*—As it now lies before us it consists of five parts. 1. The prologue, in prose, ch. i.-ii., describes in rapid and dramatic steps the history of this man, his piety and prosperity and greatness corresponding to his godliness; then how his life is drawn in under the operation of the trying, sifting providence of God, through the suspicion suggested by the Satan, the minister of this aspect of God's providence, that his godliness is but selfish and only the natural return for the unexampled prosperity bestowed upon him, and the insinuation that if stripped of his prosperity he will renounce God to His face. These suspicions bring down two severe calamities on Job, one depriving him of all external blessings, children and possessions alike, and the other throwing the man himself under a loathsome and painful malady. In spite of these afflictions Job retains his integrity and ascribes no wrong to God. Then the advent of Job's three friends is described, Eliphaz the Temanite, Bildad the Shuhite, and Zophar the Naamathite, who, having heard of Job's calamities, come to condele with him. 2. The body of the book, in poetry, ch. iii.-xxxi., contains a series of speeches in which the problem of Job's afflictions and the relation of external evil to the righteousness of God and the conduct of men is brilliantly discussed. This part is divided into three cycles, each containing four speeches, one by Job and one by each of the friends (ch. iii.-xiv.;



oh. xv.-xxi.; ch. xxii.-xxxii.), although in the last cycle the third speaker Zophar fails to answer, and Job, having driven his opponents from the field, carries his reply through a series of discourses in which he dwells in pathetic words upon his early prosperity, contrasting with it his present misery and humiliation, and ends with a solemn repudiation of all the offences that had been insinuated or might be suggested against him, and a challenge to God to appear and put His hand to the charge which He had against him and for which He afflicted him. 3. A youthful bystander named Elihu, the representative of a younger generation, who had been a silent observer of the debate, intervenes and expresses his dissatisfaction with the manner in which both Job and his friends had conducted the cause, and offers what is in some respects a new solution of the question (ch. xxxii.-xxxvii.). 4. In answer to Job's repeated demands that God would appear and solve the riddle of his life, the Lord answers Job out of the whirlwind. The Divine speaker does not condescend to refer to Job's individual problem, but in a series of ironical interrogations asks him, as he thinks himself capable of fathoming all things, to expound the mysteries of the origin and subsistence of the world, the phenomena of the atmosphere, the instincts of the creatures that inhabit the desert, and, as he judges God's conduct of the world amiss, invites him to seize the reins himself and gird him with the Divine thunder and quell the rebellious forces of evil in the universe (ch. xxxviii.-xlii. 6). Job is humbled and abashed, and lays his hand upon his mouth, and repents his hasty words in dust and ashes. No solution of his problem is vouchsafed; but God Himself effects that which neither the man's own thoughts of God nor the representations of the friends could accomplish: he heard of Him with the hearing of the ear without effect, but now his eye saw Him. This is the profoundest religious deep in the book. 5. The epilogue, also in prose, ch. xlii. 7-17, describes Job's restoration to a prosperity double that of his former estate, his family felicity, and long life.

*Design.*—With the exception of the episode of Elihu, the connexion of which with the original form of the poem may be doubtful, all these five parts are essential elements of the work as it came from the hand of the first author, although some parts of the second and fourth divisions may have been expanded by later writers. The idea of the composition is not to be derived from any single element of the book, as from the prologue but from the teaching and movement of the whole piece. Job is unquestionably the hero of the work, and in the ideas which he expresses and the history which he passes through combined we may assume that we find the author himself speaking and teaching. The discussion of the question of suffering between Job and his friends occupies two-thirds of the book, or, if the space occupied by Elihu be not considered, nearly three-fourths, and in the direction which the author causes this discussion to take we may see revealed the main didactic purpose of the book. When the three friends, the representatives of former theories of providence, are reduced to silence and driven off the ground by Job, we may be certain that it was the author's purpose to discredit the ideas which they represent. Job himself offers no positive contribution to the doctrine of evil; his position is negative, and merely antagonistic to that of the friends. But this negative position victoriously maintained by him has the effect of clearing the ground, and the author himself supplies in the prologue the positive truth, when he communicates the real explanation of his hero's calamities, and teaches that they were a trial of his righteousness. It was therefore the author's purpose in his work to widen men's views of the providence of God and set before them a new view of suffering. This may be considered the first great

object of the book. This purpose, however, was in all probability no mere theoretical one, but subordinate to some wider practical design. No Hebrew writer is merely a poet or a thinker. He is always a teacher. He has men before him in their relations to God. And it is not usually men in their individual relations, but as members of the family of Israel, the people of God. It is consequently scarcely to be doubted that the book has a national scope. The author considered his new truth regarding the meaning of affliction as of national interest, and to be the truth needful for the heart of his people in their circumstances. But the teaching of the book is only half its contents. It contains also a history—deep and inexplicable affliction, a great moral struggle, and a victory. The author meant his new truth to inspire new conduct, new faith, and new hopes. In Job's sufferings, undeserved and inexplicable to him, yet capable of an explanation most consistent with the goodness and faithfulness of God, and casting honour upon his faithful servants; in his despair bordering on unbelief, at last overcome; and in the happy issue of his afflictions—in all this Israel may see itself, and from the sight take courage, and forecast its own history. Job, however, is not to be considered Israel, the righteous servant of the Lord, under a feigned name; he is no mere parable (though such a view is found as early as the Talmud); he and his history have both elements of reality in them. It is these elements of reality common to him with Israel in affliction, common even to him with humanity as a whole, confined within the straitened limits set by its own ignorance, wounded to death by the mysterious sorrows of life, tortured by the uncertainty whether its cry finds an entrance into God's ear, alarmed and paralysed by the irreconcilable discrepancies which it seems to discover between its necessary thoughts of Him and its experience of Him in His providence, and faint with longing that it might come into His place, and behold Him, not girt with His majesty, but in human form, as one looketh upon his fellow,—it is these elements of truth that make the history of Job instructive to Israel in the times of affliction when it was set before them, and to men in all ages. It would probably be a mistake, however, to imagine that the author consciously stepped outside the limits of his nation, and assumed a human position antagonistic to it. The chords he touches vibrate through all humanity; but this is because Israel is the kernel of humanity, and because from Israel's heart the deepest music of mankind is heard, whether of pathos or of joy.

Two threads requiring to be followed, therefore, run through the book,—the one the discussion of the problem of evil between Job and his friends, and the other the varying attitude of Job's mind towards heaven, the first being subordinate to the second. Both Job and his friends advance to the discussion of his sufferings and of the problem of evil, ignorant of the true cause of his calamities,—Job strong in his sense of innocence, and the friends armed with their theory of the righteousness of God, who giveth to every man according to his works. With fine psychological instinct the poet lets Job altogether lose his self-control first when his three friends, the men his fellows, came to visit him. His bereavements and the acute anguish of his malady he bore with a steady courage, and the direct instigations to godlessness of the woman, his wife, he repelled with severity and resignation. But when men, his equals and the old associates of his happiness, came to see him, and when he read in their looks and in their seven days' silence the depth of his own misery, his self-command deserted him, and he broke out into a cry of despair, cursing his day and crying for death (ch. iii.). Job had somewhat misinterpreted the demeanour of his friends. It was not all pity that it expressed. Along with their pity they had also brought their theology with them, and they trusted to heal Job's malady with this. Till a few days ago Job would have agreed with them on the sovereign virtues of this remedy. But he had learned through a higher teaching, the events of God's providence, that it was no more a specific in his case. His violent impatience, however, under his afflictions and his covert attacks upon the divine rectitude only served to confirm the view of his sufferings which their theory of evil had already suggested to his friends. And thus

commences the high debate which continues through thirty chapters of the book.

The principle with which the three friends of Job came to the consideration of his history was the principle that calamity is the result of evil-doing, as on the other hand prosperity is the reward of righteousness. Suffering is not an accident or a spontaneous growth of the soil; man is born unto trouble as the sparks fly upwards; there is in human life a tendency to do evil which draws down upon men the chastisement of heaven (ch. v. 6). The form in which the principle is enunciated by Eliphaz, from whom the other speakers take their cue, is this: where there is suffering there has been sin in the sufferer, not necessarily deadly sin, though where the suffering is great the sin must have been heinous. Not suffering in itself, but the effect of it on the sufferer is what gives insight into his true character. Suffering is not always punitive; it is far oftener disciplinary, designed to wean the good man from his sin. If he sees in his suffering the monition of God and turns from his evil, his future shall be rich in peace and happiness, and his latter estate more prosperous than his first. If he murmurs or resists, he can only perish under the multiplying chastisements which his impotence will provoke. Now this principle of the friends is far from being a peculiar crotchet of theirs; its truth is undeniable, though they erred in supposing it a principle that would cover the wide providence of God. The principle is the fundamental idea of moral government, the expression of the natural conscience, a principle common more or less to all peoples, though perhaps more prominent in the Semitic mind, because all religious ideas are more prominent and simple there,—not suggested to Israel first by the law, but found and adopted by the law, though it may be sharpened by it. It is the fundamental principle of prophecy no less than of the law, and, if possible, of the wisdom or philosophy of the Hebrews more than of either. Speculation among the Hebrews had a simpler task before it than it had in the West or in the further East. The Greek philosopher began his operations upon the sum of things; he threw the universe into his crucible at once. His object was to effect some analysis of it, such an analysis that he could call one element cause and another effect. Or, to vary the figure, his endeavour was to pursue the streams of tendency which he could observe upwards till he reached at last the central spring which sent them all forth. God, a single cause and explanation, was the object of his search. But to the Hebrew this was already found. The analysis resulting in the distinction of God and the world had been effected for him long ago, so long that the history and circumstances of the process had been forgotten, and only the unchallengeable result remained. His philosophy was not a quest of God whom he did not know, but a recognition on all hands of God whom he knew. The great primary idea to his mind was that of God, a Being wholly just, doing all. And the world was little more than the phenomena that revealed the mind and the presence and the operations of God. Consequently the nature of God as known to him and the course of events formed a perfect equation. The idea of what God was in Himself was in complete harmony with His manifestation of Himself in providence, in the events of human life, and the history of men and nations. The philosophy of the wise did not go behind the origin of sin, or referred it to the freedom of man; but, sin existing, and God being in immediate personal contact with the world, every event was a direct expression of His moral will and energy; calamity fell on wickedness, and success attended right-doing. This view of the moral harmony between the nature of God and the events of providence in the fortunes of men and nations is the view of the Hebrew wisdom in its oldest form, during what might be called the period of principles, to which belong Prov. x. 27.; and this is the position maintained by Job's three friends. And the significance of the book of Job in the history of revelation arises from this that it marks the point when such a view was definitively overcome, closing the long period when this principle was merely subjected to questionings, and makes a new positive addition to the doctrine of evil.

Job agreed with the friends that afflictions came directly from the hand of God, and also that God afflicted those whom He held guilty of sins. But his conscience denied the imputation of guilt, whether insinuated by his friends or implied in God's chastisement of him. Hence he was driven to conclude that God was unjust, that He sought occasions against him, and perverted his right. The position of Job appeared to his friends nothing else but impiety, as it came very near being; while theirs was to him mere falsehood and the special pleading of sycophants in behalf of God because He was the stronger. Within these two iron walls the debate moves, making little progress, but with much brilliancy, if not of argument, of illustration. A certain advance indeed is perceptible. In the first series of speeches, ch. iv.—xiv., the key-note of which is struck by Eliphaz, the oldest and most considerate of the three, the position is that affliction is caused by sin, and is chastisement designed for the sinner's good; and the moral is that Job should recognize it and use it for the purpose for which it was sent. In the second, ch. xv.—xxi., the other side of the picture is held up, the terrible fate of the sinner, and those brilliant pictures of a restored future,

thrown in by all the speakers in the first series, are absent. Job's demeanour under the consolations offered him afforded little hope of his repentance. In the third series, ch. xxii. 27., the friends cast off all disguise, and openly charge Job with a course of evil life. That their armoury was now exhausted is shown by the brevity of the second speaker, and the failure of the third to answer in any form. In reply Job disdains for a time to touch what he well knew lay under all their exhortations; he laments with touching pathos the defection of his friends on whom he counted, who were like the winter torrents looked for in vain by the perishing caravan in the summer heat; he meets with bitter scorn their constant cry that God will not cast off the righteous man, by asking—How one can be righteous with God? what can human weakness, however innocent, do against infinite might and subtlety? they are righteous whom an omnipotent and perverse will thinks fit to consider so; he falls into a hopeless wall over the universal misery of man, who has a weary campaign of life appointed him; then, rising up in the strength of his conscience, he upbraids the Almighty with His misuse of His power and His indiscriminate tyranny,—righteous and innocent He destroys alike—and challenges Him to lay aside His majesty and meet His creature as a man, and then he would not fear Him. Even in the second series Job can hardly bring himself to face the personal issue raised by the friends. His relations to God absorb him almost wholly,—his pitiable isolation, the indignities showered on his once honoured head, the loathsome spectacle of his body; and, abandoned by all, he turns for pity from God to men and from men to God. Only in the third series of debates does he put out his hand and grasp firmly the theory of his friends, and their "defences of mud" fall to dust in his hands. Instead of that roseate moral order which they are never weary insisting upon, he finds only disorder and moral confusion. When he thinks of it, trembling takes hold of him. It is not the righteous but the wicked that live, grow old, wax mighty in strength, that send forth their children like a flock and establish them in their sight. Before the logic of facts the theory of the friends goes down; and with this negative result, which the author skillfully reaches through the debate, has to be combined his own positive doctrine of the uses of adversity advanced in the prologue.

To a reader of the poem now it appears strange that both parties were so entangled in the meshes of their preconceptions regarding God as to be unable to break through to broader views. The friends, while maintaining their position that injustice on the part of God is inconceivable, might have given its due weight to the persistent testimony of Job's conscience as that behind which it is impossible to go, and found refuge in the reflexion that there might be something inexplicable in the ways of God, and that affliction might have some other meaning than to punish the sinner or even to wean him from his sin. And Job, while maintaining his innocence from overt sins, might have bowed beneath the rod of God and confessed that there was such sinfulness in every human life as to account for the severest chastisement from heaven, or at least have stopped short of charging God foolishly. Such a position would certainly be taken up by an afflicted saint now, and such an explanation of his sufferings would suggest itself to the sufferer, even though it might be in truth a false explanation. Perhaps here, where an artistic fault might seem to be committed, the art of the writer, or what is the same thing his truth to nature, and the extraordinary freedom with which he moves among his materials, as well as the power and individuality of his dramatic creations, are most remarkable. It was the rôle which the author reserved for himself to teach the truth on the question in dispute, and he accomplishes this by allowing his performers to push their false principles to their proper extreme. There is nothing about which men are usually so sure as about God. They are ever ready to take Him in their own hand, to interpret His providence in their own sense, to say what things are consistent or not with His character and word, and beat down the opposing consciences of other men, by His so-called authority, which is nothing but their own. The friends of Job were religious Orientals, men to whom God was a Being in immediate contact with the world and life, effecting all things with no intervention of second causes, men to whom the idea of second causes was unknown, on whom science had not yet begun to dawn, nor the conception of a divine scheme pursuing a distant end by complicated means, in which the individual's interest may suffer for the larger good. The broad sympathies of the author and his sense of the truth lying in the theory of the friends are seen in the scope which he allows them, in the richness of the thought and the splendid luxuriance of the imagery—drawn from revelation, the immemorial moral consent of mankind, the testimony of the living conscience, and the observation of life—with which he makes them clothe their views. He felt it needful to make a departure from a position too narrow to confine the providence of God within, but he remembered the elements of truth in the theory which he was departing from, that it was a national heritage, which he himself perhaps had been constrained not without a struggle to abandon; and, while showing its insufficiency, he sets it forth in its most brilliant form.



Then, in regard to the position maintained by Job,—the extravagance of his assertions was occasioned greatly by the extreme position of his friends, which left no room for his conscious innocence along with the rectitude of God. Again, the poet's purpose, as the prologue shows, was to teach that afflictions may fall on a man out of all connexion with any offence of his own, and merely as the trial of his righteousness; and hence he allows Job, as by a true instinct of the nature of his sufferings, to repudiate all connexion between them and sin in himself. And further, the terrible conflict into which the suspicions of the Satan brought Job could not be exhibited without pushing him to the verge of ungodliness. These are all elements of the poet's art; but art and nature are one. Under the Old Covenant the sense of sin was less deep than it is now. In the desert, too, men speak boldly of God. Such a creation as Job would be an anomaly in Christianity. But nothing is more false than to judge the poet's creation from our later point of view, and construct a theory of the book according to a more developed sense of sin and a deeper reverence of God than belonged to antiquity. In complete contradiction to the testimony of the book itself, some theorists, as Hengstenberg, have assumed that Job's spiritual pride was just the cause of his afflictions, that this was the root of bitterness in him which must be killed down ere he could become a true saint. The fundamental position of the book is that Job was already a true saint; this is testified by God Himself, is the radical idea of the author in the prologue, and the very hypothesis of the drama. We might be ready to think that Job's afflictions did not befall him out of all connexion with his own condition of mind, and we might be disposed to find a vindication of God's ways in this. There is no evidence that such an idea was shared by the author of the book. The interpretation of Job has suffered not a little from the righteousness overmuch of its exponents. The writer did not consider that God's ways needed this vindication. The confession of sin which he puts into Job's mouth had reference exclusively to his demeanour under his afflictions. This demeanour may be evidence of the imperfection of his previous religious state. It is evidence of this, of which, however, no evidence was needed, for Job does not claim to be nor is he supposed sinless, but it is no evidence that this imperfection was the cause of his afflictions. These were the trial of his faith, which, maintaining itself in spite of them, and becoming stronger through them, was rewarded with a higher felicity. It is remarkable that the attitude which we imagine it would have been so easy for Job to assume, viz., while holding fast his integrity, to fall back upon the inexplicableness of Providence, of which there are such imposing descriptions in his speeches, is just the attitude which he takes up in ch. xxviii. It is far from certain, however, that this chapter is an integral part of the original book.

The other line running through the book, the varying attitude of Job's mind towards heaven, exhibits dramatic action and tragic interest of the highest kind, though the movement is internal. That the exhibition of this struggle in Job's mind was a main point in the author's purpose is seen from the fact that at the end of each of his great trials he notes that Job sinned not, nor ascribed wrong to God (ch. i. 22; ii. 10), and from the effect which the divine voice from the whirlwind is made to produce upon him (ch. xl. 8). In the first cycle of debate (ch. iv.—xiv.), Job's mind reaches the deepest limit of estrangement. There he not merely charges God with injustice, but, unable to reconcile His former goodness with His present enmity, he regards the latter as the true expression of the divine mind towards His creatures, and the former, comprising all His infinite creative skill in weaving the delicate organism of human nature and the rich endowments of His providence, but as the means towards exercising His mad and immoral cruelty in the time to come. When the Semitic skin of Job is scratched, we find a modern pessimist beneath. Others in later days have brought the keen sensibility of the human frame and the torture which it endures together, and asked with Job to whom at last all this has to be referred. Towards the end of the cycle a star of heavenly light seems to rise on the horizon; the thought seizes the sufferer's mind that Ioan might have another life, that God's anger pursuing him to the grave might be sated, and that He might call him out of it to Himself again (ch. xiv. 13). This idea of a resurrection, unfamiliar to Job at first, is one which he is allowed to reach out of the necessities of the moral complications around him, but from the author's manner of using the idea we may judge that it was not unfamiliar to himself. In the second cycle the thought of a future reconciliation with God (for of course he regarded his afflictions as evidence of God's anger) is more firmly grasped. That satisfaction or at least composure which, when we observe calamities that we cannot morally account for, we reach by reflecting that providence is a great scheme moving according to general laws, and that it does not always truly reflect the relation of God to the individual, Job reached in the only way possible to a Semitic mind. He drew a distinction between God and God, between an outer God whom events obey, pursuing him in His anger, and an inner God whose heart was with him, who was conscious of his innocence; and he appeals from God to God, and beseeches God to judge Himself that

he shall receive justice from God (ch. xvi. 19; xvii. 3). And so high at last does this consciousness that God is at one with him rise that he avows his assurance that He will yet appear to do him justice before men, and that he shall see Him with his own eyes, no more estranged but on his side, and for this moment he faints with longing (ch. xix. 25 sq.).<sup>1</sup>

After this expression of faith Job's mind remains calm, though he ends by firmly charging God with perverting his right, and demanding to know the cause of his afflictions (ch. xxvii. 2 sq.; xxxi. 35, where render, Oh, that I had the indictment which mine adversary has written). In answer to this demand the Divine voice answers Job out of the tempest—Who is this that darkeneth counsel by words without knowledge? The word "counsel" intimates to Job that God does not act without a design, large and beyond the comprehension of man; and to impress this is the purpose of the Divine speeches. The speaker does not enter into Job's particular cause; there is not a word tending to unravel his riddle; his mind is drawn away to the wisdom and majesty of God Himself. His own words and those of his friends are but re-echoed, but it is God Himself who now utters them. Job is in immediate nearness to the majesty of heaven, wise, unfathomable, ironical over the littleness of man, and he is abased; God Himself effects what neither the man's own thoughts of God nor the representations of his friends could accomplish, though by the same means. The religious insight of the writer sounds here the profoundest deeps of truth.

*Integrity.*—Doubts whether particular portions of the present book belonged to the original form of it have been raised by many. Half a century ago De Wette expressed himself as follows: "It appears to us that the present book of Job has not all flowed from one pen. As many books of the Old Testament have been several times written over, so has this also" (Ersch and Gruber, *Encyk.*, sect. ii., vol. viii.). The judgment formed by De Wette has been adhered to more or less by most of those who have studied the book. Questions regarding the unity of such books as this are difficult to settle; there is not unanimity among scholars regarding the idea of the book, and consequently they differ as to what parts are in harmony or conflict with unity; and it is dangerous to apply modern ideas of literary composition and artistic unity to the works

<sup>1</sup> This remarkable passage reads thus: "But I know that my redeemer liveth, and afterwards he shall arise upon the dust, and after my skin, even this body is destroyed, without my flesh shall I see God; whom I shall see for myself, and mine eyes shall behold, and not as a stranger; my reins within me are consumed with longing." The redeemer who liveth and shall arise or stand upon the earth is God whom he shall see with his own eyes, on his side. The course of exegesis was greatly influenced by the translation of Jerome who, departing from the Itala, rendered: "In novissimo die de terra surrecturus sum . . . et rursum circumdabor pelle mea et in carae meae videbo deum meum." The only point now in question is whether—(a) Job looks for this manifestation of God to him while he is still alive, or (b) after death, and therefore in the sense of a spiritual vision and union with God in another life; that is, whether the words "destroyed" and "without my flesh" are to be taken relatively only, of the extremest effects of his disease upon him, or literally, of the separation of the body in death. A third view which assumes that the words rendered "without my flesh," which run literally, "out of my flesh," mean looking out from my flesh, that is, clothed with a new body, and finds the idea of resurrection repeated, perhaps imports more into the language than it will fairly bear. In favour of (b) may be adduced the persistent refusal of Job throughout to entertain the idea of a restoration in this life; the word "afterwards"; and perhaps the analogy of other passages where the same situation appears, as Ps. xlix. and lxxiii., although the actual disengagement of the tragely supports (a). The difference between the two senses is not important, when the Old Testament view of immortality is considered. To the Hebrew the life beyond was not what it is to us, a freedom from sin and sorrow and admission to an immediate divine fellowship not attainable here. To him the life beyond was at best a prolongation of the life here; all he desired was that his fellowship with God here should not be interrupted in death, and that Sheol, the place into which deceased persons descended and remained, cut off from all life with God, might be overleapt. On this account the theory of Ewald, which throws the centre of gravity of the book into this passage in ch. xix., considering its purpose to be to teach that the riddles of this life shall be solved and its inequalities corrected in a future life, appears one-sided. The point of the passage does not lie in any distinction which it draws between this life and a future life: it lies in the assurance which Job expresses that God, who even now knows his innocence, will vindicate it in the future, and that, though estranged now, He will at last take him to His heart.

of antiquity and of the East. The problem raised in the book of Job has certainly received frequent treatment in the Old Testament; and there is no likelihood that all efforts in this direction have been preserved to us. It is probable that the book of Job was but a great effort amidst or after many smaller. It is scarcely to be supposed that one with such poetic and literary power as the author of chap. iii.—xxxi., xxxviii.—xli. would embody the work of any other writer in his own. If there be elements in the book which must be pronounced foreign, they have been inserted in the work of the author by a later hand. It is not unlikely either in itself or when the history of other books is considered that our present book may, in addition to the great work of the original author, contain some fragments of the thoughts of other religious minds upon the same question, and that these, instead of being loosely appended, have been fitted into the mechanism of the first work. Some of these fragments may have originated at first quite independently of our book, while others may be expansions and insertions that never existed separately. At the same time it is scarcely safe to throw out any portion of the book merely because it seems to us out of harmony with the unity of the main part of the poem, or unless several distinct lines of consideration conspire to point it out as an extraneous element.

The arguments that have been used against the originality of the prologue—as, that it is written in prose, that the name Jehovah appears in it, that sacrifice is referred to, and that there are inconsistencies between it and the body of the book—are of little weight. There must have been some introduction to the poem explaining the circumstances of Job, otherwise the poetical dispute would have been unintelligible, for it is improbable that the story of Job was so familiar that a poem in which he and his friends figured as they do here would have been understood. And there is no trace of any other prologue or introduction having ever existed. The prologue, too, is an essential element of the work, containing the author's positive contribution to the doctrine of suffering, for which the discussion in the poem prepares the way. The intermixture of prose and poetry is common in Oriental works containing similar discussions; the reference to sacrifice is to primitive not to Mosaic sacrifice; and the author, while using the name Jehovah freely himself, puts the patriarchal Divine names into the mouth of Job and his friends because they belonged to the patriarchal age and to a country outside of Israel. That the observance of this rule had a certain awkwardness for the writer perhaps appears from his allowing the name Jehovah to slip in once or twice (xii. 9, comp. xxviii. 28) in familiar phrases in the body of the poem. The discrepancies, such as Job's references to his children as still alive (xix. 17, the interpretation is doubtful), and to his servants, are trivial, and even if real imply nothing in a book admittedly poetical and not history. The objections to the epilogue are equally unimportant,—as that the Satan is not mentioned in it, and that Job's restoration is in conflict with the idea of the poem that earthly felicity does not follow righteousness, and undoes its teaching. The epilogue confirms the teaching of the poem when it gives the Divine sanction to Job's doctrine regarding God in opposition to that of the friends (xlii. 7). And it is certainly not the intention of the poem to teach that earthly felicity does not follow righteousness, but to correct the exclusiveness with which the friends of Job maintained that principle. The Satan is introduced in the prologue, exercising his function as minister of God in heaven; but it is to misinterpret the doctrine of evil in the Old Testament wholly to assign to the Satan any such personal importance or independence of power as that he should be called before the curtain to receive the hisses

that accompany his own discomfiture. The Satan, though he here appears with the beginnings of a malevolent will of his own, is but the instrument of the trying, sifting providence of God. His work was to try; that done he disappears, his personality being too slightly important to have any place in the result.

Much graver are the suspicions that attach to the speeches of Elihu. It is the opinion of most of those who have studied the book carefully that this part does not belong to the original cast of it, but has been introduced at a considerably later time. The piece is one of the most interesting parts of the book; both the person and the thoughts of Elihu are marked by a strong individuality. This individuality has indeed been very diversely estimated. The ancients for the most part passed a very severe judgment on Elihu: he is a buffoon, or a boastful youth whose shallow intermeddling is only to be explained by the fewness of his years, the incarnation of folly, or even the Satan himself gone a-mumming. Some moderns on the other hand have regarded him as the incarnation of the voice of God or even of God Himself. The main objections that may be urged against the connexion of the episode of Elihu with the original book are—that the prologue and epilogue know nothing of him; that on the cause of Job's afflictions he occupies virtually the same position as the friends; that his speeches destroy the dramatic effect of the Divine manifestation by introducing a lengthened break between Job's challenge and the answer of God; that the language and style of the piece are marked by an excessive mannerism, too great to have been created by the author of the rest of the poem, even when introducing an interlocutor out of the ranks of the bystanders, and of another race; that the allusions to the rest of the book are so minute as to betray a reader rather than a hearer; and that the views regarding sin, and especially the scandal given to the author by the irreverence of Job, indicate a religious advance which marks a later age. The position taken by Elihu is almost that of a critic of the book. Regarding the origin of afflictions he is at one with the friends, although he dwells more on the general sinfulness of man than on actual sins, and his reprobation of Job's position is even greater than theirs. His anger was kindled against Job because he made himself righteous before God, and against his friends because they found no answer so as to condemn Job. His whole object is to refute Job's charge of injustice against heaven. What is novel in Elihu, therefore, is not his position but entirely his arguments. These do not lack cogency, but betray a kind of thought different from that of the friends. Injustice in God, he argues, can only arise from selfishness in Him; but the very existence of creation implies unselfish love on God's part, for if He thought only of Himself, He would cease actively to uphold creation, and it would fall into death. Again, without justice mere earthly rule is impossible; how then is injustice conceivable in Him who rules over all? It is probable that the original author found his three interlocutors a sufficient medium for expressing all that he desired to say, and that this new speaker is the creation of another. To a devout and thoughtful reader of the original book, belonging perhaps to a more reverential age, it appeared that the language and bearing of Job had scarcely been sufficiently reprobated by the original speakers, and that the religious reason, apart from any theophany, could suggest arguments sufficient to condemn such demeanour on the part of any man.

It is more difficult to come to a decision in regard to some other portions of the book, particularly ch. xxvii. 7—xxviii. In the latter part of ch. xxvii. Job seems to go over to the camp of his opponents, and expresses sentiments in complete contradiction to his former views. Hence



some have thought the passage to be the missing speech of Zophar. Others, as Hitzig, believe that Job is parodying the ideas of the friends; while others, like Ewald, consider that he is offering a recantation of his former excesses, and making such a modification as to express correctly his views on evil. None of these opinions is quite satisfactory, though the last probably expresses the view with which the passage was introduced, whether it be original or not. The meaning of ch. xxviii. can only be that "Wisdom," that is, a theoretical comprehension of providence, is unattainable by man, whose only wisdom is the fear of the Lord or practical piety. But to bring Job to the feeling of this truth was just the purpose of the theophany and the Divine speeches; and, if Job reached it already through his own reflexion, the theophany becomes an irrelevancy. It is difficult, therefore, to find a place for these two chapters in the original work. The hymn on Wisdom is a most exquisite poem, which probably originated separately, and was brought into our book with a purpose similar to that which suggested the speeches of Elihu. Objections have also been raised to the descriptions of leviathan and behemoth (ch. xl. 15-xli). Regarding these it may be enough to say that in meaning these passages are in perfect harmony with other parts of the Divine words, although there is a breadth and detail in the style unlike the sharp, short, ironical touches, otherwise characteristic of this part of the poem.

*Date.*—The age of such a book as Job, dealing only with principles and having no direct references to historical events, can be fixed only approximately. Any conclusion can be reached only by an induction founded on matters which do not afford perfect certainty, such as the comparative development of certain moral ideas in different ages, the pressing claims of certain problems for solution at particular epochs of the history of Israel, and points of contact with other writings of which the age may with some certainty be determined. It may be said without doubt that the book belongs to the period between David and the return from exile. The Jewish tradition that the book is Mosaic, or the other idea that it is a production of the desert, written in another tongue and translated into Hebrew, wants even a shadow of probability. The book is a genuine outcome of the religious life and thought of Israel, the product of a religious knowledge and experience that was possible among no other people. That the author lays the scene of the poem outside his own nation and in the patriarchal age is a proceeding common to him with other dramatic writers, who find freer play for their principles in a region removed from the present, where they are not hampered by the obtrusive forms of actual life, but free to mould occurrences into the moral form that their ideas require.

It is the opinion of many scholars, *e.g.*, Delitzsch, that the book belongs to the age of Solomon. It cannot be earlier than this age, for Job (ch. vii. 17) travesties the ideas of Ps. viii. in a manner which shows that this hymn was well known. Undoubtedly many of the means and conditions necessary for its production existed in this age. It is a creation of that direction of thought known as the Wisdom, a splendid efflorescence of which distinguished this time, unless history and tradition alike are to be altogether discredited. The cosmopolitanism of Solomon's reign, and the close relations into which Israel then entered with Egypt, the further East, and even the West, may seem reflected in the poem, the author of which had seen many lands and strange peoples, and draws his illustrations from many distant sources. When, however, we compare Job with the literature of the Wisdom, presumably of the Solomonic age and even later, the difference is found to be extreme. Job is not only a creation of the Wisdom; it is its highest creation. The literature of the Wisdom falls

into three periods:—the period of principles, referred to above, to which belongs the book of Proverbs; the period of problems, illustrated by such compositions as Ps. xxxvii., xlix., lxxiii., and others; and the period of exhaustion, where a solution of the problems was scarcely sought, and only a *modus vivendi* in the face of them, through a practical prudence, was aimed at, to which belongs Ecclesiastes. Job has no affinity with the last-named period. But it is almost equally impossible that it can belong to the first. The point of view of this period on the question of evil is that represented by Job's friends, a point of view from which our book signalizes a final departure. On the other hand, the spirit of Job is that which breathes in the psalms referred to and in many other fragments of the Scriptures of the prophetic age. Such problems as burn in the pages of Job—the miseries of the just, and the felicity of the ungodly—were not likely to force themselves on men's attention in the Solomonic age. In the settled, well-ordered life of Israel in this happy time, the general principles of moral well-being were receiving their most splendid illustration. Only later, when the state began to receive fatal blows from without, and when through revolution and civil discord at home great and unmerited sufferings befell the best citizens in the state, would such problems rise with an urgency that demanded some solution. In some of the psalms which treat of these questions, the "ungodly" oppressor, whose felicity occasions disquietude to the religious mind, is probably the heathen conqueror. But these shorter pieces in all likelihood preceded in time the elaborate treatment to which such problems are subjected in Job. It is doubtful if there is a trace of such questions in Proverbs, which, however, did not receive its final form till the age of Hezekiah. In one direction the Wisdom receives a higher development in Prov. viii. than it does in Job, but that despair of the attainment by man of any theoretical wisdom at all, which is the burden of Job xxviii., is unheard of even in Prov. i.-ix., which certainly dates from a time long posterior to the Solomonic age. The book of Job probably has behind it some public calamity which forced the question of evil on men's minds with an urgency that could not be resisted. Such a calamity, wide and national, could be nothing less than the dismemberment or subjugation of the state. The question may be difficult to settle whether it was a misfortune befalling the northern kingdom or that of the south. We gain no help here from the book itself, for the author of Job is an Israelite indeed, who belongs to none of its divisions. Somewhere in the troubled period between the early part of the 7th and the early part of the 5th century the poem may have been written. Ewald and many distinguished writers on the book support the earlier date, while on the part of living scholars there is rather a growing feeling that the book is later than some of the prophecies of Jeremiah.

This question has to be settled largely by a comparison of literary coincidences and allusions. This is a very delicate operation. For, first, owing to the unity of thought and language which pervades Scripture, in which, regarding it for a moment merely as a national literature, it differs from all other national literatures, we are apt to be deceived, and to take mere similarities for literary allusions and quotations; and, secondly, even when we are sure that there is dependence, it is often uncommonly difficult to decide which is the original source. The reference to Job in Ezek. xiv. 14 may not be to our book, but to the man who was afterwards made the hero of it. The affinities between Job and Isa. xl.-lxvi. are very close. The date of this part of Isaiah is uncertain, but it cannot have received its final form, if it be composite, long before the return. Its affinity with Job is not only literary; the problem is the

same, the meaning of the afflictions of the "servant" of the Lord. "My servant Job" may not be the same as "my righteous servant" of Isaiah, but there is no doubt national allusion in Job. The solution of the problem differs in the two. In Job's sufferings are a trial of faith, which, successfully borne, issues in restoration. In Isaiah they are vicarious, borne by one element in the nation in behalf of the whole, and issuing in the national redemption. Two such solutions can scarcely be entirely contemporaneous. That of Isaiah is the profounder truth and may be the later, though certainty on such a point is of less consequence than the reflexion both solutions force upon us that this is the period in Israel's history at which the profoundest depths of religious thought were sounded. Between Job iii. and Jer. xx. 14 *sq.* there is certainly literary connexion. The judgment of different minds differs on the question which passage is dependent on the other. The language of Jeremiah has a natural pathos and genuineness of feeling in it, somewhat in contrast with the elaborate poetical finish of Job's words, which might suggest the originality of the former; and there is a growing feeling among many in favour of this view. At the same time a good deal remains yet to be said on both sides.

The book of Job is not literal history, though it reposes on an historical tradition. To this tradition belong probably the name of Job and his country, and the names of his three friends, and perhaps also many other details impossible to specify particularly. The view that the book is entirely a literary creation with no basis in historical tradition is as old as the Talmud, in which a rabbi is cited who says, Job was not, and was not created, but is an allegory. And this view has still supporters, *e.g.*, Hengstenberg. Pure poetical creations on so extensive a scale are not probable in the East and at so early an age.

*Author.*—The author of the book is wholly unknown. No literature has so many great anonymous works as that of Israel. The religious life of this people was at certain periods very intense, and at those times the spiritual energy of the nation expressed itself almost impersonally, through men who forgot themselves and were speedily forgotten in name by others. Hitzig conjectures that the author was a native of the north on account of the free criticism of providence which he allows himself. Others, on account of some affinities with the prophet Amos, infer that he belonged to the south of Judah, and this is supposed to account for his intimate acquaintance with the desert. Ewald considers that he belonged to the exile in Egypt, on account of his minute acquaintance with that country. But all these conjectures localize an author whose knowledge was not confined to any locality, who was a true child of the East and familiar with life and nature in every country there, who was at the same time a true Israelite and felt that the earth was the Lord's and the fulness thereof, and whose sympathies and thought took in all God's works.

*Literature.*—The literature of the book will be found fully given in Delitzsch's commentary, or in Lange's *Bibelwerk*. A few more recent essays may be mentioned bearing on the criticism and the problem of the book: Hoekstra, "Job, de Knecht van Jehovah," in the *Theolog. Tijds.*, 1871, and in reply, Kuenen, "Job en de leidende Knecht van Jahveh," *ibid.*, 1873; Studer, "Ueber die Integrität des Buches Hiob," in the *Jahrb. für Prot. Theologie*, 1875, and *Das Buch Hiob für gebildete Laien*, Bremen, 1881; Budde, *Beiträge zur Kritik des B. Hiob*, Bonn, 1876, with the review of Smend, *Stud. u. Krit.*, 1878; Cheyne, "Job and the second part of Isaiah," *Isaiah*, ii. p. 235 *sq.* (A. B. D.)

**JOB'S TEARS.** The seeds, or properly fruits of Job's tears, *Coix lachryma*, Willd., a species of grass, are contained singly in a stony involucre or bract, which does not open until the enclosed seed germinates. The young involucre surrounds the female flower and the stalk support-

ing the spike of male flowers, and when ripe has the appearance of bluish white porcelain. Being shaped somewhat like a large drop of fluid, the form has suggested the name Job's tears, or *Lachryma Jobi*, under which the plant has been long known. The seeds are esculent, but the involucre is the part chiefly used, for making necklaces and other ornaments. The plant is a native of the East Indies, and was cultivated by Gerard as a tender annual.

JODHPUR, also called MĀRWAR, a native state in Rājputāna, India, situated between 24° 36' and 27° 42' N. lat., and between 70° 6' and 75° 24' E. long. It is bounded on the N. by Bikaner and Jeypore states, on the E. by Jeypore and Kishangarh, on the S. by Sirohi and Pālanpur states, and on the W. by the Rann of Kachchh (Rann of Cutch) and the British district of Thar and Pārkar in Sind. The general aspect of the country is that of a sandy plain, divided into two unequal parts by the river Lūni, and dotted with bold and picturesque conical hills, attaining in places an elevation rising to 3000 feet. The river Lūni is the principal feature in the physical aspects of Jodhpur. It takes its rise in the sacred lake of Pushkar in Ajmere, and flows through Jodhpur in a south-westerly direction till it is finally lost in the marshy ground at the head of the Rann of Cutch. It is fed by numerous tributaries and occasionally overflows its banks, fine crops of wheat and barley being grown on the saturated soil. Its water is, as a rule, saline or brackish, but comparatively sweet water is obtained from wells sunk at a distance of 20 or 30 yards from the river bank. The famous salt-lake of Sambhar is situated on the borders of Jodhpur and Jeypore, and two smaller lakes of the same description lie within the limits of the district, from which large quantities of salt are annually extracted. Zinc is also obtained in considerable quantities, and marble is mined in the north of the state, and along the south-east border.

The population consists of the Rahtor Rājputs (who form the ruling class), Charans, Bhāts, Jāts, Bishnawis, Minas, Bhils, and Bauris, with a small proportion of Mahometans. The Charans, a sacred race, hold large religious grants of land, and enjoy peculiar immunities as traders in local produce. The Bhāts are by profession genealogists, but also engage in trade. The Minas, Bauris, and Bhils are predatory classes, but are employed in menial capacities. The Mahometans are principally soldiers. The natives, as a race, are enterprising and industrious, but the agricultural classes have to undergo great privations from poor food, and often bad water. Mārwarī traders are to be found throughout the length and breadth of the peninsula. No census of the population has ever been taken, but it has roughly been estimated at about 2,850,000, of whom 86 per cent. are said to be Hindus, 10 per cent. Jains, and 4 per cent. Mahometans.

The principal crops are pulses and millets, but wheat and barley are largely produced in the fertile tract watered by the Lūni river. The manufactures comprise leather boxes and brass utensils; and turbans and scarfs and a description of embroidered silk knotted thread are specialities of the country. A large proportion of the population can read and write Hindī, including most ladies of good birth, which is believed to be peculiar to this state. Jodhpur town contains two good schools, one for the sons of chiefs and the higher classes, and the other for the children of tradespeople downwards. Every large village also has a school of its own, in which the vernacular is taught.

The māharāja belongs to the Rahtor clan of Rājputs. The local historians relate that after the downfall of the Rahtor dynasty of Kanauj in 1194 at Sivaji, the grandson of Jāi Chānda, the last king of Kanauj, entered Mārwar on a pilgrimage to Dwarka, and on halting at the town of Pāli he and his followers settled there to protect the Brāhman community from the constant raids of marauding bands. The Rahtor chief thus laid the foundation of the state, but it was not till the time of Rāo Chānda, the tenth in succession from Sivaji, that Mārwar was actually conquered. His grandson Jodha founded the city of Jodhpur, which he made his



capital. In 1561 the country was invaded by Akbar, and the chief was forced to submit, and to send his son as a mark of homage to fake service under the Mughal emperor. When this son Udái Sinh succeeded to the chiefship, he gave his sister Jodhbái in marriage to Akbar, and was rewarded by the restoration of most of his former possessions. Udái Sinh's son, Rájá Geve Sinh, held high service under Akbar, and conducted successful expeditions in Guzerat and the Deccan. The bigoted and intolerant Aurangzeb invaded Márwar in 1679, plundered Jodhpur, sacked all the large towns, and commanded the conversion of the Rahtors to Mahometanism. This cemented all the Rájput clans into a bond of union, and a triple alliance was formed by the three states of Jodhpur, Udáipur, and Jeypore, to throw off the Mahometan yoke. One of the conditions of this alliance was that the chiefs of Jodhpur and Jeypore should regain the privilege of marriage with the Udáipur family, which they had forfeited by contracting alliances with the Mughal emperors, on the understanding that the offspring of Udáipur princesses should succeed to the state in preference to all other children. The quarrels arising from this stipulation lasted through many generations, and led to the invitation of Marhattá help from the rival aspirants to power, and finally to the subjection of all the Rájput states to the Marhattás. Jodhpur was conquered by Sindhia, who levied from it a tribute of £60,000, and took from it the fort and town of Ajmere. Intercourse disputes and succession wars disturbed the peace of the early years of the century, until in January 1818 Jodhpur was taken under British protection. In 1839 the misgovernment of the rájá led to an insurrection which compelled the interference of the British, and Jodhpur was held in military occupation for five months, until the rájá entered into engagements for the future good government of his subjects. In 1843 the chief having died without a son, and without having adopted an heir, the nobles and state officials were left to select a successor from the nearest of kin. Their choice fell upon Rájá Takht Sinh, chief of Ahmadnagar. This chief, who did good service during the mutiny, died in 1873. The constitution of Jodhpur may be described as a tribal suzerainty rapidly passing into the feudal stage. The *patkail* or tribal chief is the ruler of his estate, and the judge almost exclusively in all matters of civil and criminal jurisdiction over his people. These chiefs owe military service to their suzerain, and exact the same from their dependants, to whom assignments of land have been made, and who form their following—the whole constituting the following of the suzerain himself. The maharájá alone has the power of life and death. The revenue of the state is mainly derived from the land, salt, and customs duties, a cess imposed on the feudatory nobles, succession dues, &c., estimated at a total of about £250,000 a year. The state pays a tribute to the British of £9800 a year, besides an annual payment of £11,500 for the support of a contingent—the Eripura Irregular Force. The maharájá also maintains an independent military force of 20 field and 250 other guns, 200 gunners, 3545 cavalry, and 5020 infantry.

JODHPUR, the capital of the above state, in 26° 17' N. lat. and 73° 4' E. long., was built by Ráo Jodha in 1549, and from that time has been the seat of government of the principality. It is surrounded by a strong wall nearly 6 miles in extent, with seventy gates. The fort stands on an isolated rock, and contains the maharájá's palace, a large and handsome building, completely covering the crest of the hill on which it stands, and overlooking the city, which lies several hundred feet below. The city contains many handsome buildings—palaces of the maharájá, and town residences of the *thákurs* or nobles, besides numerous fine temples and tanks. Building stone is plentiful, and close at hand, and the architecture solid and handsome. Three miles north from Jodhpur are the ruins of Mandor, the site of the ancient capital of the Purihar princes of Márwar, prior to its conquest by the Rahtors.

JOEL. The second book among the minor prophets is entitled *The word of Jehovah that came to Joel the son of Pethuel*, or, as the Septuagint, Latin, Syriac, and other versions read, *Bethuel*. Nothing is recorded as to the date or occasion of the prophecy, which presents several peculiarities that aggravate the difficulty always felt in interpreting an ancient book when the historical situation of the author is obscure. Most Hebrew prophecies contain pointed references to the foreign politics and social relations of the nation at the time. In the book of Joel there are only scanty allusions to Phœnicians, Philistines, Egypt, and Edom, couched in terms applicable to very different ages,

while the prophet's own people are exhorted to repentance without specific reference to any of those national sins of which other prophets speak. The occasion of the prophecy, described with great force of rhetoric, is no known historical event, but a plague of locusts, perhaps repeated in successive seasons; and even here there are features in the description which have led many expositors to seek an allegorical interpretation. The most remarkable part of the book is the eschatological picture with which it closes; and the way in which the plague of locusts appears to be taken as foreshadowing the final judgment—the great day or assize of Jehovah, in which Israel's enemies are destroyed—is so unique as greatly to complicate the exegetical problem. It is not therefore surprising that the most various views are still held as to the date and meaning of the book. Allegorists and literalists still contend over the first and still more over the second chapter, and, while the largest number of recent interpreters accept Credner's view that the prophecy was written in the reign of Joash of Judah, a rising and powerful school of critics follow the view suggested by Vatke (*Bib. Theol.*, p. 462 *sq.*), and reckon Joel among the post-exile prophets. Other scholars give yet other dates: see the particulars in the elaborate work of Merx, *Die Prophetie des Joels und ihre Ausleger*, Halle, 1879. The followers of Credner are literalists; the opposite school of moderns includes some literalists (as Duhm), while others (like Hilgenfeld, and in a modified sense Merx) adopt the old allegorical interpretation which treats the locusts as a figure for the enemies of Jerusalem.

The reasons for placing Joel either earlier or later than the great series of prophets extending from the time when Amos first proclaimed the approach of the Assyrian down to the Babylonian exile are cogent. In Joel the enemies of Israel are the nations collectively, and among those specified by name neither Assyria nor Chaldæa finds a place. This circumstance might, if it stood alone, be explained by placing Joel with Zephaniah in the brief interval between the decline of the empire of Nineveh and the advance of the Babylonians. But it is further obvious that Joel has no part in the internal struggle between spiritual Jehovah-worship and idolatry which occupied all the prophets from Amos to the captivity. He presupposes a nation of Jehovah-worshippers, whose religion has its centre in the temple and priesthood of Zion, which is indeed conscious of sin, and needs forgiveness and an outpouring of the Spirit, but is not visibly divided, as the kingdom of Judah was, between the adherents of spiritual prophecy and a party whose national worship of Jehovah involved for them no fundamental separation from the surrounding nations. The book, therefore, must have been written before the ethico-spiritual and the popular conceptions of Jehovah came into conscious antagonism, or else after the fall of the state and the restoration of the community of Jerusalem to religious rather than political existence had decided the contest in favour of the prophets, and of the Law in which their teaching was ultimately crystallized.

The considerations which have given currency to an early date for Joel are of various kinds. The absence of all mention of one great oppressing world-power seems most natural before the westward march of Assyria involved Israel in the general politics of Asia. The purity of the style is also urged, and a comparison of Amos i. 2, Joel iii. 16 (Heb., iv. 16), and Amos ix. 13, Joel iii. 18 (iv. 18), has been taken as proving that Amos knew our book. The last argument might be inverted with much greater probability, and numerous points of contact between Joel and other parts of the Old Testament (*e.g.*, Joel ii. 2, Exod. x. 14; Joel ii. 3, Ezek. xxxvi. 35; Joel iii. 10, Mic. iv. 3) make it not incredible that the purity of his style—which is rather elegant than original and strongly marked—is in

large measure the fruit of literary culture. The absence of allusion to a hostile or oppressing empire may be fairly taken in connexion with the fact that the prophecy gives no indication of political life at Jerusalem. When the whole people is mustered in chap. i., the elders or sheikhs of the municipality and the priests of the temple are the most prominent figures. The king is not mentioned,—which on Credner's view is explained by assuming that the plague fell in the minority of Joash, when the priest Jehoiada held the reins of power,—and the princes, councillors, and warriors necessary to an independent state, and so often referred to by the prophets before the exile, are altogether lacking. The nation has only a municipal organization with a priestly aristocracy, precisely the state of things that prevailed under the Persian empire. That the Persians do not appear as enemies of Jehovah and His people is perfectly natural. They were hard masters but not invaders, and under them the enemies of the Jews were their neighbours, just as appears in Joel.<sup>1</sup> Those, however, who place our prophet in the minority of King Joash draw a special argument from the mention of Phœnicians, Philistines, and Edomites (iii. 4 *sq.*, 19), pointing to the revolt of Edom under Joram (2 Kings viii. 20) and the incursion of the Philistines in the same reign (2 Chron. xxi. 16, xxii. 1). These were recent events in the time of Joash, and in like manner the Phœnician slave trade in Jewish children is carried back to an early date by the reference in Amos i. 9. This argument is rather specious than sound. Edom's hostility to Judah was incessant, but the feud reached its full intensity only after the time of Deuteronomy (xxiii. 7), when the Edomites joined the Chaldeans, drew profit from the overthrow of the Jews, whose land they partly occupied, and exercised barbarous cruelty towards the fugitives of Jerusalem (Obad. *passim*; Mal. i. 2 *sq.*; Isa. lxiii.). The offence of shedding innocent blood charged on them by Joel is natural after these events, but hardly so in connexion with the revolt against Joram.

As regards the Philistines, it is impossible to lay much weight on the statement of Chronicles, unsupported as it is by the older history, and in Joel the Philistines plainly stand in one category with the Phœnicians, as slave dealers, not as armed foes. Gaza in fact was a slave emporium as early as the time of Amos (i. 6), and continued so till Roman times.

Thus, if any inference as to date can be drawn from chap. iii., it must rest on special features of the trade in slaves, which was always an important part of the commerce of the Levant. In the time of Amos the slaves collected by Philistines and Tyrians were sold *en masse* to Edom, and presumably went to Egypt or Arabia. Joel complains that they were sold to the Grecians (Javan, Ionians).<sup>2</sup> It is probable that some Hebrew and Syrian slaves were exported to the Mediterranean coasts from a very early date, and Isa. xi. 11 already speaks of Israelites captive in these districts as well as in Egypt, Ethiopia, and the East. But the traffic in this direction hardly became extensive till a later date. In Deut. xxviii. 68 Egypt is still the chief goal of the maritime slave trade, and in Ezek. xxvii. 13 Javan exports slaves to Tyre, not conversely. Thus the allusion to Javan in Joel better suits a later date, when Syrian slaves were in special request in Greece.<sup>3</sup> And the name of Javan is not found in any part of the Old Testament certainly older than Ezekiel. In Joel it seems to stand as a general representative of the distant countries reached by the Mediterranean (in contrast with the southern Arabians, *Sabæans*, chap. iii. 8), the farthest nation reached by the fleets of the Red Sea. This is precisely the geographical standpoint of the post-exile author of Gen. x. 4, where Javan includes Carthage and Tartessus.

<sup>1</sup> On the Authorized Version of ii. 17 it appears that subjection to a foreign power is not a present fact but a thing feared. But the parallelism and ver. 19 justify the now prevalent rendering, "that the heathen should make a mock of them."

<sup>2</sup> The hypothesis of an Arabian Javan, applied to Joel iii. 6 by Credner, Hitzig, and others, may be viewed as exploded. See Stade, *De Populo Javan*, Giessen Programme, 1880.

<sup>3</sup> Compare Movers, *Phönizisches Alterthum*, III. i. p. 70 *sq.*

Finally, the allusion to Egypt in Joel iii. 19 must on Credner's theory be explained of the invasion of Shishak a century before Joash. From this time down to the last period of the Hebrew monarchy Egypt was not the enemy of Judah.

If the arguments chiefly relied on for an early date are so precarious or can even be turned against their inventors, there are others of an unambiguous kind which make for a date in the Persian period. It appears from chap. iii. 1, 2 that Joel wrote after the exile. The phrase "to bring again the captivity" would not alone suffice to prove this, for it is used in a wide sense, and perhaps means rather to "reverse the calamity;"<sup>4</sup> but the dispersion of Israel among the nations, and the allotment of the Holy Land to new occupants, cannot fairly be referred to any calamity less than that of the captivity. With this the whole standpoint of the prophecy agrees. To Joel Judah and the people of Jehovah are synonyms; northern Israel has disappeared. Now it is true that those who take their view of the history from Chronicles, where the kingdom of Ephraim is always treated as a sect outside the true religion, can reconcile this fact with an early date. But in ancient times it was not so; and under Joash, the contemporary of Elisha, such a limitation of the people of Jehovah is wholly inconceivable. The earliest prophetic books have a quite different standpoint; otherwise indeed the books of northern prophets and historians could never have been admitted into the Jewish canon. Again, the significant fact that there is no mention of a king and princes, but only of sheikhs and priests, has a force not to be invalidated by the ingenious reference of the book to the time of Joash's minority and the supposed regency of Jehoiada.<sup>5</sup> And the assumption that there was a period before the prophetic conflicts of the 8th century when spiritual prophecy had unchallenged sway, when there was no gross idolatry or superstition, when the priests of Jerusalem, acting in accord with prophets like Joel, held the same place as heads of a pure worship which they occupied after the exile (comp. Ewald, *Propheten*, i. 89), is not consistent with history. It rests on the old theory of the antiquity of the Levitical legislation, so that in fact all who place that legislation later than Ezekiel are agreed that the book of Joel is also late. In this connexion one point deserves special notice. The religious significance of the plague of drought and locusts is expressed in chap. i. 9 in the observation that the daily meat and drink offering are cut off, and the token of new blessing is the restoration of this service, chap. ii. 14. In other words, the daily offering is the continual symbol of gracious intercourse between Jehovah and His people and the main office of religion. This conception, which finds its parallel in Dan. viii. 11, xi. 31, xii. 11, is quite in accordance with the later law. But under the monarchy the daily oblation was the king's private offering, and not till Ezra's reformation did it become the affair of the community and the central act of national worship (Neh. x. 33 *sq.*).<sup>6</sup> That Joel wrote not only after the exile but after the work of Ezra and Nehemiah may be viewed as confirmed by the allusions to the walls of Jerusalem in chap. ii. 7, 9. Such is the historical basis which we seem to be able to lay for the study of the exegetical problems of the book.

The style of Joel is clear, and his language presents little difficulty beyond the occurrence of several unique words, which in part may very well be due to errors of the text.<sup>7</sup>

<sup>4</sup> See Ewald on Jer. xlvi. 47, and Kuenen, *Theol. Tijdschrift*, 1873, p. 519 *sq.*

<sup>5</sup> Stade not unreasonably questions whether 2 Kings xii. 1-3 implies the paramount political influence of Jehoiada. *Op. cit.*, p. 17.

<sup>6</sup> See Wellhausen, *Geschichte Israels*, p. 78 *sq.*



But the structure of the book, the symbolism, and the connexion of the prophet's thoughts have given rise to much controversy. It seems safest to start from the fact that the prophecy is divided into two well-marked sections by chap. ii. 18, 19a. According to the Massoretic vocalization, which is in harmony with the most ancient exegetical tradition as contained in the LXX., these words are historical: "Then the Lord was jealous, . . . and answered and said unto his people, Behold," &c. Such is the natural meaning of the words as pointed, and the proposal of Merx to change the pointing so as to transform the perfects into futures, and make the priests pray that Jehovah will answer and deliver the gracious promises that fill the rest of the book, is an exegetical monstrosity not likely to find adherents.

Thus the book falls into two parts. In the first the prophet speaks in his own name, addressing himself to the people in a lively description of a present calamity caused by a terrible plague of locusts which threatens the entire destruction of the country, and appears to be the vehicle of a final consuming judgment (the day of Jehovah). There is no hope save in repentance and prayer; and in chap. ii. 12 the prophet, speaking now for the first time in Jehovah's name, calls the people to a solemn fast at the sanctuary, and invites the intercession of the priests. The calamity is described in the strongest colours of Hebrew hyperbole, and it seems arbitrary to seek too literal an interpretation of details, e.g., to lay weight on the four names of locusts, or to take chap. i. 20 of a conflagration produced by drought, when it appears from ii. 3 that the ravages of the locusts themselves are compared to those of fire. But when due allowance is made for Eastern rhetoric, there is no occasion to seek in this section anything else than literal locusts. Nay, the allegorical interpretation, which takes the locusts to be hostile invaders, breaks through the laws of all reasonable writing; for the poetical hyperbole which compares the invading swarms to an army (ii. 4 sq.) would be inconceivably lame if a literal army was already concealed under the figure of the locusts. Nor could the prophet so far forget himself in his allegory as to speak of a victorious host as entering the conquered city like a thief (ii. 9). The second part of the book is Jehovah's answer to the people's prayer. The answer begins with a promise of deliverance from famine, and of fruitful seasons compensating for the ravages of the locusts. In the new prosperity of the land the union of Jehovah and His people shall be sealed anew, and so the Lord will proceed to pour down further and higher blessings: The aspiration of Moses (Num. xi. 29) and the hope of earlier prophets (Isa. xxxii. 15, lix. 21; comp. Jer. xxxi. 33) shall be fully realized in the outpouring of the Spirit on all the Jews and even upon their servants (compare Isa. lxi. 5 with lvi. 6, 7); and then the great day of judgment, which had seemed to overshadow Jerusalem in the now averted plague, shall draw near with awful tokens of blood and fire and darkness. But the terrors of that day are not for the Jews but for their enemies. The worshippers of Jehovah on Zion shall be delivered (comp. Obad. ver. 17, whose words Joel expressly quotes in chap. ii. 32), and it is their heathen enemies, assembled before Jerusalem to war against Jehovah, who shall be mowed down in the valley of Jehoshaphat (*Jehovah judgeth*) by no human arm but by heavenly warriors. Thus definitively freed from the profane foot of the stranger (comp. Isa. lii. 1), Jerusalem shall abide a holy city for ever. The fertility of the land shall be such as was long ago predicted in Amos ix. 13, and streams issuing from the temple, as Ezekiel had described in his picture of the restored Jerusalem (Ezek. xlvi.), shall fertilize the barren Wady of Acacias. Egypt and Edom, on the other hand, shall be desolate, because they have shed the blood of

Jehovah's innocents. Compare the similar predictions against Edom, Isa. xxxiv. 9 sq. (Mal. i. 3), and against Egypt, Isa. xix. 5 sq., Ezek. xxix. Joel's eschatological picture appears indeed to be largely a combination of elements from older unfulfilled prophecies. Its central feature, the assembling of the nations to judgment, is already found in Zeph. iii. 8, and in Ezekiel's prophecy concerning Gog and Magog, where the wonders of fire and blood named in Joel ii. 30 are also mentioned (Ez. xxxviii. 22). The other physical features of the great day, the darkening of the lights of heaven, are a standing figure of the prophets from Amos v. 6, viii. 9, downwards. It is characteristic of the prophetic eschatology that images suggested by one prophet are adopted by his successors, and gradually become part of the permanent scenery of the last times; and it is a proof of the late date of Joel that almost his whole picture is made up of such features. In this respect there is a close parallelism, extending to minor details, between Joel and the last chapters of Zechariah.

That Joel's delineation of the final deliverance and glory attaches itself directly to the deliverance of the nation from a present calamity is quite in the manner of the so-called prophetic perspective. But the fact that the calamity which hurls so largely is natural and not political is characteristic of the post-exile period. Other prophets of the same age speak much of dearth and failure of crops, which in Palestine then as now were aggravated by bad government, and were far more serious to a small and isolated community than they could ever have been to the old kingdom. It was indeed by no means impossible that Jerusalem might have been altogether undone by the famine caused by the locusts; and so the conception of these visitants as the destroying army, executing Jehovah's final judgment, is really much more natural than appears to us at first sight, and does not need to be explained away by allegory. The chief argument relied upon by those who still find allegory at least in chap. ii. is the expression הַצִּפְּנִי, "the Northener," in ii. 20. In view of the other points of affinity between Joel and Ezekiel, this word inevitably suggests Gog and Magog, and it is difficult to see how a swarm of locusts could receive such a name, or if they came from the north could perish, as the verse puts it, in the desert between the Mediterranean and the Dead Sea. The verse remains a *crux interpretum*, and no exegesis hitherto given can be deemed thoroughly satisfactory; but the interpretation of the whole book must not be made to hinge on a single word in a verse which might be altogether removed without affecting the general course of the prophet's argument.

The whole verse is perhaps the addition of an allegorizing glossator. The prediction in ver. 19, that the seasons shall henceforth be fruitful, is given after Jehovah has shown His zeal and pity for Israel, not of course by mere words, but by acts, as appears in verses 20, 21, where the verbs are properly perfects recording that Jehovah hath already done great things, and that vegetation has already revived. In other words, the mercy already experienced in the removal of the plague is taken as a pledge of future grace not to stop short till all God's old promises are fulfilled. In this context ver. 20 is out of place. Observe also that in ver. 25 the locusts are spoken of in the plain language of chap. i.

For the literature on Joel in common with the other minor prophets, see HOSIA. There are separate commentaries by Credner (Halle, 1831), Wünsche (Leips., 1872), Merx (Halle, 1879). The last-named gives an elaborate history of interpretation from the Septuagint down to Calvin, and appends the Ethiopic text edited by Dillmann. Of older commentaries the most valuable is Pococke's (Oxford, 1691). Boehart's *Hierozoicon* may also be consulted. (W. R. S.)

JOHN, the Apostle (יְהוֹנָן), "Jehovah hath been gracious"), was the son of Zebedee, a Galilean fisherman, and Salome. It is probable that he was born at Bethsaida, where along with his brother James he followed his father's occupation. The family appear to have been in easy circumstances; at least we find that Zebedee employed hired servants, and that Salome was among the number of those

women who contributed to the maintenance of Jesus; he himself was perhaps related to Annas the high priest (John xviii. 15, 16). It seems to have been when attending as a disciple the preaching of John the Baptist at Bethany beyond Jordan that he first became personally acquainted with our Lord (John i. 35 sq.); his "call" to follow Him occurred simultaneously with that addressed to his brother and to Andrew and Peter (Mark i. 19, 20). He speedily took his place among the twelve apostles, sharing with James the title of Boanerges ("sons of thunder"), became a member of that inner circle to which, in addition to his brother, Peter alone belonged, and ultimately was recognized as the disciple *par excellence* whom Jesus loved, a distinction usually attributed to his amiability and gentleness of character, but much less probably due to any special sweetness of temperament (see Luke ix. 54; Mark iii. 17, ix. 38) than to a quickness and depth of insight which enabled him to enter more fully than his companions into the larger and wider-reaching views of his Master. After the departure of Jesus John remained at Jerusalem, where he was one of the most prominent among those who bore personal testimony to the fact of the resurrection; we find him for a short time in Samaria (Acts viii. 14, 25) after the martyrdom of Stephen, but on Paul's second visit to the Jewish capital (Gal. ii. 9) John was again there. His subsequent movements are obscure, but he can hardly have been in Jerusalem at the time of Paul's last visit there in 58 A.D.

At this point the history of the apostle is taken up by ecclesiastical tradition. Polycrates, bishop of Ephesus, 196 A.D. (in Euseb., *H. E.*, iii. 31; v. 24), attests that John "who lay on the bosom of the Lord" died at Ephesus; and, though this evidence is weakened by the legendary trait that he "was a priest wearing the *πέταλον*" or gold plate that distinguished the high-priestly mitre, it is fair to infer that the grave of the apostle was already shown (comp. *H. E.*, iii. 39). Irenæus in various passages of his works confirms this tradition. He says that John lived up to the time of Trajan, and published his Gospel in Ephesus. Irenæus also identifies the apostle with John the disciple of the Lord, who wrote the Apocalypse under Domitian, whom his teacher Polycarp had known personally, and of whom Polycarp had much to tell. These traditions are accepted and enlarged by later authors, Tertullian adding that John was banished to Patmos after he had miraculously survived the punishment of immersion in boiling oil. As it is evident that legend was busy with John as early as the time of Polycrates, while Irenæus's view that the Apocalypse was written under Domitian is inconsistent with the internal evidence offered by that book, the real worth of these traditions requires to be tested by examination of their ultimate source. This inquiry has been pressed upon scholars since the apostolic authorship of the Apocalypse or of the Fourth Gospel or of both these works has been disputed. See GOSPELS and REVELATION. The question is not strictly one between advanced and conservative criticism, for the Tubingen school recognized the Apocalypse as apostolic, and found in it a confirmation of John's residence in Ephesus. On the other hand, Lützelberger (1840), Keim (*Jesu v. Nuz.*, vol. i., 1867), Holtzmann (in *Bibel-Lex.*, s.v.), Scholten (*Theol. Tijdsch.*, 1871), and other recent writers wholly reject the tradition, while it has able defenders in Steitz (*Stud. u. Krit.*, 1868), Hilgenfeld (*Eint.*, 1875, p. 394 sq.; *Z. f. W. T.* 1872, 1877), and Lightfoot (*Contemp. Rev.*, 1875, 1876).

The opponents of the tradition lay weight on the absence of positive evidence before the latter part of the 2d century, especially in Papias, and in the epistles of Ignatius and of Irenæus's authority Polycarp. But they also find it necessary to assume that Irenæus mistook Polycarp, and that John "the disciple of the Lord," who was known to the latter, was not the apostle but a certain presbyter John of whom we hear from Papias. This view would be at once refuted if we could hold with some scholars that the presbyter is but another name for the apostle. This identification had already supporters to the time of Jerome (*Vir. Ill.*, 9; comp. Usener, *Acta S. Timothei*, Bonn, 1877), but seems inconsistent with a fair reading of the words of Papias. It is therefore very possible that some things which Irenæus in his later years supposed Polycarp to have related of the apostle really belong to the other John (see GOSPELS, x. 520); but it is a much stronger thing to assume that he was mistaken in supposing that Polycarp had conversed with the apostle at all. An altogether independent and apparently inconsistent tradition that John was killed by the Jews is given on the authority of Papias by Georgeus Hamartolus in the 9th century.

JOHN, EPISTLES OF. Of the three Epistles which are ascribed to the apostle John, the First is by far the most important, both from the space which it occupies in the canon and from the weightiness of its teaching.

FIRST EPISTLE.—*Title*.—Some exception has been taken to the title "epistle" as applied to this document, seeing that it bears the name neither of sender nor of recipient, and carries with it no definiteness of message to a special correspondent. But, though it may be admitted that with regard to its literary form it would more properly be described as a homily or discourse, the frequently recurring terms "I wrote," "I have written," imply that the message was written, not orally delivered.

*Genuineness*.—The external evidence for the genuineness of this epistle is weighty. Polycarp, a disciple of John, writes with evident reference to 1 John iv. 3: *πᾶς γὰρ ὁς ἂν μὴ ὁμολογῇ Ἰησοῦν Χριστὸν ἐν σαρκὶ ἐληλυθῆναι ἀντιχριστός ἐστιν* (*Ad Phil.*, vii.). Eusebius, writing of Papias (*H. E.*, iii. 39), says: *Κέχρηται δ' ὁ αὐτὸς μαρτυρίας ἀπὸ τῆς Ἰωάννου προτέρας ἐπιστολῆς καὶ ἀπὸ τῆς Πέτρου ὁμοίως*.<sup>1</sup> The epistle was frequently cited by Irenæus, a disciple of Polycarp, as we learn both from the statement of Eusebius (*H. E.*, v. 8) and from his extant work against heretics (*Adv. Hæret.*, iii. 16, v. and viii.). The two epistles of St John mentioned in the canon of Muratori are probably the Second and Third, but the absence of reference to the First in that particular connexion implies its acknowledged canonicity; moreover, the same canon contains a citation of 1 John i. 1, 4. The early fragment called the letter to Diognetus has unmistakable allusions to the Johannine epistles. The Peshito contains the epistle, and there is an undoubted reference to it in the letter from the churches of Vienne and Lyons. All those authorities belong to the first two centuries. In the succeeding centuries the volume of evidence grows. Eusebius reckons the epistle among the *Homologoumena* or writings of acknowledged authority, and the testimony of Tertullian, Clemens Alexandrinus, Origen, and Cyprian, in addition to the evidence already adduced, indicates its reception in all the churches.<sup>2</sup>

To those who accept the Fourth Gospel as John's, the strength of the internal evidence for the Johannine authorship of the epistle lies in the similarity of words, of teaching, and of style between the two writings. This similarity is so marked that it requires no argumentative proof. It is a similarity not only of diction, or of parallel expressions and peculiarities of style, but one which is penetrated by the more subtle correspondence of under-currents of thought and of implied knowledge. See on this part of the subject Westcott, *Introduction to the Gospel of St John*, p. lxi. sq., in the *Speaker's Commentary*; and Davidson's *Introduction to the Study of the New Testament*, ii. 293 sq. On the other hand, the very closeness of the connexion between the epistles and the gospel has necessarily involved the former in the assaults of recent criticism upon the genuineness of the latter.<sup>3</sup> Some critics, however, while admitting the similarity of style, contend that there are differences of doctrine between the gospel and epistle which preclude identity of authorship. The main points advanced in behalf of this statement are—the supposed differences in eschatological views, the application of the term "Paraclete" to the work of the Holy Spirit in the gospel and to the office of Christ alone in the epistle, the introduction into the epistle of such terms as *ἰασμός* and *χρίσμα*, which are not found in the gospel, and, lastly, the polemical and

<sup>1</sup> See, however, for exceptions that may be taken to these testimonies, GOSPELS, vol. x. pp. 820, 822.

<sup>2</sup> The epistle was not included in the Marcionite canon, and the *Logi*, as they are sect so named by Epiphanius (*Hæc.*, i. 1-3), seem to have neglected this, together with the other writings of St John.

<sup>3</sup> See GOSPELS, vol. x. p. 828.



strongly anti-Docetic tone which is said to distinguish the epistle from the gospel. Such differences, however, are in part more apparent than real (they are certainly not contradictions), and in part may be naturally explained by the changed circumstances in which the two writings were composed and the different aims proposed in them. On this point see Westcott, p. lxxxviii., and Reuss, *Introduction*, p. 358 sq.

*Date.*—The date of the epistle must remain in uncertainty; but it is generally viewed as later in composition than the gospel. "The phrases in the gospel," writes Professor Westcott, "have a definite historic connexion; they belong to circumstances which explain them. The phrases in the epistle are in part generalizations and in part interpretations of the earlier language in view of Christ's completed work, and of the experience of the Christian church." The same writer assigns on good grounds to the gospel as well as to the epistle a date subsequent to the fall of Jerusalem. In this view *ἐρχάτη ὥρα*, ch. ii. 18, must be understood of the approach of the second advent of Christ.

*Occasion and Contents.*—Mr Browning has in his *Death in the Desert* caught the true occasion of the apostle's letter: it was written in view of the time when

"There is left on earth  
No one alive who know (consider this).—  
Saw with his eyes and handled with his hands  
That which was from the first, the Word of Life;  
How will it be when none more saith 'I saw'?"

It is the testimony of the last surviving eyewitness of the Lord, far removed from the scenes and words which he attests, giving, in view of rising error,—Gnostic and Docetic,—the apostolic judgment on questions of the day, and founding the truth of Christian doctrine on a recognition of the historical Christ.

The subject and character of the epistle answer these conditions. The direct testimony to the real existence of Jesus Christ in the flesh, the declaration of spiritual tests (as in ch. i. 6, ii. 29, iii. 19, and in many other passages) which gives an introspective element to the epistle, and, lastly, the impressive re-delivery of familiar truths not freshly defined but exhibited in different mutual relations, are characteristic of an address given by an aged teacher to a generation of men who had not seen the Lord,—from whom therefore objective proof had been withdrawn, and who in consequence would desire some clear testimony of the facts about Jesus, and some definite tests of communion with God and of the reality of their spiritual condition. It is an address to the instructed. Much therefore is taken for granted; many elementary principles and truths of the Christian life are left unnoticed, and religious terms frequent in other parts of the New Testament are absent from this epistle. The apostle writes "because they have known Him that was from the beginning" (ii. 13), and his aim is a deepening of the spiritual life and a confirmation of faith.

After an introduction, giving his credentials as a witness and stating his aim, the apostle delivers his message to the church, "God is light" (i. 5). This thought is the subject of the epistle; it is illustrated by the opposite of light—darkness, and by analogous pairs of opposites, in which the principal theme is exhibited in different aspects: these are—righteousness and sin, truth and falsehood, love and hate, God and the world, life and death. To those ideas, which are in truth varied expressions of one and the same idea, the apostle turns and returns, not repeating himself, but on each reiteration of the truth adding some fresh thought and deeper truth. Through these opposites runs another thought—judgment or decision,—which is viewed not as a future but as an ever-present fact in the Christian life.

After the delivery of his message (*ἀγγελία*) the apostle proceeds to set forth some effects of the "light,"—fellowship with one another, confession of sin, forgiveness of sin (i. 5-10). This suggests one aspect of the object of the "message," freedom from sin, the test of which, *i.e.*, in other words, the test of knowing God, is observance of His commandments, which are summed up in love (*ἀγάπη*) (ii. 1-11). Here the apostle reminds his readers why he sends the message; it is because (*ὅτι*) they to whom it comes are Christians, whose sins have been forgiven, who have known Christ, who have conquered Satan; it comes to all,—to little children, to young men, to the aged (ii. 12-14). Therefore let them not love the world nor the things of the world (ii. 15-17). Hence the thought of the end of the world and the signs thereof. Of these one is the Antichrist. There are now many Antichrists even in the nominal church. But there is a test of the true Christian,—to have the Father, the Son, the unction (*χρῖσμα*) of the Holy Spirit, and the truth (ii. 18-28).

A new section begins with the thought of sonship of God. The test of sonship is doing righteousness because God is righteous. Sonship is a proof of the Father's love; and the condition of it is likeness to the Father (ii. 28-iii. 9). The connexion is then traced between righteousness and love (10-13), between love and life, and hate and death (14, 15). This suggests the range of love,—self-sacrifice even to death (16-18). Truth (suggested by reality of love) is shown to be tested by keeping the commandments, the first of which is love (19-23), the result is the indwelling of Christ which the Spirit testifies (24). The mention of the Spirit leads the apostle's thoughts once more, as in ch. ii. 18 sq., to the distinction between true spirits and false. The test is the same, the acknowledgment that Christ has come in the flesh (iv. 1-6). The thought of the true Christian as distinguished from the false again suggests mutual love, which springs from God's love to us manifested by the mission of Christ. Mutual love is a proof of the indwelling Christ (7-13). Here the apostle pauses to bear impressive witness to the mission of Christ and the love of God (14-16), and then resumes the subject of love. A result of perfect love is confidence in the day of judgment. But absence of brotherly love means want of love to God (17-21). For the test of brotherly love is love to God, which consists in keeping His commandments through the faith in Jesus Christ that overcomes the world (v. 1-5). Jesus Christ then is the object of faith. Faith brings its own evidence, and its evidence is that God gave eternal life (6-12). To effect the knowledge of this (the possession of eternal life), and the belief in the Son of God, were the apostle's objects in writing. Such knowledge and belief bring assurance, from which results certainty of answer to prayer. The instance given is intercessory prayer (13-17). In conclusion the apostle recapitulates some of the leading truths dwelt upon in the epistle.

From this brief summary it will be seen that the sections are sometimes linked together by a manifest chain of reasoning, and that sometimes the concluding word in one paragraph suggests the fresh train of thought in the next. Some expositors detect a more logical sequence in the epistle: But the varying results of their expositions go to prove the improbability that the apostle had in view any such systematic arrangement. See, however, Düsterdieck, whose scheme is mainly followed by Alford, and Davidson, *Introduction to the Study of the New Testament*.

*Where Written and to Whom Addressed.*—The epistle was probably written at Ephesus, where the most ancient tradition places the closing scenes of St John's life, and addressed to the church of Ephesus; or as an encyclical letter to the churches of Asia. In some Latin MSS., how-

ever, and in St Augustine's *Quæst. Evang.*, ñ. 39, the address *ad Parthos* is found. Bede adds testimony to the same effect. But such a destination of the epistle is unlikely in itself, receives no support from the Greek Church, and is opposed to ecclesiastical tradition. Hence the best criticism rejects the superscription. It is variously accounted for. Whiston, in his *Commentary on the Epistles* (1719), suggests that the original address was *πρὸς παρθένους*, and that this abbreviated appeared in Latin as *ad Parthos*; according to others it is a corruption of *ad Sparsos*, "to the dispersed."

Before textual criticism was studied scientifically, much controversy turned upon the words contained in vers. 7 and 8 of ch. v. The disputed passage, *ἐν τῷ οὐρανῷ . . . ἐν τῇ γῆ*, is now omitted by all the leading editors, on indisputable authority.

SECOND AND THIRD EPISTLES.—These are interesting as the only examples of apostolic letters to private persons, except the epistle to Philemon, which have descended to us. Their genuineness is well attested, though with less decisive evidence than that of the First Epistle. Irenæus quotes 2 John 10, 11. Clement of Alexandria (*Strom.*, ii. 66) alludes to the First Epistle in a way which implies another, *ἐν τῇ μείζονι ἐπιστολῇ*. Dionysius of Alexandria (248 A.D.) makes express mention of the Second and Third Epistles; Alexander, bishop of Alexandria, cites a passage from the Second. The Muratorian canon, as already stated, probably contains a reference to the two minor epistles.

On the other hand, Eusebius mentions those epistles among the *ἀπιλεγόμενα*, or disputed writings (*H. E.*, iii. 25); Jerome writes that they were ascribed to John the Presbyter; Cyprian appears never to cite from them in his own writings (though he records words of Bishop Aurelius, who, speaking in a synod, quotes 2 John 9); Tertullian is equally silent; the Peshito does not contain either epistle.

In answer to the doubts thus raised it has been urged that the brevity and unimportance of the two minor epistles sufficiently account for the comparative silence of the first two centuries respecting them; that the existence of John the Presbyter rests on the slender authority of an inference from a statement by Papias (*Eus.*, *H. E.*, iii. 39); that the style and expressions in the disputed epistles are so manifestly Johannine that, if they did not proceed from John the apostle, they must be the work of a conscious imitator, who, if honest, would have used his own name, if an intentional deceiver, that of the apostle; that the term *ὁ πρεσβύτερος* ("the elder," or "the aged"), 2 John 1, 3 John 1, is either a title of dignity or descriptive of age (if the first it may be paralleled by the use of *συμπρεσβύτερος*, 1 Pet. v. 1; if the second, by that of *πρεσβύτερης*, Phil. 9, both applied by an apostle to himself).

The greeting in the Second Epistle *ἐκλεκτῇ κυρίᾳ* is variously interpreted—either (a) of a person (to the elect lady, to the elect Kyria, or to the lady Eclecta), or (b) of a church mystically addressed under a personal appellation. The last hypothesis is unlikely, and is not supported either by New Testament usage or by the early apocryphal writings. If either *ἐκλεκτῇ* or *κυρίᾳ* be a proper name, it is better to regard *κυρία* as such, since *ἐκλεκτός* is a term applied to all the saints, and in this very letter to the lady's sister, ver. 13. On the whole it is more probable that both *ἐκλεκτῇ* and *κυρία* bear their ordinary meanings, and that the A.V. is correct.

The Third Epistle is addressed to Gaius or Caius, a name so common that all identifications must be regarded as purely conjectural. From the epistle we learn that he was a Christian of good report, probably a layman, whom the apostle commends for his hospitality to certain missionaries of the faith who seem to have visited his city. Two other

names are mentioned—Diotrephes, a leading and ambitious presbyter, who had refused to obey the apostle's injunctions, and Demetrius, either the bearer of the epistle or a member of the same church to which Caius belonged.

The time when and the place where these epistles were written must remain unknown from the absence of any data by which to determine them.

The works consulted for this article have been the commentaries of Allford, Ebrard, Lücke, and Reuss on the Epistles, and that of Westcott on the Gospel of St John (*Speaker's Commentary*); Westcott, *The Canon of the New Testament*; Neander's *Planting of Christianity* (Bohn's trans., vol. "ii."); F. D. Maurice's *Lectures on the Epistles of St John*; and Davidson's *Introduction to the New Testament*. There are also commentaries, among others, by Dusterdieck, 1852; Luthardt, 1860; Haupt, 1869; Baur, 1848; Hilgenfeld, 1854, the last two representing the Tübingen school of criticism. (A. C. \*)

JOHN, GOSPEL OF. See GOSPELS, vol. x. p. 818.

JOHN THE BAPTIST, the last of the prophets and the "forerunner" of Christ, was born in a *πάλαις Ἰουδα* (according to rabbinical tradition, at Hebron, but according to an ingenious modern interpretation of the phrase, at Jutta), in the beginning of the second half of the year 749 A.U.C. His father Zechariah was a priest "of the course of Abia"; his mother Elizabeth was related to Mary, the mother of Jesus, whose senior he was by six months. The circumstances of his birth are related with much detail in Luke i., but those of his early years are summed up in the single expression at ver. 80 that he "grew, and waxed strong in spirit, and was in the deserts till the day of his shewing unto Israel." In his thirtieth year (Autumn, 779 A.U.C.) he began his public life in the "wilderness of Judæa," the wild district that lies between the Kidron and the Dead Sea, and particularly in the neighbourhood of the Jordan, where multitudes were attracted by his eloquence. His appearance, costume, and habits of life were such as to recall to the minds of his hearers what they had read about the ancient prophets, and particularly about Elijah, who came to be regarded as his prototype. Nor was his preaching in substance different from theirs: his central doctrine was that "the kingdom of heaven" had come near, and preparation for its speedy arrival by an appropriate change of heart and life was the practical duty he urged. With regard to the nature of the baptism he administered, much uncertainty exists; for some discussion of its origin and meaning, the reader is referred to the article BAPTISM (vol. iii. p. 348-9). Amongst those who resorted to this rite was John's kinsman, Jesus of Nazareth, whom he had foretold, and now acknowledged, as one mightier than himself, the latchet of whose shoes he was not worthy to unloose. The duration of John's ministry cannot be determined with certainty; it terminated in his imprisonment in the fortress of Macherus, to which he had been committed by Herod Antipas, whose incestuous marriage with Herodias the Baptist had sternly rebuked, and where he was beheaded under circumstances which are familiar to every reader of the Bible. The date of this event cannot with safety be placed later than the end of 782 A.U.C. For our knowledge of John the Baptist we are almost entirely dependent on the notices contained in the Gospel narratives, but a brief account of his career is also given by Josephus (*Ant.*, xviii. 5); some legends of an obviously fictitious character are contained in the apocryphal Gospels.

JOHN, the name of twenty-two popes.

JOHN I. (pope from 523 to 526) was a Tuscan by birth, Pope and was consecrated pope on the death of Hormisdas. In 525 he was sent by Theodoric at the head of an embassy to Constantinople to obtain from the emperor Justin toleration for the Arians; but, whether designedly or not, he succeeded so imperfectly in his mission that Theodoric on his return, suspecting that he had acted only halfheartedly, threw him into prison, where he shortly afterwards died, Felix IV. (or



III.) succeeding him. He was enrolled among the martyrs, his day being May 27.

JOHN II. (pope from 532 to 535), surnamed on account of his eloquence Mercurius, was elevated to the papal chair on the death of Boniface II. During his pontificate a decree against simony was engraven on marble and placed before the altar of St Peter's. At the instance of the emperor Justinian he adopted the proposition *unus de Trinitate passus est in carne* as a test of the orthodoxy of certain Scythian monks accused of Nestorian tendencies. He was succeeded by Agapetus I.

JOHN III. (pope from 560 to 573), successor to Pelagius, was descended from a noble Roman family. He is said to have been successful in preventing an invasion of Italy by the recall of the deposed exarch Narses, but the Lombards still continued their incursions, and, especially during the pontificate of his successor Benedict I., inflicted great miseries on the province.

JOHN IV. (pope from 640 to 642) was a Dalmatian by birth, and succeeded Severinus after the papal chair had been vacant four months. While he adhered to the repudiation of the Monothelitic doctrine by Severinus, he endeavoured to explain away the connexion of Honorius I. with the heresy. His successor was Theodorus I.

JOHN V. (pope from 685 to 686) was a Syrian by birth, and on account of his knowledge of Greek had in 680 been named papal legate to the sixth oecumenical council at Constantinople. He was the successor of Benedict II., and after a pontificate of little more than a year, passed chiefly in bed, was followed by Conon.

JOHN VI. (pope from 701 to 705) was a native of Greece, and succeeded to the papal chair two months after the death of Sergius I. An attempt of the exarch Theophylact of Ravenna to extort from him certain concessions to the Byzantine emperor Tiberius was frustrated by the revolt of the Italian portion of the army with which he threatened Rome, who but for the intervention of the pope would have put their leader to death. Partly by persuasion and partly by means of a bribe, John also succeeded in inducing Gisulph, duke of Benevento, to withdraw from the territories of the church.

JOHN VII. (pope from 705 to 707), successor of John VI., was also of Greek nationality. He declined to accede to the request of the emperor Justinian II. that he should give his sanction to the decrees of the Quinisext or Trullan council of 691, on the ground that a papal legate was not present, and his death shortly afterwards delivered him from the necessity of committing himself to a more decided opinion. He was followed by Sisinnius.

JOHN VIII. (pope from 872 to 882), successor of Adrian II., was a Roman by birth. His chief aim during his occupancy of the papal chair was to build up his temporal power by uniting the various discordant political elements of Italy into a theocracy under his own immediate control, and by subordinating the empire to the ecclesiastical authority of Rome. The qualifications he brought to the task he had undertaken were a resolute and unbending will, an unscrupulous readiness to employ any means that might best advance his purpose, and a thorough mastery of diplomatic intrigue. Events, however, were so fatally opposed to his designs that no sooner did one of his schemes begin to realize itself in fact than it was shattered and dissipated by an unlooked for chance. To take advantage of the opportunity of winning a recognition of the dependence of the imperial authority on that of Rome, as well as to obtain an influential alliance against his enemies, he agreed, in 875, to bestow the imperial crown on Charles the Bald, but that monarch was too much occupied in Germany to grant him much effectual aid, and about the time of the death of Charles he found it necessary to come

to ignominious terms with the Saracens, who were only prevented from entering Rome by the promise of an annual tribute. Carloman, the opponent of Charles's son Louis, soon after invaded northern Italy, and, securing the support of the bishops and counts, demanded from the pope the imperial crown. John attempted to temporize, but Duke Lambert of Spoleto, a partisan of Carloman, whom events had recalled to Germany, entered Rome in 878 with an overwhelming force, and for thirty days virtually held him a prisoner in St Peter's. He was, however, unsuccessful in winning any concession from the pope, who after his withdrawal carried out a previous purpose of going to France. There he presided at the council of Troyes, which promulgated a ban of excommunication against the supporters of Carloman—amongst others Adalbert of Tuscany, Lambert of Spoleto, and Formosus, bishop of Porto, who was afterwards elevated to the papal chair. In 879 John returned to Italy accompanied by Duke Boso of Provence, whom he adopted as his son, and made an unsuccessful attempt to get recognized as king of Italy. In the same year he was compelled to give a promise of his sanction to the claims of Charles the Fat, who received from him the imperial crown in 881. Previous to this, in order to secure the aid of the Greek emperor against the Saracens, he had agreed to sanction the restoration of Photius to the see of Constantinople, and had withdrawn his consent on finding that he reaped from the concession no substantial benefit. Charles the Fat, partly from unwillingness, partly from natural inability, gave him also no effectual aid, and the last years of John VIII. were spent chiefly in hurling vain anathemas against his various political enemies. According to the annalist of Fulda, he was murdered by members of his household. His successor was Martin I.

JOHN IX. (pope from 898 to 900) was of German birth, and belonged to the Benedictine order. He not only confirmed the judgment of his predecessor Theodore II. in granting Christian burial to Formosus, but at a council held at Ravenna decreed that the records of the synod which had condemned him should be burned. Finding, however, that it was advisable to cement the ties between the empire and the papacy, John gave unhesitating support to Lambert in preference to Arnulf, and also induced the council to determine that henceforth the consecration of the popes should take place only in the presence of the imperial legates. The sudden death of Lambert shattered the hopes which this alliance seemed to promise. John was succeeded by Benedict IV.

JOHN X. (pope from 914 to 928) was a canon at Bologna when he attracted the attention of the empress Theodora, through whose influence he was elevated first to that see and then to the archbishopric of Ravenna. In direct opposition to a decree of council, he was also at the instigation of Theodora promoted to the papal chair as the successor of Lando. Like John IX. he endeavoured to secure himself against his temporal enemies through a close alliance with the imperial power and the establishment of an independent Italian kingdom. With this view he in December 915 granted the imperial crown to Berengar, and with the assistance of the imperial troops and the forces of the duke of Benevento and Naples he took the field in person against the Saracens, over whom he gained a great victory on the banks of the Garigliano. The defeat and death of Berengar through the combination of the Italian princes again frustrated the hopes of a united Italy subservient to papal purposes, and after witnessing several years of anarchy and confusion John perished through the intrigues of Marozia, daughter of Theodora. His successor was Leo VI.

JOHN XI. (pope from 931 to 936) was born in 906, the son of Marozia and the reputed son of Sergius III. Through the influence of his mother he was chosen to

succeeded Stephen VII. at the early age of twenty-one. He was the mere exponent of the purposes of his mother, until her son Alberic succeeded in 933 in overthrowing their authority. The pope was kept a virtual prisoner in the Lateran, where he is said to have died in 936, in which year Leo VII. was consecrated his successor.

JOHN XII. (pope from 955 to 964) was the son of Alberic, whom he succeeded as patrician of Rome in 954, being then only sixteen years of age. His original name was Octavian, but when he assumed the papal tiara as successor to Agapetus II., he adopted the apostolic name of John, the first example, it is said, of the custom of altering the surname in connexion with elevation to the papal chair. As a temporal ruler John was devoid of the vigour and firmness of his father, and his union of the papal office—which through his scandalous private life he made a byword of reproach—with his civil dignities proved a source of weakness rather than of strength. In order to protect himself against the intrigues in Rome and the power of Berengar II. of Italy, he called to his aid Otho the Great of Germany, to whom he granted the imperial crown in 962. Even before Otho left Rome the pope had, however, repented of his recognition of a power which threatened altogether to overshadow his authority, and had begun to conspire against him, on whom he had newly conferred the dignity of emperor. His intrigues were discovered by Otho, who after he had defeated and taken prisoner Berengar, returned to Rome and summoned a council which deposed John, who was in hiding in the mountains of Campania, and elected Leo VIII. in his stead. An attempt at an insurrection was made by the inhabitants of Rome even before Otho left the city, and on his departure John returned at the head of a formidable company of friends and retainers, and caused Leo to seek safety in immediate flight. Otho determined to make an effort in support of Leo, but before he reached the city John had died, in what manner is uncertain, and Benedict V. had mounted the papal chair.

JOHN XIII. (pope from 965 to 972) was descended from a noble Roman family, and at the time of his election as successor to Leo VIII. was bishop of Narni. He had been somewhat inconsistent in his relations with his predecessor Leo, but his election was confirmed by the emperor Otho, and his submissive attitude towards the imperial power was so distasteful to the Romans that they expelled him from the city. On account of the threatening procedure of Otho, they permitted him shortly afterwards to return, upon which, with the sanction of Otho, he took savage vengeance on those who had formerly opposed him. Shortly after holding a council along with the emperor at Ravenna in 967, he gave the imperial crown to Otho II. at Rome in assurance of his succession to his father; and in 972 he also crowned Theophania as empress immediately before her marriage. On his death in the same year, he was followed by Benedict VI.

JOHN XIV. (pope from 983 to 984), successor to Benedict VII., was born at Pavia, and before his elevation to the papal chair was imperial chancellor of Otho II. Otho died shortly after his election, and, taking advantage of the opportunity, Boniface VII., on the strength of the popular feeling against the new pope, returned from Constantinople and placed John in prison, where he died either by starvation or poison.

JOHN XV. (pope from 985 to 996) is now generally recognized as the successor of Boniface VII., the pope of the same name who was said to have ruled for four months after the murder of Boniface being now omitted by the best authorities. John XV. was the son of Leo, a presbyter in Gallina Alba. At the time he mounted the papal chair Crescentius was patrician of Rome, but, although his influence was on this account very much hampered, the

presence of the empress Theophania in Rome from 989 to 991 restrained also the ambition of Crescentius. On her departure the pope, whose venality and nepotism had made him very unpopular with the citizens, found it necessary to flee to Tuscany. The news of the approach of Otho III. made it possible for him soon afterwards to return, but he died of fever before the arrival of Otho, who elevated his own kinsman Bruno to the papal dignity under the name of Gregory V.

JOHN XVI. (pope or antipope from 997 to 998) was a Calabrian Greek by birth, and a favourite of the empress Theophania, from whom he had received the bishopric of Placentia. His original name was Philagathus. In 995 he was sent by Otho III. on an embassy to Constantinople to negotiate a marriage with a Greek princess. On his way back he either accidentally or at the special request of Crescentius visited Rome. A little before this Gregory V., in the beginning of 997, had been compelled to flee from the city; and the wily and ambitious Greek had now no scruple in accepting the papal tiara from the hands of Crescentius, to whom he consented to give up the temporal authority on condition that he recognized his subordination to the Western empire. The arrival of Otho at Rome in the spring of 998 put a sudden end to the treacherous compact. John sought safety in flight, but was discovered in his place of hiding and brought back to Rome, where after enduring cruel and ignominious tortures he was immured in a dungeon.

JOHN XVII., whose original name was Sieco, succeeded Silvester II. as pope in June 1003, but died in less than five months afterwards.

JOHN XVIII. (pope from 1003 to 1009) was, during his whole pontificate, the mere creature of the patrician John Crescentius, and ultimately he abdicated and retired to a monastery, where he died shortly afterwards. His successor was Sergius IV.

JOHN XIX. (pope from 1024 to 1033) succeeded his brother Benedict VIII., both being members of the powerful house of Tusculum. He merely took orders to enable him to ascend the papal chair, having previously been a consul and senator. He displayed his freedom from ecclesiastical prejudices, if also his utter ignorance of ecclesiastical history, by agreeing, on the payment of a large bribe, to grant to the patriarch of Constantinople the title of an oecumenical bishop, but the general indignation which the proposal excited throughout the church compelled him almost immediately to withdraw from his agreement. On the death of the emperor Henry II. in 1024 he gave his support to Conrad II., who along with his consort was crowned with great pomp at St Peter's in Easter of 1027. In 1033 a conspiracy of the nobles compelled the pope to flee from Rome, but he was restored by Conrad, and died the same year in the full possession of his dignities. A successor was found for him in his nephew Benedict IX., a boy of only twelve years of age.

JOHN XXI. (pope from 1276 to 1277), successor to Adrian V., should, according to the order observed above, be named John XX., but there is an error in the reckoning through the insertion of an antipope before John XV. or some time after John XIX. At the time of his elevation to the papal chair he was cardinal-bishop of Tusculum, and he had previously been archbishop of Braga. He was a Portuguese by birth, and his original name was Pedro Juliani. The son of a physician, he had studied with distinction at Paris, was the author of several medical and scholastic treatises, and is mentioned by some chroniclers as a magician. His small affection for the monks, his unecclesiastical tone and habits, free and unaffected intercourse with every class of men, and proficiency in secular science, awakened against him



the jealousy and distrust of the clergy, but probably his comprehensive and liberal policy would have shed exceptional lustre on the church had not his life been brought to a premature close through the fall of the roof which he had planned for one of his rooms in the palace of Viterbo. His successor was Nicholas III.

JOHN XXII. (pope from 1316 to 1334) was born at Cahors about 1244. His original name was Jacques d'Esuse, and his father is said to have been a cobbler. Tradition also affirms that the son learned the same employment, but afterwards he was taken charge of by his uncle, a successful merchant, who rose to be chancellor of Robert of Sicily. Through the instruction of a Franciscan friar, Jacques d'Esuse acquired, besides an acquaintance with theology, a mastery of canon and civil law which afterwards stood him in good stead; but, although he was also versed in all the details of statemanship, his learning was saturated with scholasticism, and his political ideas were narrowed by a mean and paltry ambition, the principal element of which was a miserly love of gold. He was small in stature and slightly deformed, and his features are said to have unpleasantly indicated his special moral defects. It is uncertain whether he ever joined the Franciscan order, but at any rate he afterwards had intimate connexions with the court of Naples, and some time before 1300 he was, at the instance of the king, appointed by Boniface VIII. bishop of Frejus. By means of forged letters purporting to have the authority of the king of Naples, Clement V. was induced in 1310 to bestow upon him the see of Avignon; and, notwithstanding that the fraud was soon discovered, he so recommended himself to the pope by his prudent conduct and his knowledge of law that in 1312 he was named cardinal-bishop of Porto. Robert of Naples also condescended to forget the liberty that had been taken in the use of the royal seal, and, on the death of Clement V. in 1316, the cardinals, through the liberal expenditure of Neapolitan gold, were won over to elect the bishop of Porto to the papal chair. The leanings of the new pope towards the French party were at once shown by his choice of Avignon as his residence, and by his first promotion of cardinals, all of whom except one were French. During the strife for the empire between Louis of Bavaria and Frederick of Austria, John took no active part on either side, but made use of the opportunity quietly to establish an Italian kingdom under the rule of King Robert of Sicily, and after fortune declared for Louis at the battle of Muhldorf in 1322 continued to act as if the imperial throne were still vacant. In consequence of this, Louis found himself compelled to enter into a league with the Ghibellines, whereupon the pope summoned him to appear before him at Avignon, and, on his declining immediate compliance with the request, promulgated against him a ban of excommunication. The empire was offered to Charles the Fair of France, who had married a daughter of the emperor Henry VII., but her death lost him his chief support in Germany; and Louis, owing in a great measure to the influence of the Franciscans, whom the persecutions of John had greatly incensed against the authority of Rome, was accepted as emperor with the unanimous consent of the states at Ratisbon in 1324, a decision fully confirmed by the diet of Spire in 1326. In the following year he experienced equal goodwill at the diet of the imperial feudatories at Trent. After receiving the crown of Italy at Milan he entered Rome with the general acclamation of the inhabitants, and was crowned emperor by two excommunicated bishops. But, although the election of Peter of Corvara as rival pope under the name of Nicholas V. was greeted with the loud approval of the citizens, the threatening attitude of Robert of Naples made it impossible for the emperor and antipope to prolong their stay in Rome, and

afterwards a gradual reaction against the imperial cause took place throughout the whole of Italy. Nicholas was taken prisoner at Pisa, but on making a complete recantation of his errors was forgiven and absolved. With Louis, however, the pope altogether declined to come to terms, although he found it impossible to establish a rival against him. The last years of John were disquieted by a dispute regarding his tenet—held by most theological authorities to be heretical—that the saints at death fall asleep and do not enjoy the beatific vision until after the resurrection. So great latterly became the general clamour against the doctrine that he found it necessary to make an ambiguous semblance of retracting what he had formerly promulgated with passionate zeal. He, however, never showed any tendency to relent in his persecution of the Franciscans, and his persistent animosity against them was a not unimportant element among the influences which produced the Reformation. He died in 1334. By means of *annates* he had greatly enriched the papal treasury. His successor was Benedict XII.

JOHN XXIII. (pope from 1410 to 1415) was born in Naples about 1360. He was of noble descent, his original name being Balthasar Cossa. In his youth he had, along with his brothers, served as a corsair, and at the university of Bologna, which he afterwards entered, he led a loose and intemperate life. After occupying the office of archdeacon of Bologna, he became chamberlain of Boniface IX., and in that office greatly enriched both himself and the pope by his unscrupulous traffic in indulgences. In recognition of the high value of his services he was in 1402 created by Boniface a cardinal, and shortly afterwards he was appointed papal legate to Bologna, which he succeeded in wresting from the Visconti. The scandalous and cruel excesses in which he indulged when governor of the city caused Gregory XII. to pass against him a sentence of excommunication, but he was restored to his full dignities by Alexander V. The death of this pope, which took place suddenly at Bologna in 1410, was generally believed to have been contrived by the governor, but the cardinals were unanimous in electing him his successor, other two popes, Benedict XIII. and Gregory XII., the predecessors of Alexander, being still alive. Previously John had entered into a close alliance with Louis of Anjou, and he now united with him against Ladislaus of Naples, but notwithstanding the victory of Rocca Secca in 1411 he found it necessary to come to ignominious terms with Ladislaus in 1412. The compact was, however, congenial to neither party, and in the following year Ladislaus, advancing on Rome, compelled the pope to flee to Florence and thence to Bologna. In his extremity John implored the protection and help of the emperor Sigismund, who condescended to acknowledge him to the extent at least of requiring him to summon a council at Constance by which his claims and that of the other two rival popes should be decided. John opened the council in person in 1414, but, after consenting to abdicate preliminarily to the council deciding on his claims, he made his escape in disguise to Freiburg, where he obtained the protection of the duke of Austria. On his refusal to return he was solemnly deposed by the council as guilty of a long list of heinous crimes. The duke of Austria then surrendered him to the emperor, and after he had acknowledged the justice of his sentence he was confined in the castle of Heidelberg. At the end of four years' imprisonment he obtained his freedom, in all probability through a bribe, and, having made his submission to his successor Martin V., he was appointed by him cardinal-bishop of Frascati and dean of the college of cardinals, but he died a few months afterwards.

JOHN I. (925-976), emperor of Constantinople, Greek surnamed on account of his short stature *Zimisces*, was emperor

descended from a distinguished family of Cappadocia, and was the nephew of Nicephorus Phocas, whom he aided to obtain the throne, and with whom he afterwards shared the military command of the empire. Being, however, deprived of this dignity through the intrigues of the emperor's brother Leo, he entered into a conspiracy to assassinate Nicephorus, which was put into execution on the 10th December 969. The reign of Zimisceus is chiefly remarkable for his victories over the Russians, and the conquest of Bulgaria. Afterwards he achieved many brilliant exploits against the Saracens, but on his way home from his Syrian campaign he was seized near Constantinople with a sudden illness, caused it is supposed by poisoning, and died there in January 976.

JOHN II. (1088-1143), Comnenus, surnamed *Kaloiwanes* (John the Good), was the eldest son of the emperor Alexius, whom he succeeded on the throne in 1118. On account of his mild and just reign he has been called the Byzantine Marcus Aurelius, but he displayed little vigour in the internal administration of his kingdom or in expiating the governmental corruptions and abuses he had inherited. Nor did his various successes against the Hungarians, Servians, and Turks, though they won him the high admiration of his soldiers, add much to the stability of his kingdom. He was accidentally killed during a wild-boar hunt on Mount Taurus, 8th April 1143.

JOHN III. (1193-1254), Vatatzes, surnamed *Ducas*, emperor of Nicea, was born in 1193, and **earned for himself** such distinction as a soldier that in 1222 he was chosen to succeed Theodore I. His successes in war, which earned for him great renown, were rendered of little advantage to him through the intrigues of other sovereigns, but he administered the internal affairs of his dominions with much enlightenment and skill, and devoted great attention to agriculture. He died 30th October 1254,—not in 1255 as writers previous to Finlay have generally alleged.

JOHN IV., Lascaris, emperor of Nicea, son of Theodore II., was born about 1250. His father dying in 1258, Michael Palæologus conspired shortly after to make himself regent, and in 1261 dethroned the boy monarch and put out his eyes. John died in prison.

JOHN V. (1329-1411), Cantacuzenus. See CANTACUZENUS, vol. v. p. 27.

JOHN VI. (1332-1391), Palæologus, emperor of Constantinople, born in 1332, was the son of Andronicus III., whom he succeeded in 1341. From 1342 John Cantacuzenus shared the throne with him, till on the abdication of his colleague, who had been virtually the sovereign, he became sole emperor in 1354. His reign was marked by the gradual dissolution of the imperial power through the rebellion of his son Andronicus and the encroachments of the Ottomans, to whom in 1381 John acknowledged himself tributary.

JOHN VII. (1390-1448), Palæologus, emperor of Constantinople, son of Manuel II., was born in 1390, and in 1425 succeeded to the semblance of dominion and the wreck of the empire. To secure the favour of the Latins he consented to the union of the Greek and Roman Churches, which was ratified at Florence in 1439. The union failed of its purpose, but by his prudent conduct towards the Ottomans he succeeded in holding possession of Constantinople till his death in 1448.

**King of England.** JOHN (1167-1216), king of England, youngest son of Henry II. and Eleanor of Aquitaine, and third king of the Plantagenet family, was born December 24, 1167. He was his father's favourite child, and Henry hoped to bestow on him the kingdom of Ireland. The Irish princes did homage to John at Oxford in 1177, and in 1185 he was sent to Ireland. His arrogant behaviour roused the resentment of the natives, and he was recalled in disgrace.

In the last revolt of Richard against Henry, John was base enough to join with his father's enemies. This treachery was the death-blow of Henry II. (1189). Richard, on his accession, made the most ample provision for John, giving him several English counties, and marrying him to the heiress of the great earldom of Gloucester. But he had so little trust in his brother's character that, before his own departure on the third crusade, he bound John to stay away from England for three years. At the end of the term John returned, and harassed Richard's justiciar, William Longchamp. The unpopularity of Longchamp enabled John, aided by the archbishop of Rouen, to lead a revolutionary movement by which Longchamp was deprived of the justiciarship, and John recognized as *summus rex* of the kingdom; but the real power remained with the archbishop of Rouen. When the news of the king's captivity arrived, John entered into an active alliance with Philip II. of France, Richard's malignant enemy, and tried to seize the reins of government, asserting that the king was dead. But he was baffled by the fidelity of Richard's ministers and mother, and at Richard's return his castles had to be surrendered to the king. Richard treated John with great generosity, and for the rest of his reign John gave no further trouble. Richard on his deathbed declared John his heir. The principle of primogeniture, now generally adopted, would have pointed out Arthur of Brittany, son of John's elder brother Geoffrey, as the heir, and Philip II. made himself the champion of Arthur. John made fresh enemies by divorcing his wife, and marrying Isabella, heiress of the count of Angoulême, who was already betrothed to the Count of La Marche. The anger of the La Marche family caused a fresh outbreak of war, in which Arthur became involved. In a misguided attempt to capture his grandmother Eleanor, in the castle of Mirabeau, he was defeated and taken prisoner by John, who marched with great swiftness to his mother's aid. Arthur now disappears from history; and, though there is no certain information about his death, it was generally believed at the time that John murdered him. Philip's court of peers declared John guilty, and sentenced him to forfeiture. John abandoned himself to pleasure, and made no attempt to defend his dominions; he showed such complete indifference, while Philip was reducing castle after castle in Normandy, that it was said he was spell-bound by witchcraft. In 1204 all Normandy was lost. Anjou, Maine, and part of Aquitaine soon followed the fate of Normandy; John made only feeble or abortive attempts to save them. In 1205 his great quarrel with the church began. The monks of Canterbury had elected their sub-prior to the archbishopric, and John had nominated a minister of his own; all parties appealed to Pope Innocent III., who took the matter into his own hands, and ordered the convent proctors to elect Stephen Langton, an Englishman already distinguished by learning and character. John's refusal to accept Langton brought sentence of interdict on his kingdom (1208). He was personally excommunicated in 1209, and in 1211 the pope issued a bull deposing him from his throne; the execution of the decree was committed to Philip, who prepared to invade England. John at last gave way, moved chiefly by a prophecy that on the next Ascension Day he would be no longer king. He made an abject submission to the papal legate Pandulph, agreeing to hold his kingdom henceforth as a tributary fief of the papedom. Thus the ecclesiastical difficulty was settled, but now John had to settle a quarrel with his own people. He had incurred their hatred by his personal vices, by his cruelty and perfidy, of which the supposed murder of Arthur was only one instance among many, and by his exaction of taxes greatly in excess of the customary rates. The barons of the north began the quarrel by refusing to



accompany John on the expedition to France which he planned immediately after his absolution, alleging that their tenures did not oblige them to service abroad. Langton restrained the king from doing immediate vengeance on the barons, and in the meantime an important assembly was held at St Albans (the first to which representatives from the towns are known to have been summoned), at which the justiciar promised in the king's name that the laws of Henry I. should be observed. At an assembly at St Paul's the same year, Langton, who was the moulding spirit of the movement, produced the charter of Henry I., which became the basis of Magna Charta. John was now bent on trying to knit together the Germanic confederacy against Philip, which had been originated by Richard. He showed both policy and energy in this matter, but the barons of Poitou failed him at the critical moment of the war, and his nephew the emperor Otho was utterly defeated by Philip at Bouvines. John was forced to conclude the peace of Chinon (1214), by which he ceded to Philip all his claims on lands lying north of the Loire. He had scarcely returned to England when his barons formed a confederacy against him at Bury St Edmunds. He attempted to bribe the clergy by granting them free election; but they stood firm to the national cause. The city of London gave its adhesion to the barons, and John found himself abandoned by all. He was obliged to grant the demands of the barons, and to sign (at Runnymede, June 15, 1215), the Great Charter, which for two hundred years was to be the watchword of English freedom. John signed the charter without the least intention of keeping it, and he found a powerful ally in his new master Innocent III., who issued a bull against the charter, and suspended Langton. Langton went to Rome to appeal, and the patriot party was thus deprived of its wisest leader. War soon broke out again, but John was able to obtain a host of foreign mercenaries, and the barons were driven to make alliance with France. Louis, son of Philip II., arrived in England in May 1216, and John's unusual audacity and success deserted him at once. In three months the greater part of the country was in the hands of Louis. Yet the national mistrust of the foreigner was already causing a reaction in favour of John, when in marching across the Wash he met with the accident which led to his death. He was overtaken by the tide, lost all his baggage and treasure, and narrowly escaped himself. Vexation and fatigue, aggravated by excess in eating and drinking, brought on an attack of dysentery; with difficulty he reached Newark, where he died October 19, 1216.

The reign of John is a turning point in English history, and marks the beginning of a new era. (1) The separation of Normandy insured the free development of English life, and the absorption of the Norman nobility in the English people. (2) Magna Charta marks the first united attempt of the English people to limit the power of the king. Hitherto the people had been the allies of the royal power against the baronage; for the two following centuries they are leagued with the baronage and the church against royal tyranny. (3) The surrender of John's kingdom to the pope, followed by the opposition of Innocent to English freedom and the papal exactions of the next reign, caused a change of feeling towards the papacy, and led to the anti-Roman legislation which went on from the reign of Edward I. till the Reformation. (E. S. A.)

Kings of France. JOHN I., king of France, son of Louis X. and Clementia of Hungary, was born, after his father's death, 15th November 1316, and only lived seven days.

JOHN II. (1319-1364), surnamed the Good, son of Philip VI. and Jane of Burgundy, was born in 1319, and succeeded his father in 1350. On the 19th September 1356 he was defeated and taken prisoner by the Black Prince at

the battle of Poitiers. He gained his liberty at the peace of Bretigny in 1360; but, his son the duke of Anjou, whom he left as hostage in England, having fled, John thought himself bound to return to captivity. He died in London in 1364. See FRANCE, vol. ix. p. 546.

JOHN II. (1609-1672), Casimir, king of Poland, second son of Sigismund III. and the duchess Constantia of Austria, was born March 21, 1609. After journeying in several countries of Europe, he in 1640 joined the Jesuit order at Rome, and shortly afterwards was chosen cardinal. Subsequently he returned to Poland, where he resided as a layman until the death of his brother, 20th November 1648, when he succeeded him on the throne. In September 1668 he abdicated, after which he went to France, and became abbot of St Germain de Près and of St Martin at Nevers. He died September 16, 1672. For the events of his unfortunate reign see POLAND.

JOHN III. (1624-1696), Sobieski, king of Poland, son of Jakob Sobieski, castellan of Cracow, was born 2d June 1624, at Olesko in Galicia. He so distinguished himself in the defensive wars of Poland that in 1667 he received the supreme command of the army, and on the death of Michael Corybut was chosen king, 20th May 1674. He died June 17, 1696.

JOHN (JOÃO) I. (1357-1433), king of Portugal, the natural son of Pedro I. (el Justicheiro), was born at Lisbon on April 22, 1357, and in 1364 was created grand-master of Aviz. On the death of his lawful brother Ferdinand I., without male issue, in October 1383, strenuous efforts were made in various quarters to secure the succession in the legitimate line for Beatrice, the only child of Ferdinand I., who as heiress apparent had been married to John I. of Castile; but the popular voice declared decisively against an arrangement by which Portugal would virtually have become a Spanish province, and John was after violent tumults proclaimed protector and regent in the following December. In April 1385 he was unanimously chosen king by the estates of the realm at Coimbra, and the coronation took place some little time afterwards. The king of Castile resorted to arms on behalf of his wife, and invested Lisbon, but the besieging army was compelled by the ravages of a pestilence to withdraw, and subsequently by the decisive battle of Aljubarrota (14th August 1385) the stability of John's throne was permanently secured. Hostilities continued, however, with more or less of interruption until the death of John of Castile, without leaving issue by Beatrice, in 1390; and even after that event relations between the two countries continued to be strained. In the meanwhile John went on consolidating the power of the crown at home and the influence of the nation abroad. In 1415 Ceuta was taken from the Moors by his sons who had been born to him by his wife Philippa, daughter of John, duke of Lancaster; specially distinguished in the siege was Prince Henry, afterwards generally known as "the Navigator," who in this and also in the following reign did so much to prepare the way for the position of colonial importance subsequently held by Portugal. Porto Santo and Madeira were occupied respectively in 1419 and 1420. John I., sometimes surnamed "the Great," and sometimes 'father of his country,' died August 11, 1433, in the forty-eighth year of a reign which had been characterized by great prudence, ability, and success; he was succeeded by his son Edward or Duarte, so named out of compliment to Edward III. of England.

JOHN II. (1455-1495), "the Perfect," king of Portugal, succeeded his father, Alphonso V., in August 1481. His first business after ascending the throne was to curtail with a vigorous hand the overgrown power of his aristocracy; noteworthy incidents in the contest were the execution (in 1483) of the duke of Braganza for correspondence with

Castile, and the murder, by the king's own hand, of the youthful duke of Viseu for conspiracy. This reign was signalized by Bartolomneo Dias's discovery of the Cape of Good Hope in 1486, and also by the equipment (1493) of a squadron for exploration of the new world recently discovered by Columbus. The latter proceeding led to disputes with Castile, until the claims of the disputants were adjusted by the famous treaty of Tordesillas (7th June 1494). John II. died, without leaving male issue, in October 1495, and was succeeded by his brother-in-law Emmanuel (Manoel) I.

JOHN III. (1502-1557) of Portugal was born at Lisbon, June 6, 1502, and ascended the throne as successor of his father Emmanuel I. in December 1521. In 1524 he married Catherine, sister to the emperor Charles V., who in turn shortly afterwards married the infanta Isabella, John's sister. Succeeding to the crown at a time when Portugal was at the height of its political power, and Lisbon in a position of commercial importance previously unknown, John III., unfortunately for his dominions, yielded so far to the counsels of the clerical party among his subjects as to consent to the introduction of the Inquisition (about 1526); this led to measures of tyranny and oppression which, notwithstanding the enactment of many wise laws, soon avenged themselves in disastrous consequences to the commercial and social prosperity of his kingdom. The conflicts in which Portugal engaged with the Moors and the Turks during his reign were comparatively unfruitful of results. He died of apoplexy on June 6, 1557, and was succeeded by his grandson Sebastian, then a child of only three years.

JOHN IV. (1603-1656), "the Fortunate," of Portugal, was born at Villaviciosa in March, 1603, succeeded to the dukedom of Braganza in 1630, and married Luisa de Guzman, eldest daughter of the duke of Medina Sidonia, in 1633. By the unanimous voice of the people he was raised to the throne of Portugal (of which he was held to be the legitimate heir) at the revolution effected in December, 1640 by a conspiracy of the nobles against the grievances inflicted by Spain and the insolence of Philip IV.'s minister, the duke of Olivarez. His accession ultimately led to a protracted war with Spain, of which the final issue—the recognized independence of Portugal—did not declare itself until a subsequent reign (1668). He died after a prosperous reign of sixteen years, on November 6, 1656, and was succeeded by his son Alphonso VI.

JOHN V. (1689-1750) of Portugal was born at Lisbon on October 22, 1689, and succeeded his father Pedro II. on December 1706, being proclaimed on January 1, 1707. One of his first acts was to intimate his adherence to the Grand Alliance, which his father had joined in 1703, and his resolution to take his full share in the war then in progress. Accordingly his general Das Minas, along with Lord Galway, advanced into Castile, but sustained the defeat of Almanza (11th April). In October 1708 he married Maria Anna, daughter of Leopold I., thus strengthening the alliance with Austria; the series of campaigns which ensued were equally unsuccessful with the first, but ultimately terminated in a favourable peace with France in 1713 and with Spain in 1715. The rest of his long reign presents no striking features, except that it was characterized by perfect subservience on his part to the clergy, the kingdom being administered by ecclesiastical persons and for ecclesiastical objects to an extent that gave him the best of rights to the title "Most Faithful King," bestowed upon him and his successors by a bull of pope Benedict XIV. in 1748. John V. died on July 31, 1750, and was succeeded by his son Joseph.

JOHN VI. (1769-1826) of Portugal was born at Lisbon May 13, 1769, and received the title of prince of Brazil in

1788. In 1792 he assumed the reins of government in name of his mother Queen Mary I., who had become insane. He himself having been brought up in an unhealthy ecclesiastical atmosphere, and being naturally of a somewhat weak and helpless character, was but ill adapted for the responsibilities he was thus called on to undertake. In 1799 he assumed the title of regent, which he retained until his mother's death in 1816. The political relations of Portugal with England and France from the period of the first coalition against France in 1793 to the treaty of Fontainebleau (1807), by which the partition of the first-named country was agreed upon, will be elsewhere explained (see PORTUGAL). In consequence of the latter treaty the prince of Brazil found it necessary to leave the kingdom (November 1807), and transfer the seat of his government to Rio Janeiro. The occupation and annexation of the whole country immediately ensued; against this he recorded his protest in November 1808, and in a more practical manner by the seizure of French Guiana in the following year. He also entered into alliance with England in 1810, and was a party to the treaty of Paris in 1814. In 1816 he was recognized as king of Portugal on the death of Mary, but he continued to reside abroad; the consequence was the spread of a feeling of natural dissatisfaction, which resulted in the peaceful revolution of 1820, and the proclamation of a constitutional government, to which he swore fidelity on his return to Portugal in 1822. In the same year, and again in 1823, he had to suppress a rebellion led by his son Dom Miguel, whom he ultimately was compelled to banish in 1824. He died at Lisbon, March 26, 1826, and was succeeded by Pedro IV.

JOHN (1801-1873), king of Saxony, brother and successor of Frederick Augustus II., and younger son of Duke Saxony. Maximilian and Caroline of Parma, was born at Dresden 12th December 1801. In youth he showed a special bent towards mathematics, and he also studied with great diligence law and history. His interest in Italian literature having been awakened by a journey to Italy in 1821, he in 1825 printed for private circulation, under the pseudonym of *Philalèthes*, a metrical translation of a portion of Dante's *Inferno*, and in 1829 he published a complete translation of the *Divine Comedy*, with critical and historical notes. At an early age he also took an active part in political life. In 1821 he became a member of the college of finance, of which he was president from 1825 to 1831. From 1831 to 1846 he acted as commander of the national guards. On ascending the throne in 1854 he followed the same enlightened and liberal policy as his brother, and introduced several reforms of great benefit to the country. In the wars of 1866 he sided with Austria against Prussia, and on that account had to submit to the payment of a large sum of money and the cession of the fortress of Königstein at the conclusion of peace. He, however, afterwards entered the North German federation, and his troops took a very prominent and distinguished part in the Franco-Prussian war of 1870-71. He died at Dresden, October 29, 1873.

JOHN (JUAN) I. (1350-1395), king of Aragon, was Spanish born December 27, 1350, and succeeded his father, Pedro IV., in 1387. He left the affairs of his kingdom to a large extent in the hands of his wife Yolande, a granddaughter of John the Good, king of France, while he himself led a life of pleasure and inglorious ease. A characteristic feature of his reign was the encouragement he gave to the poetical institutions of the troubadours, a "consistory of the *Gaya Sciencia*" having been founded at Barcelona under his auspices in 1390. In that year he repelled an attack by the count of Armagnac, who had laid claim to the domains in Majorca previously in possession of his family; and in 1392 he quelled a revolt of the Sardinians



He died in 1395, in consequence of an accident on the hunting field, and was succeeded by his brother Martin.

JOHN II. (1397-1479), king of Aragon from 1458, was the younger son of Ferdinand I. (the Just), and was born June 29, 1397. He was twice married,—first to Blanche, daughter of Charles III. of Navarre, by whom he had three children (Carlos, heir to the crowns of Navarre and Aragon; Blanche, for some time the wife of Henry IV. of Castile; and Eleanor, wife of Gaston, count of Foix); and afterwards (in 1447) to Joanna Henriquez, of the blood-royal of Castile, by whom he became the father of Ferdinand V. (the Catholic). For a long time he acted as lieutenant-general in Aragon for his brother Alphonso V., whom business detained in his Neapolitan dominions; in this capacity he intervened frequently in the affairs of Castile, where his weak and inexperienced kinsman John II. occupied the throne, and on one occasion (1414) he invaded that kingdom, but was defeated at Olmedo. On his second marriage he irritated his son Carlos and the community by sending his queen Joanna to share the administration of Navarre with his son; in the revolt which ensued victory declared for John, Carlos himself being reduced to captivity (1452), in which he was detained for many months. In May 1458 John succeeded his brother in Aragon, Sicily, and Sardinia; but the influence of Joanna Henriquez prevented him from recognizing the legitimate claims of his own eldest son to the reversion; an attempt by Carlos to obtain support in other quarters led to his arrest and imprisonment, from which he was released only after Catalonia had risen in arms and the king of Castile had begun an irruption into Navarre. Shortly after this temporary triumph Carlos was carried off by a fever in September 1461, bequeathing the crown of Navarre to his sister Blanche and her posterity. Ferdinand, the half-brother of Carlos, was now put forward as heir apparent of the Aragonese throne, but the indignant Catalonians raised a revolt which did not come to an end until December 1472. Immediately afterwards John entered upon a war with Louis XI. of France in consequence of disputes about Roussillon and Cerdagne; first successful, but afterwards worsted, this bold and energetic but ambitious and unjust prince died January 20, 1479, before the conclusion of the peace. He was succeeded by Ferdinand V.

JOHN (JUAN) I. 1358-1390), king of Castile and Leon, born in August 1358, was the son of Henry II. ("El Bastardo"), whom he succeeded in 1379. At his accession the Lancasterian claims to the throne of Castile were renewed, and gained the support of Portugal; the result was a war with the latter power, which ended in a marriage (1382) between John and the Portuguese infanta. The peace thus ratified did not subsist long, for, on the death of Ferdinand of Portugal in the following year without male issue, John sought to establish a claim to the succession on behalf of his wife, and crossing the frontier penetrated as far as Lisbon, to which he began to lay siege while John, the grand-master of Aviz, was being proclaimed king. Compelled by pestilence and other unfavourable circumstances to withdraw, he encountered the Portuguese in the neighbourhood of Aljubarrota in August of 1385; the disastrous defeat he there sustained was followed by a descent of John of Gaunt, duke of Lancaster (July 1386), which led to the conclusion of the peace of Tronçoso (1387), in virtue of which the constantly recurring disputes about the crown were settled by the marriage of the crown prince Henry to Catherine, the representative of the Lancasterian claims. The last four years of the reign of John were marked by important legislative reforms in the town brotherhoods (*hermandades*), in the army, and in the system of taxation. In 1390 he was

killed by a fall from his horse, and was succeeded by his son Henry III.

JOHN II. (1404-1454) of Castile and Leon, grandson of the preceding, succeeded to the throne when only twenty-two months old. Until 1412 the regency was shared with his mother Catherine by his uncle Ferdinand (afterwards Ferdinand IV. of Aragon); this period was marked by much internal prosperity and by important conquests from the Moors, especially by the capture of Antequera. Unfortunately for Castile, Ferdinand was called away (in 1412) to occupy the throne of Aragon; but it was not until after the death of Catherine in 1418 that John's weakness and incapacity came to be fully seen. Abandoning himself recklessly to a life of frivolous pleasure, he left the affairs of his kingdom in the hands of a few favourites, such as the archbishop of Toledo and Juan do Velasco. From 1423 onwards he was the tool principally of Alvaro de Luna, a brilliant, ambitious, and crafty courtier. Henceforward the history of his reign is largely a record of the internal commotions, rising sometimes to the height of civil war, occasioned by the nobles' jealousy of Alvaro, and by the oppressions to which the common people were exposed under the absolutist policy of that minister. The period of John II. is chiefly and most favourably remembered in connexion with the history of Castilian literature: a man of some literary turn himself, he was a liberal patron of letters; and his countenance gave an impulse to refinement and culture of literary style, the effects of which were distinctly traceable through several subsequent generations. By his first wife John II. became the father of Henry IV., his successor; the daughter of a second marriage was Isabella, afterwards known as "the Catholic." He died in June 1454.

JOHN, Dux, of Austria (1545-1578), was the bastard son of the emperor Charles V. by Barbara Blomberg, the daughter of a well-to-do citizen of Ratisbon. He was born in that free imperial city (according to a not very probable tradition in the "imperial hostelry" there, which still survives as the inn of the Golden Cross), on February 24, 1545, the anniversary of his father's birth and coronation, and of the battle of Pavia. On another visit to Ratisbon in the following year, after arranging a marriage between the fair Barbara and one of his German courtiers, Hieronymus Piramis Kegell, the emperor carried off the young Geronimo, as he was then conveniently called. The worthy Don Luis de Quijada, to whose care he was hereupon confided, watched over his early childhood with jealous care. It was at first sought to conceal the connexion between the emperor and the child of his declining years, who was brought up in retirement, chiefly in Quijada's castle of Villagarcia in Spain. In the year before the emperor's death, however, the boy was brought into the immediate neighbourhood of San Yuste, where his presence brightened the close of his father's life. In his last will Charles V. acknowledged "Geronimo" as his son, and commended him to the care of his successors, expressing a wish that he should take monastic vows, but that in the event of his declining these a handsome income should be provided for him out of the revenues of Naples.

In September 1559 the boy was publicly recognized by king Philip II. as his brother; and henceforth he resided at court under the name of Don Juan d'Austria as a member of the royal family. With the heir to the throne, the unhappy Don Carlos, his relations were so friendly that, when at the end of the year 1567 the infante was plotting his flight from Spain, he confided his more or less treasonable scheme to his half-brother, and even requested the latter to accompany him on his expedition. A sense of duty, at which it is difficult to cavil, prompted Don John to reveal this unsought confidence to the king, and

thus he helped to bring about the fatal catastrophe, as it proved, of the imprisonment of Don Carlos.

It was not the habit of Philip II. to allow those who served him to choose their own seasons and methods of doing so. The impetuous Don John, whom the king would have preferred to see a monk, had in 1565 been refused permission to serve in the fleet ordered to sail for the relief of Malta; and an express royal command had been needed to bring him back when on the point of making the voyage on his own account. His obedience was rewarded when in 1568 he was appointed to the great office of *capitan general de la mar*. His first actual service, however, was by land, and of a kind unattractive to any but the genuine Spanish blood. In 1569 he was charged with a task, the execution of which the captain-general of Granada, the marquis of Moudejar, had begun, but was unwilling reluctantly to complete. The reformation of the converted Moriscoes had come to mean the suppression of the remnants of their national as well as religious life; and after the insurrection of Aben Humeya had been overcome, the wholesale deportation of all the Moriscoes from their habitations was decreed, and executed on All Saints' Day 1570. Don John cannot be held responsible either for the cruelty of this ordinance, or for the general policy of the war, which from the time when the jealousy of the king had allowed him to take the field, instead of remaining at Granada, he had carried on with vigour and skill. The capture of Guejar had been his first deed of arms (December 1569); it had been followed by that of Galera; and in August 1570 the Alpujarras mountains were cleared of the Moriscoes, of whom more than 10,000 are said to have been killed or captured in the space of a single month.

Before long a nobler crusade engaged the energy of the obedient and successful commander. Philip II., though he was during nearly the whole of his reign engaged in hostilities with the Turks, had hitherto displayed no great vigour in resisting their still unceasing inroads upon the domain of Christendom. His fleet had for the time saved Malta; but Cyprus was torn by the infidel from the Venetians without his having offered timely co-operation for its defence (1571); and the barbarous proceedings of the conquerors had filled Europe with horror and shame. Not even the waters of the Adriatic were secure from the Turkish vessels, and the league which shortly before the loss of Cyprus papal diplomacy had succeeded in knitting between Spain, Venice, and Rome, and which purported to aim at the extinction of the Mahometan power, had as yet remained a dead letter. At length the forces of the allies—208 galleys, 6 galleasses, and a number of smaller craft, with more than 20,000 Spanish, German, and Italian soldiers on board—assembled at Messina. Don John of Austria had been named admiral of the league, with power (granted at the request of Pope Pius V.) of free action after consultation with his captains and the Venetian commander. Thus the day of Lepanto was in every sense his own, though it was his good fortune that the Turks had underestimated his numbers, which were in truth little inferior to theirs. The Christian victory was complete. Only forty of the Turkish vessels effected their escape, the rest being burnt or captured; and 35,000 of their men were slain or captured, while 15,000 Christian galley-slaves were released. At Constantinople apprehensions were even entertained of an immediate attack on the part of the victors. The battle of Lepanto (October 7, 1571) was, as Ranke observes, like that of Actium, a decisive historic struggle between West and East; and the ecstatic joy which it inspired was shared by all Christian Europe. But though, on receiving the great news of a success which seemed in its momentousness to surpass any of his father's achievements, Philip II. had vowed to carry on this

Christian war, jealousy between the allies wasted the immediate fruits of the victory, and the by no means remotely possible consequences of an active Franco-Turkish alliance inclined the king of Spain to keep his brother inactive in Sicily. Soon the ever vigilant suspicions of Philip were aroused by information which he received—partly from the candid Don John himself—as to the visions which (instigated by the inveterate papal habit of giving away kingdoms before they had been conquered) suggested themselves to the restless imagination of the hero of Lepanto. At one time Albania and the Morea entreated him to reign over them, after he should have previously freed them from the Turkish yoke; next, Rhodes besought the aid of his invincible arm for the work of its liberation. Meanwhile, after the Turks had brought together another fleet, he was unable to force them to accept another battle at Navarino (September 1572); and soon afterwards Venice, by concluding a separate treaty of peace with the sultan, put an end to the league which had been victorious at Lepanto. Spain was by herself no match for the Turkish power; and though in 1573 Don John captured Tunis, it was speedily recaptured in the following year.

Although unable to obtain from his brother even so much as the title of an infante of Spain, the ardent spirit of Don John had continued to indulge in wild dreams of a kingdom to be erected by him for himself in those regions which he had successfully disputed with the infidel; and, after suppressing a momentary hankering after the crown of France which the death of Charles IX. had excited, he had solicited the good offices of pope Gregory XIII. towards his establishment as king of Tunis. The pope, however, had destined him for higher things. As yet King Philip had shrunk from taking up the cause of Rome's unfortunate daughter, held captive in heretic England. Might not a share in the throne of three northern kingdoms tempt Don John to become the hero of a second and more rewardful crusade?

In the midst of schemes and dreams such as these Don John was summoned by King Philip to an office which might seem to bring him near to the accomplishment of the most glorious of them all. He was appointed (in 1576) to the government of the Netherlands, vacant by the death of Requesens. The administration of the latter had not been intended to introduce any radical change into the system of his predecessor Alva; his military operations had been only partially successful; and the pacification of Ghent (October 1576), concluded since his death, had greatly improved the prospects of William of Orange and the insurrection. The magic of Don John's name, and the loyal energy of which he had given proof, were to recover what had been lost; and he was willing to undertake a task the accomplishment of which might lead to higher tasks beyond. He was, however, now brought into conflict with an adversary of a very different calibre from his own. He showed himself willing to consent to the demand of the dismissal of the Spanish troops from the Netherlands, hoping to be able to employ them in a descent upon England. William of Orange, by warning Queen Elizabeth of these designs, secured not only her goodwill, but the rarer proof of it in the shape of a sum of money, and at home drew still tighter the alliance established by the Ghent pacification. Hereupon Don John found himself obliged to grant the perpetual edict (February 1577) which in accordance with the pacification dismissed the Spanish troops designed by him for the conquest of England, and held his entry into Brussels (May 1st) amidst popular acclamations. In secret, however, he was counselling and preparing a renewal of the war; and before the end of the summer he took Namur by a stratagem. The answer was the proclamation of Orange as protector of Brabant, and



the nomination as governor-general of the archduke Matthias, under whom Orange continued to hold the actual supremacy, while Don John's control was almost entirely confined to the south-western part of the Netherlands. He now (January 1578) declared war against the insurgent provinces, and the dismissed Spanish troops were soon with other forces reassembling under his standard. A large army brought from Lombardy by Alexander Farnese, prince of Parma (Don John's nephew), raised the Spanish forces to a virtual equality in numbers with those of their opponents; and Farnese's victory of Gemblours (January 31, 1578) hopefully opened the campaign. It remained an open question whether the aid of France (which appeared to be warranted by the arrival with an army of the duke of Anjou, the "protector" of the liberties of the Netherlands), together with the money of England and the men of the Palatinate, would suffice to make the cause of freedom prevail against the determination of Philip, the ambitious devotion of Don John, and the military genius of Alexander Farnese. On the other hand, it seemed doubtful whether the disunion among Philip's adversaries would weaken them more than his parsimony and suspicion vexed the soul and crippled the energies of his brother. Such was the situation when Don John was removed by death. After having shortly before escaped the dagger of an English assassin (a Catholic refugee, who had hoped by the act to secure the pardon of the queen), Don John succumbed to a sudden illness at Namur on October 1, 1578. An altogether unwarranted, but under the circumstances far from inexplicable, suspicion accused King Philip of having by poison brought about the death of a half-brother whose action his jealousy and distrust of all the world except himself had thwarted after Gemblours as after Lepanto. The settlement of the Netherlands, after whatever fashion Don John might have accomplished it, was a harder task than any he ever executed; and the subjection of heretic England to the authority of a Catholic queen seems to posterity a dream more marvellous than were even the actual glories of Lepanto. But his life, which spanned but little more than thirty-three years, was the reverse of an empty or an ignoble one, and though it was full of imperfections and disappointments, yet its enthusiasm shines forth even under the cold shade spread over it by the fraternal jealousy of a Philip II.

The only modern monograph on the life of Don John of Austria is that by Professor W. Havemann (Gotha, 1865), which corrects some of Motley's vivacities. For the rebellion of the Moriscos and the battle of Lepanto see Prescott's *Reign of Philip II.*, and Feroner's *Histoire de Philippe II.* (vols. i. and ii., Paris, 1880); for the battle, see also Ranke's *Die Osmanen u. die Spanische Monarchie* (4th ed., 1877). (A. W. W.)

JOHN OF DAMASCUS. See DAMASCENUS, vol. vi. p. 789.

JOHN OF GAUNT. See LANCASTER, DUKE OF.

JOHN, ST. OF NEPOMUK, OR POMUK (c. 1330–1393), the patron saint of Bohemia, was born at Pomuk about 1330. After studying at the university of Prague he took holy orders and was for some time a priest in the diocese of Prague. In 1372 he is mentioned as imperial notary; in 1380 he became rector of the church of St Gall in Prague, and notary and secretary of the archbishop; and in 1381 he was made doctor of canon law and canon of the metropolitan chapter. He appears to have taken an important part as adviser or supporter of the archbishop John of Janstein in his disputes with King Wenceslaus, and on this account, after suffering cruel torture, he was drowned in the Moldau. The chief events of his life were afterwards adorned with a variety of legends, and in 1729 he was canonized by Benedict XIII. An annual procession in his honour takes place at Prague on May 16. See Abel, *Die Legende vom St Johann von Nepomuk*, Berlin, 1855.

JOHN OF SALISBURY (c. 1115–1180), a distinguished writer of the 12th century, was born at Salisbury in Wiltshire between the years 1110 and 1120. From the cognomen *Parvus*, which he applies to himself, and from the fact that he was of Saxon, not of Norman race, it may be inferred that his name was Short, or Small, or Little. Few details are known regarding his early life or rank in society; but from his own statements it is gathered that he crossed to France about the year 1131, and began regular studies in Paris under Abelard, who had there for a brief period reopened his famous school on Mont St Geneviève. After Abelard's retirement, John carried on his studies under Alberich, Robert of Melun, and Robert Pulleyn. Three years he spent at the great school of Chartres, mainly under William of Conches, though it would seem that he had been a pupil of the founder of the school, Bernard Silvester. Bernard's teaching was distinguished partly by its pronounced Platonic tendency, partly by the stress laid upon literary study of the greater Latin writers; and the influence of the latter feature is noticeable in all John of Salisbury's works. Returning to Paris, he spent some years there, partly as teacher, partly as pupil of Adam de Ponto Parvo and Gilbert de la Porrée. Whether he attended any of the teachers of the Victorin school is uncertain, but his mode of thinking in theological subjects bears unmistakable traces of the peculiar views of these writers. Probably in the year 1147 or 1148 he crossed to England, with a letter of recommendation from Peter of Celli to Theobald, archbishop of Canterbury. For thirteen years he acted as secretary to Theobald, and was frequently ambassador from the English primate to the papal see. During this time he composed his greatest works, published almost certainly in 1159, the *Policraticus*, *sive de Nugis Curialium et de Vestigiis Philosophorum* and the *Metaphisicis*, writings invaluable as storehouses of information regarding the matter and form of scholastic education, and remarkable for their cultured literary style and humanist tendency. After the death of Theobald in 1061, John continued to occupy the post of secretary to his successor, the famous chancellor Thomas Becket, and took an active part in the long disputes between the primate and his sovereign, Henry II. His letters are of great value for the light they throw upon the obscure course of the constitutional struggle then agitating the English world. With Becket he withdrew to France during the king's displeasure; he returned with him in 1169, and was present at his assassination in 1170. In the following years, during which he continued in an influential situation in Canterbury, but at what precise date is unknown, he drew up the *Life of St Thomas à Becket*, and somewhat later the *Life of St Anselm*. In 1176 he was made bishop of Chartres, where he passed the remainder of his life. The date of his death has been variously given as 1182, 1181, or 1180; the strongest reasons are in favour of the last.

John's writings are not in any strict sense philosophical, but they give much information regarding the general currents of thinking at the time, and enable us to understand with much completeness the literary and scientific position of the 12th century. So far as his own views are concerned, they are such as one might expect from a cultured intelligence well versed in practical affairs. His doctrine, on the whole, is a kind of utilitarianism, with a strong leaning, on the side of speculative questions, to the modified, literary scepticism of Cicero. For Cicero, indeed, he has unbounded admiration, and his Latin style, unusually excellent when compared with the average Latinity of the scholastic writers, is evidently moulded on that of Cicero. The remarkable feature of his writings, apart from their value as giving information respecting studies in the 12th century, is their strongly marked humanist tendency. To

some extent this is common to John and to his predecessors in the school of Chartres, but no other writer seems to have possessed so extensive and competent an acquaintance with the great works of Latin classical literature. Of Greek writers he appears to have known nothing at first hand, and very little in translations. The *Timæus* of Plato in the Latin version of Chalcidius was known to him as to his contemporaries and predecessors, and probably he had access to translations of the *Phædo* and *Meno*. Of Aristotle he possessed, in Latin version, the whole of the *Organon*; he is, indeed, the first of the mediæval writers of note to whom the whole was known. Of other Aristotelian writings he appears to have known nothing.

The *Pollæticus* seems first to have been printed in 1476, in folio; a quarto reprint reappeared in 1513, and an octavo in the same year, but from different MS. sources; the most common edition is that of 1639. The *Metaphisicus* was first printed in 1610; the best known edition is that of 1639. The *Eudælicus*, or more correctly *Nathælicus*, was first printed in 1843 by C. Petersen. The collected editions of the works are by J. A. Giles, 5 vols., Oxford, 1848, and by Migne, in the *Patrologia Cursus*, vol. 199,—neither accurate. The most complete study of John of Salisbury is the monograph by Schnarschmidt, *Johnnes Sarrisenis nach Leben und Studien, Schriften und Philosophie*, which is a model of accurate and complete workmanship.

JOHN, PRESTER. See PRESTER JOHN.

JOHNSON, ANDREW (1808-1875), seventeenth president of the United States, was born in Raleigh, North Carolina, December 29, 1808. His youth was passed in such poverty that it was not till during his apprenticeship as tailor that he learned to read. His wife taught him to write and cipher after their marriage. Settling in Greenville, Tennessee, he worked at his trade, and in 1828 began to take an active part in politics, organizing a working man's party, by which he was elected to several local offices. He served in the State legislature; from 1843 till 1853 he was member of Congress; in 1853, and again in 1855, he was elected governor of Tennessee; and in 1857 he took his seat as United States senator from Tennessee. His independence procured him prominence in the senate. In opposition to the general policy of the Democratic party, whose nominee he was, he ardently supported the homestead bill; and, though in the important presidential election of 1860 he had supported Breckenridge and Lane, the candidates of the southern wing of the Democratic party, yet, when Lincoln was elected, Johnson made a strong speech in the senate, denouncing secession, and pledging himself to unconditional support of the Union. This loyalty to the Union subjected him to grave personal danger from the secessionists of Tennessee, when he returned to the State to organize a Union party. In 1862 Lincoln appointed Johnson military governor of Tennessee, a post of difficulty and danger, in which he displayed an amount of energy and ability in dealing with the secessionists that attracted attention in the north, and led to his nomination for the vice-presidency by the Republican convention of 1864, which nominated Lincoln for the presidency. When, a few weeks after his inauguration, the assassination of Lincoln, on April 14, 1865, made Johnson president, his vigorous denunciation of treason as "a crime that must be punished" placed him for a time high in public favour. The rest of his term of office was spent in dissension with Congress as to the conditions upon which the seceding States should be allowed to return to the Union. Johnson vetoed bill after bill; but Congress passed them over his veto. In August 1866 the president, attended by members of his cabinet, made a tour through several of the northern and western States, denouncing the action of Congress as rebellious, and appealing to the people to support him. But at the congressional elections of that year the policy of Congress was endorsed by large majorities. The conflict became still more bitter, and was at last brought to a crisis

by the president's attempts to remove secretary Stanton from office, after the senate had refused its approval. The Republicans in Congress claimed that Johnson had violated the tenure of office law, and on February 24, 1868, the House of Representatives passed a resolution impeaching him for high crimes and misdemeanours. At the trial before the senate the articles of impeachment were not sustained. A two-thirds majority was necessary for conviction; and thirty-five voted "guilty," nineteen "not guilty." On March 4, 1869, Johnson was succeeded in the presidency by U. S. Grant. Retiring to Greenville, he immediately prepared to re-enter public life; and in January 1875 he was elected United States senator. He died July 31, 1875.

JOHNSON, SAMUEL (1709-1784), one of the most eminent English writers of the 18th century, was the son of Michael Johnson, who was, at the beginning of that century, a magistrate of Lichfield, and a bookseller of great note in the midland counties. Michael's abilities and attainments seem to have been considerable. He was so well acquainted with the contents of the volumes which he exposed to sale that the country rectors of Staffordshire and Worcestershire thought him an oracle on points of learning. Between him and the clergy, indeed, there was a strong religious and political sympathy. He was a zealous churchman, and, though he had qualified himself for municipal office by taking the oaths to the sovereigns in possession, was to the last a Jacobite in heart. At his house, a house which is still pointed out to every traveller who visits Lichfield, Samuel was, born on the 18th of September 1709. In the child the physical, intellectual, and moral peculiarities which afterwards distinguished the man were plainly discernible: great muscular strength accompanied by much awkwardness and many infirmities; great quickness of parts, with a morbid propensity to sloth and procrastination; a kind and generous heart, with a gloomy and irritable temper. He had inherited from his ancestors a scrofulous taint, which it was beyond the power of medicine to remove. His parents were weak enough to believe that the royal touch was a specific for this malady. In his third year he was taken up to London, inspected by the court surgeon, prayed over by the court chaplains, and stroked and presented with a piece of gold by Queen Anne. One of his earliest recollections was that of a stately lady in a diamond stomacher and a long black hood. Her hand was applied in vain. The boy's features, which were originally noble and not irregular, were distorted by his malady. His cheeks were deeply scarred. He lost for a time the sight of one eye; and he saw but very imperfectly with the other. But the force of his mind overcame every impediment. Indolent as he was, he acquired knowledge with such ease and rapidity that at every school to which he was sent he was soon the best scholar. From sixteen to eighteen he resided at home, and was left to his own devices. He learned much at this time, though his studies were without guidance and without plan. He ransacked his father's shelves, dipped into a multitude of books, read what was interesting, and passed over what was dull. An ordinary lad would have acquired little or no useful knowledge in such a way; but much that was dull to ordinary lads was interesting to Samuel. He read little Greek; for his proficiency in that language was not such that he could take much pleasure in the masters of Attic poetry and eloquence. But he had left school a good Latinist, and he soon acquired, in the large and miscellaneous library of which he now had the command, an extensive knowledge of Latin literature. That Augustan delicacy of taste which is the boast of the great public schools of England he never possessed. But he was early familiar with some classical writers who were quite unknown to the best



scholars in the sixth form at Eton. He was peculiarly attracted by the works of the great restorers of learning. Once, while searching for some apples, he found a huge folio volume of Petrarch's works. The name excited his curiosity, and he eagerly devoured hundreds of pages. Indeed, the diction and versification of his own Latin compositions show that he had paid at least as much attention to modern copies from the antique as to the original models.

While he was thus irregularly educating himself, his family was sinking into hopeless poverty. Old Michael Johnson was much better qualified to pore upon books, and to talk about them, than to trade in them. His business declined; his debts increased; it was with difficulty that the daily expenses of his household were defrayed. It was out of his power to support his son at either university; but a wealthy neighbour offered assistance; and, in reliance on promises which proved to be of very little value, Samuel was entered at Pembroke College, Oxford. When the young scholar presented himself to the rulers of that society, they were amazed not more by his ungainly figure and eccentric manners than by the quantity of extensive and curious information which he had picked up during many months of desultory but not unprofitable study. On the first day of his residence he surprised his teachers by quoting Macrobius; and one of the most learned among them declared that he had never known a freshman of equal attainments.

At Oxford Johnson resided during about three years. He was poor, even to raggedness; and his appearance excited a mirth and a pity which were equally intolerable to his haughty spirit. He was driven from the quadrangle of Christ Church by the sneering looks which the members of that aristocratical society cast at the holes in his shoes. Some charitable person placed a new pair at his door; but he spurned them away in a fury. Distress made him, not servile, but reckless and ungovernable. No opulent gentleman commoner, panting for one-and-twenty, could have treated the academical authorities with more gross disrespect. The needy scholar was generally to be seen under the gate of Pembroke, a gate now adorned with his effigy, haranguing a circle of lads, over whom, in spite of his tattered gown and dirty linen, his wit and audacity gave him an undisputed ascendancy. In every mutiny against the discipline of the college he was the ringleader. Much was pardoned, however, to a youth so highly distinguished by abilities and acquirements. He had early made himself known by turning Pope's Messiah into Latin verse. The style and rhythm, indeed, were not exactly Virgilian; but the translation found many admirers, and was read with pleasure by Pope himself.

The time drew near at which Johnson would, in the ordinary course of things, have become a bachelor of arts; but he was at the end of his resources. Those promises of support on which he had relied had not been kept. His family could do nothing for him. His debts to Oxford tradesmen were small indeed, yet larger than he could pay. In the autumn of 1731 he was under the necessity of quitting the university without a degree. In the following winter his father died. The old man left but a pittance; and of that pittance almost the whole was appropriated to the support of his widow. The property to which Samuel succeeded amounted to no more than twenty pounds.

His life, during the thirty years which followed, was one hard struggle with poverty. The misery of that struggle needed no aggravation, but was aggravated by the sufferings of an unsound body and an unsound mind. Before the young man left the university, his hereditary malady had broken forth in a singularly cruel form. He had become an incurable hypochondriac. He said long after

that he had been mad all his life, or at least not perfectly sane; and, in truth, eccentricities less strange than his have often been thought ground sufficient for absolving felons, and for setting aside wills. His grimaces, his gestures, his mutterings, sometimes diverted and sometimes terrified people who did not know him. At a dinner table he would, in a fit of absence, stoop down and twitch off a lady's shoe. He would amaze a drawing-room by suddenly ejaculating a clause of the Lord's Prayer. He would conceive an unintelligible aversion to a particular alley, and perform a great circuit rather than see the hateful place. He would set his heart on touching every post in the streets through which he walked. If by any chance he missed a post, he would go back a hundred yards and repair the omission. Under the influence of his dis-ease, his senses became morbidly torpid, and his imagination morbidly active. At one time he would stand poring on the town clock without being able to tell the hour. At another he would distinctly hear his mother, who was many miles off, calling him by his name. But this was not the worst. A deep melancholy took possession of him, and gave a dark tinge to all his views of human nature and of human destiny. Such wretchedness as he endured has driven many men to shoot themselves or drown themselves. But he was under no temptation to commit suicide. He was sick of life; but he was afraid of death, and he shuddered at every sight or sound which reminded him of the inevitable hour. In religion he found but little comfort during his long and frequent fits of dejection; for his religion partook of his own character. The light from heaven shone on him indeed, but not in a direct line, or with its own pure splendour. The rays had to struggle through a disturbing medium; they reached him refracted, dulled, and discoloured by the thick gloom which had settled on his soul, and, though they might be sufficiently clear to guide him, were too dim to cheer him.

With such infirmities of body and of mind, this celebrated man was left, at two-and-twenty, to fight his way through the world. He remained during about five years in the midland counties. At Lichfield, his birthplace and his early home, he had inherited some friends and acquired others. He was kindly noticed by Henry Harvey, a gay officer of noble family, who happened to be quartered there. Gilbert Walmsley, registrar of the ecclesiastical court of the diocese, a man of distinguished parts, learning, and knowledge of the world, did himself honour by patronizing the young adventurer, whose repulsive person, unpolished manners, and squalid garb moved many of the petty aristocracy of the neighbourhood to laughter or to disgust. At Lichfield, however, Johnson could find no way of earning a livelihood. He became usher of a grammar school in Leicestershire; he resided as a humble companion in the house of a country gentleman; but a life of dependence was insupportable to his haughty spirit. He repaired to Birmingham, and there earned a few guineas by literary drudgery. In that town he printed a translation, little noticed at the time, and long forgotten, of a Latin book about Abyssinia. He then put forth proposals for publishing by subscription the poems of Politian, with notes containing a history of modern Latin verse; but subscriptions did not come in, and the volume never appeared.

While leading this vagrant and miserable life, Johnson fell in love. The object of his passion was Mrs Elizabeth Porter, a widow who had children as old as himself. To ordinary spectators the lady appeared to be a short, fat, coarse woman, painted half an inch thick, dressed in gaudy colours, and fond of exhibiting provincial airs and graces, which were not exactly those of the Queensberrys and Lepels. To Johnson, however, whose passions were strong, whose eyesight was too weak to distinguish cerise-

from natural bloom, and who had seldom or never been in the same room with a woman of real fashion, his Titty, as he called her, was the most beautiful, graceful, and accomplished of her sex. That his admiration was unfeigned cannot be doubted; for she was as poor as himself. She accepted, with a readiness which did her little honour, the addresses of a suitor who might have been her son. The marriage, however, in spite of occasional wranglings, proved happier than might have been expected. The lover continued to be under the illusions of the wedding-day till the lady died in her sixty-fourth year. On her monument he placed an inscription extolling the charms of her person, and of her manners; and when, long after her decease, he had occasion to mention her, he exclaimed with a tenderness half ludicrous half pathetic, "Pretty creature!"

His marriage made it necessary for him to exert himself more strenuously than he had hitherto done. He took a house in the neighbourhood of his native town, and advertized for pupils. But eighteen months passed away, and only three pupils came to his academy. Indeed, his appearance was so strange, and his temper so violent, that his schoolroom must have resembled an ogre's den. Not was the tawdry painted grandmother whom he called his Titty well qualified to make provision for the comfort of young gentlemen. David Garrick, who was one of the pupils, used, many years later, to throw the best company of London into convulsions of laughter by mimicking the endearments of this extraordinary pair.

At length Johnson, in the twenty-eighth year of his age, determined to seek his fortune in the capital as a literary adventurer. He set out with a few guineas, three acts of the tragedy of *Irene* in manuscript, and two or three letters of introduction from his friend Walmsley. Never since literature became a calling in England had it been a less gainful calling than at the time when Johnson took up his residence in London. In the preceding generation a writer of eminent merit was sure to be munificently rewarded by the Government. The least that he could expect was a pension or a sinecure place; and, if he showed any aptitude for politics, he might hope to be a member of parliament, a lord of the treasury, an ambassador, a secretary of state. It would be easy, on the other hand, to name several writers of the 19th century of whom the least successful has received forty thousand pounds from the booksellers. But Johnson entered on his vocation in the most dreary part of the dreary interval which separated two ages of prosperity. Literature had ceased to flourish under the patronage of the great, and had not begun to flourish under the patronage of the public. One man of letters, indeed, Pope, had acquired by his pen what was then considered as a handsome fortune, and lived on a footing of equality with nobles and ministers of state. But this was a solitary exception. Even an author whose reputation was established, and whose works were popular—such an author as Thomson, whose *Seasons* were in every library, such an author as Fielding, whose *Pasquin* had had a greater run than any drama since *The Beggar's Opera*—was sometimes glad to obtain, by pawning his best coat, the means of dining on tripe at a cookshop underground, where he could wipe his hands, after his greasy meal, on the back of a Newfoundland dog. It is easy, therefore, to imagine what humiliations and privations must have awaited the novice who had still to earn a name. One of the publishers to whom Johnson applied for employment measured with a scornful eye that athletic though uncouth frame, and exclaimed, "You had better get a porter's knot, and carry trunks." Nor was the advice bad, for a porter was likely to be as plentifully fed, and as comfortably lodged, as a poet.

Some time appears to have elapsed before Johnson was able to form any literary connexion from which he could

expect more than bread for the day which was passing over him. He never forgot the generosity with which Hervey, who was now residing in London, relieved his wants during this time of trial. "Harry Hervey," said the old philosopher many years later, "was a vicious man; but he was very kind to me. If you call a dog Hervey, I shall love him." At Hervey's table Johnson sometimes enjoyed feasts which were made more agreeable by contrast. But in general he dined, and thought that he dined well, on sixpennyworth of meat and a pennyworth of bread at an alehouse near Drury Lane.

The effect of the privations and sufferings which he endured at this time was discernible to the last in his temper and his deportment. His manners had never been courtly. They now became almost savage. Being frequently under the necessity of wearing shabby coats and dirty shirts, he became a confirmed sloven. Being often very hungry when he sat down to his meals, he contracted a habit of eating with ravenous greediness. Even to the end of his life, and even at the tables of the great, the sight of food affected him as it affects wild beasts and birds of prey. His taste in cookery, formed in subterranean ordinaries and *à la mode* beefshops, was far from delicate. Whenever he was so fortunate as to have near him a hare that had been kept too long, or a meat pie made with rancid butter, he gorged himself with such violence that his veins swelled and the moisture broke out on his forehead. The affronts which his poverty emboldened stupid and low-minded men to offer to him would have broken a mean spirit into sycophancy, but made him rude even to ferocity. Unhappily the insolence which, while it was defensive, was pardonable, and in some sense respectable, accompanied him into societies where he was treated with courtesy and kindness. He was repeatedly provoked into striking those who had taken liberties with him. All the sufferers, however, were wise enough to abstain from talking about their beatings, except Osborne, the most rapacious and brutal of booksellers, who proclaimed everywhere that he had been knocked down by the huge fellow whom he had hired to puff the Harleian Library.

About a year after Johnson had begun to reside in London he was fortunate enough to obtain regular employment from Cave, an enterprising and intelligent bookseller, who was proprietor and editor of the *Gentleman's Magazine*. That journal, just entering on the ninth year of its long existence, was the only periodical work in the kingdom which then had what would now be called a large circulation. It was, indeed, the chief source of parliamentary intelligence. It was not then safe, even during a recess, to publish an account of the proceedings of either House without some disguise. Cave, however, ventured to entertain his readers with what he called "Reports of the Debates of the Senate of Lilliput." France was Blefuscu; London was Mildendo; pounds were sprugs; the duke of Newcastle was the Nardac secretary of state; Lord Hardwicke was the Hurgo Hickrad; and William Pulteney was Wingul Pulnub. To write the speeches was, during several years, the business of Johnson. He was generally furnished with notes, meagre indeed, and inaccurate, of what had been said; but sometimes he had to find arguments and eloquence both for the ministry and for the opposition. He was himself a Tory, not from rational conviction—for his serious opinion was that one form of government was just as good or as bad as another—but from mere passion, such as inflamed the Capulets against the Montagues, or the Blues of the Roman circus against the Greens. In his infancy he had heard so much talk about the villainies of the Whigs, and the dangers of the church, that he had become a furious partisan when he could scarcely speak. Before he was three he had insisted on being taken to hear,



Sacheverel preach at Lichfield cathedral, and had listened to the sermon with as much respect, and probably with as much intelligence, as any Staffordshire squire in the congregation. The work which had been begun in the nursery had been completed by the university. Oxford, when Johnson resided there, was the most Jacobitical place in England; and Pembroke was one of the most Jacobitical colleges in Oxford. The prejudices which he brought up to London were scarcely less absurd than those of his own Tom Tempest. Charles II. and James II. were two of the best kings that ever reigned. Laud, a poor creature who never did, said, or wrote any thing indicating more than the ordinary capacity of an old woman, was a prodigy of parts and learning over whose tomb Art and Genius still continued to weep. Hampden deserved no more honourable name than that of "the zealot of rebellion." Even the ship money, condemned not less decidedly by Falkland and Clarendon than by the bitterest Roundheads, Johnson would not pronounce to have been an unconstitutional impost. Under a Government the mildest that had ever been known in the world, under a Government which allowed to the people an unprecedented liberty of speech and action, he fancied that he was a slave; he assailed the ministry with obloquy which refuted itself, and regretted the lost freedom and happiness of those golden days in which a writer who had taken but one-tenth part of the licence allowed to him would have been pilloried, mangled with the shears, whipped at the cart's tail, and flung into a noisome dungeon to die. He hated dissenters and stock-jobbers, the excise and the army, septennial parliaments, and Continental connexions. He long had an aversion to the Scotch, an aversion of which he could not remember the commencement, but which, he owned, had probably originated in his abhorrence of the conduct of the nation during the Great Rebellion. It is easy to guess in what manner debates on great party questions were likely to be reported by a man whose judgment was so much disordered by party spirit. A show of fairness was indeed necessary to the prosperity of the *Magazine*. But Johnson long afterwards owned that, though he had saved appearances, he had taken care that the Whig dogs should not have the best of it; and, in fact, every passage which has lived, every passage which bears the marks of his higher faculties, is put into the mouth of some member of the opposition.

A few weeks after Johnson had entered on these obscure labours, he published a work which at once placed him high among the writers of his age. It is probable that what he had suffered during his first year in London had often reminded him of some parts of that noble poem in which Juvenal had described the misery and degradation of a needy man of letters, lodged among the pigeons' nests in the tottering garrets which overhung the streets of Rome. Pope's admirable imitations of Horace's *Satires* and *Epistles* had recently appeared, were in every hand, and were by many readers thought superior to the originals. What Pope had done for Horace, Johnson aspired to do for Juvenal. The enterprise was bold, and yet judicious. For between Johnson and Juvenal there was much in common, much more certainly than between Pope and Horace.

Johnson's *London* appeared without his name in May 1738. He received only ten guineas for this stately and vigorous poem; but the sale was rapid, and the success complete. A second edition was required within a week. Those small critics who are always desirous to lower established reputations ran about proclaiming that the anonymous satirist was superior to Pope in Pope's own peculiar department of literature. It ought to be remembered, to the honour of Pope, that he joined heartily in the applause with which the appearance of a rival genius was welcomed. He made inquiries about the author of

*London*. Such a man, he said, could not long be concealed. The name was soon discovered; and Pope, with great kindness, exerted himself to obtain an academical degree and the mastership of a grammar school for the poor young poet. The attempt failed, and Johnson remained a bookseller's hack.

It does not appear that these two men, the most eminent writer of the generation which was going out, and the most eminent writer of the generation which was coming in, ever saw each other. They lived in very different circles, one surrounded by dukes and earls, the other by starving pamphleteers and indexmakers. Among Johnson's associates at this time may be mentioned Boyse, who, when his shirts were pledged, scrawled Latin verses sitting up in bed with his arms through two holes in his blanket, who composed very respectable sacred poetry when he was sober, and who was at last run over by a hackney coach when he was drunk; Hoole, surnamed the metaphysical tailor, who, instead of attending to his measures, used to trace geometrical diagrams on the board where he sat cross-legged; and the penitent impostor, George Psalmanazar, who, after poring all day, in a humble lodging, on the folios of Jewish rabbis and Christian fathers, indulged himself at night with literary and theological conversation at an alehouse in the city. But the most remarkable of the persons with whom at this time Johnson consorted was Richard Savage, an earl's son, a shoemaker's apprentice, who had seen life in all its forms, who had feasted among blue ribands in Saint James's Square, and had lain with fifty pounds weight of irons on his legs in the condemned ward of Newgate. This man had, after many vicissitudes of fortune, sunk at last into abject and hopeless poverty. His pen had failed him. His patrons had been taken away by death, or estranged by the riotous profusion with which he squandered their bounty, and the ungrateful insolence with which he rejected their advice. He now lived by begging. He dined on venison and champagne whenever he had been so fortunate as to borrow a guinea. If his questing had been unsuccessful, he appeased the rage of hunger with some scraps of broken meat, and lay down to rest under the piazzas of Covent Garden in warm weather, and, in cold weather, as near as he could get to the furnace of a glass house. Yet, in his misery, he was still an agreeable companion. He had an inexhaustible store of anecdotes about that gay and brilliant world from which he was now an outcast. He had observed the great men of both parties in hours of careless relaxation, had seen the leaders of opposition without the mask of patriotism, and had heard the prime minister roar with laughter and tell stories not over-decent. During some months Savage lived in the closest familiarity with Johnson; and then the friends parted, not without tears. Johnson remained in London to drudge for Cave. Savage went to the west of England, lived there as he had lived everywhere, and in 1743 died, penniless and heart-broken, in Bristol jail.

Soon after his death, while the public curiosity was strongly excited about his extraordinary character and his not less extraordinary adventures, a life of him appeared widely different from the catchpenny lives of eminent men which were then a staple article of manufacture in Grub Street. The style was indeed deficient in ease and variety; and the writer was evidently too partial to the Latin element of our language. But the little work, with all its faults, was a masterpiece. No finer specimen of literary biography existed in any language, living or dead; and a discerning critic might have confidently predicted that the author was destined to be the founder of a new school of English eloquence.

The *Life of Savage* was anonymous; but it was well known in literary circles that Johnson was the writer.

During the three years which followed, he produced no important work; but he was not, and indeed could not be, idle. The fame of his abilities and learning continued to grow. Warburton pronounced him a man of parts and genius; and the praise of Warburton was then no light thing. Such was Johnson's reputation that, in 1747, several eminent booksellers combined to employ him in the arduous work of preparing a *Dictionary of the English Language*, in two folio volumes. The sum which they agreed to pay him was only fifteen hundred guineas; and out of this sum he had to pay several poor men of letters who assisted him in the humbler parts of his task.

The prospectus of the *Dictionary* he addressed to the earl of Chesterfield. Chesterfield had long been celebrated for the politeness of his manners, the brilliancy of his wit, and the delicacy of his taste. He was acknowledged to be the finest speaker in the House of Lords. He had recently governed Ireland, at a momentous conjuncture, with eminent firmness, wisdom, and humanity; and he had since become secretary of state. He received Johnson's homage with the most winning affability, and requited it with a few guineas, bestowed doubtless in a very graceful manner, but was by no means desirous to see all his carpets blackened with the London mud, and his soups and wines thrown to right and left over the gowns of fine ladies and the waistcoats of fine gentlemen, by an absent, awkward scholar, who gave strange starts and uttered strange growls, who dressed like a scarecrow, and ate like a cormorant. During some time Johnson continued to call on his patron, but, after being repeatedly told by the porter that his lordship was not at home, took the hint, and ceased to present himself at the inhospitable door.

Johnson had flattered himself that he should have completed his *Dictionary* by the end of 1750; but it was not till 1755 that he at length gave his huge volumes to the world. During the seven years which he passed in the drudgery of penning definitions and marking quotations for transcription, he sought for relaxation in literary labour of a more agreeable kind. In 1749 he published the *Vanity of Human Wishes*, an excellent imitation of the tenth satire of Juvenal. It is in truth not easy to say whether the palm belongs to the ancient or to the modern poet. The couplets in which the fall of Wolsey is described, though lofty and sonorous, are feeble when compared with the wonderful lines which bring before us all Rome in tumult on the day of the fall of Sejanus, the laurels on the doorposts, the white bull stalking towards the Capitol, the statues rolling down from their pedestals, the flatterers of the disgraced minister running to see him dragged with a hook through the streets, and to have a kick at his carcase before it is hurled into the Tiber. It must be owned too that in the concluding passage the Christian moralist has not made the most of his advantages, and has fallen decidedly short of the sublimity of his pagan model. On the other hand, Juvenal's Hannibal must yield to Johnson's Charles; and Johnson's vigorous and pathetic enumeration of the miseries of a literary life must be allowed to be superior to Juvenal's lamentation over the fate of Demosthenes and Cicero. For the copyright of the *Vanity of Human Wishes* Johnson received only fifteen guineas.

A few days after the publication of this poem, his tragedy, begun many years before, was brought on the stage. His pupil, David Garrick, had in 1741 made his appearance on a humble stage in Goodman's Fields, had at once risen to the first place among actors, and was now, after several years of almost uninterrupted success, manager of Drury Lane Theatre. The relation between him and his old preceptor was of a very singular kind. They repelled each other strongly, and yet attracted each other

strongly. Nature had made them of very different clay; and circumstances had fully brought out the natural peculiarities of both. Sudden prosperity had turned Garrick's head. Continued adversity had soured Johnson's temper. Johnson saw with more envy than became so great a man the villa, the plate, the china, the Brussels carpet, which the little mimic had got by repeating, with grimaces and gesticulations, what wiser men had written; and the exquisitely sensitive vanity of Garrick was galled by the thought that, while all the rest of the world was applauding him, he could obtain from one morose cynic, whose opinion it was impossible to despise, scarcely any compliment not acidulated with scorn. Yet the two Lichfield men had so many early recollections in common, and sympathized with each other on so many points on which they sympathized with nobody else in the vast population of the capital, that, though the master was often provoked by the monkey-like impertinence of the pupil, and the pupil by the bearish rudeness of the master, they remained friends till they were parted by death. Garrick now brought *Irene* out, with alterations sufficient to displease the author, yet not sufficient to make the piece pleasing to the audience. The public, however, listened, with little emotion, but with much civility, to five acts of monotonous declamation. After nine representations the play was withdrawn. It is, indeed, altogether unsuited to the stage, and, even when perused in the closet, will be found hardly worthy of the author. He had not the slightest notion of what blank verse should be. A change in the last syllable of every other line would make the versification of the *Vanity of Human Wishes* closely resemble the versification of *Irene*. The poet, however, cleared, by his benefit nights, and by the sale of the copyright of his tragedy, about three hundred pounds, then a great sum in his estimation.

About a year after the representation of *Irene*, he began to publish a series of short essays on morals, manners, and literature. This species of composition had been brought into fashion by the success of the *Tatler*, and by the still more brilliant success of the *Spectator*. A crowd of small writers had vainly attempted to rival Addison. The *Lay Monastery*, the *Censor*, the *Freethinker*, the *Plain Dealer*, the *Champion*, and other works of the same kind had had their short day. None of them had obtained a permanent place in our literature; and they are now to be found only in the libraries of the curious. At length Johnson undertook the adventure in which so many aspirants had failed. In the thirty-sixth year after the appearance of the last number of the *Spectator* appeared the first number of the *Rambler*. From March 1750 to March 1752 this paper continued to come out every Tuesday and Saturday.

From the first the *Rambler* was enthusiastically admired by a few eminent men. Richardson, when only five, numbers had appeared, pronounced it equal if not superior to the *Spectator*. Young and Hartley expressed their approbation not less warmly. Bubb Dodington, among whose many faults indifference to the claims of genius and learning cannot be reckoned, solicited the acquaintance of the writer. In consequence probably of the good offices of Dodington, who was then the confidential adviser of Prince Frederick, two of his royal highness's gentlemen carried a gracious message to the printing office, and ordered seven copies for Leicester House. But these overtures seem to have been very coldly received. Johnson had had enough of the patronage of the great to last him all his life, and was not disposed to haunt any other door as he had haunted the door of Chesterfield.

By the public the *Rambler* was at first very coldly received. Though the price of a number was only two



pence, the sale did not amount to five hundred. The profits were therefore very small. But as seen as the flying leaves were collected and reprinted they became popular. The author lived to see thirteen thousand copies spread over England alone. Separate editions were published for the Scotch and Irish markets. A large party pronounced the style perfect, so absolutely perfect that in some essays it would be impossible for the writer himself to alter a single word for the better. Another party, not less numerous, vehemently accused him of having corrupted the purity of the English tongue. The best critics admitted that his diction was too *monotonous*, too obviously artificial, and now and then turgid even to absurdity. But they did justice to the *acuteness* of his observations on morals and manners, to the constant precision and frequent brilliancy of his language, to the weighty and magnificent eloquence of many serious passages, and to the solemn yet pleasing humour of some of the lighter papers. On the question of precedence between Addison and Johnson, a question which, seventy years ago, was much disputed, posterity has pronounced a decision from which there is no appeal. Sir Roger, his chaplain, and his butler, Will Wimble and Will Heneycomb, the "Vision of Mirza," the "Journal of the Retired Citizen," the "Everlasting Club," the "Dunmow Flicht," the "Loves of Hilpah and Shalum," the "Visit to the Exchange," and the "Visit to the Abbey" are known to everybody. But many men and women, even of highly cultivated minds, are unacquainted with Squire Bluster and Mrs Busy, Quisquilius and Venustus, the "Allegory of Wit and Learning," the "Chronicle of the Revolutions of a Garret," and the sad fate of Aningait and Ajut.

The last *Rambler* was written in a sad and gloomy hour. Mrs Johnson had been given over by the physicians. Three days later she died. She left her husband almost broken-hearted. Many people had been surprised to see a man of his genius and learning stooping to every drudgery, and denying himself almost every comfort, for the purpose of supplying a silly, affected old woman with superfluities, which she accepted with but little gratitude. But all his affection had been concentrated on her. He had neither brother nor sister, neither son nor daughter. To him she was beautiful as the Gunnings, and witty as Lady Mary. Her opinion of his writings was more important to him than the voice of the pit of Drury Lane Theatre, or the judgment of the *Monthly Review*. The chief support which had sustained him through the most arduous labour of his life was the hope that she would enjoy the fame and the profit which he anticipated from his *Dictionary*. She was gone; and in that vast labyrinth of streets, peopled by eight hundred thousand human beings, he was alone. Yet it was necessary for him to set himself, as he expressed it, doggedly to work. After three more laborious years, the *Dictionary* was at length complete.

It had been generally supposed that this great work would be dedicated to the eloquent and accomplished nobleman to whom the prospectus had been addressed. He well knew the value of such a compliment; and therefore, when the day of publication drew near, he exerted himself to soothe, by a show of zealous and at the same time of delicate and judicious kindness, the pride which he had so cruelly wounded. Since the *Ramblers* had ceased to appear, the town had been entertained by a journal called the *World*, to which many men of high rank and fashion contributed. In two successive numbers of the *World*, the *Dictionary* was, to use the modern phrase, puffed with wonderful skill. The writings of Johnson were warmly praised. It was proposed that he should be invested with the authority of a dictator, nay, of a pope, over our language, and that his decisions about the meaning and

the spelling of words should be received as final. His two folios, it was said, would of course be bought by everybody who could afford to buy them. It was soon known that these papers were written by Chesterfield. But the just resentment of Johnson was not to be so appeased. In a letter written with singular energy and dignity of thought and language, he repelled the tardy advances of his patron. The *Dictionary* came forth without a dedication. In the preface the author truly declared that he owed nothing to the great, and described the difficulties with which he had been left to struggle so forcibly and pathetically that the ablest and most malevolent of all the enemies of his fame, Horne Tooke, never could read that passage without tears.

The public, on this occasion, did Johnson full justice, and something more than justice. The best lexicographer may well be content if his productions are received by the world with cold esteem. But Johnson's *Dictionary* was hailed with an enthusiasm such as no similar work has ever excited. It was indeed the first dictionary which could be read with pleasure. The definitions show so much acuteness of thought and command of language, and the passages quoted from poets, divines, and philosophers are so skillfully selected, that a leisure hour may always be very agreeably spent in turning over the pages. The faults of the book resolve themselves, for the most part, into one great fault. Johnson was a wretched etymologist. He knew little or nothing of any Teutonic language except English, which indeed, as he wrote it, was scarcely a Teutonic language; and thus he was absolutely at the mercy of Junius and Skinner.

The *Dictionary*, though it raised Johnson's fame, added nothing to his pecuniary means. The fifteen hundred guineas which the booksellers had agreed to pay him had been advanced and spent before the last sheets issued from the press. It is painful to relate that twice in the course of the year which followed the publication of this great work he was arrested and carried to spunging-houses, and that he was twice indebted for his liberty to his excellent friend Richardson. It was still necessary for the man who had been formally saluted by the highest authority as dictator of the English language to supply his wants by constant toil. He abridged his *Dictionary*. He proposed to bring out an edition of Shakespeare by subscription, and many subscribers sent in their names and laid down their money; but he soon found the task so little to his taste that he turned to more attractive employments. He contributed many papers to a new monthly journal, which was called the *Literary Magazine*. Few of these papers have much interest; but among them was the very best thing that he ever wrote, a masterpiece both of reasoning and of satirical pleasantry, the review of Jenyns's *Inquiry into the Nature and Origin of Evil*.

In the spring of 1758 Johnson put forth the first of a series of essays, entitled the *Idler*. During two years these essays continued to appear weekly. They were eagerly read, widely circulated, and indeed impudently pirated, while they were still in the original form, and had a large sale when collected into volumes. The *Idler* may be described as a second part of the *Rambler*, somewhat livelier and somewhat weaker than the first part.

While Johnson was busied with his *Idlers*, his mother, who had accomplished her ninetieth year, died at Lichfield. It was long since he had seen her, but he had not failed to contribute largely out of his small means to her comfort. In order to defray the charges of her funeral, and to pay some debts which she had left, he wrote a little book in a single week, and sent off the sheets to the press without reading them over. A hundred pounds were paid him for the copyright, and the purchasers had great cause to be pleased with their bargain, for the book was *Rasselas*.

The success of *Rasselas* was great, though such ladies as Miss Lydia Languish must have been grievously disappointed when they found that the new volume from the circulating library was little more than a dissertation on the author's favourite theme, the "vanity of human wishes;" that the prince of Abyssinia was without a mistress, and the princess without a lover; and that the story set the hero and the heroine down exactly where it had taken them up. The style was the subject of much eager controversy. The *Monthly Review* and the *Critical Review* took different sides. Many readers pronounced the writer a pompous pedant, who would never use a word of two syllables where it was possible to use a word of six, and who could not make a waiting woman relate her adventures without balancing every noun with another noun, and every epithet with another epithet. Another party, not less zealous, cited with delight numerous passages in which weighty meaning was expressed with accuracy and illustrated with splendour. And both the censure and the praise were merited.

About the plan of *Rasselas* little was said by the critics; and yet the faults of the plan might seem to invite severe criticism. Johnson has frequently blamed Shakespeare for neglecting the proprieties of time and place, and for ascribing to one age or nation the manners and opinions of another. Yet Shakespeare has not sinned in this way more grievously than Johnson. *Rasselas* and Imlac, Nekayah and Pekuah, are evidently meant to be Abyssinians of the 18th century; for the Europe which Imlac describes is the Europe of the 18th century, and the inmates of the Happy Valley talk familiarly of that law of gravitation which Newton discovered, and which was not fully received even at Cambridge till the 18th century. What a real company of Abyssinians would have been may be learned from Bruce's *Travels*. But Johnson, not content with turning filthy savages, ignorant of their letters, and gorged with raw steaks cut from living cows, into philosophers as eloquent and enlightened as himself or his friend Burke, and into ladies as highly accomplished as Mrs Lennox or Mrs Sheridan, transferred the whole domestic system of England to Egypt. Into a land of harems, a land of polygamy, a land where women are married without ever being seen, he introduced the flirtations and jealousies of our ball-rooms. In a land where there is boundless liberty of divorce, wedlock is described as the indissoluble compact. "A youth and maiden meeting by chance, or brought together by artifice, exchange glances, reciprocate civilities, go home, and dream of each other. Such," says *Rasselas*, "is the common process of marriage." Such it may have been, and may still be, in London, but assuredly not at Cairo. A writer who was guilty of such improprieties had little right to blame the poet who made Hector quote Aristotle, and represented Julio Romano as flourishing in the days of the oracle of Delphi.

By such exertions as have been described Johnson supported himself till the year 1762. In that year a great change in his circumstances took place. He had from a child been an enemy of the reigning dynasty. His Jacobite prejudices had been exhibited with little disguise both in his works and in his conversation. Even in his massy and elaborate *Dictionary* he had, with a strange want of taste and judgment, inserted bitter and contumelious reflexions on the Whig party. The excise, which was a favourite resource of Whig financiers, he had designated as a hateful tax. He had railed against the commissioners of excise in language so coarse that they had seriously thought of prosecuting him. He had with difficulty been prevented from holding up the lord privy seal by name as an example of the meaning of the word "renegade." A pension he

had defined as pay given to a state hireling to betray his country; a pensioner as a slave of state hired by a stipend to obey a master. It seemed unlikely that the author of these definitions would himself be pensioned. But that was a time of wonders. George III. had ascended the throne, and had, in the course of a few months, disgusted many of the old friends, and conciliated many of the old enemies of his house. The city was becoming mutinous; Oxford was becoming loyal. Cavendishes and Bentincks were murmuring; Somersets and Wyndhams were hastening to kiss hands. The head of the treasury was now Lord Bute, who was a Tory, and could have no objection to Johnson's Toryism. Bute wished to be thought a patron of men of letters; and Johnson was one of the most eminent and one of the most needy men of letters in Europe. A pension of three hundred a year was graciously offered, and with very little hesitation accepted.

This event produced a change in Johnson's whole way of life. For the first time since his boyhood he no longer felt the daily goad urging him to the daily toil. He was at liberty, after thirty years of anxiety and drudgery, to indulge his constitutional indolence, to lie in bed till two in the afternoon, and to sit up talking till four in the morning, without fearing either the printer's devil or the sheriff's officer.

One laborious task indeed he had bound himself to perform. He had received large subscriptions for his promised edition of Shakespeare; he had lived on those subscriptions during some years; and he could not without disgrace omit to perform his part of the contract. His friends repeatedly exhorted him to make an effort, and he repeatedly resolved to do so. But, notwithstanding their exhortations and his resolutions, month followed month, year followed year, and nothing was done. He prayed fervently against his idleness; he determined, as often as he received the sacrament, that he would no longer doze away and trifle away his time; but the spell under which he lay resisted prayer and sacrament. His private notes at this time are made up of self-reproaches. "My indolence," he wrote on Easter eve in 1764, "has sunk into grosser sluggishness. A kind of strange oblivion has overspread me, so that I know not what has become of the last year." Easter 1765 came, and found him still in the same state. "My time," he wrote, "has been unprofitably spent, and seems as a dream that has left nothing behind. My memory grows confused, and I know not how the days pass over me." Happily for his honour, the charm which held him captive was at length broken by no gentle or friendly hand. He had been weak enough to pay serious attention to a story about a ghost which haunted a house in Cock Lane, and had actually gone himself, with some of his friends, at one in the morning, to St John's Church, Clerkenwell, in the hope of receiving a communication from the perturbed spirit. But the spirit, though adjured with all solemnity, remained obstinately silent; and it soon appeared that a naughty girl of eleven had been amusing herself by making fools of so many philosophers. Churchill, who, confident in his powers, drunk with popularity, and burning with party spirit, was looking for some man of established fame and Tory politics to insult, celebrated the Cock Lane ghost in three cantos, nicknamed Johnson Pomposo, asked where the book was which had been so long promised and so liberally paid for, and directly accused the great moralist of cheating. This terrible word proved effectual, and in October 1765 appeared, after a delay of nine years, the new edition of Shakespeare.

This publication saved Johnson's character for honesty, but added nothing to the fame of his abilities and learning. The preface, though it contains some good passages, is not in his best manner. The most valuable notes are those in



which he had an opportunity of showing how attentively he had during many years observed human life and human nature. The best specimen is the note on the character of Polonius. Nothing so good is to be found even in Wilhelm Meister's admirable examination of *Hamlet*. But here praise must end. It would be difficult to name a more slovenly, a more worthless edition of any great classic. The reader may turn over play after play without finding one happy conjectural emendation, or one ingenious and satisfactory explanation of a passage which had baffled preceding commentators. Johnson had, in his prospectus, told the world that he was peculiarly fitted for the task which he had undertaken, because he had, as a lexicographer, been under the necessity of taking a wider view of the English language than any of his predecessors. That his knowledge of our literature was extensive is indisputable. But, unfortunately, he had altogether neglected that very part of our literature with which it is especially desirable that an editor of Shakespeare should be conversant. It is dangerous to assert a negative. Yet little will be risked by the assertion that in the two folio volumes of the *English Dictionary* there is not a single passage quoted from any dramatist of the Elizabethan age, except Shakespeare and Ben Jonson. Even from Ben the quotations are few. Johnson might easily in a few months have made himself well acquainted with every old play that was extant. But it never seems to have occurred to him that this was a necessary preparation for the work which he had undertaken. He would doubtless have admitted that it would be the height of absurdity in a man who was not familiar with the works of Æschylus and Euripides to publish an edition of Sophocles. Yet he ventured to publish an edition of Shakespeare, without having ever in his life, as far as can be discovered, read a single scene of Massinger, Ford, Dekker, Webster, Marlow, Beaumont, or Fletcher. His detractors were noisy and scurrilous. Those who most loved and honoured him had little to say in praise of the manner in which he had discharged the duty of a commentator. He had, however, acquitted himself of a debt which had long lain heavy on his conscience, and he sank back into the repose from which the sting of satire had roused him. He long continued to live upon the fame which he had already won. He was honoured by the university of Oxford with a doctor's degree, by the Royal Academy with a professorship, and by the king with an interview, in which his Majesty most graciously expressed a hope that so excellent a writer would not cease to write. In the interval, however, between 1765 and 1775 Johnson published only two or three political tracts, the longest of which he could have produced in forty-eight hours, if he had worked as he worked on the *Life of Savage* and on *Rasselas*.

But, though his pen was now idle, his tongue was active. The influence exercised by his conversation, directly upon those with whom he lived, and indirectly on the whole literary world, was altogether without a parallel. His colloquial talents were indeed of the highest order. He had strong sense, quick discernment, wit, humour, immense knowledge of literature and of life, and an infinite store of curious anecdotes. As respected style, he spoke far better than he wrote. Every sentence which dropped from his lips was as correct in structure as the most nicely balanced period of the *Rambler*. But in his talk there were no pompous triads, and little more than a fair proportion of words in *-osity* and *-ation*. All was simplicity, ease, and vigour. He uttered his short, weighty, and pointed sentences with a power of voice, and a justness and energy of emphasis, of which the effect was rather increased than diminished by the rollings of his huge form, and by the asthmatic gaspings and puffings in which the peals of his

eloquence generally ended. Nor did the laziness which made him unwilling to sit down to his desk prevent him from giving instruction or entertainment orally. To discuss questions of taste, of learning, of casuistry, in language so exact and so forcible that it might have been printed without the alteration of a word, was to him no exertion, but a pleasure. He loved, as he said, to fold his legs and have his talk out. He was ready to bestow the overflowings of his full mind on anybody who would start a subject, on a fellow-passenger in a stage coach, or on the person who sat at the same table with him in an eating-house. But his conversation was nowhere so brilliant and striking as when he was surrounded by a few friends, whose abilities and knowledge enabled them, as he once expressed it, to send him back every ball that he threw. Some of these, in 1764, formed themselves into a club, which gradually became a formidable power in the commonwealth of letters. The verdicts pronounced by this conclave on new books were speedily known over all London, and were sufficient to sell off a whole edition in a day, or to condemn the sheets to the service of the trunkmaker and the pastrycook. Nor shall we think this strange when we consider what great and various talents and acquirements met in the little fraternity. Goldsmith was the representative of poetry and light literature, Reynolds of the arts, Burke of political eloquence and political philosophy. There, too, were Gibbon the greatest historian and Jones the greatest linguist of the age. Garrick brought to the meetings his inexhaustible pleasantry, his incomparable mimicry, and his consummate knowledge of stage effect. Among the most constant attendants were two high-born and high-bred gentlemen, closely bound together by friendship, but of widely different characters and habits,—Bennet Langton, distinguished by his skill in Greek literature, by the orthodoxy of his opinions, and by the sanctity of his life, and Topham Beanclerk, renowned for his amours, his knowledge of the gay world, his fastidious taste, and his sarcastic wit. To predominate over such a society was not easy. Yet even over such a society Johnson predominated. Burke might indeed have disputed the supremacy to which others were under the necessity of submitting. But Burke, though not generally a very patient listener, was content to take the second part when Johnson was present; and the club itself, consisting of so many eminent men, is to this day popularly designated as Johnson's club.

Among the members of this celebrated body was one to whom it has owed the greater part of its celebrity, yet who was regarded with little respect by his brethren, and had not without difficulty obtained a seat among them. This was James Boswell, a young Scotch lawyer, heir to an honourable name and a fair estate. That he was a coxcomb and a bore, weak, vain, pushing, curious, garrulous, was obvious to all who were acquainted with him. That he could not reason, that he had no wit, no humour, no eloquence, is apparent from his writings. And yet his writings are read beyond the Mississippi, and under the Southern Cross, and are likely to be read as long as the English exists either as a living or as a dead language. Nature had made him a slave and an idolater. His mind resembled those creepers which the botanists call parasites, and which can subsist only by clinging round the stems and imbibing the juices of stronger plants. He must have fastened himself on somebody. He might have fastened himself on Wilkes, and have become the fiercest patriot in the Bill of Rights Society. He might have fastened himself on Whitfield, and have become the loudest field-preacher among the Calvinistic Methodists. In a happy hour he fastened himself on Johnson. The pair might seem ill-matched. For Johnson had early been prejudiced

against Boswell's country. To a man of Johnson's strong understanding and irritable temper, the silly egotism and adulation of Boswell must have been as teasing as the constant buzz of a fly. Johnson hated to be questioned; and Boswell was eternally catechizing him on all kinds of subjects, and sometimes propounded such questions as, "What would you do, sir, if you were locked up in a tower with a baby?" Johnson was a water drinker and Boswell was a winebibber, and indeed little better than an habitual sot. It was impossible that there should be perfect harmony between two such companions. Indeed, the great man was sometimes provoked into fits of passion, in which he said things which the small man, during a few hours, seriously resented. Every quarrel, however, was soon made up. During twenty years the disciple continued to worship the master; the master continued to scold the disciple, to sneer at him, and to love him. The two friends ordinarily resided at a great distance from each other. Boswell practised in the Parliament House of Edinburgh, and could pay only occasional visits to London. During those visits his chief business was to watch Johnson, to discover all Johnson's habits, to turn the conversation to subjects about which Johnson was likely to say something remarkable, and to fill quarto notebooks with minutes of what Johnson had said. In this way were gathered the materials out of which was afterwards constructed the most interesting biographical work in the world.

Soon after the club began to exist, Johnson formed a connexion less important indeed to his fame, but much more important to his happiness, than his connexion with Boswell. Henry Thrale, one of the most opulent brewers in the kingdom, a man of sound and cultivated understanding, rigid principles, and liberal spirit, was married to one of those clever, kind-hearted, engaging, vain, pert young women, who are perpetually doing or saying what is not exactly right, but who do or say what they may, are always agreeable. In 1765 the Thrales became acquainted with Johnson, and the acquaintance ripened fast into friendship. They were astonished and delighted by the brilliancy of his conversation. They were flattered by finding that a man so widely celebrated preferred their house to any other in London. Even the peculiarities which seemed to unfit him for civilized society, his gesticulations, his rollings, his puffings, his mutterings, the strange way in which he put on his clothes, the ravenous eagerness with which he devoured his dinner, his fits of melancholy, his fits of anger, his frequent rudeness, his occasional ferocity, increased the interest which his new associates took in him. For these things were the cruel marks left behind by a life which had been one long conflict with disease and with adversity. In a vulgar hack writer such oddities would have excited only disgust. But in a man of genius, learning, and virtue their effect was to add pity to admiration and esteem. Johnson soon had an apartment at the brewery in Southwark, and a still more pleasant apartment at the villa of his friends on Streatham Common. A large part of every year he passed in those abodes, abodes which must have seemed magnificent and luxurions indeed, when compared with the dens in which he had generally been lodged. But his chief pleasures were derived from what the astronomer of his Abyssinian tale called "the endearing elegance of female friendship." Mrs Thrale rallied him, soothed him, coaxed him, and, if she sometimes provoked him by her flippancy, made ample amends by listening to his reproofs with angelic sweetness of temper. When he was diseased in body and in mind, she was the most tender of nurses. No comfort that wealth could purchase, no contrivance that womanly ingenuity, set to work by womanly compassion, could devise, was wanting to his sick room. He requited her kindness by an affection pure

as the affection of a father, yet delicately tinged with a gallantry which, though awkward, must have been more flattering than the attentions of a crowd of the fools who gloried in the names, now obsolete, of Buck and Maccaroni. It would seem that a full half of Johnson's life during about sixteen years was passed under the roof of the Thrales. He accompanied the family sometimes to Bath, and sometimes to Brighton, once to Wales and once to Paris. But he had at the same time a house in one of the narrow and gloomy courts on the north of Fleet Street. In the garrets was his library, a large and miscellaneous collection of books, falling to pieces and begrimed with dust. On a lower floor he sometimes, but very rarely, regaled a friend with a plain dinner—a veal pie, or a leg of lamb and spinach, and a rice pudding. Nor was the dwelling uninhabited during his long absences. It was the home of the most extraordinary assemblage of inmates that ever was brought together. At the head of the establishment Johnson had placed an old lady named Williams, whose chief recommendations were her blindness and her poverty. But, in spite of her murmurs and reproaches, he gave an asylum to another lady who was as poor as herself, Mrs Desmoulins, whose family he had known many years before in Staffordshire. Room was found for the daughter of Mrs Desmoulins, and for another destitute damsel, who was generally addressed as Miss Carmichael, but whom her generous host called Polly. An old quack doctor named Levett, who bled and dosed coal-heavers and hackney coachmen, and received for fees crusts of bread, bits of bacon, glasses of gin, and sometimes a little copper, completed this strange menagerie. All these poor creatures were at constant war with each other, and with Johnson's negro servant Frank. Sometimes, indeed, they transferred their hostilities from the servant to the master, complained that a better table was not kept for them, and railed or maundered till their benefactor was glad to make his escape to Streatham, or to the Mitre Tavern. And yet he, who was generally the laughtiest and most irritable of mankind, who was but too prompt to resent anything which looked like a slight on the part of a parse-proud bookseller, or of a noble and powerful patron, bore patiently from mendicants, who, but for his bounty, must have gone to the workhouse, insults more provoking than those for which he had knocked down Osborne and bidden defiance to Chesterfield. Year after year Mrs Williams and Mrs Desmoulins, Polly and Levett, continued to torment him and to live upon him.

The course of life which has been described was interrupted in Johnson's sixty-fourth year by an important event. He had early read an account of the Hebrides, and had been much interested by learning that there was so near him a land peopled by a race which was still as rude and simple as in the Middle Ages. A wish to become intimately acquainted with a state of society so utterly unlike all that he had ever seen frequently crossed his mind. But it is not probable that his curiosity would have overcome his habitual sluggishness, and his love of the smoke, the mud, and the cries of London, had not Boswell importuned him to attempt the adventure, and offered to be his squire. At length, in August 1773, Johnson crossed the Highland line, and plunged courageously into what was then considered, by most Englishmen, as a dreary and perilous wilderness. After wandering about two months through the Celtic region, sometimes in rude boats which did not protect him from the rain, and sometimes on small shaggy ponies which could hardly bear his weight, he returned to his old haunts with a mind full of new images and new theories. During the following year he employed himself in recording his adventures. About the beginning of 1775 his *Journey to the Hebrides* was published, and



was, during some weeks, the chief subject of conversation in all circles in which any attention was paid to literature. The book is still read with pleasure. The narrative is entertaining; the speculations, whether sound or unsound, are always ingenious; and the style, though too stiff and pompous, is somewhat easier and more graceful than that of his early writings. His prejudice against the Scotch had at length become little more than matter of jest; and whatever remained of the old feeling had been effectually removed by the kind and respectful hospitality with which he had been received in every part of Scotland. It was, of course, not to be expected that an Oxonian Tory should praise the Presbyterian polity and ritual, or that an eye accustomed to the hedgerows and parks of England should not be struck by the bareness of Berwickshire and East Lothian. But even in censure Johnson's tone is not unfriendly. The most enlightened Scotchmen, with Lord Mansfield at their head, were well pleased. But some foolish and ignorant Scotchmen were moved to anger by a little unpalatable truth which was mingled with much eulogy, and assailed him whom they chose to consider as the enemy of their country with libels much more dishonourable to their country than anything that he had ever said or written. They published paragraphs in the newspapers, articles in the magazines, sixpenny pamphlets, five-shilling books. One scribbler abused Johnson for being bear-eyed, another for being a pensioner; a third informed the world that one of the doctor's uncles had been convicted of felony in Scotland, and had found that there was in that country one tree capable of supporting the weight of an Englishman. Macpherson, whose *Fingal* had been proved in the *Journey* to be an impudent forgery, threatened to take vengeance with a cane. The only effect of this threat was that Johnson reiterated the charge of forgery in the most contemptuous terms, and walked about, during some time, with a cudgel, which, if the impostor had not been too wise to encounter it, would assuredly have descended upon him, to borrow the sublime language of his own epic poem, "like a hammer on the red son of the furnace."

Of other assailants Johnson took no notice whatever. He had early resolved never to be drawn into controversy; and he adhered to his resolution with a steadfastness which is the more extraordinary because he was, both intellectually and morally, of the stuff of which controversialists are made. In conversation he was a singularly eager, acute, and pertinacious disputant. When at a loss for good reasons, he had recourse to sophistry; and when heated by altercation, he made unsparring use of sarcasm and invective. But when he took his pen in his hand, his whole character seemed to be changed. A hundred bad writers misrepresented him and reviled him; but not one of the hundred could boast of having been thought by him worthy of a refutation, or even of a retort. The Kenricks, Campbells, MacNicol, and Hendersons did their best to annoy him, in the hope that he would give them importance by answering them. But the reader will in vain search his works for any allusion to Kenrick or Campbell, to MacNicol or Henderson. One Scotchman, bent on vindicating the fame of Scotch learning, defied him to the combat in a detestable Latin hexameter—

"Maxime, si tu vis, cupio contendere tecum."

But Johnson took no notice of the challenge. He had learned, both from his own observation and from literary history, in which he was deeply read, that the place of books in the public estimation is fixed, not by what is written about them, but by what is written in them, and that an author whose works are likely to live is very unwise if he stoops to wrangle with detractors whose works are certain to die. He always maintained that fame was a shuttlecock which could be kept up only by being beaten

back as well as beaten forward, and which would soon fall if there were only one battledore. No saying was oftener in his mouth than that fine apophthegm of Bentley, that no man was ever written down but by himself.

Unhappily, a few months after the appearance of the *Journey to the Hebrides*, Johnson did what none of his envious assailants could have done, and to a certain extent succeeded in writing himself down. The disputes between England and her American colonies had reached a point at which no amicable adjustment was possible. Civil war was evidently impending; and the ministers seem to have thought that the eloquence of Johnson might with advantage be employed to inflame the nation against the opposition here, and against the rebels beyond the Atlantic. He had already written two or three tracts in defence of the foreign and domestic policy of the Government; and those tracts, though hardly worthy of him, were much superior to the crowd of pamphlets which lay on the counters of Almon and Stockdale. But his *Taxation No Tyranny* was a pitiable failure. The very title was a silly phrase, which can have been recommended to his choice by nothing but a jingling alliteration which he ought to have despised. The arguments were such as boys use in debating societies. The pleasantry was as awkward as the gambols of a hippopotamus. Even Boswell was forced to own that in this unfortunate piece he could detect no trace of his master's powers. The general opinion was that the strong faculties which had produced the *Dictionary* and the *Rambler* were beginning to feel the effect of time and of disease, and that the old man would best consult his credit by writing no more.

But this was a great mistake. Johnson had failed, not because his mind was less vigorous than when he wrote *Rasselas* in the evenings of a week, but because he had foolishly chosen, or suffered others to choose for him, a subject such as he would at no time have been competent to treat. He was in no sense a statesman. He never willingly read or thought or talked about affairs of state. He loved biography, literary history, the history of manners; but political history was positively distasteful to him. The question at issue between the colonies and the mother country was a question about which he had really nothing to say. He failed, therefore, as the greatest men must fail when they attempt to do that for which they are unfit,—as Burke would have failed if Burke had tried to write comedies like those of Sheridan, as Reynolds would have failed if Reynolds had tried to paint landscapes like those of Wilson. Happily, Johnson soon had an opportunity of proving most signally that his failure was not to be ascribed to intellectual decay.

On Easter eve 1777 some persons, deputed by a meeting which consisted of forty of the first booksellers in London, called upon him. Though he had some scruples about doing business at that season, he received his visitors with much civility. They came to inform him that a new edition of the English poets, from Cowley downwards, was in contemplation, and to ask him to furnish short biographical prefaces. He readily undertook the task, a task for which he was pre-eminently qualified. His knowledge of the literary history of England since the Restoration was unrivalled. That knowledge he had derived partly from books, and partly from sources which had long been closed: from old Grub Street traditions; from the talk of forgotten poetasters and pamphleteers, who had long been lying in parish vaults; from the recollections of such men as Gilbert Walmesley, who had conversed with the wits of Button, Cibber, who had mutilated the plays of two generations of dramatists, Orrery, who had been admitted to the society of Swift, and Savage, who had rendered services of no very honourable kind to Pope. The biographer therefore

sat down to his task with a mind full of matter. He had at first intended to give only a paragraph to every minor poet, and only four or five pages to the greatest name. But the flood of anecdote and criticism overflowed the narrow channel. The work, which was originally meant to consist only of a few sheets, swelled into ten volumes, small volumes, it is true, and not closely printed. The first four appeared in 1779, the remaining six in 1781.

The *Lives of the Poets* are, on the whole, the best of Johnson's works. The narratives are as entertaining as any novel. The remarks on life and on human nature are eminently shrewd and profound. The criticisms are often excellent, and even when grossly and provokingly unjust, well deserve to be studied. For, however erroneous they may be, they are never silly. They are the judgments of a mind trammelled by prejudice and deficient in sensibility, but vigorous and acute. They therefore generally contain a portion of valuable truth which deserves to be separated from the alloy; and, at the very worst, they mean something, a praise to which much of what is called criticism in our time has no pretensions.

*Savage's Life* Johnson reprinted nearly as it had appeared in 1744. Whoever, after reading that life, will turn to the other lives will be struck by the difference of style. Since Johnson had been at ease in his circumstances he had written little and had talked much. When therefore he, after the lapse of years, resumed his pen, the mannerism which he had contracted while he was in the constant habit of elaborate composition was less perceptible than formerly, and his diction frequently had a colloquial ease which it had formerly wanted. The improvement may be discerned by a skilful critic in the *Journey to the Hebrides*, and in the *Lives of the Poets* is so obvious that it cannot escape the notice of the most careless reader.

Among the *Lives* the best are perhaps those of Cowley, Dryden, and Pope. The very worst is, beyond all doubt, that of Gray.

This great work at once became popular. There was, indeed, much just and much unjust censure; but even those who were loudest in blame were attracted by the book in spite of themselves. Malone computed the gains of the publishers at five or six thousand pounds. But the writer was very poorly remunerated. Intending at first to write very short prefaces, he had stipulated for only two hundred guineas. The booksellers, when they saw how far his performance had surpassed his promise, added only another hundred. Indeed Johnson, though, he did not despise or affect to despise money, and though his strong sense and long experience ought to have qualified him to protect his own interests, seems to have been singularly unskilful and unlucky in his literary bargains. He was generally reputed the first English writer of his time. Yet several writers of his time sold their copyrights for sums such as he never ventured to ask. To give a single instance, Robertson received four thousand five hundred pounds for the *History of Charles V.*; and it is no disrespect to the memory of Robertson to say that the *History of Charles V.* is both a less valuable and a less amusing book than the *Lives of the Poets*.

Johnson was now in his seventy-second year. The infirmities of age were coming fast upon him. That inevitable event of which he never thought without horror was brought near to him; and his whole life was darkened by the shadow of death. He had often to pay the cruel price of longevity. Every year he lost what could never be replaced. The strange dependants to whom he had given shelter, and to whom, in spite of their faults, he was strongly attached by habit, dropped off one by one; and, in the silence of his home, he regretted even the noise of their scolding *matrons*. The kind and generous Thrale

was no more; and it would have been well if his wife had been laid beside him. But she survived to be the laughing-stock of those who had envied her, and to draw from the eyes of the old man who had loved her beyond anything in the world tears far more bitter than he would have shed over her grave. With some estimable and many agreeable qualities, she was not made to be independent. The control of a mind more steadfast than her own was necessary to her respectability. While she was restrained by her husband, a man of sense and firmness, indulgent to her taste in trifles, but always the undisputed master of his house, her worst offences had been impertinent jokes, white lies, and short fits of pettishness ending in sunny good humour. But he was gone; and she was left an opulent widow of forty, with strong sensibility, volatile fancy, and slender judgment. She soon fell in love with a music-master from Brescia, in whom nobody but herself could discover anything to admire. Her pride, and perhaps some better feelings, struggled hard against this degrading passion. But the struggle irritated her nerves, soured her temper, and at length endangered her health. Conscious that her choice was one which Johnson could not approve, she became desirous to escape from his inspection. Her manner towards him changed. She was sometimes cold and sometimes petulant. She did not conceal her joy when he left Streatham; she never pressed him to return; and, if he came unbidden, she received him in a manner which convinced him that he was no longer a welcome guest. He took the very intelligible hints which she gave. He read for the last time a chapter of the Greek Testament in the library which had been forced by himself. In a solemn and tender prayer he commended the house and its inmates to the Divine protection, and, with emotions which choked his voice and convulsed his powerful frame, left for ever that beloved home for the gloomy and desolate house behind Fleet Street, where the few and evil days which still remained to him were to run out. Here, in June 1783, he had a paralytic stroke, from which, however, he recovered, and which does not appear to have at all impaired his intellectual faculties. But other maladies came thick upon him. His asthma tormented him day and night. Dropsical symptoms made their appearance. While sinking under a complication of diseases, he heard that the woman whose friendship had been the chief happiness of sixteen years of his life had married an Italian fiddler, that all London was crying shame upon her, and that the newspapers and magazines were filled with allusions to the Ephesian matron and the two pictures in Hamlet. He vehemently said that he would try to forget her existence. He never uttered her name. Every memorial of her which met his eye he flung into the fire. She meanwhile fled from the laughter and hisses of her countrymen and countrywomen to a land where she was unknown, hastened across Mount Cenis, and learned, while passing a merry Christmas of concerts and lemonade parties at Milan, that the great man with whose name hers is inseparably associated had ceased to exist.

He had, in spite of much mental and much bodily affliction, clung vehemently to life. The feeling described in that fine but gloomy paper which closes the series of his *Idlers* seemed to grow stronger in him as his last hour drew near. He fancied that he should be able to draw his breath more easily in a southern climate, and would probably have set out for Rome and Naples but for his fear of the expense of the journey. That expense, indeed, he had the means of defraying; for he had laid up about two thousand pounds, the fruit of labours which had made the fortune of several publishers. But he was unwilling to break in upon this hoard, and he seems to have wished even to keep its existence a secret. Some of his friends



hoped that the Government might be induced to increase his pension to six hundred pounds a year, but this hope was disappointed, and he resolved to stand one English winter more. That winter was his last. His legs grew weaker; his breath grew shorter; the fatal water gathered fast, in spite of incisions which he, courageous against pain but timid against death, urged his surgeons to make deeper and deeper. Though the tender care which had mitigated his sufferings during months of sickness at Streatham was withdrawn, he was not left desolate. The ablest physicians and surgeons attended him, and refused to accept fees from him. Burke parted from him with deep emotion. Windham sat much in the sick room, arranged the pillows, and sent his own servant to watch at night by the bed. Frances Burney, whom the old man had cherished with fatherly kindness, stood weeping at the door; while Laugton, whose piety eminently qualified him to be an adviser and comforter at such a time, received the last pressure of his friend's hand within. When at length the moment, dreaded through so many years, came close, the dark cloud passed away from Johnson's mind. His temper became unusually patient and gentle; he ceased to think with terror of death, and of that which lies beyond death; and he spoke much of the mercy of God, and of the propitiation of Christ. In this serene frame of mind he died on the 13th of December 1784. He was laid, a week later, in Westminster Abbey, among the eminent men of whom he had been the historian,—Cowley and Denham, Dryden and Congreve, Gay, Prior, and Addison.

Since his death the popularity of his works—the *Lives of the Poets*, and perhaps the *Vanity of Human Wishes*, excepted—has greatly diminished. His *Dictionary* has been altered by editors till it can scarcely be called his. An allusion to his *Rambler* or his *Idler* is not readily apprehended in literary circles. The fame even of *Rasselas* has grown somewhat dim. But, though the celebrity of the writings may have declined, the celebrity of the writer, strange to say, is as great as ever. Boswell's book has done for him more than the best of his own books could do. The memory of other authors is kept alive by their works. But the memory of Johnson keeps many of his works alive. The old philosopher is still among us in the brown coat with the metal buttons and the shirt which ought to be at wash, blinking, puffing, rolling his head, drumming with his fingers, tearing his meat like a tiger, and swallowing his tea in oceans. No human being who has been more than seventy years in the grave is so well known to us. And it is but just to say that our intimate acquaintance with what he would, himself have called the infirmitates of his intellect and of his temper serves only to strengthen our conviction that he was both a great and a good man. (M.)

JOHNSTON, ALBERT SIDNEY (1803–1862), American soldier, was born in Kentucky in 1803. After graduating at West Point in 1826 he served for eight years in the United States army, emigrated to Texas in 1834, and entered the Texan service as private in 1836. His promotion was so rapid that in 1838 he was appointed commander-in-chief, and till 1840 acted as secretary for war. From 1840 till 1846 he lived in retirement on his farm in Texas; but in the latter year he accepted the colonelcy of a regiment of Texan volunteers to serve against Mexico. As a staff-officer he was present at the battle of Monterey in September 1846. Texas joined the Union in 1846; and in 1849 Johnston received a major's commission in the United States army. After various services he won the rank of brevet brigadier-general by his skilful conduct of the expedition sent to Utah in 1857 to bring the Mormons to order. In January 1861 he was transferred from the command of the Texas department to that of

the Pacific department; but in April he was superseded, probably on account of his secessionist sympathies. He resigned his national commission in May 1861, and accepted a command in the Confederate army. While acting as commander-in-chief at the battle of Shiloh, he was killed, April 6, 1862.

JOHNSTON, ALEXANDER KEITH (1804–1871), geographer, was born at Kirkhill near Edinburgh, in December 1804. After an education at the High School of Edinburgh he was apprenticed to an engraver; and about 1830 he joined his brother in a prosperous printing and engraving business. His passion for geography had early developed itself, but his first important work was the *National Atlas* of general geography, which gained for him in 1843 the appointment of geographer-royal for Scotland. Johnston was the first to bring the study of physical geography into competent notice in England. His attention had been called to the subject by Humboldt; and after years of labour he published his magnificent *Physical Atlas* in 1848, followed by a second and enlarged edition in 1856. This, by means of maps with descriptive letterpress, illustrates the geology, hydrography, meteorology, botany, zoology, and ethnology of the globe, and undoubtedly marks an epoch in the history of English geographical science. The rest of Johnston's life was equally given to geography, his later years to its educational aspects especially. His services were recognized by election to fellowships of the leading scientific societies of Europe, India, and America. For his chart of the geographical distribution of health and disease he received the diploma of the London Epidemiological Society; in 1865 he received the degree of LL.D. from Edinburgh University; and in 1871 the Royal Geographical Society awarded him its Victoria medal. He died July 9, 1871. His son of the same name (1844–1879) was also the author of various geographical works and papers.

Johnston published a *Dictionary of Geography* in 1850, with many later editions; *The Royal Atlas of Modern Geography*, begun in 1855; an atlas of military geography to accompany Alison's *History of Europe*; and a variety of other atlases and maps for educational or scientific purposes.

JOHNSTONE, a manufacturing town in the county of Renfrew, Scotland, is situated on the Black Cart river, about 10 miles west of Glasgow, with which it is connected by rail. First fenced in 1781, it rose rapidly in prosperity owing to the introduction of the cotton-manufacture. The town contains several engineering works, a paper mill, and the largest flax mill in Scotland. About a mile to the east is Elderslie, the traditional birthplace of Wallace. The population in 1871 was 7538, and in 1881 9268.

JOHNSTOWN, a borough of Cambria county, Pennsylvania, U.S., is situated on the Stony Creek and the Conemaugh river, 78 miles east of Pittsburg and 277 miles west of Philadelphia. It is the centre of nine contiguous boroughs constituting one town of 22,000 inhabitants, who are mainly employed by the Cambria Iron Company in the manufacture of iron, steel, railway bars, wire, &c. There are large woollen and flouring mills, numerous churches, and a public library. The library building was presented to the Library Association by the Cambria Iron Company. The population in 1870 was 6028, and in 1880 8380.

JOHORE, a native state at the southern end of the Malay or Malacca peninsula, bounded by the Mear river on the N.W. and by the Indu on the N.E., with an area estimated at 20,000 square miles. The territory, covered for the most part by virgin forest, has been but partially explored; but it is gradually being opened up under the patronage of the rajah Abubaker (born 5th December 1833), who has visited Europe, as well as Java and other eastern countries, and takes a keen interest in the development of his country. At present the principal

exports from Johore are gambier and catechu, black pepper, timber, rattans, and dammar; but the soil and climate are well fitted for the growth of sugar-cane, rice, tobacco, coffee, and similar products, and the rajah is promoting the formation of regular plantations. The town of Johore is a flourishing little settlement 15 miles north-east of Singapore, in  $1^{\circ} 0' 26''$  N. lat. and  $103^{\circ} 47'$  E. long. A school where English is taught has been founded in the town by the rajah, who also maintains a similar institution in Singapore. The population of the country, exclusive of the tribes of the interior, is estimated at 100,000, the greater number being Malays and Chinese. It was the present rajah's grandfather—Abdulrahman Tumengong of Rio, Singapore, and Johore—who ceded Singapore to the British. The dynasty is the continuation of the sultans of Malacca, who retired to Johore on the conquest of their capital in 1311 by Albuquerque. Bekhari, author of *Makôta Raja Raja*, one of the most remarkable productions in the Malay tongue, was a native of Johore.

JOIGNY, chief town of an arrondissement in the department of Yonne, France, is situated on the right bank of the Yonne, about 12 miles north-west of Auxerre. Its streets are steep and narrow; some of the houses are of wood, and date from the 15th or 16th century. Joigny has tribunals of first instance and commerce, a communal college, a library with 9000 volumes, and a civil and military hospital, and manufactures cloth, hunting and other arms, percussion-caps, leather, cooper work, and brandy. It has also trade in cereals, cattle, and wood, and in an excellent variety of wine, produced in the neighbourhood. The chief buildings are the old and interesting churches of St Andrew, St John, and St Thibaut; the ruins of the old castle of the 10th century; the partly destroyed later castle; the large 10th century tower beside the prison; the hôtel-de-ville, of 1727; the palais-de-justice, including the fine chapel of the Ferrands; the college; and the stone bridge of seven arches. Of the former massive fortifications, St John's gate and the moat are the chief remains. The population in 1876 was 5975.

Joigny, in Latin Joviniacum, is held to have been founded by Flavius Jovinius, *magister equitum* under the emperor Valentinian (364 A.D.). It gave its name to an important line of mediæval counts (whence sprang the counts of Joinville), who about 1716 merged in the dukes of Villeroy.

JOINERY. See BUILDING, vol. iv. p. 485.

JOINT, in law, as applied to obligations, estates, &c., implies that the rights in question relate to the aggregate of the parties joined. Obligations to which several are parties may be *several*, *i.e.*, enforceable against each independently of the others, or *joint*, *i.e.*, enforceable only against all of them taken together, or *joint and several*, *i.e.*, enforceable against each or all at the option of the claimant. So an interest or estate given to two or more persons for their joint lives continues only so long as all the lives are in existence. Joint-tenants are co-owners who take together at the same time, by the same title, and without any difference in the quality or extent of their respective interests; and when one of the joint-tenants dies his share, instead of going to his own heirs, lapses to his co-tenants by survivorship. This estate is therefore to be carefully distinguished from *tenancy in common*, when the co-tenants have each a separate interest which on death passes to the heirs and not to the surviving tenants. When several take an estate together any words or facts implying severance will prevent the tenancy from being construed as joint.

JOINTS, in the sense in which engineers use the word, may be classed either (*a*) according to their material, as in stone or brick, wood, or metal; or (*b*) according to their object, to prevent leakage of air, steam, or water, or to transmit force, which may be thrust, pull, or shear; or (*c*) according as they are stationary or moving ("working"

in technical language). Many joints, like those of ship-plates and boiler-plates, have simultaneously to fulfil both objects mentioned under (*b*).

All *stone* joints of any consequence are stationary. If being uneconomical to dress the surfaces of the stones resting on each other smoothly and so as to be accurately flat, a layer of mortar or other cementing material is laid between them. This hardens and serves to transmit the pressure from stone to stone without its being concentrated at the "high places." If the ingredients of the cement are chosen so that when hard the cement has about the same coefficient of compressibility as that of the stone or brick, the pressure will be nearly uniformly distributed. The cement also adheres to the surfaces of the stone or brick, and allows a certain amount of tension to be borne by the joint. It likewise prevents the stones slipping one on the other, *i.e.*, it gives the joint very considerable shearing strength. The composition of the cement is chosen according as it has to "set" in air or water. The joints are made impervious to air or water by "pointing" their outer edges with a superior quality of cement.

Wood joints are also nearly all stationary. Lignum vitæ is still used by engineers for the one half of some special working joints, but even in these few instances its use is rapidly dying out. Wood joints are made partially fluid-tight by "grooving and tenoning," and by "caulking" with oakum or similar material. If the wood is saturated with water, it swells, the edges of the joints press closer together, and the joints become tighter the greater the water-pressure is which tends to produce leakage.

Relatively to its weaker general strength, wood is a better material than iron so far as regards the transmission of a thrust past a joint. So soon as a heavy pressure comes on the joint all the small irregularities of the surfaces in contact are crushed up, and there results an approximately uniform distribution of the pressure over the whole area (*i.e.*, if there be no bending forces), so that no part of the material is unduly stressed. To attain this result the abutting surfaces should be well fitted together, and the bolts binding the pieces together should be arranged so as to ensure that they will not interfere with the timber surfaces coming into this close contact.

Owing to its weak shearing strength on sections parallel to the fibre, timber is peculiarly unfitted for tension joints. If the pieces exerting the pull are simply bolted together with wooden or iron bolts, the joint cannot be trusted to transmit any considerable force with safety. The stresses become intensely localized in the immediate neighbourhood of the bolts. A tolerably strong timber tension-joint can, however, be made by making the two pieces abut, and connecting them by means of iron plates covering the joint and bolted to the sides of the timbers by bolts passing through the wood. These plates should have their surfaces which lie against the wood ribbed in a direction transverse to the pull. The bolts should fit their holes slackly, and should be well tightened up so as to make the ribs sink into the surface of the timber. There will then be very little localized shearing stress brought upon the interior portions of the wood.

*Metal Joints.*—Iron and the other commonly used metals possess in variously high degrees the qualities desirable in substances out of which joints are to be made. The joint ends of metal pieces can easily be fashioned to any advantageous form and size without waste of material. Also these metals offer peculiar facilities for the cutting of their surfaces at a comparatively small cost so smoothly and evenly as to ensure the close contact over their whole areas of surfaces placed against each other. This is of the highest importance, especially in joints designed to transmit force.



Wrought iron and mild steel are above all other metals suitable for tension joints where there is not continuous rapid motion. Where such motion occurs, a layer, or, as it is technically termed, a "bush," of brass is inserted underneath the iron. The joint then possesses the high strength of a wrought iron one and at the same time the good frictional qualities of a brass surface.

Where the running speed is high and the intensity of pressure can be made small by adopting large bearing surfaces, cast iron is now increasingly preferred for pressure joints. But when, owing to want of space or for other reasons, the bearing surface cannot be made large in proportion to the thrust to be transmitted, gun-metal, *i.e.*, the toughest quality of brass, should be used if the speed be high, and steel if the speed be small.

Leakage past moving metal joints can be prevented by cutting the surfaces very accurately to fit each other. Steam-engine slide-valves and their seats, and piston "packing-rings" and the cylinders they work to and fro in, may be cited as examples. A subsidiary compressible "packing" is in other situations employed, an instance of which may be seen in the "stuffing boxes" which prevent the escape of steam from steam-engine cylinders through the piston-rod hole in the cylinder cover.

Fixed metal joints are made fluid tight—(a) by caulking a rivetted joint, *i.e.*, by hammering in the edge of the metal with a square-edged chisel (the tighter the joint requires to be against leakage the closer must be the spacing of the rivets—compare the rivet-spacing in bridge, ship, and boiler-plate joints); (b) by the insertion between the surfaces of a layer of one or other of various kinds of cement, the layer being thick or thin according to circumstances; (c) by the insertion of a layer of soft solid substance called "packing" or "insertion." A special kind of indiarubber and canvas sheet is prepared for this purpose. A very effective species of "insertion" is thin copper gauze. Sometimes a single round of thick copper wire laid in opposite grooves cut on joint-surfaces serves the purpose.

*The Principles of the Strength of Joints.*—The conditions of strength of cemented and glued joints are too obvious to require description. It may, however, be mentioned that in most cases the joint is stronger the thinner the layer of cementing material interposed between the surfaces.

Nearly all other joints are formed by cutting one or more holes in the ends of the pieces to be joined, and inserting in these holes a corresponding number of pins. The word "pin" is technically restricted to mean a cylindrical pin in a movable joint. The word "bolt" is used when the cylindrical pin is screwed up tight with a nut so as to be immovable. When the pin is not screwed, but is fastened by being beaten down on either end, it is called a "rivet." The pin is sometimes rectangular in section, and tapered or parallel lengthwise. "Gibs" and "cottars" are examples of the latter. It is very rarely the case that fixed joints have their pins subject to simple compression in the direction of their length. They are, however, frequently subject to simple tension in that direction. A good example is the joint between a steam cylinder and its cover. Here the bolts have to resist the whole thrust of the steam, and at the same time to keep the joint steam-tight.

If  $D$  be the cylinder diameter,  $t$  the thickness of the flange of the cover, and  $n$  the number of bolts used, it can be shown that the amount the flange rises between the bolts by bending is proportional to  $\frac{D^2}{n^2 t^3}$ , where  $p$  is the steam pressure per unit area. If the same degree of tightness be desired for all sizes of cylinders, this deflexion should be the same for all. The spacing of the bolts is proportional to  $\frac{D}{n}$ , and, therefore, we should have the spacing  $\propto \beta p^{-1}$ . If then the total bolt area is made proportional to the total steam

pressure, it would follow that the diameter of bolt  $\propto p^{\frac{1}{2}} D^{\frac{1}{2}}$ . Again, if  $t$  were reckoned in accordance with the shearing force of the steam on the circular section of the cover at the circumference of the cylinder, *i.e.*,  $t \propto p D$ , we would have

$$\text{spacing} \propto p^{\frac{1}{2}} D^{\frac{1}{2}},$$

$$\text{and bolt diam.} \propto p^{\frac{1}{2}} D^{\frac{1}{2}}.$$

For reasons connected with technical difficulties in the foundry,  $t$  is made larger in proportion to  $D$  than this rule indicates for the smaller sizes of cylinders; and, therefore, the spacing and the bolt diameter are not made to increase quite so rapidly as the  $\frac{1}{2}$  and  $\frac{1}{2}$  powers of  $D$ .

No moving joints have their pins exposed to simple stress on sections transverse to the pins' axes. The pins of such joints have these transverse sections subjected to shearing and bending stresses, and the sections parallel to the pin axes to compressive stress.

The simplest case by which the subject can be illustrated is that in which a cylindrical pin passes through the ends of two links—one forked, and the other simple and lying between the branches of the fork of the other.

Let the accompanying diagram represent the end of the unforked link. The width of the link parallel to  $CC'$  is taken as unity, and the letters on the figure indicate the ratios of the respective dimensions to this width. Let  $b$  represent the ratio of the thickness, perpendicular to the paper, of the "eye" to the thickness in the same direction of the main body of the link at  $D$ . Let also  $f$  be the intensity of uniform tensile stress on the section at  $D$ . Evidently no pressure comes on the under side of the pin below  $CC'$ . The whole pull at  $D$  is passed round half on each side of the pin, and is delivered to the upper side of the pin, on which it produces compression. Since the side sections  $t$ , through which the pull passes, lie out of the direct line of that pull, the stress is much higher on the parts of these sections towards the centre line  $DD'$  than on those further off. The lines of force crowd as close as possible together near the surface of the pin, *i.e.*, towards the main line  $DD'$  of the pull. In other words, the inequality of stress is occasioned by the bending moments due to the centre of force not passing through the centres of gravity of area of the sections. The inequality begins at the root of the widening out of the link to form the eye, and reaches its maximum at  $CC'$ .

The bending moment at  $CC'$  and the stress caused by it at the edge of the section can be found by the help of the ordinary theory of elasticity. The best method of doing so is to calculate the amount by which the portion of the eye below  $CC'$  is bent by the forces applied to it. In the equations the bending moment at  $CC'$  is inserted as an unknown quantity. The section on  $DD'$  remaining unmoved, each element of the linear deflexion is resolved parallel to  $CC'$ , and the integral from  $DD'$  up to  $CC'$  of all these components parallel to  $CC'$  is equated to zero, the resultant deflexion at  $C$  in the direction of  $CC'$  being evidently nil. This equation gives value of the bending moment at  $CC'$ , and from it the correspond stress is obtained.

If the section at  $D$  be rectangular, as also that at  $CC'$ , then the average tensile stress on  $t$  is

$$f = f \frac{1}{2tb};$$

and the extra stress caused at the edge of the section by the bending moment is

$$f' = f \frac{1}{4t^2b} \left\{ 3(t+d) - \frac{1}{2t+d} \right\}.$$

The total maximum stress is, therefore,

$$f' + f'' = f \frac{1}{4t^2b} \left\{ 5t + 3d - \frac{1}{2t+d} \right\}.$$

This gives the ratio of the maximum tension at the side of the eye

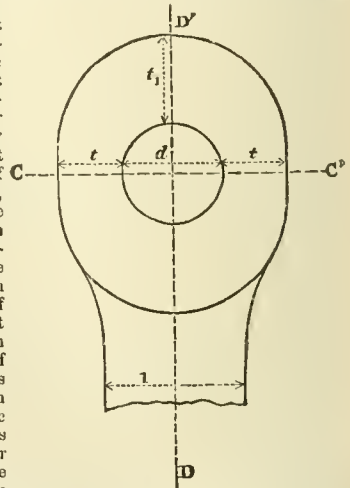

to the uniform tension ( $f$ ) on the main body of the link at D. If the section at D be circular while  $t$  remains rectangular, the corresponding ratio is a little more than  $\frac{1}{2}\pi$ , or about  $\frac{2}{3}$  of the above. If it is desired that this maximum should not exceed  $f$ , we obtain a relation between the ratios  $d$ ,  $t$  and  $b$  by putting  $f' + f'' = f$ . The following table exhibits the results of this calculation for rectangular section at D:—

$t =$	$\frac{1}{2}$	$\frac{2}{3}$	$\frac{3}{4}$	$\frac{4}{5}$	1
$d = \frac{1}{2}$ and $b =$	3.1	2.5	2	1.7	1.5
$d = \frac{2}{3}$ " $b =$	4	3	2.4	2	1.7
$d = 1$ " $b =$	4.9	3.5	2.8	2.3	1.9

For circular section at D,  $b$  is about  $\frac{2}{3}$  of these values.

Although the values of  $t$  and  $d$  that are commonly used all fall considerably within the limits of the above tables, the values of  $b$  usually found in practice are much less than those shown above. This means that the eyes of links as commonly proportioned are much more severely stressed than is the main body of the link.

In working joints the frictional resistance to rotation throws more than half the main pull on one side of the eye, and this side is therefore still more severely stressed than is indicated by the above equations.

The stresses on the portion of the eye lying above CC' are complicated by the combination with the direct pull already mentioned of the pressure of the upper surface of the pin. This latter is normal at each point if the surface be smooth and the joint a motionless one. It increases from zero at CC' to a maximum at the line DD'. At this point the intensity of the surface pressure is, according to an approximate theoretic estimate, about  $\frac{4}{\pi}$ , or  $1\frac{1}{4}$

times greater than if the whole pull were evenly distributed over the projection on CC' of the upper half surface of the pin. It has often been fallaciously imagined that the central section  $t_1$  is exposed to severe shearing stress. From the symmetry of the case, however, it is evident that on this section the shear is zero. The maximum shear occurs on a section nearly parallel to DD', and somewhat less than  $\frac{1}{2}d$  distant from DD'. The exact position of this section of maximum shear depends upon the dimension-ratio  $t_1$ , which is usually made considerably greater than  $t$ .

The pin surface pressure has transverse components parallel to CC', which produce tension and a bending moment on the section  $t_1$ . A theoretical approximation to this bursting pressure is  $\frac{1}{\pi}$ , or about  $\frac{1}{3}$ , of the whole pull exerted by the link, and the line of the resultant (parallel to CC') is situated  $\frac{1}{4}d$  distant from the centre of the pin. A small portion of this is borne by the central section on DD' of the main part of the link below CC', but by far the larger part is borne by the section marked  $t_1$ . If it were wholly borne by that section, the average tension on  $t_1$  would, for a circular section at D, be  $\frac{f}{4t_1b}$ , and the extra stress produced by this bending moment

would be  $\frac{f}{4t_1b} \left( 3 + \frac{d}{t_1} \right)$ . Other bending moments, however, are thrown on this section due to—first, the resultant of the pin-surface-pressure-components parallel to DD', which lies at  $\frac{2}{3\pi}d$ , or about  $\frac{1}{4}d$ , from the line DD'; and, second, the stress at the section CC'. Adding all these together, there is obtained an approximation to the actual tension parallel to CC' on the lower edge of the section  $t_1$ , namely,

$$\frac{f}{t_1b} \left\{ 1 + \frac{d}{t_1} - \frac{t}{\pi t_1} - \frac{1}{5t_1 \left( \frac{2}{3}t + d \right)} \right\}$$

The shearing and bending stresses upon the pin itself depend upon whether one of the links is forked or both are simple; and also greatly upon the exactitude with which the pin fits the holes.

When the link exerts a thrust instead of a pull through the joint, a similar investigation of the state of stress may be made.

A couple of plates joined together by a single row of rivets may, so far as concerns the sections lying between the rivets, be looked upon as a number of flat links laid side by side with their eyes of equal width with the body of the link.

We may therefore apply the first of the above equations for  $f' + f''$  to find the stress close to the rivets on the section coinciding with the line of the rivets. To adapt the formula to this case, it is only necessary to put  $b = 1$  and  $t = \frac{1}{2}(1 - d)$ . The formula thus derived, however, gives results probably considerably higher than those actually occurring, because of the strips into which the plate has been supposed to be divided, acting on each other in such a way as to produce bending moments partly neutralizing the above increase of stress.

The strip of metal between the rivets and the edge of the plate is in the condition of a continuous beam supported by the rivets.

The maximum moment occurs just over the rivets, and is nearly the same as if the load were uniformly distributed over the length of the beam. If  $t_1$  be the ratio to the rivet-spacing of the distance of the edge of the plate to the rivet hole, the supposition of uniformity of distribution of load gives the equation  $f' = f \frac{1}{2t_1}$  for

the maximum stress on a section perpendicular to the plate edge. To make  $f' = f$ , it is necessary to make  $t_1 = \sqrt{0.5} = 0.7$ . The edge of the plate will then be amply strong enough to resist the greatest shear to which it is anywhere exposed.

When there are two or more rows of rivets the investigation of the stress is quite similar to the above.

In joints where the movement is rapid and continuous, the size of the pin is determined by considerations of durability against wear. The metal wears rapidly if the bearing surfaces are not well lubricated. The lubricant is pressed out from between these surfaces if the intensity of pressure exceeds a limit determined by the character of the lubricant. The size of the pin must be sufficient to prevent this limiting pressure being reached. Even before the oil is wholly squeezed out the friction becomes so great as to heat the metal surfaces to a high temperature, which hastens the evaporation of the remaining oil. In order to ensure that the temperature may be kept low by the continuous dissipation of the heat generated, some engineers design the bearing surface in proportion to the product of the pressure and the speed, so as to allow a certain area of "conducting surface" for each unit of heat generated per second. (R. H. S.\*)

JOINT STOCK COMPANIES. See COMPANY, vol. vi. p. 221.

JOINVILLE, JEAN DE (1224-1319), was the second great writer of history in Old French, and in a manner occupies the interval between Villehardouin and Froissart. From the point of view of literary history there are numerous minor chroniclers who fill up the gaps, but no one of them has the idiosyncrasy which distinguishes these three writers, and for general purposes it may be said that they complete the series of historians illustrating, as no series in any other country or language illustrates, the three periods of the Middle Ages—adolescence, complete manhood, and decadence. Joinville was born in 1224 of a good family of the province of Champagne, allied to many distinguished houses in the east of France and connected by marriage with the emperor Frederick II. The property of the Joinvilles came, curiously enough, like that of Comines, the fourth great historian of old France, into the hands of the Orleans family, and the castle, which overhung the Marne, was sold in 1791 for purposes of demolition. The provincial court of the counts of Champagne had long been a distinguished one, and the action of Thibaut the poet, together with the neighbourhood of the district to Paris, made the province less rebellious than most of the great feudal divisions of France to the royal authority. Joinville's first appearance at the king's court was in 1241, when he performed the functions of carver for his feudal superior on the occasion of the knightng of Louis IX.'s younger brother Alphonse. Seven years afterwards, when he was four and twenty, he took the cross, thereby giving St Louis a valuable follower, and supplying himself with the occasion of an eternal memory. His family had been persistent crusaders for several generations. The crusade, however, in which he distinguished himself equally by wisdom and prowess, taught his practical spirit several lessons. He returned with the king in 1254. But, though his reverence for the personal character of his prince seems to have known no bounds, he had probably gauged accurately enough the strategic faculties of the saintly king, and he certainly had imbibed the spirit of the dictum that a man's first duties are those to his own house. He was in the intervals of his residence on his own fief a constant attendant on the court, but he declined to accompany the



king on his last and fatal expedition. Some years later, in 1282, he was one of the witnesses whose testimony was formally given at St Denis in the matter of the canonization of Louis, and long afterwards, in 1298, being then a man of more than seventy years, he was present at the exhumation of the saint's body. It was not till even later that he began his literary work, the occasion being a request from Jeanne of Navarre, the wife of Philippe le Bel and the mother of Louis le Hutin. The great interval between his experiences and the period of the composition of his history is important for the due comprehension of the latter. Books were not hastily written in those days, and some years passed before the task was completed, on its own showing, in October 1309. Jeanne was by this time dead, and Joinville presented his book to her son Louis the Quarreller. This the original manuscript is now lost, whereby hangs a tale. Great as was his age, Joinville had not ceased to be actively loyal, and in 1315, being then almost ninety, he complied with the royal summons to bear arms against the Flemings. He was at Joinville again in 1317, and on the 11th July 1319 he died at the age of ninety-five, leaving his possessions and his position as seneschal of Champagne to his second son Anselm. He was buried in the neighbouring church of St Laurent, where during the Revolution his bones underwent the usual profanation. In the next generation but one his male heirs failed, and the fief passed by marriage through the house of Lorraine to the Guises, and so to the house of Orleans. Besides his *Histoire de Saint Louis* and his *Credo* or "Confession of Faith," written much earlier, a considerable number, relatively speaking, of letters and business documents concerning the fief of Joinville and so forth are extant. These have an importance which we shall consider further on; but Joinville owes his place in general estimation only to his history of his crusading experiences and of the subsequent fate of his hero.

Of the famous French history books of the Middle Ages Joinville's is beyond all doubt that which bears most vivid impress of the personal characteristics of its composer. It does not, like Villehardouin, give us the picture of the temper and habits of a whole order or cast of men during an heroic period of human history; it falls far short of Froissart in vivid portraiture of the picturesque and external aspects of social life; but it is altogether a more personal book than either. As has been already noticed, the age and circumstances of the writer must not be forgotten in reading it. He is a very old man telling of circumstances which occurred in his youth. He evidently thinks that the times have not changed for the better—what with the frequency with which the devil is invoked in modern France, and the sinful expenditure common in the matter of embroidered silk coats. But his laudation of times past concentrates itself almost wholly on the person of the sainted king whom, while with feudal independence he had declined to swear fealty to him, "because I was not his man," he evidently regarded with an unlimited reverence. His age, too, while it is garrulous to a degree, seems to have been entirely free from the slightest taint of boasting. No one perhaps ever took less trouble to make himself out a hero than Joinville. He is constantly admitting that on such and such an occasion he was terribly afraid; he confesses without the least shame that, when one of his followers suggested defiance of the Saracens and voluntary death, he (Joinville) paid not the least attention to him; nor does he attempt to gloss in any way his refusal to accompany St Louis on his unlucky second crusade, or his invincible conviction that it was better to be in mortal sin than to have the leprosy, or his decided preference for wine as little watered as might be, or any other weakness. Yet he was a sincerely religious man, as the curious *Credo*

written at Acre and forming a kind of anticipated appendix to the history seems sufficiently to show. He presents himself as an altogether human person, brave enough in the field, and at least when young capable of extravagant devotion to an ideal, provided the ideal was fashionable, but having at bottom a sufficient respect for his own skin and a full consciousness of the side on which his bread is buttered. Nor can he be said to be in all respects an intelligent traveller. There were in him what may be called glimmerings of deliberate literature, but they were hardly more than glimmerings. His famous description of Greek fire has a most provoking mixture of circumstantial detail with absence of verifying particulars. It is as matter of fact and comparative as Dante, without a touch of Dante's genius. "The fashion of Greek fire was such that it came to us as great as a tun of verjuice, and the fiery tail of it was as big as a mighty lance; it made such noise in the coming that it seemed like the thunder from heaven, and looked like a dragon flying through the air; so great a light did it throw that throughout the host men saw as though it were day for the light it threw." Certainly the excellent seneschal has not stinted himself of comparisons here, yet they can hardly be said to be luminous. That the thing made a great flame, a great noise, and struck terror into the beholder, is about the sum of it all. Every now and then indeed a striking circumstance, strikingly told, occurs in Joinville, such as the famous incident of the woman who carried in one hand a chafing dish of fire, in the other a phial of water, that she might burn heaven and quench hell, lest in future any man should serve God merely for hope of the one or fear of the other. But in these cases the author only repeats what he has heard from others. On his own account he is much more interested in small personal details than in greater things. How the Saracens, when they took him prisoner, he being half dead with a complication of diseases, kindly left him "un mien couverture d'écarlate" which his mother had given him, and which he put over him, having made a hole therein and bound it round him with a cord; how when he came to Acre in a dilapidated condition an old servant of his house presented himself, and "brought me clean white hoods and combed my hair most comfortably"; how he bought a hundred tuns of wine and served it—the best first, according to high authority—well-watered to his private soldiers, somewhat less watered to the squires, and to the knights neat, but with a suggestive phial of the weaker liquid to mix "si comme ils vouloient,"—these are the details in which he seems to take greatest pleasure, and for readers six hundred years after date perhaps they are not the least interesting details.

It would, however, be a mistake to imagine that Joinville's book is exclusively or even mainly a chronicle of small beer. If he is not a Villehardouin or a Carlyle, his battlepieces are vivid and truthful, and he has occasional passages of no small episodic importance, such as that dealing with the Old Man of the Mountain. But, above all, the central figure of his book redeems it from the possibility of the charge of being commonplace or ignoble. To St Louis Joinville is a nobler Boswell; and hero-worshipper, here, and heroic ideal, all have something of the sublime about them. The very pettiness of the details in which the good seneschal indulges as to his own weaknesses only serves to enhance the sublime unworldliness of the king. Joinville is a better warrior than Louis, but, while the former frankly prays for his own safety, the latter only thinks of his army's when they have escaped from the hands of the aliens. One of the king's knights boasts that ten thousand pieces have been "forconté;" (counted short) to the Saracens; and it is with the utmost trouble that Joinville and the rest can persuade the king that this is a

joke, and that the Saracens are much more likely to have got the advantage. He warns Joinville against wine-bibbing, against bad language, against all manner of foibles small and great; and the pupil acknowledges that this physician at any rate had healed himself in these respects. It is true that he is severe towards infidels; and his approval of the knight who, finding a Jew likely to get the better of a theological argument, resorted to the baculine variety of logic, does not meet the views of the 19th century. But Louis was not of the 19th century but of the 13th, and after his kind he certainly deserved Joinville's admiration. Side by side with his indignation at the idea of cheating his Saracen enemies may be mentioned his answer to those who after Taillebourg complained that he had let off Henry III. too easily. "He is my man now, and he was not before," said the king, a most unpractical person certainly, and in some ways a sore saint for France. But it is easy to understand the half-despairing adoration with which a shrewd and somewhat prosaic person like Joinville must have regarded this flower of chivalry born out of due time. He has had his reward, for assuredly the portrait of St Louis from the early collection of anecdotes to the last learsy sketch of the woeful end at Tunis, with the famous *Enseignement* which is still the best summary of the theoretical duties of a Christian king in mediæval times, is such as to take away all charge of vulgarity or mere *conterage* from Joinville, a charge to which otherwise he might perhaps have been exposed.

The arrangement of the book is, considering its circumstances and the date of its composition, sufficiently methodical. According to its own account it is divided into three parts,—the first dealing generally with the character and conduct of the hero; the second with his acts and deeds in Egypt, Palestine, &c., as Joinville knew them; the third with his subsequent life and death. Of these the last is very brief, the first not long; the middle constitutes the bulk of the work. The contents of the first part are, as might be expected, miscellaneous enough, and consist chiefly of stories chosen to show the valour of Louis, his piety, his justice, his personal temperance, and so forth. The second part enters upon the history of the crusade itself, and tells how Joinville—he would hardly have done this later—pledged all his land save so much as would bring in a thousand livres a year, and started with a brave retinue of nine knights (two of whom besides himself wore bannerets), and shared a ship with the Sire d'Aspremont, leaving Joinville without raising his eyes, "pour ce que le euer ne me attendristis du bian chastel que je lessoie et de mes deux enfans"; how they could not get out of sight of a high mountainous island (Lampedusa or Pantellaria) till they had made a procession round the masts in honour of the Virgin; how they reached first Cyprus and then Egypt; how they took Damietta, and then entangled themselves in the Delta. Bad generalship, which is sufficiently obvious, unwholesome food,—it was Lent, and they ate the Nile fish which had been feasting on the carcasses of the slain,—and Greek fire did the rest, and personal valour was of little avail, not merely against superior numbers and better generals, but against dysentery and a certain "mal de l'est" which attacked the mouth and the legs, a curious human version of a well-known bestial malady. After ransom Acre was the chief scene of Louis's stay in the East, and here Joinville lived in some state, and saw not a few interesting things, hearing besides much gossip as to the interior affairs of Asia from ambassadors, merchants, and others. At last they journeyed back again to France, not without considerable experiences of the perils of the deep, which Joinville tells with a good deal of spirit. The remainder of the book is very brief. Some anecdotes of the king's "justice," his favourite and distinguishing

attribute, during the sixteen years which intervened between the two crusades are given; then comes the story of Joinville's own refusal to join the second expedition, a refusal which bluntly alleged the harm done by the king's men who stayed at home to the vassals of those who went abroad as the reason of Joinville's resolution to remain behind. The death of the king at Tunis, his *Enseignement* to his son, and the story of his canonization, complete the work.

The book in which this interesting story is told has had a literary history which less affects its matter than the vicissitudes to which Froissart has been subjected, but which is hardly less curious in its way. There is no reason for supposing that Joinville indulged in various editions, such as those which have given MM. Kervyn de Lettenhove and Siméon Luce so much trouble, and which make so vast a difference between the first and the last redaction of the chronicler of the Hundred Years' War. Indeed the great age of the seneschal of Champagne, and his intimate first-hand acquaintance with his subject, made such variations extremely improbable. But, whereas there is no great difficulty (though much labour) in ascertaining the original and all subsequent texts of Froissart, the original text of Joinville was until a few years ago unknown, and even now may be said to be in the state of a conjectural restoration. It has been said that the book was presented to Louis le Hutin. Now we have a catalogue of Louis le Hutin's library, and, strange to say, Joinville does not figure in it. His book seems to have undergone very much the same fate as that which befell the originals of the first two volumes of the *Paston Letters* which Sir John Fenn presented to George the Third. Several royal library catalogues of the 14th century are known, but in none of these does the *Histoire de St Louis* appear. It does appear in that of Charles V. (1411), but apparently no copy even of this survives. As everybody knows, however, books could be and were multiplied by the process of copying tolerably freely, and a copy at first or second hand which belonged to the fiddler king René in the 15th century was used for the first printed edition in 1547. Other editions were printed from other versions, all evidently posterior to the original. But in 1741 the well-known mediævalist La Curne de St Palaye found at Lunca a manuscript of the 16th century, evidently representing an older text than any yet printed. Three years later a 14th century copy was found at Brussels, and this is the standard manuscript authority for the text of Joinville. Those who prefer to rest on MS. authority will probably hold to this text, which appears in the well-known collection of MM. Michaud and Poujoulat as well as that of Buchon, and in a careful and useful separate edition by M. Francisque Michel. The modern science of critical editing, however, which applies to mediæval texts the principles long recognized in editing the classics, has discovered in the 16th century manuscript, and still more in the original miscellaneous works of Joinville, the letters, deeds, &c., already alluded to, the materials for what we have already called a conjectural restoration, which is not without its interest, though perhaps it is possible for that interest to be exaggerated. M. Natalis de Wailly is the Joinvillian Orelli or Lachmann, and his later editions (for he has produced several) exhibit the results of the new learning. These results are not trifling, for all students of Old French know that a remarkable change—from the purely linguistic point of view more remarkable perhaps than any of subsequent occurrence—passed over the language between the beginning and the end of the century in which Joinville died. But they affect the matter of the book little, and as such cannot be compared with the changes evident in the Angliæan and Gallican editions, so to speak, of Froissart. Their interest, however, is much too great and too typical not to deserve that some notice should be given to them here.

For merely general readers Buchon's or Michaud's editions of Joinville will amply suffice. Both possess translations into modern French, which however, are hardly necessary, for the language is very easy. M. de Wailly's editions of 1868 and 1874 are critical editions, the value of which is considerable, but contestable. They are accompanied by ample annotations and appendices, with illustrations of great merit and value. Much valuable information appeared for the first time in the edition of M. F. Michel, 1859. To these may be added M. A. F. Didot's *Études sur Joinville*, and some articles in the *Bibliothèque de l'École des Chartes* and in *Romania*. A good sketch of the whole subject will be found in Aubertin's *Histoire de la Langue et de la Littérature Françaises au Moyen Âge*, ii. 196-211. (G. SA.)

JOLIET, the county seat of Will county, Illinois, United States, is situated on both sides of the Des Plaines river, 40 miles south-west of Chicago, with which it is connected by three railroads and the Illinois and Michigan canal. The State penitentiary near the city, erected at a cost of over \$1,000,000, is one of the largest in the United States.



Manufactures of various kinds, especially of iron and steel, barbed fence wire, agricultural implements and machinery, paper, boots and shoes, cut stone, draining tiles, and sewer pipes, are extensively carried on. The coal-fields of Wilmington, Morris, and Streator are within a few miles of the city. Quarries of good building stone, and deposits of fireclay, sand, and cement gravel abound in the neighbourhood. Joilet is an important railroad centre, from which large quantities of manufactured articles, grain, cattle, and hogs are despatched daily. Population in 1880, 11,659.

JOMINI, HENRY, BARON (1779-1869), general in the French and afterwards in the Russian service, and writer on military tactics, was born 6th March 1779 at Payerne in the canton of Vaud, Switzerland, where his father held the dignity of magistrate. At an early period he showed a marked preference for a military life, but at first he was disappointed of his hopes by the dissolution of the Swiss regiments of France at the Revolution. For some years he acted as clerk in a banking house in Paris, until the outbreak of the Swiss revolution, when he returned to his native country, and at the early age of nineteen was appointed chief secretary of war. At the peace of Lunéville in 1801 he returned to Paris and introduced himself to Marshal Ney, who made him his aide-de-camp and private secretary. In 1804 he published *Traité des grandes opérations militaires*, which in 1805 he presented to Napoleon on the field of Austerlitz as the work of a young Swiss officer. A few days afterwards he was named colonel, and appointed first aide-de-camp to Marshal Ney. In 1806 he published a treatise on the probabilities of the war with Prussia, the ability of which so impressed Napoleon that he resolved to attach him to his person. He was present with Napoleon at the battle of Jena, but afterwards joined Ney, and afforded him important assistance in delivering his army from a very perilous situation. After the peace of Tilsit he was made chief of the staff to Ney, and created a baron. In the Spanish campaign of 1808 his skilful advice contributed in no small degree to the victories of Ney, but on account of that general's jealousy he resigned his commission, and he was entering into negotiations with the emperor of Russia, when Napoleon, learning his intention, compelled him to remain in the French service with the rank of brigadier-general. On his refusal to take part in the Russian campaign, Napoleon named him governor of Wilna; but during the retreat from Moscow he at once placed his strategic skill and knowledge of the country at the service of France, and, having after the battle of Lützen obtained his old office under Marshal Ney, he suggested the happy manœuvre which led to the victory of Bautzen. Finding, however, that the road to promotion was closed against him, he again offered his services to Russia. They were accepted, and he obtained the rank of lieutenant-general and was named aide-de-camp to the emperor. He gave the important assistance of his counsel to the allied armies during the German campaign, but declined to take part in the passage of the Rhine and the invasion of France in 1814. In 1817 he returned to Paris, where he published *Principes de la stratégie*, 3 vols., 1818; *Histoire critique et militaire des campagnes de la Révolution de 1792 à 1801*, 15 vols., 1819-24; *Vie politique et militaire de Napoléon*, 1827. In 1826 he again entered the service of Russia, and in the Turkish campaign of 1828 his sagacious advice led to the capitulation of Yarna. Afterwards he was employed in organizing the military academy at St Petersburg and in superintending the military studies of the czarowitz, for the use of whom he wrote *Tableau analytique des principales combinaisons de la guerre*, the new and improved edition of which was named *Précis de l'art de la guerre*. During the later period of his life

Jomini resided at Brussels, but he afterwards returned to Paris, where he died March 24, 1869. Although Jomini played a secondary and unobtrusive part in the great military events of his time, the military triumphs of France were in no inconsiderable degree due to his masterly counsels; and doubtless, had circumstances conspired to grant him the opportunity of playing a practical and independent rôle, he would have achieved for himself a place among the greatest generals of his country. His delineations of the campaigns of Napoleon are the ablest military account of these great wars, and his exposition of the laws of tactics and strategy have achieved for him European fame.

See Ferdinand Leconte, *Le Général Jomini, sa vie et ses écrits*, 1861; and *Le Général Jomini*, by Sainte-Beuve, 1869.

JOMMELLI, NICCOLÒ (1714-1774), a famous Italian composer of the last century, was born at Aversa near Naples, September 11, 1714, and received his musical education at two of the famous music schools of that capital, being at first a pupil of Durante at the Conservatorio di San Onofrio, and subsequently studying composition under Leo at La Pietà dei Turchini. His first opera, *L'Errore Amoros*, was produced when Jommelli was only twenty-three, at Naples, and so timid was the young composer that he prefixed a pseudonym to his work. The result, however, was favourable beyond all expectation, and encouraged Jommelli to continue his career as a dramatic composer. Three years afterwards he went to Rome to produce two new operas, and thence to Bologna, where he became acquainted with and profited by the advice of Padre Martini, the greatest contrapuntist of his age. In the meantime Jommelli's fame began to spread beyond the limits of his country, and in 1745 he went for the first time to Vienna, where one of his finest operas, *Didone*, was produced. Three years later he returned to Italy, and in 1754 he obtained the post of chapel-master to the music-loving duke of Württemberg at Stuttgart, which city he made his home for a number of years. Here he considerably modified his style in accordance with German taste, so much so that, when after an absence of fifteen years he returned to Naples, his countrymen hissed two of his operas off the stage. He retired in consequence to his native village, and only occasionally emerged from his solitude to take part in the musical life of the capital.

His last composition was a *Miserere* written a few weeks before his death, which took place at Naples, August 28, 1774. In the last-named work, as well as in his other church compositions, Jommelli proves himself to be a musician of earnest purpose and sound scholarship. In his operatic music he follows essentially the style of his age, being intent on writing effective pieces for the voice rather than upon expressing the feelings and passions of the characters; but even here he betrays a certain elevation of sentiment not always to be found amongst the composers of the latter half of the 18th century. His best dramatic work is generally supposed to be *Armida*, one of the operas scorned by the Neapolitans in 1771.

JONAH. The Book of Jonah is so named from the principal personage of the narrative, only mentioned elsewhere in 2 Kings xiv. 25. Jonah there appears as a native of Zebulun, and a contemporary of Jeroboam II. (8th century B.C.). If the book of Jonah were written then, it has a claim to rank as the oldest of the prophetic writings (Joel being in all probability of post-exile origin). The problems connected with this little book are, however, so great that no judicious critic would think of admitting such a date as proved. The problems are twofold:—(1) was the book written at one jet? and (2) is it to be understood as a history, or as an allegorical tale, and, if the latter, is it, or is it not, based at all upon tradition, or upon a

nature-myth? Köhler thinks that he can trace "the hand of a late reviser, who has made alterations, interpolations, and transpositions of verses and sentences. . . . There is at the very beginning of the story a perceptible lacuna in the second verse, where we are not told what Jonah was to announce to the men of Nineveh." He offers very plausible grounds for preferring the reading of the Septuagint in iii. 4, "yet three days, and Nineveh shall be overthrown," and points out that the alteration into "forty days" involves an interference with part of the details of the narrative. He detects traces of interpolation in i. 8, ii. 2-10 (A. V. 1-9), iii. 9, iv. 1-4, and other passages, and regards the passage iv. 5-8 as "full of insertions and variants." After purging the text from later additions and enlargements, we obtain a brief but simple and striking story, which, according to Köhler, formed part of a book of prophetic narrations, and therefore commenced with "And." Later Jews, by very plausible conjectures, in search of a lesson-book on penitence for reading in times of public calamity, modified and interpolated it (comp. Mishna, *Taanit*, ii.). This is not the place to discuss this conjecture in detail; it is favoured by analogy and cannot be rejected without consideration. It enables us to account for comparatively primitive conceptions of the Godhead, and the naïveté in the description of the heathen mariners, and supplies a *locus stantii* to the orthodox view of the book which would otherwise be destroyed by acute rationalistic criticism. The additions may be later, but the kernel of the narrative may be old.

At the same time, it will be seen at once that to grant that the kernel of the narrative may be pre-exile is not to grant that it is historical. From a purely literary point of view it has been urged that "the marks of a story are as patent in the book of Jonah as in any of the tales of the Thousand and One Nights." The greatest of the improbabilities is a moral one; can we conceive of a large heathen city being converted by an obscure foreign prophet? "To judge of the degree of this improbability, it is enough to read any inscription you please of an Assyrian king. Fancy Sargon or Sennacherib in the presence of Jonah. The case quoted by the *Speaker's Commentary* of a Christian priest frightening a Mahometan town into repentance is not to the point, for Christians and Moslems have a common basis in theism. How could the Ninevites give credence to a man who was not a servant of Asshur?" It is obvious that in New Testament times (see Matt. xii. 39-40, Luke xi. 29-30, and Matt. xvi. 4) the symbolic meaning of the book was the most important part of it. Why should it not have been originally composed with a symbolic or allegorical object? For the hearers of Christ, one symbolic meaning was the most important, but probably enough (for Scripture is many-sided) other ages saw different meanings. The truths of the equality of Jews and heathen before God, the prophetic and missionary character of the people of Israel, and the conditional character of prophecy, have all been suggested as possible meanings, and all possess great plausibility.

Mr Tylor (*Early History of Mankind*, pp. 336, 337, and *Primitive Culture*, i. 306) has already pointed out the close superficial resemblance between the story of Jonah and various solar myths; and indeed the former was long ago connected with the myths of Hercules and Hesione, and Persens and Andromeda. To suppose a direct imitation of these Greek myths is, indeed, quite gratuitous. Preller's handbook will show that the most circumstantial parallels to the Hebrew only occur in the narratives of later writers. These late narratives, however, are not improbably derived in part from earlier sources, and at any rate M. Leermant and M. Clermont Ganneau have pointed out Babylonian and Egyptian affinities for the Greek myths in

question. "In Mesopotamia the story is naturally more original and more transparent. In Mr George Smith's translation, Tiamtu the dragon opens its mouth to swallow Bel Merodach, but in vain (Smith's *Chaldean Genesis*, by Sayce, p. 111)." A remarkable passage in Jeremiab (ii. 44), evidently alluding to a popular mythic story, seems to supply a missing link between the narrative of Jonah and the original myth. "Like the latter, it describes the destroyer as the dragon, like the former, it converts both destroyer and destroyed into symbols," no uncommon phenomenon in poetical passages of the Old Testament.<sup>1</sup>

The evidences of date are difficult to seize. The use of the uncommon phrase, Yahveh Elohim (iv. 6), points to a date synchronizing with that of Gen. ii., iii., but when those chapters were written is a debatable question. Many have argued the exile or post-exile origin of the book from the supposed Aramaizing character of the style; against this view, Pusey's introduction deserves reading. The arguments from internal evidence have been made best use of by Kuenen, who couples it with the book of Ruth as a product of the opposition to the strict and exclusive policy of Ezra towards heathen nations. Kalisch's theory is that the book is a romance founded perhaps on fact. "Why should not the substance of the story, though the historical annals make no allusion to such enterprise, be founded on a real fact? Jonah, being on intimate relations with his sovereign, might have been employed by him for important offices; foreign embassies were not unusual, and some such legation from the king of Israel to the king of Assyria is actually mentioned by Jonah's contemporary Hosea (v. 13)" (*Bible Studies*, ii. 122).

*Modern Literature.*—Besides the commentaries, see Kuenen, *Religion of Israel*, ii. 237-44; Noldeke, *Die Alttestamentl. Literatur*, Leipzig, 1863, pp. 72-80; Cheyne, "Jonah, a Study in Jewish Folklore and Religion," in *Theological Review*, 1877, pp. 211-19; Kalisch, *Bible Studies*, part ii., 1878 (reviewed by Oort, *Theologisch Tijdschrift*, 1878); Köhler, "The Original Form of the Book of Jonah," in *Theological Review*, 1879, pp. 139-44. (T. K. C.)

JONAH, RABBI, of Cordova, the most eminent Jewish grammarian and lexicographer of the Middle Ages, known also among Hebrew authors as R. Merinos (Martinus), but now usually called by his Arabic name Abu 'l Walid Merwān ibn Janāh, was born at Cordova towards the close of the 10th century, but spent his youth partly at the neighbouring Jewish town of Lucena (Alisana), where he studied under Isaac ben Gikatila and Isaac ben Saul. He appears not to have returned to Cordova till after the death of the famous Hayyūj, the founder of a scientific Hebrew grammar based on the doctrine of trilateral roots. Though not a personal disciple of Hayyūj, Abu 'l Walid adopted the general principles of his system, and early applied himself to the task of completing and correcting the observations of his predecessor on the subject of weak roots. While engaged in these studies he retired from Cordova during the siege of the town by the Berber prince Suleiman (1013), and took up his residence in Saragossa, where he published his first work, the *Kitāb el Mustallik*, so named because it contained an attempt to supply the omissions of Hayyūj. The Jews of Saragossa were not favourably disposed to the new philology, and the writings of Abu 'l Walid were not only displeasing to men of the old school, but involved him in bitter controversy with the professed disciples of Hayyūj, on whose views he had presumed to improve. The most formidable of these antagonists was Samuel Ibn Nagdela Halvey, the prime minister of Granada. Abu 'l Walid had much to suffer from the rancour of so influential an opponent, but he persisted in his studies, which were finally crowned by the

<sup>1</sup> It is worth noticing that the "fish" of Jonah is found five or six times in paintings in the Roman catacombs assigned to the first two centuries, and that it is distinctly a dragon.



publication of the *Kitáb el Tanqíh*, or "Book of Minute Research," a grammatical and lexicographical work of the first order, which is still consulted by scholars, and can never be opened without admiration for the range and precision of the author's scholarship and the soundness of his philological method. There is more Hebrew to be learned from Abu 'l Walíd than from all the later rabbins put together. Abu 'l Walíd was essentially a philologist. He had essayed poetry in his youth, was read in philosophy, and not only practised as a physician but wrote on medicine; but the devotion of his life was concentrated on the exact verbal study of Scripture. Armed with a thorough knowledge of the language and grammatical system of the Arabs, as well as of the dialects of Jewish Aramaic, he studied the Biblical idiom in the light of the cognate Semitic tongues, and in a spirit of pure scholarship, free from traditional prejudice.

The extant minor works of R. Jonah have been published in Arabic with a French translation by J. and H. Derenbourg, *Opuscules et Traités d'Abou 'l-Walíd*, Paris, 1880. The first or grammatical part of the *Kitáb el-Tanqíh* has been published in the imperfect Hebrew version entitled *Sefer Harikma* by Goldberg, Frankfurt-on-the-Main, 1856. The lexicographical part of the *Kitáb el-Usúl*, or *Book of Roots*, was published in Arabic by Neubauer, Oxford, 1875. For further details as to the life and works of Abu 'l-Walíd see Munk's articles in *Journal Asiatique*, 1850, 1851; and Derenbourg, *op. cit.*

JONAS, JUSTUS (1493-1555), a German Protestant Reformer, was born at Nordhansen in Thuringia 5th June 1493. In 1506 he entered the university of Erfurt, where he graduated in law in 1516; but, having been converted to the doctrines of Luther, he, about 1519, resolved to study theology. In 1521 he accompanied Luther to the diet of Worms. The same year he was appointed professor of canon law at Wittenberg, where shortly afterwards he became doctor in theology, and occupied himself much in preaching. During the next twenty years he took part in many church visitations and conferences, and translated into German several of the works of Luther and Melancthon. In 1541 he became superintendent of the churches at Halle, whence he was banished by the elector Maurice of Saxony in 1546. He returned for a short time in 1547 and again in 1548, but was unable to resume his interrupted tasks; after a short stay at Jena, where he had some share in the ordering of the new university, he became court-preacher at Coburg in 1551. In 1553 he was called as first pastor to Eislefeld, where he died 9th October 1555. Among the theological tractates of Jonas is *Discussio pro conjugio sacerdotali*, 1523. He also wrote an account of the proceedings of the conference of Marburg.

See Reinhard, *De Vita et obitu Justii Jonæ*, 1713; Knapp, *Narratio de Justo Jona*, 1817; and the life by Hasse in Meurer's *Leben der Ältester der luth. Kirche*, 1864.

JONES, INIGO (c. 1572-1651), an English architect, sometimes called the "English Palladio," was the son of a cloth-worker, and was born in London about 1572. It is stated that he became apprenticed to a joiner, but at any rate his talent for drawing attracted somehow the attention of a nobleman, by some affirmed to have been the earl of Arundel, by others the earl of Pembroke, who sent him to study landscape-painting in Italy. His preference soon transferred itself to architecture, and, following chiefly the style of Palladio, he acquired at Venice such considerable reputation that in 1604 he was invited by Christian IV. to Denmark, where he is said to have designed the two great royal palaces of Rosenborg and Frederiksberg. In the following year he accompanied Anne of Denmark to the court of James I. of England, where, besides being appointed architect to the queen and Prince Henry, he was employed in supplying the designs and decorations of the court masques. After a second visit to Italy in 1612, Jones was appointed surveyor-general of the royal buildings by

James I., and was engaged to prepare designs for a new palace at Whitehall. In 1620 he was employed by the king to investigate the origin of Stonehenge, when he came to the absurd conclusion that it had been a Roman temple. Shortly afterwards he was appointed one of the commissioners for the repair of St Paul's, but the work was not begun till 1633. Under Charles I. he enjoyed the same offices as under his predecessor, and in the capacity of designer of the masques he came into collision with Ben Jonson, who on this account has frequently made him the butt of his satire. After the civil war Jones was forced to pay heavy fines as a courtier and malignant. He died in poverty July 5, 1651.

A list of the principal buildings designed by Jones is given in Dallaway's edition of Walpole's *Anecdotes of Painting*, and for an estimate of him as an architect see the article ARCHITECTURE, vol. ii. p. 442, and also Ferguson's *History of Modern Architecture*. The *Architecture of Palladio*, in 4 books, by Inigo Jones, appeared in 1715; *The Most Notable Antiquity of Great Britain, called Stonehenge, restored by Inigo Jones*, in 1655 (an edition, with memoir, 1725); the *Designs of Inigo Jones*, by W. Kent, in 1727; and *The Designs of Inigo Jones*, by J. Ware, in 1757.

JONES, JOHN PAUL (1747-1792), was born July 6, 1747, on the estate of Arbignad, in the parish of Kirkbean and the stewardry of Kirkcudbright, Scotland, where his father, John Paul, was gardener. At twelve he went to sea as apprentice to a merchant of Whitehaven, in whose ships he visited America several times. He became a skilful sailor, and was for some time mate of a slaver in the West Indies. On his way back to England, after leaving the slave trade in disgust, the captain and mate of the ship in which he was both died; and the skilful manner in which Paul Jones brought the ship safely into port induced the owners to appoint him captain. In 1773, having for some unknown reason assumed the cognomen Jones, he settled in Virginia, on a property which had fallen to him on the death of an older brother. When the American war of independence broke out two years later, Jones took up arms for the colonies, and accepted a command in the navy of the new republic. He did good service against his native land, and in 1777 was sent to France to receive a more important command. Disappointed in that, he sailed in 1778 to the English coast in his ship "Ranger," and availed himself of his early knowledge to land at Whitehaven, where, however, he was unsuccessful in his attempt to fire the shipping. Next year he sailed on a similar expedition in the "Bonhomme Richard," along with other vessels, and, steering up the Firth of Forth, was only prevented by a strong westerly gale from attacking Leith. On his way south again he fell in, off Flamborough Head, with the English ship "Serapis," which after a long and bloody combat he compelled to strike. That exploit raised his fame to its acme. On his return to Paris he was feted and caressed by the best society; and Louis XVI. presented him with a gold-hilted sword, and decorated him with the military Order of Merit. After some time spent in America, where he was much chagrined by the neglect that met his boastful requests for further employment, Paul Jones returned to Paris as agent for all prizes taken in Europe under his own command. While he resumed his efforts to pose as a man of *ton*, he attended carefully to his duties. A favourable report to Congress as to his naval services was followed by a vote of a gold medal from that body in 1786. In 1788 the Chevalier Jones entered the service of the empress Catherine of Russia, and became as enthusiastic a Russian as he had been an American. He was appointed to a command in the Black Sea, with the rank of rear-admiral, to act against the Turks; but the jealousy and rivalry of the Russian commanders brought about his recall in less than eight months. Summoned to St Petersburg, on pretext of

receiving a post in the North Sea, he was left in restless idleness, until at last two years' formal leave of absence was granted him. On this virtual dismissal, Paul Jones retired to Paris, soured and disappointed; and after two years spent in fruitlessly importuning the Russian court, he died in that city on July 18, 1792.

Paul Jones is described as a "short, thick, little fellow, about 5 feet 8 inches in height, of a dark swarthy complexion." Naval skill and bravery he certainly had, but his letters prove him to have been boastful and quarrelsome. He writhed under the suspicion of being an "adventurer"; once and again he eagerly repels the charge. English contemporary accounts generally speak of him as a pirate; and, though he certainly ranked as an officer of the United States, the independent manner in which he cruised might well suggest letters of marque rather than a Government commission.

The life of Paul Jones has given rise to much romance. Cooper, Dunas, and Allan Cunningham have celebrated him in their novels; and scarcely less fictitious are some of his so-called biographies. The most authentic seems to be the *Memoirs of Paul Jones*, 2 vols., Edinburgh, 1830.

JONES, OWEN (1741-1814), a Welsh antiquary, was born in 1741 at Llanvihangel Glyn y Myvyr in Denbighshire, and died September 26, 1814, in Thames Street, London. Introduced in 1760 to the service of a London firm of furriers (Kidney & Nutt), he ultimately succeeded to their business, and continued to carry it on with success till his death. His fancy had been fired in boyhood with a passion for the poetry of his country, and, when wealth and leisure were attained, he devoted them both to the acquisition of the ancient monuments of the art. Assisted by Edward William of Glamorgan (Iolo Morganwg), and Dr Owen Pughe, he published, at a cost of more than £1000, the well-known *Myvyrian Archaeology of Wales* (London, 1801-7, 3 vols.), a great collection of pieces dating from the 6th to the 14th century. The manuscripts which he had brought together are now deposited in the British Museum,—the material not utilized in the *Myvyrian Archaeology* amounting to 100 volumes containing 16,000 pages of verse and 15,300 pages of prose. Jones was the founder of the Gwyneddigion Society (1772) in London for the encouragement of Welsh studies and literature; and he commenced in 1805 a miscellany—the *Great*—of which, however, only one volume appeared. An edition of the poems of Davydd ab Gwilym was also issued at his expense. A new edition of the *Myvyrian Archaeology* was published at Denbigh in 1870.

JONES, OWEN (1809-1874), architect and art-decorator, son of the subject of last notice, was born in London in 1809. After an apprenticeship of six years in an architect's office, he travelled for four years in Italy, Greece, Turkey, Egypt, and Spain, making a special study of the Alhambra in the last-mentioned country. On his return to England in 1836 he busied himself in his professional work. His forte was interior decoration, for which his formula was—"form without colour is like a body without a soul." He was one of the superintendents of works for the Exhibition of 1851; and, as director of decorations for the Crystal Palace at Sydenham, he arranged the Egyptian, Greek, Roman, and Alhambra courts, besides being responsible for the general decoration of the whole building. Along with Mr (afterwards Sir Digby) Wyatt, Jones collected the casts of works of art on the Continent which adorn the different courts. In his later years he was much engaged in the decoration of private houses, among which may be reckoned the viceroy of Egypt's palace at Gesch. In 1857 he received the royal medal for architecture; and after other distinctions, he was awarded a diploma of honour at the Vienna Exhibition of 1873. He died in London, April 19, 1874.

Owen Jones is described in *The Builder* for 1874 as "the most potent apostle of colour that architectural England has had in these days." His range of activity is to be traced in his works: *Plans, Elevations, and Details of the Alhambra* (1835-45), in which he was assisted by M. Gouly and Gayangos; *Designs for Mosaic and Tessellated Pavements*, 1842; *Polychromatic Ornament of Italy*, 1845; *An Attempt to define the Principles which regulate the Employment of Colour in Decorative Arts*, 1852; *Handbook to the Alhambra Court; Grammar of Ornament*, fol., 1856, a very important work; *One Thousand and One Initial Letters*, 1864; *Seven Hundred and Two Monograms*, 1864; and *Examples of Chinese Ornament*, 1867.

JONES, SIR WILLIAM (1746-1794), one of the most accomplished linguists and Oriental scholars that England has produced, was born in London September 28, 1746. When seven years old he was sent to Harrow, where he soon far excelled all his school-fellows in every branch of study. But the classical routine of a public school failed to satisfy the ardent thirst for knowledge displayed by the boy from his earliest childhood. He accordingly began to apply himself, during the last three years of his life at Harrow, to the study of Oriental languages, teaching himself the rudiments of Arabic, and becoming sufficiently familiar with Hebrew to be able to read that language with tolerable ease. The greater part of his vacations he devoted to the improvement of his acquaintance with French and Italian by assiduously practising composition in those tongues. In 1764 young Jones went to Oxford and entered University College, where he continued to prosecute his studies with unabated vigour. Though obliged to give up a considerable portion of his time to the classical studies required by the university course, he still directed his attention chiefly to Oriental literature, particularly to Persian and Arabic. In acquiring the latter language he received effective assistance from a Syrian named Mirza, whom he discovered in London and brought with him to Oxford. Meanwhile, however, not content with all this work, he managed to make considerable progress in Italian, Spanish, and Portuguese. At nineteen he left Oxford to become tutor to Earl Spencer's eldest son, and remained with that nobleman's family for five years. In 1766 Jones obtained a fellowship which placed him in a position of independence, and enabled him to give his undivided attention to his linguistic pursuits. On his return from a short visit to the Continent, where he picked up some knowledge of German, he began the study of Chinese, and made himself master of the radical characters of that language. Though not more than twenty-two years of age, he was already becoming famous for his acquirements as a linguist and Oriental scholar. Accordingly when Christian VII., king of Denmark, visited England in 1768, bringing with him a life of Nadir Shah in Persian, Jones was requested to render the MS. into French. He agreed, and the translation appeared in 1770, with an introduction containing a description of Asia and a short history of Persia (2 vols. 8vo; new ed., 1790). This was followed in the same year by a treatise in French on Oriental poetry, and by a metrical translation, in the same language, of the odes of Hafiz.

For some time Jones had been thinking of taking up the law as a profession, and, having now finally decided on doing so, he became a member of the Temple. About this time the French Orientalist, Anquetil Du Perron, published his translation of the *Zend Avesta*, in the introduction to which he made an unjustifiable attack on Oxford. Jones, taking on himself the defence of his university, addressed an anonymous letter in French to Du Perron, in which he was convicted that scholar of unwarrantable invective and wilful misrepresentation. It is a remarkable proof of Jones's great talent for languages that the racy and idiomatic style of the French in this pamphlet led several foreign savans to attribute it to the pen of some *bel esprit*



of the French capital. In the same year appeared his grammar of the Persian language (9th ed., with corrections and additions by Samuel Lee, D.D., Lond., 1828), which is still considered one of the best text-books on the subject. In 1772 Jones published a small volume of poems, chiefly translations from Asiatic languages, together with two elegant essays on the poetry of Eastern nations and on the arts commonly called imitative. His next publication, which appeared in 1774, was a treatise entitled *Poeseos Asiaticæ commentariorum libri sex*, the chief aim of which was to familiarize the European mind with the genius of Oriental poetry.

Being now admitted to the bar, Jones determined to give up all his energies to his legal studies, and renounced polite literature for some years. Setting to work with the same eagerness which he displayed in the pursuit of all other kinds of knowledge, he made it his endeavour, not merely to master the technicalities of law, but to devote himself to it as a branch of philosophy. Having within two years acquired a considerable legal reputation, he was in 1776 appointed commissioner of bankrupts. In 1780 he was induced by his friends to come forward as a candidate for the representation of the university of Oxford in parliament, but he withdrew from the contest before the day of election, as he found he had no chance of success, owing to the liberal principles he held, especially on the questions of the American war and of the slave trade.

In the winter of 1780–81 he found leisure to complete his translation of the seven ancient Arabic poems called *Moallakât*. Besides writing an *Essay on the Law of Bailments*, Jones translated in 1781 the speeches of Isæus on the right of inheritance, and an Arabian poem on the Mahometan law of succession to the property of intestates, as bearing on his legal studies.

The hopes which he had for some time entertained of obtaining a seat on the judicial bench in Bengal, were at last gratified on the accession to power of the Shelburne administration, by which he was in 1783 appointed a judge of the supreme court of judicature at Fort William, at the same time receiving the honour of knighthood. Shortly after his arrival in Calcutta he founded, in January 1784, the Asiatic Society, of which he remained president till his death. Convinced as he was of the great importance of consulting the Hindu legal authorities in the original, he lost no time in commencing the study of Sanskrit. Having in a few years made himself complete master of the language, he undertook, in 1788, the task of compiling a digest of Hindu and Mahometan law, the completion of which he did not live to see; the work was finished, however, by Colebrooke, who edited it at Calcutta in 1800 under the title of *Digest of Hindu Laws*. In 1789 Sir William Jones published the first volume of *Asiatic Researches* and his translation of *Sakuntalâ*, the most famous play of Kâlidâsa, the greatest Indian dramatist. He also translated the well-known collection of fables entitled the *Hitopaleça*, the *Gîtâgovinda*, an erotic poem by Jayadeva, and considerable portions of the Veda, besides editing the text of the *Ritusamhâra*, a short but celebrated poem by Kâlidâsa. His last work, which appeared in 1794, was the translation of the *Institutes of Manu*, a compilation of laws and ordinances, dating from the 5th century B.C. Sir William's unremitting literary labours, together with the conscientious performance of his heavy judicial work, could not fail to tell on his health after a ten years' residence in the climate of Bengal; and he was about to return to England when a sudden attack of inflammation of the liver carried him off in the forty-eighth year of his age (April 27, 1794).

The amount of labour of various kinds which Sir William Jones compressed into the space of a comparatively short life seems almost

incredible. In addition to numerous other acquirements, he knew thirteen languages well, and had an elementary acquaintance with twenty-eight others. His capacity for assimilating and reproducing knowledge of every sort was almost unparalleled. But his works, though they display a vast amount of learning, do not bear the stamp of genius. He shows no originality either in discovering new truths or in placing old truths in a new light. Had he concentrated his powers, his extraordinary industry might have secured him greatness in some one branch of knowledge; but their diffusion over too great a surface contributed greatly to that weakness which is so manifest both in his style and in his critical faculty. His chief claim to the remembrance of posterity will rest on the fact that by founding the Asiatic Society he rendered the language and literature of the ancient Hindus accessible to European scholars, and thus became the indirect cause of the splendid achievements in the field of Sanskrit and comparative philology which the present century has witnessed.

Sir William Jones's complete works were edited in 1799 (6 vols. 4to), and reprinted in 1807 (13 vols. 8vo). Lord Teignmouth published memoirs of his life, writings, and correspondence in 1807 (new ed. 1855, 2 vols. 8vo); and an autobiography, published by his son, was printed in 1846. (A. A. M.)

JONES, WILLIAM (1726–1800), a divine of the Church of England, and one of the principal followers of John Hutchinson, was born at Lewick, Northamptonshire, July 30, 1726. By his father's side he was descended from an old Welsh family, and one of his progenitors was Colonel Jones, brother-in-law of Cronwell. He was educated at Charterhouse school, from which he received an exhibition to University College, Oxford. There a kindred taste for music, as well as a similarity in regard to other points of character, led to his close intimacy with George Horne, afterwards bishop of Norwich, who, chiefly through his arguments, was induced to embrace Hutchinsonian doctrines. After obtaining his bachelor's degree in 1749, Jones was curate successively at Finedon and Waddenhoe in Northamptonshire. In 1764 he was presented to the vicarage of Bethersden in Kent, and shortly afterwards to the rectory of Pluckley in the same county, where he took up his residence. In 1776 he removed to Nayland, Suffolk, of which he obtained the perpetual curacy, and, although in 1798 he became rector of Hollingbourn, Kent, he continued to reside at Nayland till his death. 6th January 1800.

In 1756 Jones published his tractate *On the Catholic Doctrine of the Trinity*, a statement of the doctrine from the Hutchinsonian point of view, with a succinct and able summary of Scriptural proofs. This was followed in 1762 by an *Essay on the First Principles of Natural Philosophy*, in which he maintained the theories of Hutchinson in opposition to those of Sir Isaac Newton, and in 1781 he gave a more extended exposition of his opinions in *Physiological Disquisitions*. Among his other works are—*Lectures on the Figurative Language of the Holy Scripture*, 1786; *The Scholar Armed*, 1792; and a life of Bishop Horne, prefixed to Horne's collected *Works*, 1795. Jones was also the originator of the *British Critic*, the first number of which appeared in May 1793. His collected works, with a life by W. Stevens, appeared in 1801, in 12 vols., and his theological and miscellaneous works with life were reprinted in 1810. Since that time various editions of his works have appeared, as well as some volumes of his sermons. A life of Jones, forming part 5 of the *Biography of English Divines*, was published in 1849.

JONKÖPING, a town of Sweden, at the head of the län of the same name, in 57° 48' N. lat., about 170 miles south-west of Stockholm, and 80 east of Gothenburg. It occupies a beautiful but somewhat unhealthy position in a valley between the southern end of Lake Wetter and two smaller lakes known as the Recksjö and the Munksjö; the very names, indeed, of two parts of the town, the Tyska Mad and the Svenska Mad, refer to the time when the site was a marsh and the buildings had to be erected on piles. The church of St Christina, dating from 1649–1673, the supreme court (built as a private enterprise in 1665), the town-house (rebuilt after the conflagration of 1691), the buildings of the provincial administration, the artillery barracks, a theatre, and the high school are the more noteworthy edifices. Jönköping is well known as the seat of a great safety-match factory, which produced in 1860

upwards of 35,000,000 boxes, of the value of £11,390, while in 1874 the value reached the sum of £150,000. It also contains snuff and cigar factories, an asphalt factory, dye-works, damask factories, and a variety of minor establishments. The population, which has been steadily increasing, numbered 15,037 in 1878.

Jönköping is mentioned as early as 1284 or 1288, and the castle in 1263, when Waldemar Biggersson married the Danish princess Sophia. It was afterwards the scene of many events of moment in Scandinavian history:—the parliaments of 1357, 1439, and 1599; the meeting of the Danish and Swedish plenipotentiaries in 1448; and the death of Sten Stura, the elder, in 1503. In 1612 Gustavus Adolphus caused the inhabitants to destroy their town lest it should fall into the hands of the Danes; but it was rebuilt soon after, and in 1620 received special privileges from the king. It was from the Dutch and German workmen, introduced at this time, that the quarter Tyska Mad received its name. In 1809 the plenipotentiaries of Sweden and Denmark concluded peace in the town.

JONSON, BEN (for thus his Christian name was usually abbreviated by himself and his contemporaries, and thus, in accordance with his famous epitaph, it will always continue to be abbreviated by posterity), was born about the beginning (N. S.) of the year 1573. By the poet's account his grandfather had been a gentleman who "came from" Carlisle, and originally, the grandson thought, from Annandale, where Johnstons or Johnstones appear to have abounded, and where indeed at least one resident of that name is noticed in the reminiscences of a later native of the border district resembling Ben himself in the quickness of his temper and in his impatience of pretences and pretenders,—the late Thomas Carlyle. Ben Jonson further related that he was born a month after the death of his father, who, after suffering in estate and person under Queen Mary, had in the end "turned minister." Two years after the birth of her son the widow married again; she may be supposed to have loved him in a passionate way peculiar to herself, since on one occasion we shall find her revealing an almost ferocious determination to save his honour at the cost of both his life and her own. Jonson's stepfather was a master bricklayer in or near Westminster, who—whether or not he afterwards constrained his stepson, while acquainting himself with the business into which he had been admitted, to undergo the degradation of laying a few bricks with his own trowel—certainly allowed him to lay for himself the foundations of a good education. After attending a private school in the neighbourhood, he was sent to Westminster school,—nor is it at all obvious why the master bricklayer should have been denied the credit of having sent him there. Jonson's gratitude, however, for an education to which in truth he owed an almost inestimable debt, concentrated itself upon the "most reverend head" of the illustrious Camden, then second and afterwards head master of the famous school, and the firm friend of his pupil in later life.

After reaching the highest form at Westminster, Jonson is stated, but on unsatisfactory evidence, to have proceeded to the university of Cambridge; but at the utmost he can only have made a transitory appearance in a scene of which as a painter of men and manners he nowhere reproduces a single feature. And doubtless he felt that neither his crop of learning and experience nor his wild oats were yet fully sown, when, goose quill or other implement in hand, he had to apply himself to the family business. He soon had enough of it, and was soldiering in the Netherlands, much to his own subsequent satisfaction when the days of self-conscious retrospect arrived, but to no further purpose beyond that of seeing something of the world. By the middle of 1597 we at last come across documentary evidence of him at home in London, in the shape of an entry in Henslowe's diary on July 28th of 3s. 6d. "received of Bengemenes Johnsenes share." He was therefore by

this time, when Shakespeare, his senior by nearly nine years, was already in prosperous circumstances and good esteem, at least a regular member of the profession, with a fixed engagement in the Lord Admiral's company, then performing under the experienced Henslowe's management at the Rose. The traditions may very possibly be true according to which he had previously acted at the Curtain (a former house of the Lord Admiral's men), and "taken mad Jeronimo's part" as a stroller. This latter appearance would in that case have probably been in *The Spanish Tragedy*, since in *The First Part of Jeronimo* Jonson would have had to dwell on the "smallness" of his "bulk." He was at a subsequent date (1601) employed by Henslowe to write up *The Spanish Tragedy*, in pursuance of a fashion differing from that of later times, when old plays have more usually been written down to the taste of modern audiences. Jonson's additions, which were not the first changes made in the play, are usually supposed to be those printed with *The Spanish Tragedy* in the edition of 1602; Charles Lamb's doubts on the subject are an instance of that subjective kind of criticism in which it is unsafe to put absolute trust.

Ben Jonson may be supposed to have married two or three years before the date of Henslowe's first entry of his name. Of his wife he afterwards spoke with scant enthusiasm, and for one (undated) interval of five years he preferred to live without her. Long burnings of "oil" among his books, and long spells of recreation at the tavern, such as Jonson loved, are not the most favoured accompaniments of family life. But Jonson was no stranger to the tenderest of affections: two at least of the several children whom his wife bore to him he commemorated in touching little tributes of verse; nor in speaking of his lost eldest daughter did he forget "her mother's tears."

Within a year's time, or little more, from the date at which we first find Ben Jonson in well-authenticated connexion with the English stage, he had produced one of the most memorable plays in its history. *Every Man in his Humour*, the original example of a species of English comedy which cannot be said to have become altogether extinct even with the Restoration, was first acted in 1598—probably in the earlier part of September—by the Lord Chamberlain's company, which was then still performing at the so-called Theatre, and in which Shakespeare, was just on the eve of acquiring one or more shares. He certainly was one of the actors in Jonson's comedy, and it is in the character of Old Knowell in this very play that, according to a bold but ingenious guess, Shakespeare is represented in the half-length portrait of him in the folio of 1623, beneath which were printed Jonson's lines concerning the picture. *Every Man in his Humour* was probably followed by *The Case is Altered*, which was certainly acted by 1599, and which contains a satirical attack upon the pageant poet Anthony Munday. Inasmuch as the earlier of these two comedies was indisputably successful, and as Jonson's reputation was already sufficient to ensure him a mention in the *Palladis Tamia* of Francis Meres, published in the same year, 1598, as one of the chief writers in tragedy (on the strength of what play or plays is unknown), it was an awkward fatality that before the year was out he should have found himself in prison and in danger of the gallows. He had had the misfortune of killing in a duel, fought in Hogsden Fields, for some cause unknown, an actor of Henslowe's company named Gabriel Spenser; possibly Henslowe's uncourteous designation of Jonson as a "bricklayer" may imply that the success of the new comedy at the other house had not been a subject of congratulation at that to which its author had formerly belonged. In prison Jonson was visited by &



Roman Catholic priest—a prison being the most likely place in which to meet a priest in those days; and the result was his conversion to the Church of Rome, to which he adhered for twelve years. Jonson was afterwards a diligent student of divinity; but, though his mind was religious, it is not probable that its natural bias much inclined it to dwell upon creeds and their controversies. Though in prison spies were set upon him, which was then thought to be an admirable method for expediting justice, yet his judges (he afterwards boasted) could get nothing out of him but “aye” or “no.” And thus after a short imprisonment he was released, some time early in 1599, in which year he is found back again at work for Henslowe, receiving, together with Dekker, Chettle, and “another gentleman,” earnest-money for a tragedy called *Robert II., King of Scots*. It is of more importance that in the same year he brought out through the Lord Chamberlain’s company (possibly already at the Globe, then newly built or building) the elaborate comedy of *Every Man out of his Humour*,—a work which subsequently had the honour, for which it was in some respects specially fitted, of being presented before Queen Elizabeth. The sunshine of court favour, rarely diffused during her reign in rays more than metaphorically golden, was not to bring any material comfort to the most learned of her dramatists, before the inevitable hand was laid upon her of which his courtly epilogue had besought death to forget the use. Indeed, of his *Cynthia’s Revels* (1600), no doubt primarily designed as a piece of unctuous flattery to the address of the queen, the most marked result had been to offend two playwrights of note with whom he had formerly worked in company—Dekker, who had a coarse and healthy grip of his own, and Marston, who was perhaps less dangerous by his strength than by his versatility. Learning their intention, or at least that of Dekker, to wreak literary vengeance upon him, he seems to have sought to anticipate its effect by covering them with contemptuous ridicule beforehand. *The Poetaster* (1601), which he states to have been completed fifteen weeks after the plot of it was first conceived, did not, however, silence his adversaries; it rather gave them the opportunity of the last word, which Dekker took in producing his *Satiromastix, or the Untrussing of the Humorous Poet* (1602). There was indeed an attempt at some more last words on Jonson’s part; but on the whole he appears to have thought (and very wisely) that the time for a season of silence had arrived for him as a court poet. According to a statement by Overbury, early in 1603, “Ben Johnson, the poet, now lives upon one Townesend”—who this generous patron was we do not know—“and scorns the world.” That, however, he was not sulking in the friendly tent with which he had been accommodated is shown by the fact that in this year (1603) was produced at the Globe the earlier of his two extant tragedies, *Sejanus*,—Shakespeare once more taking a part in the performance. Meanwhile, in the year which dates the tragedy concerning the fall of the great favourite, there had begun a reign in England destined to be remembered as that of favourites hardly less hated than he. Adulatory loyalty seemed intent on showing that it had not exhausted itself at the feet of Gloriana, and Jonson’s well-stored brain and ready pen had their share in devising and executing ingenious variations on the theme “Welcome—since we cannot do without thee!” It is very remarkable how promptly his genius, which it is sheer prejudice to describe as wanting in flexibility and lightness, suited itself to the sudden demands of the new taste for masks and entertainments—new of course in degree rather than in kind—introduced with the new reign. The pageant which on the 7th of May 1603 bade the king welcome to a capital dissolved in joy was partly of Jonson’s partly of

Dekker’s devising; and, having thus been prominently brought into notice, he was able to deepen and diversify the impression by the composition of masks presented to James I. when entertained at houses of the nobility. He was soon occasionally employed by the court itself,—already in 1606 in conjunction with Inigo Jones as responsible for the “painting and carpentry,”—and thus speedily showed himself master in a species of composition to which he, more than any other of our poets before Milton, secured an enduring place in our national poetic literature. Personally, no doubt, he derived considerable material benefit from the new fashion, very valuable to poets in days when there were no monthly magazines,—more especially if his statement to Drummond was any thing like correct, that out of his plays he had never gained a couple of hundred pounds.

Good humour seems to have come back with good fortune. Joint employment had reconciled him with Dekker; and with Marston also he was again on good terms. When therefore, in 1604, the latter and Chapman (who, Jonson told Drummond, was loved of him, and whom he had probably honoured as “Virgil” in *The Poetaster*) produced the excellent comedy of *Eastward Ho*, it appears to have contained some contributions by Jonson; at all events, when the authors were arrested on account of one or more passages in the play which were deemed insulting to the Scotch, he voluntarily imprisoned himself with them. They were soon released, and a banquet at his expense, attended by Camden and Selden, terminated the incident. If Jonson is to be believed, there had been a report that the prisoners were to have their ears and noses cut, and, with reference apparently to this peril, “at the midst of the feast his old mother drank to him, and showed him a paper which she had intended (if the sentence had taken execution) to have mixed in the prison among his drink, which was full of lusty strong poison; and that she was no churl, she told him, she minded first to have drunk of it herself.” Strange to say, in 1605 Jonson and Chapman, though the former, as he averred, had so “attempered” his style as to have “given no cause to any good man of grief,” were again in prison on account of “a play”; but they appear to have been once more speedily set free, in consequence of the (very manly and dignified) letter addressed by Jonson to the earl of Salisbury. In the same year he played a part—which had till recently remained unknown, and is still in some measure obscure—in the mysterious history of the Gunpowder Plot. On November 7th, very soon after the discovery of the conspiracy, whose threads it became the immediate duty of the council to unravel, that body appears to have sent for Ben Jonson, at the advice no doubt of Salisbury, who (as has just been seen) knew of Jonson; indeed, the latter has been supposed to have given his support as a dramatist to the party headed by Robert Cecil before Queen Elizabeth’s death. As a loyal Roman Catholic Jonson was asked, and undertook to give, his good offices in inducing the priests to do something required by the council,—one hardly likes to conjecture it to have been some tampering with the secrets of confession. In any case, the negotiations fell through, because the priests declined to come forth out of their hiding-places to be negotiated with—greatly to the wrath of Ben Jonson, who declares in a letter to Lord Salisbury that “they are all so enweaved in it that it will make 500 gentlemen less of the religion within this week, if they carry their understanding about them.” Jonson himself, however, did not declare his separation from the Church of Rome for five years longer, however much it might have been to his advantage to do so.

His powers as a dramatist were at their height during

the earlier half of the reign of James I.; and by the year 1616 he had produced nearly all the plays which are worthy of his genius. They include the tragedy of *Catiline* (1611), which achieved only a doubtful success, and the comedies of *Volpone* or *The Fox* (acted 1605), *Epicene* or *The Silent Woman* (1609), the *Alchemist* (1610), *Bartholomew Fair* (1614), and *The Devil is an Ass* (1616). During the same period he produced several masks, usually in connexion with Inigo Jones, with whom, however, he seems to have quarrelled already in this reign, though it is very doubtful whether the architect is really intended to be ridiculed in *Bartholomew Fair* under the character of Lanthorn Leatherhead. In 1616 a modest pension of 100 marks a year was conferred upon him; and possibly this mark of royal favour may have encouraged him to the publication of the first volume of the folio collected edition of his works (1616).

He had other patrons more countful than the crown, and for a brief space of time (in 1613) had travelled to France as governor to the eldest son of Sir Walter Raleigh, then a state prisoner in the Tower, for whose society Jonson may have gained a liking at the Mermaid Tavern in Cheapside, but for whose moral character he, like so many of his contemporaries, seems to have had but small esteem. Thus by the year 1616 Jonson seems to have made up his mind to cease writing for the stage, where neither his success nor his profits had equalled his merits and expectations. He continued to produce masks and entertainments when called upon; but he was attracted by many other literary pursuits, and had already accomplished enough to furnish plentiful materials for retrospective discourse over pipe or cup. He was already entitled to lord it at the Mermaid, where his quick antagonist in earlier wit-combats no longer appeared even on a visit from his comfortable retreat at Stratford. That on the other hand Ben carried his wicked town habits into Warwickshire, and there, together with Drayton, made Shakespeare drink so hard with them as to bring upon himself the fatal fever which ended his days, is a bit of petty scandal with which we may fairly refuse to load his memory.

It was in the year 1618 that Ben Jonson, like his great namesake a century and a half afterwards, resolved to have a real holiday for once, and about midsummer started for his ancestral country, Scotland. He had (very heroically for a man of his habits) determined to make the journey on foot; and—imitation is the sincerest kind of flattery—was speedily followed by John Taylor, the water-poet, who still further handicapped himself by the condition that he would accomplish the pilgrimage without a penny in his pocket. Jonson (who put money in his good friend's purse when he came up with him at Leith) spent more than a year and a half in the hospitable Lowlands, being solemnly elected a Burgess of Edinburgh, and on another occasion entertained at a public banquet there. But the best remembered hospitality which he enjoyed was that of the learned and refined Scottish poet Drummond of Hawthornden, to which we owe the so-called *Conversations*. In these famous jottings, the work of no extenuating hand, Jonson lives for us to this day, delivering his censures freely in praise and blame, but by no means generously described in the postscript added by his exhausted host as "a great lover and praiser of himself, a contemner and scorner of others." A poetical account of this journey, "with all the adventures," was burnt with Jonson's library.

After his return to England Jonson appears to have resumed his former course of life. In 1619 his visits to the country seats of the nobility were varied by a sojourn at Oxford with Corbet at Christ Church, on which occasion a master's degree was conferred upon him by the university. He confessed about this time that he was or seemed

growing "restive," i.e., lazy, though it was not long before he returned to the occasional composition of masks. The extremely spirited *Gipsies Metamorphosed* (1621) was thrice presented before the king, who was so pleased with it as to grant to the poet the reversion of the office of master of the revels, besides proposing to confer upon him the honour of knighthood. This honour Jonson (hardly in deference to the memory of Sir Petronel Flash) declined, but there was no reason why he should not gratefully accept the increase in his pension, which was in the same year (1621) raised to 200 marks. Yet the close of king James I.'s reign found the foremost of the poets of the time in an anything but prosperous condition. It would be unjust to hold "The Sun," "Thé Dog," "The Triple Tun," or the "Old Devil" with its Apollo club-room, where Ben's supremacy must by this time have become established, responsible for this result; taverns were the clubs of that day, and a man of letters is not considered lost in our own because he "haunts" a smoking-room in Pall Mall. Disease had weakened the poet's strength, and the burning of his library, as his *Execration upon Vulcan* sufficiently shows, must have been no mere transitory trouble to a poor man of letters. He thus thought it best to recur to writing for the stage, and in 1625 produced, with no faint heart, but with a very clear anticipation of the comments which would be made upon the reappearance of the "huge, overgrown play-maker," *The Staple of News*, a comedy excellent in some respects, but little calculated to become popular. In 1628, on the death of Middleton, some interest obtained for him the appointment of city chronologer, with a salary of 100 nobles a year—an office of which he appears to have considered the duties as purely ornamental, inasmuch as in 1631 his salary was suspended until he should have presented some fruits of his labours in his place, or—as he more succinctly phrased it—"yesterday the barbarous court of aldermen have withdrawn their chandlerly pension for verjuice and mustard, £33, 6s. 8d." After being in 1628 arrested by mistake on the utterly false charge of having written certain verses in approval of the assassination of Buckingham, he was soon allowed to return to Westminster, where it would appear from a letter of his "son and contiguous neighbour," James Howell, he was living in 1629, and about this time narrowly escaped another conflagration. In the same year (1629) he once more essayed the stage with the comedy of *The New Inn*, which was actually, and on its own merits not unjustly, damned on the first performance. The epilogue dwelt not without dignity upon the neglect which the poet had experienced at the hands of "king and queen"; and it is honourable to King Charles I. that he should not only have immediately sent the unlucky author a gift of a hundred pounds, but on receiving another more cheerful versified appeal in response, should have increased his standing salary to the same sum, with the addition of an annual tierce of canary,—henceforth the poet-laureate's customary royal gift. But though he afterwards composed one or two little entertainments, and even a comedy or two, there seemed little power left in his palsy-stricken hand. The patronage of kind friends like the earl of Newcastle was never wholly wanting to him; nor could he have ended in neglect. He was the acknowledged chief of English literature, both at the festive meetings where he ruled the roost among the younger authors whose pride it was to be "sealed of the tribe of Ben," and by the avowal of grave writers, old or young, not one of whom would have ventured to dispute his pre-eminence. Nor was he to the last unconscious of the claims upon him which his position brought with it. When death came upon him on August 6, 1637, he left behind him an unfinished work of great beauty, the pastoral drama



or *The Sad Shepherd*: For forty years, he said in the prologue, he had feasted the public; at first he could scarcely hit its taste, but patience had at last enabled it to identify itself with the working of his pen.

We are so accustomed to think of Ben Jonson presiding, attentive to his own applause, over a circle of youthful followers and admirers, that we are apt to forget the hard struggle which he had passed through before gaining the crown now universally acknowledged to be his. Howell records, in the year before Ben's death, that at a solemn supper at the poet's own house, where the host had almost spoiled the relish of the feast by vilifying others and magnifying himself, "T. C." (Thomas Carew) buzzed in the writer's ear "that, though Ben had barrell'd up a great deal of knowledge, yet it seem'd he had not read the *Ethics*, which, among other precepts of morality, forbid self-commendation." Self-reliance is but too frequently coupled with self-consciousness, and for good and for evil self-confidence was no doubt the most prominent feature in the character of Ben Jonson. Hence the combativeness which involved him in so many quarrels in his earlier days, and which jarred so harshly upon the gentler nature of Drummond. But his quarrels do not appear to have entered deeply into his soul, or indeed usually to have lasted long.<sup>1</sup> He was too exuberant in his vituperations to be bitter, and too outspoken to be malicious. He loved of all things to be called "honest," and there is every reason to suppose that he deserved the epithet. The old superstition, which may perhaps still linger here and there, hardly needs notice, according to which Jonson was filled with malignant envy of the greatest of his fellow-dramatists, and lost no opportunity of giving expression to it. Those who consider that Shakespeare was beyond the criticism of his contemporaries—as he certainly very frequently is above that of posterity—may find blasphemy in the saying of Jonson that Shakespeare "wanted art." Occasional jesting allusions to particular plays of Shakespeare may be found in Jonson, among which should hardly be included the sneer at *Pericles*; but these amount to nothing collectively, and to very little individually; and against them have to be set, not only the many pleasant traditions concerning the long intimacy between the pair, but also the noble lines, as noble as they are judicious, dedicated by the survivor to "the star of poets." But if Gifford had rendered no other service to Jonson's fame, he must be allowed to have once for all vindicated him from the cruellest aspersion which has ever been cast upon it. That in general Ben Jonson was a man of strong likes and dislikes, and was wont to manifest the latter as vehemently as the former, it would be idle to deny. He was at least impartial in his censures, dealing them out freely to Puritan poets like Wither and princes of his church like Cardinal Duperron. And, if sensitive to attack, he seems to have been impervious to flattery—to judge from the candour with which he condemned the foibles even of so enthusiastic an admirer as Beaumont. The personage that he disliked the most, and abused the most roundly to its face, was unfortunately one with many heads and a tongue to hiss in each,—no other than that "general public" which it was the radical mistake of his life to fancy he could "rail into approbation" before he had effectively secured its goodwill. And upon the whole it may be said that the admiration of the few, rather than the favour of the many, has kept green the fame of the most independent among all the masters of an art which, in more senses than one, must please to live.

<sup>1</sup> With Inigo Jones; however, in quarrelling with whom, as Howell reminds Jonson, the poet was virtually quarrelling with his bread and butter, he seems to have found it impossible to live permanently at peace; his satirical *Epistulation* against the architect was published as late as 1635.

Jonson's learning and industry, which were alike exceptional, by no means exhausted themselves in furnishing and elaborating the materials of his dramatic work. His enemies sneered at him as a translator—a title which only a generation earlier would have been esteemed of all literary titles the most honourable. But his classical scholarship shows itself not only in his translations from the Latin poets (the *Ars Poetica* in particular), in addition to which he appears to have written a version of Barclay's *Argenis*: it was likewise the basis of his *English Grammar*, of which nothing but the rough draft remains (the MS. itself having perished in the fire in his library), and in connexion with the subject of which he appears to have pursued other linguistic studies (Howell in 1629 is trying to procure him a Welsh grammar). And its effects are very visible in some of the most pleasing of his non-dramatic poems, which often display that combination of polish and simplicity hardly to be attained to—hardly even to be appreciated—without some measure of classical training.

Exclusively of the few lyrics in Jonson's dramas (which, with the exception of the stately choruses in *Catiline*, charm, and perhaps may surprise, by their lightness of touch), his non-dramatic works are comprised in the following collections. The book of *Epigrams* (published in the first folio of 1616) contained, in the poet's own words, the "ripest of his studies." His notion of an epigram was the ancient not the restricted modern one—still less that of the critic (R. C., the author of the *Times' Whistle*) in whose language, according to Jonson, "witty" was "obscene." On the whole, these epigrams excel more in encomiastic than in satiric touches, while the pathos of one or two epitaphs in the collection is of the truest kind. In the lyrics and epistles contained in the *Forest* (also in the first folio), Jonson shows greater variety in the poetic styles adopted by him; but the theme of love, which Dryden considered conspicuous by its absence in the author's dramas, is similarly eschewed here. The *Underwoods* (which were not published collectively till the second and surreptitious folio) are a miscellaneous series, comprising, together with a few religious and a few amatory poems, a large number of epigrams, epitaphs, elegies, and "odes," including both the tributes to Shakespeare and several to royal and other patrons and friends, besides the *Execration upon Vulcan*, and the characteristic ode addressed, apparently in the earlier part of his career, by the poet to himself. To these pieces in verse should be added the *Discoveries*—an often highly interesting commonplace-book of aphorisms that occurred to the poet in his daily readings,—self-communings of a more tranquil and perhaps a more sober kind than the outpourings of the *Conversations at Hawthornden*.

The dramatic works of Ben Jonson fall into three or, if his fragmentary pastoral drama be considered to stand by itself, into four distinct divisions. His tragedies are only two in number—*Sejanus his Fall*, and *Catiline his Conspiracy*.<sup>2</sup> Of these the earlier, as is worth noting, was produced at Shakespeare's theatre, in all probability before the first of Shakespeare's Roman dramas, and still contains a considerable admixture of rhyme in the dialogue. Though perhaps less carefully elaborated in diction than its successor, *Sejanus* is at least equally impressive as a highly-wrought dramatic treatment of a complex historic theme. The character of Tiberius adds an element of curious psychological interest which is wanting in *Catiline* and his surround-

<sup>2</sup> Of *The Fall of Mortimer* Jonson left only a few lines behind him; but, as he also left the argument of the play, factious ingenuity contrived to furnish up the relic into a libel against Queen Caroline and Sir Robert Walpole in 1731, and to revive the contrivance by way of an insult to the princess dowager of Wales and Lord Bute in 1762.

ings; but in both plays the action is powerfully conducted, and the care bestowed by the dramatist upon the great variety of characters introduced cannot, as in some of his comedies, be said to distract the interest of the reader. Both these tragedies are noble works, though the relative popularity of the subject has perhaps secured the preference to *Catiline*. Yet this play and its predecessor were alike too manifestly intended by their author to court the goodwill of what he calls the "extraordinary" reader. It is difficult to imagine that (with the aid of judicious shortenings) either could altogether miss its effect on the stage; but, while Shakespeare causes us to forget, Jonson seems to wish us to remember, his authorities. The half is often greater than the whole: and Jonson, like all dramatists and, it might be said, all novelists in similar cases, has had to pay the penalty incurred by too obvious a desire to underline the learning of the author.

Perversity—or would-be originality—alone could declare Jonson's tragedy preferable to his comedy. Even if the revolution which he created in the latter branch of the drama had been mistaken in its principles or unsatisfactory in its results, it would be clear that the strength of his dramatic genius lay in the power of depicting a great variety of characters, and that in comedy alone he succeeded in finding a wide field for the exercise of this power. There may have been no very original or very profound discovery in the idea which he illustrated in *Every Man in his Humour*, and, as it were, technically elaborated in *Every Man out of his Humour*,—that in many men one quality is observable which so possesses them as to draw the whole of their individualities one way, and that this phenomenon "may be truly said to be a humour." But by refusing to apply this term to a mere peculiarity or affectation of manners, and restricting its use to actual or implied differences or distinctions of character, he broadened the whole basis of English comedy after his fashion, as Molière at a later date did that of French after his. It does not of course follow that Jonson's disciples, the Bromes and the Cartwrights, always adequately reproduced the master's conception of "humorous" comedy. Jonson's wide and various reading helped him to diversify the application of his theory, while perhaps at times it led him into too remote illustrations of it. Still, Captain Bobadil and Captain Tucca, Macilente and Fungoso, Volpone and Mosca, and a goodly number of other characters commend themselves readily, as well as distinctly enough to the memory of those who have once made their acquaintance. It is a very futile criticism to condemn Jonson's characters as a mere series of types of general ideas; on the other hand, it is a very sound criticism to object, as Barry Cornwall does, to the "multitude of characters who throw no light upon the story, and lend no interest to it, occupying space that had better have been bestowed upon the principal agents of the plot."

In the construction of plots, as in most other respects, Jonson's at once conscientious and vigorous mind led him in the direction of originality; he depended to a far less degree than the greater part of his contemporaries (Shakespeare with the rest) upon borrowed plots. But either his inventive character was occasionally at fault in this respect, or his devotion (so to speak) to his characters often diverted his attention from a brisk conduct of his plot. The writer just quoted has directed attention to the essential likeness in the plot of two of Jonson's best comedies, *Volpone* and *The Alchemist*, and another critic, unsurpassed in his delicate appreciation of the relations between the drama and the stage,—Mr W. Bedham Donne,—has dwelt on the difficulty which, in *The Poetaster* and elsewhere, Ben Jonson seems to experience in sustaining the promise of his actions. *The Poetaster* is, however, a play

*sui generis*, in which the real business can hardly be said to begin till the last act.

Dryden, when criticizing Ben Jonson's comedies in a superfine vein, which (to do him justice) he very rarely indulged, thought fit, while allowing the old master humour and incontestable "pleasantness," to deny him wit and those ornaments thereof which Quintilian reckons up under the terms *urbana, salsa, faceta*, and so forth. Such wit as Dryden has in view is the mere outward fashion or style of the day, the euphuism or "sheerwit" or *chic* which is the creed of the Fastidious Brisks and of their crafty purveyors at any given moment. In this Ben Jonson was no doubt defective; for he was too accurate an observer of men and manners to be himself a man of fashion, literary or otherwise. But it would be an error to suppose him, as a comic dramatist, to have stood towards the world around him in the attitude of a philosopher, careless of mere transient externalisms. It is said that the scene of his *Every Man in his Humour* was originally laid near Florence; and his *Volpone*, which is perhaps the darkest social picture ever drawn by him, plays at Venice. But the atmosphere of his comedies, wherever they may be supposed to play, is familiar enough to any one fairly acquainted with the native surroundings amidst which they were produced; and Ben Jonson's times live for us in his men and women, his country gulls and town gulls, his alchemists and exorcists, his "skeldring" captains and whining Pritans, and the whole ragamuffin rout of his *Bartholomew Fair*, the comedy *par excellence* of Elizabethan low life. After he had described the pastimes, fashionable and unfashionable, of his age, its feeble superstitions and its flaunting naughtinesses, its vapouring affectations and its lying effronteries, with an odour as of "divine tobacco" pervading the whole, little might seem to be left to describe for his "sons" and successors. Enough, however, remained; only that his followers speedily again threw manners and "humours" into one undistinguishable medley.

The gift which both in his art and in his life Jonson lacked was that of exercising the influence or creating the effects which he wished to exercise or create without the appearance of consciousness. Instead of this, influenced no doubt by the example of the free relations between author and public permitted by Attic comedy, he resorted again and again, from *Every Man out of his Humour* to *The Magnetic Lady*, to sundry devices of inductions and commentary intermezzos and appendices, which, though occasionally effective by the excellence of their execution, are to be regretted as introducing into his dramas an exotic and often vexatious element. A man of letters to the very core, he never quite understood that there is and ought to be a wide difference between the world of letters and the world of the theatre.

The richness and versatility of Jonson's genius will never be fully appreciated by those who fail to acquaint themselves with what is preserved to us of his "masks" and cognate entertainments. He was conscious enough of his success in this direction—"next himself," he said, "only Fletcher and Chapman could write a mask." He introduced, or at least established, the ingenious innovation of the anti-mask, which Schlegel has described as a species of "parody added by the poet to his device, and usually prefixed to the serious entry," and which accordingly supplies a grotesque antidote to the often extravagantly imaginative main conception. Jonson's learning, creative power, and humorous ingenuity—combined, it should not be forgotten, with a genuine lyrical gift—all found abundant opportunities for displaying themselves in these productions. Though a growth of foreign origin, the mask was by him thoroughly domesticated in the high places of English literature. He lived long enough to see the species produce its poetic



masterpiece in *Comus*, after which it soon faded away in times too fierce to allow of its further cultivation.

*The Sad Shepherd*, of which Jonson left behind him three acts and a prologue, is distinguished among English pastoral dramas by its freshness of tone; and, though not altogether without either allegorical allusions or classical ornament, breathes something of the spirit of the greenwood, and is not unnatural even in its supernatural element. While this piece, with its charming love-scenes between Robin Hood and Maid Marion, remains a fragment, another pastoral by Jonson, *The May Lord*, has been lost, and a third, of which Loch Lomond was intended to be the scene, probably remained unwritten.

Though Ben Jonson never altogether recognized the truth of the maxim that the dramatic art has properly speaking no didactic purpose, his long and laborious life was not wasted upon a barren endeavour. In tragedy he added two works of uncommon merit to our dramatic literature. In comedy his aim was higher, his effort more sustained, and his success more solid, than were those of any of his fellows. In the subsidiary and hybrid species of the mask, he helped to open a new and attractive though undoubtedly devious path in the field of dramatic literature. His intellectual endowments surpassed those of most of our great dramatists in richness and in breadth; and in energy of application he probably surpassed them all. Yet it is less by these gifts or even by his power of hard work than by the true ring of his manliness that he is uniquely distinguished among his peers.

\* The date of the first folio volume of Jonson's *Works* (of which title his novel but characteristic use in applying it to plays was at the time much ridiculed) has already been mentioned as 1616; the second is described by Gifford as "a wretched continuation of the first, printed from MSS. surreptitiously obtained during his life, or ignorantly hurried through the press after his death, and bearing a variety of dates from 1631 to 1641 inclusive." The whole works were reprinted in a single folio volume in 1692, and again in 6 vols. 8vo in 1715. Whalley's edition in 7 vols., with a life, appeared in 1756, but was superseded in 1816 by Gifford's, in 9 vols. (of which the first includes a biographical memoir, and the famous essay on the "Proofs of Ben Jonson's Maligolity, from the Commentators on Shakespeare"). A new edition of Gifford's excellent book was published in 9 vols. in 1875 by Colonel F. Cunningham, as well as a cheap reprint in 3 vols. in 1870. Both contain the "Conversations with Drummond," which were first printed in full by David Laing in the *Shakespeare Society's Publications* (1842), and the *Jonsonus Virgilius*, a collection (unparalleled in number and variety of authors) of poetical tributes published about six months after Jonson's death by his friends and admirers. There is also a single-volume edition, with a very readable memoir, by Barry Cornwall (1838). Recently *Every Man in his Humour* has been edited, with an excellent brief biographical as well as special introduction, to which the present sketch owes some details, by H. B. Wheatley (1877). The criticisms of Jonson are too numerous to mention; but among many deserving to be overlooked should not be included that of Dryden in the preface to *An Evening's Love, or the Mock Astrologer*. (A. W. W.)

JOPLIN, a flourishing city of Jasper county, Missouri, U.S., chiefly engaged in smelting lead and zinc, of which very large quantities are turned out annually. The population in 1880 was 7038.

JOPPA, the Greek Ἰόππη, Ἰόπη, Hebrew JAPHO, and Arabic يَافَا, incorrectly written JAFFA, an ancient seaport of Palestine. It is mentioned in the lists of Thothmes III., and in an inscription of Sennacherib, but in the Bible probably in no writing older than the exile. After the exile it was the harbour of Judea (Ezra iii. 7; Strabo, xvi. 2), and as such appears as an important point in the Maccabee wars, when it was fortified by Simon. Strabo and Josephus speak of it as a haunt of pirates, and on this account it was destroyed by Vespasian in the Jewish war. The small bay south of the town, called *Birket el Kamr* ("Moonpool"), is possibly the old harbour, the present one being formed by a reef having a broad entrance on the north-west and a narrow passage in the middle. The coast being quite straight and unsheltered, the port possesses neither natural

nor artificial advantages. In the 5th, 6th, and 11th centuries bishops of Joppa are noticed, under the metropolitan of Jerusalem. In 1187 Saladin took the town, which was recovered by King Richard in 1191 and retaken by Malek el 'Adil in 1196. In 1799 Napoleon stormed the city, then protected by walls. The fortifications were further increased at a later period by the English. The modern town, the seaport of Jerusalem, with which it is connected by a carriage road in very bad repair, is built on a rounded hillock rising 100 feet above the shore; to the north and south are sandhills; to the east are gardens of oranges, pomegranates, figs, and olives. Sweet water is derived from numerous wells, and palms and bananas occur in these orchards, which cover an area of 3 square miles. The walls of the town still remain standing; the houses are of stone, well built, and the bazaars are good. The town is the seat of a *caim-nacam* or lieutenant-governor. It contains English, French, German, and American consulates, and Latin and Greek monasteries. The trade consists of wheat, sesame, oranges and other fruit, olives, and soap; the population is stated at 8000, the majority being Moslems. A German colony established in 1869 has built two villages, one just outside the town on the north-east, the second (Saróna) at a distance of 2 miles. The colonists number about 300.

Joppa claimed to be the place where Andromeda was exposed. There her chains were shown (Jos., *B. J.*, iii. 9, 13), and thence the skeleton of the monster was brought to Rome by Scaurus (Pliny, ix. 4).

JORDAENS, JACOB (1593-1678), painter, was born at Antwerp in 1593. He studied, like Rubens, under Adam van Noort, and his marriage with his master's daughter in 1616, the year after his admission to the guild of painters, prevented him from visiting Rome. He was forced to content himself with studying such examples of the Italian masters as he found at home; but a far more potent influence was exerted upon his style by Rubens, who employed him sometimes to reproduce small sketches in large. Jordaens is second to Rubens only in their special department of the Flemish school. In both there is the same warmth of colour, truth to nature, mastery of chiaroscuro, and energy of expression; but Jordaens is wanting in dignity of conception, and is inferior in choice of forms, in the character of his heads, and in correctness of drawing. Not seldom he sins against good taste, and in some of his humorous pieces the coarseness is only atoned for by the animation. Of these last he seems in some cases to have painted several replicas. He employed his pencil also in Scriptural, mythological, historical, and allegorical subjects, and is well-known as a portrait painter. He also etched some plates. He died at Antwerp in 1678.

JORDAN (יַרְדֵּן "swift-flowing"), the principal river of Palestine. The historical source of this famous stream is the cave at Baniás (Caesarea Philippi), while the stream from Dan (Tell el Kady) is called Lesser Jordan by Josephus, although the larger of the two springs at the Tell is probably the largest fountain in Syria. A third affluent, which has a better geographical claim to be considered the true Jordan, is the Nahr Hasbany, rising near Hasbeiya on Hermon. The stream from Baniás joins that from Tell el Kady after a course of 5 miles, descending by cascades through thickets and cane brakes, and a little lower down the Nahr Hasbany, after a course of 15 miles, joins the united stream from the other sources. The Baniás source is about 1000 feet above the Mediterranean, and, after passing through the papyrus swamps, the river reaches the Huleh Lake (Merom or Semechonitis), falling 1000 feet in 12 miles. The Huleh is 4 miles long, and thence to the Sea of Galilee is 10½ miles, with a fall of 682 feet. The second lake (see GALILEE) is 12½ miles

long. The fall of the river after leaving it is at first 40 feet per mile, but on entering the plain of Beisán it becomes only 10 or 12 feet per mile, and further south only 4 or 5 feet. The total length from Baniás to the Dead Sea is 104 miles direct, and, as the level of the Dead Sea is 1292·5 below the Mediterranean, the total fall is nearly 2300 feet. Thus the Jordan is only half as long as the Thames, and the Sea of Galilee about equal in length to Windermere. The Ghór or valley of Jordan south of the Sea of Galilee varies in width from 4 to 14 miles east and west; the course of the river is extremely tortuous, and it is hidden by a dense jungle of cane, willow, and tamarisk, growing on the water's edge in the sunken channel called Zór, which is about a mile wide, with steep banks of white marl 50 to 100 feet high. For the last few miles the stream is free from jungle, flowing through a muddy flat. The average width is from 30 to 50 yards, but in February the river "overflows its banks" (Josh. iii. 15) and fills the Zór. The Arabs enumerate some forty fords, mostly passable in summer only. Of these the most important is 'Abárah near Beisán,—probably the Bethabara of Origen, the *Onomastica*, and the common text of John i. 28, where Bethany is the true reading. There is a ferry immediately south of the Sea of Galilee, and another on the road from Shechem to Gilead; the latter is called Ed Dámieh, and has been conjectured to preserve the name of Adam (Josh. iii. 16) or Admah (Gen. x. 19). The ford of Hájlah, east of Jericho, is probably that of Josh. iii., and is the traditional site of Bethabara. The four main affluents of Jordan are the Hieronax (Yarmúk) and the Jabbok on the east, and on the west the Jáhud passing Beisán, and the Fári'a rising not far from Shechem. The supply of these and other perennial streams scarcely, however, balances the loss from evaporation of the river. Salt springs flow to Jordan along the greater part of its course south of Beisán. The valley, formed by a depression in the early Tertiary period, was once filled by a chain of lakes, and raised beaches have been found in various parts of the Ghór.

JORDAN, CAMILLE (1771-1821), French politician, was born in Lyons, January 11, 1771, of a well-to-do mercantile family. He was educated in Lyons, and from an early age was imbued with the royalist principles that distinguished his townsmen. He actively supported by voice, pen, and musket his native town in its gallant resistance to the Convention; and when Lyons fell, in October 1793, Jordan fled. From Switzerland he passed in six months to England, where he formed acquaintances with other French exiles and with prominent British statesmen, and imbibed a lasting admiration for the English constitution. In 1796 he returned to France, and next year he was sent by Lyons as a deputy to the council of five hundred. There his eloquence won him consideration. He earnestly supported what he felt to be true freedom, especially in matters of religious worship, though the energetic appeal on behalf of church bells in his *Rapport sur la liberté des cultes* procured him the sobriquet of Jordan-Cloche. Jordan would have been one of the victims of the *coup d'état* of the 18th Fructidor (September 4, 1797) had he not escaped to Basle. Thence he went to Germany, where he met Goethe, and probably laid the foundation of his affection for German literature, especially as represented by Klopstock. Back again in France by 1800, he boldly published in 1802 his *Vrai Sens du Vote National pour le Consulat à Vie*, in which he exposed the ambitious schemes of the First Consul. He was unmolested, however, and during the first empire lived in literary retirement at Lyons with his wife and family, producing for the Lyons Academy occasional papers on the *Influence réciproque de l'Éloquence sur la Révolution et de la Révolution sur l'Éloquence; Études sur Klopstock, &c.* At the

Restoration in 1814 he again emerged into public life. By Louis XVIII. he was ennobled and named a councillor of state; and from 1816 he sat in the chamber of deputies as representative of Ain. At first he supported the ministry, but when they began to show signs of reaction he separated from them, and gradually came to be at the head of the constitutional opposition. His speeches in the chamber were always eloquent and powerful. Though warned by failing health to resign, Camille Jordan remained at his post till his death, May 19, 1821.

To his pen we owe *Lettre à M. Lamourette*, 1791; *Histoire de la Conversion d'une Dame Parisienne*, 1792; *La Loi et la Religion Vengées*, 1792; *Adresse à ses Commettants sur la Révolution du 4 Septembre* 1797; 1797; *Sur les Troubles de Lyon*, 1818; *La Session de 1817, 1818*. His *Discours* were collected in 1818. The "Fragments Choisis," and translations from the German, were published in *L'Abéille française*.

Besides the various histories of the time, see for further details, vol. x. of the *Revue Encyclopédique*; and a paper on Jordan and Madame de Staël, by Sainte-Beuve, in the *Revue des Deux Mondes* for March 1868.

JORDANES, or JORNANDES, the historian of the Gothic nation, flourished about the middle of the 6th century of the Christian era.<sup>1</sup> All that we certainly know about his life is contained in three sentences of his history of the Goths (cap. 50), from which, among other particulars as to the history of his family, we learn that his grandfather Peria was notary to Candac, the chief of a confederation of Alans and other tribes settled during the latter half of the 5th century on the south of the Danube in the provinces which are now Bulgaria and the Dobrukscha. Jordanes himself was a notary until he renounced his worldly calling and took the vows of a monk. This, according to the manner of speaking of that day, is the meaning of his words "ante conversionem meam," though it is quite possible that he may at the same time have renounced the Arian creed of his forefathers, which it is clear that he no longer held when he wrote his Gothic history.

It is probable that the latter part at any rate of the life of Jordanes was spent in Italy. In some early editions of his works he is called "episcopus Ravennas," but the ample details which we possess as to the bishops of Ravenna make it certain that he never occupied that see. He may have been a bishop, but the best authority for that assertion (according to the statement in Muratori's *Rerum Italicarum Scriptores*, i. 189) is only Sigebert of Gembloux, who lived five centuries later. Traces have been discovered of a certain Jordanes, bishop of Crotona, in 551, and a "Jordanes defensor ecclesiæ nostræ" is mentioned in a letter of Pope Pelagius in 556.

We pass from the extremely shadowy personality of Jordanes to the more interesting question of his works.

1. The *De Regnorum et Temporum Successione*, or, as he himself called it, *Breviatio Chronicorum*, was probably composed in 550 or 551. It is a short and dry sketch of the history of the world from the creation, founded on the chronicles of Eusebius and Jerome. The book has no value, literary or historical, till the historian comes near to his own times; and here, from about 450 to 550, the *De Regnorum Successione* is sometimes a really important authority, owing to the extreme scarcity of other information as to this epoch.<sup>2</sup>

2. The other work of Jordanes, *De Rebus Geticis*, as it is commonly called, was styled by himself, *De Origine Actuque Geticæ Gentis*, and was probably written in the year 552. He informs us that while he was engaged upon

<sup>1</sup> The evidence of MSS. is overwhelming against the form *Jornandes* adopted in the two earliest editions. Strictly speaking, the MSS. favour *Jordanis*; but this seems to be only an incorrect spelling of *Jordanes*.

<sup>2</sup> The terms of the dedication of this book to a certain *Vigilius* make it impossible that the pope of that name is meant.



the *Bioculto* a friend named Castalius invited him to compress into one small treatise the twelve books—now lost—of the senator Cassiodorus, or Cassiodorus, on *The Origin and Actions of the Goths*. Jordanes professes to have had the work of Cassiodorus in his hands for but three days, and to reproduce the sense, not the words; but his book, short as it is, evidently contains long verbatim extracts from the earlier author, and it may be suspected that the story of the “tridua lectio” and the apology “quamvis verba non recolo,” possibly even the friendly invitation of Castalius, are mere blinds to cover his own entire want of originality. This suspicion is strengthened by the fact (discovered by Von Sybel) that even the very preface to his book is taken almost word for word from Rufinus’s translation of Origen’s commentary on the epistle to the Romans. There is no doubt, even on Jordanes’s own statements, that his work is based upon that of Cassiodorus, and that any historical worth which it possesses is due to that fact. Cassiodorus was one of the very few men who, Roman by birth and sympathies, could yet appreciate the greatness of the barbarians by whom the empire was overthrown. The chief adviser of Theodoric, the East Gothic king in Italy, he accepted with ardour that monarch’s great scheme, if indeed he did not himself originally suggest it to his master, of welding Roman and Goth together into one harmonious state, which should preserve the social refinement and the intellectual culture of the Latin-speaking races, without losing the hardy virtues of their Teutonic conquerors. To this aim everything in the political life of Cassiodorus was subservient, and this aim he evidently kept before him in his Gothic history. He translated into his somewhat stilted prose the sagas which were still sung by the Gothic warriors round their camp-fires,<sup>1</sup> telling of the past migrations and dangers of their people. He reduced into form the pedigree which traced the descent of the Amals, Theodoric’s kingly house, from gods and heroes. To all this he worked on such lines as a modern historical inquirer would have him work on. Unfortunately, he also accepted the current theory of his age which identified the Goths with the Scythians, whose country Darius Hystaspis invaded, and with the Getæ of Dacia whom Trajan conquered. This double identification enabled him to bring the favoured race in line with the people of classical antiquity, to interweave with their history stories about Hercules and the Amazons, to make them invade Egypt, to claim for them a share in the wisdom of the semi-mythical Scythian philosopher Zamolxis. He was thus able with some show of plausibility to represent the Goths as “wiser than all the other barbarians and almost like the Greeks” (Jord., *De Reb. Get.*, cap. v.), and to send a son of the Gothic king Telephus to fight at the siege of Troy, on the right side, in rank with the ancestors of the Romans. All this we can now perceive to have no relation to history, but at the time it may have made the subjugation of the Roman less bitter to feel that he was not after all bowing down before a race of barbarian upstarts, but that his Amal sovereign was as firmly rooted in classical antiquity as any Julius or Claudius who ever wore the purple. A grateful king of the Goths, the young Athalaric, truly said of Cassiodorus, “Origenem Gothicam historiam fecit esse Romanam, colligens quasi in unam coronam germen florum, quod per librorum campos passim fuerat ante dispersum” (Cassiod., *Vita*, ix. 25).

Cassiodorus completed his history of the Goths probably about the year 534. In the eighteen years which elapsed between that date and the composition of the *De Rebus*

*Geticis* of Jordanes, great events, and most disastrous for the Romano-Gothic monarchy of Theodoric, had transpired. It was no longer possible to write as if the whole civilization of the Western world would sit down contentedly under the shadow of East Gothic dominion and Amal sovereignty. And moreover, the instincts of Jordanes, as churchman and Catholic, predisposed him to flatter the sacred majesty of Justinian, by whose victorious arms the overthrow of the barbarian kingdom in Italy had been effected. Hence we perceive two currents of tendency in the *De Rebus Geticis*. On the one hand, as a Goth himself and as a transcriber of the philo-Goth Cassiodorus, he magnifies the race of Alaric and Theodoric, and claims for them their full share, perhaps more than their full share, of glory in the past. On the other hand, he speaks of the great anti-Teuton emperor Justinian, and of his reversal of the German conquests of the 5th century, in language which would certainly have grated on the ears of Totila and his heroes. Gelimer the Vandal is “overtaken by the revenge of Justinian,” and Africa “long subject to the Vandal yoke is recalled into the liberty of the Roman kingdom.” When Ravenna is taken, and Vitigis carried into captivity, Jordanes almost exults in the fact that “the nobility of the Amals and the illustrious offspring of so many mighty men have surrendered to a yet more illustrious prince and a yet mightier general, whose fame shall not grow dim through all the centuries.”

This laudation, both of the Goths and of their Byzantine conquerors may perhaps help us to understand the political motive with which the *De Rebus Geticis* was written. In the year 551 Germannus, nephew of Justinian, accompanied by his bride, Matasuntha, granddaughter of Theodoric, set forth to reconquer Italy for the empire. His early death (in 552) prevented any schemes for a revived Romano-Gothic kingdom which may have been based on his personality. His widow, however, bore a posthumous child, also named Germanus, of whom Jordanes speaks (cap. 60) as “blending the blood of the Anicii and the Amals, and furnishing a hope under the divine blessing of one day uniting their glories.” This younger Germanus did nothing in after life to realize these anticipations; but the somewhat pointed way in which his name and his mother’s name are mentioned by Jordanes lends some probability to the idea that the *De Rebus Geticis* was put forth in the interests of a third party, Italian rather than Gothic or Byzantine, and possibly headed by Pope Vigilius, who may have wished to advocate the claims of this infant to an independent sovereignty in Italy.

The *De Rebus Geticis* falls naturally into four parts. The first (chaps. i–xiii.) commences with a geographical description of the three quarters of the world, and in more detail of Britain and “Scanzia” (Sweden), from which the Goths under their king Berig migrated to the southern coast of the Baltic. Their migration across what has since been called Lithuania, to the shores of the Euxine, and their differentiation into Visigoths and Ostrogoths, follow. Chaps. v.–xiii. contain an account of the intrusive Geta-Scythian element before alluded to.

The second section (chaps. xiv.–xxiv.) returns to the true history of the Gothic nation, sets forth the genealogy of the Amal kings, and describes the inroads of the Goths into the Roman empire in the 3d century, with the foundation and the overthrow of the great but somewhat shadowy kingdom of Hermanric. The author here probably rests to some extent on Orosius, Ammianus, and other Latin historians, but draws partially at least from native sources.

The third section (chaps. xxv.–xlvii.) traces the history of the West Goths from the Hunnish invasion to the downfall of the Gothic kingdom in Gaul under Alaric II. (376 to 507 A.D.). The best part of this section, and indeed of the whole book, is the seven chapters devoted to Attila’s invasion of Gaul and the battle of the Mauriac plains. Here we have in all probability a verbatim extract from Cassiodorus, who has interwoven with his narrative large portions of the Gothic sagas. The celebrated expression “certaminis gaudia” assuredly came at first neither from the suave minister Cassiodorus nor from the small-souled

<sup>1</sup> “Quemadmodum et in prisca eorum carminibus pæna historico ritu in commune recitata.” *De Reb. Get.*, ix.

notary Jordanes, but is the translation of some thought which first found utterance through the lips of a Gothic minstrel.

The fourth section (chaps. xlviii.—lx.) traces the history of the East Goths from the same Hunnish invasion to the first overthrow of the Gothic monarchy in Italy (376—539). In this fourth section are inserted, somewhat out of their proper place, some valuable details as to the *Colti Minores*, "an immense people dwelling in the region of Nicopolis, with their high priest and primate Vulfilas, who is said also to have taught their letters." The book closes with the allusion to Germanus and the panegyric on Justinian as the conqueror of the Goths referred to above.

As to the style and literary character of Jordanes, every author who has used him speaks in terms of severe censure. When he is left to himself and not merely transcribing, he is sometimes scarcely grammatical. There are awkward gaps in his narrative and statements inconsistent with each other. He quotes, as if he were familiarly acquainted with their writings, about twenty Greek and Roman writers, of whom it is almost certain that he had not read more than three or four. At the same time he does not quote the chronicler Marcellinus, from whom he has copied verbatim the history of the deposition of Augustulus. All these faults make him a peculiarly unsatisfactory authority to depend upon where we cannot check his statements by those of other authors. It may, however, be pleaded in extenuation that he is professionally a transcriber, and, if his story be correct, a transcriber under peculiarly unfavourable circumstances. He has also himself suffered much from the inaccuracy of copyists. But nothing has really been more unfortunate for the reputation of Jordanes as a writer than the extreme preciseness of the information which he has preserved to us. The Teutonic tribes whose dim original he records have in the course of centuries attained to world-wide dominion. The battle in the Mauriac plains, of which he is really the sole historian, is now seen to have had at least as important bearings on the destinies of the world as Marathon or Waterloo. And thus the hasty pamphlet of a half-educated Gothic monk has been forced into prominence, almost into rivalry with the finished productions of the great writers of classical antiquity. No wonder that it stands the comparison badly; but with all its faults the *De Rebus Geticis* of Jordanes will probably ever retain its place side by side with the *De Moribus Germanorum* of Tacitus, as a chief source of information respecting the history, institutions, and modes of thought of our Teutonic forefathers.

*Manuscripts.*—The chief MSS. of the *De Rebus Geticis* are one at Heidelberg of the 8th century and one at the Vatican of the 10th, one at Milan, two of the 11th and 12th centuries at Vienna, and one of the 12th century at Munich. Unfortunately the Heidelberg and Vienna MSS. perished in the fire at Prof. Mommsen's house, but not before he had accurately collated them.

*Editions.*—The *editio princeps* of the *De Rebus Geticis* was published by Peutingger, at Augs-burg, 1515. Two of the best known editions are those in Muratori's *Rerum Italicarum Scriptores*, vol. 4. (which gives Grotius's text collated by J. A. Saxe with the Ambrosian MS., and which also contains the *De Legatione Successione*), and in Grotius's *Historia Gothorum, Vandalarum, et Longobardorum*, Amsterdam, 1655. A new edition is expected from Professor Mommsen.

*Literature.*—The foregoing article is chiefly founded on Von Sybel's essay, *De fontibus Jordanis* (1828), Schirren's *De ratione quæ inter Jordanem et Cassiodorum intercedat Commentatio*, Dorpat, 1858; Koyke's *Die Anfänge des Könythums bei den Gothen*, Berlin, 1859; Dahn's *Die Könige der Germanen*, vol. II., Munich, 1861; Loren's *Geschichte der Christlich-Lateinischen Literatur*, Leipzig, 1874; and Waitz's *Deutschland's Geschichtsquellen im Mittelalter*, Berlin, 1877.

JORTIN, JOHN (1698—1770), a writer on theological subjects, was the son of a Protestant refugee from Brittany, and was born in London 23d October 1698. In his tenth year he entered Charterhouse school, and in 1715 he became a pensioner of Jesus College, Cambridge, where his reputation as a Greek scholar led the classical tutor of his college to select him to translate certain passages from Eustathius for the use of Pope in his translation of Homer. He graduated B.A. in 1719 and M.A. in 1722. In the latter year he published a small volume of Latin verse entitled *Lusus Poeticæ*. Having received priest's orders in 1724, he was in 1726 presented by his college to the vicarage of Swavesey in Cambridgeshire, an appointment which he resigned in 1730 to become preacher of a chapel in New Street, London. In 1731, along with some friends, he began a publication entitled *Miscellaneous Observations on Authors Ancient and Modern*, which appeared at intervals during two years. In 1737 he was presented to the vicarage of Eastwell in Kent, and in 1751 he became rector of St Dunstan's-in-the-East. Shortly after becoming chaplain to the bishop of London in 1762, he was appointed to a prebendal stall of St Paul's, and to the vicarage of Kensington, and in 1764 he was made archdeacon of London. He died at Kensington, September 5, 1770.

The principal works of Jortin are *Discussions Concerning the Truth of the Christian Religion*, 1746; *Remarks on Ecclesiastical History*, 1751; *Life of Erasmus*, 2 vols., 1750, 1760, founded on the life by Le Clerc, but containing a large amount of new matter; and *Tracts Philological, Critical, and Miscellaneous*, 1790. All his works display great learning and some acuteness both of research and criticism, but though written in a lively style they do not bear that stamp of originality which confers permanent interest.

See Disney's *Life of Jortin*, 1792; and the "Account of his Life and Writings" prefixed to an edition of the *Remarks on Ecclesiastical History* published in 1816.

JOSEPH, the most powerful tribe of northern Israel, occupied the centre of the land from the plain of Esdraelon to the mountain country of Benjamin and threw out colonies to Bashan and northern Gilead (see ISRAEL, p. 397). Unlike the other sons of Jacob, Joseph is usually reckoned as two tribes, the younger but more numerous tribe of Ephraim, to which Joshua belonged, having the pre-eminence over the other—Manasseh. In Ephraim lay the city of Shechem with the tomb of the tribal ancestor, and the great sanctuary of Shiloh where the ark stood till the battle of Ebenezer destroyed for a time the hegemony of Joseph, till after the division of the kingdoms he again became "the crowned one of his brethren" (Gen. xlix. 26; Deut. xxxiii. 16). Along with the small tribe of Benjamin, which as its name indicates lay immediately to the south, the house of Joseph constituted the group known as sons of Rachel (the ewe), which with the sons of Leah (the antelope) claimed a higher ancestry than the other Hebrews (the sons of Jacob's concubines).

The name of Joseph, the tribal ancestor, is explained in Gen. xxx. 24, in accordance with the usual spelling יוסף, as meaning "he addeth" (hence in Ps. lxxxi. 6 [E. V. 5] the resolved form יוסיף). Another hand in Gen. xxx. 23 takes the word from יוסף, "he taketh away." The history of Joseph, Gen. xxxvii.—l., belongs almost wholly to the earliest strata of the Pentateuch, the narratives of the Jehovist and non-Levitical Elohist, the larger share belonging to the latter author, himself probably a member of the house of Joseph.

The history of Joseph in Egypt displays remarkable familiarity with the circumstances and usages of that country (see *Egypt, Aegypten und die Bücher Moses*, Leipzig, 1868), but presents no data which enable us with certainty to combine the Biblical record with known events in Egyptian history. It is still disputed whether Joseph came to Egypt before, under, or after the Hyksos. The first opinion, which is supported by Bunsen and others, involves a considerable reduction in the period of five hundred and eleven years assigned to the Hyksos by Manetho, while on the other hand a date subsequent to the expulsion of the Semitic invaders (e.g., under Sethi I. as Lepsius suggests) demands a great shortening of the four hundred and thirty years of Exod. xii. 40, if the Pharaoh of the oppression was Sethi's successor, Rameses II. That the Israelites entered Egypt under the Hyksos is already mentioned as the current opinion of his time by George Syncellus, and is followed by many moderns, who observe that the promotion of a Hebrew appears most natural under a Semitic dynasty. See EGYPT, vol. vii. p. 741, and for Brugsch's supposed monumental reference to the seven years' famine, *ibid.*, p. 736. The Egyptian tale of "The Two Brothers," which presents a remarkable parallel to the story of Joseph, is given in *Records of the Past*, vol. ii.

The name of Joseph was common among the later Jews; of the Biblical personages by whom it was borne the best known are Joseph the husband of Mary, Joseph of Arimathea, Joseph Barnabas, and Joseph Barsabas.

JOSEPH, the husband of Mary the mother of Jesus, was a descendant of the house of David, and followed the trade of a carpenter in the village of Nazareth. Of his personal history practically nothing is recorded in Scripture. It is probable that he had died before the beginning of the public ministry of Christ, at least this seems a fair inference from the fact that no mention of him is made in passages relating to this period where the mother and brethren of Jesus are introduced. From John xix. 26 it is clear



that he was not alive at the time of the crucifixion... Ecclesiastical tradition, probably influenced by dogmatic prepossessions, has it that when married to Mary he was already eighty years of age and the father of four sons and two daughters, and that his first wife was named Salome, a connexion of the family of John the Baptist. In the Roman Catholic Church the 19th of March has since 1642 been a feast of obligation in his honour. His cultus is on the increase.

JOSEPH I. (1678-1711), Holy Roman emperor, was born in Vienna July 26, 1678. In 1689 he received the crown of Hungary, in 1690 that of the king of the Romans; and in 1705 he succeeded his father, Leopold I., as Holy Roman emperor. The war of the Spanish succession was raging at the time of his accession to the imperial throne; and it continued during the whole of his reign. Thanks to the genius of Marlborough and Eugene, Joseph was able to maintain in this struggle the greatest military traditions of the empire; and, the French troops having been gradually driven out of Italy and the Netherlands, Louis XIV. was compelled to ask several times for the conclusion of peace. The pope also gave evidence of the emperor's power by recognizing his brother Charles as king of Spain. In 1706 the electors of Cologne and Bavaria, and in 1708 the duke of Mantua, were put to the ban of the empire for supporting the enemy of their sovereign; and the emperor not only seized Bavaria, but began to partition it. He was successful, too, in Hungary, where he put down a rebellion that had broken out in the time of his father. On the other hand, he found it prudent to manifest a conciliatory spirit in his relations to Charles XII. of Sweden, who in 1706 made his way from Poland to Saxony through Silesia. In 1707 the emperor concluded treaties with him, granting religious liberty to the Silesian Protestants, and restoring to them upwards of two hundred churches which had been seized by the Jesuits. These concessions were not unwillingly made by the emperor, who, although a sincere Catholic, was of a tolerant disposition. He showed his respect for the constitution and dignity of the empire by supporting the diet in the free exercise of its functions, by promoting the activity of the imperial chamber, and by restoring Donauwörth, which had been mediatised by Bavaria, to the position of a free imperial city. He died of small-pox on the 17th of April 1711.

JOSEPH II. (1741-1790), Holy Roman emperor, born in Vienna March 13, 1741, was the son of the emperor Francis I. and Maria Theresa. He was made king of the Romans in 1764; and in 1765 he succeeded his father as Holy Roman emperor. Maria Theresa declared him co-regent of her hereditary states, but almost all real power she retained in her own hands. He received full authority only in the regulation of the military system, into which he introduced many changes, following in the main the example of Frederick the Great. Chiefly by his advice Maria Theresa was induced to associate herself with Russia and Prussia in the partition of Poland; and in 1777 he persuaded her to force Turkey to surrender Bukovina. When the younger branch of the house of Wittelsbach died out in 1777, Joseph claimed a large part of its territory; but Frederick the Great resisted his pretensions, and in 1779, after a nominal war, the emperor accepted the treaty of Teschen, by which he obtained only a small concession. Before this time he had sought to prepare himself for his future duties by extensive travels in his own states and in foreign countries; and everywhere he had made a favourable impression by his genial courtesy. In 1769 he had visited Frederick the Great, for whom he had at that time a warm admiration; and in the following year Frederick returned the visit, going back to Prussia with the conviction that it would be necessary to keep his eye on that

young man." On the death of Maria Theresa in 1780 Joseph became sole ruler of the Austrian states. He was penetrated by the characteristic ideas of the 18th century as to the duties of an absolute monarch, and began at once to give effect to them in a fearless and almost revolutionary spirit. His first step was to combine the various nationalities subject to him into a single state with thirteen administrative districts. He refused to be crowned king of Hungary, and would not summon the Hungarian diet, insisting that the country should be governed as a province, and causing German to be used as the official language. Among other reforms he proclaimed the abolition of serfdom, substituted various punishments for the capital penalty, established common tribunals, and issued new codes based on the principle that all citizens are equal before the law. He transferred the censorship of books from the clergy to laymen of liberal sympathies, and granted complete freedom to journalism. He instituted public libraries and observatories, founded a medical college in Vienna a university in Lemberg, and schools for the middle classes in various parts of the monarchy, and encouraged art by offering prizes in connexion with the academy of the plastic arts. Industry and trade he fostered by destroying many monopolies, by aiding in the establishment of new manufactures, by raising Fiume to the position of a free harbour, and by opening the Danube to his subjects from its source to the Black Sea. His ecclesiastical policy was of so bold a character that Pope Pius VI. went to Vienna for the purpose of expostulating with him, but found that the emperor was beyond the range of his influence. The hierarchy was forbidden to correspond with the Roman see without express permission, and papal bulls were subjected to the *Placetum Regium*. In 1781 he issued an edict of toleration, granting freedom of worship to all Protestants and to members of the Greek Church; and between 1782 and 1790 about seven hundred monasteries were closed, the members of religious orders being reduced from 63,000 to 27,000. All these changes were well-meant, but the emperor, in the ardour of his philanthropy, shot too far ahead of the prevailing sentiment of his people. Moreover, his good intentions were often rendered fruitless by unskilful or unsympathetic subordinates. In nearly every part of the monarchy discontent soon manifested itself, and some of the inhabitants of Tyrol broke into open rebellion. The Hungarians bitterly resented the suppression of their ancient privileges, and in 1787 the emperor's new institutions led in several districts to a furious conflict between the peasantry and the nobles. The estates of the Austrian Netherlands persistently opposed the execution of his schemes, the clergy being especially active in stirring up popular indignation; and when, in 1789, he altogether destroyed their constitution, they rebelled and were able for some months to maintain their independence. In Hungary there was so dangerous an agitation that in January 1790 Joseph had to undo almost everything he had attempted to accomplish in that country during the previous nine years; he succeeded only in maintaining the decrees by which he had abolished serfdom and established toleration. Thus his last days were rendered miserable by the conviction that his career had been a failure. He was not more fortunate in his foreign policy than in his home government. Early in his reign, indeed, he gained some advantages over the Dutch, who were obliged to abandon their fortresses on the frontier of the Austrian Netherlands. And when they refused to open the Scheldt, they had to compensate him (in 1785) by a payment of ten million florins. In the same year he renewed his claims on Bavarian territory, but was thwarted by Frederick the Great, who formed his famous league of princes for the

protection of the German states against Austrian ambition. After the conclusion of the treaty of Teschen, Joseph made it one of the chief objects of his foreign policy to form an enduring alliance between Austria and Russia; and in 1788, in association with Catherine II., he declared war against Turkey. He did not live to see the end of this war, which brought him little honour. On the 20th of February 1790 he died, deeply disappointed that he had been able to achieve so few of the objects with which he had begun his reign. He was twice married, first to the Princess Marié Louise of Parma, afterwards to the Princess Marié Josephé of Bavaria. His only daughter died in childhood, so that he was succeeded by his brother Leopold II. Notwithstanding the defeat of so many of his plans, his reign marked an epoch in the history of Austria; and the interest still excited by his name was shown by the enthusiasm with which the people of Austria celebrated in 1880 the centenary of his accession as sole ruler. On the pedestal of his statue in Vienna, erected by Francis I. in 1807, are these words:—"Josepho secundo, qui saluti publicæ vixit non diu, sed totus." (J. st.)

JOSEPHINE (1763-1814), empress of the French, was born at Trois-Îlets, Martinique, on the 23d of June 1763; and was the eldest of three daughters born to Joseph Tascher de la Pagerie, lieutenant in the artillery, and his wife Rose-Claire Des Vergers de Sannois. She was educated at a local convent, from which she was withdrawn in her fifteenth year, knowing how to dance, sing, and embroider, but little else. An aunt, resident in France, was godmother to the second son of the Marquis de Beauharnais, once the governor of Martinique; and she suggested a marriage between her god-child and niece. After much negotiation between the families, in which the second and youngest daughters were both preferred to Joséphine, her father carried her to Havre in 1779, she being already described to her aunt and the Beauharnais as possessing a fine complexion, beautiful arms and eyes, and with a sweet voice and a remarkable taste for music—altogether "très-avancée et formée pour son âge." On the 13th of December she was married to the Vicomte Alexandre Beauharnais at Noisy-le-Grand. Her son Eugène was born at a time when her relations with her husband were embittered by jealousy; and after the birth of her daughter Hortense-Eugénie he sought a separation, but, though he carried his request to the parliament, his petition was dismissed. Joséphine went back to her parents in June 1783, and was with them when the Revolution broke out. At the request of the vicomte she returned, however, to France in 1790. He was then a member of the constituent assembly, receiving at his house the chiefs of the constitutional party; and Joséphine was admired by all of them for her dignity, simplicity, and sweetness. As the crisis became more acute, her husband thought it prudent to withdraw to Ferté-Beauharnais, in Sologne, where he left his family when he went to command the army of the Rhine. After his execution by order of the Convention, Joséphine was reduced to great straits, and not till the end of 1795 did regular remittances from Martinique begin again. She was living in the Rue Chauteraine, Paris, in a house of her own, when she paid her first visit to Napoleon, to thank him for restoring the sword of her husband. She was in the full flower of her womanhood; Napoleon was at once drawn to her; on the 9th of March 1796 they were married. In twelve days he left her to take command of the army in Italy; but in June, at his earnest request, she joined him at Milan and went on to Brescia. After the peace of Léoben they lived at Montebello near Milan, and Joséphine was for some time the queen of a court frequented by great officers and diplomats. Having visited Rome, she went back to Paris, and

at her house assembled the most distinguished men of the day. During the expedition to Egypt she moved between the capital and Plombières; but she had her first quarrel with Napoleon on his return, because, by an oversight, she omitted meeting him. Social duties of the most brilliant and difficult sort began to accumulate round her during the consulate. At the palace of the Luxembourg and the Tuileries her drawing-room was again the centre of attraction in Paris; her receptions were ruled by the old traditions of regal ceremony, and there was an endless round of fêtes, entertainments, and plays. Her beauty and amiability won upon everybody; and when she wanted rest she retired to Malmaison, a country seat she had bought, and amused herself with a variety of light studies in botany and natural history. Rumours now began to reach her that Napoleon, in despair of offspring, meant to sue for a divorce. She had long known that his relatives were trying to undermine her position; and even when she knelt beside him at Notre Dame, and received the triple unction at the ceremony which crowned her empress, she knew it to be a concession wrung from him. After the coronation he gave her less and less of his society. It was not, however, until the winter of 1809 that he deliberately proposed to dissolve the connexion. He divorced her with much show of tenderness, and she retired to Malmaison with an annual grant of two million francs for her establishment. Her affection for Napoleon, and her anxiety for his success, remained strong to the hour of her death, on May 24, 1814; and but for his inordinate ambition he would never have sought to live apart from her. She often provoked him by a certain mild duplicity in her character; she was extravagant and superstitious; yet, to fulfil the high destiny to which she was called, she brought much gentleness, courage, and sweetness, qualities which carried her through her reverses with admirable dignity.

See Aubenas, *Histoire de l'Impératrice Joséphine*, 1858-59.

JOSEPHUS, FLAVIUS, the well-known historian of the Jews, was born at Jerusalem in the first year of the reign of Caligula, the precise date is uncertain, but it lies somewhere between September 13, 37, and March 16, 38 A.D. His early advantages were very considerable. His father Matthias belonged to one of the best priestly families in the city, while on his mother's side he was descended from Jonathan, the first Hasmonean high priest. The position of his parents procured for him a careful education, and such was his progress (at least if his own account of himself is to be believed) that at the age of fourteen he was often consulted by the high priests and prominent citizens on difficult points of Jewish law. At sixteen he resolved upon an experimental study of the doctrines of the three leading sects, or schools of philosophy, as he prefers to consider them; and, hearing that Bannus, a celebrated Essene, was living in the wilderness with the rigorous asceticism of a hermit, he joined him and remained under his teaching for three years. Returning to Jerusalem at the age of nineteen, he definitively joined the Pharisees, to whom he continued ever after to adhere. In 64 A.D. (æt. 26) he undertook a journey to Rome to intercede for some priests of his acquaintance whom Felix the procurator had sent thither as prisoners to be tried on some trifling charges. Landing safely at Puteoli after a narrow escape from death by shipwreck in the Adriatic, he gained the friendship of Alityrus, a famous Jewish mime of the day, and a favourite of Nero; by this means he not only obtained the pardon of his friends, but was also loaded with many valuable gifts by the empress Poppæa. On teaching Judæa again he found his countrymen bent at all hazards on throwing off the Roman yoke; knowing well the resources of Rome, and the hopelessness of successfully



resisting her power, he (according to his own account, which is not in itself very improbable) did his best to dissuade them from any such attempt. Ultimately, however, after the victory over Cestius Gallus, he yielded to the force of the current, and joined the revolutionary movement in 66, being entrusted with the task of governing and defending the province of Galilee, an appointment for which he was indebted to family influence rather than to any known military skill. Proceeding at once to his province, he set about the execution of plans of political reorganization, at the same time fortifying various military positions, and getting together and drilling an army of 100,000 men. Very soon, however, he had to encounter the opposition of a strong party, headed by John of Giscala, and it was with difficulty that he averted an insurrection at Taricheæ, and afterwards saved himself by flight from Tiberias. His enemies actually at one time had succeeded in obtaining his recall; but the act was afterwards cancelled, through the powerful influence he still possessed in Jerusalem. Meanwhile Vespasian had assembled a large force at Antioch, and in the spring of 67 threw a garrison into Sepphoris, whence (the troops of Josephus not waiting his attack) he made himself master of all Lower Galilee. Josephus himself falling back on Tiberias sent for large reinforcements from Jerusalem; these not being forthcoming, he in May shut himself up in Jotapata, the defence of which he maintained against all the efforts of the Romans for forty-seven days. At the end of that period the place was taken by storm, and such of the garrison as had not perished in the siege were put to death by the conquerors. The governor himself demanded to be led into the presence of the general, and, with great adroitness assuming the rôle of a prophet, told his captor that he was no chance prisoner, but had been commissioned by heaven to predict that he was shortly to become the sole head of the Roman empire. The plan was so far successful that the prisoner's life was spared; Vespasian, however, kept him in close confinement for two years, but on attaining the purple liberated him. Thenceforward Josephus assumed the family name of his patron (Flavius). After having accompanied Vespasian to Alexandria, he attended Titus to Palestine, and remained in his train until the close of the war. At the risk of his life he was more than once sent to urge his countrymen to yield, but without success. After the fall of the city he accompanied Titus to Rome, where Vespasian assigned him a residence in what had once been his own house, conferred on him the citizenship, and gave him a yearly pension, to which was afterwards added an estate in Judæa. Under Titus and Domitian he was confirmed in all his privileges, devoting the peaceful remainder of his days to those literary labours with which his name is now so exclusively associated. The precise date of his death is unknown; he must have survived the first century, for his autobiography mentions the death of Agrippa II., which occurred in 100 A.D.

His extant works are the following. (1) *History of the Jewish War* (*Ἱστορία τοῦ Ἰουδαϊκοῦ πολέμου*), in seven books. It was originally written in Aramaic for the benefit of the Jews dwelling beyond the Euphrates, but was afterwards translated by its author into the Greek, which alone we now possess. Books i.-ii. sketch the whole course of Jewish history from the period of the Maccabees to the beginning of the war. The remainder of the work gives a minute account of the entire struggle from 65 to its complete suppression in 73 A.D. On its completion the whole work was submitted to Vespasian, Titus, and Agrippa II., who, the author tells us, bore witness to its accuracy. Of its general trustworthiness there can be no reasonable doubt: Josephus had a considerable personal share in much of what he records; and on other points he seems to have had access to direct documentary evidence. The speeches which he reports are not of course to be construed by stricter rules than those which occur in the works of Livy or Thucydides; and apart from this some allowance also must be made for a tendency to exaggeration or false accentuation wherever his

vanity judged such a thing to be desirable. (2) *Antiquities of the Jews* (*Ἰουδαϊκὴ ἀρχαιολογία*), in twenty books, a comprehensive Jewish history from the earliest times down to the outbreak of the war in 66. It was completed in the thirteenth year of Domitian (93-94 A.D.), long after the author's own interest in it had exhausted itself. For the first eleven books, covered by the Scriptural narrative, his exclusive authority seems to have been the Bible itself, especially the LXX. translation. He frequently, however, omits or modifies points which seemed to him likely to give offence; sometimes he supplements with current traditions or uses the works of his predecessors in the same field, Demetrius and Artapanus; and occasionally he gives excerpts from profane writers. The remaining nine books are very unequal in merit. The period between Alexander the Great and the Maccabees is almost an entire blank. For the Maccabean wars (xii. 5-xiii. 7) he had 1 Macc. to draw upon; for the reigns of the later Hasmonæans (xiii. 8-xiv.) he is dependent upon the historians Strabo and Nicolaus of Damascus. The last-named writer is also his chief authority for the portion of his narrative which relates to the times of Herod (xiv.-xvii.), but he appears to have had access to some original memoirs. The last three books (xviii.-xx.), relating to the times immediately subsequent to the death of Herod, are more meagre than might have been expected, and by the carelessness of their manner bear witness to the author's confessed fatigue. Book xviii. (chap. iii. sec. 3) contains a remarkable passage relating to Jesus Christ, which is twice cited by Eusebius as genuine (*Il. E.*, i. 11; *Dem. Ev.*, iii. 3, 105-6), and which is met with in all the extant MSS. It is, however, unanimously believed to be, in its present form at least, spurious, and those who contend even for its partial genuineness are decidedly in the minority. (3) *Autobiography*, in seventy-six chapters, all of which, however, except the first six and the last two relate to the occurrences in Galilee in which he had so large a share during 66-67 A.D., written in defence of himself against the representations of a certain Justus of Tiberias. His narrative of these events cannot be regarded as an impartial one, and that in some points at least he was led to sacrifice truth to self-interest can be conclusively shown by comparison even with his own earlier work, the *History of the Jewish War*. The *Vita*, which contains the allusion to the death of Agrippa II., must have been written at a date subsequent to 100 A.D. (4) *Against Apion*, in two books. This is the usual but somewhat misleading title of a general apology for Judaism, in which the polemic against Apion occupies only a subordinate place. Porphyry cites it by the title *Πρὸς τοὺς Ἑλληνας*, while Origen and Eusebius call it *Περὶ τῆς τῶν Ἰουδαίων ἀρχαίτητος*. The date of its composition is later than that of the *Antiquities*. Other works referred to by Josephus, but no longer extant, are (1) *Περὶ τῶν νόμων* (*Ant.*, iii. 5, 6), which is most probably to be identified with the composition elsewhere cited by the title *Περὶ ἑθῶν καὶ αἰτιῶν* (*Ant.*, iv. 8, 4); and (2) *Περὶ θεοῦ καὶ τῆς οὐσίας αὐτοῦ*, in four books (*Ant.*, xx. 11, 2). The so-called fourth book of Maccabees has sometimes, but erroneously, been assigned to Josephus. One or two philosophical treatises are also attributed to him by Photius; they are, however, obviously of Christian origin, and most probably are from the pen of Hippolytus of Ostia.

The Greek text of the works of Josephus was first printed at Basel in 1544. The earliest critical editions were those of Hudson (Oxford, 1720) and Havercamp (Utrecht, 1726); the text of the latter is that given by Oberthur (3 vols. Svo., Leipsic, 1782-85) and by Richter (Leipsic, 1826-27). Further emendations occur in the edition of Dindorf (Paris, 1845-47), which is the basis of Bekker's edition (Leipsic, 1855-56). A new edition based upon fresh collation of MSS. is promised by Niese. The treatise *Against Apion* was separately edited, with notes, by J. G. Müller, 1877. The translations of Josephus have been very numerous, and his writings are also the basis of the *Bellum Judaicum* which bears the name of Egesippus (corrupted from Josippus), and of the mediæval Hebrew history ascribed to Josippon ben Gorion. For the whole subject, biographical and literary, see Schürer's *Jüdische Zeitgeschichte* (1874) and his exhaustive article "Josephus" in Herzog-Plitt's *Real-Encycl.*, vol. vii. (1880).

JOSHUA (יְהוֹשֻׁעַ), or in later Heb. *יְהוֹשֻׁעַ*, Gr. Ἰησοῦς, whence "Jesus" in the A. V. of Heb. iv. 8; another form of the name is Hoshea, Num. xiii. 8, 16), first the lieutenant and afterwards the successor of Moses, was the son of Nun, of the tribe of Ephraim, and left Egypt, along with the rest of the children of Israel, at the time of the exodus. In the Pentateuch he is first mentioned as being the victorious commander of the Israelites in their battle against the Amalekites at Rephidim (Ex. xvii. 9-13), and he is represented as having earned further distinction along with Caleb by his calm and courageous demeanour in the midst of the popular tumult

caused by the report of the spies (Num. xiv. 6-9, 38). On the death of Moses he assumed the leadership to which he had previously been designated by his chief, and the book known by his name is entirely occupied with details of the manner in which he carried out the task thus laid to his hand,—that of taking possession of the land of Canaan. On the completion of the reconnaissance by the two spies, he left Shittim with his army, preceded by the priest-borne ark of the covenant. The Jordan having been miraculously crossed, his first encampment was at Gilgal. Jericho and Ai soon fell into his hands, and the people of Gibeon became vassals. In the neighbourhood of Gibeon the five kings of the Amorites were crushed in a decisive battle in which the very elements conspired to favour the invader, and (to use the poetical language of the book of Jashar) "the sun stood still and the moon stayed until the people had avenged themselves upon their enemies." The victorious arms of Israel were now directed northwards against a league of Canaanite potentates under the hegemony of Jabin, king of Hazor; anticipating the attack of the enemy, Joshua surprised and crushed them at the waters of Merom, Hazor itself being taken and burnt. Thus far the first twelve chapters of the book of Joshua; the remaining twelve describe the partition of the (conquered and unconquered) country among the twelve tribes, and conclude with a resumé of his parting exhortations. At the age of one hundred and ten he died and was buried in this inheritance in Timnath-serah, in the territory of Ephraim. For the book of Joshua, an integral part of that part of the Old Testament sometimes spoken of as Hexateuch, the reader is referred to the heading PENTATEUCH.

Critical investigation has shown that the history of Joshua as now sketched is a composite narrative, made up mainly from the two Elohistic (or, as they are now generally called, the Elohistic and the Levitical) documents. Fragments of an account of the conquest of Canaan older than either of these writings are preserved in the book of Judges, and it is generally recognized by recent inquirers that the progress of the Israelites was much slower and their action less united than appears on the face of the book of Joshua as we now read it, the statistics of the Levitical record in particular applying properly to a much later date. From this point of view Joshua appears rather as the leader of Ephraim than of all Israel. He is for the north what Caleb was for the south. See ISRAEL and JUDGES, and compare a paper by Meyer in *Stade's Zeitsch. f. A. Fliche Wiss.*, vol. i. (1881). See also Ewald, *Geschichte*, vol. ii. The only extra-Biblical notice of Joshua is the inscription of more than doubtful genuineness given by Procopius (*Fand.*, ii. 20), and mentioned also by Moses of Chorene (*Hist. Arm.*, i. 18). It is said to have stood at Tingis in Mauretania, and to have borne that those who erected it had fled before Ἰησοῦς ὁ Ἀραβίτης.

JOSIAH, the last but four of the kings of Judah, was the son of Amon, whom he succeeded when only eight years old, the people having declared in his favour against the conspirators who had murdered his unworthy father. The circumstances of the regency which must have existed during his minority are not recorded; it is not until his eighteenth year (for 2 Chr. xxxiv. 3 cannot be set against the explicit testimony of 2 Kings xxii., xxiii.) that he emerges into the light of history, when we find him interested in the repair of the temple at Jerusalem. The religious movement of which this was a symptom took more definite shape with the finding by Hilkiah the high priest of a copy of "the book of the law." The reasons for believing this to have been (substantially at least) the book of Deuteronomy cannot be detailed here. They were already appreciated by Jerome and Chrysostom, and no very careful examination is required to show that the effect of its perusal was to bring about a religious reformation, which in all its features was in accordance with the prescriptions and exhortations of that remarkable composition. The main features of the movement (which extended into the adjoining kingdom of Samaria, at that time a loosely

governed Assyrian dependency) have already been sketched in the article ISRAEL. On the secular aspects of the reign of Josiah Scripture is almost wholly silent. Thus nothing is related of the great Scythian invasion, which as we know from Herodotus (i. 105) took place at this period, and must have approached Judah, being probably alluded to by Zephaniah and Jeremiah. The storm which shook the great world powers was favourable to the peace of Josiah's kingdom; the power of Assyria was practically broken, and that of the Chaldeans had not yet developed itself into the aggressive forms it afterwards assumed. But in his thirty-first year Josiah for some unexplained reason was rash enough to place himself in the path of Pharaoh Necho in his military expedition against the king of Assyria; a disastrous encounter took place at Megiddo, in which he lost at once his crown and life (æt. 39).

JÓSIKA, MIKLÓS or NICHOLAS, BARON (1794-1865), the greatest and, next to Jókai, most prolific Hungarian novelist, was born 28th April 1794, at Torda in Transylvania, of aristocratic and wealthy parents. After finishing the usual course of legal studies at Kolozsvár (Klausenburg), he in 1811 at the age of seventeen entered the army, joining a cavalry regiment, with which he subsequently took part in the Italian campaign. In 1813 he was promoted to the grade of sub-lieutenant, and on the battlefield of Mincio (February 8, 1814) to that of lieutenant. Elevated to the rank of captain, he served in the campaign against Napoleon, and was present at the entry of the allied troops into Paris (31st March 1814). In 1818 Jósika resigned his commission in the army, returned to Hungary, and married his first wife Elizabeth Kallai. The union proving an unhappy one, Jósika parted from his wife, settled on his estate at Szurdok in Transylvania, and devoted himself to agricultural and literary pursuits. Drawn into the sphere of politics, he took part in the memorable Transylvanian diet of 1834. At about this period Jósika first began to attract attention as a writer of fiction. In 1836 he brought out his *Abafi*, 2 vols., which laid the foundation of his literary reputation. He was soon afterwards elected member of the Hungarian Academy of Sciences and of the Kisfaludy Society; of the latter he became, in 1841, director, and in 1842 vice-president. In 1847 Jósika appeared at the Transylvanian diet as second deputy for the county of Szolnok, and zealously supported the movement for the union of Transylvania with Hungary proper. In the same year he was converted to Protestantism, was formally divorced from his wife, and married Baroness Julia Podmaniczky, with whom he continued to live happily until his death. So great was Jósika's literary activity that by the time of the revolution (1848) he had already produced about sixty volumes of romances and novels, besides numerous contributions to literary and political periodicals. Both as magnate of the upper house of the Hungarian diet and by his writings Jósika aided the revolutionary movement, with which he was soon personally identified, being chosen one of the members of the committee of national defence. Consequently, after the capitulation at Világos (13th August 1849), he found it necessary to flee the country, and settled first at Dresden and then, in 1850, at Brussels, where he resumed his literary pursuits anonymously. In 1864 he removed to Dresden, in which city he died on the 27th February 1865. The romances of Jósika, written somewhat after the style of Sir Walter Scott, are chiefly of a historical and social-political character, his materials being drawn almost entirely from the annals of his own country. Among his more important works may be specially mentioned, besides *Abafi*—*The Poet Zrínyi*, 1843; *The last of the Batoris*, 1837; *The Bohemians in Hungary*, 1839; *Esther*, 1853; *Francis Rákóczy II.*, 1861; and *A Végváriak*, a tale of the time



of the Transylvanian prince Bethlen Gábor, 1864. Many of Jósika's novels have been translated into German, the earlier ones by Klein, Schwarz, Steinacker, and Kovács, and the later by Jósika's second wife Julia, herself an authoress of considerable merit.

See K. Menich and S. Vutkovič, *Magyar Irók Névtára*, Budapest, 1876; M. Jókai, "Jósika Miklós Emlékezete," *A Kisfaludy-Társaság Evtáji, Új folyam*, vol. iii., Pest, 1869; G. W. Steinacker, *Ungarische Lyriker*, Leipzig, 1874. Cf. also Jósika's autobiography—*Emlékirat*, Pest, 1865, vol. iv.

**JOSQUIN.** See DEPRÉS, JOSQUIN, vol. vii. p. 101, musical composer, ordinarily designated by the name Josquin.

**JOSI, ISAAK MARKUS** (1793–1860), historical writer, was born on February 22, 1793, at Bernburg, and studied at the gymnasium of Wolfenbüttel, whence he passed successively to the universities of Göttingen and Berlin. In Berlin he taught a school from 1826 till 1835, when he received the appointment of upper master in the Jewish commercial school (called the Philanthropin) at Frankfurt-on-the-Main. Here he remained until his death, 20th November 1860. The work by which he is chiefly known is a *Geschichte der Israeliten*, in 9 vols. (Berlin, 1820–29), which was afterwards supplemented by *Neuere Geschichte der Israeliten von 1815–45* (Berlin, 1846–47), and *Geschichte des Judenthums u. seiner Sekten* (Leipzig, 1857–59). He also published an abridgment of the *Geschichte* under the title *Allgemeine Geschichte des jüdischen Volks* (1831–32), and an edition of the Mishna with a German translation and notes (in 6 vols., 1832–34). The *Israelitische Annalen* were edited by him from 1839 to 1841, and he contributed extensively on pedagogic and historical subjects to scientific journals.

**JOUFFROY, THEODORE-SIMON** (1796–1842), a French philosopher, was born at Pontets, near Moulins, department of Doubs, 1796. In his tenth year, his father, who was a taxgatherer, sent him to an uncle at Pontarlier, under whom he commenced his classical studies. At Dijon his compositions attracted the attention of an inspector who had him placed (1814) in the Normal School, Paris. He there came under the influence of Cousin, and in 1817 he was appointed assistant professor of philosophy at the Normal and Bourbon schools. Three years later, being thrown upon his own resources, he began a course of lectures in his own house, and formed literary connexions with *Le Courrier Français*, *Le Globe*, *L'Encyclopédie Moderne*, and *La Revue Européenne*. The variety of his pursuits at this time carried him over the whole field of ancient and modern literature. But he was chiefly attracted to the philosophical system represented by Reid and Stewart. The application of "common sense" to the problem of substance supplied a more satisfactory analytic for him than the scepticism of Hume which reached him through a study of Kant. He thus threw in his lot with the Scotch philosophy, and his first dissertations are, in their leading position, adaptations from *The Inquiry*. His tendency towards eclecticism makes his philosophical position undefinable, but his limpid style and capacity for generalizing historical movements are as distinct in his earlier as in his later works. In 1826 he wrote a preface to a translation of the *Moral Philosophy* of Stewart, demonstrating the possibility of a scientific statement of the laws of consciousness; in 1828 he began a translation of the works of Reid, and in his preface estimated the influence of Scotch criticism upon philosophy, giving a biographical account of the movement from Hutcheson onwards. In the same year he assisted Milon in ancient philosophy at the Faculty of Letters, and, while carrying on a course upon recent philosophy, he returned to the Normal School in 1830. Next year he was returned to parliament by the arrondissement of Pontarlier; but the

work of legislation was ill-suited to his powers. Swift practical decisions on questions demanding immediate settlement were repugnant to his habits of mind. He tried to introduce a reform in the manner of considering petitions,—his sole suggestion of any weight during the years of his representation; though he frequently spoke, he never gained any real influence. Yet he attended to his parliamentary duties conscientiously, and ultimately broke his health in their discharge. In 1833 he was appointed professor of Greek and Roman philosophy at the college of France and a member of the Academy of Sciences; he then published the *Mélanges Philosophiques*, a collection of fugitive papers in criticism and philosophy and history. In them is foreshadowed all that he afterwards worked out in metaphysics, psychology, ethics, and aesthetics. He had already demonstrated in his prefaces the possibility of a psychology apart from physiology, of the science of the phenomena of consciousness distinct from the perceptions of sense. He now classified the mental faculties, premising that they must not be confounded with capacities or properties of mind. They were, according to his analysis, personal will, primitive instincts, voluntary movement, natural and artificial signs, sensibility and the faculties of intellect; on this analytic he founded his scheme of the universe. In 1835 he published a *Cours de Droit Naturel*, which, for precision of statement and logical coherence, is the most important of his works. Starting from the conception of a universal order in the universe, he reasons from it to a Supreme Being, who has created it and who has conferred upon every man in harmony with it the aim of his existence, leading to his highest good. As to the nature of good and evil, how is it to be judged? The good, he says, is the fulfilment of man's destiny, the evil the thwarting of it. Every man being organized in a particular way has, of necessity, an aim, the fulfilment of which is good; and he has faculties for accomplishing it, directed by reason. The aim is only good, however, when reason guides it for the benefit of the majority, but that is not absolute good. When reason rises to the conception of universal order, when actions are submitted, by the exercise of a sympathy working necessarily and intuitively, to the idea of the universal order, the good has been reached, the true good, good in itself, absolute good. But he does not follow his idea into the details of human duty, though he passes in review fatalism, mysticism, pantheism, scepticism, egotism, sentimentalism, and rationalism. In 1835 his health failed and he went to Italy, where he continued to translate the Scotch philosophers. On his return he became librarian to the university, and took the chair of recent philosophy at the Faculty of Letters. He died in Paris, 4th February 1842. After his death were published *Nouveaux Mélanges Philosophiques* and *Cours d'Esthétique*. The former contributed nothing new to the system except a more emphatic statement of the distinction between psychology and physiology. The latter formulated his theory of beauty. The beautiful, by his analysis, is that which aesthetically pleases, without consideration of interest. Utility being defined as the satisfaction of human wants, the beautiful may be useless. Order and proportion he takes to be the components of beauty,—an order and proportion not leading to the useful, but giving pleasure without consideration of the end. Unity and variety are the conditions of beauty; it demands their coexistence, the former for the satisfaction of sensibility, the latter of intelligence. Jouffroy's claim to distinction rests upon his ability as an expositor of other men's ideas. He founded no system; he contributed nothing of importance to philosophical science; he initiated nothing which has survived him. But his enthusiasm for mental science, and his command over the language of popular ex-

ation, made him a great, international medium for the trans- mission of ideas. He stood between Scotland and France and Germany and France; and, though his expositions are vinated by loose reading of the philosophers he interpreted, he did serviceable, even memorable work.

JOURDAIN, ALFONSE, count of Toulouse, son of Count Raymond IV. by his third wife, Elvire de Castile, was born in 1103, in the castle of Mont-Pèlerin, Tripoli. His father died when he was two years old, and he remained under the guardianship of the count of Cerdagne until he was five. He was then taken to Europe, and his brother gave him Rouergue; in his tenth year he succeeded to the government of Narbonne, Toulouse, and Provence, but Toulouse was taken from him by the duke of Aquitaine while he was still in his minority. After the duke's death the inhabitants of Toulouse revolted and recalled Jourdain; he returned in triumph in 1123. He, however, drew upon himself a sentence of excommunication by his treatment of the religious community of St Gilles, which had previously thrown in its influence on the side of the duke of Aquitaine. He had next to fight for the sovereignty of Provence against Raymond Beranger III., and not till September 1125 did the war end in an amicable agreement. Under it Jourdain became absolute master of the regions lying between the Pyrenees and the Alps, Auvergne and the sea. His ascendancy was an unmixed good to the country, for during a period of fourteen years art and industry were successfully prosecuted. Louis VII., for some reason which has not appeared, besieged Toulouse in 1141, but without result. Next year Jourdain again incurred the displeasure of the church by siding with the rebels of Montpeller against their lord. A second time he was excommunicated. But his isolation from Rome did not suit his taste or policy; so, in the autumn of 1144 he took the cross at the meeting of Vézelay called by Louis VII., and three years later he embarked for the East. He lingered on the way in Italy, and probably in Constantinople; but in 1148 he had arrived at Acre. Among his companions he had made enemies, and he was destined to take no share in the crusade he had joined. He was poisoned at Acre before hostilities commenced, either the wife of Louis or the mother of the king of Jerusalem suggesting the draught.

JOUVENET, JEAN (1617-1717), born at Rouen in 1647, came of a family of painters, one of whom had had the honour of teaching Poussin. He early showed remarkable aptitude for his profession, and, on arriving in Paris, attracted the attention of Le Brun, by whom he was employed at Versailles, and under whose auspices, in 1675, he became a member of the Royal Academy, of which he was elected professor in 1681, and one of the four perpetual rectors in 1707. The great mass of works that he executed, chiefly in Paris, many of which, including his celebrated Miraculous Draught of Fishes (engraved by Audran; also London, *Annales*, i. p. 42), are now in the Louvre, show his fertility in invention and execution, and also that he possessed in a high degree that general dignity of arrangement and style which distinguished the school of Le Brun. Jouvnet died on April 5, 1717, having been forced by paralysis during the last four years of his life to work with his left hand. See *Mém. Ind. Acad. Roy. de P. et de Sc.*, 1854, and D'Argenville, *Vies des Peintres*.

JOVELLANOS, or JOVE LLANOS, GASPARD MELCHOR DE (1744-1811), statesman and author, was born at Gijon in Asturias, Spain, January 5, 1744. Selecting law as his profession, he studied at Oviedo, Avila, and Alcala, and in 1767 became criminal judge at Seville. His integrity and ability were rewarded in 1778 by a judgeship in Madrid, and in 1780 by appointment to the council of

military orders. In the capital Jovellanos took a good place in the literary and scientific societies; for the society of Friends of the Country he wrote in 1787 his most valuable work, *Informe sobre un proyecto de Ley Agraria*. Involved in the disgrace of his friend, the brilliant French adventurer Cabarrus, Jovellanos spent the years 1790 to 1797 in a sort of banishment at Gijon, engaged in literary work and in founding the Asturian institution for agricultural, industrial, social, and educational reform throughout his native province. This institution continued his darling project up to the latest hours of his life. Summoned again to public life in 1797, Jovellanos refused the post of ambassador to Russia, but accepted that of minister of grace and justice, under "the Prince of the Peace," whose attention had been directed to him by Cabarrus, then a favourite of Godoy. Displeased with Godoy's policy and conduct, Jovellanos combined with his colleague Saavedra to procure his dismissal. They were but temporarily successful; Godoy returned to power in 1798; Jovellanos was again sent to Gijon, but in 1801 was thrown into prison in Majorca. The revolution of 1808, and the advance of the French into Spain, set him once more at liberty. Joseph Bonaparte, on mounting the Spanish throne, made Jovellanos the most brilliant offers; but the latter, sternly refusing them all, joined the patriotic party, became a member of the central junta, and contributed to reorganize the cortes. This accomplished, the junta at once fell under suspicion, and Jovellanos was involved in its fall. To expose the conduct of the cortes, and to defend the junta and himself were the last labours of his pen. In 1811 he was enthusiastically welcomed to Gijon; but the approach of the French drove him forth again. The vessel in which he sailed was compelled by stress of weather to put in at Vega in Asturias, where, on November 27, 1811, Jovellanos died.

The poetical works of Jovellanos comprise a tragedy *El Pelayo*, the comedy *El Delincuente Honrado*, satires, and miscellaneous pieces, including a translation of the first book of *Paradise Lost*. His prose works, especially those on political and legislative economy, constitute his real title to literary fame. In them depth of thought and clear-sighted sagacity are couched in a certain Ciceronian elegance and classical purity of style. Besides the *Ley agraria* he wrote *Elogios*; various political and other essays; and *Memorias Politicas*, 1801, suppressed in Spain, and translated into French, 1825. An edition of his complete works was published at Madrid, 1831-32, in 7 vols., and another at Barcelona, 1839.

See *Noticias historicas de Don G. M. de Jovellanos*, Palma, 1812, and *Memorias puestas en vista del Señor . . . Jovellanos*, by J. A. C. Bermudez, Madrid, 1814, both reviewed in the *Foreign Quarterly Review*, No. 5.

JOVIANUS, FLAVIUS CLAUDIUS, Roman emperor from June 27, 363, to February 17, 364, was the son of the brave general Varronianus, and was born at Singidunum in Moesia about 332. As captain of the guard (*primus ordinis domesticorum*) he accompanied Julian in his Persian expedition; and on the day after that emperor's death, when the aged Sallust declined the purple, the voices of the army beyond the Tigris were united in Jovian's favour. It was perhaps the absence of any very invidious ability, no less than his father's reputation, that set Jovian on the throne. The new emperor's first care was to continue the retreat begun by Julian; and he had with difficulty reached the rapid and well-nigh unpassable Tigris, when, overtures of peace were made, by the Persian king Sapor II., who had not ceased to harass the Roman march. Jovianus was not in a position to command easy terms; the famished and exhausted state of his army compelled his assent to a humiliating treaty, which gave up to the Persians the provinces of Arzacene, Corduene, Moxoene, Rehimene, and Zabdicene, which had been conquered by Galerius in 297, and Nisibis and other cities. From this time the Greek and Christian influence dates its decline in the trans-Euphrates regions. Jovian was anxious to reach Constantinople in order to establish his power; but the



news of the loyalty of the western legions gladdened him while still on the march through Asia Minor. After issuing a decree by which Christianity was restored as the state religion, though paganism was recognized, the emperor assumed the consulship at Ancyra, on January 1, 364, with his infant son as colleague. Within two months, on February 17, 364, Jovianus was found dead in his bed at Dadastana, a small town of Galatia. A surfeit of mushrooms or the fumes of a charcoal fire have been assigned as the causes of death. The suspicion of foul play is unsupported by evidence. He was succeeded by Valentinian and Valens, after an interregnum of ten days.

Besides the ancient historians of the period, see Gibben's *Decline and Fall*; Le Beau's *Bas-Empire*; Finlay's *Greece under the Romans*; and the Abbé de la Blérierie's *Histoire de Jovien*, Amsterdam, 1740. In Syriac literature Jovian (Jovianianus) became the hero of a Christian romance, published by George Hoffmann (*Julianus der Abtrünnige*, 1880). Compare the account of this work by Nöldeke, *Z. D. M. G.*, vol. xxviii.

JOVINIANUS, or JOVIANUS, a Roman monk and reputed heretic who flourished during the latter half of the 4th century. All our knowledge of him is derived from a passionately hostile polemic of Jerome (*Adv. Jovinianum Libri II.*), written at Bethlehem, and without any personal acquaintance with the man assailed, in 393 A.D. According to this authority he in 388 was living at Rome the celibate life of an ascetic monk, possessed a good acquaintance with Scripture, and was the author of several minor works, but, undergoing an heretical change of view, afterwards became a self-indulgent Epicurean and unrefined sensualist. The doctrinal heresies which had provoked the wrath of Jerome were mainly these:—(1) he held that in point of merit, so far as their domestic state was concerned, virgins, widows, and married persons who had been baptized into Christ were on a precisely equal footing; (2) those who with full faith have been regenerated in baptism cannot be overthrown (or, according to another reading, tempted) of the devil; (3) to abstain from meats is not more praiseworthy than thankfully to enjoy them; (4) all who have preserved their baptismal grace shall receive the same reward in the kingdom of heaven. Jerome's bitter polemic was chiefly provoked by those views of Jovinian as to fasting and marriage in which the entire Protestant world has declared itself substantially at one with the so-called heretic. He was, however, condemned by a Roman synod under Bishop Siricius in 390, and afterwards excommunicated by another at Milan under the presidency of Ambrose. The year of his death is unknown, but he is referred to as being no longer alive in Jerome's *Contra Vigilantium*, which was composed in 406.

JOVIUS, PAULUS, or PAOLO GIOVIO (1483–1552), an Italian historian and biographer, was born of an ancient and noble family at Como, April 19, 1483. His father died when he was a child, and Giovio owed his education to his brother Benedetto. After studying the humanities, he applied himself to medicine and philosophy at his brother's request. He was Pomponazzi's pupil at Padua; and afterwards he took a medical degree in the university of Pavia. But the attraction of literature proved irresistible for Giovio, and he was bent upon becoming the historian of his age. Some time, probably in or after 1516, he went to Rome, with a portion of his history already finished. This he presented to Leo X., who read the MS., and pronounced it superior in elegance to anything which had been produced since the decades of Livy. Giovio, encouraged by the success of his first step in authorship, took up his residence in Rome, and attached himself to the court of the cardinal Giulio de' Medici. The next pope, Adrian VI., gave him a canonry in his native town of Como, on the condition, it is said, that Giovio should mention him with honour in his history. This patronage from a pontiff who

was averse to the current tone of Italian humanism, proves that Giovio at this period passed for a man of sound learning and sober manners. After Adrian's death, Clement VII. assigned him chambers in the Vatican, with maintenance for servants befitting a courtier of rank. In addition to other benefices, he finally, in 1528, bestowed on him the bishopric of Nocera. Giovio had now become in a special sense dependent on the Medici. He was employed by that family on several missions,—as when he accompanied Ippolito to Bologna on the occasion of Charles V.'s coronation, and Caterina to Marseilles before her marriage to the duke of Orleans. During the siege of Rome in 1527 he attended Clement in his flight from the Vatican. While crossing the bridge which connected the palace with the castle of S. Angelo, Giovio threw his mantle over the pope's shoulders in order to disguise his master.

In the sack he suffered a serious literary loss if we may credit his own statement. The story runs that he deposited the MS. of his history, together with some silver, in a box at S. Maria Sopra Minerva for safety. This box was discovered by two Spaniards, one of whom secured the silver, while the other, named Herrera, knowing who Giovio was, preferred to hold the MSS. for ransom. Herrera was so careless, however, as to throw away the sheets he found in paper, reserving only that portion of the work which was transcribed on parchment. This he subsequently sold to Giovio in exchange for a benefice at Cordova, which Clement VII. conceded to the Spaniard. Six books of the history were lost in this transaction. Giovio contented himself with indicating their substance in a summary. Perhaps he was not unwilling that his work should resemble that of Livy, even in its imperfection. But doubt rests upon the whole of this story. Apostolo Zeno affirms that in the middle of the last century three of the missing books turned up among family papers in the possession of Count Gio. Batt. Giovio, who wrote a panegyric on his ancestor. It is therefore not improbable that Giovio possessed his history intact, but preferred to withhold those portions from publication which might have involved him in difficulties with living persons of importance. The omissions were afterwards made good by Curtio Marinello in the Italian edition, published at Venice in 1581. But whether Marinello was the author of these additions is not known.

After Clement's death Giovio found himself out of favour with the next pope, Paul III. The failure of his career is usually ascribed to the irregularity of the life he led in the literary society of Rome. We may also remember that Paul had special causes for animosity against the Medici, whose servant Giovio had been. Despairing of a cardinal's hat, Giovio retired to his estates at Como, where he spent the wealth he had acquired from donations and benefices in adorning his villa with curiosities, antiquities, and pictures. He died upon a visit to Florence in 1552.

Giovio's principal work was the *History of his own Times*, from the invasion of Charles VIII. to the year 1547. It was divided into two parts, containing altogether forty-five books. Of these, books v.–xi. of part i. were said by him to have been lost in the sack of Rome, while books xix.–xxiv. of part ii., which should have embraced the period from the death of Leo to the sack, were never written. Giovio supplied the want of the latter six books by his lives of Leo, Adrian, Alphonso I. of Ferrara, and several other personages of importance. But he alleged that the history of that period was too painful to be written in full. His first published work, printed in 1524 at Rome, was a treatise *De Piscibus Romanis*. After his retirement to Como he produced a valuable series of biographies, entitled *Elogia Virorum Illustrium*. They commemorate men distinguished for letters and arms, selected from all periods, and are said to have been written in illustration of portraits collected by him for the museum of his villa at Como. Besides these books, we may mention a biographical history of the Visconti, lords of Milan; an essay on mottoes and badges; a dissertation on the state of Turkey; a large collection of familiar epistles; together with descriptions of Britain, Muscovy, the Lake of Como, and Giovio's own villa. The titles of these miscellanies will be found in the bibliographical note appended to this article.

Giovio preferred Latin in the composition of his more important works. Though contemporary with Machiavelli, Guicciardini, and Varchi, he adhered to humanistic usages, and cared more for the Latinity than for the matter of his histories. His style is fluent and sonorous, rather than pointed or grave. Partly owing to the rhetorical defects

inherent in this choice of Latin, when Italian had gained the day, but more to his own untrustworthy and shallow character, Giovo takes a lower rank as historian than the bulk and prestige of his writings would seem to warrant. He professed himself a flatterer and a lampooner. The old story that he said he kept a golden and an iron pen, to use according as people paid him, condenses the truth in epigram. He had the faults of the elder humanists, in combination with that literary cynicism which reached its height in Aretino; and therefore his histories and biographical essays are not to be used as authorities, without corroboration. Yet Giovo's works, taken in their entirety and with proper reservation, have real value. To the student of Italy they yield a lively picture of the manners and the feeling of the times in which he lived, and in which he played no obscure part. They abound in vivid sketches, telling anecdotes, fugitive comments, which unite a certain charm of autobiographical romance with the worldly wisdom of an experienced courtier. A flavour of personality makes them not unpleasant reading. While we learn to despise and mistrust the man in Giovo, we appreciate the litterateur. It would not be too far-fetched to describe him as a sort of 16th century Horace Walpole.

*Bibliography.*—The sources of Giovo's biography are—his own works; Tiraboschi's *History of Italian Literature*; Litta's *Genealogy of Illustrious Italian Families*; and Giovo Batt. Giovo's *Uomini illustri della Diocesi Comasca*, Modena, 1734. Cicogna, in his *Delle Inscrizioni Veneziane Riscoperte* (Venice, 1830), gives a list of Giovo's works, from which the following notices are extracted:—1. Works in Latin:—(1) *Pauli Jovii Historiarum sui temporis*, Florence, 1550-52, the same translated into Italian by L. Domenichi, and first published at Florence, 1551, afterwards at Venice; (2) *Louis X., Hubricus VI., Pompeii Columnæ Cord., Vita*, Florence, 1518, translated by Domenichi, Florence, 1549; (3) *Vite XII. Vicentium Mediolani principum*, Paris, 1549, translated by Domenichi, Venice, 1549; (4) *Vita Sfortie clariss. ducis*, Rome, 1549, translated by Domenichi, Florence, 1549; (5) *Vite Fr. Ferri. Durati*, Florence, 1549, translated by Domenichi, *ibid.*, 1551; (6) *Vita magis Consulet*, *ibid.*, 1549, translated by Domenichi, *ibid.*, 1550; (7) *Alfonsi Atelesensis*, &c., *ibid.*, 1550, Italian translation by Giovo Batt. Gelli, Florence, 1553; (8) *Elogia virorum bellica virtute illustrium*, *ibid.*, 1551, translated by Domenichi, *ibid.*, 1554; (9) *Elogia clarorum virorum*, &c., Venice, 1546 (these are biographies of men of letters), translated by Hippolito Orio of Ferrara, Florence, 1552; (10) *Libellus de legatione Basilii Magni Principis Moscovitæ*, Rome, 1525; (11) *Descriptio Larii Lacus*, Venice, 1559; (12) *Descriptio Britannicæ*, &c., Venice, 1548; (13) *De Romanis Piscibus*, Rome, 1524. 2. Works in Italian:—(1) *Dialogo delle L'oprese militari et amorose*, Rome, 1555; (2) *Lettere Volgari*, Venice, 1560. Some minor works and numerous reprints of those cited have been omitted from this list; and it should also be mentioned that some of the lives, with additional matter, are included in the *Vite Illustrum Virorum*, Basel, 1576. (J. A. S.)

JUANES, or JOANES, VICENTE (1523-1579), head of the Valencian school of painters, and often called "the Spanish Raphael," was born at Fuente de la Higuera in the province of Valencia in 1523. Of his biography practically no authentic facts have been preserved. He is said to have studied his art for some time in Rome, with which school his affinities are closest, but the greater part of his professional life was spent in the city of Valencia, where most of the extant examples of his work are now to be found. All relate to religious subjects, and are characterized by dignity of conception, accuracy of drawing, truth and beauty of colour, and minuteness of finish. The best known are the Entombment, the Nativity, the Burial of a Monk, and the Martyrdom of St. Agnes. His style is also seen to full advantage in the series on the life of St. Stephen, originally painted for the church of San Esteban in Valencia, and now in the Museo at Madrid. He died at Bocairente (near Jativa) while engaged upon an altarpiece in the church there, on 21st December 1579.

JUAN FERNANDEZ, a small island in the South Pacific in 34° S. lat., 400 miles west of Valparaiso. The Spaniards also designate it *Mas-a-Tierra*, "more to land,"

to distinguish it from a smaller island, *Mas-a-Fuera*, "more to sea," 9 miles farther west. The aspect of Juan Fernandez is beautiful and striking; only 13 miles in length by 4 in width, it consists of a series of precipitous rocks rudely piled into irregular blocks and pinnacles. The highest of these masses (about 3000 feet), a fine object from the anchorage, is called, from its massive form, *El Yunque*, the Anvil; it appears to be inaccessible. Any attempt to scale the higher peaks of the island is dangerous; the soil is very light and shallow, and the vegetation mostly a shrubby under growth, and on any attempt to pull oneself up by the help of this, the whole is apt to give way, and climber and shrubs are precipitated together down the cliffs. The rocks are trap-tuffs, basalts, and greenstones, and the island seems to date back to the older trappean series. There is a doubtful story of light having been seen emanating from one of the higher peaks; but it seems likely that, if Juan Fernandez was ever a subaerial volcanic cone, its fires have been long extinguished. Small indentations are found all round the island, but Cumberland Bay on the north side is the only good anchorage, and even there, from the great depth of water, there is some difficulty and risk.

A wide valley collecting streams from several of the ravines on the north side of the island opens into Cumberland Bay, and is partially enclosed and cultivated; and the settlement, consisting of some thirty or forty dilapidated Chilean huts, faces the anchorage. As seen from the bay the mountains seem covered with foliage to the sky-line, except where precipitous faces of rock—basalt and greenstone—form a beautiful contrast to the luxuriant somewhat pale vegetation so characteristic of an island in the warmer temperate zone.

The flora and fauna of Juan Fernandez are in most respects Chilean,—the opportunities of immigration from any other direction being specially difficult, for nearly constant currents set from the south-west, a direction in which there is no land nearer than the antarctic continent. There are few trees on the island, and these are chiefly in inaccessible situations, the timber near the shore having been almost entirely cut down for fire-wood. Most of the valuable indigenous trees have been exterminated; the sandal-wood, which the earlier navigators found one of the most valuable products of the island, is now confined to almost inaccessible places, while the other prominent indigenous forms, a native palm (*Ceroxylon australe*) and two tree-ferns, may be counted on the fingers as they raise their feathery heads over some overhanging crag or precipitous ravine. The steep paths up the hills are bordered by a thicket of flowering shrubs and herbs chiefly of South American origin. One of the most prominent of the latter (*Gunnera chilensis*) expands its gigantic rhubarb-like leaves to an enormous size, while the procumbent rhizomes creep along the ground, throwing up leaf-stalks 8 and 10 feet in height, and forming with the leaves, which frequently measure 15 feet across, a canopy under which one can ride easily on the small Chilean horses. There are twenty-four species of ferns on the island, and of these four are special to it; so great a prevalence of ferns gives quite a character to the island flora.

The fauna of Juan Fernandez is likewise fairly rich and very special. There are no indigenous land mammals on the island. Pigs, which have long since become wild and numerous, were left by the earlier navigators, and wild goats imported in the same fashion are now abundant, and their flesh is excellent. Sea-elephants and fur-seals were at one time plentiful upon Juan Fernandez, and are still found in some numbers at Mas-a-Fuera. There are, besides the *Accipitres* and the *Natantes*, four land birds on Juan Fernandez (and four somewhat different on Mas-a-Fuera).



The four Juan Fernandez birds are a thrush, a tyrant, and two humming-birds (*Eustephanus fernandensis* and *E. galerites*). The thrush and *Eustephanus fernandensis* are special to the island, and the latter has the great peculiarity of having the male of a bright cinnamon colour while the female is green. Both sexes are green in *E. galerites*. Of the shrubs in the jungle bordering the ravine, there seems scarcely a plant of myrtle, or of a bignoniaceous plant with long dark bells associated with the myrtle, which is not inhabited by a pair of humming birds, so that the whirring and buzzing of the brilliant flutterers over the flowers is singularly attractive.

Juan Fernandez was discovered by a Spanish pilot of that name (who was also the discoverer of the island of Mas-a-Fuera) in 1563. Fernandez obtained from the Spanish Government a grant of the islands, where he resided for some time, stocking them with goats and pigs. He soon, however, appears to have abandoned his possessions, which were afterwards for many years only visited occasionally by fishermen from the coasts of Chili and Peru, who found the sea round the island well stocked with fish. In 1616 Le Maire and Schouten called at Juan Fernandez for water and fresh provisions. Pigs and goats were then abundant on the island, and the valleys coming down to the anchorage were filled with herbage and the sea with excellent fish. Sandal-wood was plentiful, and near the anchorage there was a grove of wild quince trees. The fleet under the command of Admiral l'Ermite next visited the island. Three soldiers and three gunners remained behind when the fleet left; what became of these is altogether unknown. In the year 1668 the buccaneer Sharp anchored off Juan Fernandez, at first apparently on the south side of the island and afterwards in Cumberland Bay. At the time of his visit seals and sea-lions frequented the shores in large numbers, and pigs, the descendants of those originally imported by Fernandez, were so abundant that a hundred were salted down in addition to those killed for immediate use. At the end of 1687 five men voluntarily remained at Juan Fernandez from another buccaneer commanded by Captain Edward Davis. They remained on the island until October 1690, when the English ship "Welfare," Captain John Story, took them off.

In February 1700 Dampier called at Juan Fernandez, and whilst there Captain Straddling of the "Cinque Porte" galley quarrelled with his men, forty-two of whom deserted; but were afterwards taken on board by Dampier; five seamen, however, remained on shore. In October 1704 the "Cinque Porte" returned and found two of these men, the others having been apparently captured by the French. On this occasion Captain Straddling had a disagreement with his master, Alexander Selkirk, who insisted upon being put on shore rather than serve longer with Straddling. Selkirk's desire was complied with, and he was sent on shore with a few ordinary necessaries. Before the ship left he begged to be readmitted; but this was refused, with the curious result that, with little merit of his own, Selkirk has become a hero for all time, and "Robinson Crusoe's Island" the cynosure of all boys' eyes. It is extremely improbable that Alexander Selkirk ever actually placed his journal in the hands of Defoe, but his story excited some public interest, and in catering for the public amusement that prince of raconteurs was most likely to have adopted Selkirk's tale for combination with other material in one of his wonderful "realistic novels." Many of the incidents in the *Adventures of Robinson Crusoe* are evidently inconsistent with the narrative of Selkirk, and are undoubtedly taken from other sources; for example, the footprint on the sand, and the decidedly tropical description of "Robinson Crusoe's Island," would agree better with one of the outlying islands of the West Indies. Alexander Selkirk was relieved from what appears to have been a by no means unbearable exile in 1709 by the ship "Duke," Captain Wood Rogers, and in 1868 the officers of H.M.S. "Topaze" erected a tablet at a point on the hill road called "Selkirk's Look-out," just where in a gap in the trap rock a magnificent view may be had of the whole island, and of the sea north and south, over which the exile must have often and eagerly watched for an approaching sail. It bears the following inscription:—"In memory of Alexander Selkirk, mariner, a native of Largo in the county of Fife, Scotland, who was on this island in complete solitude for four years and four months. He was landed from the 'Cinque Porte' galley, 96 tons, 16 guns, 1704 A.D., and was taken off in the 'Duke' privateer, 12th February 1709. He died lieutenant of the 'Weymouth,' 1723 A.D., aged forty-seven years. This tablet is erected near Selkirk's look-out by Commodore Powell and officers of H.M.S. 'Topaze,' 1868 A.D."

After Selkirk's relief, visits, especially from buccaneers, to the island of Juan Fernandez became more frequent. In June 1741 Commodore Anson anchored in Cumberland Bay in the "Centurion." During Anson's stay the "Trial" visited Mas-a-Fuera, and found the anchorage more exposed than at Juan Fernandez.

Anson found vegetables, of which the scurvy-struck crew of the "Centurion" stood greatly in need, much as formerly,—the cabbage palm, celery, water-cresses, and radishes being abundant. After having added to the resources of the island by sowing the stones of fruit trees and garden seeds, some of which did well, Anson continued his voyage in September. On Anson's return home it was proposed to form an English settlement on Juan Fernandez, but the Spaniards hearing that the matter had been mooted in England gave orders to occupy the island, and it was garrisoned accordingly in 1750. Carteret first observed this settlement in May, 1767, and on account of the hostility of the Spaniards preferred to put in at Mas-a-Fuera.

After the revolutionary wars Juan Fernandez passed into the possession of the Chilians, and has remained theirs ever since. Shortly after 1818 it was used as a state prison by the Chilian Government. In 1820 there appear to have been 300 convicts on the island, with 100 regular troops. In that year the island was swarming with wild horses, cattle, pigs, sheep, and goats, and vegetables and fruit were in abundance. In 1830 Juan Fernandez was visited by Captain King in H.M.S. "Adventure." There were then no convicts on the island. There was a small garrison of forty persons, and provisions were scarce. In 1833 Juan Fernandez was again used as a convict station by the Chilians. In 1835 the island appears to have been governed by a Mr Sutchiffe, an Englishman in the Chilian service. He was present when an earthquake took place on the 20th February of that year, of which he gives a description.

In November 1875 H.M.S. "Challenger," Captain F. T. Thomson, called at Juan Fernandez for two days, lying as usual in Cumberland Bay.

Shortly after 1835 Juan Fernandez was abandoned as a convict settlement, and since that time it has been leased by the Chilian Government to such as cared to occupy it for the supply of whalers and other passing ships, and for such remains of sea-lion hunting and fur-sealing as still exist. The speculation does not appear to be very profitable; and the island is likely to be by and by left so far as may be in the busier world of to-day to its pristine solitude. (C. W. T.)

JUAREZ, BENITO PABLO (1806-1872), president of Mexico, was born near Ixtlan, in the state of Oajaca, Mexico, March 21, 1806, of full Indian blood. Early left in poverty by the death of his father, he received from a charitable friar a good general education, and afterwards the means of studying law. Beginning to practise in 1834, Juarez speedily rose to professional distinction, and in the stormy political life of his time and country took a prominent part as an exponent of liberal views. In 1832 he sat in the state legislature; in 1846 he was one of a legislative triumvirate for his native state and a deputy to the republican congress, and from 1847 to 1852 he was governor of Oajaca. Banished in 1853 by Santa Anna, he returned to Mexico in 1855, and joined Alvarez, who, after Santa Anna's defeat, made him minister of justice. Under Comonfort, who succeeded Alvarez in December 1855, Juarez was made president of the supreme court of justice and minister of the interior; and, when Comonfort was unconstitutionally replaced by Zuloaga in 1858, the chief justice, in virtue of his office, claimed to be legal president of the republic. It was not, however, till the beginning of 1861 that he succeeded in finally defeating the unconstitutional party and in being duly elected president by congress. His decree of July 1861, suspending for two years all payments on public debts of every kind, led to the landing in Mexico of English, Spanish, and French troops. The first two powers were soon induced to withdraw their forces; but the French remained, declared war in 1862, placed Maximilian upon the throne as emperor, and drove Juarez and his adherents to the northern limits of the republic. Juarez maintained an obstinate resistance, which resulted in final success. In 1867 Maximilian was taken at Querterero, and shot; and in August Juarez was once more elected president. His term of office was far from tranquil; discontented generals stirred up ceaseless revolts and insurrections; and, though he was re-elected in 1871, his popularity seemed to be on the wane. He died of apoplexy in the city of Mexico, July 18, 1872. In him Mexico lost a statesman of integrity, ability, and deter-

mination, whose good qualities are too apt to be overlooked in consequence of his connexion with the unhappy fate of Maximilian.

JUBA I., successor to his father Hiempsal on the throne of Numidia, owes his importance much more to the distracted state of the Roman world during the struggle betwixt Cæsar and Pompey than to his intrinsic merit. He embraced Pompey's cause, moved by ancient hereditary friendship to that general, as well as by personal enmity to Cæsar, who had insulted him at Rome a few years before, and to Curio, Cæsar's general in Africa, who had openly proposed when tribune of the plebs in 50 B.C. that Numidia should be sold to colonists, and the king reduced to a private station. In 49 B.C. Juba marched against Curio, who was threatening Utica, and by a stratagem inflicted on the Cæsarean army a crushing defeat, in which Curio was slain. Juba's attention was momentarily distracted by a counter invasion of his territories by Bocchus and Sittius; but, finding that his lieutenant Saburra was able to defend his interests, he rejoined Scipio with a large body of troops. With Scipio he shared the defeat at Thapsus. Fleeing from the field with the Roman general Petreius, the king wandered about for some time as a fugitive, spurned even from the gates of his own city Zama, where he had prepared for a desperate siege. The fugitives at length resolved to die by mutual slaughter. Juba killed Petreius, and sought the aid of a slave in despatching himself (46 B.C.). Juba's character may be summed up in the word savage; he was brave, treacherous, insotent, and cruel.

JUBA II., king of Mauretania, was on the death of his father Juba I. in 46 B.C. carried to Rome, a mere infant, to grace Cæsar's triumph. He seems to have received a good education under the care of Octavianus (afterwards Augustus), whom he accompanied later in his campaign against Antony. In 29 B.C., after Antony's death, Octavianus gave the young African the hand of Cleopatra Selene, daughter of Antony and Cleopatra, and placed him on his paternal throne. In 25 B.C., however, he transferred him from Numidia to the kingdoms formerly held by Bocchus and Bogus, viz., Mauretania Tingitana and Mauretania Cesariensis, to which was added a part of Gætulia. Juba fixed his royal residence at Jol, whose name he changed to Cæsarea, and which is now identified with the modern Cherchel, about 72 miles west of Algiers. He seems to have reigned in considerable prosperity, though in 6 A.D. the Gætulians rose in a revolt of sufficient importance to afford the surname Gætulicus to Cornelius Cossus, the Roman general whose aid the king called in to suppress it. According to Josephus (*Ant.* xvii. 13, 1 and 4; *B. J.*, ii. 7, 4), Juba married in second nuptials Glaphyra, daughter of Archelaus of Cappadocia, and widow of Alexander, son of Herod the Great, afterwards wife of Alexander's brother, the Archelaus of the New Testament. The date of Juba's death is by no means certain; from the evidence of coins and certain allusions in Strabo, scholars have been led to place it in 19 or 20 A.D.

Juba, to quote the words of Pliny, was more memorable for his writings than for his crown. He wrote many historical and geographical works, of which some seem to have been voluminous and of considerable value on account of the sources to which their author had access. Unfortunately they are known to us only from fragments imbedded in other writers. The list given by C. Muller in his *Fragmenta Historicorum Græcorum* (vol. iii., Paris, 1849), is as follows:—(1) *Ῥωμαϊκὴ ἱστορία*; (2) *Ἀσσυριακὰ*; (3) *Λιβυκὰ*; (4) *De Arabia sive De Expeditione Arabica*; (5) *Physiologia*; (6) *De Euphorbia herba*; (7) *Περὶ ὄπῳ*; (8) *Περὶ γραφικῆς* (*Περὶ ζωγράφων*); (9) *Θεατρικὴ ἱστορία*; (10) *Ὀμοιωτικαί*; (11) *Περὶ φθορᾶς λέξεως*; (12) *Ἐπίγραμμα*. Muller (*loc. cit.*) has collected at the head of Juba's fragments the scattered notices of the king from the writers of antiquity. See also Sevin in *Mém. de l'Acad. des Inscriptions*, vol. iv.

JUBBULPORE. See JADALPUR.

JUBILEE, or JUBILE, THE YEAR OF. In Ezek. xlv. 16, 17, there is indication of a law according to which "the prince" is at liberty to alienate in perpetuity any portion of his inheritance to his sons; but if he give a gift of his inheritance to any other of his subjects, then the change of ownership holds good only till "the year of liberty" (שָׁנַת הַיְרֵוּהוּ), after which the alienated property returns to its original possessor, the prince. This restriction upon the transfer of real property is applied to a greatly enlarged class of persons and cases in Lev. xxv. 8-55, which is by far the most important passage relating to this subject. It is again referred to in Lev. xxvii. 17-25, and the only other allusion to it in the Pentateuch occurs in Numb. xxxvi. 4. According to Lev. xxv. 8-12, at the completion of seven sabbaths of years, the trumpet of the jubilee (שֹׁפָר הַיְרֵוּהוּ) is to be sounded "throughout the land," on the tenth day of the seventh month, i.e., on the great day of atonement. The fiftieth year thus announced is to be "hallowed," i.e., liberty (יְרֵוּהוּ) is to be proclaimed everywhere to every one, and the people are to return "every man unto his possession and unto his family." The year in other respects is to resemble the sabbatical year; there is to be no sowing, nor reaping that which grows of itself, nor gathering of grapes. Coming to fuller detail,—as regards real property (Lev. xxv. 13-34), the law is that if any Hebrew under pressure of necessity shall alienate his property he is to get for it a sum of money reckoned according to the number of harvests to be reaped between the date of alienation and the first jubilee year; should he or any relation desire to redeem the property before the jubilee, this can always be done by repaying the value of the harvests between the redemption and the jubilee. The fundamental principle is that "the land shall not be sold so as to be quite cut off, for it is mine, and ye are strangers and sojourners with me." The same rule applies to dwelling-houses of unwalled villages; the case is different, however, as regards dwelling-houses in walled cities. These may be redeemed within a year after transfer, but if not redeemed within that period they continue permanently in possession of the purchaser. An exception to this last rule is made for the houses of the Levites in the Levitical cities. As regards property in slaves (Lev. xxv. 35-55), the Hebrew whom necessity has compelled to sell himself into the service of his brother Hebrew is to be treated as a hired servant and a sojourner, and to be released absolutely at the jubilee; non-Hebrew bondmen on the other hand are to be bondmen for ever. But the Hebrew who has sold himself to a stranger or sojourner is entitled to freedom at the year of jubilee, and further is at any time redeemable by any of his kindred,—the redemption price being regulated by the number of years to run between the redemption and the jubilee, according to the ordinary wage of hired servants. So much for the Levitical law; as regards its observance, the evidence of history is not voluminous, but Jer. xxxiv. 14 seems to show conclusively that in his time at least the law acknowledged by the prophets was that described in Dent. xv., according to which the rights of Hebrew slave-holders over their compatriots were invariably to cease seven years after they had been acquired. After the exile the law of Lev. xxv. was also certainly disregarded; the Talmudists and Rabbins are unanimous that although the jubilee years were "reckoned" they were not observed.

As regards the meaning of the name "jubilee" (שָׁנַת הַיְרֵוּהוּ), or simply יְרֵוּהוּ, *ἐνιαυτὸς ἀφέσεως* or *ἀφεσις*, and us *jubilæi* or *jubilæus*, authorities are not agreed. According to Josephus (*Ant.*, iii. 12, 3), it means *ἐλευθερία*; but the use of the word יְרֵוּהוּ in Exod. xix. 13, Josh. vi. 5, makes it probable that the name is derived from the trumpet sound with which the jubilee was to be proclaimed; and it is not impossible that the old Jewish traditional view is right



which states **יבל** to mean a ram—for which there is a probable confirmation in Phœnician—and then, by abbreviation for **יבל יבל**, a trumpet of ram's horn. See Dillmann on Exod. xix. 13. If the law of the jubilee is posterior to the time of Jeremiah and Ezekiel, and was not enforced after the exile, the practical difficulties of the institution, especially in its connexion with the sabbatical year, call for no remark. Older theologians, by whom all the Pentateuchal laws were regarded as homogeneous parts of a single practical scheme, spent much ingenuity on the explanation of the year of jubilee. Thus Scaliger and many others sought to identify it with the seventh sabbatical year, and so to avoid a succession of two years in which agriculture was suspended. The most ingenious form of this attempt is the theory of Franke (*Nov. Syst. Chron. Fund.*, 1778), revived by Klostermann (*Stud. u. Krit.*, 1850, p. 720 sq.), which compares the jubilee period with the Egyptian twenty-five year period, and connects it with the intercalation necessary to re-establish the correspondence of the lunar and solar years.

**JUBILEE YEAR**, in the Roman Catholic Church, is observed every twenty-fifth year, from Christmas to Christmas. During its continuance plenary indulgence is obtainable by all Catholics, on condition of their penitently confessing their sins and visiting certain churches a stated number of times, or doing an equivalent amount of meritorious work. The institution does not go farther back than to the time of Boniface VIII., whose bull is dated April 22, 1300. The circumstances in which it was promulgated are related by a contemporary authority, Jacobus Cajetanus, according to whose account ("Relatio de centesimo s. jubilæo anno" in the *Bibliotheca Patrum*) it had its origin in a wide-spread popular belief then prevalent, which had taken practical shape in an enormous influx of pilgrims to Rome from the 1st of January onwards. The advance upon the recently formulated doctrine of indulgences (see **INDULGENCE**) was indeed a natural one. Originally the churches of St Peter and St Paul in Rome were the only jubilee churches, but the privilege was afterwards extended to the Lateran Church and that of Sta Maria Maggiore, and it is now shared also for the year immediately following that of the Roman jubilee by a number of specified provincial churches. At the request of the Roman people, Clement VI. appointed that the jubilee should recur every fifty years instead of every hundred years as had been originally contemplated in the constitution of Boniface; Urban VI. reduced the interval still further to thirty-three years (the supposed duration of the earthly life of Christ); and by Paul II. it was finally fixed at twenty-five years. According to the special ritual prepared by Alexander VI. in 1500, the pope on the Christmas eve with which the jubilee commences goes in solemn procession to a particular walled-up door ("Porta aurea") of St Peter's and knock three times, using at the same time the words of Ps. cxviii. 19 ("Aperite mihi portas justitiæ"). The doors are then opened and sprinkled with holy water, and the pope passes through. A similar ceremony is conducted by cardinals at the other jubilee churches of the city. At the close of the jubilee, the special doorway is again built up with appropriate solemnities. The last ordinary jubilee was observed in 1875. "Extraordinary" jubilees are sometimes appointed on special occasions.

**JUBILEES, BOOK OF THE.** See **APOCALYPTIC LITERATURE**, vol. ii. p. 176.

**JUDÆA.** See **PALESTINE**.

**JUDAH** (יהודה, Yehûda, *i.e.*, according to the etymology given in Gen. xxix. 35, "praised"), the name of one of the twelve tribes and of their eponymus the fourth son of Jacob by Leah. Except in the history of Joseph, the Biblical interest attaching to Judah belongs not to the individual but to the tribe; for in Gen. xxxviii. an ethnographical allegory appears transparently enough under the surface of the record. According to the usual form of such statements in the Old Testament, Judah's marriage

with the daughter of the Canaanite Shuah is to be referred to a union of the tribe with Canaanite elements. Er and Onan are extinct subdivisions of the mixed population, though a minor family of the former name appears as incorporated with Shelah, the third clan of this branch of the tribe (1 Chron. iv. 21). The details of the disappearance of these ancient stocks are obscure.<sup>1</sup> The stocks of Pharez and Zerah are represented as secondary. They are children of Judah and Tamar, but the former is their father in virtue of an extension of the levirate principle. As the author represents Tamar's conduct as justifiable under the circumstances, the narrative must have taken shape before the levirate law assumed the narrower form given in Deuteronomy.<sup>2</sup> An ingenious explanation of Tamar, Pharez, and Zerah is given by Lagarde, *Orientalia*, ii. (1880). He identifies Tamar (palm tree) with Phœnicia, and regards Zerah (זרה=אורה, *indigena*) as the old Canaanite element of the union which had to yield precedence to the younger Hebrew invaders (Pharez). In any case the narrative of Gen. xxxviii., with all its obscurities, indicates two of the most notable features in the early history of Judah, its mixed character and its long separation from the rest of Israel (ver. 1). The latter point receives further illustration in the book of Judges. Judah and Simeon seem to have broken off from Israel at Gilgal, and taken a separate course. In the song of Deborah the tribe is not named among the rest, and even in the time of David Judah and Israel are still more conscious of their separation than of their original unity. Indeed the two soon fell apart again at the division of the kingdom, but after the time of David the idea of unity was never lost; and, while the prophets look for a restoration of the realm of the house of Jesse, Deut. xxxiii. 7 (the work of a poet of Ephraim) prays for victory to Judah against his enemies and his ultimate restoration to his people, the greater Israel of the north. The blessing of Jacob, on the other hand, views Judah in the light of the Davidic sovereignty as holding the hegemony over his brethren until the coming of the Messiah.<sup>3</sup> Our most detailed information as to the tribal history of Judah is derived from 1 Chron. ii. 1-iv. 23. It appears that the tribe absorbed a large element of non-Israelite origin, the Hezronites, or, as the Arabs would now say, the *hadar*, original nomads who had settled down in villages and towns. To these belonged not only the Jerahmeelites but the Calibbites in Hebron and the southern steppes. It appears to have been the incorporation of these elements that raised Judah to the eminent place which it maintained from the time of David. The details of this important piece of history have been analysed by Wellhausen, *De gentibus et familiis Judæorum* (Göttingen, 1870).

**JUDAS ISCARIOT** (Ἰούδας Ἰσκαριώτης or Ἰσκαριώθ), the son of Simon Iscariot (John. vi. 71, xiii. 26), and one of the twelve apostles; he is always enumerated last, with special mention of the fact that he was the betrayer of Jesus. If the now generally accepted explanation of his surname (יהודה קריות, *i.e.*, "man of Kerioth"; see Josh. xv. 25) be correct, he was the only original member of the apostolic band who was not a Galilean. (For other

<sup>1</sup> Compare the Arabic **سحلي**, *Sahîh*, Bulak ed. vi. 147; *Mocatta*, Cairo ed., iii. 77.

<sup>2</sup> Compare Hupfeld, *Ueber die heutige theosophische Theologie*, 1861.

<sup>3</sup> The oldest interpretation of Shiloh, as if it were pointed **שילה** (for **אשר לו**) is perhaps the best, especially if with Wellhausen (*Gesch.*, p. 375) we delete the following **וְלֹא**. The sense then is, "till he comes to whom the people's obedience is due." Another explanation is given by Lagarde (*Onom.*, ii. 95), who takes the word as equivalent to **שֵׁאלִיָה**, "he whom Judah prays for." At all events the context demands a Messianic interpretation.

suggested etymologies of the name see Winer's *Bib. Realwörterb.*, s. v.) The circumstances which led to his admission into the apostolic circle are not stated; according to the Fourth Gospel (vi. 64), his treachery had been foreseen by Jesus from the very first, but this is not suggested by the synoptists. The motives by which he was actuated in rendering to the Jewish authorities the petty and base service of enabling them to arrest his Master without tumult have been analysed by scholars with very various degrees of subtlety and insight. According to some his sole object was to place Jesus in a position in which He should be compelled to make what had seemed to His followers the too tardy display of His Messianic power; according to others (and their view seems the best supported by the narrative of the Gospels) he was simply an avaricious and dishonest man, who felt that his opportunities for petty peculation—as keeper of the common purse, John xii. 6, ziii. 29—were rapidly disappearing. As regards the effects of his subsequent remorse and the use to which his ill-gotten gains were put, the strikingly apparent discrepancies between the narratives of Matt. xxvii. 3-10 and Acts i. 18, 19 have continually attracted the attention of Biblical scholars ever since Papias, in his fourth book, of which a fragment has been preserved, discussed the subject; the probability is that they simply represent divergent traditions, one of which has possibly been coloured by the history of Abithophel. In ecclesiastical legend and in sacred art Judas Iscariot has taken a prominent place, being generally treated as the very incarnation of treachery, ingratitude, and impiety. The Middle Ages, after their fashion, have supplied the lacunæ in what they deemed his too meagre biography. According to the common form of their story, he belonged to the tribe of Reuben; before he was born his mother Cyborea had a dream that he was destined to murder his father, commit incest with his mother, and sell his God. The attempts made by her and her husband to avert this curse simply led to its accomplishment. At his birth he was enclosed in a chest and flung into the sea; picked up on a foreign shore, he was educated at the court until an act of murder committed in a moment of passion compelled his flight. Coming to Judæa, he entered the service of Pontius Pilate as page, and during this period committed the first two of the crimes which had been expressly foretold. Learning the secret of his birth, he, full of remorse, seeks the prophet who, he has heard, has power on earth to forgive sins. He is accepted as a disciple and promoted to a position of trust, where avarice, the only vice in which he has hitherto been unpractised, gradually takes possession of his soul, and leads to the complete fulfilment of his evil destiny. This Judas legend, as given by Jacobs and Voragine, obtained no small popularity; and it is to be found in various shapes in every important literature of Europe. For the history of its genesis and its diffusion the reader may consult D'Ancona, *La leggenda di Vergogna e la leggenda di Giuda*, Bologna, 1869, and papers by W. Creizenach in Paul and Braune's *Beitr. zur Gesch. der deutschen Sprache und Literatur*, vol. ii., Halle, 1875, and Victor Diederich in *Russische Revue*, St Petersburg, 1880. Cholevius, in his *Geschichte der deutschen Poesie nach ihren antiken Elementen* (Leipsic, 1854), pointed out the connexion of the legend with the *Œdipus* story. The popular hatred of Judas has found strange symbolical expression in various parts of Christendom. In Corfu, for instance, the people at a given signal on Easter eve throw vast quantities of crockery from their windows and roofs into the streets, and thus execute an imaginary stoning of Judas (see Kirkwall, *Ionian Islands*,

vol. ii. p. 47). At one time (according to Mustoxidi, *Delle cose corciresi*) the tradition prevailed that the traitor's house and country villa existed in the island, and that his descendants were to be found among the local Jews. Details in regard to some Judas legends and superstitions are given in *Notes and Queries*, 2d series, v., vi., and vii.; 3d ser., vii.; 5th ser., vi.

JUDAS MACCABÆUS. See ISRAEL and MACCABEES.

JUDAS TREE, the *Cercis Siliquastrum* of botanists, belongs to the section *Cæsalpinea* of the natural family *Leguminosæ*. It is a native of the south of France, Spain, Portugal, Italy, Greece, and Asia Minor, and forms a handsome low tree with a flat spreading head. In spring it is covered with a profusion of purplish pink flowers, which appear before the leaves. The flowers have an agreeable acid taste, and are eaten mixed with salad or made into fritters. The tree was one frequently figured by the older herbalists. One woodcut by Castor Durante is a copy of Lobel's cut, with the addition of the figure of Judas suspended from one of the branches, illustrating the popular tradition regarding this tree. A second species, *C. canadensis*, is common in North America from Canada to Virginia, and differs from the European species in its smaller size and pointed leaves. The flowers are also used in salads and for making pickles, while the branches are used to dye wool a nankeen colour.

JUDE. The writer of the epistle of St Jude (*Ιουδας*) calls himself (ver. 1) "the brother of James." In primitive Christian times, among the Judæo-Christians to whom this epistle, from the nature of its contents, must have been addressed, there was but one James who could be thus spoken of without any further description, viz., James "the Lord's brother" (see JAMES). The writer of this epistle, then, claims to be the Judas named among the brethren of the Lord in Matt. xiii. 55, Mark vi. 3. He seems himself to declare by implication that he was not an apostle (ver. 17), and with this agrees the statement (John vii. 5) that at a time not long before the crucifixion the brethren of Jesus did not believe on Him. And it is some confirmation of this position that the writer of the epistle of St James in like manner does not claim to be an apostle. The brethren of the Lord are spoken of in Acts i. 14 as distinct from the apostolic body, and are placed last in the enumeration, as though latest included among the believers; and that their feeling towards Jesus should have been changed since His death and resurrection has been thought to be sufficiently explained by the assertion of St Paul (1 Cor. xv. 7) that the Lord had been "seen of James" on one special occasion after he had risen from the dead. We conclude therefore that the writer of the epistle was a different person from Jude the apostle, who appears also to have had the names Lebbaeus and Thaddæus (comp. Matt. x. 3, Mark iii. 18, with Luke vi. 16, Acts i. 13).

When we consider the brevity of St Jude's epistle we can hardly wonder that it did not receive more recognition from the early Christian writers than it has met with. Clemens Alexandrinus (165-220) quotes from this epistle or alludes to its language more than once, as does Tertullian (200), making express mention that the book of Enoch is quoted in it.<sup>2</sup> Origen (186-253) gives several notices of it, and in the Latin translation of some portions of his works, of which the original has been lost, Jude is called an apostle. Nevertheless Eusebius classes the epistle amongst the *ἀπὸκρυφά*, and its omission from the Syriac version shows us that in one branch of the Christian church it was either not known, or not received for canonical, when that version was made. Jerome in the 4th century

<sup>1</sup> Other forms make him a Danite, and consider the passage in Genesis (xlix. 17) a prophecy of the traitor.

<sup>2</sup> The book of Enoch (see vol. ii. p. 175) is cited in Jude 14, and allusions to it occur in 4, 6, 13. Another apocalyptic work, the Assumption of Moses, is the source of Jude 9.



gives a reason for its non-acceptance, which perhaps operated with many of the early Christians. He says (*Catalog. Scr. Eccl.*, 4), "Because in it Jude derives a testimony from the book of Enoch, which is apocryphal, it is rejected by most." Yet the canon of Muratori, the date of which is judged to be about 170 A.D., includes the epistle of St Jude among the canonical books, though Justin Martyr (140), Theophilus of Antioch (180), and Irenæus (135-200) make no mention of it. It was early included among the acknowledged Christian writings, and was placed without question among the canonical books by the council of Laodicea.<sup>1</sup>

The persons to whom the epistle was addressed must have been for the most part Judeo-Christians. This is the reason why the writer styles himself "brother of James," and the same is apparent from all the illustrations contained in the letter. The deliverance from Egypt, the fallen angels, the cities of the plain, the legend of Michael's contention with Satan, the references to Cain, Balaam, and Korah, as well as to the prophecy ascribed to Enoch, are all found in so brief a space, and are so touched upon in a manner that could be edifying to none save those who were familiar, not only with Old Testament Scripture, but also with Jewish traditions, that we cannot but conclude that we have here the work of a Jew writing for Jews, although the epistle is included among those called "catholic."

From the notices of the descendants of Jude, the brother of the Lord, preserved by Eusebius (*H. E.*, iii. 19, 20) from Hegesippus, we should conclude that they were resident in Palestine. It seems natural therefore to suppose that the epistle was written in Palestine, and, it may be, for the Jewish converts in some district of that country. But of this we can have no certainty. If, as seems to be intimated by Hegesippus, Jude was dead in the time of Domitian, we perhaps shall not be far wrong in assigning the composition of the epistle to about 80 A.D. All arguments for an earlier date, based on the assumption that in a letter of this character the writer would not have failed to mention the destruction of Jerusalem as an illustration, had that event already taken place, must be disregarded. For the brevity of the letter is such as to deprive this reasoning of all force, while the very recentness of the overthrow of Jerusalem would prevent its destruction from entering as yet into such history as might be used for pointing a moral.

The epistle of St Jude appears to have been written after the second epistle of St Peter. Of those corrupt teachers about whom St Peter spoke in the future tense, "there shall be false teachers among you," St Jude speaks in the past, "certain men are crept in unawares;" and the like difference is observable throughout the respective letters wherever verbs occur to which it is possible to attach a definite notion of time. But, beside this, St Peter's letter represents all the corruption which he sees likely to break forth among the Christian community as the outcome of false teaching. Destructive heresies are abroad, and through them many shall be induced to follow lascivious doings, and the way of truth shall be evil spoken of. With a promise of liberty which sounds like a perverse employment of some of St Paul's language they will lead their followers astray. But in St Jude's picture the colours seem much darker, and all allusions to teaching, and to the idea that, by lessons such as we know from other sources

the Gnostics did give, these men were being beguiled into evil courses through what appeared to be the gate of greater knowledge, have disappeared. The sinners against whom this epistle is directed were avowed libertines and practical unbelievers; they mocked at all sacred things; they were sensual, and had not the Spirit. But stronger than any other reason for believing in the later date of the present epistle is the direct quotation which is made in it from the 2d epistle of St Peter. In verses 17-18 St Jude writes, "But ye, beloved, remember ye the words which have been spoken before by the apostles of our Lord Jesus Christ, how that they said to you, In the last time there shall be mockers (*ἐμπαῖκται*) walking after their own ungodly lusts." The whole of what is here given as apostolic teaching corresponds very closely indeed with the words of 2 Peter iii. 2, while the word *ἐμπαῖκται* is one that is found nowhere else in the New Testament until it is here quoted by St Jude.

Attempts have been made to prove that St Jude's epistle originally appeared in Aramaic, from which the Greek that we have is a translation. But there seems no sufficient evidence for such a conclusion. No doubt a Jew when writing Greek would not unfrequently give expression to his thoughts in a form more or less moulded after his mother tongue, but there are far more points in the epistle which are satisfactory Greek of the date of the New Testament than are the instances which, even after much ingenuity, can be shown to be renderings of Aramaic.

See Semler, *Paraphrasis epp. Jacobi, Petri, et Judæ*, 1781; Augusti, *Die Katholischen Briefe*, 1801; Jessien, *De authentia ep. Judæ*, 1821; Stier, *Der Brief Judæ*, 1850; Wiesinger (in Olsbansen's *Bibelwerk*), 1854; Hoffmann, *Die Briefe Petri, Judæ, und Jacobi*, 1875; Reuss, *Les Épîtres Catholiques*, 1878. (J. R. L.)

JUDGE, an officer appointed by the sovereign power in a state to administer the law. The duties of the judicial office, whether in a civil or a criminal matter, are to hear the statements on both sides in open court, to arrive at a conclusion as to the truth of the facts submitted to him, or when a jury is engaged to direct the jury to find such a conclusion, to apply to the facts so found the appropriate rules of law, and to certify by his judgment the relief to which the parties are entitled or the obligations or penalties which they have incurred. With the judgment the office of the judge is at an end, but the judgment sets in motion the executive forces of the state, whose duty it is to carry it into execution. Such is the type of a judicial officer recognized by mature systems of law, but it is not to be accepted as the universal type, and the following qualifying circumstances should be noticed. 1. In primitive systems of law the judicial is not separated from the legislative and other governing functions. 2. Although the judge is assumed to take the law from the legislative authority, yet, as the existing law never at any time contains provision for all cases, the judge may be obliged to invent or create principles applicable to the case. This is called by Bentham and the English jurists judge-made and judiciary law. 3. The separation of the function of judge and jury, and the exclusive charge of questions of law given to the judge, are more particularly characteristic of the English judicial system. During a considerable period in the history of Roman law an entirely different distribution of parts was observed. The adjudication of a case was divided between the *magistratus* and the *judex*, neither of whom corresponds to the English judge. The former was a public officer charged with the execution of the law; the latter was an arbitrator whom the magistrates commissioned to hear and report upon a particular case. The following are points more specially characteristic of the English system and its kindred judicial systems. 1. Judges are absolutely protected from action for anything that they may do in the discharge of their judicial duties. This is true in the fullest sense of judges of the supreme

<sup>1</sup> Many modern critics, following Luther, have questioned the genuineness of the epistle. The libertines against whom it is directed display close affinity to the Carpocratians of the 2d century, of whose heresy Clemens Alexandrinus makes it a prophecy. Mayerhoff, Schenkel, and Maugold suppose that it was written against that heresy not long before the middle of the 2d century. It is also argued that the Muratorian canon seems to regard the epistle as pseudonymous in the same sense as the Wisdom of Solomon.

courts. "It is a principle of English law that no action will lie against a judge of one of the superior courts for a judicial act, though it be alleged to have been done maliciously and corruptly." Other judicial officers are also protected, though not to the same extent, against actions. 2. The highest class of judges are irremovable except by what is in effect a special Act of Parliament, viz., a resolution passed by both Houses and assented to by the sovereign. The inferior judges and magistrates are removable for misconduct by the Lord Chancellor. 3. The judiciary in England is not a separate profession. The judges are chosen from the class of advocates, and almost entirely according to their eminence at the bar. 4. Judges are in England appointed for the most part by the crown. In a few cases municipal corporations may appoint their own judicial officer, and the coroner is elected by the freeholders of the county.

In the United States judges of the supreme courts, as well as ambassadors and other public functionaries, are nominated and appointed by the president with the consent of the Senate, and hold their offices during good behaviour. In the separate States the practice varies, but the tendency is in favour of electing the judges and limiting their tenure of office. In the revised constitution of New York of 1846, the principle was established that all public officers, inclusive of the judges, should be chosen by popular election. "The constitutional provision for making judges elective for short periods by universal suffrage is contagious, and every new constitutional reform or establishment tends that way" (Kent's *Commentaries*, i. 295, where a summary of the practice will be found).

JUDGES, THE BOOK OF, as we now read it, constitutes a sequel to the book of Joshua, covering the period of history between the death of the son of Nuo and the birth of Samuel. But it is well known that the present adjustment of the older historical books of the Old Testament to form a continuous record of events from the creation to the Babylonian exile is due to an editor, or rather to successive redactors, who pieced together and reduced to a certain unity older memoirs of very different dates; and closer examination shows that the continuity of many parts of the narrative is more apparent than real. This is very clearly the case in the book of Judges.

We observe in the first place that the book has two commencements, each of which connects it directly with the book of Joshua (chap. i. 1; ii. 6). But in i. 1 the connexion is merely apparent. The events related in chap. i. are there said to have taken place after the death of Joshua, but in reality the chapter covers the same ground with the book of Joshua, giving a brief account of the conquest of Canaan, which in some particulars repeats the statements of the previous book, while in others it is quite independent. It is impossible to regard the warlike expeditions described in this chapter as supplementary campaigns undertaken after Joshua's death; they are plainly represented as the first efforts of the Israelites to gain a firm footing in the centre of the land (at Hebron, Lebir, Bethel), in the very cities which Joshua in the book that bears his name is related to have subdued (Josh. x. 38). And this is confirmed by the circumstance that in Judges ii. 1 the "angel of Jehovah," who, according to Exod. xiv. 24, xxiii. 20, xxxii. 34, xxxiii. 2, 7 *sq.*, must be viewed as having his local manifestation at the headquarters of the host of Israel, is still found at Gilgal and not at Shiloh (Josh. xviii. 1). Here then we have an account of the first settlement of Israel west of the Jordan which is parallel to the book of Joshua, but makes no mention of Joshua himself, and places the tribe of Judah in the front. The author of the chapter cannot have had Joshua or his history in his eye at all, and the passage,

Josh. xv. 13-19, which corresponds to Judg. i. 10-15, 20, is either derived from our chapter or from an earlier source common to both. It follows from these considerations that the words "Now after the days of Joshua" in Judg. i. 1 are from the hand of the editor, who desired to make the whole book of Judges, including chap. i., read continuously with that which now precedes it in the canon of the earlier prophets.

There are other signs of more than one pen having been engaged on Judges i. Compare, for example, ver. 8 with ver. 21, and see for the details, which are too complicated to be discussed here, Graf, *Der Stamm Simeon*, 1866; Wellhausen-Bleek, *Einführung*, p. 182; Wellhausen, *Geschichte*, i. 366; Meyer, "Die Eroberung Palästinas" in Stade's *Zeitschrift*, 1881, Hft. i. The chapter was written after Israel had become strong enough to make the Canaanite cities tributary (ver. 28), that is, in the time of the kingship. Meyer, following hints by Wellhausen, brings arguments to show that the original author is the Jahwist of the Pentateuch, of whose work there is but little trace among the sources of Joshua, though it cannot have closed without speaking of the conquest.

The second and main section of our book (chap. ii. 6-xvi.) stands on quite another footing. The opening verses ii. 6-9 repeat the closing words of Joshua's history (Josh. xxiv. 28-31), and so link what follows to the book of Joshua as strictly as the first words of Ezra connect that book with the last verses of Chronicles. According to Josh. xxiv. the people "served Jehovah" during the lifetime of the great conqueror and his contemporaries. In Judg. ii. this statement is repeated, and the writer proceeds to explain that subsequent generations fell away from the faith, and served the gods of the nations among which they dwelt. The worship of other gods is represented, not as something which went on side by side with Jehovah worship (compare x. 6), but as a revolt against Jehovah, periodically repeated and regularly chastised by foreign invasion. The history, therefore, falls into recurring cycles, each of which begins with religious corruption, followed by chastisement, which continues till Jehovah in answer to the groans of His oppressed people raises up a judge to deliver Israel, and recall them to the true faith. On the death of the judge, if not sooner, the corruption spreads anew and the same vicissitudes follow. This religious explanation of the course of the history, formally expounded at the outset and repeated in more or less detail from chapter to chapter (most fully in chap. x.), determines the form of the whole narrative, which is grouped round six principal judges, Othniel, Ehud, Deborah, Gideon, Jephthah, and Samson. The intervals between the great judges are filled up by the history of Gideon's son Abimelech and of six minor heroes—Shamgar (following Ehud), Tola and Jair (following Abimelech), Ibzan, Elon, and Abdon (between Jephthah and Samson). The minor judges are not represented as having any immediate religious importance. The cycles of revolt, chastisement, and deliverance are six, not twelve.

To the unity of religious pragmatism in the main stock of the book of Judges corresponds a unity of chronological scheme. The judges, in spite of the fact that most of them had clearly no more than a local influence, are all represented as successive rulers, and the history is dated by the years of each judgeship and those of the intervening periods of oppression. Here, however, a difficulty arises. The fourth year of Solomon is, according to 1 Kings vi. 1, the 480th from the exodus. These 480 years are 12 generations of 40 years each. The larger numbers which make up this total are also mainly reckoned by forties. Moses, Othniel, Ehud, Deborah, Gideon, and the Philistine oppression, in which, according to Judg. xv. 20, Samson's judgeship was but an incident, make up together  $7 \times 40$  years. Again, David has 40 years, and Samuel (who arose to close the Philistine interregnum twenty years after the death of Eli, and continued in office till he was quite old) cannot have ruled much less than a normal generation. Finally Joshua,



who died at the age of 110, ruled 30 years, if in point of age he was a man of the same standing with Caleb (Josh. xiv. 10). Add to these 30 years 6 for Jephthah and 4 for Solomon and we get 10 × 40. There remain but 80 years for the elders who outlived Joshua, the interregna or times of oppression previous to the Philistine period, the minor judges, and Saul. But the interregna alone are 71 years, and the minor judges 70, or with Abimelech 73 or 74. It is plain that there is no room for both in the chronological scheme, and the two series correspond so nearly that they must be held to be alternative items in the reckoning, leaving a slightly different length for Saul's brief reign. But as a matter of fact the minor judges are not so placed in the narrative as to coincide with the periods of oppression. Thus the apparent consecutiveness of the narrative breaks down. The minor judges really lie outside of the chronological scheme of the history as well as of the system of religious cycles; and we infer that even the main stock of the book of Judges is not all constructed by one hand or on a uniform plan.<sup>1</sup>

The religious interpretation of the history corresponds with the prophetic teaching of the 8th century B.C. The use of Baal as a title peculiar to false deities as opposed to Jehovah hardly fits an earlier date than the time of Hosea, and the hostile attitude taken up towards the *asherah* (sacred tree or pole) was not shared by the religious leaders of the period of Jehu. Critics have spoken of chaps. ii. and x. as Deuteronomic, and no doubt the last hand that touched all the earlier historical books and reduced them to unity may be so named; but the main ideas are not necessarily so late, and are rather akin to the non-Levitical Elohist, the author of Josh. xxiv. In particular the worship of the high places is not condemned, nor is it excused as is done in 1 Kings iii. 2.

But the sources of the narrative are obviously much older than the theological exposition of its lessons. The composer of the book has generally transcribed them with little change, so that in reading the story of each great deliverance vouchsafed to Israel we feel ourselves in living contact with the earliest strain of Hebrew patriotism and religion. In this respect the book of Judges is one of the most valuable and interesting in the Old Testament. The song of Deborah and the history of Abimelech carry us back to the beginnings of national life in Israel, when Judah lived outside the main current of the history—the tribe is not even named by Deborah—and when Israelite and Canaanite populations existed side by side and struggled together for supremacy. In these chapters Israel is still in some sense a nation foreign to Canaan, and Jehovah Himself has His seat not on the mountains of Israel but beyond the fields of Edom on the southern heights of Sinai. The importance of such documents for the scientific historian lies not so much in the events they record as in the unconscious witness they bear to the state of things in which the narrator or poet lived. From this point of view all parts of the book are by no means of equal value, and in some instances, particularly in the histories of Deborah and Gideon, critical analysis appears to show that two narratives of different age have been fused together, the older story giving more prominence to ordinary human motives and combinations, while the later version is coloured by religious reflexion, and shows the characteristic tendency of the Old Testament to retell the fortunes of Israel in a form that lays ever increasing weight on the work of Jehovah for His people. \*The history of the minor judges is plainly not related from such lively and detailed remin-

iscence as gives charm to the longer episodes of the book; and some of the names, as Nöldeke (*op. cit.*) and others have shown, are those of personified families or communities rather than of individuals. This indeed is a characteristic feature of the earlier Hebrew history, which older expositors failed to recognize, but which modern science can no longer ignore.

The third and last part of the book embraces chaps. xvii.–xxi., and consists of two narratives independent of one another and of the main stock of the book, with which they are not brought into any chronological connexion. The first narrative, that of Micah and the Danites, belongs to the most primitive strata of the Old Testament history, and is of the highest interest both as a record of the state of religion and for the accurate picture it gives of the way in which one tribe passed from the condition of an invading band into settled possession of land and city. The history of the Levite and the Benjamites is of quite another character, and presupposes a degree of unity of feeling and action among the tribes of Israel which it is not easy to reconcile with the rest of the book. In its present form this episode appears to be not very ancient; it resembles the book of Ruth in giving a good deal of curious archaeological detail (the feast at Shiloh) in a form which suggests that the usages referred to were already obsolete when the narrative was composed.

*Literature.*—On questions of introduction the latest and best investigations are those of Wellhausen in Bleek's *Einleitung*, 4th ed., Berlin, 1878, and in his *Geschichte*, chap. vii. For the historical questions compare also Ewald's *Geschichte*, vol. ii. The most useful modern commentary is that of Studer, Bern, 1835. Later works are those of Bertheau, Leipsic, 1845; Keil, Leipsic, 1863, English translation, 1865; Cassel, in Lange's *Bibelwerk*, Bielefeld, 1865; in the *Speaker's Commentary*; and in Reuss's Bible. On the song of Deborah see Ewald, *Dichter*, i. 1, p. 173, Böttcher, *ATische Bühnendichtungen*, Leipsic, 1850; Kemink, *De Carm. Deb.*, Utrecht, 1840; Meier, *Deborah*, Tübingen, 1859. (W. R. S.)

JUDGMENT is the last stage in an action, being the definitive order or sentence of the court or judge, enforceable by the appropriate mode of "execution" appointed by law. In English law the writ of execution remains in force only for one year unless renewed, but a writ of execution may be obtained at any time within six years of the judgment, and after six years the application may be made to the court by any person entitled to execution, and execution may issue accordingly. Judgments by courts of an alien jurisdiction are not immediately enforceable as judgments in England, but they constitute a cause of action, and may be sued upon. They are in fact conclusive as between the parties, although objections going to deny the jurisdiction of the court, or showing that the defendant had not been summoned and had never really been before it, would be a good defence. It has lately been held no defence to an action in a foreign judgment that it disclosed on the face of it a manifest misapprehension by the foreign court of a rule of English law.

JUDICATURE, JUDICATURE ACTS. The Judicature Acts are an important series of English statutes having for their object to simplify the system of judicature in its higher branches. They are the following:—36 & 37 Vict. c. 66; 37 & 38 Vict. c. 83; 38 & 39 Vict. c. 77; 39 & 40 Vict. c. 59 (the Appellate Jurisdiction Act); 40 & 41 Vict. c. 9.

The movement which ended in the Judicature Acts has been promoted by all the recent holders of the office of Lord Chancellor and by most of the leading judges, but it required a long time to bring it to a successful issue, on account of the difficulty always experienced in creating a sufficient amount of public interest in legal reform to overcome the obstacles to legislation. The principal Judicature Act is framed on the basis of a report by a commission which was appointed in 1867. It was carried in the

<sup>1</sup> The minor details of the chronology appear not to be derived throughout from tradition, but to be got by subdividing the round number 40. See Wellhausen, *op. cit.*, and Nöldeke, *Untersuchungen*, p. 173 sq.

chancellorship of Lord Selborne, but his predecessor Lord Hatherley had in 1870 introduced a measure of the same character. The objects of the Act are threefold—first, to reduce the historically independent courts of common law and equity to one supreme court of judicature, consisting of two branches, a High Court of Justice and a Court of Appeal; secondly, to establish for all divisions of the court a uniform system of pleading and procedure; and, thirdly, to provide for the enforcement of the same rule of law in those cases where chancery and common law had hitherto recognized different rules. The Act does not fuse common law and equity in the sense in which that phrase has generally been employed. The chancery division still remains distinct from the common law division, having a certain range of legal questions under its exclusive control, and possessing to a certain extent a peculiar machinery of its own for carrying its decrees into execution. But all actions may now be brought in the High Court of Justice, and, subject to such special assignments of business as that alluded to, may be tried in any division thereof; and all divisions must recognize the same principles. Further, the difficulties occasioned by mere technicalities of procedure have been to a great extent removed by a system of pleading, the inspiring principle of which is that each party should state his case in the simplest possible manner. It is in respect of the last point that the operation of the Judicature Act has been least satisfactory, and it is certain that a further simplification of pleading, possibly based on the practice of the Scotch courts, will follow very soon.<sup>1</sup>

The appellate part of the judicature has after some hesitation been finally settled thus. The House of Lords remains the last court of appeal, as before the first Judicature Act. That Act abolished the appellate jurisdiction of the Lords so far as the new court of judicature was concerned, leaving it still the appeals from Scotland and Ireland. A temporary Act allowed appeals to be brought from the new court, and the Act 39 & 40 Vict. c. 59 made provisions for the permanent hearing of appeals from all courts to the Lords. The judicial functions of the House of Lords have been virtually transferred to an appeal committee, consisting of the Lord Chancellor and other peers who have held high judicial office, and certain lords of appeal in ordinary created by the Act. No appeal is to be heard unless three of such persons shall be present, and the lords of appeal may sit for the despatch of judicial business during a prerogation of parliament, and even by order of the queen during a dissolution. The lords of appeal in ordinary are an entirely new creation. They hold office on the same conditions as other judges; they take rank as barons for life; but they are entitled to a writ of summons to attend and vote in the House only so long as they hold office, and their dignity does not descend to their heirs. Two are appointed in the first instance, but an arrangement is provided for by which the four head judges of the privy council may ultimately be the four lords of appeal in ordinary. When two of the privy council judges die or resign, a third lord of appeal may be appointed, and a fourth when the remaining two judges of the privy council cease to hold office. The judicial committee of the House of Lords and the judicial committee of the privy council will then be the same, and the two jurisdictions will be fused. The Court of Appeal, created by the Judicature Act of 1873, with intention of making it a final court, is now subject to an appeal to the House of Lords. It now consists of six judges, and sits in two divisions, which, roughly speaking, take respectively the chancery and common law

business of the divisional courts, but the lords justices of appeal sit in either division according to convenience. This part of the rearrangement of the judicature may be pronounced entirely successful. A strong and stable court of appeal has been created, instead of the fluctuating tribunal of former times. The same is true generally of the redistribution of judicial strength effected by the Acts, which has led to a marked improvement in the despatch of business.

The Irish Judicature Act (40 & 41 Vict. c. 57) follows the same lines as the English Acts. The pre-existing courts are consolidated into a supreme court of judicature, consisting of a High Court of Justice and a Court of Appeal. The Judicature Acts do not affect Scotch judicature, but the Appellate Jurisdiction Act includes the Court of Session among the courts from which an appeal lies to the House of Lords under the new conditions. (E. R.)

JUDITH, THE BOOK OF, one of the books of the Old Testament APOCRYPHA (*q.v.*), takes its name from the heroine Judith (Ἰουδίθ, Ἰουδῆθ, *i.e.*, Ἰουδαῖα, "Jewess"), to whom the last nine of its sixteen chapters relate. In the Septuagint and Vulgate it immediately precedes Esther, and along with Tobit comes after Nehemiah; in the English Apocrypha it is placed between Tobit and the apocryphal additions to Esther. The argument of the book is briefly as follows. In the twelfth year of his reign Nebuchadnezzar, who is described as king of Assyria, having his capital in Nineveh, makes war against Arphaxad (*i.e.*, the district Arrhapachitis), king of Media, and overcomes him in his seventeenth year. He then despatches his chief general Holofernes to take vengeance on the nations of the west who had withheld their assistance. This expedition has already succeeded in its main objects when Holofernes proceeds to attack Judæa. The children of Israel, who are described as having newly returned from captivity, are apprehensive of a desecration of their sanctuary, and resolve on resistance to the uttermost. The inhabitants of Bethulia (Betylūa) and Betemestham in particular (neither place can be identified), directed by Joachim the high priest, guard the mountain passes near Dothaim, and place themselves under God's protection. Holofernes now inquires of the chiefs who are with him about the Israelites, and is answered by Achior the leader of the Ammonites, who enters upon a long historical narrative showing the Israelites to be invincible except when they have offended God. For this Achior is punished by being handed over to the Israelites, who lead him to the governor of Bethulia. Next day the siege begins, and after forty days the famished inhabitants urge the governor Ozias to surrender, which he consents to do unless relieved in five days. Judith, a beautiful and pious widow of the tribe of Simcon, now appears on the scene with a plan of deliverance. Wearing her rich attire, and accompanied by her maid, who carries a bag of provisions, she goes over to the hostile camp, where she is at once conducted to the general, whose suspicions are disarmed by the tales she invents. After four days Holofernes, smitten with her charms, at the close of a sumptuous entertainment invites her to remain within his tent over night. No sooner is he overcome with sleep than Judith, seizing his sword, strikes off his head and gives it to her maid; both now leave the camp (as they had previously been accustomed to do, ostensibly for prayer) and return to Bethulia, where the trophy is displayed amid great rejoicings and thanksgivings. Achior now publicly professes Judaism, and at the instance of Judith the Israelites make a sudden onslaught on the enemy, who at once give way, leaving immense spoil in the hands of the victors. Judith now sings a song of praise, and all go up to Jerusalem to worship with sacrifice and rejoicing. The book concludes with a brief

<sup>1</sup> Pleading, it should be stated, to prevent a possible confusion, means the written statements of complaint and defence made by the parties before the case comes to trial.



notice of the closing years of the heroine, who returned to her native place and lived to the age of one hundred and five years.

Formerly the majority of interpreters were inclined to assign a strictly historical character to the foregoing narrative, although its historical, chronological, and even geographical difficulties were not overlooked; but this view has to a large extent been superseded by that of most recent critics, who, following Buddens, regard it as a romance written with a patriotic and moral purpose by some imperfectly informed Jew of the Maccabæan period who wished to raise the zeal of his compatriots to the fighting point on behalf of their religion and worship against an overbearing enemy. Volkmar stands alone in treating it as a veiled account of the campaigns of Trajan and his generals against the Parthians and Jews.

According to Origen the book was unknown to the Jews, and did not exist in Hebrew. The extant Greek text, however, which exists in three divergent recensions, shows unmistakable traces of a Hebrew original, even apart from certain expressions which can only be explained as ignorant mistranslations. But that original must have differed considerably from the Chaldee text which lay before Jerome, and was used by him for his new Latin version.

The first express reference to Judith occurs in Clement of Rome (1 *Ad Cor.*, cap. 55); it is cited as Scripture by Clement of Alexandria, Tertullian, Ambrose, and Augustine, and was recognized as canonical by the council of Carthage, and by Innocent I. of Rome.

See Schürer, *NTliche Zeitgesch.*, and De Wette-Schrader, *Einleitung*; in both works full bibliographies are given. The most important commentary is that of Fritzsche in the *Exegetisches Handbuch* (1853).

JUDSON, ADONIRAM (1788-1850), was born at Malden, Massachusetts, August 9, 1788. During his education at Andover theological seminary he formed the resolution to become a missionary, and in 1812 he was ordained a missionary to Burmah under the auspices of the Congregational Board of Foreign Missions. Having after his arrival in India adopted Baptist views, he was appointed to labour in Burmah by the American Baptist Missionary Union in 1814. His translations of the Bible into Burmese appeared in 1835, and his *Burmese and English Dictionary* in 1852. He died April 12, 1850. Both in his literary and his missionary labours he was greatly assisted by the three ladies whom he successively married, of whom as well as of Judson biographies have been published.

JUGURTHA. After the final conquest of Carthage by the Romans in 146 B.C., the larger part of the north of Africa was practically under Roman control. The so-called province, indeed, of Africa, as then constituted, was but a small strip of territory, comprising the possessions retained by Carthage during the few years previous to her downfall. It coincided with the north-eastern portion of Tunis. Around it, to the west, south, and east, was the region to which the Romans gave the name of Numidia, the country of the "Nomads," which stretched westwards to Mauretania, the river Malucha (Malūwi), which flows into the gulf of Melillah, being here roughly its boundary, and eastwards to the Great Syrtis, thus bordering on Cyrene and Egypt. We may say that Numidia corresponds with what is now Algiers, the south of Tunis, and Tripoli, including in addition a region of indefinite extent to the south. Over this extensive territory, parts of which were rich and populous, Masinissa had ruled for many years, and had rendered Rome substantial aid in her war with Carthage. On his death in 149 B.C. his sovereign power was divided under the direction of Scipio Africanus the younger, the conqueror of Carthage, between his three sons Micipsa, Gulussa, and Mastanabal. The actual government, how-

ever, was chiefly in the hands of an illegitimate son of Mastanabal, Jugurtha. The Numidian princes were by no means mere barbarous chiefs. Micipsa, though too weak to be a king, is said to have been imbued with a considerable tincture of Greek philosophy, and Jugurtha's father too was a man of some literary culture. Jugurtha himself had many of the qualities which command success. He was strong and active; he had a handsome face and keen intelligence; he was a skilful rider, and was a thorough adept in all warlike exercises. In fact, he was in many respects a very worthy grandson of Masinissa, and he inherited much of his political ability and adroitness. Micipsa was naturally rather afraid of him, and knowing his military tastes he sent him to Spain in command of a Numidian force, to serve under Scipio, who was then engaged in the war with Numantia. Jugurtha soon won Scipio's good opinion, and he became a favourite with the Roman nobles serving in the camp, some of whom put into his head the idea of making himself the sole king of Numidia, hinting that at Rome anything could be done for money. There was truth in the hint, as subsequent events proved.

In 118 B.C. Micipsa died. He had thought it politic to adopt Jugurtha, and to provide by his will that he should be associated with his own two sons, Adherbal and Hiempsal, in the government of Numidia. Scipio had written to Micipsa a strong letter of recommendation in favour of Jugurtha; and to Scipio, accordingly, Micipsa entrusted the execution of his will. His testamentary arrangements thus had the Roman guarantee, but they utterly failed. The princes soon quarrelled; and Jugurtha, who was thoroughly unscrupulous, claimed the entire kingdom. His cousin Hiempsal he contrived to have assassinated; and Adherbal he quickly drove out of Numidia by force of arms, compelling him to take refuge in the Roman province of Africa. He had next the audacity to send envoys to Rome to defend his usurpation. Hiempsal, they were to say, had been murdered by his subjects for his cruelty, and Adherbal, who was now at Rome to get redress, had been himself the aggressor. The senate decided that Numidia was to be divided between the two princes, and the division, which was arranged under the superintendence of Roman commissioners, gave the western, the richest and most populous half of the country, to Jugurtha, while the sands and deserts of the eastern half were left to Adherbal. Jugurtha's envoys appear to have found several of the Roman nobles and senators accessible to judicious bribery. So far, however, was he from being satisfied with having secured the best of the bargain that he at once began to molest Adherbal's dominions and to provoke him to a war of self-defence. He so completely defeated him, somewhere near, it would seem, the modern Philippeville, that Adherbal sought safety in Cirta (Constantina), the chief town of Numidia, and a very strong fortress. Here he was besieged by Jugurtha, who, notwithstanding the interposition of a Roman embassy headed by Marcus Scaurus, a leading Roman senator, ultimately forced the place to capitulate, and then treacherously massacred all the inhabitants, his cousin Adherbal among them, and a number of Italian merchants who had settled in the town. There was great wrath at Rome and throughout all Italy; and the senate, a majority of which still clung to Jugurtha in spite of the proof they had just had of his atrocious treachery and cruelty, were persuaded in the same year, 111 B.C., on the motion of the tribune Caius Memmius, to allow a declaration of war against the Numidians. An army was despatched to Africa under the command of the newly elected consul, Calpurnius Bestia, and several of the Numidian towns voluntarily surrendered, while Bocchus, the king of Mauretania, and Jugurtha's father-in-law, offered the Romans his alliance.

Jugurtha was alarmed, but, having plenty of money at his command out of the accumulated treasures of his grandfather Masinissa, he again acted on his experience of Roman venality, and he was successful in arranging for himself with the Roman general a peace which left him in undisturbed possession of the whole of Numidia. When the facts were known at Rome, the tribune Memminus insisted that Jugurtha should appear in person and be questioned as to the precise nature of the negotiations. Jugurtha indeed appeared under a safe conduct, but he had partisans who took care that his mouth should be closed. The treaty, however, was set aside, and war was again declared, Spurius Albinus, the new consul, having the command. The Roman army in Africa was thoroughly demoralized, and quite unfit to take the field. An unsuccessful attempt was made on a fortified town, Suthul, in which the royal treasures were deposited. Worse followed: the army was surprised by the enemy in a night attack, and the camp was taken and plundered. Jugurtha was master of the situation, and every Roman was driven out of Numidia.

By this time the feeling at Rome and in Italy against the corruption and incapacity of the nobles had become so strong that prosecutions on a wholesale scale struck down a number of the senators, and Bestia and Albinus were sentenced to exile. The Numidian war was now entrusted to Quintus Metellus, an aristocrat indeed in sentiment, but at the same time an able soldier and a stern disciplinarian. With him was associated the famous Caius Marius, who had risen from the rank of a centurion. The army was soon in a condition to face the enemy, and from the year 109 B.C. to the close of the war in 106 the contest was carried on with credit to the Roman arms. Jugurtha was defeated in an action on the river Muthal, after an obstinate resistance and a display of much military skill. Once again he even succeeded in surprising the Roman camp and forcing Metellus into winter quarters. There were fresh negotiations, but Metellus insisted on the surrender of the king's person, and this Jugurtha refused. Numidia on the whole seemed disposed to assert its independence, and Rome had before her an indefinite prospect of a long and troublesome guerilla war. The country was a particularly trying one for a regular army, and a victory seemed to lead to no substantial result. Nothing could be really accomplished unless Jugurtha himself could be secured; and to this end negotiations, reflecting little credit on the Romans, were set on foot with Bocchus, who for a time, as his interest seemed to dictate, played fast and loose with both parties. The war dragged on till in 106 B.C. Marius was called on by the vote of the Roman people to supersede Metellus. Marius found that he had a difficult work, and his army was once seriously imperilled on the borders of Mauretania, whither he had led them to overawe Bocchus, who had just made a friendly treaty with Jugurtha. Shortly afterwards this cunning and treacherous prince again offered his friendship to the Romans, and it was through his perfidy and not by Roman skill or valour that the war with Jugurtha was ended. In the final negotiations Lucius Sulla, who was Marius's questor and commanded the cavalry, had the honour, such as it was, of winning over to the Roman side the king of Mauretania, and prevailing on him to sacrifice Jugurtha. The Numidian fell into an ambush through his father-in-law's treachery, and was conveyed a prisoner to Rome. Two years afterwards, in 104 B.C., he figured with his two sons in Marius's triumph, and in the subterranean prison beneath the Capitol, "the bath of ice," as he called it, he was either strangled or starved to death. The war had been an inglorious one for Rome, and its end with all its attendant circumstances was deplorably disgraceful.

Jugurtha, though doubtless for a time regarded by his African and Numidian countrymen as their deliverer from the yoke of Rome, mainly owes his historical importance to the very full and minute account of him which we have from the hand of Sallust, himself afterwards governor of Numidia. The Jugurthine war too happened to coincide with a period of considerable political interest at Rome. The symptoms of revolution were beginning to make themselves visible. The weakness and corruption of the government of the senate was forcing itself on the notice of all men, and popular opinion was becoming too strong to be disregarded. One general after another had been superseded and disgraced, and Marius, a man of the humblest origin, had been summoned by the public voice to put an end to a war in which the incapacity and disloyalty of consuls and senators had been grievously exposed. The names of both Marius and Sulla became famous for the first time in a struggle with a Numidian chief. The time was clearly at hand when the old system of Rome's government could sustain itself no longer.

The best modern account of Jugurtha and the Jugurthine war is to be found in Mommsen, *Hist. of Rome*, book iv. chap. v. (W. J. B.)

**JUJUBE.** Under this name the fruits of at least two species of *Zizyphus* are usually described, namely, *Z. vulgaris* of Lamark and *Z. Jujuba* of the same author. The species of *Zizyphus* are for the most part small trees or shrubs, armed with sharp, straight, or hooked spines, having alternate leaves and fruits, which are in most of the species edible, and have an agreeable acid taste; this is especially the case with those of the two species mentioned above.

*Z. vulgaris* is a tree about 20 feet high, extensively cultivated in many parts of southern Europe, Asia, Spain, the south of France, and Italy, also in western Asia, China, and Japan. In India it extends from the Punjab to the western frontier, ascending in the Punjab Himalaya to a height of 6500 feet, and is found both in the wild and cultivated state. The plant is grown almost exclusively for the sake of its fruit, which both in size and shape resembles a moderate sized plum; at first the fruits are green, but as they ripen they become of a reddish-brown colour on the outside and yellow within. They ripen in September, when they are gathered and preserved by storing in a dry place; after a time the pulp becomes much softer and sweeter than when fresh. Jujube fruits when carefully dried will keep for a long time, and retain their agreeable refreshing acid flavour, on account of which they are much valued in the countries of the Mediterranean region as a winter dessert fruit; and, besides, they are nutritive and demulcent. At one time a decoction was prepared from them and recommended in pectoral complaints. A kind of thick paste, known as jujube paste, was also made of a composition of gum arabic and sugar dissolved in a decoction of jujube fruit evaporated to the proper consistency. The fruits of the *Zizyphus* do not enter into the composition of the lozenges now known as jujubes.

The second species of *Zizyphus* referred to above, viz., *Z. Jujuba*, is a tree averaging from 30 to 50 feet high, found both wild and cultivated in many parts of the tropics, as in China, Australia, the Malay archipelago, Ceylon, throughout India, and in tropical Africa. Many varieties of this tree are known to and cultivated by the Chinese, who distinguish them by the shape and size of their fruits, which are produced in abundance, and are not only much valued as dessert fruit in China, but are also occasionally exported to England.

As seen in commerce jujube fruits are about the size of a small filbert, having a reddish-brown, shining, somewhat wrinkled exterior, and a yellow or gingerbread-colored pulp enclosing a hard elongated stone.



**JUKES, JOSEPH BEETE** (1811–1869), geologist, was born near Birmingham, October 10, 1811. Educated first at Wolverhampton grammar-school and afterwards at King Edward's School, Birmingham, he passed in 1830 to St John's College, Cambridge, where he graduated in 1836. At Cambridge he began the study of geology under Sedgwick, and in 1839, after three years of study, lecturing, and writing, he was appointed geological surveyor of Newfoundland. He returned to England at the end of 1840, and in April 1842 sailed as naturalist on board H.M.S. "Fly," despatched to survey Torres Strait, New Guinea, and the east coast of Australia. Jukes landed in England again in June 1846, and in August received an appointment to the geological survey of Great Britain. The district to which he was sent was North Wales. In 1850 he accepted the post of local director of the geological survey of Ireland. The exhausting nature of his work slowly but surely wore out even his robust constitution, and on July 29, 1869, he died. Immediately on leaving college, Jukes became a member of the London Geological Society, and in 1852 he was admitted to the Dublin Geological Society, of which he was president in 1853 and 1854. He was also a Fellow of the Royal Society. For many years he lectured as professor of geology, first at the Royal Dublin Society's Museum of Irish Industry, and afterwards at the Royal College of Science in Dublin.

In addition to the reports of his various appointments, Jukes wrote very many papers and memoirs, to be found in the London and Dublin geological journals and other periodicals. While in Ireland he edited, and in great measure wrote, forty-two memoirs explanatory of the maps of the south, east, and west of Ireland, and prepared a geological map of Ireland on a scale of 8 miles to an inch. He was also the author of *Excursions in and about Newfoundland*, 2 vols., 1842; *Narrative of the Surveying Voyage of H.M.S. "Fly,"* 2 vols., 1847; *A Sketch of the Physical Structure of Australia*, 1848; *Popular Physical Geology*, 1853; *On the Geology of Australia*, 1853; *Student's Manual of Geology*, 1857 (later editions, 1862, 1872); the article *Geology*, in the 8th edition of the *Encyclopædia Britannica*, 1858; and *School Manual of Geology*, 1863. See *Letters, &c., of J. Beete Jukes, edited, with connecting memorial notes, by his sister (C. A. Brown)*, 1871, to which is added a chronological list of Jukes's writings.

**JULIAN** (331–363), commonly called Julian the Apostate, was Roman emperor for about a year and eight months (361–363). His full name was Flavius Claudius Julianus. He was born at Constantinople in 331, being the son of Julius Constantius and his wife Basilina, and nephew of Constantine the Great. He was thus a member of the dynasty under whose auspices Christianity became the established religion of Rome.

Julian lost his mother not many months after he was born. He was only six when his imperial uncle Constantine died; and one of his earliest memories must have been the fearful massacre of his father and kinsfolk, in the interest and more or less at the instigation of the sons of Constantine. Only Julian and his elder brother Gallus were spared, as they were too young to excite the fear or justify the cruelty of the murderers. From this period till his twenty-fifth year Julian passed his life in the closest retirement, jealously watched by the reigning emperor, often under immediate fear of death. He was carefully educated, however, under the supervision of the family eunuch Mardonius, and of Eusebius, bishop of Nicomedia, at Constantinople itself and at various places in Ionia and Bithynia, and afterwards for six years at Macellum, a remote and lonely castle in Cappadocia. He was trained to the profession of the Christian religion; but he became early attracted to the old faith, or rather to the idealized amalgam of paganism and philosophy which was current among his teachers, the rhetoricians. Cut off from all sympathy with the reigning belief by the terrible fate of his family, and with no prospect of a public career, he turned with all the eagerness of an enthusiastic temperament to the literary

and philosophic studies of the time. The old Hellenic world had an irresistible attraction for him. Love for its culture was in Julian's mind intimately associated with loyalty to its religion.

In the meantime the course of events had left as sole autocrat of the Roman empire his cousin Constantius, who felt himself unequal to the enormous task, and called Julian's brother Gallus to a share of power. The same turn of affairs brought a great improvement in the condition of Julian, who was permitted to pursue his studies at Nicomedia. Here he made the acquaintance of some of the most eminent rhetoricians of the time, and here it was that he became confirmed in his secret devotion to the pagan faith. But the downfall of Gallus (354) yet again exposed Julian to the greatest danger. By his rash and headstrong conduct Gallus had incurred the enmity of Constantius and the eunuchs, his confidential ministers, and was put to death. Julian fell under a like suspicion, and narrowly escaped the same fate. For some months he was confined at Milan, till at the intercession of the empress Eusebia, who always had a kindness for him, he was permitted to retire to Athens (355). The few months he spent here were probably the happiest of his life. Living at the ancient hearth of Grecian culture, and amid the companionship of congenial friends, he found his dearest ambition realized in the enthusiastic study of literature and philosophy.

But a member of the Roman imperial house could not thus be allowed to escape the public responsibilities connected with his birth. The emperor Constantius and he were now the sole surviving male members of the family of Constantine; and, as the emperor again felt himself oppressed by the cares of government, there was no alternative but to call Julian to his assistance. At the instance of the empress, he was summoned to Milan; and there from Constantius, who had been chiefly concerned in the murder of his family, he received the hand of Helena, sister of the emperor, as also the title of Cæsar and the government of Gaul. It was with extreme reluctance that Julian entered on his new dignities. Accustomed to a life of quiet study and retirement, he felt timid and awkward in the world of ceremony, suspicion, and intrigue to which he was now introduced. He knew well the danger to which he was exposed from the dark temper of the emperor and the arts of the eunuchs who were all-powerful at the court.

A task of extreme difficulty also awaited him beyond the Alps. During recent troubles the Alemanni and other German tribes had crossed the Rhine; they had burned Cologne, Treves, Strasburg, and many other flourishing cities, and extended their ravages far into the interior of Gaul. The internal government of the province had also fallen into great confusion. In spite of his inexperience, and by virtue of his native energy and ability, Julian quickly brought affairs into order. He completely overthrew the Alemanni in the great battle of Strasburg (357). The Frankish tribes which had settled on the western bank of the lower Rhine were reduced to submission. Five times in all he crossed the river to overawe the restless tribes beyond. In Gaul he rebuilt the cities which had been laid waste, re-established the administration on a just and secure footing, and as far as possible lightened the taxes, which weighed so heavily on the poor provincials. Paris was the usual residence of Julian during his government of Gaul, and his name has become inseparably associated with the early history of the city.

The position and reputation of Julian were now established. He was general of a victorious army enthusiastically attached to him, and governor of a province which he had saved from ruin; but he had also become an object of fear and jealousy at the imperial court. It was accordingly

resolved to weaken his power. A threatened invasion of the Persians was made an excuse for withdrawing some of the best legions from the Gallic army. Julian recognized the covert purpose of this, yet proceeded to fulfil the commands of the emperor. A sudden movement of the legions themselves decided otherwise. At Paris, on the night of the parting banquet, they forced their way into Julian's tent, and, proclaiming him emperor, offered him the alternative either of accepting the lofty title or of instant death. Julian accepted the empire, and sent an embassy with a deferential message to Constantius. The message being contemptuously disregarded, both sides prepared for a decisive struggle. After a march of unexampled rapidity through the Black Forest and down the Danube, Julian reached Sirmium, and was on the way to Constantinople, when he received news of the death of Constantius at Mompsoene in Cilicia (361). Without further trouble Julian found himself everywhere acknowledged the sole ruler of the Roman empire.

Julian had already made a public avowal of paganism, of which he had been a secret adherent from the age of twenty. It was no ordinary profession, but the expression of a strong and even enthusiastic conviction; the restoration of the pagan worship was to be the great aim and controlling principle of his government. His reign was too short to show what precise form the pagan revival might ultimately have taken, how far his feelings might have become embittered by his conflict with the Christian faith, whether persecution, violence, and civil war might not have taken the place of the moral suasion which was the method he originally affected. He issued an edict of universal toleration; but in many respects he used his imperial influence unfairly to advance the work of restoration. In order to deprive the Christians of the advantages of culture, and discredit them as an ignorant sect, he forbade them to teach rhetoric. The symbols of paganism and of the imperial dignity were so artfully interwoven on the standards of the legions that they could not pay the usual homage to the emperor without seeming to offer worship to the gods; and, when the soldiers came forward to receive the customary donative, they were required to throw a handful of incense on the altar. Without directly excluding Christians from the high offices of state, he held that the worshippers of the gods ought to have the preference. In short, though there was no direct persecution, he exerted much more than a moral pressure to restore the power and prestige of the old faith.

Having spent the winter of 361-2 at Constantinople, Julian proceeded to Antioch to prepare for his great expedition against Persia. His stay there was a curious episode in his life. Strange to say, it is doubtful whether his pagan convictions or his ascetic life, after the fashion of an antique philosopher, gave most offence to the so-called Christians of the dissolute city. They soon grew heartily tired of each other, and Julian took up his winter quarters at Tarsus, from which in early spring he marched against Persia. At the head of a powerful and well-appointed army he advanced through Mesopotamia and Assyria as far as Ctesiphon, near which he crossed the Tigris, in face of a Persian army which he defeated. Misled by the treacherous advice of a Persian nobleman, he desisted from the siege of that great city, and set out to seek the main army of the enemy under King Sapor. After a long and useless march into the interior he was forced to retreat, when he found himself enveloped and harassed by the whole Persian army, in a waterless and desolate country, and at the hottest season of the year. The Romans repulsed the enemy in many an obstinate battle. In one of these, however, on the 26th of June 363, Julian, who was ever in the front, was mortally wounded. The same night he

died in his tent. In the most authentic historian of his reign, Ammianus Marcellinus, we find a noble speech, which, like Socrates in the prison, he is said to have addressed to his afflicted officers. Jovianus was chosen emperor by the army, which was extricated from its perilous situation only by a very disadvantageous treaty.

From Julian's unique position as the last champion of a dying polytheism, his character has ever excited interest and been the subject of debate. Authors such as Gregory of Nazianzus have heaped the fiercest anathemas upon him; but a just and sympathetic criticism, like Neander's, has found many noble qualities in his character and ample excuse for his leanings to a philosophic paganism. In his childhood he had seen his nearest kinsmen massacred by the heads of the new Christian state; till the age of twenty-five he held his life on sufferance, and passed it in obscurity under the most rigid and suspicious surveillance. The only sympathetic friends he met were among the heathen rhetoricians and philosophers; and he found a suitable outlet for his restless and inquiring mind only in the studies of ancient Greece. In this way he was attracted to the old paganism; but it was a paganism idealized by the philosophy of the time, and still further purified by the moral influence of the Christianity which it rejected.

In other respects Julian was no unworthy successor of the Antonines. Though brought up in a studious and pedantic solitude, he was no sooner called to the government of Gaul than he displayed all the energy, the hardihood, and the practical sagacity of an old Roman. In temperance, self-control, and zeal for the public good, as he understood it, he was unsurpassed. To these Roman qualities he added the culture, literary instincts, and speculative curiosity of a Greek. One of the most remarkable features of his public life was the perfect ease and mastery with which he associated the cares of war and statesmanship with the assiduous cultivation of literature and philosophy. Yet even his devotion to culture was not free from pedantry and dilettantism. His contemporaries observed in him a want of naturalness. He had not the moral health or the composed and reticent manhood of a Roman, or the unself-conscious spontaneity of a Greek. He could never be at rest; he never could hold his tongue; in the rapid torrent of his conversation he was apt to run himself out of breath; his manner was jerky and spasmodic. He showed quite a deferential regard for the sophists and rhetoricians of the time, and advanced them to high offices of state; there was real cause for fear that he would introduce the government of pedants in the Roman empire. Last of all, his love for the old philosophy was sadly disfigured by his devotion to the old superstitions, and in this respect he little pleased the taste of a judge like Gibbon. He was greatly given to divination; he was noted for the number of his sacrificial victims. Wits applied to him the joke that had been passed on Marcus Aurelius: "The white cattle to Marcus Caesar, greeting. If you conquer, there is an end of us."

Julian wrote several works, including—(1) *Letters*, eighty-three of which are preserved in the edition of Heyler, Mainz, 1828 (most of these are addressed to men of letters); (2) *Oration*s, nine in number; (3) *Καίσαρες ἢ Συναρόσιον*, a satirical composition, in which the dead Cæsars appear at a banquet prepared in the heavens, and have to endure the caustic wit of old Silenus; (4) *Ἀντιοχείας ἢ Μισσοῦργον*, a *jeu d'esprit* on the inhabitants of Antioch, in which also his own person and mode of life are jocularly handled. The most important of his works, the *Κατὰ Χριστιανῶν*, has been lost, except the fragments preserved in the refutation by Cyril, latest edition by Neumann, 1881. The best edition of his entire works used to be that of Spanheim, Leipsic, 1696; the most recent is that of Hertlein in the Teubner series, Leipsic, vol. i. in 1876.

Of the primary sources for Julian's life and character the most important are his own works; the trustworthy and impartial historian of the period, Ammianus Marcellinus, v. 25-xxv.; the letters and orations of Julian's much-esteemed friend Libanius; and the orations of his severest critic, Gregory of Nazianzus. The impression which Julian's career produced on the Christians of the East is



reflected in two Syriac romances published by J. G. E. Hoffmann (*Julianos der Abtrünnige*, Leyden, 1880). Compare Nöldeke, in *Z. D. M. G.*, 1874, vol. xxviii., p. 263 sq., 666 sq. Modern authorities are—Gibbon's *Decline and Fall*; Neander, *Der Kaiser Julian und sein Zeitalter*, Leipzig, 1813, English translation by G. V. Cox; D. P. Strauss, *Der Romantiker auf dem Throne der Cäsaren oder Julian der Abtrünnige* (*Gesam. Schriften*, vol. I., Bonn, 1876); Semisch, *Julian der Abtrünnige*; Rodé, *Geschichte der Reaction K. Julians gegen die christliche Kirche*; H. Adrien Naville, *Julien l'Apostat*, Paris, 1877; and the Hulsean essay for 1876 by G. H. Reudill. (T. K.)

JÜLICH (Fr., *Juliers*), the chief town of a circle in the government district of Aachen, Prussia, and capital of the former duchy of Jülich, situated on the right bank of the Roer, about 16 miles north-east of Aachen (Aix-la-Chapelle). It contains three churches, a gymnasium, and a military school, and has manufactures of leather, paper, and wood. The population in 1875 was 5111.

Jülich (formerly also Gulch, Guliche) is the Juliacum of the *Antonine Itinerary*; some have attributed its origin to Julius Cæsar. From the 9th century it appears several times in history, generally as the scene of siege. From 1794 till 1815 it was in the hands of the French. Till 1860, when its works were demolished, Jülich ranked as a fortress of the second class.

JULIEN, NOËL (1797–1873), afterwards called STANISLAS-AIGNAN JULIEN, was born at Orleans April 13, 1797. His father, who was a mechanic, being desirous of improving the position of his son, destined the young Stanislas-Aignan for the priesthood, and in preparation for that calling sent him to the seminary in his native town. Here his extraordinary talent for the acquisition of languages first displayed itself, and with his knowledge increased his repugnance to the profession marked out for him. His favourite study at this time was Greek literature, and so recognized did his scholarship become that, when he went to Paris in 1821, he received the appointment of assistant professor of Greek at the Collège de France. In the same year he published a translation of the *Ἐλέγους ἀπραγῆ* of Coluthus, of which work he subsequently brought out a new edition, with a Latin version and notes. In later years he was in the habit of saying that it was as the author of this work that he would be best known by posterity,—another instance of the common inability of authors to judge correctly of the relative merits of their works. At this period his attention was drawn to the lectures being delivered by Abel Rémusat on the Chinese language, and being attracted to the study he placed himself under the tuition of that professor. In this new pursuit his progress was as marked and as rapid as formerly in Greek. From the first he, as if by intuition, thoroughly mastered the genius of the language; and the complexity of the characters and the peculiarities of construction, which to others have always presented serious difficulties, at once yielded to his ability and diligence. In 1823 he published a translation in Latin of a part of the works of Mencius, one of the nine classical books of the Chinese, and, though this volume appeared within two years of his having taken up the study of the language, it justified its publication by its success. A year later he produced a translation of the modern Greek odes of Kalvos under the title of *La Lyre patriotique de la Grèce*. But such works were not profitable in a commercial sense, and, being without any patrimony, Julien was glad to accept the assistance of Sir William Drummond and others, until in 1827 he was appointed sub-librarian to the French Institute. In 1831 he was elected a member of L'Académie des Inscriptions et Belles-Lettres de l'Institut de France in the place of Saint-Martin, and in the following year he succeeded Rémusat as professor of Chinese at the Collège de France. For some years his studies had been directed towards the dramatic and lighter literature of the Chinese, and in rapid succession he now brought out translations of the *Hoei-lan-ki*, or "L'histoire du cercle de craie," a drama in which occurs a curiously analogous scene to the judgment of Solomon; the *Pih shay tsing ki*; *Blanche et Bleue*, ou les deux couleurs j'és; and the *Tchao-chi kou eul*, upon

which Voltaire subsequently founded his *Orphelin de la Chine*. With the versatility which belonged to his genius, he next turned, apparently without difficulty, to the very different style common to Taoist writings, and translated in 1835, for the Oriental Translation Fund, *Le Livre des Récompenses et des Peines* of Laou-tsze. About this time the cultivation of silk-worms was beginning to attract attention in France, and by order of the minister of agriculture Julien compiled, in 1837, a *Résumé des principaux traités Chinois sur la culture des mûriers, et l'éducation des vers-à-soie*, which was speedily translated into English, German, Italian, and Russian.

Nothing was more characteristic of his method of studying Chinese than his habit of collecting every peculiarity of idiom and expression which he met with in his reading; and, in order that others might reap the benefit of his experiences, he published in 1841 a work entitled *Discussions grammaticales sur certaines règles de position qui, en Chinois, jouent la même rôle que les inflexions dans les autres langues*, which he followed in 1842 by *Exercices pratiques d'analyse, de syntaxe, et de lexicographie Chinoise*. Meanwhile in 1839 he had been appointed joint keeper of the Bibliothèque Royal, with the especial superintendence of the Chinese books, and shortly afterwards he was made Administrateur du Collège de France.

The facility with which he had learned Chinese, and the success which his proficiency commanded, naturally inclined other less gifted scholars to resent the impatience with which he regarded the mistakes into which they fell in their translations from this most difficult language, and at different times bitter controversies arose between Julien and his fellow Sinologues on the one subject which they had in common. How envenomed were the disputes which thus arose may be gathered from the following title of a work published in 1842 by Julien, *Simple exposé d'un fait honorable odieusement dénaturé dans un libelle récent de M. Pauthier, suivi de la réfutation de sa dernière réponse, du résumé analytique de plus de 600 fautes qu'il n'a pas su justifier, et de l'examen de certains passages où Païde desquels il a prétendu prouver que des Egyptiens ont porté en Chine l'invention de l'écriture 2253 ans avant J. C.* In the same year appeared from his busy pen a translation of the *Tao te King*, the celebrated work in which Laou-tsze attempted to explain his idea of the relation existing between the universe and something which he called *Tau*, and on which the religion of Taoism is based. From Taoism to Buddhism was a natural transition, and about this time Julien turned his attention to the Buddhist literature of China, and more especially to the travels of Buddhist pilgrims to India. In order that he might better understand the references to Indian institutions, and the transcriptions in Chinese of Sanskrit words and proper names, he began the study of Sanskrit, and in 1853 brought out his *Voyages des Pèlerins Bouddhistes*, the value of which work is much enhanced by the fruits of this new instance of his extraordinary mental enterprise. The same remark applies to the work which he published six years later entitled *Les Avadânas, contes et apologues Indiens inconnus jusqu'à ce jour, suivis de poésies et de nouvelles Chinoises*. For the benefit of future students he disclosed his system of deciphering Sanskrit words occurring in Chinese books in his *Méthode pour déchiffrer et transcrire les noms Sanscrits qui se rencontrent dans les livres Chinois* (1861). This work, which contains much of interest and importance, falls short of the value which its author was accustomed to attach to it. It had escaped his observation that, since the translations of Sanskrit works into Chinese were undertaken in different parts of the empire, the same Sanskrit words were of necessity differently represented in Chinese characters in accordance with the

dialectical variations. No hard and fast rule can therefore possibly be laid down for the decipherment of Chinese transcriptions of Sanskrit words, and the effect of this impossibility was felt though not recognized by Julien, who in order to make good his rule was occasionally obliged to suppose that wrong characters had by mistake been introduced into the texts. His Indian studies led to a controversy with M. Reinaud, which was certainly not free from the gall of bitterness. Among the many subjects to which he turned his attention were the native industries of China, and his work on the *Histoire et fabrication de la porcelaine Chinoise* is still, and is likely to remain, a standard work on the subject. In another volume he also published an account of the *Industries anciennes et modernes de l'empire Chinois* (1869), translated from native authorities. In the intervals of more serious undertakings he translated the *San tseu King*, or "Le Livre des trois mots"; *Thsien tseu wen*, or "Le Livre de mille mots"; "Les deux cousines"; "Nouvelles Chinoises"; the *Ping chan ling yen*, "Les deux jeunes filles lettrées"; and the "Dialoghi Cinesi," *Ji-tch'ang Keou-t'ou-koa*. The last work of importance which proceeded from his pen was his *Syntaxe nouvelle de la langue Chinoise* (1869). In these volumes he gives the results of his study of the language, and has collected in them a vast array of facts and of idiomatic expressions. A more scientific arrangement and treatment of his subject would have added much to the value of this work, which, however, contains a mine of material which amply repays exploration. One great secret by which Julien acquired his grasp of the Chinese language was, as we have said, his methodical collection of phrases and idiomatic expressions. Whenever in the course of his reading he met with a new phrase or expression, he entered it on a card which took its place in regular order in a long series of boxes. At his death, which took place on the 20th February 1873, he left, it is said, 250,000 of such cards, about the fate of which, however, little seems to be known. In politics Julien was imperialist, and in 1863 he was made a commander of the legion of honour in recognition of the services he had rendered to literature during the empire. (R. K. D.)

**JULIERS.** See **JÜLICH**.

**JULIUS I.**, pope from 337 to 352, was a native of Rome, and was chosen as successor of Marcus after the Roman see had been vacant four months. He is chiefly known by the part which he took in the Arian controversy. After the Eusebians had, at a synod held in Antioch in 341, renewed their deposition of Athanasius, they resolved to send delegates to Constans, emperor of the West, and also to Julius, setting forth the grounds on which they had proceeded. The latter, after expressing an opinion favourable to Athanasius, adroitly invited both parties to lay the case before a synod to be presided over by himself. This proposal, however, the Eastern bishops declined to accept. On his second banishment from Alexandria, Athanasius came to Rome, and was recognized as a regular bishop by the synod held in 342. It was through the influence of Julius that, at a later date, the council of Sardica in Illyria was held, which was attended only by seventy-six Eastern bishops, who speedily withdrew to Philippopolis and deposed Julius, along with Athanasius and others. The three hundred Western bishops who remained confirmed the previous decisions of the Roman synod; and by its 3d, 4th and 5th decrees relating to the rights of revision claimed by Julius the council of Sardica perceptibly helped forward the pretensions of the papacy. Julius on his death in April 352 was succeeded by Tiberius.

**JULIUS II.**, pope from 1503 to 1513, was born at Savona in 1443. He was the son of a brother of Sixtus IV., his original name being Giuliano della Rovere. By his

uncle, who took him under his special charge, he was educated among the Franciscans, and latterly sent to a convent in La Pérouse with the special purpose of obtaining a knowledge of the sciences. He does not appear, however, to have joined the order of St Francis, but to have remained one of the secular clergy until his elevation in 1471 to be bishop of Carpentras, shortly after his uncle succeeded to the papal chair. In the same year he was promoted to be cardinal, taking the same title as that formerly held by his uncle, St Peter ad Vincula. With his uncle he obtained very great influence, and in addition to the archbishopric of Avignon he held no fewer than eight bishoprics. In the capacity of papal legate he was sent in 1480 to France, where he remained four years, and acquitted himself with such ability that he soon acquired a paramount influence in the college of cardinals, an influence which rather increased than diminished during the pontificate of Innocent VIII. A rivalry had, however, gradually grown up between him and Roderigo Borgia, and on the death of Innocent in 1492 Borgia by means of a secret agreement with Ascanio Sforza succeeded in being elected over Della Rovere by a large majority, under the name of Alexander VI. Della Rovere at once determined to take refuge at Ostia, and in a few months afterwards went to Paris, where he incited Charles VIII. to undertake the conquest of Naples. Accompanying the young king on his campaign, he entered Rome along with him, and endeavoured to instigate the convocation of a council to inquire into the conduct of the pope with a view to his deposition, but Alexander, having gained a friend in Charles's minister Briçonnet, by the offer of a cardinal's hat succeeded in counterworking the machinations of his enemy. On the death of Alexander in 1503 Della Rovere supported the candidature of Cardinal Piccolomini of Milan, who was consecrated under the name of Pius III., but was then suffering from an incurable malady, of which he died in little more than a month afterwards. Della Rovere then succeeded by dexterous diplomacy in winning the support of Cæsar Borgia, and was elected to the papal dignity by the unanimous vote of the cardinals. From the beginning Julius II. set himself with a courage and determination rarely equalled to rid himself of the various powers under which his temporal authority was almost overwhelmed. By a series of complicated stratagems he first succeeded in rendering it impossible for Borgia to remain in the papal states. He then used his influence to reconcile the two powerful houses of Orsini and Colonna, and, by decrees made in their interest, he also attached to himself the remainder of the nobility. Being thus secure in Rome and the surrounding country, he next set himself to oust the Venetians from Faenza, Rimini, and the other towns and fortresses of Italy which they occupied at the death of Alexander VI. Finding it impossible to succeed with the doge by remonstrance, he in 1504 brought about a union of the conflicting interests of France and Germany, and sacrificed temporarily to some extent the independence of Italy in order to conclude with them an offensive and defensive alliance against Venice. The combination was, however, at first little more than nominal, and was not immediately effective in compelling the Venetians to deliver up more than a few unimportant places in the Romagna; but by a brilliant campaign Julius in 1506 succeeded in freeing Perugia and Bologna from their despots, and raised himself to such a height of influence as to render his friendship of prime importance both to the king of France and the emperor. Events also in other respects so favoured his plans that in 1508 he was able to conclude with Louis XII., the emperor Maximilian, and Ferdinand of Aragon the famous league of Cambrai against the Venetian republic. In the spring of the following year the republic was placed



under an interdict. The results of the league soon stripped the primary intention of Julius. By the single battle of Agnadello the dominion of Venice in Italy was practically lost; but, as neither the king of France nor the emperor was satisfied with merely effecting the purposes of the pope, the latter found it necessary to enter into a combination with the Venetians to defend himself from those who immediately before had been his allies against them. The Venetians on making humble submission were absolved in the beginning of 1510, and shortly afterwards France was placed under the papal ban. Attempts to bring about a rupture between France and England proved unsuccessful; on the other hand, at a synod convened by Louis at Tours in September 1510 the French bishops withdrew from the papal obedience, and resolved, with Maximilian's co-operation, to seek the deposition of Julius. In November 1511 a council actually met for this object at Pisa. Julius hereupon entered into the Holy League with Ferdinand of Aragon and the Venetians against France, in which both Henry VIII. and the emperor ultimately joined. He also convened a general council (that afterwards known as the Fifth Lateran) to be held at Rome in 1512, which, according to an oath taken on his election, he had bound himself to summon, but which had been delayed, he affirmed, on account of the occupation of Italy by his enemies. In 1512 the French were driven across the Alps, but it was at the cost of the occupation of Italy by the other powers, and Julius, though he had securely established the papal authority in the states immediately around Rome, was practically as far as ever from realizing his dream of an independent Italian kingdom when he died of fever in February 1513.

The abilities and ambition of Julius were regal and military rather than in any sense ecclesiastical. He was more concerned for his own personal fame as a member of the family of Della Rovere than for the advancement of the influence and authority of the church. His dauntless spirit, his mastery of political stratagem, and his moral indifference in the choice of means rendered him the most prominent political figure of his time. While, however, his political and warlike achievements would alone entitle him to rank amongst the most remarkable of the occupants of the papal chair, his chief title to honour is to be found in his patronage of art and literature. He did much to improve and beautify the city; in 1506 he laid the foundation stone of St Peter's; and he was the friend and patron of Bramante, Raphael, and Michelangelo. He was succeeded by Leo X.

See Dumesnil, *Histoire de Jules II.*, Paris, 1873; Brosch, *Papst Julius II.*, Götting, 1878.

**JULIUS III.**, pope from 1550 to 1555, was born at Rome in 1487. He was of good family, his original name being Gian Maria del Monte. After attaining the dignity of archbishop of Siponto, he was in 1536 created cardinal by Paul III., by whom he was employed on several important legations; he was one of the presidents of the council of Trent during its session at Bologna in April 1547. In 1550 he was unanimously chosen successor of Paul III. He consented, at the request of the emperor Charles V., to the reopening of the council of Trent (in 1551), and he also entered into a league with him against the duke of Parma and Henry II. of France; but soon afterwards he deemed it advisable to make terms with his enemies, and in 1552 he again suspended the meetings of the council. From this time pope Julius seems to have lost interest both in political and ecclesiastical affairs; formerly he had acquired a reputation for impetuous energy as well as austerity, but he now exchanged these qualities for a love of luxurious ease, comporting himself at the entertainments given by him in his palace

in a manner fitted to shock preconceived ideas of ecclesiastical propriety. He also aroused much scandal by creating as his first cardinal a youth of sixteen years of age, one of his pages, on account of the courage he had displayed when bitten by a monkey. The adornment of his palace and the laying out of its grounds occupied a large share of his attention, and have done more to make him remembered than his strictly pontifical procedure. Julius was a friend of the Jesuits, to whom he granted a fresh confirmation in 1550. He was succeeded by Marcellus II.

**JULY**, the seventh month in our present calendar, consists of thirty-one days. It was originally the fifth month of the year, and as such was called by the Romans *Quintilis*. The later name of Julius was given in honour of Julius Cæsar (who was born in the month), and came into use in the year of his death. Our Anglo-Saxon ancestors called July *Mæl-mônáð*, "mead month," from the meadows being then in their bloom; and *ǽftera Lífra*, "the latter mild month," in contradistinction to June, which they named "the former mild month." The principal days now observed and noted in this month are the following:—July 3d, Dog Days begin; July 15th, St Swithin; and July 25th, St James.

**JUMET**, or **JUMETZ**, a town and commune of Belgium, in the arrondissement of Charleroi and the province of Hainault, is situated about 4 miles north-east of Charleroi. Its manufactures include glass-bottles, knives, nails, and hats; and there are extensive coal-mines in the neighbourhood. The population of the commune in 1876 was 20,102.

**JUMÈGES**, or **JUMIÈGES**, a village of France, in the department of Seine Inférieure and arrondissement of Rouen, about 16 miles south-west of Rouen, in one of the peninsulas formed by the winding of the Seine. The population was less than 2000 in 1876; but the place is famous for the imposing ruins of the abbey of Jumèges (Latinized as *Gemetium*, *Gemedium*, *Gimegia*, *Jumedica*, &c.), one of the great establishments of the Benedictine order. The principal remains are those of the Church of the Virgin, which had a central tower, the magnitude of which may be judged by one of the sustaining arches still extant. Among the minor relics are the stone which once covered the grave of Agnes Sorel, and two recumbent statues of the 13th century, popularly known as the *Énévées*, and explained by a baseless legend which makes them represent two sons of Clovis II., who were punished for revolt against their father by having the tendons of their arms and legs cut through, and being set adrift in a boat on the Seine.

The foundation of the abbey of Jumèges is generally assigned to St Philbert, 664 A.D., whose name is still to be read on gold and silver coins obtained from the site. It was to Jumèges that abbot Sturm of Fulda was relegated (760-62), and thither it was that Charlemagne sent Thassilo, the captive duke of Bavaria, and his son Theodo. The 9th century was a period of pillage and disaster for the abbey, but the 11th and 12th centuries saw it raised to new splendour and greatness. One of its monks, Robert Champart, became, under Edward the Confessor, bishop of London and archbishop of Canterbury. Returning to die in his abbey (1052), he brought with him an Anglo-Saxon missal and pontifical, which are still preserved in the public library of Rouen. For further details see Mabillon, *Acta Sanct. ord. S. Benedicti*, tom. ii.; W. Calcut (a monk of Jumèges), *Hist. Norm.*, apud Durlesne; Deshayes, *Hist. de l'abbaye royale de Jumèges*, Rouen, 1829; Langlois, *Essai sur les Énévées de Jumèges*, Rouen, 1838; Cochet, *La Seine Inférieure*, Paris, 1864.

**JUMILLA**, a town of Spain, in the province of Murcia, is situated 37 miles north-north-west of Murcia, at the foot of a hill whose summit is crowned by a citadel. The streets are regular, clean, and well-paved, and there are three squares. Jumilla possesses two parish churches of some architectural merit, the church of Saufiagn in the Corinthian

style being adorned with paintings of Rubens and other artists of fame, and with some beautiful frescoes. There is also a Franciscan convent and a hospital. The town is chiefly dependent on agriculture, but has corn and oil mills, brick-kilns, and manufactories of salt, coarse cloth, soap, and firearms. The population in 1877 was 13,886.

JUMNA, or JAMUNA, one of the large rivers of northern India, rises in the Himālayas in Garhwāl state, about 5 miles north of Jamnotri hot springs, in  $31^{\circ} 3' N.$  lat. and  $78^{\circ} 30' E.$  long. The stream first flows south for 7 miles, then south-west for 32 miles, and afterwards due south for 26 miles, receiving several small tributaries in its course. It afterwards turns sharply to the west for 14 miles, when it is joined by the large river Tons from the north. The Jumna here emerges from the Himālayas into the valley of the Dūn, and flows in a south-westerly direction for 22 miles, dividing the Kiarda Dūn on the west from the Dehra Dūn on the east. It then, in the 95th mile of its course, forces its way through the Siwālīk hills, and debouches upon the plains of India at Faizābād in Sahāranpur district. By this time a large river, it gives off, near Faizābād, both the eastern and western Jumna canals. From Faizābād the river flows for 65 miles in a south-south-west direction, receiving the Maskarra stream from the east. Near Bidhāull, in Muzaffarnagar district, it turns due south for 80 miles to Delhi city; thence south-east for 27 miles to near Dankaur, receiving the waters of the Katha-nadi and Hindan river on the east, and of the Sabi-nadi on the east. From Dankaur it resumes its southerly course for 100 miles to Mahāban near Muttra, where it turns eastwards for nearly 200 miles, passing the towns of Agra, Firozābād, and Etāwah, receiving on its left bank the Karwan-nadi, and on its right the Utangan. From Etāwah it flows 140 miles south-east to Hamirpur, being joined by the Sengon on its north bank, and on the south by the great river Chambal from the west, and by the Sind. From Hamirpur, the Jumna flows nearly due east, until it enters Allahābād district and passes Allahābād city, 3 miles below which it falls into the Ganges in  $25^{\circ} 25' N.$  lat. and  $81^{\circ} 55' E.$  long. In this last part of its course it receives the waters of the Betwa and the Ken.

The Jumna, after issuing from the hills, has a longer course through the North-Western Provinces than the Ganges, but it is not so large nor so important a river; and above Agra in the hot weather it dwindles to a small stream. This is no doubt partly caused by the eastern and western Jumna canals,—of which the former was excavated in 1823–30, and in its course of 130 miles irrigated, in 1875–76, 195,846 acres of the districts of Sahāranpur, Muzaffarnagar, and Meerut, in the North-Western Provinces; while the latter, consisting of the reopened channels of two canals dating from about 1350 and 1628 respectively, extends for 405 miles through the districts of Ambāla, Karnāl, Delhi, and Rohtak in the Punjab, irrigating (1872–73) 351,820 acres.

The trade on the Jumna is not now very considerable; in its upper portion timber, and in the lower stone, grain, and cotton are the chief articles of commerce, carried in the clumsy barges which navigate its stream. Its waters are clear and blue, while those of the Ganges are yellow and muddy; the difference between the streams can be discerned for some distance below the point at which they unite. Its banks are high and rugged, often attaining the proportions of cliffs, and the ravines which run into it are deeper and larger than those of the Ganges. It traverses the extreme edge of the alluvial plain of Hindustān, and in the latter part of its course it almost touches the Bundelkhand offshoots of the Vindhya range of mountains. Its passage is therefore more tortuous, and

the scenery along its banks is more varied and pleasing, than is the case with the Ganges.

The Jumna at its source near Jamnotri is 10,849 feet above the sea-level; at Kotnur, 16 miles lower, it is only 5036 feet; so that, between these two places, it falls at the rate of 314 feet in a mile. At its junction with the Tons it is 1686 feet above the sea; at its junction with the Asan, 1470 feet; and at the point where it issues from the Siwālīk hills into the plains, it is 1276 feet. The catchment area of the river is 118,000 square miles; its flood discharge at Allahābād is estimated at 1,333,000 cubic feet per second. The Jumna is crossed by railway bridges at Delhi, Agra, and Allahābād, while bridges of boats are stationed at Etāwah, Kalpi, Hamirpur, Muttra, Chillatāra, and many other places.

JUNĀGARH, a native state in Kāthiāwār, in the province of Guzerat, Bombay presidency, India, is situated between  $20^{\circ} 48'$  and  $21^{\circ} 40' N.$  lat., and between  $69^{\circ} 55'$  and  $71^{\circ} 35' E.$  long. The state, which comprises an estimated area of 3800 square miles, consists of a level plain, with the exception of the Gīrnar group of hills, sacred to Jainism, the highest peak of which rises to about 3500 feet above sea-level. The coast-line is well supplied with fair-weather harbours, of which the chief are Verawāl, Nawabandar, and Sattrapora. The ruined but famous temple of Somnāth is situated in the state. The estimated population in 1872 was 380,921, residing in eight hundred and ninety villages. The principal agricultural products are cotton (largely exported to Bombay for re-export), wheat, pulses and millets, oilseeds, and sugar-cane. The manufactures are oil and coarse cotton cloth. The estimated revenue is £200,000. Junāgarh town, the fortified capital of the state, situated in  $21^{\circ} 31' N.$  lat.,  $70^{\circ} 36' 30' E.$  long., has an estimated population of 20,025.

Prior to 1746 Junāgarh was a Rājput state ruled by chiefs of the Churāsūmā tribe, but in that year it was conquered by Sultan Muhammad Begira of Ahmadābād. In Akbar's reign it became a dependency of the court of Delhi, under the immediate authority of the Mughal viceroy of Guzerat. About 1735, when the representative of the Mughals had lost his authority in Guzerat, Sher Khān Bābi, a soldier of fortune under the viceroy, expelled the Mughal governor and established his own rule. Sher Khān's son, Sāhibat Khān, appointed his heir chief of Junāgarh, assigning to his younger sons the lands of Bāntwā. Though himself tributary to the gāekwār of Baroda and the British Government, the nawāb of Junāgarh receives yearly contributions, called *zakhābi*, from a large number of the petty chiefs in Kāthiāwār. This levy, which is collected and paid to the nawāb by British officers of the Kāthiāwār agency, is a relic of the days of Mahometan supremacy. Junāgarh ranks as a first class state among the many chiefships of Kāthiāwār, and its ruler first entered into engagements with the British in 1807.

JUNE, the sixth month in our present calendar, consists of thirty days. Ovid, in his *Fasti* (vi. 25), makes Juno assert that the name was expressly given in her honour:—

“Ne tamen ignores vulgare errore traharis,  
Junius a nostro nomine nomen habet.”

In another part of the *Fasti* (vi. 87) he gives the derivation a *junioribus*, as May had been derived from *Majores*. Others connect the term with the gentile name Junius, or with the consulate of Junius Brutus. Probably, however, it has an agricultural reference, and originally denoted the month in which crops grow to ripeness. In the old Latin calendar June was the fourth month, and in the so-called year of Romulus it is said to have had thirty days; but at the time of the Julian reform of the calendar its days were only twenty-nine. To these Caesar added the thirtieth, which it still retains. The Anglo-Saxons had several names for the month of June. They called it “the dry month,” “midsummer month,” and, in contradistinction to July, “the earlier mild month.” The summer solstice occurs in June. The principal days now observed in this month are the following:—



June 11th, St Barnabas; June 24th, Midsummer Day (Nativity of St John the Baptist); and June 29th, St Peter.

JUNG, JOHANN HEINRICH (1740-1817), best known by his assumed name of HEINRICH STILLING, charcoal-burner, tailor, village schoolmaster, oculist, professor of political science, and mystic, was born in the village of Grund in the duchy of Nassau on the 12th September 1740. His father, Wilhelm Jung, schoolmaster and tailor, was the son of Eberhard Jung, charcoal-burner, and his mother was Dortchen or Dorothy Moritz, daughter of a poor clergyman. In the best of his books Stilling gives a charming description of the patriarchal simplicity of his home, and draws the portrait of his grandfather especially with a loving and skilful hand. Stilling became, by his father's desire, schoolmaster and tailor, but "to be always sitting at the needle and making clothes for people was highly repugnant to me," and "to be everlastingly instructing boys and girls in A B C" was equally wearisome. Severe home discipline made Stilling glad to accept an appointment as schoolmaster in a neighbouring village, where, however, he taught not with pleasure but from a sense of duty. He afterwards became tutor in the family of a merchant, and in 1768 went with "half a French dollar," as he himself tells us, to study medicine at the university of Strasburg. What he wanted in money he possessed in confidence in Divine aid; and in after life he was wont to refute sceptical adversaries by recounting the many occasions on which his prayers were answered by providential messengers, for so he regarded them, who in the most unexpected way provided him with the money necessary not only for his studies but for his very existence. At Strasburg he met Goethe, who showed him much kindness, and introduced him to Herder. The acquaintance with Goethe ripened into friendship; and it was by his influence that Stilling's first and best work, *The Account of his Youth*, was in 1777 given to the world. In 1772 he settled at Elberfeld as physician and oculist, and soon became celebrated for operations in cases of Cataract. Surgery, however, was not much more to his taste than tailoring or teaching; and in 1778 he was glad to accept the appointment of lecturer on "agriculture, technology, commerce, and the veterinary art" (!) in the newly established academy at Kaiserslautern. In 1784 the academy was transferred to Heidelberg and united with the university. In 1786, on the occasion of the anniversary of the fourth centenary of Heidelberg university, Stilling created immense enthusiasm by delivering his speech, the last of the day, in German. The other professors had used Latin. In 1787 Stilling was appointed professor of economical, financial, and statistical science in the university of Marburg. In 1803 he resigned his professorship and returned to Heidelberg, where he remained with no official appointment until 1806. In that year he received a pension from the grand-duke Charles Frederick of Baden, and removed to Carlsruhe, where he remained until his death on the 2d April 1817. He was married three times, and left a numerous family. Of his engagement to his first wife he tells a most amusing story in his autobiography. Of his works this autobiography *Heinrich Stillings Leben*, from which he came to be known as Stilling, is the only one now of any interest, and, with the supplement by his son-in-law Dr Schwarz, is the chief authority for his life. A believer in dreams and apparitions, he was superstitious rather than mystical. His piety was fervent, but not austere; and his chief delight was in seeing others happy. Modest and affable, he endeared himself to all who came in contact with him. He hated nothing except sects, which, he says, are due merely to pride under the mask of piety. He numbered among his many friends Goethe and Kant and Lavater, the first of whom pays

him high tribute in the second part of *Aus meinem Leben*.

A complete edition of his numerous works, in 14 vols. 8vo, was published at Stuttgart in 1835-38. There are English translations by Sam. Jackson of the *Leben*, London, 1835, and of the *Theorie der Geisterkunde*, London, 1834, and New York, 1851; and of *Theobald, or the Fenatic*, a religious romance, by the Rev. Sam. Schaeffer, Philadelphia, 1846.

JUNIPER. The junipers, of which there are about twenty-five species, are evergreen bushy shrubs or low columnar trees, with a more or less aromatic odour, inhabiting the whole of the cold and temperate northern hemisphere, but attaining their maximum development in the temperate zone in North America and Europe. The leaves are usually articulated at the base, spreading, sharp-pointed, and needle-like in form, destitute of oil-glands, and arranged in alternating whorls of three; but in some the leaves are minute and scale-like, closely adhering to the branches, the apex only free, and furnished with an oil-gland on the back. Sometimes the same plant produces both kinds of leaves on different branches, or the young plants produce acicular leaves, while those of the older plants are squamiform. The male and female flowers are usually produced on separate plants; the occurrence of both on the same plant is rare. The male flowers are developed at the ends of short lateral branches, are rounded or oblong in form, and consist of several antheriferous scales in two or three rows, each scale bearing three or six almost spherical pollen-sacks on its under side. The female flower is a small bud-like cone situated at the apex of a small branch, and consists of two or three whorls of two or three scales. The scales of the upper or middle series each produce one lateral ovule. The mature cone is fleshy, with the succulent scales fused together and forming the fruit-like structure known to the older botanists as the galbulus, or berry of the juniper. The berries are red or purple in colour, varying in size from that of a pea to a nut. They differ considerably from the cones of other members of the order *Coniferae*, to which the junipers belong. The seeds are usually three in number, sometimes fewer (1), rarely more (8), and have the surface near the middle or base marked with large glands containing oil. The genus occurs in a fossil state, four species having been described from rocks of Tertiary age.

Bentham and Hooker divide the genus into three sections, viz., *Sabina*, *Oxycedrus*, and *Caryocedrus*. *Juniperus Sabina* is the savin, an irregularly spreading much branched shrub with scale-like glandular leaves, and emitting a disagreeable odour when bruised. The flesh and dried tops of savin are official in the British and United States pharmacopœias. The plant is poisonous, acting as a powerful local and general stimulant, diaphoretic, emmenagogue and antelmintic; it is employed both internally and externally. *Juniperus bermudiana*, a tree about 40 or 50 feet in height, yields a fragrant red wood, which was used for the manufacture of "cedar" pencils. The tree is now very scarce in Bermuda, and the "red cedar," *Juniperus virginiana*, of North America is employed instead for pencils and cigar boxes. The red cedar is abundant in some parts of the United States, and in Virginia is a tree 50 feet in height. It is very widely distributed from the great lakes to Florida and round the Gulf of Mexico, and extends as far west as the Rocky Mountains. The wood is applied to many uses in the United States. The fine red fragrant heart-wood takes a high polish, and is much used in cabinet work and inlaying, but the small size of the planks prevents its more extended use. The tops of the young branches are official in the United States pharmacopœia. The galls produced at the ends of the branches have also been used in medicine, and the wood yields cedar-camphor and oil of cedar wood.

The *Juniperus thurifera* is the incense juniper of Spain and Portugal, and *J. phœnicea* (*J. lycia*) from the Mediterranean district is stated by Loudon to be burned as incense.

*Juniperus communis*, the common juniper, and several other species, belong to the section *Oxycedrus*. The common juniper is a very widely distributed plant, occurring in the whole of northern Europe, central and northern Asia to Kamchatka, and North America. It grows at considerable elevations in southern Europe, in the Alps, Apennines, Pyrenees, and Sierra Nevada (4000 to 9000 feet). It also grows in Asia Minor, Persia, and at great elevations on the Himalayas. In former times the juniper seems to have been a very well known plant, the name occurring almost unaltered in many languages. The dialectical names, chiefly in European languages, have been collected by Prince L. L. Bonaparte, and published in *The Academy* (July 17, 1880, No. 428, p. 45). The common juniper is official in the British pharmacopœia and in that of the United States, yielding the oil of juniper, a powerful diuretic, distilled from the unripe fruits. The wood is very aromatic, and is used for ornamental purposes. In Lapland the bark is made into ropes. The fruits are used for flavouring gin (a name derived from *juniper*, through the French *genièvre*); and in some parts of France a kind of beer called *Genévrette* was made from them by the peasants. *Juniperus Oxycedrus*, from the Mediterranean district and Madeira, yields cedar oil which is official in most of the European pharmacopœias, but not in that of Britain.

The third section, *Caryocedrus*, consists of a single species, *Juniperus drupacea* of Asia Minor. The fruits are large and edible; they are known in the East by the name *Labdet*.

JUNIUS. This is the signature of an unknown writer who, after exciting and baffling the curiosity of three or four generations of critics, has been allowed to take rank amongst English classics under a pseudonym. The first of the published letters with this signature was dated January 21, 1769; the last, January 21, 1772. The entire series appeared in the *Public Advertiser*, a popular newspaper edited by Woodfall, to whom a number of private letters were also addressed by the same writer. These are included in the collected and complete editions, as well as a number of letters attributed on varying grounds, more or less satisfactory, to Junius.

The first of the letters was a sweeping attack on the Government for the time being. Its spirit may be judged from the concluding sentence: "They (posterity) will not believe it possible that their ancestors could have survived or recovered from so desperate a condition while a duke of Grafton was prime minister, a Lord North chancellor of the exchequer, a Weymouth and a Hillsborough secretaries of state, a Granby commander-in-chief, and a Mansfield chief criminal judge of the kingdom." He does not condescend to particulars, and the letter might have passed unnoticed if Sir William Draper, a man of considerable note, had not undertaken the defence of Lord Granby in answer to it. A bitter controversy ensued, which rapidly degenerated into an exchange of personalities, much to the disadvantage of Sir William. Then came letters to the duke of Grafton, the prime minister, directed more against his private character and conduct than his policy, the main charge against his Grace being his abandonment of Wilkes, whom Junius treats throughout the letters as the champion of the constitution, to be supported against the ministry and the crown. He takes Blackstone, the author of the *Commentaries*, severely to task for justifying the expulsion of Wilkes, whose cause he also espouses in an altercation with Horne Tooke; and he omits no opportunity

of denouncing Luttrell, the elect of Middlesex. The address to the king, the most celebrated of Junius's compositions, after recapitulating the familiar charges of personal pique and favouritism, calls upon his Majesty to summon his whole council without consulting his minister: "Lay aside the wretched formality of a king, and speak to your subjects with the spirit of a man and in the language of a gentleman. Tell them you have been fatally deceived." Many of the letters turn on topics which have no longer the slightest interest. A long letter is addressed to Lord Mansfield for bailing a man named Eyre. In another, equally elaborate, this learned lord is accused of tampering with the common law by an admixture of the civil law, which is now regarded as his highest praise; Junius treats it as an attempt to undermine the liberties of England. He relies little on argument or proof. His force is in his style. He commonly assumes his victim to be what he wishes him to be thought, and produces the desired effect by irony, sarcasm, or polished invective. One of his happiest figures of speech is in the letter on the affair of the Falkland Islands: "Private credit is wealth; public honour is security; the feather that adorns the royal bird supports his flight; strip him of his plumage, and you fix him to the earth." Although an admirer of Lord Chatlam, Junius agreed with Mr Grenville as to the right of England to tax the colonies; and, although an uncompromising supporter of popular rights, he was an advocate or apologist for rotten boroughs.

The sensation Junius created in the political world may be inferred from the manner in which the leading orators and statesmen of the day spoke of him. "How comes this Junius," exclaimed Burke, addressing the Speaker, "to have broke through the cobwebs of the law, and to range uncontrolled, unpunished, through the land! The myrmidons of the court have been long, and are still, pursuing him in vain. They will not spend their time upon me or you. No, sir, they disdain such vermin when the mighty boar of the forest who has broke through all their toils is before them. But what will all their efforts avail? No sooner has he wounded one than he lays down another dead at his feet. For my part, when I read his attack upon the king, I own my blood ran cold." . . . "Nor has he dreaded the terrors of your brow, but he has attacked even you—he has—and I believe you have no reason to triumph in the encounter. In short, after carrying away our royal eagle in his pounces and dashing him against a rock, he has laid you prostrate. King, lords, and commons are but the sport of his fury. Were he a member of this House, what might not be expected from his knowledge, his firmness, and integrity? He would be easily known by his contempt of all danger, by his pointed penetration and activity." Lord North spoke in the same strain: "Why should we wonder that the great boar of the wood, this mighty Junius, has broke through the toils and foiled the hunters? Though there may be at present no spear that will reach him, yet he may be some time or other caught."

What added signally to his influence was the general belief of his contemporaries that he was a man of rank and position, familiar with what was passing behind the scenes in high places; and this belief arose not simply from the intimate knowledge he showed of things and persons about the court and the principal departments of the state, but from the lofty and independent tone that was habitual and seemed natural to him,—as when he tells Sir William Draper, "I should have hoped that even my name might carry some authority with it if I had not seen how very little weight or consideration a printed paper receives even from the respectable signature of Sir William Draper"; or when in private letters to the publisher, after waiving all right to the profits of the publication, he says: "As for



myself, be assured that I am far above all pecuniary views." "You, I think, sir, may be satisfied that my rank and fortune place me above a common bribe."

In the preface to the second volume of Bohn's edition of 1855, no less than thirty-seven persons are enumerated to whom the authorship has been attributed. Contemporary opinion strongly inclined to Burke, whose power of assuming or disguising style is proved by his *Indication of Natural Society*; and, as his biographer Prior pointedly remarks, "contemporary opinion, as formed from a variety of minor circumstances which do not come within the knowledge of future inquirers, is perhaps, on such occasions, the truest." Dr Johnson, who had entered the lists against Junius, told Boswell: "I should have believed Burke to be Junius, because I know no man but Burke who is capable of writing these letters; but Burke spontaneously denied it to me." Burke told Reynolds that he knew Junius, and uniformly spoke of him as he would hardly have spoken of himself. A very strong case was made out for Lord George Sackville, on whom, after Burke's denial, Sir William Draper's suspicions permanently fixed. Fox used to say that, although he would not take Single-speech Hamilton against the field, he would back him against any single horse. Boyd is another candidate who did not lack supporters. A plausible claim was advanced for the American General Lee, backed by three experts who pretended to detect him by the handwriting. A famous expert, Inbert, gave a written certificate on the same ground in favour of Horne Tooke; and another, Netherclift, declared that there was more of the Junius character in the handwriting of Mrs Dayrolles (the alleged amanuensis of Lord Chesterfield) than in any other specimen submitted to him as a possible performance by the great unknown. Other experts declared confidently for other claimants. But the identity remained an open question, and case after case was pronounced not proven, till the appearance of Mr Taylor's *Junius Identified* in 1816, when Sir Philip Francis immediately became the favourite, and during the next half century the problem was pretty generally considered at an end.

Prior to the publication, Mr Taylor called on Sir Philip to intimate what was intended, and came away with the impression that he was rather pleased than displeased with the intimation. In fact, he had been already playing Junius, and he continued playing the part till his death in 1818. "His first gift," writes his second wife, whom he married in 1814, two years before *Junius Identified*, "was an edition of Junius, which he bade me take to my room and not let it be seen or speak upon the subject; and his posthumous present, which his son found in his bureau, was *Junius Identified*, sealed up and directed to me." The real Junius might have bequeathed a much more conclusive legacy. He writes to Woodfall, December 17, 1771: "When the book is finished, let me have a sett (*sic*) bound in vellum, gilt, and lettered 'Junius I. II.' as handsomely as you can. The edges gilt, let the sheets be well dried before binding. I must also have two setts in blue paper covers. This is all the fee I shall ever require of you." These were duly sent, and it would have been something to the purpose had Francis bequeathed one of them to his wife. Neither of them has turned up. The surviving son (by the first wife) likewise claimed the authorship for the father as a source of pride to the family, so that no evidence in their possession would have been kept back.

Pitt told Lord Aberdeen (the fourth earl) that he knew who Junius was, and that it was not Francis. On its being objected that the Franciscan theory had not been started till after Pitt's death, Lord Aberdeen replied "*that's stuff*," and proceeded to relate that he himself had once dined in

company with Francis when proofs of his being Junius were adduced before him, that he had listened with evident pleasure, and at last exclaimed in a stilted theatrical manner, "God! if men force laurels on my head, I'll wear them." His immediate contemporaries remained unconvinced. Sir Fortunatus Dwaris states broadly that no one who knew, heard, or read Francis thought him capable of producing Junius. Lord Broughton confirmed this. Tierney said: "I know no better reason for believing the fellow to be Junius than that he was always confoundedly proud of somethiug, and no one could ever guess what it could be."

Lord Stanhope, however, would admit no shadow of doubt upon the point, and Lord Macaulay declared that all reasoning from circumstantial evidence was at an end unless Francis were admitted to be Junius. Both these eminent authorities agree in resting their case on similarity of handwriting, on the internal evidence of style, and on five points which are summarily stated by Lord Macaulay in his essay on Warren Hastings. As regards similarity of handwriting, there is one plain test on which experts are agreed, namely, that "it is impossible for a man, in order to disguise his writing, to write better than he does habitually"; and the best penmanship of Junius is incomparably superior in fineness, delicacy, and grace to the best of Francis, who wrote a large, coarse, clerk-like hand. As regards style, the specimens culled from Francis's speeches and writings prove no more than that he, an assiduous imitator of Junius, succeeded occasionally in catching the mannerism, without any one of the distinctive merits, of his model. Lord Macaulay, not denying the inferiority, endeavours to weaken the argument drawn from it by remarking that it may be urged with at least equal force against every claimant that has ever been mentioned, with the single exception of Burke. "And what conclusion," he asks, "after all, can be drawn from mere inferiority? Every writer must produce his best work; and the interval between his best and his second best work may be very wide indeed." This undeniable truth might have been urged with equal force by any pretender to a disputed authorship,—for example, by Theophilus Swift, the dean's cousin, when he claimed the authorship of the *Tale of a Tub*. Surely the strongest argument in favour of any given candidate is that (tested by his known writings) he alone was equal to the authorship, and the strongest argument against any given candidate that (tested in the same manner) he was unequal to it. Francis put forth his full powers in his controversy with Hastings, and his friend D'Oly writes to him in 1778 that the public who had followed the controversy allowed both to be good writers; "but, in their opinion, he (Hastings) takes the lead so decidedly as to admit of no comparison."

The five points (which have been logically resolved into three) remained untouched till the publication of the memoirs of Sir Philip Francis by Parkes and Merivale in 1867. This book entirely changed the aspect of the controversy by showing that Francis's position, opinions, interests, manner of life, and tone during the Junian period were the reverse of what those of Junius might be supposed to have been. During the whole of that period he was first clerk in the war office under Lord Barrington. Born in Dublin, October 22, 1740, he was in his thirtieth year when the famous letters commenced. He was the son of Dr Francis, the translator of Horace, but had married under his station, and was associating principally with his wife's relatives and connexions. The habits of his set may be collected from his letters, e.g.: "January 4, 1769: I am just returned from spending a riotous fortnight at Bath. Gravier and two others filled a post-coach, which was dragged with no small velocity by four horses. We

travelled like gentlemen, and lived like rakes." February 12, 1771: "Tilman dined with me yesterday, and swallowed a moiety of two bottles of claret." . . . "We lead a jolly kind of life. This night to a concert, on Thursday to a ridotto, on Saturday the opera, and on Tuesday following a grand private ball at the London Tavern." July 26, 1771: "To-morrow Godfrey, Tilman, another gent, and I set out upon a tour through Derbyshire, and propose to reach Manchester." They did not return till August 13, the day on which Junius's reply to Horne Tooke appeared. On June 25, 1771, in the very thick of the Junian correspondence, Francis writes to a friend abroad: "For the next three years I am likely enough to remain in my present state of uninteresting indolence."

There is no trace at this time of any connexion with the newspapers, nor of any earnest or sustained literary occupation. The only political personage we find him in communication with was Calcraft, to whom he occasionally supplied scraps of official news. By a startling coincidence, all the persons who had been kind or useful to him in promoting his advancement, including Wood (to whom he owed his clerkship), his chief (Lord Barrington), and Calcraft, were bitterly assailed by Junius. The predilections of the pair, the substance and the shadow, are as hard to reconcile as their antipathies. Junius had a high respect for Wilkes's judgment, and avows a liking for both the cause and the man. On November 8, 1771, he writes to Woodfall: "Show the dedication and preface of the letters to Mr Wilkes, and, if he has any material objection, let me know." Francis, in his private correspondence, uniformly expresses the most unmitigated contempt for Wilkes. He writes like one of the general public about Junius. Thus on June 12, 1770, to his brother-in-law: "Junius is not known, and that circumstance is perhaps as curious as any of his writings. I have always suspected Burke; but, whoever he is, it is impossible he can ever discover himself." Sir William Draper, Junius's first victim, was an old friend of the Francis family, and in a letter dated Bath, January 28, 1769, Dr Francis writes to Philip: "Give my love to Mr Calcraft. Tell him to expect a very spirited and exceeding honourable defence of L. G—y (Granby) against the virulent Junius, by our friend Sir W. D—r. I truly honour him for it." Again, February 11, 1769: "Poor Sir William! I am glad he is gone to Clifton, where he may eat his own heart in peace. When he repeated to me some passages of his letter, I bid him prepare his best philosophy for an answer. But who is this devil Junius, or rather legion of devils? Is it not Burke's pen directed in the gall of Sa—lle's heart? Poor Sir William

One of Lord Macaulay's five points is that Junius was "bound by some strong tie" to the first Lord Holland, the friend of Dr Francis and the early patron of Philip. Now, in a fragment of autobiography (included in the memoirs) it is stated that, long before the Junius letters, Dr Francis considered himself grossly ill used by Lord Holland, and "was stung with the idea of having been so long the dupe of a scoundrel." "In this," adds the son, "I concurred with him heartily." Another point, and a most important one, is that Francis bitterly resented the appointment (over his head) of Mr Chamier to the place of deputy secretary-at-war, and that to the resentment thus aroused was owing the downright ferocity, the brutal abuse (as Mr Merivale calls it), with which Lord Barrington was assailed by Junius under the signature of Veteran. Laying out of the account the fact that Lord Barrington had been the object of Junius's unrelenting attacks for more than two years before the appointment of Chamier, it is sufficient to refer to Francis's letter of January 24, 1772, to Major Baggs,

in which he says: "You will have heard that Mr D'Oyly has resigned his employment (of deputy). He did it while I was at Bath. Immediately upon my return, my Lord Barrington was so good as to make me the offer with many obliging and friendly expressions. I had, however, solid reasons for declining the offer, and Mr Anthony Chamier is appointed." He was obviously looking out for an Indian appointment, and left the war office in the March following, relying on Lord Barrington's aid in procuring one. After relating in the autobiography how he accidentally heard that Cholwell, one of the intended commissioners for India, had declined the appointment, he proceeds: "It was the king's birthday, and Barrington was gone to court. I saw him the next morning; and, as soon as I had explained my views, he wrote the handsomest and strongest imaginable letter in my favour to Lord North. Other interests contributed, but I owe my success to Lord Barrington." After his arrival in India, Francis was in the habit of writing long and confidential letters to Lord Barrington, who, in 1777, writes to express his gratification at the good understanding between Francis and Claveing. "I love you both so much that I cannot wish you to continue long in a situation so painful though so creditable to you." One of the first visits Francis paid on his return was to Lord Barrington at his country house. "It is the imputed folly," urge the opponents of the Franciscan theory, "not merely the imputed baseness of Francis that startles us. He is represented systematically writing against every friend, benefactor, and patron in succession, without a rational motive or an intelligible cause."

As if the embarrassments of his position were not enough, he must have gone out of his way to multiply them. The terms on which Junius stood with Sir William Draper are well known. In a letter dated February 14, 1770, he describes Sir John Burgoyne as "sitting down for the remainder of his life infamous and contented." On December 11, 1787, when Francis was attacked in the House of Commons for having allowed himself to be included in the list of managers for the impeachment of Warren Hastings, his personal enemy, he rose and stated that the two persons whom he had consulted as the best judges of points of honour were Sir William Draper and Sir John Burgoyne. Draper was dead, but Burgoyne rose and handsomely responded to the appeal, which, if Francis was Junius, has been justly stigmatized as one of the strongest examples of gratuitous folly and brazen impudence on record.

That Earl Temple wrote or inspired Junius is a theory which has been maintained in two able essays, and it derives plausibility from Pitt's assertion that he knew who Junius was, as well as from the language of the Grenville family, which all points to Stowe as the seat of the mystery. The Right Hon. T. Grenville told the first duke of Buckingham, who thought he had discovered the secret, that it was no news to him, but for family reasons the secret must be kept. He also stated to other members of the family, subsequently to the publication of *Junius Identified*, that Junius was not either of the persons to whom the letters had been popularly ascribed. Lord Grenville told Lord Sidmouth that he (Lord G.) knew who Junius was. Lady Grenville told Sir Henry Holland and Dr James Ferguson that she had heard Lord Grenville state that he knew who Junius was, and that it was not Francis. The handwriting of Countess Temple (supposed to have acted as the amanuensis of her lord) comes far the nearest to the Junian hand of any that have been produced as similar to it, especially as regards powers of penmanship; but evidence is altogether wanting that Earl Temple, or any one about him, possessed the required literary qualifications and capacity. The authorship of the letters, therefore, remains a mystery, and



*Stat Nominis Umbra* is still the befitting motto for the title-page.

See John Wade, *Junius, including Letters by the same writer under other Signatures, &c.*, 2 vols., 1850; Parkes and Merivale, *Memoirs of Sir Philip Francis, K. C. B., with Correspondence and Journals*, 2 vols., 1867; John Taylor, *Junius Identified*, 1816; A. Hayward, *More about Junius*, 1868; Charles Chabot, *The Handwriting of Junius Professionally Investigated*, with preface and collateral evidence by the Hon. E. Twissleton, 1871. (A. II.)

**JUNIUS, FRANCISCUS** (1545–1602), in French François du Jon, Huguenot divine and writer, was born of good family at Bourges, in France, May 1, 1545. He was a precocious child, and had studied law for two years under Donellus, when a place in the retinue of the French ambassador to Constantinople was procured for him in his fifteenth year. Before he reached Lyons, where he was to join the ambassador, the latter had departed, but Junius, scarcely disappointed, found ample consolation in the better opportunities for study to be found at Lyons. A religious tumult warned the young Huguenot back to Bourges, where the judicious piety of his father not only won him from certain atheistic principles that he had imbibed at Lyons, but also inspired him with the desire of entering the church. To that end he went to study at Geneva, where he was reduced to the direst straits of poverty by the failure of remittances from home, owing to civil war in France. His pride or independence allowed him to accept only the barest sustenance from a humble friend who had himself been a protégé of Junius's family at Bourges, and his health was permanently injured by the weakness to which he was reduced. The long-expected remittance from home was closely followed by the news of the brutal murder of his father at Issoudun; and Junius resolved to remain at Geneva, where his reputation for learning now enabled him to find support by teaching. In 1565, however, he was appointed minister of the Walloon congregation at Antwerp. His foreign birth excluded him from the privileges of the native Reformed pastors, and exposed him to the persecutions of Margaret of Parma, governess of the Netherlands. Several times he barely escaped arrest, and finally, after spending six months in preaching at Limburg, he was forced to retire to Heidelberg in 1567. There he was welcomed by the elector Frederick, and temporarily settled in charge of a church at Schönau; but in 1568 his patron sent him as chaplain with the prince of Orange in his unfortunate expedition to the Netherlands. Junius escaped as soon as he could from that post, and returning to his church remained there till 1573. From 1573 till 1578 he was at Heidelberg, assisting Tremellius in his Latin version of the Old Testament, which appeared at Frankfort in 1579; and after two and a half years distributed between Neustadt and Otterburg he was appointed to the chair of divinity at Heidelberg. Thence in a short time he was taken to France by the duke of Bouillon, and after an interview with Henry IV. was sent again to Germany on a mission. As he was returning to France, he was named professor of theology at Leyden. In that office, which he filled with success and popularity, he died October 13, 1602. Junius was a learned and pious man, and in that age of illiberal theologians was distinguished for his liberality. He was several times married; "quatuor uxores," he naively expresses himself in his autobiography, "*duxit hæcenus.*"

He was a voluminous writer on theological subjects, and translated and composed many exegetical works. He is best known from his own edition of the Latin Old Testament, slightly altered from the former joint edition, and with a version of the New Testament added (Geneva, 1590; Hanover, 1624). The *Opera Theologica Francisci Junii Bâuvrigis* were published at Geneva, 2 vols., 1613, to which is prefixed his autobiography, written about 1592. The last had been published at Leyden, 1595, and is reprinted in the *Miscellanea Groningana* vol. i., along with a list of the author's other writings.

**JUNIUS, FRANCISCUS** (1589–1677), son of the foregoing, was born at Heidelberg in 1589. Brought up at Leyden, his attention was diverted from military to theological studies by the peace of 1609 between Spain and the Netherlands. In 1620 he went to England, where he became librarian to the earl of Arundel, and remained thirty years. He devoted himself to the study of Anglo-Saxon, and afterwards of the cognate old Teutonic languages,—a branch of study in which he has high claims to honour, not only from his own valuable labours in a hitherto almost completely neglected field, but also from having directed the scholarly attention of others to it. In 1650 Junius returned to Holland, where he continued to study as zealously as ever. For two years he lived in Friesland in order to study the peculiar old dialect. In 1675 he returned to England; in 1677 he went to live at Windsor with his nephew, Isaac Vossius, in whose house he died, November 19, 1677.

The uneventful life of Junius was eminently the life of a student; fourteen hours a day were spent at his desk; and the results are seen in his books, and in the rich collection of ancient MSS., edited and annotated by him, which he bequeathed to the university of Oxford. Junius published *De Picuris Veteribus*, 1637 (in English by the author, 1638; enlarged and improved edition, edited by Grævius, who prefixed a life of Junius, and with a catalogue of architects, painters, &c., and their works, Rotterdam, 1694); *Observationes in Willeramii Abbatis Francicani Paraphrasin Cantice Canticorum*, Amst., 1655; *Annotationes in Harmoniam Latino-Francicam quatuor Evangelistarum, Latine a Tulliano confectam*, Amst., 1655; *Cædmonis Paraphrasin Poeticæ Genesios*, Amst., 1655; *Quatuor D. N. J. C. Evangeliorum Versiones Perantiquas Dux, Gothica scilicet et Anglo-Saxonica*, Dort., 2 vols., 1665 (the Gothic version in this book Junius transcribed from the Silver Codex of Ulfilas; the Anglo-Saxon version is from an edition by Thomas Marshall, whose notes to both versions are given, and a Gothic glossary by Junius); *Etymologicum Anglicanum*, edited by Edmund Lye, and preceded by a life of Junius and Hiekes's Anglo-Saxon grammar, Oxford, 1743. Grævius gives a list of the MSS. presented by Junius to Oxford; the most important are a version of the *Ormulum*, the version of Cædmon, and 9 volumes containing *Glossarium V. Linguarum Septentrionalium*.

**JUNO**, one of the chief goddesses of the Roman state, was identified through the influence of Greek religion with the Hellenic goddess Hera. It is exceedingly unlikely that this identification is grounded on any real connexion between the two, as is the case with Zeus and Jupiter (see **JUPITER**); it was suggested solely by some superficial points of resemblance. There was a certain analogy in the relation which they respectively bore to the chief god; but it is probable that the marriage of Jupiter and Juno is not a native but a borrowed idea. In Latin and in modern literature the character of Juno is wholly that of the Greek Hera (see **HERA**). The opinion is general that Juno is not an Aryan goddess, but adopted from a non-Aryan race; if so, she must be Etruscan. One of the chief cults of Juno in Rome was that of Juno Regina on the Aventine. She had been brought thither by Camillus when Rome conquered the Etruscan city of Veii and adopted its patron goddess Juno. The Etruscan name is apparently Uui (see Deecke, *Das Tempel von Piaccenza*). Another great seat of the worship of Juno was Lanuvium. When that city was conquered, the cultus of Juno Sospita was carried to Rome and established on the Palatine hill. Had Juno been an Aryan goddess, we should certainly find a strong naturalistic element in her; but in fact her sphere is almost entirely limited to human life and action. She must, therefore, have been adopted from some civilized race, where the moral side of the divine conception had been developed, and the naturalistic element which originally belongs to all deities had lost prominence. At Veii, Lanuvium, and other places Juno was the protecting goddess of the state and of society, and in a similar way she had been worshipped at Rome from the earliest times under the epithets *Cariatia* and *Populona*.

The great cultus of Juno at Rome was on the Capitol, where Tarquin had established her beside Jupiter to share with him the sovereignty of the state. Though she has nothing to correspond to the naturalistic side of Jupiter, she is readily associated with him in his moral character. She is the patroness and guardian of women, as he is of men. She watches over women from their birth onward. As *Virginensis* she protects maidenhood; as *Pronuba*, *Juga* or *Jugalis*, *Domiduca*, *Unxia*, *Cinxia*, she ushers them through all the rites of marriage; as *Matrona* she presides over their wedded life; as *Lucina* she helps them in childbirth. The *Kalends* were sacred to Juno, as the *Ides* belong to Jupiter; and thus the two divide the month and the year between them. Geese were her favourite birds, and those which were kept in the Capitoline temple gave the garrison timely warning of the Gallic attack. The chief feast of Juno was the *Matronalia*, on the *Kalends* of March. Only maidens and wives of stainless character could participate in the procession which was made to the temple of *Lucina* on the *Esquiline* hill. On this the first day of the year, the women received presents from their husbands and relatives, and gave presents to their slaves. The name *Junones* was also applied to the attendant spirits who belong to each woman, just as each man has his own genius. A woman swears by her Juno, a lover by the Juno of his mistress; hence the sarcasm of Juvenal, "per Junonem domini jurante ministro." When Rome began to coin money in order to compete with the currency of the Greek states on the south coast, the mint was the temple of Juno *Moneta*; but this was probably due to Greek influence. The coinage was modelled on that of the cities of *Magna Grecia*, which it was designed to supplant; and these cities had their religious centre in the temple of *Hera Lacinia* (see Curtius, "Religious Character of Greek Coins," *Namism. Chron.*, 1870, p. 102).

**JUNOT, ANDOCHÉ** (1771-1813), Duc d'Abrantès, was born at Bussy-le-Grand, 23d October 1771. He went to school at Chatillon, and was known among his comrades as a blustering but loveable creature, with a pugnacious disposition. He came under the special notice of Napoleon during the siege of Toulon, while serving as his secretary. It is related that as he was taking down a despatch, a shell bursting hard by and covering the paper with sand, he exclaimed "Bien! nous n'avions pas de sable pour sécher l'encre! en voici!" He accompanied Napoleon to Italy in the capacity of aide-de-camp, and distinguished himself so much at the battle of *Millesimo* that he was selected to carry back the captured colours to Paris. Returning to Italy he went through the campaign with honour, but was badly wounded in the head at *Lonato*. From the effects of the wound he never completely recovered, and many rash incidents in his career may be directly traced to it. During the expedition to Egypt he acted as general of brigade, and went through fourteen brilliant hours of fighting at *Nazareth*, putting 10,000 Turks to flight with 300 troopers. His devotion to Napoleon involved him in a duel with General *Lanusse*, in which he was again wounded. He had to be left in Egypt to recover, and in crossing to France was captured by English cruisers. On his return to France he was made commandant of Paris, and afterwards promoted general of division. He next served at Arras in command of the grenadiers of the army destined for the invasion of England, and made some alterations in the equipment of the troops which received the praise of the emperor. It was, however, a bitter mortification that he was not appointed a marshal of France when he received the cross of the legion of honour. He was sent to Lisbon instead, his entry into which city was something like a royal progress, though his vanity was disappointed by the mission. He was so restless and dissatisfied in the

Portuguese capital that he set out, without leave, for the army of Napoleon, and at *Austerlitz* behaved with conspicuous courage and zeal. But he soon offended the emperor by his manner and his demands, and was sent to Parma to put down an insurrection and to be out of the way. In 1806 he was recalled and became governor of Paris. His extravagance and prodigality shocked the Government, and some rumours of an intrigue with *Joséphine* made it desirable again to send him away. He was, therefore, appointed to lead an invading force into Portugal. For the first time Junot had a great task to perform, and only his own resources to fall back upon for its achievement. Early in November 1807 he set out from Salamanca, crossed the mountains of *Beira*, rallied his broken forces at *Abrantès*, and, with 1500 men, dashed upon Lisbon. The whole movement only took a month; he was then invested with the governorship. Administration was his weak point, and in a short time, instead of consolidating the results of his victory, he had squandered them by a course of conduct like that of an Eastern monarch. After *Wellesley* encountered him at *Vimiera* he was obliged to withdraw from Portugal with all his forces. Napoleon disapproved, but sent him back to Spain, where, acting under *Massena*, he was once more seriously wounded. His last campaign was made in Russia, and he got more than a just share of the discredit which attached to it. Napoleon next appointed him to govern *Illyria*. On the 29th July 1813 he threw himself from a window at *Montbard*, in a fit of insanity.

**JUNOT, LAURE PERMON** (1784-1838), Duchesse d'Abrantès, was born at Montpellier, 6th November 1784. Her father was an army contractor, who allowed his wife to take his daughters to Paris in order that they might make good matches. They were lively, witty young ladies, and soon attracted to their hotel a mixed society of officers. Madame Junot declared that Napoleon wished to marry her mother; but there is no evidence for the truth of the story. But he gave *Laure Permon* 100,000 francs when she married Junot, and after the birth of her first child a house in the *Champs-Élysées*, with 100,000 francs to furnish it. Her husband had extravagant tastes; but she was extravagant to recklessness, contracting debts as rapidly as tradesmen would allow her to run them up. In 1805 she went with her husband to Lisbon, and, as she took it on her to represent "female France," her train was more expensive than that of a queen. After she returned to Paris, she renewed her extravagance, and, opening her drawing-room to the older families as well as to the new men of the empire, she fell under suspicion. With Junot she went through the Spanish campaign, and contrived to give pleasant balls and to hold drawing-rooms all along the route. After her husband's death she was forbidden to return to Paris, but she ignored Napoleon's order, returned, opened her house again, and attracted to it all the celebrities of the day. Her poverty compelled her to retire to *L'Abbaye-aux-Bois* when the empire ended; but she devoted herself to literature with much zeal. She made social recollections from her own life her chief subject; her style was free and flowing; and her articles, memoirs, and romances were widely read. She died at Paris, 7th June 1838.

**JUPITER** was the chief god of the Roman state. The great and constantly growing influence exerted from a very early period on Rome by the superior civilization of Greece not only caused a modification of the Roman god after the analogy of *Zeus*, the supreme deity of the Greeks, but led the Latin writers to identify the one with the other, and to attribute to Jupiter myths which were purely Greek and never belonged to actual Roman religion. The Jupiter of actual worship was a Roman god; the Jupiter of Latin



literature was more than half Greek. From the Latin this composite deity has passed into modern literature, and under the name of Jupiter is understood a god whose character is half Roman half Greek; while the legends, family history, and posterity attributed to him are wholly Greek. The identification was facilitated by the community of character which really belonged to Jupiter and Zeus as the Roman and Greek developments of the original Aryan conception of God; whereas the analogy between the non-Aryan Juno of Rome and the Aryan Hera of Greece was very slight. As we have in the two gods one original form differently developed by Roman and Greek genius, it is impossible to treat the one without frequent reference to the other; but it is equally necessary to treat them separately. The highest religious conceptions of each race are summed up in the characters of Jupiter and Zeus, and an account of them must be in reality an outline of the growth of religious thought among Romans and Greeks.

Every influence which affected the growth of the Roman state affected also the religion, and along with the development of Rome out of many elements we have a development of the state god Jupiter out of the original Aryan deity. The state, beginning with a mixture of Latin and Sabine population, soon acquired also Etruscan colonists, who were for a time the ruling element in the state; and, although the dynasty was expelled, yet the Etruscan civilization exerted an immense influence on Roman religion. Jupiter, the Vedic *dyans pitar*, invoked by the Greeks as *Zeû páter*, was the god both of Latins and Sabines. He was identified with the Etruscan *Tina*, and acquired something of his character. But another influence was felt at an early period. Greek civilization, spreading from Cumæ, revolutionized Etruscan art and modified Etruscan thought. The influence was strongly exerted in Rome also. Under such various influences grew the Roman religion, and it was completed as a national institution when Tarquin, the same king that received into Rome the prophetic books of the Cumæan Sibyl, enthroned Jupiter Optimus Maximus on the Capitoline hill as the guardian and protector of the fully formed Roman state. Many separate cults of Jupiter, originating from different sections of the mixed state, still continued, but were quite overshadowed by the great worship. Several of these worships puzzled the antiquarians of later Rome, and it became a question how far their objects were identical with or distinct from Jupiter. The ceremonial of these ancient cults, of Vejovis the Asylum-god on the Capitol, of Jupiter Stator on the Palatine, of *Dius Fidius* or *Semo Sancus* on the Aventine, of *Consus* the god of good counsel who ruled in the lower world in the Circus, and of many others, would throw much light on the beginnings of the Roman state; but our information on the subject is very scanty. This being the case, we cannot assign to each influence its exact share in developing the Roman conception, though certain elements may be distinguished as more primitive than others. It is also impossible to distinguish accurately the different cults of Jupiter.

The original naturalistic element, the Græco-Italian god whose power is embodied in the phenomena and the cyclic changes of the heavens, never disappeared. Jupiter or Diespiter is under various epithets, *Lucetius*, *Pluvius*, &c., the god of clear and clouded sky, of light and darkness, of thunder and rain. By the proper ceremonies he can be drawn down in lightning to the earth, as *Elicius* and *Indiges*, to supply it with rain and springs. Every place which he strikes with the lightning is marked as his own, and is surrounded with a wall to keep off the profane from holy ground. As *Averruncus* and *Depulsor*, Jupiter protects men from the effects of the portents that he himself sends from heaven. Through such portents he also reveals

his will to men, and proper interpretation of them will enable men to walk securely before heaven. There can be little doubt that this character as revealer of fate is almost wholly Etruscan, as all the rules of interpretation came from that people. A stone, the symbol of the thunderbolt, was the old symbol of the god, and never became wholly obsolete; hence the phrase *per Jovem lapidem jurare*. Among trees the oak, among birds the woodpecker, were originally sacred to him; but afterwards the eagle and other symbols were, under Greek influence, associated with Jupiter *Cipitolinus*. The identity of many of these attributes with those of the Greek Zeus is obvious. Equally striking is the double character of god both among the dead and among the living which originally belonged to both gods, and was from different causes lost sight of in both cases. In Rome Etruscan influence changed the old views about the nature of the future world; and only some ceremonies, understood by neither priests nor people, preserved the original idea. In nothing was Etruscan influence more conspicuous at Rome than in the gloomy views of the future world that it introduced. The priest of Jupiter, *flamen Dialis*, might not touch a corpse; if his wife, the *flaminica*, died he lost his office. His life was complicated by a multitude of prohibitions: he must not touch a dog or a she-goat, nor see an army, nor take off his pointed cap, nor leave the city for a night, and so on. Violation of any rule, even by accident, entailed impurity on himself and on the whole state, and in some cases made him forfeit his office.

A mortal side in the Roman conception of God is apparent at a very early period, and probably was never wholly wanting. Jupiter is the fatherly ruler of mankind; he protects all the higher elements of human society, guards the sanctity of oaths, the rights of strangers and suppliants, the unity of the state, and the intercourse with other peoples. When a foreign state had injured Rome, it was forbidden to begin war without a formal declaration by the fetiales or heralds, the ministers of Jupiter. Headed by the *pater patrotus populi Romani*, they appealed to Jupiter to witness that they had been wronged, and denounced ruin on the wrong doers. Having thus through his representative on earth solemnly warned the guilty, the god as Victor led his people to conquest. When the army returned, their entry was a religious ceremonial in honour of Jupiter. The general, as representative of Jove, was borne on a gilded chariot drawn by four white horses through the *Porta Triumphalis* to the temple on the Capitol, where he offered a solemn sacrifice to the god, and laid on his knees the victor's laurels. In the ceremony the victorious general was invested with the purple toga, the tunica palmata, the sceptre and crown of gold, which belong to a god not to a man; while the four-horse chariot itself is the symbol of apotheosis. So the *spolia opima* were dedicated by the general who won them to Jupiter Feretrius in the Capitol. Also to Jupiter, as supreme god of the state, the consuls sacrificed when they assumed office, and the young men when they put on the toga virilis. The Ides of the month were always sacred to Jupiter.

The chief festivals celebrated in honour of Jupiter were the *Ludi Romani* and the *Ludi Magi*, the *Ludi Capitolini* instituted in honour of the deliverance of Rome from the Gauls, and the *Ludi Plebei* instituted to commemorate the reconciliation between the two orders in the state. In all of them there was included a feast of the magistrates and senators in the Capitol, to which the three deities, Jupiter, Juno, and Minerva, were invited, and places were left for them. Outside of Rome the chief cultus of Jupiter was that on the Alban mount, where Jupiter Latiaris had been the god who guarded the league of the thirty Latin cities. When Rome destroyed, or rather absorbed, this

league, she kept up the worship that had hallowed it. The *Feria Latina* were celebrated every year by the consuls on a day appointed by themselves before they went forth to war. Accompanied by representatives of the Latin cities, they offered a sacrifice of white oxen to Jupiter. Other festivals of Jupiter show his old character as patron of agriculture, especially the different feasts called *Vinalia*; in this character *Liber*, who was once only a form of Jupiter, had almost entirely supplanted him. The word *liber*, originally an epithet of the chief god, gradually acquired distinct personality, and became the name of a god who was assimilated to the Greek *Dionysus*.

The Romans had in themselves none of the anthropomorphic Greek spirit: while Greek gods were concrete personal beings, Roman gods were almost pure abstractions. The personal element was not wholly wanting, for the gods were conceived as distinguished by sex, and as possessing names which must be concealed lest enemies should know and use them. But to the Roman the gods were little more than spiritual principles of earthly things; each man had his *genius*, the wood had its *Silvanas*. There was no mythology,—no marriages and births of gods, no family relationships. But when Greek influence became powerful, and the Italian deities *Saturnus* and *Ops* had been identified with *Cronos* and *Rhea*, Jupiter like *Zeus* was called their son, and the Greek tales about the conduct of *Zeus* to his parents were applied to the Latin god. On the Capitol Jupiter was enthroned between *Juno* on the left and *Minerva* on the right. The two goddesses now became his wife and his daughter. In like manner the Roman poets attributed to Jupiter all the legends about *Zeus*, and invented new tales and new amours on Italian soil after the analogy of the Greek. The artistic rendering of the conception of Jupiter is wholly borrowed from the Greek, and can be dealt with only in treating of the Greek deity. The first temple on the Capitol was built after the Etruscan model; but, when it was destroyed in 83 B.C., it was rebuilt in Greek style. (W. M. R.A.)

**JURA.** This range may be roughly described as the block of mountains rising between the Rhine and the Rhone, and forming the frontier between France and Switzerland. The gorges by which these two rivers force their way to the plains cut off the Jura from the Swabian and Francoian ranges to the north and those of Dauphiné to the south. But in very early days, before these gorges had been carved out, there were no openings in the Jura at all, and even now its three chief rivers—the Doubs, the Loue, and the Ain—flow down the western slope, which is both much longer and but half as steep as the eastern. Some geographers extend the name Jura to the Swabian and Francoian ranges between the Danube and the Necker and the Main; but, though these are similar in point of composition and direction to the range to the south, it is most convenient to limit the name to the mountain ridges lying between France and Switzerland, and this narrower sense will be adopted here.

The Jura has been aptly described as a huge plateau about 136 miles long and 38 miles broad, hewn into an oblong shape, and raised by internal forces to an average height of from 1950 to 2600 feet above the surrounding plains. The shock by which it was raised, and the vibration caused by the elevation of the great chain of the Alps, produced many transverse gorges or "cluses," while on the plateaus between these subaerial agencies have exercised their ordinary influence.

Geologically, the sedimentary rocks of the Jura belong to the Mesozoic age, and were deposited in a sea of variable depth, traces of which survive in the vast salt mines from which *Salins* and *Lons-le-Saunier* derive their names. The special name of these fossiliferous strata is *Oolitic*;

they are also called *Jurassic*, from the fact that the Jura is entirely made up of such layers. They include sands, sandstones, marls, clays, and limestones; and the water that deposited these strata must have been highly charged with carbonate of lime, since calcareous rocks abound in the Jura. The action on these rocks of the carbonic acid gas discharged by all animals has been to transform them into bicarbonate of lime, a very soluble body, and hence the work of erosion has been much facilitated. The countless blocks of gneiss, granite, and other crystalline formations which are found in such numbers on the slopes of the Jura, and go by the name of "erratic blocks" (of which the best known instance—the *Pierre à Bot*—is 40 feet in diameter, and rests on the side of a hill 900 feet above the Lake of Neuchâtel), have been transported thither from the Alps by ancient glaciers, which have left their mark on the Jura range itself in the shape of striations and moraines.

The general direction of the chain is from north-east to south-west, but a careful study reveals the fact that there were in reality two main lines of upheaval, viz., north to south and east to west, the former best seen in the southern part of the range and the latter in the northern; and it was by the union of these two forces that the lines north-east to south-west (seen in the greater part of the chain), and north-west to south-east (seen in the *Villebois* range at the south-west extremity of the chain), were produced. This is best realized if we take *Besançon* as a centre; to the north the ridges run east and west; to the south, north and south, while to the east the direction is north-east to south-west.

Before considering the topography of the interior of the Jura, it may be convenient to take a brief survey of its outer slopes.

1. The northern face dominates on one side the famous "Trouée" (or Trench) of Belfort, one of the great geographical centres of Europe, whence routes run north down the Rhine to the North Sea, south-east to the Danube basin and Black Sea, and south-west into France and so to the Mediterranean basin. It is now so strongly fortified that it becomes a question of great strategical importance to prevent its being turned by means of the great central plateau of the Jura, which, as we shall see, is a network of roads and railways. On the other side it overhangs the "Trouée" of the Black Forest towns on the Rhine (*Rheinfelden*, *Säckingen*, *Laufenburg*, and *Waldshut*) through which the central plain of Switzerland is easily gained. On this north slope two openings offer routes into the interior of the chain,—the valley of the Doubs belonging to France, and the valley of the Birs belonging to Switzerland. Belfort is the military, Muhlhausen the industrial and Basel the commercial centre of this slope.

2. The eastern and western faces offer many striking parallels. The plains through which flow the Aar and the Saône have each been the bed of an ancient lake, traces of which remain in the lakes of Neuchâtel, Bienne, and Morat. The west face runs mainly north and south like its great river, and for a similar reason the east face runs north-east to south-west. Again, both slopes are pierced by many transverse gorges or "cluses" (due to fracture and not to erosion), by which access is gained to the great central plateau of Poutarlier, though these are seen more plainly on the east face than on the west; thus the gorges at the exit from which *Lons le Saunier*, *Poligny*, *Arbois*, and *Salins* are built balance those of the *Suze*, of the *Val de Ruz*, of the *Val de Travers*, and of the *Val d'Orbe*, though on the east face there is but one city which commands all these important routes—Neuchâtel. This town is thus marked out by nature as a great military and industrial centre, just as *Besançon* on the west, which has besides to defend the route from Belfort down the Doubs. These easy means of communicating with the Free County of Burgundy or *Franche Comté* accounts for the fact that the dialect of Neuchâtel is Burgundian, and that it was held generally by Burgundian nobles, though most of the country near it was in the hands of the house of Savoy until gradually annexed by Bern. The *Chasseron* (5286 feet) is the central point of the eastern face, commanding the two great railways which join Neuchâtel and Poutarlier. It is in a certain sense parallel to the valley of the Loue on the west face, which flows into the Doubs a little to the south of *Dôle*, the only important town of the central portion of the Saône basin. South of the *Val d'Orbe* the east face becomes a rocky wall crowned by all the highest summits of the chain—the *Mont Tendre* (5512 feet), the *Dôle* (5507 feet), the *Reculé* (5643 feet), the *Croix de la Neige* (5653 feet), and the *Grand Croix* (5276



feet), the uniformity of level being as striking as on the west edge of the Jura, though there the absolute height is far less. The position of the Dôle is similar to that of the Chasseron, as along the sides of it run the great roads of the *Col de St Cergues* (4159 feet) and the *Col de la Faucille* (4341 feet), the latter leading through the  *Vallée des Dappes*, which was divided in 1862 between France and Switzerland, after many negotiations. The height of these roads shows that they are passages across the chain, rather than through natural depressions.

3. The southern face is supported by two great pillars—on the east by the *Grand Credo* and on the west by the ridge of *Revermont* (2529 feet) above *Bourg en Bresse*; between these a huge bastion (the district of *Bugey*) stretches away to the south, forcing the Rhone to make a long détour. On the two sides of this bastion the plains in which *Amberieu* and *Culoz* stand balance one another, and are the meeting points of the routes which cut through the bastion by means of deep gorges. On the eastern side this great wedge is steep and rugged, ending in the *Grand Colombier* (5033 feet) above *Culoz*, and it sinks on the western side to the valley of the *Ain*, the district of *Bresse*, and the plateau of *Dombes*. The junction of the *Ain* and the *Surand* at *Pont d'Aio* on the west balances that of the *Valserine* and the *Rhone* at *Bellegarde* on the east.

The Jura thus dominates on the north one of the great highways of Europe, on the east and west divides the valleys of the *Saône* and the *Aar*, and stretches out to the south so as nearly to join hands with the great mass of the *Dauphiné Alps*. It therefore commands the routes from France into Germany, Switzerland, and Italy, and hence its enormous historical importance.

Let us now examine the topography of the interior of the range. This naturally falls into three divisions, each traversed by one of the three great rivers of the Jura—the *Doubs*, the *Loue*, and the *Ain*.

1. In the northern division it is the east and west line which prevails—the *Lomont*, the *Mont Terrible*, the defile of the *Doubs* from *St Ursanne* to *St Hippolyte*, and the “*Trouée*” of the *Black Forest* towns. It thus bars access to the central plateau from the north, and this natural wall does away with the necessity of artificial fortifications. This division falls again into two distinct portions.

(a) The first is the part east of the deep gorge of the *Doubs* after it turns south at *St Hippolyte*; it is thus quite cut off on this side, and is naturally Swiss territory. It includes the basin of the river *Birs*, and the great plateau between the *Doubs* and the *Aar*, on which, at an average height of 2600 feet, are situated a number of towns, one of the most striking features of the Jura. These include *Locle* and *La Chaux de Fonds*, and are mainly occupied with watchmaking, an industry which does not require bulky machinery, and is therefore well fitted for a mountain district.

(b) The part west of the “*Cluse*” of the *Doubs*.—Of this, the district east of the river *Dessoubre*, isolated in the interior of the range (unlike the *Locle* plateau), is called the “*Haute Montagne*,” and is given up to cheese making, curing of hams, saw mills, &c. But little watchmaking is carried on there, *Besançon* being the chief French centre of this industry, and being connected with *Geneva* by a chain of places similarly occupied, which fringe the west plateau of the Jura. The part west of the *Dessoubre*, or the *Moyenne Montagne*, a huge plateau north of the *Loue*, is more especially devoted to agriculture, while along its north edge metal working and manufacture of hardware are carried on, particularly at *Besançon* and *Audincourt*.

2. The central division is remarkable for being without the deep gorges which are found so frequently in other parts of the range. It consists of the basin of which *Pontarlier* is the centre, through notches in the rim of which routes converge from every direction; this is the great characteristic of the middle region of the Jura. Hence its immense strategic and commercial importance. On the north-east roads run to *Morteau* and *Locle*, on the north-west to *Besançon*, on the west to *Salins*, on the south-west to *Dôle* and *Lons-le-Sannier*, on the east to the *Swiss plain*. The *Pontarlier* plateau is nearly horizontal, the slight indentations in it being due to erosion, e.g., by the river *Dugeon*. The keys to this important plateau are to the east the *Fort de Joux*, under the walls of which meet the two lines of railway from *Neuchâtel*, and to the west *Salins*, the meeting place of the routes from the *Col de la Faucille*, from *Besançon*, and from the *French plain*.

The *Ain* rises on the south edge of this plateau, and on a lower shelf or step, which it waters, are situated two points of great military importance—*Nozeroy* and *Champagnole*. The latter is specially important, since the road leading thence to *Geneva* traverses one after another, not far from their head, the chief valleys which run down into the *South Jura*, and thus commands the southern routes as well as those by *St Cergues* and the *Col de la Faucille* from the *Geneva* region, and a branch route along the *Orbe* river from *Jougne*. The fort of *Les Rousses*, near the foot of the *Dôle*, serves as an advanced post to *Champagnole*, just as the *Fort de Joux* does to *Pontarlier*.

The above sketch will serve to show the character of the central Jura as the meeting place of routes from all sides, and the import-

ance to France of its being strongly fortified, lest an enemy approaching from the north-east should try to turn the fortresses of the “*Trouée de Belfort*.” It is in the western part of the central Jura that the north and south lines first appear strongly marked. There are said to be in this district no less than fifteen ridges running parallel to each other, and it is these which force the *Loue* to the north, and thereby occasion its very eccentric course. The cultivation of wormwood wherewith to make the tonic “*absinthe*” has its headquarters at *Poutarlier*.

3. The southern division is by far the most complicated and entangled part of the Jura. The lofty ridge which bounds it to the east forces all its drainage to the west, and the result is a number of valleys of erosion (of which that of the *Ain* is the chief instance), quite distinct from the natural “*cluses*” or fissures of those of the *Doubs* and of the *Loue*. Another point of interest is the number of roads which intersect it, despite its extreme irregularity. This is due to the great “*cluses*” of *Nantua* and *Virieu*, which traverse it from east to west. The north and south line is very clearly seen in the eastern part of this division; the north-east and south-west is entirely wanting, but in the *Villebois* range south of *Amberieu* we have the principal example of the north-west to south-east line. The plateaus west of the *Ain* are cut through by the valleys of the *Valouse* and of the *Surand*, and like all the lowest terraces on the west slope do not possess any considerable towns. The *Ain* receives three tributaries from the east:—

(a) The *Bièvre*, which flows from the fort of *Les Rousses* by *St Claude*, the industrial centre of the *South Jura*, famous for the manufacture of wooden toys, owing to the large quantity of boxwood in the neighbourhood. *Septioncel* is busied with cutting of gems, and *Morez* with watch and spectacle making. Cut off to the east by the great chain, the industrial prosperity of this valley is of recent origin.

(b) The *Oignon*, which flows from south to north. It receives the drainage of the lake of *Nantua*, a town noted for combs and silk weaving, and which communicates by the “*cluse*” of the *Lac de Silan* with the *Valserine* valley, and so with the *Rhone* at *Bellegarde*, and again with the various routes which meet under the walls of the fort of *Les Rousses*, while by the *Val Romey* and the *Sérant* *Culoz* is easily gained.

(c) The *Albarine*, connected with *Culoz* by the “*cluse*” of *Virieu*, and by the *Furan* flowing south with *Belley*, the capital of the district of *Bugey* (the old name for the *South Jura*).

The “*cluses*” of *Nantua* and *Virieu* are now both traversed by important railways; and it is even truer than of old that the keys of the *South Jura* are *Lyons* and *Geneva*. But of course the strategic importance of these gorges is less than appears at first sight, because they can be turned by following the *Rhone* in its great bend to the south.

The name *Jura*, which occurs in *Cæsar* and in *Strabo*, is a form of a word which appears under many forms (e.g., *Joux*, *Jorat*, *Jorasse*, *Juriens*), and is a synonym for a wood or forest. The German name is *Leberberg*, *Leber* being a provincial word for a hill.

Politically the *Jura* is French (departments of the *Doubs*, *Jura*, and *Ain*) and Swiss (parts of the cantons of *Geneva*, *Vaud*, *Neuchâtel*, *Bern*, *Solothurn*, and *Basel*); but at its north extremity it takes in a small bit of *Alsace* (*Pfirt* or *Ferrette*). In the *Middle Ages* the southern, western, and northern sides were parcelled out into a number of districts, all of which were gradually absorbed by the French crown, viz., *Gex*, *Val Romey*, *Bresse*, and *Bugey* (exchanged in 1601 by *Savoy* for the marquisate of *Saluzzo*), *Franche Comté*, or the *Free County of Burgundy*, an imperial fief till annexed in 1674, the county of *Montbéliard* (*Mümpelgard*), acquired in 1793, and the county of *Ferrette* (French 1648–1871). The northern part of the eastern side was held by the bishop of *Basel* as a fief of the empire, but was given to *Bern* in 1815 (as a recompense for its loss of *Vaud*), and now forms the *Bernese Jura*, a French-speaking district. The centre of the eastern slope formed the principality of *Neuchâtel* and the county of *Vallangin*, which were generally held by *Burgundian* nobles, came by succession to the kings of *Prussia* in 1707, and were formed into a *Swiss canton* in 1815, though they did not become free from formal *Prussian* claims until 1857. The southern part of the eastern slope originally belonged to the house of *Savoy*, but was conquered bit by bit by *Bern*, which was forced in 1815 to accept its subject district *Vaud* as a colleague and equal

In the Swiss Confederation. It was Charles the Bold's defeats at Grandson and Morat which led to the annexation by the Confederates of these portions of Savoyard territory.

See *E. F. Berlioux; Le Jura*, Paris, 1880; Adolphe Joanne, *Jura et Alps Française*, Paris, 1877; *Id., Géographie Départementales* (the Doubs, Jura, and Ain volumes); Charles Sauria, *Le Jura pittoresque*.  
(W. A. B. C.)

JURA, an eastern frontier department of France, formed of the southern portion of the old province of Franche-Comté, owes its name to the offshoots and plateaus of the Jura mountains, which occupy more than half its area. It is bounded N. by Doubs, Haute-Saône, and Côte-d'Or; E. by Doubs, Ain, and Switzerland; S. by Ain; and W. by Saône-et-Loire and Côte-d'Or. Lying between 46° 15' and 47° 17' N. lat., and between 5° 15' 39" and 6° 8' 9" E. long., its greatest length from north to south is 143 miles, and its greatest breadth from east to west 83 miles. The department is divided by a not very broad zone of hills into a region of plain in the north and north-west, and a region of mountains in the south-east, increasing in height towards the Swiss frontier. The highest summit is Noir Mont (5085 feet). Jura belongs almost entirely to the basin of the Rhone,—its chief streams being the Oignon, Doubs, and Scille, affluents of the Saône, and the Ain and Valserine, direct tributaries of the Rhone. The Doubs and Ain are navigable. There are numerous lakes; those of Rousses, Châlin, Chamblay, and of the abbey of Grandvaux are noteworthy. The climate is, on the whole, cold; the temperature is subject to sudden and violent changes, and among the mountains winter lingers for nearly six months. The plain called the Bresse is rich in fruit trees, and in fields of wheat, rye, maize, and buckwheat; the hill-region grows vines, barley, oats, maize, rape, walnuts, and fruits; the mountains, which exhibit some of the grandest scenery of leaping torrent and silent tarn, are covered with forests or pastures. Jura is one of the most thickly wooded departments of France; a third of its surface is covered with forests, of which that of Chaux, with an area of about 75 square miles, is the largest. The commonest trees are oaks, beeches, hornbeams, aspens, birches, box-trees and firs. Wolves and foxes are numerous in Jura; wild boars and deer lurk in the forests. The principal minerals are iron, salt, limestone, marble, sandstone, millstone, and clay. Peats are very abundant. Agriculture employs about three-fourths of the inhabitants, though the manufactures extend to wine, cheese (made in the mountain dairies), watches, files, stationery, toys and fancy wooden-ware, machinery, candles, porcelain, basket-work, &c.; while some industry is maintained in wool-spinning, silk-weaving, and in brass, pottery, and tanning works. The trade is mainly in wines, cheese, and wooden goods. The first are full-bodied, stout, and rather coarse-flavoured; their chief market is Paris, where they form the basis of the *vin ordinaire* of the wine-shops. The department of Jura embraces the arrondissements of Lons-le-Saunier, Dôle, Poligny, and St Claude, with 32 cantons and 583 communes. Lons-le-Saunier is the chief town. The total area is about 1928 square miles; the population in 1866 was 298,477; in 1876, 288,823.

JURA, an island of the inner Hebrides, on the west coast of Argyllshire, Scotland, the fourth largest of the group, is situated between 55° 52' and 56° 9' N. lat., and 5° 43' and 6° 8' W. long. On the north it is separated from the island of Scarba by the whirlpool of Corryvreckan, on the east from the mainland by Jura Sound, which is 10 miles broad, and on the south and south-west from Islay by Islay Sound. The area is about 160 square miles, the greatest length about 27 miles, and the breadth about 6. A chain of rugged hills, rising into

eminences called the Paps of Jura, the highest summit of which is 2500 feet, traverses the whole extent of the island, interrupted only by Tarbert Loch, an arm of the sea, which forms an indentation into the island of nearly 6 miles, and almost cuts it in two. Jura derived its name, meaning "deer island," from the red deer which abounded on it. On the pasturage a considerable number of black cattle are raised; and some corn and potatoes are cultivated along the eastern shore. Fishing is prosecuted to a small extent. The population, which in 1851 was 1064, was 781 in 1881.

JURIEU, PIERRE (1637–1713), a French Protestant theologian, was born in 1637 at Mer, in Orléanais, where his father was a Protestant pastor. He studied at Saumur and afterwards at Sedan under his maternal grandfather the famed theologian Pierre Dumoulin, who died about the time that Jurieu left Sedan. After completing his studies in England under his maternal uncle Dumoulin, Jurieu received episcopal ordination there, and returning to France succeeded his father as pastor of the church at Mer. In 1671 he accepted the chair of theology and Hebrew at Sedan, where he soon afterwards became also pastor. Both as preacher and professor he obtained a very high reputation, but much of the legitimate influence of his talents was destroyed by the extreme warmth of his controversial temper, which frequently developed into an irritated fanaticism verging on insanity. On the suppression of the academy of Sedan in 1681, Jurieu received an invitation to a church at Rouen, but, dreading persecution on account of a work he was about to publish, entitled *La Politique du Clergé de France*, he went to Holland and became soon after pastor of the Walloon church of Rotterdam, an office which he occupied till his death, 11th January 1713.

Deeply pained by the revocation of the Edict of Nantes Jurieu turned for consolation to the prophecies of the Apocalypse, and succeeded in persuading himself that the overthrow of Antichrist would take place in 1689, and afterwards, when that year had passed without the fulfilment of the prophecy, in 1715. Jurieu defended the doctrines of Protestantism with great ability against the attacks of Arnauld and Bossuet, but was equally ready to enter into dispute with his fellow Protestant divines when their opinions differed from his own even on minor matters. The bitterness and persistency of his attacks on his colleague Bayle led to the latter being deprived of his chair in 1693. In his favour it must, however, be mentioned that he was actuated in his controversies not by a mean jealousy of his opponents but by a sincere anxiety for truth. One of the most important works of Jurieu is *Lettres Pastorales adressées aux Fidèles de France*, 3 vols., Rotterdam, 1686 and 1687, which found its way into France notwithstanding the vigilance of the police, and produced a deep impression on the Protestant population. Besides his numerous other controversial writings, which deal with nearly every topic in regard to which difference of opinion was possible, Jurieu was the author of a *Traité de la Dévotion*, Rouen, 1674.

#### JURISPRUDENCE. SE LAW.

JURY. The essential features of trial by jury as practised in England and countries influenced by English ideas are the following. The jury are a body of laymen selected by lot to ascertain, under the guidance of a judge, the truth in questions of fact arising either in a civil litigation or in a criminal process. They are generally twelve in number, and their verdict, as a general rule, must be unanimous. Their province is strictly limited to questions of fact, and within that province they are still further restricted to the exclusive consideration of matters that have been proved by evidence in the course of the



trial. They must submit to the direction of the judge as to any rule or principle of law that may be applicable to the case; and, even in deliberating on the facts, they receive, although they need not be bound by, the directions of the judge as to the weight, value, and materiality of the evidence submitted to them. Further, according to the general practice, they are selected from the inhabitants of the locality, whether county or city, within which the cause of action has arisen or the crime has been committed, so that they bring to the discharge of their duties a certain amount of independent local knowledge, an element in the institution which is by no means to be ignored. Such in general terms is the famous judicial institution the development of which is generally regarded as one of the greatest achievements of English jurisprudence.

What is the origin of this very remarkable and characteristic system? That is a question which has engaged the attention of many learned men. The fullest discussion of the subject is contained in Forsyth's *Trial by Jury*, published in 1852, and more concise notices of the various theories that have been advanced will be found in Stubbs's *Constitutional History*, vol. i., and in Freeman's *Norman Conquest*, vol. v. Until quite recently this, like all other institutions, was popularly regarded as the work of a single legislator, and in England it is one of the achievements usually assigned to Alfred. It is needless to say that there is no historical foundation whatever for such a supposition, nor is it much more correct to regard it as "copied from this or that kindred institution to be found in this or that German or Scandinavian land," or brought over ready made by Hengist or by William.<sup>1</sup> "Many writers of authority," says Canon Stubbs, "have maintained that the entire jury system is indigenous in England, some deriving it from Celtic tradition based on the principles of Roman law, and adopted by the Anglo-Saxons and Normans from the people they had conquered. Others have regarded it as a product of that legal genius of the Anglo-Saxons of which Alfred is the mythic impersonation, or as derived by that nation from the customs of primitive Germany or from their intercourse with the Danes. Nor even when it is admitted that the system of recognition was introduced from Normandy have legal writers agreed as to the source from which the Normans themselves derived it. One scholar maintains that it was brought by the Norsemen from Scandinavia; another that it was derived from the processes of the canon law; another that it was developed on Gallic soil from Roman principles; another that it came from Asia through the crusades," or was borrowed by the Angles and Saxons from their Slavonic neighbours in northern Europe. The true answer is that forms of trial resembling the jury system in various particulars are to be found in the primitive institutions of all nations. That which comes nearest in time and character to trial by jury is the system of recognition by sworn inquest, introduced into England by the Normans. "That inquest," says Mr Stubbs, "is directly derived from the Frank capitularies, into which it may have been adopted from the fiscal regulations of the Theodosian code, and thus own some distant relationship with the Roman jurisprudence." However that may be, the system of recognition consisted in questions of fact, relating to fiscal or judicial business, being submitted by the officers of the crown to sworn witnesses in the local courts. It is pointed out by Mr Freeman that the Norman rulers of England were obliged, more than native rulers would have been, to rely on this system for accurate information. They needed to have a clear and truthful account of disputed points set before them, and such an account was sought for in the oaths of

the recognitors.<sup>2</sup> The Norman Conquest, therefore, fostered the growth of those native germs common to England with other countries out of which the institution of juries grew. Recognition, as introduced by the Normans, is only, in this point of view, another form of the same principle which shows itself in the compurgators, in the *frithbock*, in every detail of the action of the popular courts before the Conquest. Admitting with Mr Stubbs that the Norman recognition was the instrument which the lawyers in England ultimately shaped into trial by jury, Mr Freeman maintains none the less that the latter is a distinctively English thing. Mr Forsyth comes to substantially the same conclusion. Noting the jury germs of the Anglo-Saxon period, he shows how out of those elements, which continued in full force under the Anglo-Normans, was produced at last the institution of the jury. "As yet it was only implied in the requirement that disputed questions should be determined by the voice of sworn witnesses taken from the neighbourhood, and deposing to the truth of what they had seen or heard." What was wanting was to mould the procedure into shape, and that it did not attain until a century after the Conquest.

The inquest by recognition, which was employed generally for the ascertainment of facts, as for example in assessing taxation, is exemplified in legal matters by the process known as the assize or the great assize, applicable to questions affecting freehold or status. Defendant in such an action was enabled by an enactment of Henry II. to decline the trial by combat and choose the trial by assize, which was conducted as follows. The sheriff summoned four knights of the neighbourhood, who being sworn chose twelve lawful knights who were most cognizant of the facts, who should determine on their oaths which had the better right to the land. If they all knew the facts and were agreed as to their verdict, well and good; if some or all were ignorant, the fact was certified in court, and new knights were named, until twelve were found to be agreed. The same course was followed when the twelve were not unanimous. New jurors, as they may be called, were added until the twelve were agreed. This was called enforcing the assize. At this point the knowledge on which the jurors acted was their own personal knowledge, acquired independently of the trial. "So entirely," says Forsyth, "did they proceed upon their own previously formed view of the facts in dispute that they seem to have considered themselves at liberty to pay no attention to evidence offered in court, however clearly it might disprove the case which they were prepared to support." The use of recognition is prescribed by the constitutions of Clarendon for cases of dispute as to lay or clerical tenure. See Forsyth, p. 131; Stubbs, vol. i. p. 617.

In criminal cases there appears to be a more complete approximation to the jury in Anglo-Saxon times in the twelve senior thegns, who, according to an ordinance of Æthelred II. were sworn in the county court that they would accuse no innocent man and acquit no guilty one. The twelve thegns were a jury of presentment or accusation, like the grand jury of later times, and the absolute guilt or innocence of those accused by them had to be determined by subsequent proceedings—by compurgation or the ordeal. Whether this is the actual origin of the grand jury or not, the assizes of Clarendon and Northampton establish the criminal jury on a definite basis. By the articles of visitation of 1194, four knights are to be chosen from the county who by their oath shall choose two lawful knights of each hundred or wapintake, or, if knights be wanting, free and legal men, so that the twelve may answer for all

<sup>2</sup> This fact would account for the remarkable development of the system on English ground, as contrasted with its decay and extinction in France.

<sup>1</sup> Freeman, *Norman Conquest*, vol. v. p. 451.

matters within the hundred, including, says Stubbs, "all the pleas of the crown, the trial of malefactors and their receivers, as well as a vast amount of civil business." This is the historical grand jury. The petty jury, as it is called, which is the real jury of trial, appears to have arisen as an alternative to the trial by ordeal. A person accused by the inquest of the hundred was allowed to have the truth of the charge tried by another and different jury.<sup>1</sup> "There is," says Forsyth, "no possibility of assigning a date to this alteration." "In the time of Bracton (middle of the 13th century) the usual mode of determining innocence or guilt was by combat or appeal. But in most cases the appellant had the option of either fighting with his adversary or putting himself on his county for trial"—the exceptions being murder by secret poisoning, and certain circumstances presumed by the law to be conclusive of guilt. Some doubt has been expressed whether the twelve jurors who tried the crime were not identical with the accusing jurors, but the separation between the two juries was at any rate complete in the reign of Edward III. (Forsyth, p. 206).<sup>2</sup>

So far we have arrived at the establishment of the jury system in its modern form, alike in civil and in criminal proceedings; and, whatever differences may be traceable in the history of the civil and criminal jury respectively, their subsequent development is one. And there is one great feature by which the jury at the stage we have now reached is distinguished from the jury of modern times. The jury still certify to the truth from their knowledge of the facts, however acquired. In other words, they still retain the character of witnesses. The complete withdrawal of that character from the jury is connected by Forsyth with the ancient rules of law as to proof of written instruments, and a peculiar mode of trial *per sectam*. When a deed is attested by witnesses, you have a difference between the testimony of the witness, who deposes to the execution of the deed, and the verdict of the jury as to the fact of execution. It has been contended with much plausibility that in such cases the attesting witnesses formed part of the jury. Forsyth doubts that conclusion, although he admits that, as the jurors themselves were originally mere witnesses, there was no distinction in principle between them and the attesting witnesses, and that the attesting witnesses might be associated with the jury in the discharge of the function of giving a verdict. However that may be, in the reign of Edward III., although the witnesses are spoken of "as joined to the assize," they are distinguished from the jurors. The trial *per sectam* was used as an alternative to the assize or jury, and resembled in principle the system of compurgation. The claimant proved his case by vouching a certain number of witnesses (secta), who had seen the transaction in question, and the defendant rebutted the presumption thus created by vouching a larger number of witnesses on his own side. In cases in which this was allowed, the jury did not interpose at all, but in course of time the practice arose of the witnesses of the secta telling

<sup>1</sup> The distinction between the functions of the grand jury, which presents or accuses criminals, and the petty jury, which tries them, has suggested the theory that the system of compurgation is the origin of the jury system—the first jury representing the compurgators of the accuser, the second the compurgators of the accused.

<sup>2</sup> The number of the jury (twelve) is responsible for some unfounded theories of the origin of the system. This use of twelve is not confined to England, nor in England or elsewhere to judicial institutions. "Its general prevalence," says Hallam (*Middle Ages*, chap. viii.), "shows that in searching for the origin of trial by jury we cannot rely for a moment upon any analogy which the mere number affords." In a *Guide to English Juries*, by a Person of Quality, 1682 (attributed to Lord Somers), the following passage occurs: "In analogy of late the jury is reduced to the number of twelve, like as the prophets were twelve to foretell the truth; the apostles twelve to preach the truth; the discoverers twelve, sent into Canaan to seek and report the truth; and the stones twelve that the heavenly Jerusalem is built on." Lord Coke indulged in similar speculations.

their story to the jury. In these two instances we have the jury as judges of the facts sharply contrasted with the witnesses who testify to the facts; and, with the increasing use of juries and the development of rules of evidence, this was gradually established as the true principle of the system. In the reign of Henry IV. we find the judges declaring that the jury after they have been sworn should not see or take with them any other evidence than that which has been offered in open court. But the personal knowledge of the jurors was not as yet regarded as outside the evidence on which they might found a verdict, and the stress laid upon the selection of jurymen from the neighbourhood of the cause of the action shows that this element was counted on, and, in fact, deemed essential to a just consideration of the case. Other examples of the same theory of the duties of the jury may be found in the language used by legal writers. Thus it has been said that the jury may return a verdict although no evidence at all be offered, and again, that the evidence given in court is not binding on the jury, because they are assumed from their local connexion to be sufficiently informed of the facts to give a verdict without or in opposition to the oral evidence. A recorder of London, *temp.* Edward VI., says that, "if the witnesses at a trial do not agree with the jurors, the verdict of the twelve shall be taken and the witnesses shall be rejected." Forsyth suggests as a reason for the continuance of this theory that it allowed the jury an escape from the *attaint*, by which penalties might be imposed on them for delivering a false verdict. They could suggest that the verdict was according to the fact, though not according to the evidence. With the disuse of attaints, the contrary rule came in, and it was established that where a jurymen is acquainted with material facts he should tell the court in order that he may be sworn as a witness; and it was clearly laid down by Lord Ellenborough that, if a judge directed the jury that they might be guided by their own knowledge of the facts independently of the evidence, such a direction would be wrong.

The ordinary jury in civil and criminal trials has now been traced down to the point at which its constitution became stereotyped. An important point still wants some historical explanation. The rule requiring a unanimous verdict has been variously accounted for, but Mr Forsyth's explanation appears conclusive. He regards the rule as intimately connected with the original character of the jury, as a body of witnesses, and with the conception common in primitive society that safety is to be found in the number of witnesses, rather than the character of their testimony. The affording of the jury above described marks an intermediate stage in the development. Where the juries were not unanimous new jurors were added until twelve were found to be of the same opinion. From the unanimous twelve selected out of a larger number to the unanimous twelve constituting the whole jury was a natural step, which, however, was not taken without some hesitation. In some old cases we find that the verdict of eleven jurors out of twelve was accepted, but it was decided in the reign of Edward III. that the verdict must be the unanimous opinion of the whole jury. Diversity of opinion was taken to imply perversity of judgment, and the law sanctioned the application of the harshest methods to produce unanimity. The jurors were not allowed to eat or drink but by leave of the justices; and they might be carried round the circuit in carts until they agreed. These rough enforcements of an unanimous verdict have been softened by later practice, but the rule itself remains.

We may now turn to the jury in actual operation. And let us notice first the various kinds of jury known to English law.

1. *The Grand Jury*.—The origin of this has been ex-



plained above. This is the jury which presents indictments for trial by the petty or ordinary jury. The sheriff is directed to summon twenty-four or more persons, out of whom the jury may be chosen; but not more than twenty-three are to be chosen, so that twelve may be a majority.<sup>1</sup> The verdict of less than twelve, although a majority of the whole body, cannot be accepted, but the verdict of twelve is sufficient although the others may dissent. The grand jury, after a general charge from the judge, consider the bills of indictment in private, hearing such of the witnesses as they think fit. If they consider that a *prima facie* case is made out against the accused, they return the indictment into court as a true bill, which then becomes the foundation of the process before the petty jury. If they think otherwise they *ignore* the bill, or send it back into court torn up. They have thus a kind of veto on the cases submitted for trial. As these for the most part have been previously investigated by magistrates who have committed the accused for trial, the utility of the grand jury depends very much on the character of the justices' courts. As a review of the discretion of stipendiary magistrates in committing cases for trial, the judgment of the grand jury is admittedly superfluous; and even when the committing justice is an unlearned magistrate, it seems very doubtful if much is gained by subjecting his open decisions to the control of a secret tribunal. It used to be urged by the defenders of the system that it secures the attendance of the landed gentry and the county justices at the assizes—a kind of argument which is no longer so cogent as it once was. Mr Forsyth thinks that the grand jury will often baffle “the attempts of malevolence” by ignoring a malicious and unfounded prosecution, but they may also defeat the ends of justice, and they have done so ere now, by shielding a criminal with whom they have strong political or social sympathies. The qualification of the grand jurymen is that they should be freeholders of the county,—to what amount appears to be uncertain.

2. The *Coroner's Jury* is undeterminate in number, but the finding must be that of twelve at least of the jurymen. Persons found guilty on this inquest may be put on trial before a petty jury at assizes.

3. *Special and Common Juries.*—This distinction belongs properly to civil trials. The practice of selecting special jurors to try important cases appears to have sprung up without legislative enactment, in the procedure of the courts. Forsyth says that the first statutory recognition of it is so late as 3 Geo. II. c. 25, and that in the oldest book of practice in existence (Powell's *Attorney's Academy*, 1623) there is no allusion to two classes of jurymen. The Acts, however, which regulate the practice allude to it as well established. The statute now in force (33 & 34 Vict. c. 7) defines the class of persons entitled and liable to serve on special juries thus:—every man whose name shall be on the juror's book for any county, &c., and who shall be legally entitled to be called an esquire, or shall be a person of higher degree, or a banker or merchant, or who shall occupy a house of a certain rateable value (*e.g.*, £100 in a town of 20,000 inhabitants, £50 elsewhere), or a farm of £300, or other premises at £100. A special jurymen receives a fee of a guinea for each cause. Either party may obtain a special jury, but must pay the additional expenses created thereby unless the judge certifies that it was a proper case to be so tried. For the common jury any man is qualified and liable to serve who has £10 by the year in land or tenements of freehold, copyhold, or customary tenure; or £20 on lands or tenement held by lease for twenty-one years or longer, or who being a house-

holder is rated at £30 in Middlesex or £20 in any other county. See 6 Geo. IV. c. 50; and 33 & 34 Vict. c. 77 (the Juries Act). A schedule to the last-cited Act contains a list of the numerous classes of persons exempted from service, which include members of the legislature and judges, ministers of various denominations, and practising lawyers of all grades. These are juries invariably employed in the superior courts. In the county court the jury consists of five.

Formerly aliens were entitled to be tried by a jury *ae meliitate linguae*—half being Englishmen and half foreigners, not necessarily of the same country as the accused. This privilege has been abolished by the Naturalization Act.

A jury of *matrons* is resorted to, in a writ *de ventre inspiciendo*, or when a female prisoner, condemned to death, pleads pregnancy in stay of execution.

From the beginning parties have been allowed to challenge the jury. In civil and criminal cases a challenge for cause is allowed; in criminal cases only, a peremptory challenge is also allowed. In the former case the challenge may be either to the *array*, *i.e.*, to the whole number of jurors returned, or to the *polls*, *i.e.*, to the jurors individually. A challenge to the array is either a *principal* challenge (on the ground that the sheriff is a party to the cause, or related to one of the parties), or a challenge for *favour* (on the ground of circumstances implying “at least a probability of bias or favour in the sheriff”). A challenge to the polls is an exception to one or more jurymen on either of the following grounds:—(1) *propter honoris respectum*, as when a lord of parliament is summoned; (2) *propter defectum*, for want of qualification; (3) *propter affectum*, on suspicion of bias or partiality; and (4) *propter delictum*, when the juror has been convicted of an infamous offence. The challenge *propter affectum* is, like the challenge to the array, either principal challenge or “to the favour.” Prisoners in criminal trials were by common law entitled to a peremptory challenge without cause shown to the number of thirty-five jurors; and so the law remains, after some fluctuation, in the case of treason. In other cases it is limited to twenty. The crown is no longer entitled to a peremptory challenge as at common law; but the cause of challenge need not be assigned by the crown until the whole list has been gone through, or unless there remain no longer twelve jurors left to try the case, exclusive of those challenged—an arrangement which practically amounts to giving the crown the benefit of a peremptory challenge.

One other special point remains to be mentioned. The province of the jury is to judge of facts; they have nothing to do with the law—which they must take from the presiding judge at the trial. The old *decantatum* assigns to each his own independent function:—“Ad questionem legis iudices respondent, ad questionem facti juratores.” But, while the jury are supposed in legal theory to be absolute masters of the questions of fact, in practice they are largely controlled by the judges. Not only does the judge at the trial decide as to the admissibility of questions, but he advises the jury as to the logical bearing of the answers on the issue. Further, after a jury has given its verdict, it may be challenged in the courts on the ground that it is against the evidence, or on the ground that there was no evidence to go before the jury. A verdict is said to be against the evidence when the jury have completely misapprehended the facts proved,—when the logical conclusion to be drawn from the facts is the opposite of that which the jury have drawn. The court will not disturb the verdict of a jury on this ground when the judge who presided at the trial is not dissatisfied with the verdict.<sup>1</sup> And it has been ruled emphatically that, when there is conflicting testimony as to the point at issue, it is exclusively

<sup>1</sup> Blackstone puts the principle as being that no man shall be convicted except by the unanimous voice of twenty-four of his equals or neighbours—twelve on the grand, and twelve on the petty jury.

For the jury to say which side is to be believed, and the court will not interfere with the verdict. To upset a verdict on the ground that "there was no evidence to go to the jury" implies that the judge at the trial ought to have withdrawn the case. The meaning of the phrase "evidence to go before the jury" is nowhere definitely ascertained, and a consideration of decided cases makes the difficulty more apparent. The question arises most frequently perhaps in cases involving an imputation of negligence—*e.g.*, in an action of damages against a railway company for injuries sustained in a collision. Juries are apt to infer negligence very easily, and the court has to say whether, on the facts proved, there was any evidence of the defendant's being guilty of negligence. This is by no means the same thing as saying whether, in the opinion of the court, they were so guilty. The court may be of opinion that on the facts they were not guilty, yet the facts themselves may be of such a nature as to be evidence of guilt to go before a jury. When the facts proved are such that a reasonable man might have come to the conclusion that there was negligence, then, although the court may wholly reject the conclusion in its own mind, it must admit that there is evidence to go before the jury. That perhaps is as near as we have yet got to an understanding of a phrase in daily use in the superior courts; but it scarcely determines what relation between the facts proved and the conclusion to be established is necessary to make the facts evidence from which a jury may infer the conclusion. The true explanation is to be found in the principle of relevancy. Any fact which is relevant to the issue constitutes evidence to go before the jury, and any fact, roughly speaking, is relevant between which and the fact to be proved there may be a connexion as cause and effect. See EVIDENCE. When the question is what damages the plaintiff has sustained, the court openly undertakes to review their decision on its merits—although this is as much a question of fact as any other. If the court deems the damages excessive, it will order a new trial to take place,—generally adding the condition that the verdict may stand if the plaintiff will accept a reduced sum for damages, which in effect amounts to the court itself finding a verdict.

The function of the jury in libel cases was in the last century the subject of a celebrated controversy which ended in the passing of Fox's Libel Act in 1792. Lord Mansfield and the judges held that the criminality or innocence of an act done, including any paper written, is matter of law and not matter of fact, an undeniable proposition then and since. They had also been in the habit of directing the jury to consider only the question of publication, telling them that its guilt or innocence was not for them to decide. Fox's Act declares and enacts that the jury may give a general verdict of guilty or not guilty in libel cases, and shall not be required or directed by the court or judge to find a verdict of guilty on proof of publication and of the sense ascribed to it by the prosecution.

Of the merits of the institution little space is left to speak. The present English jury has at least one conspicuous defect in the requirement of unanimity; yet, so far as that is concerned, in practice it produces hardly any appreciable evil. All that Bentham and others have urged against it—the application of a kind of torture to force conviction on the minds of jurors, the indifference to veracity which the concurrence of unconvinced minds must produce in the public mind, the probability that jurors will disagree and trials be rendered abortive, and the absence of any reasonable security in the unanimous verdict that would not exist in the verdict of a majority—all this is undeniably true. Yet we rarely hear of juries disagreeing or of jurors agreeing under compulsion. When civil juries were established in Scotland, this was one

of the arguments used against the experiment, but it has been stated by the judge, Mr Commissioner Adam, under whom the system was started, that he only knew of one instance of disagreement during a period of twenty years. English experience is much the same, and a reform which twenty or thirty years ago was pronounced absolutely necessary by conservative jurists is now hardly ever heard of. Practically juries have no difficulty in coming to a unanimous verdict; and, if a guess may be hazarded on so wide a subject, they have probably less difficulty now than ever. One cause of that result may be the deference which juries invariably pay to the carefully suggested opinion of the judge—arising no doubt from such perfect confidence in the bench as did not always exist, and would not always have been deserved if it had existed.

But, apart from any incidental defects, it may be doubted whether, as an instrument for the investigation of truth, the jury deserves all the encomiums which have been passed upon it. In criminal cases, especially of the graver kind, it is perhaps the best tribunal that could be devised. There the element of moral doubt enters largely into the consideration of the case, and that can best be measured by a popular tribunal. Opinion in England is unanimously against subjecting a man to serious punishment as a result of conviction before a judge sitting without a jury, and the judges themselves would be the first to deprecate so great a responsibility. But in civil causes, where the issue must be determined one way or the other on the balance of probabilities, a single judge would probably be a better tribunal than the present combination of judge and jury. Even if it be assumed that he would on the whole come to the same conclusion as a jury deliberating under his directions, he would come to it more quickly. Time would be saved in taking evidence, summing up would be unnecessary, and the addresses of counsel would inevitably be shortened and concentrated on the real points at issue.

*The Jury in Scotland.*—According to the *Regium Majestatem*, which is identical with the treatise of Glanvill on the law of England (but whether the original or only a copy of that work is a question which need not delay us), trial by jury existed in Scotland for civil and criminal cases from as early a date as in England, and there is reason to believe that at all events the system became established at a very early date. Its history was very different from that of the English jury system. In Scotland trial by jury survived for criminal trials, but became extinct in civil cases. In the criminal assize the jury has always consisted of fifteen persons chosen from the jury lists, general and special, drawn up by the sheriff,—one-third of the jury being chosen from the special, and two-thirds from the general list. The verdict is to be that of the majority of the jury, and formerly it had to be expressed in writing, but may now be delivered *viva voce* by the chancellor or foreman. Besides the "guilty" or "not guilty" to which the English jury is restricted, a Scotch jury may bring in a verdict of "not proven," which has legally the same effect as "not guilty" in releasing the accused from further charge, while it practically inflicts upon him the stigma of moral guilt for the rest of his life.

The civil jury was reintroduced in Scotland by the Act 55 Geo. III. c. 42, mainly on account of the difficulty which Scotch appeals turning on questions of fact presented to the House of Lords. Originally the juries were appointed to try issues sent from the Court of Session under the direction of three lords commissioners, but afterwards the procedure by jury was united with the ordinary business of the court, and the special tribunal of commissioners was abolished. The jury was copied strictly from the English practice: the jurors are twelve in number, and their verdict must be unanimous. If they fail to agree within twelve (now six) hours, they must be discharged. This experiment was not at first popular, and it is doubtful if it had even now become assimilated to Scotch practice.

*United States.*—Trial by jury according to the English system has been incorporated into the constitution of the United States. There was at one time some controversy as to whether the civil jury was included or not. The three articles (III., V., and VI.) in which allusion to trial by jury is made refer to criminal proceedings only, and, moreover, the supreme court is declared to have appellate jurisdiction both as to law and fact. It has accordingly been provided by one of the amendments to the constitution that, in suits at common law where the value in controversy shall exceed twenty dollars, the right of trial by jury shall be preserved;



and no fact tried by a jury shall be otherwise re-examined in any court of the United States than according to the rules of the common law. "Throughout the Union in all trials, whether civil or criminal, unanimity in the jury is essential" (Forsyth, 344).

In France there is no grand jury, and no civil jury. The jury in a criminal case find their verdict by a majority. (E. R.)

JUSSIEU, DE, the name of a distinguished French family, which came into prominent notice towards the close of the 16th century, and for a century and a half was illustrious for the botanists it produced. The following are its more eminent members.

I. ANTOINE DE JUSSIEU (1686-1758), born at Lyons in 1686, was the earliest in point of time of the line of distinguished botanists of his name. He was the son of Christophe de Jussieu (or Dejussieu), an apothecary of some repute, who published a *Nouveau traité de la thériaque*, Trévoux, 1708. Antoine studied at the university of Montpellier, and travelled with his brother Bernard through Spain, Portugal, and southern France. He came to Paris in 1708, Tournefort, whom he succeeded, dying in that year. His own original publications are not of marked importance, but he edited an edition of Tournefort's *Institutiones rei herbariæ*, Paris, 1719, 3 vols. He performed a similar office for a posthumous work of Barrelier, *Plantæ per Galliam, Hispaniam, et Italiam observatæ*, &c., Paris, 1714. He practised medicine, chiefly devoting himself to the very poor. He died at Paris, 22d April 1758.

II. BERNARD DE JUSSIEU (1699-1777), a younger brother of the above, was also born at Lyons, in 1699. He was educated for the medical profession, took his doctor's degree at Montpellier, and commenced practice in 1720, but his sensitive temperament hindered his prosecution of it, and on his brother's invitation he gladly joined him in Paris in 1722. He succeeded Vaillant as sub-demonstrator of plants in the Jardin du Roi, and his principal duties consisted in superintending the herborizations of the students. His knowledge of plants and even of non-botanical subjects was so great that he readily detected and named the component parts of made-up plants which were sometimes submitted to him. It is reported that at one of these excursions, whilst Linnæus was his guest, the students having brought some such counterfeit to be named by the young Swede, his reply was "Aut Deus, aut D. de Jussieu." In 1725 he brought out a new edition of Tournefort's *Histoire des plantes qui naissent aux environs de Paris*, in 2 vols., which was afterwards translated into English by John Martyn,—the original work being incomplete. In the same year he was admitted into the Académie des Sciences, and communicated several papers to that body. Long before Tremblay published his *Histoire des polypes d'eau douce*, he maintained the doctrine that these organisms were animals, and not the flowers of marine plants, then the current notion; and to confirm his views he made three journeys to the coast of Normandy. Singularly modest and retiring, he published very little, but in 1759 he arranged the plants in the royal garden of the Trianon at Versailles, according to his own scheme of classification. This arrangement is printed in his nephew's *Genera*, pp. lxi.iii.-lxx., and formed the basis of that work. He cared little for the credit of enunciating new discoveries, so long as the facts themselves were made public. On the death of his brother Antoine, he could not be induced to succeed him in his office, but prevailed upon Lemonnier to assume the higher position. He died at Paris, 6th November 1777.

III. JOSEPH DE JUSSIEU (1704-1779), brother of Antoine and Bernard, was born at Lyons 3d September 1704. Educated like the rest of the family for the medical profession, he accompanied La Condamine to Peru, in the expedition for measuring an arc of meridian,

and remained in South America for thirty-six years, returning to France in 1771. His health having previously failed, his works were never printed, and remain in manuscript. During his long absence, he was a member of the Académie des Sciences, although for thirty-five years he never came near the place where that body held its deliberations. Amongst the seeds he sent to Bernard were those of *Heliotropium peruvianum*, Linn., then first introduced into Europe. He died at Paris, 11th April 1779.

IV. ANTOINE LAURENT DE JUSSIEU (1748-1836), nephew of the three preceding, was born at Lyons on 12th April 1748. Called to Paris by his uncle Bernard, and carefully trained by him for the pursuits of medicine and botany, he largely profited by the opportunities afforded him. Gifted with a tenacious memory, and the power of quickly grasping the salient points of subjects under observation, he steadily worked at the improvement of that system of plant-arrangement which had been sketched out by his uncle. In 1789 was issued his *Genera plantarum secundum ordines naturales disposita, juxta methodum in horto regio Parisiensi exaratum, anno MDCCCLXXIV*, Paris, 8vo. The influence of this volume is briefly noticed in the article BOTANY, vol. iv. p. 80: it formed the foundation on which modern classification was afterwards built; more than this, it is certain that Cuvier derived much help in his zoological classification from its perusal. Hardly had the last sheet passed through the press, when the French Revolution broke out, and the author was installed in charge of the hospitals of Paris. The Muséum d'Histoire Naturelle was organized on its present footing mainly by him in 1793, and he selected for its library everything relating to natural history from the vast materials obtained from the convents then broken up. He continued as professor of botany there from 1770 to 1826, when his son Adrien succeeded him. Besides the *Genera*, he produced nearly sixty memoirs on botanical topics. He died at Paris, 17th September 1836.

V. ADRIEN (LAURENT HENRI) DE JUSSIEU (1797-1853), son of Antoine Laurent, was born at Paris 23d December 1797. Although his youth was delicate, he displayed the qualities of his family in his thesis for the degree of M.D., *De Euphorbiacearum generibus medicisque earundem viribus tentamen*, Paris, 1824. He was also the author of valuable contributions to botanical literature on the *Rutaceæ*, *Meliaceæ*, and *Malpighiaceæ* respectively, of "Taxonomie" in the *Dictionnaire universelle d'histoire naturelle*, and of an introductory work styled simply *Botanique*, which reached nine editions, and has been translated into the principal languages of Europe. He also edited his father's *Introductio in historiam plantarum*, issued at Paris, without imprint or date, it being a fragment of the intended second edition of the *Genera*, which Antoine Laurent did not live to complete. He died at Paris, 29th June 1853, leaving two daughters, but no son, so that with him closed the brilliant botanical dynasty.

VI. LAURENT (PIERRE) DE JUSSIEU (1792-1866). This miscellaneous writer, nephew of Antoine Laurent, was born at Villeurbanne, 7th February 1792. *Simon de Nantua, ou le marchand forain*, Paris, 1818, reached fifteen editions, and has been translated into seven languages. He also wrote *Simple notions de physique et d'histoire naturelle*, Paris, 1857, and a few geological papers. He died in 1866.

JUSTICE, in law, has long been the official title of the judges of two of the English superior courts of common law, and it is now extended to all the judges in the Supreme Court of Judicature—a judge in the High Court of Justice being styled Mr Justice, and in the Court of Appeal Lord Justice. Before the Judicature Act the Queen's Bench and the Common Pleas were each presided over by a lord chief

justice, and the lord chief justice of the Queen's Bench was nominal head of all the three courts, and held the title of Lord Chief Justice of England. The titles of Lord Chief Justice of the Common Pleas and Lord Chief Baron have recently been abolished, and all the common law divisions of the High Court are united into the Queen's Bench division, the president of which is the lord chief justice of England.

The lord chief justice of England or of the Queen's Bench traces his descent from the justiciar of the Norman kings. This officer appears first as the lieutenant or deputy of the king, exercising all the functions of the regal office in the absence of the sovereign. "In this capacity William Fitz-Osbern, the steward of Normandy, and Odo of Bayeux, acted during the Conqueror's visit to the Continent in 1067; they were left, according to William of Poitiers, the former to govern the north of England, the latter to hold rule in Kent, *vice sua*; Florence of Worcester describes them as "custodes Angliæ," and Ordericus Vitalis gives to their office the name of "præfectura." It would seem most probable that William Fitz-Osbern at least was left in his character of steward, and that the Norman seneschalship was thus the origin of the English justiciarship," Stubbs's *Constitutional History*, vol. i. p. 346. The same authority observes that William of Warenne and Richard of Bienfaite, who were left in charge of England in 1074, are named by a writer in the next generation "præcipui Angliæ justitiarum"; but he considers the name to have not yet been definitely attached to any particular office, and that there is no evidence to show that officers appointed to this trust exercised any functions at all when the king was at home, or in his absence exercised supreme judicial authority to the exclusion of other high officers of the court. The office became permanent in the reign of William Rufus, and in the hands of Ranulf Flambard it became coextensive with the supreme powers of government. For some time, however, the title of justiciar seems not to have been definitely appropriated to this high minister. Judges of the curia regis were occasionally so named, and it was not till the reign of Henry II. that the chief officer of the crown acquired the exclusive right to the title of *capitalis* or *totius Angliæ justitarius*. Canon Stubbs considers that the English form of the office is to be accounted for by the king's desire to prevent the administration falling into the hands of an hereditary noble. The early justiciars were clerics, in whom the possession of power could not become hereditary. The justiciar continued to be the chief officer of state, next to the king, until the fall of Hubert de Burgh (in the reign of King John), described by Mr Stubbs as the last of the great justiciars. Henceforward, according to Mr Stubbs, the office may be regarded as virtually extinct, or it may be said to have survived only in the judicial functions, which were merely part of the official character of the chief justiciar. He was at the head of the curia regis, which was separating itself into the three historical courts of common law about the time when the justiciarship was falling from the supreme place. The chancellor took the place of the justiciar in council, the treasurer in the exchequer, while the two offshoots from the curia regis, the Common Pleas and the Exchequer, received chiefs of their own. The Queen's Bench represented the original stock of the curia regis, and its chief justice the great justiciar. The justiciar may, therefore, be said to have become from a political a purely judicial officer. A similar development awaited his successful rival the chancellor.

The lord chief justice is, next to the lord chancellor, the highest judicial dignitary in the kingdom. The office is generally the prize of the chief law officer of the Government, and political considerations, therefore, enter largely into the appointment. But the chief justices have been

generally worthy of their great position. The list of them contains the names of some of the greatest masters of the common law, among whom pre-eminent rank must be assigned to Hale, Coke, Holt, Mansfield, and Cockburn. Lord Campbell has written the *Lives of the Chief Justices*, in 3 vols. A list of the lords chief justices will be found in Haydn's *Book of Dignities*, 1851. Robert de Brus, said by Fox to be the first judge who took the distinctive title of lord chief justice of the King's Bench (1268), was the grandfather of Robert the Bruce, king of Scotland.

In the United States the supreme court consists of a chief justice and eight associate justices, any five of whom make a quorum. The salary of the chief justice is \$10,500, and that of the associates \$10,000.

JUSTICE OF THE PEACE is an inferior magistrate appointed in England by special commission under the great seal to keep the peace within the county for which he is appointed. "The whole Christian world," said Lord Coke, "hath not the like office as justice of the peace if duly executed." Lord Cowper, on the other hand, describes them as "men sometimes illiterate and frequently bigoted and prejudiced." The truth is that the justices of the peace perform without any other reward than the consequence they acquire from their office a large amount of work indispensable to the administration of the law, and for the most part they discharge their duties with becoming good sense and impartiality. But being chosen from the limited class of country gentlemen in counties, they are sometimes exposed to the suspicion of the general public, particularly when they have to administer laws which are considered to confer special privileges on their own class. Further, as they do not generally possess a professional knowledge of the law, their decisions are occasionally inconsiderate and ill-informed. In great centres of population, when the judicial business of justices is heavy, it has been found necessary to appoint paid justices or stipendiary magistrates to do the work, and an extension of the system to the country districts has been often advocated.

The commission of the peace is addressed to all the justices of the county, and assigns to them the duty of keeping and causing to be kept all ordinances and statutes for the good of the peace and for preservation of the same, and for the quiet rule and government of the people, and further assigns "to you and every two or more of you (of whom any one of the aforesaid A, B, C, D, &c., we will, shall be one) to inquire the truth more fully by the oath of good and lawful men of the county of all and all manner of felonies, poisonings, enchantments, sorceries, arts, magic, trespasses, forestallings, regratings, engrossings, and extortions whatever." This part of the commission is the authority for the jurisdiction of the justices in *sessions*. Justices named specially in the parenthetical clause are said to be on the *quorum*. Justices cannot act beyond the limits of the county for which they are appointed, and the warrant of a justice cannot be executed out of his county unless it be backed, that is, endorsed by a justice of the county in which it is to be carried into execution. A justice improperly refusing to act on his office, or acting partially and corruptly, may be proceeded against by a criminal information, and a justice refusing to act may be compelled to do so by the High Court of Justice. An action will lie against a justice for any act done by him in excess of his jurisdiction, and for any act within his jurisdiction which has been done wrongfully and with malice, and without reasonable or probable cause. But no action can be brought against a justice for a wrongful conviction until it has been quashed. By 18 Geo. II. c. 20 every justice for a county must have an estate of freehold, copyhold, or customary tenure in fee, for life or a given term, of the



yearly value of £100. The vast and multifarious duties of the justices cover some portion of every important head of the criminal law, and extend to a considerable number of matters relating to the civil law. A complete guide thereto is Burn's *Justice of the Peace*, in 5 large volumes, the thirtieth edition of which was published in 1869.

In the United States these officers are sometimes appointed by the executive, sometimes elected. "In some, perhaps all, of the United States, justices of the peace have jurisdiction in civil cases given to them by local regulations" (*Bouvier's Law Dictionary*).

JUSTICIARY, HIGH COURT OF, in Scotland, is the supreme criminal court, and consists of five of the lords of session together with the lord justice-general and the lord justice-clerk as president and vice-president respectively. The constitution of the court is settled by the Act 1672 c. 16. The lords of justiciary hold circuits regularly twice a year according to the ancient practice, which, however, had been allowed to fall into disuse until revived in 1748. The circuits are—the south, at the towns of Jedburgh, Dumfries, and Ayr; west (three times a year), at Glasgow, Inveraray, and Stirling; and north, Perth, Aberdeen, Dundee, and Inverness. By a recent order in council the number of circuit courts in future is to be doubled. Two judges generally go on circuit, and in Glasgow they are by special statute authorized to sit in separate courts. The High Court, sitting in Edinburgh, has, in addition to its general jurisdiction, an exclusive jurisdiction for districts not within the jurisdiction of the circuits—the three Lothians, and Orkney and Shetland. The High Court also takes up points of difficulty arising before the special courts, like the court for crown cases reserved in England. The court of justiciary has authority to try all crimes, unless when its jurisdiction has been excluded by special enactment of the legislature. It is also stated to have an inherent jurisdiction to punish all criminal acts, even if they have never before been treated as crimes. Its judgments are believed to be not subject to any appeal or review, but it may be doubted whether an appeal on a point of law would not lie to the House of Lords. The following crimes must be prosecuted in the court of justiciary:—treason, murder, robbery, rape, fire-raising, deforcement of messengers, breach of duty by magistrates, and all offences for which a statutory punishment higher than imprisonment is imposed.

JUSTIN, Martyr and Apologist as he is usually called, was an able and eloquent advocate of Christianity in the 2d century. Almost all we know about him is told us in his own writings. He was born in Palestine, at Flavia Neapolis (*Apol.*, i. 1), the ancient Shechem, now Nâbulus. The names of his father Priscus and grandfather Bacchius suggest that he was of Latin descent, and some passages in his writings seem to say that his parents were heathens. He relates his own conversion in two passages. In the one he says that he was drawn to Christianity because he saw the Christians dauntless in death (*Apol.*, ii. 12); in the other he tells how chance intercourse with an aged stranger brought him to know the truth (*Dial. c. Tryph.*, c. 2), but this passage may be allegorical. In the introduction to the dialogue with Trypho, Justin describes various systems of pagan philosophy and his relation to them. At first he associated with the Stoics; from them he went to a Peripatetic, then to a Pythagorean; and at length he embraced the doctrines of Platonism. His Platonism clung to him through life, and curiously coloured many of his Christian speculations. We know little about Justin's life after his conversion. It is very probable that he retained his philosopher's cloak, the distinctive badge of the wandering and professional teacher of philosophy, and went about from place to place discussing the truths of Christianity in the hope of bringing educated

pagans, as he himself had been brought, through philosophy to Christ. At Ephesus he held the famous disputation with Trypho the Jew, and in Rome he argued with Crescens the Cynic. If the *Cohortatio* be genuine, he also visited Alexandria and Cumæ. His martyrdom is well authenticated. In his second *Apology* Justin declares that he expected martyrdom, and that he believed that his opponent Crescens, silenced in public by his arguments, would do his best to get him thrown into prison and condemned to death; and this declaration is probably the reason why Eusebius, who often manufactures facts out of suppositions, asserts that Justin was slain through the plots of Crescens. An old martyrdom, of unknown authorship, records the trial and death of a Justin, who is probably Justin Martyr, though there is no corroborative historical evidence. If the account can be accepted, Justin was brought before Rusticus, a Roman magistrate who was a Stoic; during his trial he was brave, quiet, and dignified; he professed his faith in the God of heaven and earth, and in His Son "the Master of Truth," and confidently expressed the conviction that after death he would share a blessed immortality. He was condemned and put to death on the same day. We cannot fix with any certainty the dates of Justin's birth and death. He was probably born near the beginning of the 2d century, and was martyred somewhere between 148 and 165.

Justin was one of the earliest and ablest of the Christian Apologists, and it is as an apologist rather than as a theologian that he must be criticized, for his *Apologies* did not lead him directly to exhibit and defend the truths of Christianity. He was defending Christians not Christianity. Trajan had formally authorized the persecution of the Christians. Hadrian and Antoninus Pius had done nothing to put this decree in operation, but it hung over the Christian church, and might have been put in force at any moment. The Christians were legally proscribed. This was the state of matters which gave rise to Justin's *Apologies*. He wrote like a man full of Christianity; it was his philosophy, his religion, his rule of daily life. And he wrote boldly, having nothing to fear and nothing to conceal. The argument of his first *Apology*, addressed to the emperor Antoninus Pius, may be thus condensed. "In the name of these unjustly hated and much abused men, I, Justin, one of themselves, present to you this discourse and petition. You are everywhere called the Pious, the guardian of justice, the friend of truth; your acts shall show whether you merit these titles. My design is neither to flatter you by this letter nor to win your favour. Judge us by a scrupulous and enlightened equity, not by mere presumption, nor in the name of superstition, nor by the persuasion of calumny; . . . we fear no harm if we are not guilty of any crime. You can kill, you cannot injure us. All that we ask for is investigation; if the charges made against us are true, let us be punished. . . . Our duty is to make our deeds and doctrines fully known; yours is to investigate our cause and to act as good judges." Justin then proceeds to set forth the iniquity of the summary modes of trial in use against the Christians, and goes on to state and deal with the charges brought against his brethren. These were three: the Christians were denounced as atheists, as rebels, and as evil-doers—faithless to God, the emperor, and society. Justin answers, "We are atheists, if it be atheism not to acknowledge your gods; but we hold this glorious atheism in common with Socrates, who was martyred for it as we are; we are no atheists, for we worship the God of truth, the Father of righteousness, of wisdom, and of all virtues. We are no rebels: the kingdom founded by Jesus is purely spiritual, and need be no cause of alarm to the emperors; we worship God only, but with this exception we joyfully obey you and acknow-

ledge you as our princes and governors. So far from our being rebels, our religion helps true and good government; men may always hope to elude human law, but they cannot hope to escape God, who sees and knows all things. We are no criminals: the Crucified One whom we worship is the Divine Word, living truth, and has enjoined us to live holy and pure lives." Justin contrasts pagan morals and the Christian life, the pagan deities and Jesus of Nazareth. The empire and Christianity were at war because of the persecuting edicts of the emperors, and Justin has no doubt that Christianity must in the end win the day. The *Apology* ends with solemn dignity: "If this doctrine appears true and reasonable give heed to it; if not, treat it as of no value. But do not condemn men to death who have done you no wrong; for we declare to you that you will not escape the judgment of God if you persist in injustice. For ourselves, we have but one cry—'The will of God be done.'" In the dialogue with Trypho, Justin endeavoured to show the truth of Christianity from the Old Testament Scriptures, and he described the New Testament as the new law which superseded, while it fulfilled, the old. It is not possible to construct a scheme of Christian dogmatic from the writings of Justin, but some ideas may be gathered from his *Apologies*. Christ is the centre of religion, and the exposition of Christian doctrine is to be grouped around a description of Christ. God is the God and Father of Jesus Christ. He is the *only* and the *one* God in opposition to the polytheism of the heathen; the *unbegotten* God, not born and reared like Dionysus the son of Semele or Apollo son of Leto; the *unspeakable* God, because every thinking man knows that God's existence cannot be thought of or described. God is spiritual; He has indescribable glory and shape; He is omniscient and almighty; He is creator; He has made the world for man, and cares for His creatures; He is full of mercy and goodness. With Justin the great fact in Christianity is that Jesus Christ is the Son of God; he does not spend much time in thinking out what this means, but he is one of the earliest writers who unconsciously tries to explain the incarnation by the Platonic thought of the Logos. Justin, however, thinks of the Logos as a personal being. The begetting of the Logos is an act of the Father's; but we cannot say when the Logos was begotten, because He was before all creation, and so before all time. The Logos is the instrument through whom God created and preserves the universe; He is the instrument in the miraculous history of the Jews; He inspired the heathen sages; He is God; He became incarnate. Justin does not seem to distinguish between the divine and human natures of Christ, but he believes Christ to be man and to be God. And so on with other doctrines. In Justin we see the earnest living Christianity of the 2d century firmly centred on Jesus Christ, very God and very man, trying to live again His life, taught by His Spirit. The faith rested in the great central facts of Christianity, but the power of defining doctrine had not become vigorous.

No ancient writer gives a complete list of Justin's writings; the fullest is that of Eusebius (*Ecl. Hist.*, iv. 18). The following, now extant, have been ascribed to him:—The two *Apologies*; *Dialogue with the Jew Trypho*; *A Speech to the Greeks*; *An Address to the Greeks*; *On the Sole Government of God*; *An Epistle to Diognetus*; *Fragments on the Resurrection*; and other fragments. The following, now extant, and attributed to Justin, are deemed spurious:—*The Exposition of Certain Doctrines of Aristotle*; *Questions and Answers to the Orthodox*; *Questions of Christians to Heathens*; *Questions of Heathens to Christians*.

The *First Apology* is undoubtedly genuine. It refers to the Jewish rebellion, 131–136, and was probably written 138–140 A.D. The *Second Apology* which has come down to us is probably not the second apology mentioned by Eusebius, which has been lost, but a portion of the first. The authenticity of the *Dialogue with Trypho* has been disputed by Lange, Koch, Wettstein, &c.,

but their arguments are not convincing; more interest attaches to the question whether it is historical or written in imitation of the dialogues of Plato; the greater weight of evidence lies on the side that it is historical. The *Speech to the Greeks* is probably Justin's; but the weight of evidence is against the authenticity of the remaining writings.

*Editions*.—Robert Stephanus, Paris, 1551; Sylburg, Heidelberg, 1593; Morell, Paris, 1615; Maran, Paris, 1742. The best edition is Otto's, 3d ed., Jena, 1876 and following years.

Good translations of Justin have appeared in the Oxford *Library of the Fathers*, and in Clarke's *Ante-Nicene Library*.

Full information about Justin's history and views may be had from Otto, *De Justinii Martyris Scriptis et Doctrina*, Jena, 1841; and from Donaldson's *History of Christian Literature and Doctrine*, London, 1866, vol. ii. For information about MSS., see Donaldson, p. 144, and Otto's prefaces. Otto refers, ii. p. xxvi., to a *Codex Glascoviensis*, but this is a mistake; the MS. referred to contains the orations of an Italian humanist Justiniani. (T. M. L.)

JUSTIN, Latin historian, called in one MS. Justinus Frontinus, in another M. Junianus Justinus, in others simply Justinus, is known from his *Historiarum Philippicarum Libri XLIV.*, a work described by himself in his preface as a collection of the most important and interesting passages from the voluminous *Historiæ Philippicæ et totius Mundi Origines et Terræ Situs*, written in the time of Augustus by Trogas Pompeius. Of Justin's personal history absolutely nothing is known. The passage in his preface on which was based the belief that he lived under Antoninus Pius is spurious; but a reference to him by St Jerome fixes his date at some point before the 5th century. The work of Trogas is lost, probably helped into oblivion by the shorter compilation; but the *prologi*, or arguments, of the forty-four books are extant, and a few fragments of the text are preserved by Pliny and other writers. From the *prologi* we gather that, although the main theme of Trogas was the rise and history of the Macedonian monarchy, he yet permitted himself a freedom of digression that extended very considerably the field of description, and makes it all the more to be regretted that Justinus chose to write a capricious anthology (*breve veluti florum corpusculum*) instead of a regular epitome of the work. As it stands, however, Justin's history contains a large amount of valuable information, which but for it we might never have possessed. The style, though far from perfect, has the merit of clearness, occasionally even of elegance.

The editio princeps of Justinus appeared at Venice, 1470, folio, from Jenson's press. An edition, folio, Rome, is referred to 1470 or 1471. The other chief editions are those of Sabellinus, Venice, folio, 1490, 1497, and 1507; Aldus, Venice, 8vo, 1522; Bongarsius, Paris, 8vo, 1581; Grævius, Leyden, 8vo, 1683; Hearne, Oxford, 8vo, 1705; Gronovius, Leyden, 1719 and 1760 (2d ed. in "Variorum" Classics); Frotscher, Leipsic, 8vo, 3 vols., 1827–30; Dübner, Leipsic, 8vo, 1831; and Dubner and Johanneau, Paris, 2 vols., 1838. Translations appeared very early in the chief European languages. There are English versions by Goldinge, 1564; Holland, 1606; Codrington, 1654; Brown, 1712; Bailey, 1732; Clarke, 1732; Turnbull, 1746; and Watson, 1853.

JUSTIN I., the elder, Roman emperor of the East from 518 to 527, was originally a Dacian peasant; but, enlisting under Leo I. he rose by his size and strength to be commander of the imperial guards of Anastasius. On the death of that emperor in 518, the wily Dacian, aged sixty-eight, used for his own election to the throne a sum of money that he had received for the support of another candidate. Though ignorant even of the rudiments of letters, Justin was sufficiently acute, and he was sensible enough to entrust the administration of state to his wise and faithful quaestor Proclus, though his own experience dictated several improvements in military affairs. An orthodox churchman himself, he effected in 519 a reconciliation of the Eastern and Western Churches, after a schism of thirty-five years (see HORMISDAS). The assassination of the orthodox general Vitalian, and the virulence of the bloody conflicts of the "blue" and "green" factions that convulsed the capital towards the end of Justin's reign,



are attributed to the jealousy and intrigues of the emperor's nephew and successor Justinian. In 522 a war broke out with Persia, in which Belisarius made his first historical appearance; it continued for some years without any definite results. In 522 also Justin ceded to Theodoric, the Gothic king of Italy, the right of naming the consuls, and in 525 he received from that Arian monarch a deputation, of which the pope, John I., was compelled to be the leader, to deprecate an edict issued by Justin in 523 against all heretics. On April 1, 527, Justin, at the request of the senate, assumed Justinian as his colleague, and on the 1st of the following August he died. Justin bestowed much care on the repairing of public buildings throughout his empire, and contributed large sums to repair the damage caused by a destructive earthquake at Antioch.

JUSTIN II., the younger, Roman emperor of the East from 565 to 578, was the nephew and successor of Justinian I. He availed himself of his influence as master of the palace, and as husband of Sophia, the niece of the late empress Theodora, to secure a peaceful election. The first few days of his reign—when he paid his uncle's debts, administered justice in person, and proclaimed universal religious toleration—gave bright promise, realization of which was prevented either by his feebleness or his caprice. The most important event of his reign was the invasion of Italy by the Lombards, who, entering in 568 under Alboin, in a few years made themselves masters of nearly the entire country. The common story that they were invited by the superseded and insulted exarch Narses, besides being inherently improbable, has but slender historical foundation. Modern historians see in the event only an evidence of the indifference of the Byzantine court to Italy, whence little revenue could be drawn. Justin's arrogance had insulted the embassies from the Persians and Avars, who had come to him in the first year of his reign; and in 572 war broke out with the former, and in 573 with the latter. Although he formed alliances with the Turks of Central Asia and with the Ethiopians of Arabia in the one case, and with the Austrasian Franks in the other, the emperor's arms were unsuccessful in both wars. The temporary fits of insanity into which he fell warned him to name a colleague. Passing over his own relatives, he raised, on the advice of Sophia, the brave general Tiberius to be Cæsar in December 574, and withdrew for his remaining years into retirement. Tiberius was advanced to the dignity of Augustus on September 26, 578, and Justin died on the 5th of the following month.

JUSTINIAN I. (483-565). Flavius Anicius Justinianus, surnamed the Great, the most famous of all the emperors of the Eastern Roman empire, was by birth a barbarian, native of a place called Tauresium in the district of Dardania, a region of Illyricum,<sup>1</sup> and was born, most probably, on May 11, 483. His family has been variously conjectured, on the strength of the proper names which its members are stated to have borne, to have been Teutonic or Slavonic. The latter seems the more probable view. His own name was originally Uprauda. Justinianus was a Roman name which he took from his uncle Justin who adopted him, and to whom his advancement in life was due.<sup>2</sup> Of his early life we know nothing except that he came to Constantinople while still a young man, and received there an excellent education. Doubtless he knew Latin before Greek; it is alleged that he always spoke Greek with a barbarian accent. When Justin

ascended the throne in 518 A.D., Justinian became at once a person of the first consequence, guiding, especially in church matters, the policy of his aged, childless, and ignorant uncle, receiving high rank and office at his hands, and soon coming to be regarded as his destined successor. On Justin's death in 527, having been a few months earlier associated with him as co-emperor, he succeeded without opposition to the throne.

His reign was filled with great events, both at home and abroad, both in peace and in war. They may be classed under four heads:—(1) his legal reforms; (2) his administration of the empire; (3) his ecclesiastical policy; and (4) his wars and foreign policy generally.

1. It is as a legislator and codifier of the law that Justinian's name is most familiar to the modern world; and it is therefore this department of his action that requires to be most fully dealt with here. He found the law of the Roman empire in a state of great confusion. It consisted of two masses, which were usually distinguished as old law (*jus vetus*) and new law (*jus novum*). The first of these comprised—(1) all such of the statutes (*leges*) passed under the republic and early empire as had not become obsolete; (2) the decrees of the senate (*senatus consulta*) passed at the end of the republic and during the first two centuries of the empire; (3) the writings of the jurists of the later republic and of the empire, and more particularly of these jurists to whom the right of declaring the law with authority (*jus respondendi*) had been committed by the emperors. As these jurists had in their commentaries upon the *leges*, *senatus consulta*, and edicts of the magistrates practically incorporated all that was of importance in those documents, the books of the jurists may substantially be taken as including (1) and (2). These writings were of course very numerous, and formed a vast mass of literature. Many of them had become exceedingly scarce,—many having of course been altogether lost. Some were of doubtful authenticity. They were so costly that no person of moderate means could hope to possess any large number; even the public libraries had nothing approaching to a complete collection. Moreover, as they proceeded from a large number of independent authors, who wrote expressing their own opinions, they contained many discrepancies and contradictions, the dicta of one writer being controverted by another, while yet both writers might enjoy the same formal authority. A remedy had been attempted to be applied to this evil by a law of the emperors Theodosius II. and Valentinian III., which gave special weight to the writings of five eminent jurists (Papinian, Paulus, Ulpian, Modestinus, Gaius); but it was very far from removing it. As regards the *jus vetus*, therefore, the judges and practitioners of Justinian's time had two terrible difficulties to contend with,—first, the bulk of the law, which made it impossible for any one to be sure that he possessed any thing like the whole of the authorities bearing on the point in question, so that he was always liable to find his opponent quoting against him some authority for which he could not be prepared; and, secondly, the uncertainty of the law, there being a great many important points on which differing opinions of equal legal validity might be cited, so that the practising counsel could not advise, nor the judge decide, with any confidence that he was right, or that a superior court would uphold his view.

The new law (*jus novum*), which consisted of the ordinances of the emperors promulgated during the middle and later empire (*edicta, rescripta, mandata, decreta*, usually called by the general name of *constitutiones*), was in a condition not much better. These ordinances or constitutions were extremely numerous. No complete collection of them existed, for although two collections (*Codex Gregorianus*

<sup>1</sup> It is commonly identified with the modern Giustendil, but Uskiub (the ancient Skupi) has also been suggested. See Tozer, *Highlands of European Turkey*, ii. p. 370.

<sup>2</sup> The name "Uprauda" itself is said to be derived from the word "prauda," which in Old Slavic means "jus," "justitia," the prefix being simply a breathing frequently attached to Slavonic names.

and *Codex Hermogenianus*) had been made by two jurists in the 4th century, and a large supplementary collection published by the emperor Theodosius II. in 438 (*Codex Theodosianus*), these collections did not include all the constitutions, there were others which it was necessary to obtain separately, but many whereof it must have been impossible for a private person to procure. In this branch too of the law there existed some, though a less formidable, uncertainty; for there were constitutions which practically, if not formally, repealed or superseded others without expressly mentioning them, so that a man who relied on the words of one constitution might find that it had been varied or abrogated by another he had never heard of or on whose sense he had not put such a construction. It was therefore clearly necessary with regard to both the older and the newer law to take some steps to collect into one or more bodies or masses so much of the law as was to be regarded as binding, reducing it within a reasonable compass, and purging away the contradictions or inconsistencies which it contained. The evil had been long felt, and reforms apparently often proposed, but nothing (except by the compilation of the *Codex Theodosianus*) had been done till Justinian's time. Immediately after his accession, in 528, he appointed a commission to deal with the imperial constitutions (*jus novum*), this being the easier part of the problem. The commissioners, ten in number, were directed to go through all the constitutions of which copies existed, to select such as were of practical value, to cut these down by retrenching all unnecessary matter, and gather them, arranged in order of date, into one volume, getting rid of any contradictions by omitting one or other of the conflicting passages.<sup>1</sup> These statute law commissioners, as one may call them, set to work forthwith, and completed their task in fourteen months, distributing the constitutions which they placed in the new collection into ten books, in general conformity with the order of the Perpetual Edict as settled by Salvius Julianus and enacted by Hadrian. By this means the bulk of the statute law was immensely reduced, its obscurities and internal discrepancies in great measure removed, its provisions adapted, by the abrogation of what was obsolete, to the circumstances of Justinian's own time. This *Codex Constitutionum* was formally promulgated and enacted as one great consolidating statute in 529, all imperial ordinances not included in it being repealed at one stroke.

The success of this first experiment encouraged the emperor to attempt the more difficult enterprise of simplifying and digesting the older law contained in the treatises of the jurists. Before entering on this, however, he wisely took the preliminary step of settling the more important of the legal questions as to which the older jurists had been divided in opinion, and which had therefore remained sources of difficulty, a difficulty aggravated by the general decline, during the last two centuries, of the level of forensic and judicial learning. This was accomplished by a series of constitutions known as the "Fifty Decisions" (*Quinquaginta Decisiones*), along with which there were published other ordinances amending the law in a variety of points, in which old and now inconvenient rules had been suffered to subsist. Then in December 530 a new commission was appointed, consisting of sixteen eminent lawyers, of whom the president, the famous Tribonian (who had already served on the previous commission), was an exalted official (*questor*), four were professors of law, and the remaining eleven practising advocates. The instructions given to them by the emperor were as follows:—they were to procure and peruse all the writings of all the authorized jurists

(those who had enjoyed the *jus respondendi*); were to extract from these writings whatever was of most permanent and substantial value, with power to change the expressions of the author wherever conciseness or clearness would be thereby promoted, or wherever such a change was needed in order to adapt his language to the condition of the law as it stood in Justinian's time; were to avoid repetitions and contradictions by giving only one statement of the law upon each point; were to insert nothing at variance with any provision contained in the *Codex Constitutionum*; and were to distribute the results of their labours into fifty books, subdividing each book into titles, and following generally the order of the Perpetual Edict.<sup>2</sup>

These directions were carried out with a speed which is surprising when we remember not only that the work was interrupted by the terrible insurrection which broke out in Constantinople in January 532, and which led to the temporary retirement from office of Tribonian, but also that the mass of literature which had to be read through consisted of no less than two thousand treatises, comprising three millions of sentences. The commissioners, who had for greater despatch divided themselves into several committees, presented their selection of extracts to the emperor in 533, and he published it as an imperial statute on December 16th of that year, with two prefatory constitutions (those known as *Onnem reipublicæ* and *Dedit nobis*). It is the volume which we now call the *Digest* (*Digesta*) or *Pandects* (*Πάνδεκται*), and which is by far the most precious monument of the legal genius of the Romans, and indeed, whether one regards the intrinsic merits of its substance or the prodigious influence it has exerted and still exerts, the most remarkable law-book that the world has seen. The extracts comprised in it are 9123 in number, taken from thirty-nine authors, and are of greatly varying length, mostly only a few lines long. About one-third (in quantity) come from Ulpian, a very copious writer; Paulus stands next. To each extract there is prefixed the name of the author, and of the treatise whence it is taken.<sup>3</sup> The worst thing about the *Digest* is its highly unscientific arrangement. The order of the Perpetual Edict, which appears to have been taken as a sort of model for the general scheme of books and titles, was doubtless convenient to the Roman lawyers from their familiarity with it, but was in itself rather accidental and historical than logical. The disposition of the extracts inside each title was still less rational; it has been shown by a modern jurist to have been the result of the way in which the committees of the commissioners worked through the books they had to peruse.<sup>4</sup> In enacting the *Digest* as a law book, Justinian repealed all the other law contained in the treatises of the jurists (that *jus vetus* which has been already mentioned), and directed that those treatises should never be cited in future even by way of illustration; and he of course at the same time abrogated all the older statutes, from the Twelve Tables downwards, which had formed a part of the *jus vetus*. This was a necessary incident of his scheme of reform. But he went too far, and indeed attempted what was impossible, when he forbade all commentaries upon the *Digest*. He was obliged to allow a Greek translation to be made of it, but directed this translation to be exactly literal.

These two great enterprises had substantially despatched

<sup>2</sup> See the constitution *Deo Auctore* (*Cod.* i. 17, 1).

<sup>3</sup> In the Middle Ages people used to cite passages by the initial words; and the Germans do so still, giving, however, the number of the paragraph in the extract (if there are more paragraphs than one), and appending the number of the book and title. We in Britain and America usually cite by the numbers of the book, the title, and the paragraph, without referring to the initial words.

<sup>4</sup> See Bluhme, "Die Ordnung der Fragmente in den Pandektentiteln." in Savigny's *Zeitschr. f. gesch. Rechtswissenschaft*, vol. iv.

<sup>1</sup> See, for an account of the instructions given to the commission, the constitution *Hæc Quæ*, prefixed to the revised *Codex* in the *Corpus Juris Civilis*



Justinian's work; however, he, or rather Tribonian, who seems to have acted both as his adviser and as his chief executive officer in all legal affairs, conceived that a third book was needed, viz., an elementary manual for beginners which should present an outline of the law in a clear and simple form. The little work of Gaius, most of which we now possess under the title of *Commentarii Institutionum*, had served this purpose for nearly four centuries; but much of it had, owing to changes in the law, become inapplicable, so that a new manual seemed to be required. Justinian accordingly directed Tribonian, with two coadjutors, Theophilus, professor of law in the university of Constantinople, and Dorotheus, professor in the great law school at Beyrout, to prepare an elementary text-book on the lines of Gaius. This they did while the *Digest* was in progress, and produced the useful little treatise which has ever since been the book with which students commonly begin their studies of Roman law, the *Institutes of Justinian*. It was published as a statute with full legal validity shortly before the *Digest*. Such merits as it possesses—simplicity of arrangement, clearness and conciseness of expression—belong rather to Gaius, who has been closely followed wherever the alterations in the law had not made him obsolete, than to Tribonian. However, the spirit of that great legal classic seems to have in a measure dwelt with and inspired the inferior men who were recasting his work; and the *Institutes* is better both in Latinity and in substance than we should have expected from the condition of Latin letters at that epoch, better than the other laws which emanate from Justinian.

In the four years and a half which elapsed between the publication of the *Codex* and that of the *Digest*, many important changes had been made in the law, notably by the publication of the "Fifty Decisions," which settled many questions that had exercised the legal mind and given occasion to intricate statutory provisions. It was therefore natural that the idea should present itself of revising the *Codex*, so as to introduce these changes into it, for by so doing, not only would it be simplified, but the one volume would again be made to contain the whole statute law, whereas now it was necessary to read along with it the ordinances issued since its publication. Accordingly another commission was appointed, consisting of Tribonian with four other coadjutors, full power being given them not only to incorporate the new constitutions with the *Codex* and make in it the requisite changes, but also to revise the *Codex* generally, cutting down or filling in wherever they thought it necessary to do so. This work was completed in a few months; and in November 529, the revised *Codex* (*Codex repetitæ prælectionis*) was promulgated with the force of law, prefaced by a constitution (*Cordi nobis*) which sets forth its history, and declares it to be alone authoritative, the former *Codex* being abrogated. It is this revised *Codex* which has come down to the modern world, all copies of the earlier edition having disappeared.

The constitutions contained in it number 4652, the earliest dating from Hadrian, the latest being of course Justinian's own. A few thus belong to the period to which the greater part of the *Digest* belongs, i.e., the so-called classical period of Roman law down to the time of Alexander Severus (244); but the great majority are later, and belong to one or other of the four great eras of imperial legislation, the eras of Diocletian, of Constantine, of Theodosius II., and of Justinian himself. Although this *Codex* is said to have the same general order as that of the *Digest*, viz., the order of the Perpetual Edict, there are considerable differences of arrangement between the two. It is divided into twelve books. Its contents, although of course of the utmost practical importance to the lawyers of that time, and of much value still, historical as well as legal, are far less interesting and scientifically admissible than the extracts preserved in the *Digest*. The difference is even greater than that between the English Reports of Cases decided since the days of Lord Holt and the English Acts of Parliament for the same two centuries.

The emperor's scheme was now complete. All the Roman law had been gathered into two volumes of not immoderate size, and a satisfactory manual for beginners added. But, as the appetite comes with eating, Justinian and Tribonian had grown so fond of legislating that they found it hard to leave off. Moreover, the very simplifications that had been so far effected brought into view with more clearness such anomalies or pieces of injustice as still continued to deform the law. Thus no sooner had the work been rounded off than fresh excrescences began to be created by the publication of new laws. Between 534 and 565 Justinian issued a great number of ordinances, dealing with all sorts of subjects, and seriously altering the law on many points,—the majority appearing before the death of Tribonian, which happened in 545. These ordinances are called, by way of distinction, new constitutions, *Novellæ constitutiones post Codicem* (*νεωτάται διατάξεις*), *Novels*. Although the emperor had stated in publishing the *Codex* that all further statutes (if any) would be officially collected, this promise does not seem to have been redeemed. The three collections of the *Novels* which we possess are apparently private collections, nor do we even know how many such constitutions were promulgated. One of the three contains 168 (together with 13 Edicts), but some of these are by the emperors Justin II. and Tiberius II. Another, the so-called *Epitome of Julian*, contains 125 *Novels* in Latin; and the third, the *Liber Authenticarum* or *Vulgata Versio*, has 134, also in Latin. This last was the collection first known and chiefly used in the West during the Middle Ages; and of its 134 only 97 have been written on by the glossators or medieval commentators; these therefore alone have been received as binding in those countries which recognize and obey the Roman law,—according to the maxim *Quicquid non agnoscit glossa, nec agnoscit curia*. And, whereas Justinian's constitutions contained in the *Codex* were all issued in Latin, the rest of the book being in that tongue, these *Novels* were nearly all published in Greek, Latin translations being of course made for the use of the western provinces. They are very bulky, and with the exception of a few, particularly the 116th and 118th, which introduce the most sweeping and laudable reforms into the law of intestate succession, are much more interesting as supplying materials for the history of the time, social, economical, and ecclesiastical, than in respect of any purely legal merits. They may be found printed in any edition of the *Corpus Juris Civilis*.

This *Corpus Juris*, which bears and immortalizes Justinian's name, consists of the four books described above:—(1) the authorized collection of imperial ordinances (*Codex Constitutionum*); (2) the authorized collection of extracts from the great jurists (*Digesta* or *Pandectæ*); (3) the elementary handbook (*Institutiones*); (4) the unauthorized collection of constitutions subsequent to the *Codex* (*Novellæ*).

From what has been already stated, the reader will perceive that Justinian did not, according to a strict use of terms, codify the Roman law. By a codification, we understand the reduction of the whole pre-existing body of law to a new form, the restating it in a series of propositions, scientifically ordered, which may or may not contain some new substance, but are at any rate new in form. If he had, so to speak, thrown into one furnace all the law contained in the treatises of the jurists and in the imperial ordinances, fused them down, the gold of the one and the silver of the other, and run them out into new moulds, this would have been codification. What he did do was something quite different. It was not codification but consolidation, not remoulding but abridging. He made extracts from the existing law, preserving the old words, and merely cutting out repetitions, removing contradictions, retrenching superfluities, so as immensely to reduce the bulk of the whole. And he made not one set of such extracts but two, one for the jurist law, the other for the statute law. He gave to posterity not one code but two digests or collections of extracts, which are new only to this extent that they are arranged in a new order, having been previously altogether unconnected with one another, and that here and there their words have been modified in order to bring one extract into harmony with some other. Except for this, the matter is old in expression as well as in substance.

Thus regarded, and even omitting to remark that the *Novels*, never having been officially collected, much less incorporated with the *Codex*, mar the symmetry of the structure, Justinian's work may appear to entitle him and Tribonian to much less credit than they have usually

received for it. But let it be observed, first, that to reduce the huge and confused mass of pre-existing law into the compass of these two collections was an immense practical benefit to the empire; secondly, that, whereas the work which he undertook was accomplished in seven years, the infinitely more difficult task of codification might probably have been left unfinished at Tribonian's death, or even at Justinian's own, and been abandoned by his successor; thirdly, that in the extracts preserved in the *Digest* we have the opinions of the greatest legal luminaries given in their own admirably lucid, philosophical, and concise language, while in the extracts of which the *Codex* is composed we find valuable historical evidence bearing on the administration and social condition of the later pagan and earlier Christian empire; fourthly, that Justinian's age, that is to say, the intellect of the men whose services he commanded, was quite unequal to so vast an undertaking as the fusing upon scientific principles into one new organic whole of the entire law of the empire. With sufficient time and labour, the work might no doubt have been done; but what we possess of Justinian's own legislation, and still more what we know of the general condition of literary and legal capacity in his time, makes it certain that it would not have been well done, and that the result would have been not more valuable to the Romans of that age, and much less valuable to the modern world, than are the results, preserved in the *Digest* and the *Codex*, of what he and Tribonian actually did.

To the merits of the work as actually performed some reference has already been made. The chief defect of the *Digest* is in point of scientific arrangement, a matter about which the Roman lawyers, perhaps one may say the ancients generally, cared very little. There are some repetitions and some inconsistencies, but not more than may fairly be allowed for in a compilation of such magnitude executed so rapidly. Tribonian has been blamed for the insertions the compilers made in the sentences of the old jurists (the so-called *Emblemata Triboniani*); but it was a part of Justinian's plan that such insertions should be made, so as to adapt those sentences to the law as settled in the emperor's time. On Justinian's own laws, contained in the *Codex* and in his *Novels*, a somewhat less favourable judgment must be pronounced. They, and especially the latter, are diffuse and often lax in expression, needlessly prolix, and pompously rhetorical. The policy of many, particularly of those which deal with ecclesiastical matters, may also be condemned; yet some gratitude is due to the legislator who put the law of intestate succession on that plain and rational footing whereon it has ever since continued to stand. It is somewhat remarkable that, although Justinian is so much more familiar to us by his legislation than by anything else, this sphere of his imperial labour is hardly referred to by any of the contemporary historians, and then only with censure. Procopius complains that he and Tribonian were always repealing old laws and enacting new ones, and accuses them of venal motives for doing so.

The *Corpus Juris* of Justinian continued to be, with of course a few additions in the ordinances of succeeding emperors, the chief law-book of the Roman world till the time of the Macedonian dynasty, when, towards the end of the 9th century, a new system was prepared and issued by those sovereigns, which we know as the *Basilica*. It is of course written in Greek, and consists of parts of the substance of the *Codex* and the *Digest*, thrown together and often altered in expression, together with some matter from the *Novels* and imperial ordinances posterior to Justinian. In the western provinces, which had been wholly severed from the empire before the publication of the *Basilica*, the law as settled by Justinian held its ground; but copies of the *Corpus Juris* were extremely rare, nor did the study of it revive until the end of the 11th century.

The best edition of the *Digest* is that of Mommsen, Berlin, 1863-70, and of the *Codex* that of Krueger, Berlin, 1875-77.

2. In his financial administration of the empire, Justinian is represented to us as being at once rapacious and extravagant. His unwearied activity and inordinate vanity led him to form all kinds of expensive projects, and undertake a great many costly public works, many of them, such as the erection of palaces and churches, unremunerative. The money needed for these, for his wars, and for buying off the barbarians who threatened the frontiers, had to be obtained by increasing the burdens of the people. They suffered, not only from the regular taxes, which were seldom remitted even after bad seasons, but also from monopolies; and Procopius goes so far as to allege that the emperor made a practice of further recruiting his treasury by confiscating on slight or fictitious pretexts the property of persons who had displeased Theodora or himself. Fiscal severities were no doubt one cause of the insurrections which now and then broke out, and in the gravest of which, 532 A.D., thirty thousand persons are said to have perished in the capital. It is not always easy to discover, putting together the trustworthy evidence of Justinian's own laws and the angry complaints of Procopius, what was the nature and justification of the changes made in the civil administration. But the general conclusion seems to be that these changes were always in the direction of further centralization, increasing the power of the chief ministers and their offices, bringing all more directly under the control of the crown, and in some cases limiting the powers and appropriating the funds of local municipalities. Financial necessities compelled retrenchment, so that a certain number of offices were suppressed altogether, much to the disgust of the office-holding class, which was numerous and wealthy, and had almost come to look on the civil service as its hereditary possession. The most remarkable instance of this policy was the discontinuance of the consulship. This great office had remained a dignity centuries after it had ceased to be a power; but it was a very costly dignity, the holder being expected to spend large sums in public displays. As these sums were provided by the state, Justinian saved something considerable by stopping the payment. He named no consul after Basilius, who was the name-giving consul of the year 541 A.D.

In a bureaucratic despotism the greatest merit of a sovereign is to choose capable and honest ministers. Justinian's selections were usually capable, but not so often honest; probably it was hard to find thoroughly upright people; possibly they were not the people who would have been most serviceable in carrying out the imperial will, and especially in replenishing the imperial treasury. Even the great Tribonian labours under the reproach of corruption, while the fact that Justinian maintained John of Cappadocia in power long after his greed, his unscrupulousness, and the excesses of his private life had excited the anger of the whole empire, reflects little credit on his own principles of government and sense of duty to his subjects. The department of administration in which he seems to have felt most personal interest was that of public works. He spent immense sums on buildings of all sorts, on quays and harbours, on fortifications, repairing the walls of cities and erecting castles in Thrace to check the inroads of the barbarians, on aqueducts, on monasteries, above all, upon churches. Of these works only two remain perfect, St Sophia in Constantinople, now a mosque, and one of the architectural wonders of the world, and the church of SS. Sergius and Bacchus, now commonly called Little St Sophia, which stands about half a mile from the great church, and is in its way a very delicate and beautiful piece of work. The church of San Vitale at Ravenna, though built in Justinian's reign, and containing mosaic pictures of him and Theodora, does not appear to have owed anything to his mind or purse.



3. Justinian's ecclesiastical policy was so complex and varying that it is impossible within the limits of this article to do more than indicate its bare outlines. For many years before the accession of his uncle Justin, the Eastern world had been vexed by the struggles of the Monophysite party, who recognized only one nature in Christ, against the view which then and ever since has maintained itself as orthodox, that the divine and human natures coexisted in Him. The latter doctrine had triumphed at the council of Chalcedon, and was held by the whole Western Church, but Egypt, great part of Syria and Asia Minor, and a considerable minority even in Constantinople clung to Monophysitism. The emperors Zeno and Anastasius had been strongly suspected of it, and the Roman bishops had refused to communicate with the patriarchs of Constantinople since 484, when they had condemned Acacius for accepting the formula of conciliation issued by Zeno. One of Justinian's first public acts was to put an end to this schism by inducing Justin to make the then patriarch renounce this formula and declare his full adhesion to the creed of Chalcedon. When he himself came to the throne he endeavoured to persuade the Monophysites to come in by summoning some of their leaders to a conference. This failing, he ejected suspected prelates, and occasionally persecuted them, though with far less severity than that applied to the heretics of a deeper dye, such as Montanists or even Arians. Not long afterwards, his attention having been called to the spread of Origenistic opinions in Syria, he issued an edict condemning fourteen propositions drawn from the writings of the great Alexandrian, and caused a synod to be held under the presidency of Mennas (whom he had named patriarch of Constantinople), which renewed the condemnation of the impugned doctrines and anathematized Origen himself.\* Still later, he was induced by the machinations of some of the prelates who haunted his court, and by the influence of Theodora, herself much interested in theological questions, and more than suspected of Monophysitism, to raise a needless, mischievous, and protracted controversy. The Monophysites sometimes alleged that they could not accept the decrees of the council of Chalcedon because that council had not condemned, but (as they argued) virtually approved, three writers tainted with Nestorian principles, viz., Theodore of Mopsuestia, Theodoret, and Ibas, bishop of Edessa. It was represented to the emperor, who was still pursued by the desire to bring back the schismatics, that a great step would have been taken towards reconciliation if a condemnation of these teachers, or rather of such of their books as were complained of, could be brought about, since then the Chalcedonian party would be purged from any appearance of sympathy with the errors of Nestorius. Not stopping to reflect that in the angry and suspicious state of men's minds he was sure to lose as much in one direction as he would gain in the other, Justinian entered into the idea, and put forth an edict exposing and denouncing the errors contained in the writings of Theodore generally, in the treatise of Theodoret against Cyril of Alexandria, and in a letter of Bishop Ibas (a letter whose authenticity was doubted, but which passed under his name) to the Persian bishop Maris. This edict was circulated through the Christian world to be subscribed by the bishops. The four Eastern patriarchs, and the great majority of the Eastern prelates generally, subscribed, though reluctantly, for it was felt that a dangerous precedent was being set when dead authors were anathematized, and that this new movement could hardly fail to weaken the authority of the council of Chalcedon. Among the Western bishops, who were less disposed both to Monophysitism and to subservience, and especially by those of Africa, the edict was earnestly resisted. When it was found that Pope Vigilius did not

forthwith comply, he was summoned to Constantinople. Even there he resisted, not so much, it would seem, from any scruples of his own, for he was not a high-minded man, as because he knew that he dared not return to Italy if he gave way. Long disputes and negotiations followed, the end of which was that Justinian summoned a general council of the church, that which we reckon the Fifth, which condemned the impugned writings, and anathematized several other heretical authors. Its decrees were received in the East, but long contested in the Western Church, where a schism arose that lasted for seventy years. This is the controversy known as that of the Three Chapters (*Tria capitula, τρία κεφάλαια*), apparently from the three propositions or condemnations contained in Justinian's original edict, one relating to Theodore's writings and person, the second to the incriminated treatise of Theodoret (whose person was not attacked), the third to the letter (if genuine) of Ibas (see Hefele, *Conciliengeschichte*, ii. 777).

At the very end of his long career of theological discussion, Justinian himself lapsed into heresy, by accepting the doctrine that the earthly body of Christ was incorruptible, insensible to the weaknesses of the flesh, a doctrine which had been advanced by Julian, bishop of Halicarnassus, and went by the name of Aphthartodocetism. According to his usual practice, he issued an edict enforcing this view, and requiring all patriarchs, metropolitans, and bishops to subscribe to it. Some, who not unnaturally held that it was rank Monophysitism, refused at once, and were deprived of their sees, among them Eutychius the eminent patriarch of Constantinople. Others submitted or temporized; but, before there had been time enough for the matter to be carried through, the emperor died, having tarnished if not utterly forfeited by this last error the reputation won by a life devoted to the service of orthodoxy.

As no preceding sovereign had been so much interested in church affairs, so none seems to have shown so much activity as a persecutor both of heathens and of heretics. He renewed with additional stringency the laws against both these classes. The former embraced a large part of the rural population in certain secluded districts, such as parts of Asia Minor and Peloponnesus; and we are told that the efforts directed against them resulted in the forcible baptism of seventy thousand persons in Asia Minor alone. Heathenism, however, survived; we find it in Laconia in the end of the 9th century, and in northern Syria it has lasted till our own times. There were also a good many crypto-pagans among the educated population of the capital. Procopius, for instance, if he was not actually a pagan, was certainly very little of a Christian. Inquiries made in the third year of Justinian's reign drove nearly all of these persons into an outward conformity, and their offspring seem to have become ordinary Christians. At Athens, the philosophers who taught in the schools hallowed by memories of Plato still openly professed what passed for heathenism, though it was really a body of moral doctrine, strongly tinged with mysticism, in which there was far more of Christianity and of the speculative metaphysics of the East than of the old Olympian religion. Justinian, partly from religious motives, partly because he discountenanced all rivals to the imperial university of Constantinople, closed these Athenian schools (529). The professors sought refuge at the court of Chosroes, king of Persia, but were soon so much disgusted by the ideas and practices of the fire-worshippers that they returned to the empire, Chosroes having magnanimously obtained from Justinian a promise, that they should be suffered to pass the rest of their days unmolested. Heresy proved more obstinate. The severities directed against the Montanists of Phrygia led to a furious war, in which most of the sectaries perished, while the doctrine was not extinguished. Harsh-

laws provoked the Samaritans to a revolt, from whose effects Palestine had not recovered when conquered by the Arabs in the following century. The Nestorians and the Eutychian Monophysites were not threatened with such severe civil penalties, although their worship was interdicted, and their bishops were sometimes banished; but this vexatious treatment was quite enough to keep them disaffected, and the rapidity of the Mahometan conquests may be partly traced to that alienation of the bulk of the Egyptian and a large part of the Syrian population which dates from Justinian's persecutions.<sup>1</sup>

4. Justinian was engaged in three great foreign wars, two of them of his own seeking, the third a legacy which nearly every emperor had come into for three centuries, the secular strife of Rome and Persia. The Sassanid kings of Persia ruled a dominion which extended from the confines of Syria to those of India, and from the straits of Oman to the Caucasus. The martial character of their population made them formidable enemies to the Romans, whose troops were at this epoch mainly barbarians, the settled and civilized subjects of the empire being as a rule averse to war. When Justinian came to the throne, his troops were maintaining an unequal struggle on the Euphrates against the armies of Kobad. After some campaigns, in which the skill of Belisarius obtained considerable successes, a peace was concluded in 533 with Chosroes Anushirvan, who had succeeded Kobad two years before. This lasted till 539, when Chosroes declared war, alleging that Justinian had been secretly intriguing against him with the Eplthallite Huns, and doubtless moved by alarm and envy at the victories which the Romans had been gaining in Italy. The emperor was too much occupied in the West to be able adequately to defend his eastern frontier. Chosroes advanced into Syria with little resistance, and in 540 captured Antioch, then the greatest city in Asia, carrying off its inhabitants into captivity. The war continued with varying fortunes for four years more in this quarter; while in the meantime an even fiercer struggle had begun in the mountainous region inhabited by the Lazæ at the south-eastern corner of the Black Sea. When after two and twenty years of fighting no substantial advantage had been gained by either party, Chosroes agreed in 562 to a peace which left Lazica to the Romans, but under the dishonourable condition of their paying thirty thousand pieces of gold annually to the Persian king. Thus no result of permanent importance flowed from these Persian wars, except that they greatly weakened the Roman empire, increased Justinian's financial embarrassments, and prevented him from prosecuting with sufficient vigour his enterprises in the West.

These enterprises had begun in 533 with an attack on the Vandals, who were then reigning in Africa. Belisarius, despatched from Constantinople with a large fleet and army, landed without opposition, and destroyed the barbarian power in two engagements. North Africa from beyond the straits of Gibraltar to the Syrtes became again a Roman province, although the Moorish tribes of the interior maintained a species of independence; and part of southern Spain was also recovered for the empire. The ease with which so important a conquest had been effected encouraged Justinian to attack the Ostrogoths of Italy, whose kingdom, though vast in extent, for it included part of south-eastern Gaul, Rætia, Dalmatia, and part of Pannonia, as well as Italy, Sicily, Sardinia, and Corsica, had been grievously weakened by the death first of the great Theodoric, and some years later of his grandson Athalaric, so that the Gothic nation was practically without

a head. Justinian began the war in 535, taking as his pretext the murder of Queen Amalasontha, daughter of Theodoric, who had placed herself under his protection, and alleging that the Ostrogothic kingdom had always owned a species of allegiance to the emperor at Constantinople. There was some foundation for this claim, although of course it could not have been made effective against Theodoric, who was more powerful than his supposed suzerain. Belisarius, who had been made commander of the Italian expedition, overran Sicily, reduced southern Italy, and in 536 occupied Rome. Here he was attacked in the following year by Vitigis, who had been chosen king by the Goths, with a greatly superior force. After a siege of more than a year, the energy, skill, and courage of Belisarius, and the sickness which was preying on his troops, obliged Vitigis to retire. Belisarius pursued his diminished army northwards, shut him up in Ravenna, and ultimately received the surrender of that impregnable city. Vitigis was sent prisoner to Constantinople, where Justinian treated him, as he had previously treated the captive Vandal king, with clemency. The imperial administration was established through Italy, but its rapacity soon began to excite discontent, and the kernel of the Gothic nation had not submitted. After two short and unfortunate reigns, the crown had been bestowed on Totila or Baduila, a warrior of distinguished abilities, who by degrees drove the imperial generals and governors out of Italy. Belisarius was sent against him, but with forces too small for the gravity of the situation. He moved from place to place during several years, but saw city after city captured by or open its gates to Totila, till only Ravenna, Otranto, and Ancona remained. Justinian was occupied by the ecclesiastical controversy of the Three Chapters, and had not the money to fit out a proper army and fleet; indeed, it may be doubted whether he would ever have roused himself to the necessary exertions but for the presence at Constantinople of a knot of Roman exiles, who kept urging him to reconquer Italy, representing that with their help and the sympathy of the people it would not be a difficult enterprise. The emperor at last complied, and in 552 a powerful army was despatched under Narses, an Armenian eunuch now advanced in life, but reputed the most skilful general of the age, as Belisarius was the hottest soldier. He marched along the coast of the Gulf of Venice, and encountered the army of Totila at Tagina, not far from Cesena. Totila was slain, and the Gothic cause irretrievably lost. The valiant remains of the nation made another stand under Teias on the Lactarian hill in Campania; after that they disappear from history. Italy was recovered for the empire, but it was an Italy terribly impoverished and depopulated, whose possession carried little strength with it. Justinian's policy both in the Vandalic and in the Gothic war stands condemned by the result. The resources of the state, which might better have been spent in defending the northern frontier against Slavs and Huns and the eastern frontier against Persians, were consumed in the conquest of two countries which had suffered too much to be of any substantial value, and which, separated by language as well as by intervening seas, could not be permanently retained. However, Justinian must have been almost preternaturally wise to have foreseen this: his conduct was in the circumstances only what might have been expected from an ambitious prince who perceived an opportunity of recovering territories that had formerly belonged to the empire, and over which its rights were conceived to be only suspended.

Besides these three great foreign wars, Justinian's reign was troubled by a constant succession of border invasions, especially on the northern frontier, where the various Slavonic and Hunnish tribes who were established along

<sup>1</sup> For a fuller account of the ecclesiastical policy of Justinian and its results the present writer ventures to refer to the article "Justinian" which he has contributed to the third volume of Dr Smith's *Dictionary of Christian Biography*.



the lower Danube and on the north coast of the Black Sea made frequent marauding expeditions into Thrace and Macedonia, sometimes penetrating as far as the walls of Constantinople in one direction and the isthmus of Corinth in another. Immense damage was inflicted by these marauders on the subjects of the empire, who seem to have been mostly too peaceable to defend themselves, and whom the emperor could not spare troops enough to protect. Fields were laid waste, villages burnt, large numbers of people carried into captivity; and on one occasion the capital was itself in danger.

It only remains to say something regarding Justinian's personal character and capacities, with regard to which a great diversity of opinion has existed among historians. The civilians, looking on him as a patriarch of his science, have as a rule extolled his wisdom and virtues; while ecclesiastics of the Roman Church, from Cardinal BARNIUS downwards, have been offended by his arbitrary conduct towards the popes, and by his last lapse into heresy, and have therefore been disposed to accept the stories which ascribe to him perfidy, cruelty, rapacity, and extravagance. The difficulty of arriving at a fair conclusion is increased by the fact that PROCOPIUS, who is our chief authority for the events of his reign, speaks with a very different voice in his secret memoirs (the *Anecdota*) from that which he has used in his published history, and that some of the accusations contained in the former work are so rancorous and improbable that a certain measure of discredit attaches to everything which it contains. The truth seems to be that Justinian was not a great ruler in the higher sense of the word, that is to say, a man of large views, deep insight, a capacity for forming just such plans as the circumstances needed, and carrying them out by a skilful adaptation of means to ends. But he was a man of considerable abilities, wonderful activity of mind, and admirable industry. He was interested in many things, and threw himself with ardour into whatever he took up; he contrived schemes quickly, and pushed them on with an energy which usually made them succeed when no long time was needed, for, if a project was delayed, there was a risk of his tiring of it and dropping it. Although vain and full of self-confidence, he was easily led by those who knew how to get at him, and particularly by his wife. She exercised over him that influence which a stronger character always exercises over a weaker, whatever their respective positions; and unfortunately it was seldom a good influence, for Theodora seems to have been a woman who, with all her brilliant gifts of intelligence and manner, had no principles and no pity. Justinian was rather quick than strong or profound; his policy does not strike one as the result of deliberate and well-considered views, but dictated by the hopes and fancies of the moment. His activity was in so far a misfortune as it led him to attempt too many things at once, and engage in undertakings so costly that oppression became necessary to provide the funds for them. Even his devotion to work, which excites our admiration in the centre of a luxurious court, was to a great extent unprofitable, for it was mainly given to theological controversies which neither he nor any one else could settle. Still, after making all deductions, it is plain that the man who accomplished so much, and kept the whole world so occupied, as Justinian did during the thirty-eight years of his reign, must have possessed no common abilities. He was affable and easy of approach to all his subjects, with a pleasant address; nor does he seem to have been, like his wife, either cruel or revengeful. We hear several times of his sparing those who had conspired against him. But he was not scrupulous in the means he employed, and he was willing to maintain in power detestable ministers if only they served him efficiently and filled his coffers. His chief passion, after that for his own fame and glory, seems to have been for theology and religion; it was in this field that his literary powers exerted themselves (for he wrote controversial treatises and hymns), and his taste also, for among his numerous buildings the churches are those on which he spent most thought and money. Considering that his legal reforms are those by which his name is mainly known to posterity, it is curious that we should have hardly any information as to his legal knowledge, or the share which he took in those reforms. In person he was somewhat above the middle height, well-shaped, with plenty of fresh colour in his cheeks, and an extraordinary power of doing without food and sleep. He spent most of the night in reading or writing, and would sometimes go for a day with no food but a few green herbs. Two mosaic figures of him exist at Ravenna, one in the apse of the church of S. Vitale, the other in the church of S. Apollinare in Urbe; but of course one cannot be sure how far in such a stiff material the portrait fairly represents the original. He had no children by his marriage with Theodora, and did not marry after her decease. On his death, which took place November 14, 565, the crown passed to his nephew Justin II.

*Authorities.*—For the life of Justinian the chief authorities are PROCOPIUS (*Historia*, *De Edificiis*, *Anecdota*) and (from 552 A.D.)

the *History of Agathias*; the Chronicle of Johannes Malalas is also of value. Occasional reference must be made to the writings of Jordanes and Marcellinus, and even to the late compilations of Cedrenus and Zonaras. The *Vita Justiniani* of Ludewig or Ludwig (Halle, 1731), a work of patient research, is frequently referred to by Gibbon in his important chapters relating to the reign of Justinian. There is a *Vie de Justinien* by Isambert (2 vols., Paris, 1856). (J. BR.)

JUSTINIAN II., Rhinotmetus, Roman emperor of the East from 685 to 695, and from 704 to 711, succeeded his father Constantine IV., at the age of sixteen. His reign was unhappy both at home and abroad. He made a truce with the Arabs, which admitted them to the joint possession of Armenia, Iberia, and Cyprus, while by removing 10,000 Christian Maronites from their native Lebanon, he gave the Arabs a command over Asia Minor of which they took advantage in 692 by conquering all Armenia. In 688 Justinian was defeated by the Bulgarians. Meanwhile the bitter dissensions caused in the church by the emperor, his bloody persecution of the Manichæans, and the insatiable and cruel rapacity with which, through his creatures Stephanus and Theodatus, he extorted the means of gratifying his sumptuous tastes, maddened his subjects into rebellion. In 695 they rose under Leontius, and, after cutting off the emperor's nose (whence his surname), banished him to Cherson in the Crimea. Leontius, after a reign of three years, was in turn dethroned and imprisoned by Tiberius Absimarus, who next assumed the purple. Justinian meanwhile had escaped from Cherson and married Theodora, sister of Busirus, khan of the Khazars. Compelled, however, by the intrigues of Tiberius, to quit his new home, he fled to Terbelis, king of the Bulgarians. With an army of 15,000 horsemen Justinian suddenly pounced upon Constantinople, slew his rivals Leontius and Tiberius, with thousands of their partisans, and once more ascended the throne in 704. His second reign was marked by an unsuccessful war against Terbelis, by Arab victories in Asia Minor, by devastating expeditions sent against his own cities of Ravenna and Cherson, and by the same cruel rapacity towards his subjects. Conspiracies again broke out; Bardanes, surnamed Philippicus, assumed the purple; and Justinian, the last of the house of Heraclius, was assassinated in Asia Minor, December 711.

JUTE is a vegetable fibre which, notwithstanding the fact that it has come under the notice of manufacturing communities only within comparatively recent times, has advanced in importance with so rapid strides that it now occupies among vegetable fibres a position, in the manufacturing scale, inferior only to cotton and flax. The term jute appears to have been first used by Dr Roxburgh in 1795, when he sent to the directors of the East India Company a bale of the fibre which he described as "the jute of the natives." Importations of the substance had been made at earlier times under the name of *pât*, an East Indian native term by which the fibre continued to be spoken of in England till the early years of the 19th century, when it was supplanted by the name it now bears. This modern name appears to be derived from *jhot* or *jhout* (Sanskrit, *jhat*), the vernacular name by which the substance is known in the Cuttack district, where the East India Company had extensive roperies at the time Dr Roxburgh first used the term.

The fibre is obtained from two species of *Corchorus* (nat. ord. *Tiliaceæ*), *C. capsularis* and *C. olitorius*, the products of both being so essentially alike that neither in commerce nor agriculture is there any distinction made between them. These and various other species of *Corchorus* are natives of Bengal, where they have been cultivated from very remote times for economic purposes, although there is reason to believe that the cultivation did

not originate in the northern parts of India. The two species cultivated for jute fibre are in all respects very similar to each other, except in their fructification and the relatively greater size attained by *C. capsularis*.—The

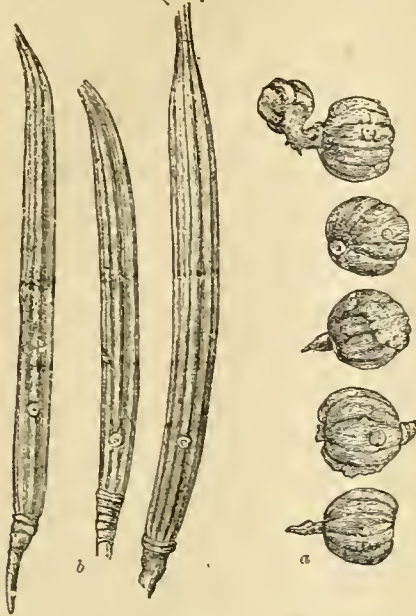

FIG. 1.—Capsules of Jute Plants. a, *Corchorus capsularis*; b, *C. olitorius*.

capsules or seed-pods in the case of *C. capsularis* are globular, rough, and wrinkled, while in *C. olitorius* they are slender quill-like cylinders, a very marked distinction,



FIG. 2.—*Corchorus olitorius*.

as may be noted from fig. 1, in which a and b show the capsules of *C. capsularis* and *C. olitorius* respectively. Fig. 2 represents a flowering top of *C. olitorius*. The two plants are thus botanically defined:—

*Corchorus capsularis*.—Annual; 5-10 feet; calyx deeply 5-lobed; petals 5; leaves alternate, oblong, acuminate, serrated, two lower serratures terminating in narrow filaments; peduncles short; flowers whitish-yellow, in clusters opposite the leaves; capsules globose, truncated, wrinkled, and mucicated, 5-celled; seeds few in each cell, without transverse partitions; in addition to the 5-partite cells, there are other 5 alternating, smaller and empty.

*Corchorus olitorius*.—Annual; 5-6 feet; erect; leaves alternate, ovate-acuminate, serrated, the two lower serratures terminated by a slender filament; peduncles 1-2 flowered; calyx 5-sepalled; petals 5; capsules nearly cylindrical, 10-ribbed, 5-celled, 5-valved; seeds numerous, with nearly perfect transverse septa; flowers small, yellow.

Both species are cultivated in India, not only on account of their fibre; but also for the sake of their leaves, which are there extensively used as a pot-herb. The use of *C. olitorius* for the latter purpose dates from very ancient times, if it may be identified, as some suppose, with the mallows (𑀧𑀺𑀢𑀺) mentioned in Job xxx. 4, "Who cut up mallows by the bushes." It is certain that the Greeks used this plant as a pot-herb; and by many other nations around the shores of the Mediterranean this use of it was, and is still, common. Throughout Bengal the name by which the plants when used as edible vegetables are recognized is *nalitá*; when on the other hand they are spoken of as fibre-producers it is generally under the name *pát*. Both species are cultivated, on account of the fibre they yield, in the greater part of Bengal. The cultivation of *C. capsularis* is most prevalent in central and eastern Bengal, while in the neighbourhood of Calcutta, where, however, the area under cultivation is limited, *C. olitorius* is principally grown. In 1872, a year which showed an extraordinary development of the cultivation, there were returned 921,000 acres as under jute in Bengal, to which Pubna contributed 122,000, Dinajpur 117,000, and Rangpur 100,000 acres respectively.

Hitherto jute has not been cultivated to any considerable extent in localities other than Bengal. From remote times it has been grown in the Hankow district of China, but not largely. In the United States of America the cultivation of the plants has also been introduced, but it has not made much progress. Recently considerable attention has been given to the culture of the plant in Egypt, and in the Dundee trade report of the 23d March 1881 there occurs the following statement:—"Some samples of jute grown in Egypt are being shown here. Reports on quality are varied, but, considering it is a first attempt, on the whole satisfactory. It proves beyond a doubt that Egypt is capable of producing this material, and for the trade of the district this is a matter of great importance, as having the fibre grown near at hand will enable our manufacturers to compete more successfully in all markets with the Indian mills."

A hot moist climate with abundant rainfall and rich alluvial soil appear to be the conditions most favourable for the successful cultivation of the jute plants. The land requires to be well tilled and abundantly manured, and, the ground being so prepared, the general time of sowing the seed throughout northern and eastern Bengal extends from about the middle of March to the end of May. The seed is sown broadcast on the prepared ground, the young plants are thinned out to 6 inches apart, and the ground carefully weeded. The stalks are ready for cutting down between the middle of August and the middle of October. As a rule the plants are cut down close to the root with a kind of bill-hook or sickle, and the fibre is obtained best in quality when the crop is secured in the flower. It is, however, common to allow the crop to run to seed and even to ripen seed before cutting, a practice which renders the resulting fibre hard and woody, thus intensifying one of the principal drawbacks of the jute fibre.

The fibre is separated from the stalks by the process



of retting practised in the case of flax, hemp, &c. (see FLAX, vol. ix. p. 294). In certain districts of Bengal it is the practice to stack the crop for a few days previous to retting, during which period the leaves drop off the stalks, and otherwise the stalks themselves are thereby brought into a condition for more rapid retting. The general practice, however, is to tie the crop into bundles sufficient for one man to carry, and to place these at once in water for the purpose of retting. Pools and ponds of stagnant water are preferred for retting where such are available, but the process is also carried on in the water of running streams. The period necessary for the completion of the retting process varies much according to the temperature and condition of the water, and may be said to occupy from two or three days up to a month. The stalks are examined periodically to test the progress of the retting operation, and when it is found that the fibres peel off and separate readily from the woody portion of the stalk, the operation is complete, and the bundles are withdrawn. The following is a description of the method generally practised for separating the fibre from the stalks. "The proper point being attained, the native operator, standing up to his middle in water, takes as many of the stalks in his hands as he can grasp, and, removing a small portion of the bark from the ends next to the roots, and grasping them together, he strips off the whole with a little management from end to end without either breaking stem or fibre. Having prepared a certain quantity into this half state, he next proceeds to wash off: this is done by taking a large handful; swinging it round his head he dashes it repeatedly against the surface of the water, drawing it through towards him so as to wash off the impurities, then with a dexterous throw he fans it out on the surface of the water and carefully picks off all remaining black spots. It is now wrung out so as to remove as much water as possible, and then hung up on lines prepared on the spot to dry in the sun." The separated fibre is then washed, sun-dried, and made up into hanks, and so is ready for the market. In favourable circumstances the produce of cleaned fibre amounts, on an average, to about 6 maunds per beegah (13½ cwts. per acre), but official returns from various districts show differences ranging from 5 to 26 or even 30 cwts. per acre. The cost of cultivation also varies much in different localities. According to the official report of Hem Chunder Kerr, it is as much as Rs. 17 per beegah (about £2, 12s. per acre) in Clittagong, and as low as R. 1 (or 3s. per acre) in Manbhūm; but such estimates are obviously of little value, as the cultivation is carried on by the ryots without the aid of hired labour, and forms generally only one among the various cultivated products of the land by which a livelihood is obtained. Jute, however, is certainly one of the most cheaply raised and prepared of all fibres; and to this fact more than to any special excellency of character it possesses is due its now extensive employment as a manufacturing staple.

The characters by which qualities of jute are judged are principally colour, lustre, softness, strength, length, firmness, uniformity, and cleanness of fibre. The best qualities of jute are of a clear white yellowish colour, with a fine silky lustre, soft and smooth to the touch, and fine, long, and uniform in fibre. As a general rule the root ends are harsher and more woody than the middle and upper portions, but in fine jute this distinction is not so noticeable as in less valuable qualities. In length the fibre varies from 6 to 7 feet, but occasionally it is obtained to a length of 14 feet, and, generally speaking, in proportion to the length of the fibre is its fineness of quality. Inferior qualities of jute are brownish in colour and, especially at the root ends, harsh and woody, with much adhering dark cortical matter and other impurities. The fibre is decidedly

inferior to flax and hemp in strength and tenacity; and, owing to a peculiarity in its microscopic structure, by which the walls of the separate cells composing the fibre vary much in thickness at different points, the single strands of fibre are of unequal strength. Recently prepared fibre is always stronger, more lustrous, softer, and whiter than such as has been stored for some time,—age and exposure rendering it brown in colour and harsh and brittle in quality. Jute, indeed, is much more woody in texture than either flax or hemp, a circumstance which may be easily demonstrated by its behaviour under appropriate reagents; and to that fact is due the change in colour and character it undergoes on exposure to the air. The fibre bleaches with facility, up to a certain point, sufficient to enable it to take brilliant and delicate shades of dye colour, but it is with great difficulty brought to a pure white by bleaching. A very striking and remarkable fact, which has much practical interest, is its highly hygroscopic nature. While in a dry position and atmosphere it may not possess more than 10 per cent. of moisture, under damp conditions it will absorb up to 30 per cent. or thereby.

As already stated, its commercial distinction is based on the botanical species of plant from which the fibre is prepared; but in the Calcutta market a series of commercial staples are recognized based on the districts whence they are drawn, the values of which bear a pretty constant relation to each other. These classes, in the order of quality, are:—(1) *Uttariyá* or northern jute, coming from Rangpur, Goalpara, Bogra, and the districts north of Sirajganj;—for length, colour, and fineness, this is unequalled; (2) *Deswál* or Sirajganj jute, which is valued on account of its softness, bright colour, fineness, and strength,—in the last characteristic it is superior to *Uttariyá* jute; (3) *Desi* jute comes from Hooghly, Bardwan, Jessore, and the 24 Parganas; (4) *Devrá* jute is produced in Faridpur and Bakarganj,—it is a strong coarse dark and sooty fibre used principally for rope-making. The other qualities recognized in Calcutta are—(5) *Narainganji* jute from Dacca, a strong soft long fibre, of inferior colour; (6) *Bákrábadí* jute from Dacca, of fine colour and softness; (7) *Bhatial* jute from Dacca, very coarse but strong, and very suitable for rope-making; (8) *Karimganji* jute from the Mymensing district, a long, strong, and well-coloured staple; (9) *Mirganji* jute, the produce of Raugpur, harsh and woody from over-ripeness of the stalks; and (10) *Jangipuri* jute of Patna, a short, weak, and foxy-coloured fibre of very inferior quality. In the European markets these distinctions are not much remarked, traders' marks and classification being the accepted standards of quality and condition. Moreover, it is only the finer qualities that are exported, the lower class jute being used locally for gunny bags, ropes, &c.

At Calcutta and various other centres the jute received from local traders is sorted, packed, and pressed into bales of 400 lb for shipment to the English and other markets. Woody and hard root ends, which will not press into bales, are cut off and sold separately under the name of "cuttings." "Jute," "cuttings," and "rejections" (the last the name of the low-class fibre) are the three heads under which jute fibre is entered in the trade and import lists of Western countries.

*The Jute Trade of Calcutta.*—The importation of jute into Europe commenced about the end of the last century, but so recently as that period it was confused with hemp. During the earlier years of the present century the imports slowly increased, but, as Hem Chunder Kerr says, "the shipments were so insignificant that little or no notice was taken of them by the custom house authorities." Since that time a great revolution has taken place. In 1829 the custom house assigned to jute a separate heading, in which

year we find the exports amounted to 496 maunds (364 cwt.). From that time the growth of the trade has been upon the whole steady and continuous, and marked by extraordinary progress, as will be evident from the following table of exports, which is compiled from official sources:—

	Quantity	Value	Average of Five Years' Quantity.	Average of Five Years' Value.
	cwts. qrs. lb	£	cwts.	
1829	364 2 0	62		
1830	1,776 2 0	417		
1831	7,677 3 0	2,222		
1832	23,852 2 0	6,361		
1833	25,333 2 18	6,577		
1829-33	59,004 3 18	15,639	11,800	£3,127
1834-38	317,415 3 11	83,246	67,483	16,649
1839-43	585,238 0 0	119,604	117,671	23,920
1844-48	1,176,279 0 0	256,125	234,655	51,225
1849-53	1,196,750 0 0	644,165	439,350	129,833
1854-58	3,564,131 0 0	1,298,319	710,826	259,667
1859-63	4,818,620 0 0	2,608,869	969,724	621,774
1864-68	13,140,550 0 0	6,129,596	6,628,110	1,225,918
1869	3,612,836 0 0	2,028,156		
1870	3,439,173 0 0	2,039,638		
1871	3,764,226 0 0	2,384,579		
1872	6,218,579 0 0	4,170,415		
1873	7,255,689 0 0	4,244,952		
1869-73	21,296,805 0 0	15,650,119	4,858,161	3,010,622
1874	6,126,000 0 0	3,153,500		
1875	5,600,000 0 0	3,244,000		
1876	5,207,000 0 0	2,865,300		
1877	4,574,000 0 0	2,664,300		
1878	5,494,000 0 0	3,568,300		
1874-78	26,801,000 0 0	13,640,900	5,361,500	3,134,500
1879	5,755,000 0 0	3,656,500		
1880	6,316,000 0 0	4,119,200		

Excepting a comparatively insignificant fraction, the whole of these exports of raw jute have been consigned to Great Britain, the United States of America being the only other country which bulks at all largely in the returns. Occasional shipments were made to America from 1829 onwards; but the quantities were small and very fluctuating till about 1850, up to which year frequently the total imports for a year were under 1000 cwts. From 1850-51 onward a rapidly increasing but still fluctuating demand for raw jute has grown up in the United States, till in 1872-73 the American demand amounted to 307,718 cwts. of jute and 1,158,895 cwts. of cuttings and rejections. An importation of 3072 cwts. was made into France in 1836-37, but there was no steady demand for jute in that country till 1845-46, when 9708 cwts. were taken. Since that time there has been a varying but upon the whole increasing demand, and in 1872-73 there were imported 137,126 cwts. The only other considerable shipments are to East Indian ports; but, taken altogether, it may be said that quite nine-tenths of the raw jute which leaves Calcutta is primarily disposed of in the British market.

**Jute Manufacture.**—Long before jute came to be known and to occupy a prominent place amongst the textile fibres of Europe, it was in extensive use and formed the raw material of a large and important industry throughout the regions of eastern Bengal, in which the plant was cultivated. Among the native Hindu population the spinning and weaving of jute was, and still is, in various districts, the most important domestic industry. The forms into which the material is worked among the Hindu population—for the Mussulmans do not use jute—are cordage, cloth, and paper. The cordage is twisted into all sizes, from the fine thread used for weaving up to strong ropes for the hawsers of native boats and for tying bales. The more important native application of jute is, however, in the manufacture of gunny cloth and gunny bags, used in extraordinary quantity and number throughout the world, for packing and carrying all manner of goods and merchandise, and by

the natives themselves for clothing and numerous domestic purposes. The ordinary mode of weaving gunnies for bags and other coarse purposes is thus described:—"Seven sticks or chattee weaving-posts, called *tand pará* or warp, are fixed upon the ground, occupying the length equal to the measure of the piece to be woven, and a sufficient number of twine or thread is wound on them as warp called *tand*. The warp is taken up and removed to the weaving machine. Two pieces of wood are placed at two ends, which are tied to the *ohari* and *okher* or roller; they are made fast to the *khoti*. The *belut* or treadle is put into the warp; next to that is the *sarsal*; a thin piece of wood is laid upon the warp, called *chupari* or regulator. There is no sley used in this, nor is a shuttle necessary; in the room of the latter a stick covered with thread called *singa* is thrown into the warp as woof, which is beaten in by a piece of plank called *beyno*, and as the cloth is woven it is wound up to the roller. Next to this is a piece of wood called *khetone*, which is used for smoothing and regulating the woof; a stick is fastened to the warp to keep the woof straight." Gunny cloth is woven of numerous qualities, according to the purpose to which it is devoted. Some kinds are made close and dense in texture, for carrying such seed as poppy or rape and sugar; others less close are used for rice, pulses, and seeds of like size, and coarser and opener kinds again are woven for the outer cover of packages and for the sails of country boats. There is a thin close-woven cloth made and used as garments among the females of the aboriginal tribes near the foot of the Himalayas, and in various localities a cloth of pure jute or of jute mixed with cotton is used as a sheet to sleep on, as well as for wearing purposes. To indicate the variety of uses to which jute is applied, the following quotation may be cited from the official report of Hem Chunder Kerr as applying to Midnapur. "The articles manufactured from jute are principally (1) gunny bags; (2) string, rope, and cord; (3) *kampa*, a net-like bag for carrying wood or hay on bullocks; (4) *chat*, a strip of stuff for tying bales of cotton or cloth; (5) *dola*, a swing on which infants are rocked to sleep; (6) *shika*, a kind of hanging shelf for little earthen pots, &c.; (7) *dulina*, a floor cloth; (8) *beera*, a small circular stand for wooden plates used particularly in *poojahs*; (9) painter's brush and brush for white-washing; (10) *ghumsi*, a waist-band worn next to the skin; (11) *gochh-dari*, a hair-band worn by women; (12) *mukbar*, a net bag used as muzzle for cattle, (13) *parchula*, false hair worn by players; (14) *rakhi-bandhan*, a slender arm-band worn at the Rakhi-poornima festival; and (15) *dhup*, small incense sticks burned at *poojahs*." Raw jute fibre and old gunnies are also largely used throughout the presidency in the manufacture of paper.

The introduction of jute factories on the European system into Bengal has had a considerable influence on the domestic manufacture of jute, notwithstanding that a vast industry is still prosecuted in the ancient Hindu manner.

The following extracts from official tables will show the extent of this particular branch of industry

The number of gunny bags imported into Calcutta amounted in 1877-78 to 21,446,000, in 1878-79 to 26,380,000, and in 1879-80 to 20,488,000.

The different districts which contributed chiefly to the trade during these three years are the following:—

Name of District	1877-78.	1878-79.	1879-80.
	Number	Number	Number
Bijnapur.....	3,790,000	8,641,000	6,193,000
Hoochly.....	6,257,000	6,920,000	5,994,000
24 Parganas.....	3,150,000	3,303,000	4,020,000
Pubna.....	2,951,000	2,532,000	2,658,000
Bardwan.....		263,000	326,000
Purannah.....	494,000	547,000	260,000
Jalpaiguri.....	281,000	484,000	204,000
Rangpur.....	117,000	512,000	169,000



The gunny bags exported from Calcutta in the year 1877-78 numbered 79,384,000; in 1878-79, 82,635,000; and in 1879-80, 92,284,000.

It will be seen that the exports of bags exceed the quantity sent into Calcutta by no less than 57,938,000 bags in 1877-78, 56,255,000 in 1878-79, and 71,796,000 in 1879-80. This is of course due to the large manufacture in Calcutta and the suburbs.

The import trade of Calcutta in gunny cloth during the three years referred to was in round numbers as follows:—51,000 pieces in 1877-78, 70,000 in 1878-79, and 88,000 in 1879-80.

Out of the total supply, that of power-loom manufacture was 43,000 pieces in 1879-80, as compared with 19,000 pieces in 1878-79. The hand-made pieces amounted to 45,000, as compared with 51,000 in 1878-79.

The export of gunny cloth by sea was consigned as follows:—

	1878-79.			1879-80.		
	Power-Loom.	Hand-Loom.	Total.	Power-Loom.	Hand-Loom.	Total.
To foreign ports	Yards. 4,530,000	Yards. 57,000	Yards. 4,587,000	Yards. 5,210,000	Yards. 1,000	Yards. 5,211,000
„ Indian „	3,135,000	17,000	3,152,000	1,658,000	7,000	1,665,000
Total .....	7,665,000	74,000	7,739,000	6,868,000	8,000	6,876,000

Besides the registered supplies mentioned above, the returns show a large quantity of power-loom gunny cloth, amounting to 664,000 pieces, sent up country from Calcutta mills without passing the port commissioners wharves. The gross total of gunny cloth exported from Calcutta was 54,731,000 yds. in 1878-79, and 61,468,000 yds. in 1879-80.

Formerly America was the largest customer for Indian jute manufactures, very large quantities of gunny having been consigned to the United States for packing cotton and other merchandise. That demand has, however, very largely fallen off, and now the Australian colonies and Burmah and the various East Indian ports are the principal places to which the manufactured articles are sent from Calcutta.

*European Trade and Manufacture.*—The occasional parcels of jute which were sent to the European market by the East India Company previous to the year 1830 appear to have been principally used for the making of door mats

and similar purposes; but the whole quantity was at that date, and, as will be seen by the table, p. 801, for several years thereafter, quite insignificant. Some part of these imports found their way to Abingdon in Berkshire, a town in which the manufacture of carpets, sacking, and cordage was extensively prosecuted, and to the manufacturers of that town is due the credit of being the first in Great Britain to experiment with the fibre, making it into yarn and cloth. In 1833 a quantity of dyed yarn was sent from Abingdon to Dundee, then an important centre of the heavier flax manufactures, and there it attracted a good deal of attention. Consignments were soon thereafter received direct at Dundee and experimented with, but little or no real progress was made for a considerable time, for jute forms no exception to the general rule that the introduction of new textile fibres is attended with many difficulties before a successful issue is reached. The many unsuccessful attempts to convert it into yarn caused it to be disliked by the manufacturer, and the bad reputation it had acquired as to strength and durability made it no favourite in public estimation. Indeed, so far was prejudice carried against it that some of the manufacturers banished the fibre entirely from their works, fearing it might prove prejudicial to their interests. Among the circumstances which added materially to the rapid development of the jute trade, lying outside its natural growth owing to cheapness and other causes, were the war with Russia in 1854-56, which temporarily cut off the supplies of Russian flax and hemp, and the cotton famine which resulted from the civil war in America in 1861-63. Leaving these circumstances out of account, however, the growth of the jute trade has been remarkable and steady, as will be seen by the following table, embracing a period of fifteen years from 1865 to 1880, during which no such cause as those alluded to above affected the trade.

*Details of Importation and Exportation of Jute into and from the United Kingdom, 1865-1879.*

	Jute Imported.			Yarn Exported.			Manufactures Exported.			Jute Exported.	
	Quantity.	Computed Value.	Average Price.	Quantity.	Declared Value.	Average Price.	Quantity.	Declared Value.	Average Price.	Quantity.	Computed Value.
	Cwts.	£	s	lb.	£	d.	Yds.	£	d.	Cwts.	£
1865	2,108,942	1,774,992	16 83	4,944,230	82,141	3 99	15,400,459	311,540	4 86	417,981	351,801
1866	1,625,903	1,476,244	18 16	7,761,391	128,704	3 98	19,394,926	361,857	4 48	416,352	378,186
1867	1,582,611	1,414,321	17 87	7,520,911	117,028	3 73	26,743,187	455,396	4 09	366,793	327,057
1868	2,182,521	1,936,230	17 74	8,108,101	126,045	3 73	43,081,322	706,966	3 94	415,266	368,549
1869	2,467,817	2,143,100	17 37	8,041,082	126,691	3 78	50,127,853	742,801	3 56	413,952	358,758
1870	2,376,690	2,326,100	19 58	12,669,948	196,465	3 72	51,920,868	789,657	3 65	425,712	416,843
1871	3,434,120	3,729,735	21 60	13,710,957	262,057	4 59	62,310,463	1,026,759	3 95	575,177	650,431
1872	4,041,018	3,954,698	19 57	12,715,969	261,239	4 93	84,452,457	1,486,484	4 22	755,120	724,659
1873	4,624,918	3,619,989	15 65	12,263,805	206,521	4 04	95,935,108	1,590,850	3 98	790,344	649,880
1874	4,270,164	3,553,179	16 64	15,724,988	245,784	3 75	112,810,415	1,679,766	3 57	716,631	603,619
1875	3,416,617	2,575,512	15 08	15,942,618	225,836	3 40	101,105,579	1,404,997	3 34	1,050,589	798,146
1876	3,825,259	2,804,597	14 66	16,709,239	226,813	3 26	120,813,966	1,558,256	3 09	933,667	704,904
1877	3,649,877	2,929,965	16 06	14,997,659	217,424	3 48	116,753,003	1,547,408	3 11	968,102	806,792
1878	4,242,382	3,236,825	15 26	12,234,600	181,076	3 55	122,961,200	1,588,901	3 10	1,013,497	792,176
1879	4,759,363	3,257,497	13 69	13,572,100	200,112	3 54	164,054,600	1,963,153	2 87	1,117,953	807,139

*Manufacture.*—In their general features the spinning and weaving of jute fabrics do not differ essentially as to machinery and processes from those employed in the manufacture of hemp and heavy flax goods. Owing, however, to the woody and brittle nature of the fibre, it has to undergo a preliminary treatment peculiar to itself. The pioneers of the jute industry, who did not understand this necessity, or rather who did not know how the woody and brittle character of the fibre could be remedied, were greatly perplexed by the difficulties they had to encounter, the fibre spinning badly into a hard, rough, and hairy yarn owing to the splitting and breaking of the fibre. This peculiarity of jute, coupled also with the fact that the machinery on which it was first spun, although quite suitable for the stronger and more elastic fibres for which it

was designed, required certain modifications to suit it to the weaker jute, was the cause of many annoyances and failures in the early days of the trade.

*Batching or Softening.*—The introduction of this preliminary process constituted the first important step in the practical solution of the difficulties of jute spinning. The process, in a great measure, supplies artificially that in which jute is naturally deficient. The mode of batching originally adopted was to divide the rolls or heads, taken from the bale, into four or five parts, each being about what a hand could grasp. These divisions, called stricks, were doubled up with a slight turn at the centre, and laid out in the floor in double rows, the roots and crop ends of the stricks overlapping each other, in the centre of the batch; each row when completed received a certain per-

centage of whale oil and water, and, according to the ideas of the person superintending, a mixture of ashes or other ingredients, supposed to have a softening tendency. These batches, which generally contained from 4 to 5 tons each, were allowed to lie from twenty-four to forty-eight hours, at the end of which time a slight fermentation caused by the oil and water was induced, and the batch was then considered ready for the preparation process. The hand process has now, however, been superseded by a more speedy and economical appliance. In order to get the fibre into that soft pliant condition so essential to the spinning operation, jute softeners or mangles have been introduced. Of these machines there are various types, but in their general outline and principle they are closely allied to each other. The machine consists of a double row of fluted rollers, generally from twelve to eighteen pairs, the one placed on the top of the other, so that the flutes longitudinally intersect each other. The rollers, when the machine is in motion, have a rippling reciprocating action, by which means the material passing through is rendered soft and pliant. In connexion with this machine, and with the view of dispensing with the more cumbersome and expensive mode of batching already described, an apparatus is attached, and is so adjusted that the jute on passing through the rollers receives with great precision a proper allowance of oil and water. The quantity of oil used varies from half a gallon to one gallon per 400 lb bale, and the quantity of water, according as the atmosphere is dry or damp, is from 12 to 18 per cent. of the weight of material operated on.

Such qualities of jute as retain rough and hard root ends or "butts" require to undergo another preliminary process termed "snipping," by which these "butts" are combed out, and separated from the remainder of the fibre; these, being torn and split up into the form of tow, may be so used in the subsequent preparing and spinning operations. A good deal of jute is now prepared at Calcutta by the snipping process instead of by cutting, the butts being thereby secured in a more useful and valuable condition.

The material, after being softened, and, if necessary, snipped, is passed on to the assorters, whose duty is to select the different qualities for the special uses to which they may be applied.

*Spinning.*—All the subsequent processes through which jute passes are essentially the same as those employed in the corresponding heavy manufactures of flax (see LINEN). As in the case of that fibre, there are two dis-

tinctions of preparing yarn, viz., by "line" spinning and by "tow" spinning. If intended for line spinning, the long jute fibre is cut or rather broken into lengths of from 20 to 24 inches. It is then ready for hackling, spreading, drawing, and roving, just as in the parallel case of flax "line" spinning. Similarly in the tow spinning the fibre is first submitted to the breaker card, then the finishing card, after which it passes through the drawing frames and the roving frame, and then, as "rove" or rovings, it is ready for the spinning frame; but, in the case of some very heavy yarns, the material is spun direct on the roving frame.

The weights of jute yarn are estimated by the spindle of 14,400 yards, and the finest kinds spun are about "2 lb yarn," i.e., yarn weighing 2 lb per spindle. The minimum weight commonly found in the market is, however, 7 lb, from which the yarn lists rise in sizes up to 40 lb, or to very much heavier weights for special purposes. The ruling feature of jute is its cheapness, and the great demand for jute manufactures arises in connexion with rough and cheap fabrics, such as sacking and bagging, bale covers, hessians for upholstery purposes, &c., tarpaulings, linings, pocketings, and backing for floorcloths, for which purpose it is woven in webs from 6 to 8 yards wide. It takes dye colours readily, which, however, are fugitive, and as dyed yarn it is woven into carpets, rugs, &c.; and woven and printed curtain cloths and tapestries are also made from jute. The fibre, however, is not worthy of being woven into elaborate and somewhat costly fabrics; and it is not likely that as a tapestry material it will take any permanent place. Jute also lends itself readily to the sophistication of more expensive fibrous materials, and is said to be employed in the adulteration of woven silks, more especially in such as are used for cheap-ribbons, scarfs, &c. It can also be prepared to imitate human hair with remarkable closeness, and advantage of this is largely taken in making stage wigs.

Although a few jute factories have sprung up in several localities other than Dundee throughout the United Kingdom, notably in Glasgow, Aberdeen, and Barrow-in-Furness, and also in various parts of the Continent, Dundee is still the headquarters and controlling centre of the jute trade,—even many of the Bengal factories being owned by Dundee merchants. The following table shows the distribution of the trade and the number of persons finding employment in it for the United Kingdom at the respective dates mentioned:—

	Factories.			Spinning Spindles.			Doubling Spindles.		Power-Looms.			Persons Employed.		
	1861.	1868.	1874.	1861.	1868.	1874.	1868.	1874.	1861.	1868.	1874.	1861.	1868.	1874.
England and Wales .....	4	8	16	620	8,230	21,754	428	1,278	...	411	927	107	1,760	4,933
Scotland .....	27	31	84	30,538	72,547	185,419	1,924	7,658	554	2,783	8,325	5,418	12,127	30,893
Ireland .....	5	2	11	1,824	...	13,738	48	338	...	720 <sup>1</sup>	347	442	283	2,094
Total .....	36	41	110	32,982	...	220,911	2,400	9,274	564	3,919	9,599	5,976	14,170	37,920

<sup>1</sup> Exclusive of number of power-loom in one factory in Antrim.

Some of the Dundee factories are of enormous extent, that of Messrs Cox Brothers, for example, covering 22 acres, and giving employment to 5000 persons, while the annual output of jute fabrics measures as much as 15,500 miles.

(J. PA.)

JÜTERBOGK, JÜTERBOG, or JÜTERBOCK, the chief town of the circle Jüterbogk-Luckenwalde, in the government district of Potsdam and province of Brandenburg, Prussia, is situated on the Nuthe, 39 miles south-west of Berlin, with which it is connected by rail. It contains four Protestant churches, of which that of St Nicholas, dating from the close of the 14th century. Jüterbogk carries on

weaving and spinning both of flax and wool, and trades in the produce of those manufactures and in cattle. Vines are cultivated in the neighbourhood. Jüterbogk appears in history as the scene of religious discussions in 1548 and 1575, of a treaty between Brandenburg and Saxony in 1611, and of the victory of the Swedes under Torstenson over the imperial troops under Gallas in 1644. Two miles south-west is the battlefield of Dennewitz, where Bülow defeated Ney and Oudinot, September 6, 1813. The population, including the garrison, was 6852 in 1875; with the immediately adjacent villages of Damm and Neumarkt it was 8127



JUVENAL (DECIMUS JUNIUS JUVENALIS) has been more read and admired in modern times than any other Latin poet, with the exception of Virgil, Horace, and perhaps Ovid. The attraction which he has had, not for scholars only, but for men of letters and men of the world, is probably due less to any intrinsic superiority of genius,—for in genius he is not the equal of Lucretius or Catullus,—but to a quality of his writing to which one of the most recent and best of his English editors has drawn attention. “In depicting character,” says Mr Lewis,<sup>1</sup> “in drawing scenes, even in turns of expression, he is, of all ancient authors, the most distinctly modern.” But besides this attraction, which is due to the fact that he wrote at a time when the interest in social life and manners had superseded that formerly felt in the commonwealth, he has his own peculiar value to students of antiquity. He closes the roll of the great writers of Rome, and is the last vital representative of her national spirit and genius. It is mainly from his representation that the picture of the social life of the imperial city during the first century of our era lives in the imagination of the world. He is the most effective satirist of Rome, not because he was the greatest writer who made satire his theme, but because the age in which he lived supplied the largest material for purely satiric representation, and because his eye was fixed on the more sombre aspects of his time to the exclusion of those happier or more genial aspects which are reflected in the pages of Statius, Martial, and Pliny. The first impression produced by the satire of Juvenal is more powerful than that produced by the satire of Horace, as the impression produced by the tragical and sensational incidents of life is greater than that produced by its ordinary course and its lighter humours. The final verdict as to their relative excellence need not be in accordance with the first impression, but will be determined by the abiding sense of truth and conformity with real life which each representation leaves upon us. But Juvenal does stand prominently out, not in ancient literature only, but in the literature of the world, as the typical example of a social satirist, writing with a serious purpose. The burning indignation to which he attributes the inspiration of his verse, and its not unrequited accompaniment, the “censure of a sardonic laugh,” are his distinguishing notes.

Nor is it only in respect of subject-matter and the spirit in which that is treated, but also in respect of literary form and style, that poetical satire finds its typical representative in Juvenal. The systematic treatment of some special topic, the sustained rhetorical pitch, so unlike the natural conversational manner of Horace, at which the treatment is maintained, the strongly-drawn scenes and portraits illustrative of the theme, the effort to make every line effective by point and emphasis, which distinguish some of the great products of modern poetical satire, have their prototype in Juvenal. The frank communicativeness,—the impulse to establish a confidential relation with the reader,—which made the writings of Lucilius appear to a later generation like a “picture of his life” drawn by his own hand, and which gives to the satires of Horace all the charm of an autobiography, has altogether disappeared from the satire of Juvenal, and given place to an attitude almost as impersonal as that assumed in the letters of Junius. And this is the attitude which modern poetical satire for the most part maintains. It commands respect by the boldness and incisiveness of its assaults on classes and individuals, or it gains popularity by gratifying the natural love of detraction, but it leaves to the prose essayist and the novelist the humaner part of acting on the reader through his sympathies.

This absence from the writings of Juvenal of that personal element which played so large a part in the satires of Lucilius and Horace forces us to depend almost entirely on external evidence for our knowledge of his life. And our available external evidence is unfortunately very meagre and untrustworthy. After reviewing it all and reading it as far as possible by light derived from his own writings, we shall have to acknowledge that we know very little with certainty of his career, that the impression we form of his character and associations is indistinct and perhaps fallacious, and that even the indications which seem to fix the date of the composition of various satires may be misleading. Still, in order to read his writings with full profit and pleasure, we must try to bring ourselves in thought as near to the writer as our knowledge admits of. The ideal presentation of human life and character in an epic poem or drama bears its own evidence of its truth. It either conforms to, or fails to conform to, what the imagination conceives of the capabilities of human nature. In reading the realistic representation of an exceptional phase of society, we wish to know whether the painter of it was, from his position, likely to have seen and understood it, whether his object was to describe it as he saw it, and whether he was a man capable of judging it reasonably and candidly.

A brief account of Juvenal's life, varying considerably in some of its details, is prefixed to the different MSS. of his works. But the original on which these various versions of the life are founded cannot be traced to Suetonius or to any competent authority, and some of the statements contained in it are intrinsically improbable. According to the form prefixed to the most valuable of the MSS., “Juvenal was the son or ward of a wealthy freedman; he practised declamation till middle age, not as a professional teacher, but as an amateur, and made his first essay in satire by writing the lines on Paris, the actor and favourite of Domitian, now found in the seventh satire (line 90 sq.) :—

Quod non dant proceres, dabit histrio, &c.

Encouraged by their success, he devoted himself diligently to this kind of composition, but refrained for a long time from either publicly reciting or publishing his verses. When at last he did come before the public, his recitations were attended by great crowds and received with the utmost favour. But the lines originally written on Paris, having been inserted in one of his new satires, excited the jealous anger of an actor of the time, who was a favourite of the emperor, and procured the poet's banishment under the form of a military appointment to the extremity of Egypt. Being then eighty years of age, he died shortly afterwards of grief and vexation.” In one account the time of his banishment is said to have been the last years of Domitian; in another he is said to have been appointed to a command against the Scots by Trajan, in another to have died in exile in the reign of Antoninus Pius, and in another to have died of a broken heart on his return to Rome, because he found his friend Martial was no longer there. One account even makes Claudius the author of his banishment. In several Aquinum is mentioned as his birthplace, and in one he is said to have been born in the time of Claudius.

Some of these statements are so much in consonance with the indirect evidence afforded by the satires that they might almost be supposed to be a series of conjectures based upon them. The rare passages in which the poet speaks of his own position, as in satires xi. and xii., indicate that he was in comfortable but moderate circumstances. We should infer also that he was not dependent on any professional occupation, and that he was separated in social station, and probably too by tastes and manners, from the higher class to which Tacitus and Pliny belonged, as he

<sup>1</sup> *D. Junii Juvenalis Satiræ, with a literal English prose translation and notes*, by John Delaware Lewis, M.A.

was by character from the new men who rose to wealth by servility under the empire. Juvenal is no organ of the pride and dignity, still less of the urbanity, of the cultivated representatives of the great families of the republic. He is the champion of the more sober virtues and ideas, and perhaps the organ of the rancours and detraction, of an educated but depressed and embittered middle class. The literary representative of such a class might well be found in the heir of a well-to-do freedman, born and bred in a provincial town, too independent both in position and character to become permanently a hanger-on of the great, and perhaps too ungracious in manner and uncompromising in speech to mix easily with the class which inherited the aristocratic and courtly traditions of Roman literature. The statement that he was a trained and practised declaimer is confirmed both by his own words (i. 16) and by the rhetorical mould in which his thoughts and illustrations are cast. The allusions which fix the dates when his satires first appeared, and the large experience of life which they imply, agree with the statement that he did not come before the world as a professed satirist till after middle age.

The statement that he continued to write satires long before he gave them to the world accords well with the nature of their contents and the elaborate character of their composition. They are not the expression of some passing impulse, but seem to sum up the experience of a lifetime. They have indeed the freshness of immediate impressions, but they are so combined as to show that they have been long brooded over before assuming their final form. And that he was known as a writer of satires for years before the publication of any of them in their present form might almost be inferred from the emphatic but yet guarded statement of Quintilian in his short summary of Roman literature. After speaking of the merits of Lucilius, Horace, and Persius as satirists, he adds, "There are, too, in our own day, distinguished writers of satire whose names will be heard of hereafter" (*Inst. Or.*, x. I, 94). There is no Roman writer of satire who could be mentioned along with those others by so judicious a critic, and whose names have been heard of in after times, except Juvenal.

The motive which a writer of satire must have had for secrecy under Domitian is sufficiently obvious; and the necessity of concealment and self-suppression thus imposed upon the writer may have permanently affected his whole manner of composition.

So far the various authors of these lives have followed a probable and consistent tradition. But when we come to the story of the poet's exile, they are at variance both with probability and with one another. Some apparent confirmation is given to the tradition by the lines of a poet of the 5th century, Sidonius Apollinaris:—

"Nec qui consimili deinde casu  
Ad vuigi tenuem strepitus auram  
Irati fuit histronis exul."

There is no reason to doubt that these lines refer to Juvenal, but they only prove that the original story from which all the varying lives are derived was generally believed before the middle of the 5th century of our era. If Juvenal was banished at the age of eighty, the author of his banishment could not have been the "enraged actor" in reference to whom the original lines were written, as Paris was put to death in 83, and Juvenal was certainly writing satires long after 100 A.D. The satire in which the lines now appear was probably first published soon after the accession of Hadrian, when Juvenal was not an octogenarian but in the maturity of his powers. The cause of the poet's banishment at that advanced age could not therefore have been either the original composition or the first publication of the lines. But it has been conjectured that the anger of another actor, a favourite of the emperor, may have

been excited by a later application of them on some public occasion, and that the poet was punished for this unfortunate revival of lines which had never been intended for the person who resented them. Against this conjecture, based on a number of confused, uncertain, and contradictory traditions, we have to weigh the intrinsic improbability of the story. An expression in sat. xv. 45 is quoted as a proof that Juvenal had visited Egypt. He may have done so as an exile or in a military command; but it seems hardly consistent with the importance which the emperors attached to the security of Egypt, or with the concern which they took in the interests of the army, that these conditions were combined at an age so unfit for military employment. If any conjecture is warrantable on so obscure a subject, it is more likely that this temporary disgrace may have been inflicted on the poet by Domitian. Among the many victims of Juvenal's satire it is only against him and against one of the vilest instruments of his court, the Egyptian Crispinus, that the poet seems to be animated by personal hatred.<sup>1</sup> A sense of wrong suffered at their hands may perhaps have mingled with the detestation which he felt towards them on public grounds. But if he was banished under Domitian, it must have been either before or after the year 93 A.D., at which time, as we learn from an epigram of Martial, Juvenal was in Rome. The whole story may be ranked with the tradition of the love potion which is said to have maddened Lucretius, as one resting on such slight evidence as to admit neither of confirmation nor refutation.

More ancient and apparently more authentic evidence of the position filled by Juvenal during some period of his life has been recovered in recent times, in the form of an inscription found at Aquinum, recording, so far as it can be deciphered, the dedication of an altar to Ceres, by Junius Juvenalis, tribune of the first cohort of Dalmatians, "duumvir quinquennalis," and "flamen Divi Vespasiani." The terms of this inscription, when read along with one of the few passages in the satires in which Juvenal distinctly speaks of himself (iii. 318 sq.)—

"Et quotiens te  
Roma tuo refici properantem reddet Aquino,  
Me quoque ad Heivnam Cererem vestramque Dianam  
Converte a Cumis: satirarum ego, ni pudet illas,  
Auditor gelidos veniam caligatus in agros—"

leaves little doubt that the author of the inscription was either the poet himself or some member of his family, of whose existence we have no other indication. If then, as is most probable, Juvenal is himself the author of it, we learn that he did hold, at one period of his life, a post of military rank, one of municipal importance in his native town, and a priesthood of the deified Vespasian. But to what period of his life does this tablet bear evidence? The fact that he filled the position of "duumvir quinquennalis" shows that he was a man of influential position in the *municipium*, but the office was only held for a year,—the year apparently in which the census was taken at Rome,—and its tenure does not imply any prolonged absence from the metropolis. The satires, though they indicate an occasional preference for the simpler life of the country towns, are the product not of leisure in the provinces but of immediate and intimate familiarity with the life of the great city; and an epigram of Martial, written at the time when Juvenal was most vigorously employed in their composition, speaks of him as settled in Rome. It is possible, but not likely, that he may have retired to his native town in the latter years of his life, and that the last book of his satires (xiii.—xvi.), which contains no im-

<sup>1</sup> For the possible connexion of Crispinus with Juvenal's banishment compare Mayor, vol. ii. p. 421.



mediate references to Rome, and is written in a less angry mood than the earlier ones, may be the work of this retirement, and that it may have been during that time that he filled this office. On the other hand, it was by Domitian that the worship of Vespasian was established with especial sanctity, and it may be doubted whether a priesthood instituted in his honour would be recorded as a title of dignity late on in the reign of Hadrian. The lines already quoted from satire iii. imply that during his early career as a satirist Juvenal maintained his connexion with Aquinum, and that he had some special interest in the worship of the "Helvintian Ceres." Nor is the tribute to the national religion implied by the dedication of the altar to Ceres inconsistent with the beliefs and feelings expressed in the satires. While the fables of mythology are often treated contemptuously or humorously by him, other passages in the satires clearly imply a conformity to and even a respect for the observances of the national religion.<sup>1</sup> The spirit of Juvenal, which sought for a standard of right action rather in the old Roman and Italian traditions than in the tenets of philosophy, would incline him to sympathize with the revival of religious observance and also of a kind of belief in divine agency on human affairs, which accompanied the establishment of the empire. The evidence as to the military post filled by him is curious, when taken in connexion with the confused tradition of his exile in a position of military importance; and there appears to be some further evidence that the cohort of which he was tribune was quartered in Britain. But it cannot be said that the satires bear traces of military experience. The life described in them is such as would present itself to the eyes of a civilian, and would be talked about and commented on at the dinner tables and in the clubs, baths, theatres, and places of public resort in the great metropolis.<sup>2</sup>

The only other contemporary evidence which affords a glimpse of his actual life is contained in three epigrams of Martial. Two of these (vii. 24 and 91) were written in the time of Domitian, the other (xii. 18) early in the reign of Trajan, after Martial had retired to his native Bilbilis. The first of these epigrams, addressed to some backbiter who had endeavoured to embroil the two friends with one another, attests the strong regard which Martial felt for him; but the subject of the epigram seems to hint that there may have been something suspicious or uneasy in the temper of the satirist, which made the maintenance of a steady friendship with him difficult. In the second of these epigrams, addressed to Juvenal himself, the epithet "facundus" is applied to him, one which might equally be employed whether he was best known at the time as a writer of poetic satires or as an eloquent rhetorician. In the last Martial imagines his friend wandering about discontentedly (*inquietus*) through the crowded streets of Rome, and undergoing all the discomforts incident to attendance on the levees of the great:—

"Dum per limina te potentiorum  
Sudatrix toga ventilat."

Two lines in the poem (22–3) suggest that the satirist, who has inveighed with just severity against the worst corruptions of Roman morals, was not too rigid a censor of the morals of his friend. Indeed, his intimacy with Martial is a ground for not attributing to him exceptional strictness of life.

The additional information as to the poet's life and circumstances derivable from the satires themselves is not

important. He tells us what might easily be inferred from the number of allusions to the Greek and Latin poets contained in his satires, that he had enjoyed the training which all educated men received in his day (i. 15); he indicates, as was mentioned above, his connexion with the old Volscian town Aquinum; he speaks of his farm in the territory of Tibur (xi. 64), which furnished a young kid and mountain asparagus for a homely dinner to which he invites a friend during the festival of the Megalesiaca. In the satire in which this invitation is contained, and in one or two more of the later ones, he seems partially to remove the mask which he wears in the earlier and more directly aggressive satires. From it we are able to form an idea of the style in which he habitually lived, and to think of him as enjoying a hale and vigorous age (line 203), and also as a kindly master of a household (159 *sq.*). The negative evidence afforded in the account of his establishment, and the bitter tone in which his friend is reminded of his domestic unhappiness (186–9), suggest the inference that, like Lucilius and Horace, Juvenal had no personal experience of either the cares or the softening influence of family life. A comparison of this poem with the invitation of Horace to Torquatus (*Ep.*, i. 5) brings out strongly the differences not in urbanity only but in kindly feeling between the two satirists. It reminds us also of how much less we know of the one poet than of the other, and of how shadowy a personage the Persius of the one is as contrasted with the Torquatus of the other.

An excellent critic of Latin literature, M. Gaston Boissier, has drawn from the indications afforded of the career and character of the persons to whom the satires are addressed most unfavourable conclusions as to the social circumstances and associations of Juvenal. If we believe that the Trebius, Postumus, Ponticus, Nævulus, Persicus, of the satires were real people, with whom Juvenal lived in intimacy, we should conclude that he was most unfortunate in his associates, and that his own relations to them were marked rather by outspoken frankness than civility. But these personages seem to be more "nominis umbræ" than real men; they serve the purpose of enabling the satirist to aim his blows at one particular object instead of declaiming at large. They have none of the individuality and traits of personal character discernible in the Damasippus or Trebatius of Horace's satires, or the Julius Florus, the Torquatus, the Celsus, the Fuscus, the Bullatius, &c., of the epistles. It is noticeable that, while Juvenal writes of the poets and men of letters, Statius, Saleius Bassus, Quintilian, &c., of a somewhat earlier time, as if they were still living, he has no reference to the career or reputation of his friend Martial, and that he is equally silent about the two illustrious writers who wrote their works during the years of his own literary activity,—the younger Pliny and Tacitus. It is equally noticeable that among the many cultivated and estimable men and women who are brought before us in the correspondence of the former of these writers the name of Juvenal does not appear.

We feel on more certain ground in endeavouring to determine the times at which the satires were given to the world. But these do not in all cases coincide with those at which they were written and to which they immediately refer. Thus the manners and personages of the age of Domitian often supply the material of satiric representation, and are spoken of as if they belonged to the actual life of the present,<sup>3</sup> while allusions even in the earliest show that, as a finished literary composition, it belongs to the age of Trajan. The most probable explanation of these discrepancies is that already hinted at, viz., that in their present form the satires are the work of the last thirty years of the poet's life, while the first nine at least, the most powerful and most characteristic among them, not only reproduce the impressions of his earlier manhood, but may have preserved with little change passages written and perhaps familiarly known in his own literary circles during this earlier time.

<sup>1</sup> See especially xiii. 3–16.

<sup>2</sup> Comp. i. 145, "It nova nec tristis per cunctas fabula cenas"; xi. 3 *sq.*—

"Omnis convictus, thermæ, stationes, omne theatrum  
De Rutulo."

<sup>3</sup> This is especially noticeable in the seventh satire, but it applies also to the mention of Crispinus, Latinus, the class of *delatores*, &c., in the first, to the notice of Vicieto in the third, of Rubellius Blandus in the eighth, of Gallicus in the thirteenth, &c.

This seems more probable than that he should have used such famous names as those of Statius and Quintilian to signify some poet or rhetorical professor of a later time; although probably like Horace he may have availed himself either of false names, or names belonging to a former time, for his satiric nomenclature. The combination of the impressions, and, perhaps of the actual compositions, of different periods also explains a certain want of unity and continuity found in some of them.

There is no reason to doubt that the sixteen satires which we possess were given to the world in the order in which we find them, and that they were divided, as they are referred to in the ancient grammarians, into five books. A minute examination of the various satires composing these books enables us to form at least a probable conjecture as to the intervals at which they appeared, and to conceive the changes of mood through which the poet passed during these intervals. Book I, embracing the first five satires, is written in the freshest vigour of the author's powers, and is animated with the strongest hatred of Domitian. The publication of this book belongs to the early years of Trajan. The mention of the exile of Marius (49) shows that it was not published before the year 100 A.D. In the second satire, the lines 29 *sq.*,

"Qualis erat nuper tragico pollutus adultu  
Concubitu,"

show that the memory of one of the foulest scandals of the reign of Domitian was still fresh in the minds of men. The third satire, imitated by Johnson in his *London*, presents such a picture as Rome may have offered to the satirist at any time in the 1st century of our era; but it was under the most emperors, Nero and Domitian, that the arts of flattery and foreign adventures were most successful, and that such scenes of violence as that described at 277 *sq.* were most likely to occur,<sup>1</sup> while the mention of Veiento (185) as still enjoying influence is a distinct reference to the court of Domitian. The fourth, which alone has any political significance, and reflects on the emperor as a frivolous trifler rather than as a monster of lust and cruelty, is the reproduction of a real or imaginary scene from the reign of Domitian, and is animated by the profoundest scorn and loathing both of the tyrant himself and of the worst instruments of his tyranny. The fifth is a social picture of the degradation to which poor guests were exposed at the banquets of the rich, but many of the epigrams of Martial and the more sober evidence of one of Pliny's letters show that the picture painted by Juvenal, though perhaps exaggerated in colouring, was drawn from a state of society prevalent during and immediately subsequent to the times of Domitian.<sup>2</sup> The second book contains the most elaborate of the satires, that which by many critics is regarded as the poet's masterpiece, the famous sixth satire, directed against the whole female sex, which shares with Domitian and his creatures the most cherished place in the poet's antipathies. It shows certainly no diminution of vigour either in its representation or its invective. If it is desirable that such a subject should be treated in the spirit in which Juvenal has treated it, it may be regarded as fortunate that it has been done once for all with such power, with such freedom from the restraints imposed either by modesty or humanity, and with, apparently, such intimate knowledge, that no writer of later ages has attempted to rival it. The time at which this satire was composed cannot be fixed with certainty, but some allusions (lines 502, 407-11, 205, 555<sup>3</sup>) render it highly probable that it was given to the world in the later years of Trajan, and before the accession of Hadrian. The date of the publication of Book III., containing the seventh, eighth, and ninth satires, seems to be fixed by its opening line "Et spes et ratio studiorum in Cesare tantum," to the first years after the accession of Hadrian. If the seventh satire stood alone, we might, from the notices of Statius, Quintilian, &c., regard it as probably belonging to the age of Domitian; nor is it unlikely that much of it was written then, and that the condition of poets and men of letters there described, with more of fellow-feeling than is apparent in most of his satires, is drawn from the life at Rome with which the poet was first familiar. But it is inconceivable that the complimentary language applied to "Caesar" in the opening lines could have been meant for Domitian; and the new hopes which are held out for the neglected race of poets would naturally be suggested by the change from the rule of a great soldier, whose thoughts were chiefly bent on foreign conquest, to that of an accomplished lover of art, like Hadrian. In the eighth satire another reference is made (line 120) to the misgovernment of Marius in Africa as a recent event (*nuper*), and at line 51 there may be an allusion to the Eastern wars that occupied the last years

of Trajan's reign. The ninth has no allusion to determine its date, but it is written with the same outspoken freedom as the second and the sixth, and belongs to the period when the poet's power was most vigorous, and his exposure of vice most uncompromising. In the fourth book, comprising the famous tenth, the eleventh, and the twelfth satires, the author appears more as a moralist than as a pure satirist. In the tenth, the theme of the "vanity of human wishes" is illustrated by great historic instances, rather than by pictures of the men and manners of the age; and, though the declamatory vigour and power of expression in it are occasionally as great as in the earlier satires, and although touches of his saturnine humour, and especially of his misogyny, appear in all the satires of this book, yet their general tone shows that the white heat of his indignation is abated; and the lines of the eleventh, already referred to (199 *sq.*),

"Spectent juvenes quos clamor et audax  
Sponsio, quos cultus decet assidue pudice;  
Nostra libat vernum contracta culicula solem,"

leave no doubt that he was well advanced in years when they were written.

Two important dates are found in the last book, comprising satires xiii.-xvi. At xiii. 16 Juvenal speaks of his friend Calvinus "as now past sixty years of age, having been born in the consulship of Fonteius."<sup>4</sup> There was a C. Fonteius Capito consul in 59 A.D., and L. Fonteius Capito in 67. If it is accepted that the different books of the satires appeared at different intervals, that the third book was given to the world after Hadrian's return to Rome (118 A.D.), and that some time must have elapsed between the appearance of the third and fourth books, and again between that of the fourth and fifth, the date referred to must be the latter of these, and thus the fifth and last book could not have been published till after the year 127 A.D. Again at xv. 27 an event is said to have happened in Egypt "nuper consule Junco," for which some editions read "Junio."<sup>5</sup> There was a Junius consul in 119 A.D. Even if he were the person referred to, the word *nuper* (as at ii. 29, viii. 120) might well indicate a date of some ten or twelve years earlier than that of the composition of the satire. Recent investigations, however, make out that there was a L. Emilius Junceus consul *suffectus* in 127 A.D. (see Mayor's note on the passage). The fifth book must therefore have been published some time after this date. More than the fourth, this book bears the marks of age, both in the milder tone of the sentiments expressed, and in the feebler power of composition exhibited. The last satire is left incomplete, and the authenticity both of it and of the fifteenth has been questioned, though on insufficient grounds.

The general conclusion arrived at is that the satires were published at different intervals, and for the most part, composed, under Trajan and Hadrian, between the years 100 and 130 A.D., or a year or two later, but that the most powerful in feeling and vivid in conception among them deal with the experience and impressions of the reign of Domitian, occasionally recall the memories or traditions of the times of Nero and Claudius, and reproduce at least one startling page from the annals of Tiberius.<sup>6</sup> The same overmastering feeling which constrained Tacitus (*Agric.*, 2, 3), when the time of long endurance and silence was over, to recall the "memory of the former oppression," acted upon Juvenal. There is no evidence that these two great writers, who lived and wrote at the same time, who were animated by the same hatred of the tyrant under whom the best years of their manhood were spent, and who both felt most deeply the degradation of their times, were even known to one another. They belonged to different social circles, Tacitus to that of the highest official and senatorial class, Juvenal apparently to the middle class and to that of the struggling men of letters; and this difference in position had much influence in determining the different bent of their genius, and in forming one to be a great national historian, the other to be a great social satirist. If the view of the satirist is owing to this circumstance more limited in some directions, and his taste and temper less conformable to

<sup>4</sup> Friedländer supposes that, as Juvenal has hitherto addressed Calvinus in the second person, the "hic" refers to himself, and that in the words "Fonteio Consule natus" we have the date of the poet's own birth. But elsewhere we find the poet changing suddenly from the second to the third person when there can be no doubt that they both refer to the same individual. *e.g.* (v. 18)—

"Voturus annalis quid ultra  
Quæris? habet Trebius, propter quod." &c.

<sup>5</sup> x. 56-107.

<sup>1</sup> Cf. Tacitus, *Annals*, xiii. 25.

<sup>2</sup> Pliny's remarks on the vulgarity as well as the ostentation of his host imply that he regarded such behaviour as exceptional, at least in the circle in which he himself lived (*Ep.*, ii. 6).

<sup>3</sup> See Mr Lewis's edition, p. 317.



the best ancient standards of propriety, he is also saved by it from prejudices to which the traditions of his class exposed the historian. But both writers are thoroughly national in sentiment, thoroughly masculine in tone. No ancient authors express so strong a hatred of evil. None of the other contemporary writers share this feeling. Pliny has the natural repugnance of a gentleman and honourable man to coarseness and baseness; but he liked to live with people of tastes and manners congenial to his own, and to see as little as possible of the corruption which existed under the surface of society. Martial, as a foreigner living in Rome, endowed with a lively observation and a keen capacity for pleasure, enjoyed whatever was enjoyable in the life around him, found in its excesses and perversions materials for his wit, and, after flattering the worst of the emperors assiduously through all his career, was ready with impartial sycophancy to flatter one of the best. The peculiar greatness and value of both Juvenal and Tacitus is that they did not shut their eyes to the evil through which they had lived, but deeply resented it,—the one with a vehement and burning passion, like the "sæva indignatio" of Swift, the other with perhaps even deeper but more restrained emotions of mingled scorn and sorrow, like the scorn and sorrow of Milton when "fallen on evil days and evil tongues." The wickedness of the age brought out more strongly than at any previous time the opposition between good and evil. The idea of conscience, as the connecting bond between religion and morality, appears in greater prominence in Tacitus and Juvenal than in any other ancient writers.

There is a criticism of an eminent living writer<sup>1</sup> to the effect that the secret of Juvenal's concentrated power consisted in this, that he knew what he hated, and that what he did hate was despotism and democracy. But it would be hardly true to say that the animating motive of his satire was political. It is true that he finds the most typical examples of lust, cruelty, levity, and weakness in the emperors and their wives,—in Domitian, Otho, Nero, Claudius, and Messalina. It is true also that he shares in the traditional idolatry of Brutus, that he strikes at Augustus in his mention of the "three disciples of Sulla," and that he has no word of recognition for what even Tacitus acknowledges as the beneficent rule of Trajan. So too his scorn for the Roman populace of his time, who cared only for their dole of bread and the public games, is unqualified. But it is only in connexion with its indirect effects that he seems to think of despotism; and he has no thought of democracy at all. It is not for the loss of liberty and of the senatorian rule that he chafes, but for the loss of the old national manliness and self-respect, alike in the descendants of "the Latian boors"<sup>2</sup> and in the representatives of the *Ænelli* and the *Pabii*. There is no more grandly imaginative passage in all his satires than that in which he evokes the ghosts of those who died at *Cremera* and *Cannæ* (ii. 153 *sq.*) to shame the degenerate debauchees of his own time. While we feel that we know little or nothing of his career, while we may imagine that personal disappointment may have supplied some of the gall in which his pen is dipped, and may doubt whether his own life and associations would have justified him in acting as a severer censor on what most Romans regarded as permitted indulgences than *Lucilius* and *Horace*, we cannot doubt that both his intellect and character were of a most masculine strength, and that his hatred for all that corrupted the old national character and enfeebled the national intellect was sincere and consistent. This feeling explains his detestation of foreign manners and superstitions, his loathing not only of inhuman crimes and

cruelties but of such derelictions from self-respect as the appearance of a Roman nobleman on the arena or even the more harmless indulgence of a taste for driving, his scorn of luxury and of art as ministering to luxury, his mockery of the poetry and of the stale and dilettante culture of his time, and perhaps, too, his indifference to the schools of philosophy and his readiness to identify all the professors of stoicism with the reserved and close-cropped puritans,—

'Rarus sermo illis et multa libido tacendi  
Adque supercilio brevior coma,"<sup>3</sup>—

who concealed the worst vices under an outward appearance of austerity. The great fault of his character, as it appears in his writings, is that he too exclusively indulged his mood. It is much more difficult to find what he loved and admired than what he hated. But it is characteristic of his strong nature that, where he does betray any sign of human sympathy or tenderness, it is for those who by their weakness and position are dependent on others for their protection,—as for "the peasant boy with the little dog, his playfellow,"<sup>4</sup> or, for "the home-sick lad from the Sabine highlands, who sighs for his mother whom he has not seen for a long time, and for the little hut and the familiar kids."<sup>5</sup>

If Juvenal is to be ranked as a great moralist, it is not for his greatness and consistency as a thinker on moral questions. In the rhetorical exaggeration of the famous tenth satire, for instance, the highest energies of patriotism,—the gallant and desperate defence of great causes, by sword or speech,—are quoted as mere examples of disappointed ambition; and, in the indiscriminate condemnation of the arts by which men sought to gain a livelihood, he leaves no room for the legitimate pursuits of industry. His services to morals do not consist in any positive contributions to the notions of active duty, but in the strength with which he has realized and expressed the restraining influence of the old Roman and Italian ideal of character, and also of that religious conscience which was becoming a new power in the world. Though he disclaims any debt to philosophy (xiii. 121), yet he really owes more to the "Stoica dogmata," then prevalent, than he is aware of. But his highest and rarest literary quality is his power of painting characters, scenes, incidents, and actions, whether from past history or from contemporary life. In this power, which is also the great power of Tacitus, he has few equals and perhaps no superior among ancient writers. The difference between Tacitus and Juvenal in power of representation is that the prose historian is more of an imaginative poet, the satirist more of a realist, and a grotesque humorist. He can paint great historical pictures in all their detail—as in the famous representation of the fall of *Sejanus*,—or call them up with all their imaginative associations in a line or two, as for instance in these—

"Atque ideo postquam ad Cimbrostragemque volabant  
Qui nunquam attigerant majora cadavera corvi;"

he can describe a character elaborately or hit it off with a single stroke; and in either case he fixes the impression which he desires to produce firmly in the mind. The picture drawn may be a caricature, or a misrepresentation of the fact,—as that of the father of *Demosthenes*, "blear-eyed with the soot of the glowing mass," &c.,—but it is, with rare exceptions, realistically conceived, and, as is well said by Mr Lewis, it is brought before us with the vivid touches of a *Defoe* or a *Swift*. Still more happily the same editor has illustrated Juvenal's power as a realistic painter of scenes from contemporary life,—and of scenes which generally combine grotesque and humorous features with serious

<sup>3</sup> ii. 14 *sq.*

<sup>4</sup> "Melius hic rusticus infans  
Cum matre et casulis et conlosore catello," &c.,—ix. 60:

<sup>5</sup> xi. 152, 153.

<sup>1</sup> Mr Swinburne.

<sup>2</sup> Unde nefas tantum Latius pasteribus? (ii. 127).

meaning,—by comparing him with the great pictorial satirist of the last century, Hogarth.<sup>1</sup> Yet even in this, his most characteristic talent, his proneness to exaggeration, the attraction which coarse and repulsive images have for his mind, and the tendency to sacrifice general effect to minuteness of detail not unfrequently mar his best effects.

† The difficulty is often felt of distinguishing between a powerful rhetorician and a genuine poet,—and there is no writer about whom it is more difficult to determine to which of the two classes he belongs than about Juvenal. He himself knew and has well described (vii. 53 *sq.*) the conditions under which a great poet could flourish; and he felt that his own age was incapable of producing one. He has little sense of beauty either in human life or nature. Whenever such sense is evoked it is only as a momentary relief to his prevailing sense of the hideousness of contemporary life, or in protest to what he regarded as the enervating influences of art. Even his references to the great poets of the past indicate rather a *blasé* sense of indifference and weariness than a fresh enjoyment of them. Yet his power of touching the springs of tragic awe and horror is a genuine poetical gift, of the same kind as that which is displayed by some of the early English dramatists. But he is, on the whole, more essentially a great rhetorician than a great poet. His training, the practical bent of his understanding, his strong but morose character, the circumstances of his time, and the materials available for his art, all fitted him to rebuke his own age and all after times in the tones of a powerful preacher, rather than to charm them with the art of an accomplished poet. The composition of his various satires shows no negligence, but rather the excess of elaboration; but it produces the impression of mechanical contrivance rather than of organic growth. His movement is sustained and powerful, but there is no rise and fall in it. He seems to forget how much more telling indignation is when it is severely controlled, but allowed occasionally to break forth in blasting scorn and wrath, as it is in Tacitus, than when it shows itself as the habitual mood of the writer. The verse is most carefully constructed, and is also most effective, but it is so with the rhetorical effectiveness of Lucan, not with the musical charm of Virgil. It was calculated to bring down the applause of an excited audience, not to perpetuate its melody through all succeeding times. So, too, the diction is full, even to excess, of meaning, point, and emphasis. Few writers have added so much to the currency of quotation. But his style altogether wants the charm of ease and simplicity. It wearies by the constant strain after effect, its mock-heroics, and allusive periphrasis. It excites distrust by its want of moderation. It makes us long to return to nature and to the apparently more careless but really truer art and the lighter touch of the satirist of the Augustan age—

“Parcentis viribus atque  
Extenuantis eas consulto.”

On the whole no one of the ten or twelve really great writers whom ancient Rome produced leaves on the mind so mixed an impression, both as a writer and as a man, as Juvenal. He has little, if anything at all, of the high imaginative mood—the mood of reverence and noble admiration—which made Ennius, Lucretius, and Virgil the truest poetical representatives of the genius of Rome. He has nothing of the wide humanity of Cicero, of the urbanity of Horace, of the ease and grace of Catullus. Yet he represents another mood of ancient Rome, the mood natural to her before she was humanized by the lessons of Greek art and thought. If we could imagine the elder Cato living under Domitian, cut off from all share in public

life, and finding no sphere for his combative and censorious energy except that of literature, we should perhaps understand the motives of Juvenal's satire and the place which is his due as a representative of the genius of his country. As a man he shows many of the strong qualities of the old Roman plebeian,—the aggressive boldness, the intolerance of superiority and privilege, which animated the tribunes in their opposition to the senatorian rule. Even where we least like him we find nothing small or mean to alienate our respect from him. Though he loses no opportunity of being coarse, he is not licentious; though he is often truculent, he cannot be called malignant. It is, indeed, impossible to say what motives of personal chagrin, of love of detraction, of the mere literary passion for effective writing, may have contributed to the indignation which inspired his verse. But the prevailing impression we carry away after reading him is that, in all his early satires, he was animated by a sincere and manly detestation of the tyranny and cruelty, the debauchery and luxury, the levity and effeminacy, the crimes and frauds, which we know from other sources were rife in Rome in the century in which Christianity made its first converts there, and that a more serene wisdom and a happier frame of mind were attained by him when old age had somewhat allayed the fierce rage which vexed his manhood.

It would be impossible to enumerate here the various editions and works forming the literature connected with Juvenal which have sprung up between the appearance of the *editio princeps* in 1470 and the present day. They occupy more than five pages of E. Hübner's *Grundriss zu Vorlesungen über die Römische Literaturgeschichte*. Among the best critical editions of the text is that of O. Jahn, and among those which may be most recommended to students are the editions of Heinrich, Maclean, Mayor, and Lewis. The last is accompanied by a literal prose translation. The verse translations of Dryden and Gifford, and Johnson's imitations of the third and tenth satires in the *London* and *Vanity of Human Wishes*, will convey to readers ignorant of Latin a good impression of the power of the original. There is no better criticism of Juvenal as a writer than that contributed by the late Professor Ramsay to Dr Smith's *Dictionary of Ancient Biography and Mythology*. (N.Y.S.)

JUXON, WILLIAM (1582–1663), archbishop of Canterbury, was born at Chichester in 1582. Through the interest of his father with the Company of Merchant Taylors he received an appointment to their school, after which he entered St John's College, Oxford, where he was elected a fellow in 1598. In 1603 he became a student of Gray's Inn, but afterwards he took holy orders, and in 1609 had become vicar of St Giles, Oxford, an appointment which he resigned for the rectorship of Somerton, Oxfordshire, in 1615. On the recommendation of Laud he succeeded him in November 1621 as president of St John's College; and in 1626 he became vice-chancellor of the university. Having by the continued favour of Laud been promoted successively dean of Worcester, prebendary of Chichester, bishop of Hereford, and bishop of London, he attained finally a dignity outside the ordinary sphere of ecclesiastical aspiration, by being appointed in 1625 to the office of lord high treasurer. The appointment, unusual in itself, was preposterously beyond Juxon's claims, but his strict probity, his prudence, and his quiet and conciliating behaviour won him the regard and goodwill even of those most opposed to him in politics. He resigned this office in 1641. Charles I. chose Juxon to administer to him the last consolations of religion. During the period of puritan ascendancy the bishop retired to his estate of Little Compton, Gloucestershire, where he kept a pack of hounds much famed in the district. At the Restoration he was, on September 20, 1660, promoted to the see of Canterbury. He died at Lambeth palace, June 4, 1663.

Juxon was the author of the *Subjects' Sorrow, or Lamentations upon the Death of Britain's Josiah, King Charles, a Sermon*, 1660, and *Some Considerations upon the Act of Uniformity*, 1662. See *Memoirs of Archbishop Juxon and his Times*, Oxford, 1869.

<sup>1</sup> Lewis, *Introduction*, p. 215.



## K

**K.** THE letter K has remained with singularly little change in form even from the Phœnician alphabet down to the present time. It represents the guttural momentary sound produced by raising the back of the tongue to the back of the palate; it is surd, corresponding to G, which is sonant; and it has this value and no other in all modern alphabets in which it is found. In many alphabets, however, it is supplanted wholly or to a great extent by the symbol C. The reason of this has been already explained under the letters C and G. The substitution of C for K took place in Italy,—the original character surviving only in a few well-understood abbreviations; and in consequence of this those alphabets which have been derived from Italy naturally have the C; while those derived directly from the Greek, *e.g.*, the Gothic, which came through Ulfilas, and the different alphabets which trace back to Cyril (see ALPHABET), have only the K. In German we find K, with the exception of some words borrowed from other languages, *e.g.*, Cabinet, Cardinal, Caprice, &c.; but even foreign words when thoroughly naturalized take the German spelling, *e.g.*, Karte, Kahmer, Onkel, &c. In French, on the other hand, K is found only in a few foreign words, and even these are merely names of men or countries. In England the large admixture of French words in the Teutonic language has produced some irregularity in spelling; but the K is not found (as might have been expected) in the Teutonic words, because the Roman alphabet was introduced by missionaries into England, and therefore the oldest English (or Anglo-Saxon) writings regularly have C and not K. The letter was introduced probably first in words borrowed from the German (thus in Alfred's version of Gregory's *Pastoral* we find "kycglum" (p. 297, l. 1, ed. Sweet), the dative of the German "Kugel"), or through German influence, as for example in the *Blicking Homilies* of the 10th century, we find "kyning" (p. 163, l. 23, ed. Morris) beside the much more common "cyning." It would have been very convenient both in English and in other languages of modern Europe if K could have been kept as the sole symbol for the pure sound and C as the symbol for a common corruption of it, now to be described.

This corruption is due to palatization; the middle instead of the back of the tongue is raised against the palate, and the result is the difference of sound between, *e.g.*, "kirk" and "church." This corruption was common in Sanskrit, and a special symbol was assigned to the sound. It is found in late Latin, especially before an *i*; and so it passed into Italian, where *c* is regularly sounded as our *ch* before *e* and *i*; in the words where the sound remained unchanged the symbol *ch* is employed to represent it, *e.g.*, in "che." In French the change was much greater; here *c* passed into the *sh*-sound (denoted by *ch*) before *a*, *e.g.*, in "chambre" from "camera," "chaud" from "calidus"; observe that the symbol *ch* has just the opposite value to the Italian one; while before *e* and *i* the sound underwent a still greater change; it sank into the simple sibilant *s*, *e.g.*, "civitas"—pronounced in Latin "kivitas"—became "cit<sup>e</sup>," whence our own sound; "certus" became "certein." In English, palatization has been very extensive; thus Old English "c<sup>e</sup>se" (sounded like German "käse") became "cheese," "cild" became "child," &c.; here dialectic variation may often be seen, *e.g.*, in Alnwick but Norwick, Caister but Chester.

Another still greater change of K has been called "labialization": this is the passage of the *k*-sound through an

intermediate *kw* into *p*. This was common in Greek, where, *e.g.*, we find ἔπομαι, τρέπω, of which the root form as shown by other languages was SAK. TARK; in Latin we have the transitional forms "sequ-or" "torqu-eo"; in the Italian dialects the change was complete. *e.g.*, Oscan "pid" corresponded to Latin "quid," and Umbrian "pumpe" to "quomque." This change arose from a slight rounding of the lips while the speech-organs were in the position for *k*-sound: this produced a more or less distinct *kw* according to the amount of the rounding, passing finally into *p*, when the rounding amounted to absolute closing of the lips. For the intermediate sound the Latin employed the symbol Q, which is a slightly turned form of the original *q* (Koppa) taken by the Greeks from the Phœnician, but not required by them, and therefore suffered to fall out except in numeration; the Latin took it on, and, if it had consistently employed it alone to denote the slightly labialized *k*, the result would have been good; but it regularly added *u* to it (QU), so that the Q might as well have been written K. The superfluous letter passed on to the French and English languages.

There is reason for believing that this labializing tendency is very old,—as old indeed as the Indo-European language itself. It is probable that that language had both the *k* pure and another with a slight *w* sound following it. This appears from the fact (first thoroughly ascertained by Fick) that in one set of cognate words which had an original *k*, we find *ch* in Sanskrit, *κ* or *π* in Greek, *c* or *qu* in Latin, *k* in Lithuanian and Slavonic; in another set we find *ç* in Sanskrit, *sz* (which is our *sh*-sound) in Lithuanian, *s* in Slavonic, but only *k* in Greek and *c* in Latin; that is, in one set we see the phenomenon of labialism, in the other assimilation but no touch of labialism; from which we infer that the assimilated *k* in the derived languages traces back to *k* pure, the labialized *k* to a sound which in the original language was at least slightly modified from *k*. An instance of the assimilation may be seen in the correspondence of Sanskrit "çatam," Lithuanian "szimtas," to Latin "centum," Greek ἑκατόν; neither in Greece nor in Italy is there any labialized form of this word.

KAABA, KA'BA, or KAABEH, the sacred shrine of Mahometanism, containing the "black stone," in the middle of the great mosque at Mecca. See ARABIA, vol. ii. p. 262, and MECCA.

KAADEN, chief town of a department in the circle of Eger, Bohemia, is situated on the Eger, about 60 miles north-west of Prague. The town lies about 2 miles E. of the station of Kaaden-Brunnersdorf, on the railway between Eger and Carlsbad, and consists of an old town, surrounded by a wall, and two suburbs. It contains two convents, a commercial school, and a school of agriculture. The chief buildings are the Late Gothic Franciscan church, and the town-house with a noteworthy tower. The manufactures include gloves and beet-root sugar; there is some trade in wood and grain; and mining for anthracite and a mineral colouring material, yielding *Kaaden green*, is carried on in the neighbourhood. Kaaden was founded about 820; in 1277 it became a free city; and in 1534 it saw the conclusion of a peace between Ferdinand I, king of the Romans, and Ulrich I, duke of Württemberg. The population in 1869 was 5057.

KABBALAH is now used as the technical name for the system of theosophy which began to be developed among the Jews in the 10th century, and which has also played an important part in the Christian church since the Middle

Ages. The term primarily denotes "reception" and then "doctrines received by tradition." In the older Jewish literature the name is applied to the whole body of received religious doctrine with the exception of the Pentateuch, thus including the Prophets and Hagiographa as well as the oral traditions ultimately embodied in the Mishnah. It is only since the 11th or 12th century that Kabbalah has become the exclusive appellation for the renowned system of theosophy which claims to have been transmitted uninterruptedly by the mouths of the patriarchs and prophets ever since the creation of the first man.

The cardinal doctrines of the Kabbalah embrace the nature of the Deity, the Divine emanations or Sephiroth, the cosmogony, the creation of angels and man, their destiny, and the import of the revealed law. According to this esoteric doctrine, God, who is boundless and above everything, even above being and thinking, is called *En Soph* (ἄπειρος); He is the space of the universe containing τὸ πᾶν, but the universe is not his space. In this boundlessness He could not be comprehended by the intellect or described in words, and as such the *En Soph* was in a certain sense *Ayin*, non-existent (*Zohar*, iii. 283). To make his existence known and comprehensible, the *En Soph* had to become active and creative. As creation involves intention, desire, thought, and work, and as these are properties which imply limit and belong to a finite being, and moreover as the imperfect and circumscribed nature of this creation precludes the idea of its being the direct work of the infinite and perfect, the *En Soph* had to become creative, through the medium of ten Sephiroth or intelligences, which emanated from him like rays proceeding from a luminary.

Now the wish to become manifest and known, and hence the idea of creation, is co-eternal with the inscrutable Deity, and the first manifestation of this primordial will is called the first *Sephirah* or emanation. This first *Sephirah*, this spiritual substance which existed in the *En Soph* from all eternity, contained nine other intelligences or *Sephiroth*. These again emanated one from the other, the second from the first, the third from the second, and so on up to ten.

The ten *Sephiroth*, which form among themselves and with the *En Soph* a strict unity, and which simply represent different aspects of one and the same being, are respectively denominated (1) the Crown, (2) Wisdom, (3) Intelligence, (4) Love, (5) Justice, (6) Beauty, (7) Firmness, (8) Splendour, (9) Foundation, and (10) Kingdom. Their evolution was as follows: "When the Holy Aged, the concealed of all concealed, assumed a

form, he produced everything in the form of male and female, as things could not continue in any other form. Hence Wisdom, the second *Sephirah*, and the beginning of development, when it proceeded from the Holy Aged (another name of the first *Sephirah*) emanated in male and female, for Wisdom expanded, and Intelligence, the third *Sephirah*, proceeded from it, and thus were obtained male and female, viz., Wisdom the father and Intelligence the mother, from whose union the other pairs of *Sephiroth* successively emanated" (*Zohar*, iii. 290). These two opposite potencies, viz., the masculine Wisdom or *Sephirah* No. 2 and the feminine Intelligence or *Sephirah* No. 3 are joined together by the first potency, the Crown or *Sephirah* No. 1; they yield the first triad of the *Sephiric* decade, and constitute the divine head of the archetypal man, as will be seen in the accompanying figure.

From the junction of *Sephiroth* No. 2 and 3 emanated the masculine potency Love or Mercy (4) and the feminine potency Justice (5), and from the junction of the latter two emanated again the uniting potency Beauty (6). Beauty, the sixth *Sephirah*, constitutes the chest in the archetypal man, and unites Love (4) and Justice (5), which constitute the divine arms, thus yielding the second triad of the *Sephiric* decade. From this second conjunction emanated again the masculine potency Firmness (7) and the feminine potency Splendour (8), which constitute the divine legs of the archetypal man; and these sent forth Foundation (9), which is the genital organ and medium of union between them, thus yielding the third triad in the *Sephiric* decade. Kingdom (10), which emanated from the ninth *Sephirah*, encircles all the other nine, inasmuch as it is the *Shechina*, or divine halo, which encompasses the whole by its all-glorious presence.

In their totality and unity the ten *Sephiroth* are not only denominated the World of *Sephiroth*, or the World of Emanations, but, owing to the above representation, are called the primordial or archetypal man (= πρωτόγονος) and the heavenly man. It is this form which, as we are assured, the prophet Ezekiel saw in the mysterious chariot (Ezek. i. 1-28), and of which the earthly man is a faint copy.

As the three triads respectively represent intellectual, moral, and physical qualities, the first is called the Intellectual, the second the Moral or Sensuous, and the third the Material World. In the figure of the archetypal man it will be seen that the three *Sephiroth* on the right are masculine, and represent the principle of rigour, that the three on the left are feminine and represent the principle of mercy, and that the four central or uniting *Sephiroth* represent the principle of mildness. Hence the right is called "the Pillar of Judgment," the left "the Pillar of Mercy," and the centre "the Middle Pillar." The middle *Sephiroth* are synecdochically used to represent the worlds or triads of which they are the uniting potencies. Hence the Crown, the first *Sephirah*, which unites Wisdom and Intelligence to constitute the first triad, is by itself denominated the Intellectual World. So Beauty is by itself described as the Sensuous World, and in this capacity is called the Sacred King or simply the King, whilst Kingdom, the tenth *Sephirah*, which unites all the nine *Sephiroth*, is used to denote the Material World, and as such is denominated the Queen or the Matron. Thus a trinity of units, viz., the Crown, Beauty, and Kingdom, is obtained within the trinity of triads. But further, each *Sephirah* is as it were a trinity in itself. It (1) has its own absolute character, (2) receives from above, and (3) communicates to what is below. "Just as the Sacred Aged is represented by the number three, so are all the other lights (*Sephiroth*) of a threefold nature" (*Zohar*, iii. 288). In this all-important doctrine of the *Sephiroth*, the Kabbalah-

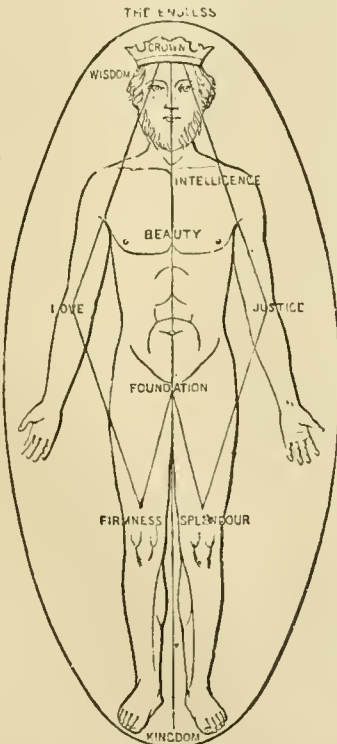

The Archetypal Man.



insists upon the fact that these potencies are not creations of the En Soph, which would be a diminution of strength ; that they form among themselves and with the En Soph a strict unity, and simply represent different aspects of the same being, just as the different rays which proceed from the light, and which appear different things to the eye, are only different manifestations of one and the same light ; that for this reason they all alike partake of the perfections of the En Soph ; and that as emanations from the Infinite, the Sephiroth are infinite and perfect like the En Soph, and yet constitute the first finite things. They are infinite and perfect when the En Soph imparts his fullness to them, and finite and imperfect when that fullness is withdrawn from them.

The conjunction of the Sephiroth, or, according to the language of the Kabbalah, the union of the crowned King and Queen, produced the universe in their own image. Worlds came into existence before the En Soph manifested himself in the human form of emanations, but they could not continue, and necessarily perished because the conditions of development which obtained with the sexual opposites of the Sephiroth did not exist. These worlds which perished are compared to sparks which fly out from a red-hot iron beaten by a hammer, and which are extinguished according to the distance they are removed from the burning mass. Creation is not *ex nihilo* ; it is simply a further expansion or evolution of the Sephiroth. The world reveals and makes visible the Boundless and the concealed of the concealed. And, though it exhibits the Deity in less splendour than its Spheric parents exhibit the En Soph, because it is farther removed from the primordial source of light than the Sephiroth, still, as it is God manifested, all the multifarious forms in the world point out the unity which they represent. Hence nothing in the whole universe can be annihilated. Everything, spirit as well as body, must return to the source whence it emanated (*Zohar*, ii. 218). The universe consists of four different worlds, each of which forms a separate Spheric system of a decade of emanations. They were evolved in the following order. (1) The World of Emanations, also called the Image and the Heavenly or Archetypal Man, is, as we have seen, a direct emanation from the En Soph. Hence it is most intimately allied to the Deity, and is perfect and immutable. From the conjunction of the King and Queen (*i.e.*, these ten Sephiroth) is produced (2) the World of Creation, or the Briatic world, also called "the Throne." Its ten Sephiroth, being farther removed from the En Soph, are of a more limited and circumscribed potency, though the substances they comprise are of the purest nature and without any admixture of matter. The angel Metatron inhabits this world. He alone constitutes the world of pure spirit, and is the garment of Shaddai, *i.e.*, the visible manifestation of the Deity. His name is numerically equivalent to that of the Lord (*Zohar*, iii. 231). He governs the visible world, preserves the harmony and guides the revolutions of all the spheres, and is the captain of all the myriads of angelic beings. This Briatic world again gave rise to (3) the World of Formation, or Yetziratic World. Its ten Sephiroth, being still farther removed from the Primordial Source, are of a less refined substance. Still they are yet without matter. It is the abode of the angels, who are wrapped in luminous garments, and who assume a sensuous form when they appear to men. The myriads of the angelic hosts who people this world are divided into ten ranks, answering to the ten Sephiroth, and each one of these numerous angels is set over a different part of the universe, and derives his name from the heavenly body or element which he guards (*Zohar*, i. 42). From this world finally emanated (4) the World of Action, also called the World of Matter. Its ten Sephiroth are made

up of the grosser elements of the former three worlds ; they consist of material substance limited by space and perceptible to the senses in a multiplicity of forms. This world is subject to constant changes and corruption, and is the dwelling of the evil spirits. These, the grossest and most deficient of all forms, are also divided into ten degrees, each lower than the other. The first two are nothing more than the absence of all visible form and organization ; the third degree is the abode of darkness ; whilst the remaining seven are "the seven infernal halls," occupied by the demons, who are the incarnation of all human vices. These seven hells are subdivided into innumerable compartments corresponding to every species of sin, where the demons torture the poor deluded human beings who have suffered themselves to be led astray whilst on earth. The prince of this region of darkness is Samael, the evil spirit, the serpent who seduced Eve. His wife is the Harlot or the Woman of Whoredom. The two are treated as one person, and are called "the Beast" (*Zohar*, ii. 255-259, with i. 35).

The whole universe, however, was incomplete, and did not receive its finishing stroke till man was formed, who is the acme of the creation and the microcosm. "The heavenly Adam (*i.e.*, the ten Sephiroth) who emanated from the highest primordial obscurity (*i.e.*, the En Soph) created the earthly Adam" (*Zohar*, ii. 70). "Man is both the import and the highest degree of creation, for which reason he was formed on the sixth day. As soon as man was created everything was complete, including the upper and nether worlds, for everything is comprised in man. He unites in himself all forms" (*Zohar*, iii. 48). Each member of his body corresponds to a part of the visible universe. "Just as we see in the firmament above, covering all things, different signs which are formed of the stars and the planets, and which contain secret things and profound mysteries studied by those who are wise and expert in these things ; so there are in the skin, which is the cover of the body of the son of man, and which is like the sky that covers all things above, signs and features which are the stars and planets of the skin, indicating secret things and profound mysteries whereby the wise are attracted who understand the reading of the mysteries in the human face" (*Zohar*, ii. 76). The human form is shaped after the four letters which constitute the Tetragrammaton. The head is in the shape of א, the arms and the shoulders are like כ, the breast like י, and the two legs with the back again resemble ה (*Zohar*, ii. 72). The souls of the whole human race pre-exist in the World of Emanations, and are all destined to inhabit human bodies. Like the Sephiroth from which it emanates, every soul has ten potencies, consisting of a trinity of triads. (1) The Spirit (רוח), which is the highest degree of being, corresponds to and is operated upon by the Crown, which is the highest triad in the Sephiroth, and is called the Intellectual World ; (2) the Soul (נפש), which is the seat of the moral qualities, corresponds to and is operated upon by Beauty, which is the second triad in the Sephiroth, and is called the Moral World ; and (3) the Cruder Soul (בשר), which is immediately connected with the body, and is the cause of its lower instincts and the animal life, corresponds to and is operated upon by Foundation, the third triad in the Sephiroth, called the Material World. Each soul, prior to its entering into this world, consists of male and female united into one being. When it descends on this earth the two parts are separated and animate two different bodies. "At the time of marriage the Holy One, blessed be he, who knows all souls and spirits, unites them again as they were before ; and they again constitute one body and one soul, forming as it were the right and the left of the individual . . . This union, however, is influenced by the

deeds of the man and by the ways in which he walks. If the man is pure and his conduct is pleasing in the sight of God, he is united with that female part of the soul which was his component part prior to his birth" (*Zohar*, i. 91). The soul's destiny upon earth is to develop those perfections the germs of which are eternally implanted in it, and it ultimately must return to the infinite source from which it emanated. Hence, if, after assuming a body and sojourning upon earth, it becomes polluted by sin and fails to acquire the experience for which it descends from heaven, it must three times reembody a body, till it is able to ascend in a purified state through repeated trials. If, after its third residence in a human body, it is still too weak to withstand the contamination of sin, it is united with another soul, in order that by their combined efforts it may resist the pollution which by itself it was unable to conquer. When the whole pleroma of pre-existent souls in the world of the Sephiroth shall have descended and occupied human bodies and have passed their period of probation and have returned purified to the bosom of the infinite Source, then the soul of Messiah will descend from the region of souls, then the great Jubilee will commence. There shall be no more sin, no more temptation, no more suffering. Universal restoration will take place. Satan himself, "the venomous Beast," will be restored to his angelic nature. Life will be an everlasting feast, a Sabbath without end. All souls will be united with the Highest Soul, and will supplement each other in the Holy of Holies of the Seven Halls (*Zohar*, i. 45, 168; ii. 97).

According to the Kabbalah all these esoteric doctrines are contained in the Hebrew Scriptures. The uninitiated cannot perceive them; but they are plainly revealed to the spiritually minded, who discern the profound import of this theosophy beneath the surface of the letters and words of Holy Writ. "If the law simply consists of ordinary expressions and narratives, such as the words of Esau, Hagar, Laban, the ass of Balaam, or Balaam himself, why should it be called the law of truth, the perfect law, the true witness of God? Each word contains a sublime source, each narrative points, not only to the single instance in question, but also to generals" (*Zohar*, iii. 149, cf. 152).

To obtain these heavenly mysteries, which alone make the Torah superior to profane codes, definite hermeneutical rules are employed, of which the following are the most important. (1) The words of several verses in the Hebrew Scriptures which are regarded as containing a veiled sense are placed over each other, and the letters are formed into new words by reading them vertically. (2) The words of the text are ranged in squares in such a manner as to be read either vertically or horizontally. (3) The words are joined together and dividible. (4) The initials and final letters of several words are formed into separate words. (5) Every letter of a word is reduced to its numerical value, and the word is explained by another of the same quantity. (6) Every letter of a word is taken to be the initial or abbreviation of a word. (7) The twenty-two letters of the alphabet are divided into two halves; one half is placed above the other; and the two letters which thus become associated are interchanged. By this permutation, *Alph*, the first letter of the alphabet, becomes *Lamed*, the twelfth letter; *Beth* becomes *Mem*, and so on. This cipher alphabet is called *Alphabet*, from the first interchangeable pairs. (8) The commutation of the twenty-two letters is effected by the last letter of the alphabet taking the place of the first, the last but one the place of the second, and so forth. This cipher is called *Alphabet*. These hermeneutical canons are much older than the Kabbalah. They obtained in the synagogue from time immemorial, and were used by the Christian fathers in the interpretation of Scripture. Thus Canon V., according to which a word is reduced to its numerical value and interpreted by another word of the same value, is recognized in the New Testament (*comp.* Rev. xiii. 18). Canon VI. is adopted by Irenæus, who tells us that, according to the learned among the Hebrews, the name Jesus contains two letters and a half, and signifies that Lord who contains heaven and earth [יהוה ששם וארץ] (*Against Heresies*, ii. xxiv., vol. i. p. 205, ed. Clark). The cipher *Alphabet* (Canon VIII.) is used in Jeremiah xxv. 26, li. 41, where *Sheshach* is written for *Babel*. In Jer. li. 1, *לכ קמוי*, *Leb-Kamai* (A.V., "the midst of them that rise up against me"), is written for *כשדים*, *Chaldæa*, by the same rule.

It is necessary to advert to the relation between the Kabbalah and Christianity in order to account for the extraordinary part which this theosophy played in the Christian church, especially at the time of the Renaissance. We have already seen that the Sephiric decade, or the archetypal man, like Christ, is considered to be of a double nature, both infinite and finite, perfect and imperfect. More distinct, however, is the doctrine of the Trinity. *On Deut. vi. 43*, where *Jehovah* occurs first, then *Elohim*, and then again *Jehovah*, we are told "The voice though one, consists of three elements, fire (*i.e.*, warmth), air (*i.e.*, breath), and water (*i.e.*, humidity), yet all three are one in the mystery of the voice and can only be one. Thus also *Jehovah*, *Elohim*, *Jehovah*, constitute one—three forms which are one" (*Zohar*, ii. 43, compare iii. 65). Discussing the three holy in *Isaiah vi. 3*, one codex of the *Zohar* had the following remark: "The first holy denotes the Holy Father, the second the Holy Son, and the third the Holy Ghost" (*comp. Galatinus, De Arcanis Cathol.*, lib. ii. c. 3. p. 31, Wolf, *Bibliotheca Hebræa*, i. 1136). Still more distinct is the doctrine of the atonement. "The Messiah invokes all the sufferings, pain, and afflictions of Israel to come upon Him. Now if He did not remove them thus and take them upon Himself, no man could endure the sufferings of Israel, due as their punishment for transgressing the law; as it is written (*Isa. liii. 4*), Surely He hath borne our griefs and carried our sorrows" (*Zohar*, ii. 12). These and similar statements favouring the doctrines of the New Testament have made many Kabbalists of the highest position in the synagogue embrace the Christian faith, and write elaborate books to win their Jewish brethren over to Christ. As early as 1450 a company of Jewish converts in Spain, at the head of which were Paul de Heredia, Vidal de Saragossa de Aragon, and Davila, published compilations of Kabbalistic treatises to prove from them the doctrines of Christianity. They were followed by Paul Ricci, professor at Pavia, and physician to the emperor Maximilian I. Sharing the conviction of his fellow converts that the doctrines of the Kabbalah are the doctrines of Christianity, this eminent Hebraist translated into Latin the Kabbalistic work entitled *The Gates of Light*, which he dedicated to the emperor (1516). It was from this work that Pico de Mirandola and John Reuchlin learnt the true secrets of the Kabbalah. Prominent among the "nine hundred theses" which Mirandola had pledged in Rome, and which he undertook to defend in the presence of all European scholars, whom he invited to the Eternal City, promising to defray their travelling expenses, was the following: "No science yields greater proof of the divinity of Christ than magic and the Kabbalah." Mirandola so convinced Pope Sixtus of the paramount importance of the Kabbalah as an auxiliary to Christianity that his holiness exerted himself to have Kabbalistic writings translated into Latin for the use of divinity students. With equal zeal did Reuchlin act as the apostle of the Kabbalah. His treatises exercised an almost magic influence upon the greatest thinkers of the time. Pope Leo X. and the early Reformers were alike captivated by the charms of the Kabbalah as propounded by Reuchlin, and not only divines, but statesmen and warriors, began to study the Oriental languages in order to be able to fathom the mysteries of Jewish theosophy.

Though the followers of this theosophy claim two works as their codes, viz., the *Book of Creation* and the *Zohar*, it is really only the latter which is the Bible of the Kabbalists. The renowned *Zohar* is written in Aramaic, and is a commentary on the Pentateuch, according to its division into fifty-two hebdomadal lessons. It derives its name *זוהר*, *i.e.*, Light, from the words "Let there be light" (*Gen. i. 4*), with the exposition of which it begins. Interspersed



throughout the *Zohar*, either as parts of the text with distinct titles or in separate columns, are the following eleven dissertations:—(1) "Additions and Supplements"; (2) "The Mansions and Abodes," describing the structure of paradise and hell; (3) "The Mysteries of the Pentateuch," describing the evolution of the Sephiroth, &c.; (4) "The Hidden Interpretation," deducing esoteric doctrine from the narratives in the Pentateuch; (5) "The Faithful Shepherd," recording discussions between Moses the faithful shepherd, the prophet Elijah, and R. Simon b. Yochi, the reputed compiler of the *Zohar*; (6) "The Secret of Secrets," a treatise on physiognomy and psychology; (7) "The Aged," i.e., the prophet Elijah, discoursing with R. Simon on the doctrine of transmigration as evolved from Exod. xxi. 1-xxiv. 18; (8) "The Book of Secrets," discourses on cosmogony and demology; (9) "The Great Assembly," discourses of R. Simon to his numerous assembly of disciples on the form of the Deity and on pneumatology; (10) "The Young Man," discourses by young men of superhuman origin on the mysteries of ablutions; and (11) "The Small Assembly," containing the discourses on the Sephiroth which R. Simon delivered to the small congregation of six surviving disciples.

The *Zohar* pretends to be a compilation made by R. Simon b. Yochi, who flourished about 70-110 A.D., of doctrines which God communicated to Adam in Paradise, and which have been received uninterruptedly from the mouths of the patriarchs and prophets. Amongst the many facts, however, established by modern criticism which prove the *Zohar* to be a compilation of the 13th century, the following are the most prominent:—(1) the *Zohar* itself praises most fulsomely R. Simon, its reputed author, and exalts him above Moses; (2) it mystically explains the Hebrew vowel points which did not obtain till 570; (3) the compiler borrows two verses from the celebrated hymn called "The Royal Diadem," written by Ibn Gebirol, who was born about 1021; (4) it mentions the capture of Jerusalem by the crusaders and the retaking of the Holy City by the Saracens; (5) it speaks of the comet which appeared at Rome, July 15, 1264, under the pontificate of Urban IV.; (6) by a slip the *Zohar* assigns a reason why its contents were not revealed before 5060-66 A.M., i.e., 1300-1306 A.D.; (7) the doctrine of the En Soph and the Sephiroth was not known before the 13th century; and (8) the very existence of the *Zohar* itself was not known prior to the 13th century. Hence it is now believed that Moses de Leon (*ob.* 1305), who first circulated and sold the *Zohar* as the production of R. Simon, was himself the author. That eminent scholars both in the synagogue and in the church should have been induced to believe in its antiquity is owing to the fact that the *Zohar* embodies many opinions and doctrines which obtained among the Jews prior to the time of Christ. The undoubted antiquity of these has served as a lever in the minds of these scholars to raise the late speculations about the En Soph, the Sephiroth, &c., to the same age.

*Literature*—The *Zohar*, frequently published in 3 vols., the pagination of which, like that of the Talmud, is always the same; Baron von Rosenzweig's *Kabbala Denudata*, Sulzbach, 1677-78, Frankfurt, 1684; Azazel, *Commentary on the Doctrine of the Sephiroth*, Warsaw, 1798, Berlin, 1850; *Id.*, *Commentary on the Song of Songs*, Altona, 1763; Franck, *La Kabbala*, Paris, 1813 (trans. by Jellinek, Leipzig, 1844); Gractz, *Geschichte der Juden*, vol. vii. 442-459; art. "Cabbalah," in Smith's *Dictionary of Christian Biography*, &c.; Ginsburg, *The Kabbalah, its Doctrines, Development, and Literature*, London, 1865 (C. D. G.)

KABUL. See CABUL.

KABYLES, or more correctly KABAIL, a number of tribes in the Algerian region of northern Africa, of special interest to the politician from the peculiarity of their institutions and from the part they will probably play in the development of the French colony, and to the ethnologist

as the best known branch of the great Berber race. In 1864 it was estimated that they amounted to 2,200,000. The country which they inhabit is usually regarded as consisting of two divisions—Great Kabylia and Lesser Kabylia—the former being also known as the Kabylia of the Jurjura (also called Adrar Budfel, "Mountain of Snow"). It is admitted on all hands that the Berbers form the main aboriginal element in the population of northern Africa, that at one time or other they have occupied the whole tract of country from Egypt in the east to the Canary Islands in the west, and that they are still represented not only by the Tuâreg (Amashir, &c.), who retain their native speech, but by many tribes that have become altogether Arab in language. In regard to their real ethnic relations, however, there has been much discussion and theory: Kaltbrunner includes the Berbers in the Mediterranean race in which Haecckel places the Semites, Iberians, &c. M. G. Olivier<sup>1</sup> recognizes the Berbers as Aryans, and Faidherbe regards them as the indigenous Libyans mingled with a fair-skinned people of European origin; while Prunor Bey and Duveyrier maintain the close relation of the Berbers with the ancient Egyptians, and consider them as forming together the white African race.<sup>2</sup> Be this as it may, the Kabyles are a Berber stock, and more particularly correspond to that part of the race which was known to the Romans as Numidians. Physically they do not present any very prominent contrast to the Arabs of Algeria. Both Kabyle and Arab are white at birth, but rapidly grow brown through exposure to air and sunshine. Both have in general brown eyes and wavy hair of coarse quality, varying from dark brown to jet black. In stature there is perhaps a little difference in favour of the Kabyle, and he appears also to have a stouter trunk and bulkier muscles. Both are clearly dolichocephalic. Among the Kabyles, it is worthy of particular notice, there exists a varying proportion of individuals with fair skins, ruddy complexions, and blue or grey eyes. As to the ethnic origin of this peculiar element many conjectures have been hazarded,—one theorist seeing in them the Vandals, another the Gallic mercenaries of Rome, another an aboriginal fair-skinned race, another the dolmen-building people from Europe. In the whole domain of life and character the contrasts between Arab and Kabyle are of the most radical and striking kind. The Kabyle lives in a house of stone or clay, forming part of a fixed village or hamlet; the Arab's tent is moved from place to place. The Kabyle enjoys the individual proprietorship of his garden and his orchards; with the Arab the ownership of the soil is an attribute of the tribe. While cereals alone are cultivated by the Arab, the Kabyle has his fig trees, olives, and vines, vegetables and tobacco. Active, energetic, and enterprising, the Kabyle is to be found far from home—as a soldier in the French army, as a workman in the towns, as a field labourer, or as a pedler or trader earning by steady effort the means of purchasing his bit of ground in his native village. Nor, however insignificant they may appear when measured by a high European standard, are the native industries to be despised. Not only do they comprise the making of lime, tiles, woodwork for the houses, domestic utensils, and agricultural implements, but also the weaving and dyeing of several kinds of cloth, the tanning and dressing of leather, and the manufacture of oil and soap. Without the assistance of the wheel, the women turn out a variety of earthenware articles; before it became a sort of proscribed industry the production of gunpowder was

<sup>1</sup> "Recherches sur l'origine des Berbères," *Bull. de l'Acad. d'Hippone*, 1867, 1868.

<sup>2</sup> See Henri Duveyrier, "Les Progrès de la géographie en Algérie," 1868-71," *Bull. de la Soc. Khédiviale de Géogr.*, Cairo, 1876

regularly carried on; the native jewellers make excellent ornaments in silver, coral, and enamel; in some places wood carving has been brought to considerable perfection; and native artists know how to engrave on metal both by etching and the burin. Like the Arabs of Algeria, the Kabyles are Mahometans of the Sunnite branch and the Malekite rite, looking to Morocco as the nearer centre of their religion; but, whereas the Arabs are fatalistic and superstitious, the Kabyles show a more independent and rationalistic turn of mind. In spite of the Koran and its administrators the Kabyles are essentially democratic. In the words of Renan,<sup>1</sup> "the people is everything and suffices for everything; government, police, administration of justice, cost nothing to the community. It is the ideal of democracy, the direct government of the people by the people." The political unit is the village or commune; so many villages constitute a fraction, so many fractions a tribe; and the tribes again are combined in the Kabaila or confederation. The governing authority in the commune is the Jem'aa or general gathering of the citizens,—every man old enough to keep the fast of the Ramadhan having a right to take part in its proceedings. Its chief executive officer, the *amin*, is chosen by the goodwill of his fellows, receives no remuneration, and withdraws from his functions as soon as he loses the confidence of the electorate. Some of the Kabyles retain their vernacular speech, while others have more or less completely adopted Arabic. The best known dialect is that of the Igouaouen, or Zouaoua,<sup>2</sup> who, at least from the time of Ibn Khaldoun, have been settled on the northern side of the Jurjura; it is the principal basis of Hanoteau's *Essai de Grammaire Kabyle* (Paris, 1858). Unlike their southern brethren, the Kabyles have no alphabet, and their literature is still in the stage of oral transmission for the most part by professional reciters. Hanoteau's *Poésies populaires de la Kabylie du Jurjura* (Paris, 1867) gives the text and translation of a considerable number of historical pieces, proverbial couplets and quatrains, dancing songs, &c.

The best résumé of ascertained facts in regard to the Kabyles is the *Instructions sur l'Anthropologie de l'Algérie*, by General Faidherbe and Dr Paul Topinard, Paris, 1874. See also Danmas, *Le Sahara Algérien*, Paris, 1845; De Slane's translation of Ibn Khaldoun's *Hist. des Berbères*, Algiers, 1852; Ancepitaine, *Les Kabyles et la Colon. de l'Algérie*, Paris, 1864, and *Les Beni M'zab*, 1868; Hanoteau and Letourneaux, *La Kabylie et les Coutumes Kabyles*, Paris, 1873; a paper by Charmetant, the head of the Roman Catholic mission, in *Jahrbücher der Verbreitung des Glaubens*, 1874; Dugas, *La Kabylie et le peuple Kabyle*, Paris, 1878; Réoux, *La démographie de l'Algérie*, Paris, 1880.

**KADOM**, a town of Russia, in the Tennikoff district of the Tamboff government, 169 miles north-north-east from Tamboff, near the Moksha, a navigable sub-tributary of the Volga. It lies for the most part in a low sandy plain, but the principal church and the Sorova convent are situated on a hill. The public buildings are of no special note. The population was 7365 in 1861, and 7100 in 1870. A considerable trade is fostered by the local fairs and markets.

Kadom is an ancient place; it was purchased in 1381 along with the Meshtcher lordship by Demetrius of the Don. In modern times it has had a curious administrative history: incorporated with the Kazan government in 1708, it was assigned to the Azoff government in 1719, to the Shatsk province of the Voronezh government in 1725, and to Tamboff in 1779.

**KADŪR**, or **CADOOR**, a district of Mysore state, southern India, lying between 13° 12' and 13° 58' N. lat., and between 75° 8' and 76° 25' E. long., with an area of 2294 square miles. It is bounded on the N. by Shimoga, on the E. by Chitaldrug, on the S. of Hassan,—all Mysore districts; on the W. the Western Ghāta separate it from the Bombay district of South Kānara.

The larger portion of the district consists of the Malnad or hill country, which contains some of the wildest mountain scenery in southern India. The western frontier is formed by the chain of the Ghāts, of which the highest peaks are the Kudremukh (6215 feet) and the Meruti Gudda (5451 feet). The centre of the district is occupied by the horse-shoe range of the Bāba Budans, containing the loftiest mountain in Mysore, Mulaingiri, 6317 feet. The Maidān or plain country lying beneath the amphitheatre formed by the Bāba Budan hills is the most fertile portion of the district, well watered, and with the famous "black cotton soil." The principal rivers are the Tunga and Bhadra, which rise near each other in the Ghāts, and unite to form the Tungabhadra, a tributary of the Kistna. The eastern portion of the district is watered by the Vedavati. At the point where this river leaves the Bāba Budan hills, it is embanked to form two extensive tanks, which irrigate the lower valley. From all the rivers water is drawn off into irrigation channels by means of ancient or weirs. The chief natural wealth of Kādūr is in its forests, which contain inexhaustible supplies of the finest timber, especially teak, and also furnish shelter for the coffee plantations. Iron is found and smelted at the foot of the hills, and corundum exists in certain localities. Wild beasts and game are numerous, and fish are abundant.

The census of 1871 returned the population of the district at 332,381 (Hindus, 318,480; Mahometans, 12,017; Jains, 1316; Christians, 568). Only one town, Tarikere, contains over 5000 inhabitants, the population in 1871 being 5302. Chikmagāhūr, the headquarters of the district, has only 2027 inhabitants, and Kādūr, the old civil station, only 2733. The staple crop of the district is rice, chiefly grown on the hill slopes, where the natural rainfall is sufficient, or in the river valleys, where the fields can be irrigated from tanks and artificial canals. The principal unirrigated crop is *ragi* (*Cynosurus coracanus*), which is preferred as food by the natives to rice, as affording more sustenance. The principal agricultural industry, however, is coffee cultivation. The berry is stated to have been first introduced by a Mahometan saint, Bāba Budan, about two centuries ago, on his return from a pilgrimage to Mecca. European capital was not attracted to the enterprise till about 1840, but there are now 60,000 acres under coffee. The cocoa-nut and areca-nut palms flourish in the moist and sheltered valleys in the west. A Government cinchona plantation has also been established on the Bāba Budan hills. The local manufactures include the production of cotton cloth, rough blankets, and sugar, as well as oil-pressing, spirit-distilling, and iron-smelting. The annual value of the district exports is estimated at £297,000, and the imports at £217,000. The revenue of the district in 1873-74, excluding forests, education, and public works, was £94,316. Government aided and inspected schools numbered 176 in 1874, attended by 3027 pupils; unaided schools, 121, with 1235 pupils. The mean annual temperature at Chikmagāhūr, is about 78° F. During 1873 and 1874 the maximum recorded was 93°, and the lowest 69°. In the Malnad the temperature falls much lower, and the cold at night in December and January is very sharp. The average rainfall at Chikmagāhūr during the four years ending 1874 was only 36 inches; while on certain coffee plantations on the Malnad from 100 to 170 inches have been registered. Jungle or malarious fevers are prevalent in the Malnad at certain seasons of the year, from which neither natives nor Europeans are exempt.

*History*.—As containing the hallowed sources of the Tungabhadra, Kādūr district abounds with scenes associated with the legends of the *Rāmāyana*. Sringeri or Kishya-sringa-giri, on the Tunga river, takes precedence of all other places in its claims to mythical antiquity. Here, in historical times, was the home of Saikara Acharya, the great Sivaite reformer of the 8th century; and here at the present day resides the *jagat-guru* or supreme high priest of the Smarta Brāhmins. The most ancient sites connected with local history are the ruins of Ratnāpuri and of Sak-rāy-patiā, both of which are described as the capitals of powerful kings before the rise of the Ballāla dynasty. On the overthrow of the Ballālas by the Mahometans, the Vijayanagar empire established itself over southern India; but the feudatory chiefs were practically independent. Subsequently the greater part of the district was overrun by the Ikkeri or Bednur *pādegār* from the neighbouring district of Hassan, who was in his turn defeated in 1694 by the conquering Hindu rājās of Mysore. It was not until 1763 that Hyder Ali finally incorporated the whole country in the Mysore dominions. In 1799, after the death of Tipu, Kādūr was restored to the Hindu kingdom then set up by the marquis of Wellesley. But in 1821 a general insurrection broke out, which overpowered the Mysore

<sup>1</sup> "La société berbère," *Revue des Deux Mondes*, 1873.

<sup>2</sup> The Arabic Zouaoua (to use the French transliteration) has given rise to the well-known "Zouavea" of the French army.



Government, and necessitated the use of British troops before it was suppressed. The inquiry that followed led to the assumption of the direct administration of the entire state of Mysore by the British. This administration was continued till March 1881, when the state was again handed over to its native rulers, on the representative of the ruling family attaining his majority.

**KAEMPFER, ENGELBRECHT** (1651-1716), traveller and physician, was born September 16, 1651, at Lemgo in Lippe-Deimold, Westphalia, where his father was a pastor. He studied at Hameln, Lüneburg, Hamburg, and Lübeck, and, after graduating as doctor of philosophy at Cracow, he spent four years at Königsberg in Prussia, in the study of medicine and the natural sciences. In 1681 he visited Upsala in Sweden, where he was offered inducements to settle; but his desire for foreign travel led him eagerly to accept the post of secretary to the embassy which Charles XI. sent through Russia to Persia in 1683. When after a stay of two years the Swedish embassy prepared to return from Ispahan, Kaempfer entered the service of the Dutch East India Company, as chief surgeon of the fleet then in the Persian Gulf. A malignant fever which seized him at Gamron on the Gulf prevented his further travels for a long while; and he did not arrive at Batavia till September 1689. The following winter was spent by Kaempfer in studying the natural history of Java; and in May 1690 he set out for Japan as physician to the embassy sent yearly to that country by the Dutch. The ship in which he sailed touched at Siam, and in September arrived at Nagasaki, the only Japanese port then open to foreigners. Kaempfer stayed two years in Japan, during which he twice visited Yedo (now Tokiô), the capital of the shôgun. His adroitness, insinuating manners, and medical skill overcame the habitual jealousy and reticence of the natives, and enabled him to elicit much valuable information, which he has embodied in his *History of Japan*. In November 1692 Kaempfer left Japan, and in October 1693 he landed at Amsterdam. Receiving the degree of doctor of medicine at Leyden, he settled down in his native city to edit and publish his travels and scientific papers at his leisure; but his appointment as physician to the count of Lippe involved him in the cares of an extensive medical practice that hindered his literary labours. His health, already impaired by his travels, gave way under various domestic troubles; and he died at Lemgo, November 2, 1716, in his sixty-sixth year.

The only work Kaempfer lived to publish was *Annotatum Erolitarum Politico-medicearum Fasciculi V.* (Lemgo, 1712), a selection from his papers giving most interesting results of his observations in Georgia, Persia, and Japan. At his death his unpublished manuscripts were purchased by Sir Hans Sloane, and conveyed to England. Among them was a *History of Japan*, which was translated from the manuscript into English by J. G. Scheuchzer and published at London, in 2 vols., in 1728. The original German has never been published, the extant German version being taken from the English. The interest and value of the work are very great. It not only contains a history, strictly so called, but also a description of the political, social, and physical state of the country in the 17th century. For upwards of a hundred years it remained the chief, if not almost the only available source of information about Japan for the general reader, and is still not wholly obsolete. A life of the author is prefixed to the *History*.

**KAFFA**, a town in the Crimea. See **THEODOSIA**.

**KAFFA**, or **GOMARA**, a little-known region to the south of Abyssinia in Africa, forming a cool elevated tract between the basins of the Sobat on the west and the Juba on the east. Some of its mountain summits, among which is Mount Mata Gera, are believed to be over 12,000 feet high. Kaffa is held to be the native home of the coffee-plant, which grows in wild profusion on the mountain slopes. The chief town is Bonga, described as one of the largest towns in Ethiopia, in 7° 12' N. lat. The inhabitants, largely belonging to the race of black Gallas, are said by Beke to be Christians, and to speak a language cognate with the Gonga tongue, spoken in a portion of

Damat, on the northern side of the Abai. The French traveller Abbadie, who visited Kaffa in 1843, was the first European explorer. Dr Beke gives a description of the habits of the people in the *London Geographical Journal* for 1843; as also does Dr Krapp in his *Travels, &c., in Eastern Africa* (1860).

**KAFFRARIA, KAFFRES**. The name Kaffraria or Kaffreland properly means the country of the Kaffres, and in this sense would embrace the whole region extending from the river Keiskamma to Delagoa Bay, including at least British Kaffraria and Kaffraria Proper, Natal, Zululand, the Transvaal, and the Orange River Free State. The term, however, has usually been confined to the districts popularly known as British Kaffraria and Kaffraria Proper. Neither term is now used officially. British Kaffraria was incorporated with Cape Colony in 1866, and now forms the two official districts of King William's Town and East London; Kaffraria Proper is now known officially as the Transkeian Territories, or simply the Transkei. But, as the two designations are still in popular use, and as they are in several respects convenient, it will be useful here to give some account of the geography and the more important events in the history of the two districts under the general heading.

The physical characteristics of the two Kaffrarias bear a general resemblance to those of the Cape Colony, of which they are the north-east continuation. The country generally rises from the sea-level in a series of terraces to the lofty mountains forming the north-west boundary. British Kaffraria culminates in the Amatola mountains, rising in one part to upwards of 6000 feet. The features of Kaffraria Proper are much more varied, and exhibit some of the most picturesque scenery in South Africa. The rugged range of the Drakenberg forms its north-west boundary, rising at its north-eastern point to a height of 9657 feet. Between that range and the coast-lands are many subsidiary ranges with fertile valleys through which the great rivers make their way to the Indian Ocean. The coast region is more broken than is the case farther south. The prevalent rock along the coast of Kaffraria is the Old Sandstone, nonfossiliferous rock, quartzite, intersected occasionally with veins of white quartz rock, and often capped with a dense mass of conglomerate; while the interior mountains are classed by Mr Dunn as the Stormberg coal-bearing fossiliferous beds of the Triassic period. Kaffraria is watered by hundreds of rivers, most of them rising at no great distance from the coast, but several of them of large dimensions. The chief, beginning at the south, are the Keiskamma, the Buffalo, the Kei, the Bashee, the Umtata, the St John's or Umzimvubu, with several large tributaries, and the Umtamvuna, which separates British Kaffraria from Natal. The rivers are of little use for navigation.

Kaffraria forms one of the most naturally fertile regions in S. Africa. In British Kaffraria most of the cereals grow, and in the cloofs, and scattered over the country, are forests and clumps of valuable timber. The Transkei shows even greater possibilities of culture. The mountain gorges abound in fine trees; thick forest and bush cover the banks of the rivers; grass grows luxuriantly in the lower regions; and the lowlands and valleys are favourable to almost any kind of fruit, field, and garden cultivation. In the occupied district cattle and sheep are numerous; lions are still found in the interior, and a fair amount of the game characteristic of the inland districts belonging to the Cape. The climate generally resembles that of the eastern province of Cape Colony, but with features more approaching to those of the tropics. The coast districts are extremely hot in summer, the temperature on an average varying from 70° to 90°, while in

winter the day temperature is seldom below 50°, though the nights are very cold. But the variation in altitude places climates of all grades within easy reach, from the burning coast to the snow-clad mountain. Thunderstorms are frequent in summer; rain mostly falls in spring and summer, and the winters are generally dry. On the whole the climate may be considered as extremely healthy.

British Kaffraria, on its incorporation with Cape Colony, was divided into King William's Town and East London, each with a capital of the same name, and forming the two most easterly divisions of the colony. King William's Town has an area of 1,781 square miles, and a total population (1875) of 106,640, of whom 9012 are white; the population of the capital is 5169. The area of East London province is 1,225 square miles, and the population 15,514, of whom 3,773 are white. Its capital, East London (population, with the contiguous Panmure, 2134), at the mouth of the Buffalo river, is the port for British Kaffraria. The anchorage is exposed, but extensive harbour works are in operation (1881). In 1880, 135 foreign ships arrived of 134,753 tons, and coastwise 152 of 217,174 tons. It is connected by railway with King William's Town, the line going north-west as far as Queenstown, the capital of the province of that name. The imports of East London amounted in 1880 to £1,152,610, showing an increase of £72,488 over the previous year; and the exports to £303,991, being an increase over 1879 of £38,369. Sheep and goat rearing is extensively carried on; there are also large numbers of cattle. Wheat, maize, and millet are the staple agricultural products. The wool exported from East London in 1880 amounted to 5,253,650 lb. In both divisions are numerous German settlements.

Kaffraria Proper or the Transkeian Territories consist of the territories of various native tribes, most of which have been annexed (1875-80) to the Cape Colony, and are under the jurisdiction of magistrates. The area of Kaffraria Proper is about 18,000 square miles,—its extreme length being about 230 miles, and its breadth from the sea to the mountains bounding it on the north-west averaging about 120 miles. On the south-east it is washed by the Indian Ocean; the Drakenberg and Stormberg ranges bound it on the north-west; in the west and south-west are the Indwe and Kei rivers, and on the east and north-east the Umziinkulu and Umtamvuna. It is surrounded by Cape Colony, Basutoland, and Natal. The area and population of the various districts can only be given approximately; the following is an official estimate of the present population:—

Fingoland .....	45,000	Tambookieland.....	70,000
Idutwya Reserve .....	18,000	Griqualand East.....	100,000
Gcalekaland (Krel's } country) .....	60,000	Pondoland .....	230,000
Bomvaniland .....	20,000		543,000

Fingoland, to which (with the Idutwya Reserve and Gcalekaland) the name Tanskeian Territory, or the Transkei, is often confined, is about 40 miles square, and is the most advanced of the districts; it is suited both for pasture and for cultivation. According to the latest return it had 4976 horses, 37,298 calves, 182,869 sheep, and 50,240 goats, the total value of its stock being £321,784. The revenue in 1879 was £5047, the expenditure £3286. There are many trading stations, and wool is largely exported. The annual value of the imports and exports is estimated at £150,000. Tambookieland or Tembulaud is divided into Tambookieland Proper, the district of the Emigrant Tambookies, and Bomvaniland. The first is about 75 miles long and from 30 to 40 broad. The population is probably about 30,000. There are many trading stations, and large numbers of sheep and cattle. A bill for the annexation of Tambookieland

Proper passed the Cape Parliament in 1880. The revenue of the whole of Tambookieland was estimated at £12,500 for 1880. The magistracy is at Umtata on the river of that name. West of Tambookieland and Fingoland is the district of the Emigrant Tambookies, removed some years ago from Tambookieland over the Indwe. It is 85 miles long and 20 broad; population about 40,000, with (in 1875) 5348 horses, 38,749 cattle, 84,201 sheep, 47,300 goats, and many trading stations. The Idutwya Reserve is about 28 miles square, with (in 1874) 2514 horses, 17,698 cattle, 51,302 sheep, 14,909 goats; revenue about £1380, expenditure £2976. Gcalekaland, the country of the Gcalekas, or Ama-Xosa Kaffres under Krel, is about 50 miles long and 30 broad. Traders are settling in the country, and a small trade in wool is done. All these territories lie mainly between the Kei and Bashee rivers. Bomvaniland is about 30 miles by 20; it lies between the Bashee and Umtata rivers. On both sides of St John's river, and extending to the Natal boundary, is Pondoland; only that portion of it on the south side of the St John's river, known as St John's Territories (21,905 inhabitants), has been formally annexed, but the magistrate has jurisdiction on both sides. Pondoland is about 60 miles square. This district is noted for its fertility and beauty, and has much excellent pasture land. The district between Pondoland, Natal, Basutoland, Wodehouse division, and Tambookieland, is now known as Griqualand East, inhabited by various tribes (upwards of 100,000 souls), about 125 miles long and 40 to 75 miles wide. A great part of this territory formerly went by the name of Nomansland, in area about 6000 square miles, and lay at the foot of the Drakenberg, between the Umziinkulu and Kinira rivers. In 1862 it was handed over to Adam Kok's people, but in 1877 an Act of annexation was passed, which was promulgated in 1879. The boundaries of the new district were made to include what was known as the St John's River territory, including, however, British Pondoland. The Griquas themselves are not numerous, being found chiefly in the neighbourhood of Kokstadt, the station of the chief magistrate, 95 miles from the mouth of the St John's River. Their farms are rapidly passing into the hands of Europeans. Various other tribes have had land allotted them in the district. The whole district is said to be very fertile, and eminently adapted for the cultivation of various kinds of grain. In 1880 land was granted and sold in Griqualand East to the extent of about 300,000 acres. All these districts may be regarded as virtually annexed to the Cape, with which they will doubtless be gradually incorporated. Kaffraria is governed by ministers responsible to the Cape legislature, in which, however, it has no representatives. Mission stations and trading stations are scattered all over the region.

*Kaffre Wars.*—During the extension of the Dutch and English powers over South Africa, collisions with the natives were of course inevitable; there are six contests which more especially came under the designation of Kaffre wars. In 1780 the Great Fish river was settled on as the boundary between the Kaffres and the colonists. For some time previous to 1811 the Kaffres in the Zuurveld broke the boundary, took possession of the neutral ground, and committed depredations on the colonists. In order to expel them from the Zuurveld, Colonel Graham took the field with a mixed force in December 1811, and in the end the Kaffres were driven beyond the Fish river. In 1817 Lord Charles Somerset, governor of the colony, entered into a treaty with a chief, Ngqika, in which he acknowledged that chief as head of all the Ama-Xosa Kaffres, and in which it was agreed that any kraal to which stolen cattle could be traced should be held accountable for compensation. This was a serious blunder, Ngqika being merely a subordinate chief, the paramount chief of the Ama-Xosas being Hintza, the chief of the Ama-Gcalekas. Some stolen cattle having been traced to one of the kraals of a chief Ndlambe, Major Fraser, with a small force, was sent to enforce restitution. On this, Ndlambe and his fellow-chiefs attacked Ngqika, who claimed and obtained help from the colonial



Government. The Kaffres were completely routed in 1818 by a force under Lieutenant-Colonel Brereton. They rallied, however, and a great force suddenly poured into the colony in the early part of 1819, sweeping at first everything before them. On April 22 the prophet-chief, Makanna, attacked Grahamstown, which was garrisoned by a mere handful of troops, under Colonel Wiltshire. Assistance arrived, however, and the Kaffres were defeated with great slaughter. The principal chiefs were outlawed, the country between Koonap Kat and the Great Fish river was added to the colony, and that between the latter river and the Keiskamma declared to be neutral territory; on this some of the Kaffres were allowed to settle. Final peace, however, was far from being secured. One tribe or another was almost constantly on the move, causing disturbances in which the colonists could not but suffer. In 1823 the chief Ngqika or Gaika died, and during the minority of his infant son Sandili, the government of the tribe, now called Gaikas, devolved on Macomo, his elder half-brother, who had been permitted to occupy the valleys of the Kat river. On account of an attack on the Ama-Tembu Kaffres, he was removed from the settlement, as was also his brother Tyali (1833). Permitted to return, they were removed again, and this vacillating treatment had no doubt something to do with the next war. On December 11, 1834, another brother of Macomo, a chief of high rank, was killed while resisting a commando party. This set the whole of the Kaffre tribes in a blaze. Under Macomo, Tyali, and Nexo a force of 10,000 fighting men swept across the frontier, spread over the country, pillaged and burned the homesteads, and murdered the farmers and all who dared to resist. The fighting power of the colony was at the time scanty, but all available forces were mustered, under Colonel (afterwards Sir Harry) Smith, who reached Grahamstown on January 6, 1835, six days after news of the rising reached Cape Town. The enemy's territory was invaded, and after nine months' fighting the Kaffres were completely subdued, and a new treaty of peace concluded (September 17). By this treaty all the country as far as the river Kei was acknowledged to be British, and its inhabitants declared British subjects. A site for the seat of government was selected, and named King William's Town. All this, however, was undone by the home Government, the secretary of state for the colonies at the time being Lord Glenelg. A policy of conciliation and mildness towards the Kaffres was adopted, a policy distasteful to the colonists, although laudable efforts seem to have been made to carry it out. The next war, known as the "War of the Axe," arose from the murder of a Hottentot, to whom an old Kaffre thief was manacled while being conveyed to Grahamstown for trial for stealing an axe. The escort was attacked by a party of Kaffres and the Hottentot killed. The surrender of the murderer was refused, and war was declared on March 11, 1846. The Gaikas were the chief tribe engaged in the war, assisted during the course of it by the Tambookies. After some reverses the Kaffres were signally defeated on June 7 by General Somerset on the Gwangu, a few miles from Fort Peddie. Still the war went on, till at length Sandili, the chief of the Gaikas, surrendered, as also gradually did the other chiefs; and by the beginning of 1848 the Kaffres were again subdued, after twenty-one months' fighting. The country was declared under British rule, and was formed into the division of Victoria East and British Kaffraria, between the new colonial boundary and the Kei river,—the latter reserved for occupation by the Kaffres. The peace, however, was not to last long. About October 1850 it was reported that the Kaffres were preparing for war. Sir Harry Smith proceeded to the frontier, and summoned Sandili and the other chiefs to an interview. Sandili refused obedience; upon which, at an assembly of other chiefs, the governor declared him deposed from his chiefship, and appointed an Englishman, Mr Browlee, a magistrate, to be chief of the Gaika tribe. This measure is said to have been the immediate cause of the ensuing outbreak; but there is no doubt that the Kaffres had already determined on war. On the 24th of December Colonel Mackinnon, being sent with a small force to capture Sandili, was attacked in a narrow defile by a large body of Kaffres, and compelled to retreat with some loss. This was the signal for a general rising of the Gaika tribe. The settlers in the military villages, assembled in fancied security to celebrate Christmas day, were surprised by the treacherous foe, many of them murdered, and their houses given to the flames. Other disasters followed in quick succession. A small patrol of military was cut off to a man. The greater part of the Kaffre police deserted, many of them carrying off their arms and accoutrements. Flushed with success, the Kaffres in immense force surrounded and attacked Fort Cox, where the governor was with an inconsiderable force. His situation was truly critical. More than one unsuccessful attempt was made to relieve him; but his dauntless spirit was equal to the occasion. At the head of one hundred and fifty mounted riflemen, accompanied by Colonel Mackinnon, he dashed out of the fort, and, through a heavy fire of the enemy, rode to King William's Town,—a distance of 12 miles. Meantime, a new enemy appeared. A large number of the Kat river Hottentots, who had in former years been firm allies of the British, rose in rebellion. This revolt was followed by that of the

Hottentots at other missionary stations; and part of the Hottentots of the Cape Mounted Rifles followed their example. We have only space to state the general results of the war. After the confusion caused by the sudden outbreak had subsided, and due preparations were made, Sir Harry Smith and his gallant force soon turned the tide of war against the Kaffres. The Amatola mountains were stormed; and the paramount chief Krelhi, who all along covertly assisted the Gaikas, was severely punished. In April 1852 Sir Harry Smith was recalled, and was succeeded by Lieutenant-General Cathcart. Krelhi was again attacked, and reduced to submission. The Amatolas were finally cleared of Kaffres, and small forts erected among them to prevent their reoccupation. It was not till March 23, 1853, that martial law was revoked, and the most sanguinary of Kaffre wars brought to a conclusion, with a loss of many hundred British soldiers. Shortly after, British Kaffraria was erected into a crown colony, which it remained till 1865, when it was incorporated with the Cape Colony. After a peace of twenty-five years, once more, in 1877, the Kaffres (of Kaffraria Proper) interrupted the progress of the country and caused considerable destruction and distress. In September of that year the hereditary enmity between the Fingoes and Gelekas broke out into open hostility, the Government taking the part of the former, who were under its protection. At first the Gelekas were driven beyond the Bashee; but collecting in force again they recrossed, and got the Gaikas to join them about the end of December. After several months the governor called in the aid of the imperial troops, and soon effectually broke up and defeated the rebels. The war with the Zulu Kaffres will be described under ZULULAND.

See Theal's *Compendium of the History and Geography of South Africa*, 1873; Silver's *Handbook to South Africa*, 1880; the *General Directory and Guide-Book to the Cape of Good Hope and its Dependencies*, and other year-books and blue-books; Keith Johnston's *Africa*, 1878; Stanford's large map of the Cape of Good Hope and neighbouring territories, 1876; *The Colonies, and The Colonies and India (passim)*; *Blacks, Boers, and British*, by F. R. Statham, 1881; Hall's *South African Geography*, 1866; *The Story of Missions in South-East Africa*, by Rev. W. Shaw, 1866; Chase and Wilmore's *History of the Colony of the Cape of Good Hope*, 1871; Anthony Trollope's *South Africa*, 1878. (J. S. K.)

#### The Kaffres.

The Kaffres, or Kafirs, a large South African race, form ethnically a well-marked variety of the Negro type, and linguistically a distinct branch of the Bantu family. There are no general or collective national names, and the various tribal divisions are mostly designated by those of distinguished historical or legendary chiefs, founders of dynasties or hereditary chieftaincies. The name Káfr (a form which in popular usage designates the African race less frequently than the inhabitants of Kafiristan in Persia) is that applied by Mahometans to all who reject the faith of Islam. It was thus current along the east coast of Africa at the arrival of the Portuguese, and passed from them to the Dutch and English, and recently even to the natives themselves under the form *Kafula*, as in the expression *ba-ng'ama Kafula-nye*, they are only Káfrs. Of this race there are two main divisions, jointly occupying the southern corner of the continent from the Lower Limpopo to the Great Fish river north and south, and from the escarpments of the central plateau to the Indian Ocean west and east. They thus impinge southwards on the Hottentot domain, westwards on the kindred Basuto and Bechuana nations, northwards on the Tekezas, Maknas, and others also of kindred stock occupying the region stretching from the Limpopo to the Zambesi and even beyond it to Lakes Nyassa and Tanganyika. Politically the Kaffre domain comprises the Portuguese possessions skirting Delagoa Bay, the semi-independent Zulu territory, the colony of Natal, and the ancient territory of Zanguana, which included that part of Cape Colony till recently known as British and Independent Kaffraria. Of the two branches, each split up into a multiplicity of tribal divisions, the representative nations are the Ama-Zulus in the north, and the Ama-Xosas, Ama-Tembu, and Ama-Mpondas or Kaffres Proper in the south, whence the compound term Zulu-Kaffre now commonly applied in a collective sense to the whole race. Intermediate between the two were the Ama-Lala or Balala of Natal, where they are still represented by the Ama-Neolosi, and several broken Ama-Zulu tribes now collectively known to the Kaffres as Ama-Fengu, i.e., "poor" or "needy" people, from *fenguza*, to seek service.<sup>1</sup>

<sup>1</sup> The Ama-Fengus are regarded both by the Ama-Zulu and Ama-Xosa as slaves or out-castes, without any right to the freedom and privileges of true-born Kaffres. They are met with everywhere, not only in Fingoland between the Great Kei and Bashee rivers south of the Ama-Xosa territory, but also in Natal, Zululand, and north of it, as well as in the highlands of the interior. Yet they can scarcely be said to have any recognized territory of their own, and but for the intervention of the British they would have long ago been everywhere reduced to a state of serfdom by the dominant tribes. Those who were driven out of Zululand early in the present century fell into the hands of the Gelekas, from whom they were delivered in 1835 by Sir Benjamin D'Urban, and by him removed to the Fort Peddie district between the Fish and Keiskamma rivers. Any tribes which become broken and mixed would probably be regarded as Ama-Fengus by the other Kaffres. Hence the multiplicity of clans, such as the Ama-Be, Ama-Sembotweni, Ama-Zili, Ama-Kuzi, Ama-Sekunene, Ama-Nokaze, Ama-Tetyeni, Ama-Shwawa, &c., all of whom are collectively grouped as Ama-Fengu. Their position may be compared with that of the Laconia Helots, or the low-caste tribes of India.





of the "witch-doctor" or medicine-man, who often becomes an instrument of cruel oppression and injustice in the hands of unscrupulous chiefs. Circumcision and polygamy are universal; the former is sometimes attributed to Mahometan influences, but has really prevailed almost everywhere in East Africa from the remotest time.

Of the few industries the chief are copper and iron smelting practised by the Ama-Tembus, Zulus, and Swazis, who manufacture from the metal weapons, spoons, and agricultural implements, both for their own use and for trade. The Swazis display some taste in wood-carving, and others prepare a peculiar water-tight vessel of grass, somewhat like the wickerwork vases of the Siberian Yakuts. Characteristic of this race is their total ignorance or neglect of the art of navigation. Not the smallest boats are ever made for crossing the rivers, much less for venturing on the sea, except by the Makazana of Delagoa Bay and by the Zambesi people, who have canoes and flat-bottomed boats made of planks.

The Kaffre race has developed a distinct and apparently very old political system, which may be described as a patriarchal monarchy limited by a powerful aristocracy. Although the tribal state still prevails, the organization has thus acquired almost a feudal character. The nation is grouped in tribes, each under an hereditary *inkose* or chief, who administers his territory by means of officers chosen by himself, and who is supreme legislator with absolute jurisdiction and power of life and death. If his decisions are unjust, the nobles (that is, the foremost members of the tribe) protest in council, and their decisions form the traditional code of common law. A group of clans forms a nation, recognizing a common hereditary chief with the title of *umkunkani* or *inkose enkulu*, that is, "great chief," whose influence largely depends on his power and personal qualities. He possesses in theory unlimited authority, but in practice each clan retains a large share of self-government, the lord paramount seldom interfering except when appealed to. In Zululand this system rapidly developed under Chaka and his successors into a military despotism of an extremely arbitrary type. But with the fall of Cetewayo, followed by the division of the land amongst a number of semi-independent chiefs, an end was put to that absolute monarchy. While it lasted it was a distinct violation of the ancient liberties of the Zulu nation by the "great chief," who arrogated to himself almost divine honours, treated the people as his slaves, claimed all the land as his personal property, and made everything subservient to his dynastic interests.

The Zulu-Kaffre language is probably the most typical member of the wide-spread Bantu family, standing in much the same relation to the other branches of this stock as Sanskrit does to those of the Aryan group. It is spoken with considerable uniformity throughout the whole Kaffre domain, the Zulu or northern dialects differing rather in idiom and peculiar forms than in structure or phonetics from the Ama-Xosa and other southern varieties. In other respects Zulu is on the whole more primitive and conservative of the oldest forms, while Kaffre seems truer to the original meaning of words. Marked Zulu dialects are the Tefula and Swazi, both widely current in Zululand, the latter forming a transition between Zulu-Kaffre and the northern Tsekeza group. The Kaffre, which presents no well-defined dialects, is current from the Keiskamma river to the southern frontier of Natal, and from the Quathlamba mountains to the sea.

The Zulu-Kaffre differs in its phonetics from most other Bantu tongues by the presence of three "clicks" adopted from the Hottentots or Bosjesmans, the true aborigines of this region. These are the dental, usually represented by *c*, as in *Ama-Gaeka*, the palatal (*q*), as in *Ama-Gika*, and the lateral (*x*), as in *Ama-Xosa*, uttered respectively by thrusting forward and then suddenly withdrawing the tongue from the front teeth, the palate, and the side teeth. Besides these there is a guttural, represented by *r*, as in *Narabe*, to be pronounced *Khakhabe*.<sup>1</sup> The language is in other respects extremely harmonious, the accent falling generally on the penultimate, and all words ending in vowels, or occasionally the liquids *m* and *n*. In its structure it is very regular, with few exceptions or departures from the normal rules, which is the more surprising that its mechanism is extremely delicate and involved. The verb especially is highly inflected, presenting no less than two hundred and fifty different forms, temporal, modal, positive, negative, active, passive, causal, augmentative, &c. In this respect it is probably unsurpassed even by the intricate verbal systems of the Finno-Tatar group.

But the characteristic feature of the Zulu-Kaffre and other Bantu languages is their peculiar alliterative structure, which finds no parallel in any other linguistic family, the Mande and Gor of West Africa alone excepted. This principle of "euphonic concord," as it has been called, is regulated by the pronominal prefix inseparable from every noun, and repeated in a more or less modified form with the following adjectives and other words in agreement with the subject. The nominal root itself is unchangeable, its various relations being expressed by modifications of the prefixed particle, or "inflex," as Colenso calls it. Hence the inflexion in these languages

is mainly initial, not final, as in most other linguistic systems, on which account they have received the name of "Pronominal Prefix Languages." Of the inflecting prefixes, of which there were sixteen in the primitive Bantu speech, the chief function is concordance and relationship. Thus the proper inflex of *ntu* in the sense of man, person, being *ntu*, pl. *abantu*, we get from *ntu-ntu*, man, *abantu*, men.<sup>2</sup> The inflex of *kose*, chief, is *ku*, pl. (irreg.) *ama*,<sup>3</sup> whence *in-kose*, a chief, *ama-kose*, chiefs. Then, the adjective "great" being *kulu*, "a great man" will be *um-ntu om-kulu*, where the inflex *ntu* is repeated in the modified form *om* with the adjective *kulu*. But "a great chief" will be *in-kose cu-kulu*, where the inflex *in* is in the same way repeated in the modified form *cu* with the following adjective *kulu*. Here we see some resemblance both to the principle of progressive vocalic harmony as developed in the Ural-Altai group, in which the vowel of the root regulates those of all the following agglutinated formative elements, and to such Latin agreements as *filius meus*, *filii mei*, &c. In both cases, however, the resemblance is more apparent than real. This surprisingly complex and almost artificial principle of alliterative concordance pervading a vast number of languages spread over half a continent, and spoken exclusively by unlettered and barbarous races, is one of the most astonishing phenomena in the history of human culture. The perfection to which the system is carried in the Zulu-Kaffre group must always render that branch of the Bantu family specially interesting to the students of comparative philology.

See Gustav Fritsch, *Die Eingeborenen Süd-Afrikas*, with atlas, 50 plates, and 120 typical heads, Dresden, 1872; Bleek's *Comparative Grammar of the South African Languages*, 1869; Hahn's *Grundzüge einer Grammatik des Hottent., Berlin, 1857*; Appleyard's *Kaffir Language*, 1859; Schrieder's *Zulu Grammar in Danish*, Christiania, 1859; Dr Colenso's *Grammar of the Zulu-Kaffir Language*, 1855; Rev. F. Fleming, *Kaffra and its Inhabitants*, 1853; Girard de Hialle, *Les Peuples de l'Afrique et de l'Amérique*, Paris, 1880; Rev. J. Shooter, *Kaffirs of Natal*, 1857; Rev. L. Grant, *Zululand*, 1865; W. Houlden, *Past and Future of the Kaffre Races*, London, 1867; C. J. Büchner, in *Zeitschrift der Berlin Geo. Soc.*, March 1881. (A. B. K.)

**KÂFIRISTÂN.** This Persian term, signifying "the country of Kâfirs," or unbelievers (in Islâm), has within the last hundred years become established in geography as the name of a mountain tract on the north of Afghanistan, occupied by tribes which have resisted conversion to the faith which prevails on every side. This faith has no doubt continually gained upon these tribes more or less, and with this encroachment the limits of the Kafir country have shrunk; but the encroachment does not appear to have been large since the name became recognized in geography. Thus Baber (c. 1504) speaks of a certain place (Chaghânserâi, in recent maps "Chegarserai") as in the very jaws of Kafiristan, and this continued to apply forty years ago, if not now. Only it is clear that in his time the Kâfirs occupied tracts about Bajaur, east of the Kuner river, which they do not pass now except on raids. The country has never been entered, and even the bordering Mahometan tracts have only here and there been touched, by any European, so that we know hardly anything of its internal geography, and not even the external geography with any precision. The northern boundary may be taken as that unvisited part of the watershed of Hindû Kûsh which lies between the Dorah Pass (71° 17' E. long.) and the Khâwak Pass (69° 53' E. long.) leading into the Andarâb valley of the province of Kunduz (see *AFGHAN TURKESTAN*, vol. ii. 242). On the east it is limited by Chitrâl or Kâshkâr; on the south and west it is more difficult to define. But 35° N. lat. and 70° E. long. will mark these limits roughly, though the Kafir tribes seem still to extend south of the former line above Jakâlâbâd, whilst their limits are

<sup>2</sup> This word *Abantu* is generally used by the Kâfres in speaking of themselves as the "men" in a pre-eminent sense in opposition to the *Ama-hungi*, or inferior white people. On this ground *Abantu*, shortened to *Eantu*, has been proposed by Bleek and generally adopted as the collective name of all the races and languages belonging to this great linguistic system, which reaches from four or five degrees north of the equator southwards to Cape Colony, and stretches right across the continent from the Ogoway delta to Zanzibar.

<sup>3</sup> The regular plural of the inflex *in* is *izin*, as in *in-hlu*, house, *izin-hlu*, houses. But *ama* is extensively used instead of *abu*, *izin*, &c., in forming the plural, especially of personal nouns, nations, tribes, &c. Hence *Ama-Xosa* for *Abu-Xosa* from *un-Xosa*, *Ama-Mpondo* from *u-Mpondo*, *Ama-Kose* from *in-Kose*, &c. The northern and western Bantu nations preserve the *ntu* under the forms *ba*, *be*, *wa*, whence *Ba-suto*, *Be-chuana*, *Wa-nyamnesi*, *Wa-ganda*, &c.

<sup>1</sup> The *r* sound does not occur; it is replaced, as in Chinese, by *l*.

retracted north of the same line above Laghmán. Indeed Kafir villages, though now destroyed, exist within Darah Núr, only 20 miles from Jalálábád. It is believed that the Kafir settlements on some points also pass to the north of Hindu Kush.

Tribes of Kafir kindred, subdued and converted by the Mahometans in comparatively recent times are known as *Nimcha*, or "half-and-half." Many of these are on good terms with the Kafirs, and trade is carried on through their mediation. A most interesting account by Lieutenant-Colonel Tanner, of some tribes of this class, will be found in the *Proc. Roy. Geog. Soc.* quoted below.

The most important portion of the Kafir tribes apparently occupies the valleys which drain (by the Pech river) into the Kunur or Chitrál river, below Chaghanserai, in about 34° 49' N. lat. The most easterly occupy the valley running south from the Dorah Pass, and joining the same river at Birkot, about 35° 15' N. lat. Others are on the headwaters of the Alingar and Alishang rivers, which join in Laghmán, and the most westerly on the sources of the river of Tagáo.

Surrounded by people professing Islam and cherishing slavery, the Kafirs are naturally objects of kidnapping incursions, and these they revenge by sallies from their mountain fastnesses to plunder and kill. Wood, in 1838, found the valley of the Upper Kokecha in Badakhshan deserted on account of Kafir forays. The Lahori Pass from Dir into Chitrál was within recent years so beset by Kafir robbers that many Mus-ulman wayfarers were annually killed, whose graves were marked by cairns and flags, and designated "The Tombs of the Martyrs." Hundreds of those dismal memorials lined the road and damped the traveller's spirits. Raverty mentions a savage invasion of Kafiristan made some thirty years ago by the chief of Bajaur from the south-east, in which villages were sacked and burnt, and the people carried off and sold. Faiz Bakhsh speaks of a like invasion from the north in 1870 by the prince of Badakhshan, which penetrated by the Dozakh Darah or "Hell-glen" to Katór (which he calls the Kafir capital), bringing back a large number of captives, whom he saw at Faizabad. Whatever difficulty from within prevents the exploration of the Kafir country is due apparently to this atrocious treatment at the hands of their Moslem neighbours.

But the Kafir wars are far from being all external. Some of the tribes wage war with one another, so constant and deadly that Biddulph says their fights with their Mussulman neighbours are comparatively desultory and harmless. Kafirs are said, however, never to kill men of their own village.

The country is, as far as can be gathered, a land of lofty mountains, dizzy paths, and hair-rope bridges swinging over torrents, of narrow valleys laboriously terraced, but of wine, milk, and honey rather than of agriculture; the valleys on the eastern side, however, are described as thickly wooded and very fertile. Though table-lands are spoken of, arable land is scanty. Over the greater part of the country the winter is severe; hence the people depend much on dairy-produce, and consume vast quantities of cheese and curd, besides meat, and fruit, fresh or dried.

The hill country of the Kafirs, and of kindred races long continuing in paganism, which extended from the north of Cabul to the borders of Kashmir, was known to mediæval Asiatics, more or less loosely, as *Bilaur*, a name of ancient origin, which we find in Marco Polo as *Bolor*. *Pashai* also, from the name of one of those races now Mussulman, seems to have had a vague application to part of this region; this name also occurs both in Marco Polo and in Ibn Batuta. *Kalór* likewise has sometimes received a like vague extension.

The first distinct mention of Kafirs as a separate race seems to be in the history of Timur. When that prince, in March 1398, arrived at Andaráb on his way to invade India, he was met with a cry for help against the Katór and Siáh-posh (or "black-clothed")

Kafirs; and he entered the country of the Katór from the upper part of the Panjhir valley. It was still winter in the highlands, and the difficulties were great. Timur himself was let down the snows by *ghissals* in a basket guided by ropes. The chief of the Kafirs was called the ruler of Katór, a title which is possibly preserved in the title of the king of Chitrál (see KASHKÁB), besides surviving in the name of one of the greater Kafir tribes. Timur distinguishes between Katór and Siáh-posh; for he speaks of detaching 10,000 horse against the Siáh-posh country, which lay to the left,—therefore, it would seem, to the north of the country entered by him. This detachment met with great disaster. Timur himself claims decided success, but probably found the country quite impracticable, for he speedily emerged again at Kháwak. He speaks of the abundant fruit trees, of the wine, of the language "distinct from Turki, Persian, Hindi, and Kasbúiri," of the weapons as arrows, swords, and slings. The ruler was styled *Adálishá*, his residence *Jorkal*, and another large place *Shókal*. Timur caused an inscription to be cut in the defiles of Katór recording his invasion and its route. Masson tells us that in the Kafir country, on the Najil or Alishang river, there is a structure still known as Timur's castle.

We hear of the Kafirs again in the *Memoirs* of Baber, of their raids in Panjhir, of their wine and fondness for it,—every man carrying slung round his neck a *khin* or leathern bottle. The occasional mentions of the Kafirs in the *As-i-Akbari* seem borrowed from Baber, but this work contains another passage (Gladwin's translation, 1784, ii. 195) which probably originated a story about the Kafirs' descent from Greeks, not yet quite obsolete in Europe. In fact, however, the passage does not appear to refer to the "Kafirs" at all, but to the claim to descent from Alexander of the princes reigning in Swát before the present Yuzufzai,—a claim remarkable enough in itself, and maintained by many other princes of the hill states north of Hindu Kush.

Again, Benedict Goes, travelling from Peshawar to Cabul in 1603, heard of a city (or country) called *Cupperstan*, into which no Mahometan might enter on pain of death. Hindu traders might enter, though not into the temples. The people were said never themselves to enter their temples except in black dresses. The country abounded in grapes; the natives drank wine, of which Goes tasted; and all this was so strange that he suspected the people might be Christians. Little or nothing is heard of the Kafirs after this till the publication of Remell's *Memoir of a Map of Hindostan* (1785),—followed twenty-six years later by Elphinstone's *Cabul*, in which a considerable amount of substantial information regarding the Kafirs was given by that admirable writer, of whom the Afghans believed, and with justice, that he had a telescope with which he could see what passed on the other side of a mountain.

The most favourable opportunity ever offered for the exploration of Kafiristan was during the British occupation of Cabul in 1839-40; and a Kafir deputation invited a visit from those whom they had been led to regard as kindred. But they were coldly received, owing to the great jealousy of such intercourse shown by the Afghans.

Colonel Tanner of the Artillery made a spirited attempt to reach the country from Jalálábád in 1879, and spent some time among the Mahometans of Darah Núr, whose language and customs indicate affinity to their heathen neighbours. But he was carried away dangerously ill, on the very day when a Kafir party arrived at the village to escort him into their country. Similar invitations were brought to Major Biddulph in Chitrál in 1878. This officer was unable to avail himself of these, but he had unusual opportunities of seeing and gaining information about the people, and his chapter on the *Siáh-posh* is the most authentic account yet available. But there are no doubt local differences, and we must not assume that to be untrue which varies from Biddulph's statements.

The Kafirs are in fact only an aggregation of tribes, probably belonging to one general race, but whose present close juxtaposition is the result of various accidents and invasions which have driven them, in part at least, from the lower countries, and concentrated them in this highland region. They have themselves vague stories to this effect, and (like the Karens of Burmah) one that they formerly possessed writing. Elphinstone heard a Kafir story that brought them from Kandahár. This may have been a dim tradition, not of the place now so called, but of the Kandahár of the older Arab geographers, *Gandaritis* of Ptolemy, and *Gandhára* of the Hindu books, viz., the region



of Peshawar and Yusufzai. A clan of the now Moslem tribe of Sâfis is called *Gandhârâi*. The *Kamoz* tribe of Kafirs have been surmised to be living representatives of the Kambojas of early Sanskrit, whose name was borrowed by that region in the far East in whose forest depths religions of Indian origin reared weird and stupendous fanes, lately made known. In two other Kafir clans, Aspins and Ashkins, one is tempted to trace remnants of the *Aspasii* and *Assaceni* of Alexander's historians, whose seat was about Kner, Bajaur, and Dir.

The people are recognized from outside as *Kâfirs* ("infidels") or *Sidh-posh* ("black-clad"—compare the *Melauchlani* of ancient Scythia); but they use no collective term as applicable to themselves; in many cases different tribes are unable to converse with each other; and apparently they recognize no common tie of nationality. If hard pushed, or speaking with foreigners, they will thus employ the word *Kappra* (for *Kafir*), but so also a Hindu talking to an Englishman will sometimes use the term *Kald âmi* ("black man") collectively of his countrymen.

The variations in the catalogue of tribes given are endless; indeed, Tauer says explicitly that he never found two people who agreed in the names of four out of five, and the variation in actual lists is greater than this. Major Biddulph's information leads him to divide the whole body into three main tribes (or perhaps topographical divisions):—(1) *Bashgalis*, occupying the eastern valley adjoining Chitral, partially tributary to that state,—their principal clan being divided into Kamoz and Kamtoz; (2) *Waigalis*, occupying the Pech valley and its upper waters; (3) *Rangalis* or *Lamgalis*, on the upper waters of the streams descending towards Laghman (formerly *Lamghân*) and Cabul, and also apparently extending north of the great watershed. But these great tribes are subdivided into numerous clans, of which the Waigalis alone count eighteen. There are also broken clans, like the *Kalishas*, adjoining Chitral, a degraded race who are claimed by the Bashgalis as their slaves, and the *Kittigalis*, a small tribe near the watershed who are subject to Munjan, one of the highland cantons of Badakhsan.

More copious lists of tribes have been given by Elphinstone (three lists on different authorities), and by Raverty, Lumsden, Bellew, &c. We may notice that all lists give a prominent place to the *Katôr* or *Katâr* (see above). Other names that appear in several lists are *Wâi* or *Wâigal* (already named in Biddulph); *Kâm*, in various forms; *Wânah*, and *Sânû*, which, we learn from Tauer, are names for one great tribe; *Pashû-gar* or *Pashû-gri*, suggestive of connexion with the now Mahometanized *Pashais* of the Cabul highlands, spoken of above; *Munde-gal*, *Paruni*, *Traingani*, *Gambir* or *Gimr*, *Ashkong* or *Asktû*, *Ashpin* or *Ashpi*, *Nisha* or *Nishai*, &c. The affix *gal* or *gali*, which attaches to several Kafir names of place and tribe, is to be ascribed to a word *gal* signifying "country." The characteristics of some tribes were given to Tauer by their (*amcha*) neighbours the Chugânis, and ran thus:—"In Kafir land are many languages, many tribes with different tongues. The *Kalawas* (Katôr's?) are horsemen. The *Parunis* have no guns, they kill men with clubs. The *Majgalis* are beautiful; they have guns and are marksmen; they are men of the chase, very active and swift. The *Wamas* are the nicest of all. But the *Kalawas* (Katôr's?) are chief before the *Wamas*. And the *Nishai* are fairer than the *Wamas*."

In regard to the general aspect and complexion of the Kafirs, accounts have varied. Dr Trumpp, a learned missionary, who examined three Kafirs at Peshawar, declares them to have been in all respects like natives of Upper India, with dark hair and eyes and swarthy colour, tinged with ruddiness due to wine. On the other hand Burnes, Atkinson, Wood, and Masson all speak of their blue eyes, nearly all of their brown hair. Bellew describes Faramorz Khan, an officer of Kafir birth in the Afghan service, as of fair, almost florid complexion, and light brown hair, hardly to be distinguished from an Englishman. And, unless their fairness were a general characteristic, one hardly sees how the story current among themselves of their kin to us could have found vogue. The fact seems to be, as Biddulph states, and as the Chugâni characterization quoted above implies, that they differ considerably in complexion, some of those living at high elevations being very fair. In feature those whom he saw were pure Aryans of a high type,—the women bandsome (as all native reports make them), with brown hair and eyes, sometimes very fair. Indeed, Sir H. Rawlinson, who repeatedly saw Kafirs at

Cabul in 1838-40, has stated that the most beautiful Oriental lady he ever had seen was a Kafir slave; by loosening her golden hair she could cover herself completely from head to foot as with a veil.

The current tale has always been like that told to Goes in 1603 that no Mussulman could enter their land and live. This is true of any one entering without warning; but, on the eastern side at least, they receive visitors when passed in by one of themselves. Thus peddlers with wares from Peshawar enter; and Mahometans from Chitral are occasionally allowed to enter the country for sport, and enjoy the hospitality for which the Kafirs are famed. The assurance that they would welcome the visits of Christians has been general, and the invitation often given. Two Afghans from Peshawar, Christian converts, on the invitation of a Kafir who had been a soldier in the Guides under Colonel (now Sir Harry) Lumsden, visited the Kafir country in 1864, and brought back a very interesting journal. They witnessed, soon after entering the country, the treacherous massacre by the Kafirs, in fulfilment of an old vendetta, of a large party of Mahometans who had been invited across the border, but were themselves well treated.

The language of the Kafir tribes belongs, like their physical type, to the Aryan class. On both northern and southern slopes of Hindu Kush are spoken a number of languages and dialects, all of which, with the striking exception of the Khajuna or Barishki in Gilgit, belong to the class named, some of them leaning more to the Persian, some to the Indic (or Prakritic) type. To the first belong especially the dialects of the north known as *Ghâlcher*, spoken in Sirikol, Wakhân, Shighnân, and other cantons of the upper Oxus. To the second belong the Shina language of Dardistan, and other dialects, spoken on the Indus and west of it as far as Chitral. Major Biddulph considers the Kafir languages, of which the Khawâr or Chitrali is a type, to stand between the two classes, drawing on the whole nearest to the Indic side, but with a larger number of Persian roots than the Dard dialects. Vocabularies of Kafir or Sidh-posh dialects have been published by various persons (e.g., Leech, Burnes, Raverty, Lumsden, Trumpp, Norris, Leitner, Tauer, Biddulph). The most ample are by no means the most valuable; and the data as yet, both as to copiousness and as to precision regarding the locality of the dialects represented, are scanty, though in these respects Major Biddulph's book marks a considerable step. The Hindi character of the lists of numerals in some of the dialects is very striking. They all seem to confirm Elphinstone's statement that in all the Kafir dialects the numeration is by scores, as in the French "survival" of *quatrevingt*, *quatrevingt-dix*, &c.

Biddulph regards the religion of the Kafirs as a crude form of the old Vedic worship. *Imbra* is their chief god, a name suggestive of *Indra*. *Mani* is spoken of as mediating with Imbra on behalf of man. There are many inferior divinities, some acknowledged to have been mortals worshipped after death. Names of some of these are given by Elphinstone and by Biddulph, and a large part of the two lists agree. Stones are set up as emblems of Imbra, but carved idols are not used, says Biddulph; we must perhaps interpolate,—“as representations of Imbra,”—for there is much evidence that images are set up. *Deogan* is a name which several accounts give as that of a chief god,—perhaps a generic word connected with *deo*, *div*, *deus*, &c. Colonel Tanner's informants told him of a temple of Deogan among the Wamas, hung about with bright-coloured cloths and ornaments, whilst Deogan was represented by a fierce image of wood, armed with club, knife, and gun. The temples are said to be stored with the accumulated spoils of ages. To all the deities cows are sacrificed, and cedar branches burned. On all occasions of slaughtering for food, some deity is invoked and sacrificial ceremonies observed. The Bashgalis showed Biddulph the sacrifice of a goat. The detail is most remarkable, as he points out, in its agreement, even in some of the minutiae (such as the ritual words used, *sûch!* and *hê-mach!*), with the account given by Elphinstone after Mullah Najib,—thus attesting the authenticity of the latter's narrative.

Polygamy is practiced, and according to the balance of

evidence woman's chastity is loose, and adultery slightly punished or easily compensated (but on these points the Afghan Christians give a strongly opposed statement). Female children are freely sold by the Bashgalis to their Mussulman neighbours, and the king of Chitral receives an annual tribute of children of both sexes (whom he sells doubtless). The black clothing, which has given the Kafirs a general name, varies in character. Tribes on the Cabul side wear entire goat's skins; the Bashgalis wear short-sleeved black tunics of woven goat's hair, with a broad red binding, and girt with a leather belt bearing a dagger. On their feet they wear rude sandals of wild-goat skin, with a tuft on the instep. The women wear long sack-like garments of black woven goat's hair, with long loose sleeves, girt loosely at the waist, and with a coloured cotton scarf tightly bound over the shoulders. It is a general characteristic that men shave the whole head except a circular 3-inch patch on the crown, from which the hair hangs often to the waist. The Bashgalis at least wear no head covering. Women wear the hair plaited in many long thin tresses, coiled under their head-dress. The head-dress of the Bashgali women is remarkable, consisting of a black cap with lappets and two horns about a foot long, made of wood wrapt with black cloth and fixed to the cap. Such a head-dress, with horns of greater length, is described by Chinese travellers of the 6th and 7th centuries as worn in the valley of the upper Oxus, then held by the Yetha or Ephthalites, an indication probably of kindred with or influence over the ancestors of this Kafir tribe. Among the Sanus, Wamas, or Red Kafirs, long, massive, silver chains presented by the tribe are worn over the shoulders by successful warriors. Their women tie up the hair with a silver band.

The Kafir arms are bows and arrows, battle-axe and dagger. The dagger is peculiar, of excellent fabric, with a deep  $\Gamma$  hilt of iron with brass studs, and slung in a triangular iron sheath. Their bows and arrows are short and weak-looking, but they make good practice up to 60 yards. Swords and matchlocks are spreading.

Among the notable and general customs are the copious use of wine, which at their feasts they drink from large silver cups which are among their most precious possessions; their sitting habitually upon stools of wicker-work, whilst they find it as difficult as we do to adopt the cramped postures usual among Asiatics; their use of slips of pine for candles; the custom of recording the deeds of a warrior by a post beside his coffin, in which a peg is driven for every man he has slain. The Islamized Chugāni people of Darah Nūr also maintain this practice.

The people are fond of dancing. Men and women join. Biddulph witnessed a village dance, wild and strange,—the men brandishing arms, with whooping and whistling and discharge of guns. At times the whole would lock arms by pairs and revolve backwards and forwards in grotesque waltz, or following in order wind in figures of 8.

Their houses are neat and clean, generally of more than one story (communicating by rough ladder beams), and sometimes of five or six on the declivity of a hill. They are much embellished with wood carving. We may assume Tanner's striking description of a large Chugāni village to give a fairer idea of the Kafir towns than we have yet any direct means of gaining:—

"It is built on the face of a very steep slope, and the houses, of which there must be six hundred, are arranged in terraces one above another. From the roof of one of the lower ones I gazed with astonishment at a vast amphitheatre of carved wood—at thousands of carved veranda-posts, and at tens of thousands of carved panels, with which the upper story of each house is constructed. . . . The carving completely covered the woodwork of the upper story of every house. The lower story is of stone and wood, and double the extent of the upper, and this allows an open roof-space on which the inhabitants mostly pass their time in fine weather—

A newborn child is carried with its mother to a special house outside the village, where they remain secluded. After twenty days mother and child are bathed and brought back with music and dancing. The dead are placed in coffins, and, after much dancing and wailing and sham fighting, are carried to some lofty spot and there deposited, but no grave is made.

The Siāh-posh dogs, cattle, sheep, fowls, and all their agricultural products are famous for quality, and much sought by their neighbours. Their cattle in appearance and size compare favourably with English breeds, but have large humps. The women are said to do much of the agricultural work.

On Kafirs, see Elphinstone's *Cabul*, ed. 1839, ii. 373 sq.; Bunes, *Cabool*, 1842, pp. 206 sq. and 381 sq.; Masson, *Journeys*, 1842, chap. xi.; Lumsden's *Mission to Kandahar*, Calcutta, 1860; Raverty, in *Journ. As. Soc. Bengal*, vols. xxviii. and xxxiii.; Bellew, "Lecture," in *Journ. U. S. Inst. Ind.*, No. 41, Sinla, 1879; Leitner, *ibid.*, No. 43, 1880; Biddulph, *Tribes of Hindoo Koosh*, Calcutta, 1880; Tanner, in *Proc. Roy. Geog. Soc.*, May 1881; *Church Missionary Intelligencer* for 1865, reprinted in same for December 1878; also *Church Missionary Intelligencer* for September 1874; Wood's *Oxus*; Terentyef, *Russia and England in Central Asia*, translated by Danke, Calcutta, 1876, i. 298 sq. (this has some amount of nonsense, deducing the Kafirs from a Slav migration through Byzantium, &c.); *Quarterly Review*, April 1873, p. 534 sq.; *Jour. Roy. As. Soc.*, vol. xix. p. 1 sq. (H. Y.)

K AHLŪR, also called BILĀSPUR, one of the petty hill states in the Panjab, India, lying between 31° 12' 30" and 31° 35' 45" N. lat., and between 76° 26' and 76° 58' E. long. The area is 448 square miles, and the estimated population 60,000. The principal products are opium and grain; woollen goods are manufactured. The estimated revenue is about £10,000. The Gurkhās overran the country in the early part of the century, and expelled the rájá, who was, however, reinstated by the British in 1815.

K'AI-FUNG FOO is the capital of the province of Honan in China, and is one of the most ancient cities in the empire. A city on the present site was first built by Duke Chwang (774-700 B.C.) to mark off (*k'ai*) the boundary of his fief (*fung*); hence its name. It has, however, passed under several *aliases* in Chinese history. During the Chow, Suy, and Tang dynasties (557-907) it was known as P'een-chow. During the Woo-tai, or five dynasties (907-960), it was the Tung king, or eastern capital. Under the Sung and Kin dynasties (960-1260) it was called P'een-king. By the Yuen or Mongol dynasty (1260-1368), its name was again changed to P'een-leang, and on the return of the Chinese to power with the establishment of the Ming dynasty (1368-1644), it was rechristened by its original name of K'ai-fung. The city is situated at the point where the last spur of the Kwan-lun mountain system melts away in the eastern plain, and a few miles south of the Yellow river. Its position, therefore, lays it open to the destructive influences of the Hwang-ho. In 1642 it was totally destroyed by a flood caused by the dykes of that river bursting, and on several prior and subsequent occasions it has suffered injury from the same cause. The city is large and imposing-looking, with broad streets and handsome edifices, the most noticeable of which are a twelve-storied pagoda 600 feet high, and a watch tower from which, at a height of 200 feet, the inhabitants are able to observe the approach of the yellow waters of the river in times of flood. The city wall forms a substantial protection, and is pierced by five gates. The whole neighbourhood, which is the site of one of the earliest settlements of the Chinese in China, is full of historical associations, and it was in this city that the Jews who entered China in the reign of Ming-te (58-75 A.D.) first established a colony. For many centuries these people held themselves aloof from the natives, and practised the rites of their religion in a temple built and supported



by themselves. Of late years, however, they have fallen upon evil times, and in 1851, out of the seventy families which constituted the original colony, only seven remained. For fifty years no rabbi had ministered to the wants of this remnant. Their temple was in ruins, and the people themselves were reduced to the lowest extreme of poverty. In 1853 the city was attacked by the Tai-ping rebels, and, though at the first assault its defenders successfully resisted the enemy, it was subsequently taken. With the ruthlessness common to the Tai-pings the captors looted and partially destroyed the town, which still retains traces of this its latest misfortune. Of the population, which is probably not far short of 100,000, it is estimated that two-thirds of the tradesmen, tavern keepers, educated classes, and attendants at the Government offices are Mahometans. The city, which is situated in 34° 52' N. lat., and 114° 33' E. long., forms also the district city of Seang-foo.

KAIRA, a British district in the province of Guzerat, Bombay, India, lying between 22° 26' and 23° 6' N. lat., and between 72° 33' and 73° 21' E. long., bounded on the N. by Ahmadábád district, on the E. and S. by the river Mahi, and on the W. by Ahmadábád district and the state of Cambay, with an area of 1561 square miles. Except a small corner of hilly ground near its northern boundary, and in the south-east and south where the land along the Mahi is furrowed into deep ravines, Kaira district forms one unbroken plain, sloping gently towards the south-west. The north and north-east portions are dotted with patches of rich rice land, broken by untilled tracts of low brushwood. The centre of the district is very fertile and highly cultivated; the luxuriant fields are surrounded by high growing hedges, and the whole country is clothed with clusters of large, shapely trees. To the west this belt of rich vegetation passes into a bare though well-cultivated tract of rice land, growing more barren and open till it reaches the maritime belt, whitened by a salt-like crust, along the Gulf of Cambay. The chief rivers are the Mahi on the south-east and south, and the Sábarmati on the western boundary. The former, owing to its deeply cut bed and sandbanks, is impracticable for either navigation or irrigation; but the waters of the Sábarmati are largely utilized for the latter purpose. A smaller stream, the Khári, also waters a considerable area by means of canals and sluices.

The census of 1872 returned the population at 782,733 (419,142 males and 363,591 females). Hindus numbered 711,619; Musalmáns, 70,741; Pársis, 68, and Christians 305, of whom 243 are natives. Among the Hindus the most important classes are the Lewa and Kadwa Kumbis, numbering 144,639; they are the best cultivators in the district, sober, peaceful, and industrious. The Rájputs, with the exception of a few who with the title of thákur still retain landed estates, have sunk into the mass of ordinary peasant proprietors. The Kolis number 281,252; idle and turbulent under native rule, they are now quiet, hard-working, and prosperous. Among the Hindu low castes, numbering 61,834, the Dhers are distinguished for industry and good behaviour. They formerly lived in comfort by weaving coarse cotton cloth, but the competition of the Bombay and local steam mills is now shutting them out of the market. Of the Musalmán population, about one-third represent the foreign conquerors of Guzerat; the remainder are the descendants of converted Hindus. The first class, employed chiefly as cultivators, or in Government service as police and messengers, are for the most part poor; the second class, who are artisans, chiefly weavers and oil-pressers, are hard-working and well-to-do. Thirteen towns contain more than 5000 inhabitants each. Agriculture forms the support of upwards of two-thirds of the population. In 1876-77, 362,221 acres, or 75 per cent. of the Government cultivable land, were under tillage, and 20,753 acres fallow or under grass. Food grains comprise upwards of 88 per cent. of the crops; pulses, 8 per cent.; oil-seeds, 1 per cent.; fibres, 1 per cent.; the remainder being taken up by miscellaneous crops, chiefly tobacco, which has the reputation of being the finest in western India. The manufactures comprise soapmaking, glassmaking, calico printing, and handloom weaving of coarse cloth. A steam spinning and weaving mill has been recently established. The exports are grain, tobacco, butter, oil, and the petals of the *maluá* tree; the imports, piece-goods, groceries,

molasses, and dye-stuffs. About 40 miles of the Bombay, Baroda, and Central India Railway pass through the district.

The revenue administration of the district is conducted by a collector-magistrate and three assistants; for judicial purposes Kaira is included within the jurisdiction of the judge of Ahmadábád. The total imperial, local, and municipal revenue in 1875-76 was £249,314, of which £195,184 was derived from the land. Education was afforded in 1876-77 by 189 schools, attended by 14,720 pupils. Kaira possesses a public library, and in 1876 published three vernacular newspapers. The prevailing diseases consist of fevers of a malarious type. The average rainfall during the five years ending 1876 was 30 inches.

Kaira district has no independent history of its own. It is made up partly of lands acquired from the peshwá in 1802, and partly of territory acquired from the gáekwár of Baroda in 1803 and 1817.

KAIRA, chief town and headquarters of the above district, situated 5 miles south-west of Mehmádábád railway station, in 22° 44' 30" N. lat., and 72° 44' 30" E. long. It is a very ancient city, having a legendary connexion with the *Mahábháratá*, and is proved by the evidence of copperplate grants to have been known as early as the 5th century. Early in the 18th century it passed to the Babi family, with whom it remained till 1763, when it was taken by the Marhattás; it was finally handed over to the British in 1803. It was a large military station till 1820, when the cantonment was removed to Deesa. Population (1872), 12,681.

KAIRWAN, KIRWAN, KERWAN (properly KAIRAWÁN), the Mecca of northern Africa, is a city of the regency of Tunis, 30 miles inland from Susa, and about 80 miles due south from the capital. It is built in an open plain a little to the west of a stream which flows south to the Sidi el Heni lake. Of the luxuriant gardens and olive groves which form so prominent a feature in the early Arabic accounts of the place hardly a remnant has been left. The total circuit of the walls, according to Edward Rac, is about 3500 yards; and the population is variously estimated from 10,000 to 15,000. A little modification of the eastern wall would make the plan an irregular hexagon. Kairwan is emphatically a religious city; no Jew is permitted to enter within its gates, and it is only at rare intervals that access has been obtained by Christian travellers, though for them in ordinary circumstances the real danger is reduced to a minimum. The more important mosques are only six in number, but the variety of the lesser religious structures is exceedingly great, and several parts of the city are crowded with the tombs of saints and warriors of the Mahometan faith. In the northern quarter stands the great mosque founded by 'Okba ibn Náf' el Fehri, and containing within its sacred precincts the shrine of this great defender of the faith and the tombs of the kings of Tunis. It has a length of 140 yards, and the south-east and north-east ends measure respectively 85 and 75 yards. To the outside it presents a heavy buttressed wall, with little of either grandeur or grace, but in the interior, in spite of whitewash and paint, it has that magnificence of marble columns which fitted it to be the prototype of the mosque of Cordova. As no European footstep has traversed its arcades, the number of the columns has not been ascertained, but there are at least upwards of 400 of them—a mingled spoil from the Roman ruins of the surrounding country. To the Mahometan mind the crowning distinction of the building is that through Divine inspiration the founder was enabled to set it absolutely true to Mecca. In the central aisle are two pillars between which the people believe that no person with the guilt of mortal sin upon him can by any possibility pass. A unique collection of ancient armour is preserved in one of the chambers. Of greater external beauty than the great mosque is the mosque of the Three Gates. The shrine of Sidi Ibn 'Isá is worthy of note for the peculiar conjuring performances carried on every Friday by the followers of its founder; and that of

the Campañion (*i.e.* of the Prophet) outside of the walls is specially sacred as possessing three hairs of the Prophet's beard. Formerly famous for its carpets and its oil of roses, Kairwan is now known in northern Africa rather for copper vessels, articles in morocco leather, potash, and saltpetre. In almost every respect it has greatly declined.

The Arabic historians relate the foundation of Kairwan by 'Okba with miraculous circumstances (Tabary, ii. 63; Yakut, iv. 213). The date is variously given (see Weil, *Gesch. d. Chalifen*, i. 283 *sq.*); according to Tabary it must have been before 670.

See Grenville T. Temple, *Excursions in the Mediterranean*, 1835; Edward Rae, *The Country of the Moors*, 1873; R. L. Playfair, *Travels in the Footsteps of Bruce*, 1877.

**KAISARIEH.** See **CESAREA**, vol. iv. p. 640.

**KAISERSLAUTERN**, the chief town of a circle in the government district of Rheinpfalz, Bavaria, is situated on the Lanter, in the hilly district of Westrich, about 40 miles west of Mannheim, and is one of the most important industrial towns of the Palatinate. It is the seat of the usual official bureaus, and counts among its educational institutions a gymnasium, a Protestant normal school, a commercial school, and an industrial museum. There are several churches, of which one owes its first foundation to Frederick Barbarossa, a hospital, and a large fruit-market. The house of correction occupies the site of Barbarossa's castle, built in 1153, and demolished by the French in 1713. The industries include cotton and wool spinning and weaving, iron-founding, and the manufacture of beer, tobacco, and numerous other articles. There is some trade in fruit and in timber. Population in 1875, 22,699.

Kaiserslautern takes its name from the emperor (Kaiser) Frederick I., who presented to the place a wood worth 50,000 marks annually. In 1276 it became a town, and in 1357 passed to the Palatinate. In 1621 it was taken by the Spanish, in 1631 by the Swedish, in 1635 by the imperial, and in 1713 by the French troops. During 1793 and 1794 it was the scene of active fighting; and in the Franco-Prussian war of 1870 it was the base of operations of the second German army, under Prince Frederick Charles. It was one of the early stations of the Reformation, and in 1849 was a focus for the revolutionary spirit in the Palatinate.

**KAISERSWERTH**, an ancient town in the circle and government district of Düsseldorf, Prussia, is situated on the right bank of the Rhine, 6 miles below Düsseldorf. It contains an old Romanesque church of the 12th or 13th century, and has several benevolent institutions, of which the chief is the training-school for Protestant sisters of charity. This institution, founded by Pastor Fließner in 1836, has more than 100 branches, some even in Asia and America; the head establishment at Kaiserswerth includes an orphanage, a lunatic asylum, and a Magdalen institution. The Roman Catholic hospital occupies the former Franciscan convent. The population in 1875 was 2135, chiefly engaged in silk-weaving and tobacco manufacture.

In 710 Pippin of Heristal presented the site of the town to Bishop Suibert, who built the Benedictine monastery round which the town gradually formed. Until 1214 Kaiserswerth lay on an island, but in that year Count Adolphus V. of Berg, who was besieging it, dammed up effectually one arm of the Rhine. About the beginning of the 14th century Kaiserswerth was pawned by the empire to Jülich, whence, after some vicissitudes, it finally passed into the possession of the princes of the Palatinate, whose rights, long disputed by the elector of Cologne, were legally settled in 1762. In 1702 the fortress was captured by the Austrians and Prussians, and the Kaiserburg, whence the young emperor Henry IV. was abducted by Archbishop Hanno in 1062, blown up.

**KAITHAL**, or **KYTHAL**, an ancient town in Karnal district, Punjab, India, 29° 48' 7" N. lat., 76° 26' 26" E. long. It is said to have been founded by the mythical hero Tudishthira, and is connected by tradition with the monkey-god Hanúmán. In 1767 it fell into the hands of the Sikh chieftain, Bhai Desu Singh, whose descendants, the Bhais to Kaithal, ranked among the most important and powerful Cis-Sutlej chiefs. Their territories lapsed to the British in 1843. There is some trade in grain, sal-

ammoniac, live stock, and blankets; and saltpetre and lac ornaments and toys are manufactured. Population in 1868, 14,490.

**KAKAPO**, the Maori name, signifying "Night-Parrot," and frequently adopted by English writers, of a bird, commonly called by British colonists in New Zealand the "Ground-Parrot" or "Owl-Parrot." The existence of this singular form was first made known in 1843 by Dieffenbach (*Travels in N Zealand*, ii. p. 194), from some of its tail-feathers obtained by him in the interior of that country, and he suggested that it was one of the *Cuculidæ*, possibly belonging to the genus *Centropus*, but he added that it was becoming scarce, and that no example had been seen for many years. The late Mr G. R. Gray, noticing it in June 1845 (*Zool. Voy. "Erebús" and "Terror,"* part ix. p. 9), was able to say little more of it, but very soon afterwards a skin was received at the British Museum, of which, in the following September, he published a figure (*Gen. Birds*, part xvii.), naming it *Strigops<sup>1</sup> habroptilus*, and rightly placing it among the Parrots, but he did not describe it technically for another eighteen months (*Proc. Zool. Society*, 1847, p. 61), by which time some further information concerning it had been furnished by Sir George Grey (*Ann. Nat. History*, xviii. p. 427) and the late Mr Strange (*Proc. Zool. Society*, 1847, p. 50); while in the same year Jules Verreaux sent an example, with an account of its habits, to the museum of Paris, which was published by Dr Pucheran (*Rev. Zoologique*, 1847, p. 385). Various observers, among whom must be especially named Drs Lyall (*Proc. Zool. Society*, 1852, p. 31) and Haast (*Verh. zool.-bot. Gesellsch. Wien*, 1863, p. 1115) supplied other particulars, and many specimens have now been received in Europe, so that it is represented in most museums, and at least half a dozen examples have reached England alive. Yet, though much has been written about it, there is no detailed description of its internal structure, which fact is the more to be regretted since the bird is obviously doomed to early extinction, and the opportunity of solving several zoological problems of great interest, which a minute examination of its anatomy might afford, will be lost if some one does not speedily take the matter in hand. Few existing birds offer a better subject for a monographer, and it is to be hoped that, if perish the genus and species must, posterity will not have to lament the want of an exhaustive treatise on its many and wonderful characteristics.

In habits the Kakapo is almost wholly nocturnal,<sup>2</sup> hiding in holes (which in some instances it seems to make for itself) under the roots of trees or rocks during the daytime, and only issuing forth about sunset to seek its food, which is solely vegetable in kind, and consists of the twigs, leaves, seeds, and fruits of trees, grass, and fern-roots—some observers say mosses also. It sometimes climbs trees, but generally remains on the ground, only using its comparatively short wings to balance itself in running, or to break its fall when it drops from a tree—though not always then—being apparently quite incapable of real flight. It thus becomes an easy prey to the marauding creatures—cats, rats, and so forth—which European colonists have let loose in New Zealand, so disastrously for its indigenous inhabitants. Sir G. Grey says it had been, within the memory of old people, abundant in every part of that country, but (writing in 1854) was then found only in the unsettled districts. But as the latter are continually suffering from encroachment, so are the haunts of the Kakapo, and it is

<sup>1</sup> This generic term was subsequently altered by Van der Hoeven, rather pedantically, to *Strigops*, a spelling now generally adopted.

<sup>2</sup> It has, however, been occasionally observed abroad by day; and, in captivity, one example at least is said to have been just as active by day as by night.



to be remarked that, from some cause unknown to us, there are localities which, though unsettled, it does not seem to inhabit, and thus little hope can be entertained of its surviving much longer.

The Kakapo is about the size of a Raven, of a green or brownish-green colour, thickly freckled and irregularly barred with dark brown, and dashed here and there with longitudinal stripes of light yellow. Examples are subject to much variation in colour<sup>1</sup> and shade, and in some the lower parts are deeply tinged with yellow. Externally the most striking feature of the bird is its head, armed with a powerful beak, that it well knows how to use, and its face clothed with hairs and elongated feathers that sufficiently resemble the physiognomy of an Owl to justify the generic name bestowed upon it. Of its internal structure little has been described, and that not always correctly. Its furcula has been said (*Proc. Zool. Society*, 1874, p. 594) to be "lost," whereas the clavicles, which in most birds unite to form that bone, are present, though they do not meet, while in like manner the bird has been declared (*op. cit.*, 1867, p. 624, note) to furnish among the *Carinatae* "the only apparent exception to the presence of a keel" to the sternum. The keel, however, is undoubtedly there, as remarked by MM. Blanchard (*Ann. Nat. Sc., Zoologie*, ser. 4, xi. p. 83) and A. Milne Edwards (*Ois. Foss. de la France*, ii. p. 516), and, though much reduced in size, is nearly as much developed as in the Dodo and the Weka (*qq.v.*). The aborted condition of this process can hardly be regarded but in connexion with the incapacity of the bird for flight, and may very likely be, as some have supposed, the result of disuse. There can be scarcely any doubt as to the propriety of considering this genus the type of a separate Family of *Psittaci*; but whether it stands alone, or some other forms (*Pezoporus* or *Geopsittacus*, for example, which in coloration and habits present some curious analogies) should be placed with it, must await future determination. In captivity the Kakapo is said to shew much intelligence, as well as an affectionate and playful disposition, soon attaching itself to its master and taking pleasure in caressing him and being caressed in turn. Unfortunately it does not seem to share the longevity characteristic of most Parrots, and none that have been held in confinement appear to have long survived, while many succumb speedily. For further details the reader may be referred to Gould's *Birds of Australia* (ii. p. 247) and *Humboldt* (ii. p. 539), Dr Finsch's *Die Papageien* (i. p. 241), and Mr Buller's *Birds of New Zealand* (p. 26)—in which last work nearly all the information hitherto recorded is to be found. (A. N.)

KALABÁGH, or KULABÁGH, a town in Bannu district, Punjab, India, in 32° 57' 57" N. lat., 71° 35' 37" E. long., picturesquely situated at the foot of the Salt Range, on the right bank of the Indus, where the river debouches from the hills, 105 miles below Attock. The houses nestle against the side of a precipitous hill of solid rock-salt, piled one upon another in successive tiers, the roof of each tier forming the street which passes in front of the row immediately above, and a cliff, also of pure rock-salt, towers above the town. The salt is quarried (about 2700 tons in 1871-72) at Māri, opposite the town, where it stands out in huge cliffs, practically inexhaustible. The similar outcrop at Kalabagh itself is not quarried. Alum also occurs in the neighbouring hills, and forms a considerable item of local trade. Iron implements are manufactured. Population in 1868, 6119.

<sup>1</sup> A specimen in the British Museum (*Zool. Voy. "Erstus" and "Terro"*, pt. xxii. pl. 7) has the prevailing green replaced by blue of several shades, and has been described as a distinct species, *S. greeni*; but it is obviously in an abnormal condition, and its specific distinctness cannot be maintained without further evidence.

KALAMATA, chief town of the modern Greek nomarchy of Messenia in the Morea, is situated on the left bank of the Nedon, about a mile from the sea. There is a suburb on the right bank of the stream. On a hill behind the town are the ruins of a mediæval castle; but no ancient Greek remains have been discovered, although modern travellers have identified the site with that of the classical Phare or Phere. It is the seat of a court of justice and of an archbishop. Kalamata is situated in a very fruitful district, of which it is the emporium. The roadsteads are safe in summer only; in the winter months the fishing craft take shelter in the haven of Armyro. The value of the chief exports in 1879 and 1880 was as follows:—currants, £111,750 and £109,200; figs, £142,730 and £87,186; olive oil, £21,340 and £12,789; silk, £34,230 and £31,215. The population in 1870 was 6327.

Phare, Phere, or Phere was founded, according to Pausanias, by Pharis, son of Hermes; and the antiquity of its origin is still further assured by its mention in the *Iliad* (v. 543, ix. 151), and the *Odyssey* (iii. 490, xvii. 186). When Messene was captured (182 B.C.) by the Achæans, Phare became a distinct member of the Achæan league. During the Middle Ages it was for a time a fief of the Villehardouins. In 1685 Kalamata was captured by the Venetians; in 1770, and again in 1821, it was the revolutionary headquarters in the Morea. In 1825 it was sacked by Ibrahim Pasha.

KALAMAZOO, the county seat of Kalamazoo county, Michigan, U.S., 40 miles east of Lake Michigan, and equidistant from Chicago and Detroit, at the intersection of four railways, in the centre of one of the finest agricultural districts in the country. The public institutions include Kalamazoo College, the Michigan Female Seminary, and an asylum for the insane. About one-third of all the wind-mills in the United States are made here. Agricultural implements, carriages, steel springs, paper and milling machinery are among the chief manufactures; and there are also extensive planing mills and flour mills. The population of the township in 1880 was 13,552, including the village population of 12,012.

KALATCH, a town of Russia, in the country of the Don Cossacks, on the left bank of the Don above the confluence of the Karpovka, in 48° 43' N. lat. and 43° 30' E. long. Previous to the opening of the railway to Tsaritsin on the Volga, it was a place of only 500 inhabitants, but since that date (1862) it has increased to more than 12,000 inhabitants; and its transit trade has received a great development.

KALBE, or CALBE, AN DER SAALE, chief town of a circle in the government district of Magdeburg, Prussia, is situated on the Saale, 3 miles from the Saale (Grizehne) station on the Leipzig and Magdeburg Railway. It contains a local court, a middle school, and several benevolent institutions. The industries of the place include wool-spinning, and the manufacture of cloth, oil, paper, bricks, beet-root sugar, and tobacco. Cucumbers and onions are largely cultivated in the neighbourhood; and anthracite is excavated. In 1875 the population was 7982; with the adjacent Bernburger and Schlossvorstadt it was 11,115.

KALEIDOSCOPE. This, as the name implies, is an instrument by means of which beautiful forms may be seen. It was invented by Sir David Brewster about 1815,—the idea of the instrument having occurred to him some time before while he was engaged with experiments on the polarization of light by reflexion. When it first appeared it attracted almost universal attention. This arose from the extreme beauty of the forms which it presented, their endless variety and perfect symmetry, as well as the readiness with which one beautiful form could be converted into another. The construction of the instrument was so simple, too, that almost any one could make it; and, in consequence, the patent originally taken out by Brewster was persistently evaded: kaleidoscopes were made by the hun-

dred, and sold in almost every toy-shop. Large cargoes of them were sent abroad; and it is stated that no fewer than two hundred thousand were sold in London and Paris in the space of three months. Besides being of essential service in the art of the designer, the kaleidoscope constitutes a very useful piece of philosophical apparatus, as it illustrates, in a very beautiful way, the optical problem of the multiplication of images produced by reflexion when the object is placed between two plane mirrors inclined to each other at a definite angle.

The general principle of the instrument will be easily understood from the following description and figures.

1. Let OA, OB (fig. 1) be the sections of two plane mirrors placed perpendicular to the plane of the paper and inclined to each other at a right angle. Let P be a luminous point, or object, placed between them. According to the general law of the reflexion of light from plane mirrors, the image of P formed by the mirror OA will be as far behind OA as P is in front of it; that is, the image of P is P<sub>1</sub>, where PA = P<sub>1</sub>A, the line PP<sub>1</sub> being perpendicular to OA. Now P<sub>1</sub> may be regarded as a new object placed before the mirror OB, and hence the image of P<sub>1</sub> formed by OB will be P<sub>2</sub>, where P<sub>1</sub>Y<sub>1</sub> = P<sub>2</sub>Y<sub>1</sub>. Similarly the image of P formed by OB will be P'<sub>1</sub>, where PY = P'<sub>1</sub>Y, and the image of P'<sub>1</sub> formed by OA will also be at a point such that P'<sub>1</sub>X<sub>1</sub> = P<sub>2</sub>X<sub>1</sub>, that is, the two last formed images will coincide. Hence we have three images placed symmetrically about O, constituting, with the object P, a symmetrical pattern of four luminous points placed at the corners of a rectangle.

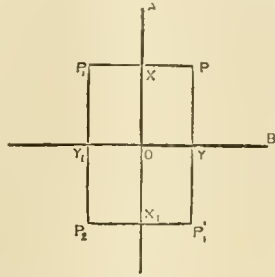

Fig. 1.

2. Let the mirrors OA and OB (fig. 2) be inclined to each other at any angle  $\alpha$ , and let P be the object placed between them. With centre O and radius OP describe a circle. Evidently the images formed by successive reflexions from the mirrors will all lie on the circumference of this circle. We shall denote the images formed by a first reflexion at OA, second at OB, third at OA, and so on, by the symbols P<sub>1</sub>, P<sub>2</sub>, P<sub>3</sub> respectively; and the images formed by a first reflexion at OB, second at OA, third at OB, and so on by P'<sub>1</sub>, P'<sub>2</sub>, P'<sub>3</sub> respectively. Draw PP<sub>1</sub> perpendicular to OA, P<sub>1</sub>P<sub>2</sub> perpendicular to OB, P<sub>2</sub>P<sub>3</sub> perpendicular to AO produced, and P<sub>3</sub>P<sub>4</sub> perpendicular to BO produced. Then P<sub>1</sub>, P<sub>2</sub>, P<sub>3</sub>, P<sub>4</sub> are the first set of images formed. Similarly draw the lines P'P'<sub>1</sub>, P'<sub>1</sub>P'<sub>2</sub>, P'<sub>2</sub>P'<sub>3</sub>, P'<sub>3</sub>P'<sub>4</sub>, then P'<sub>1</sub>, P'<sub>2</sub>, P'<sub>3</sub>, P'<sub>4</sub> are the second set of images formed by a first reflexion at OB. Now, when any image falls within the angle vertically opposite to AOB, it is evident that no further reflexion can take place, as it is behind both mirrors. Hence the number of images formed depends upon the size of the angle AOB and also upon the position of the point P in relation to the mirrors.

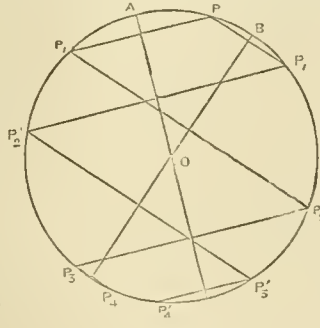

Fig. 2.

When a symmetrical picture is required, it is essential that the two last formed images, that is, P<sub>4</sub> and P'<sub>4</sub> in the figure, should coincide, and we must determine when this will be the case. We shall measure the distances of the several images from P by the arcual distances PP<sub>1</sub>, &c. Now it is evident that

$$\begin{aligned} P_1PP_1' &= 2PA + 2PB = 2AB = 2a. \\ P_2PP_2' &= PP_1 + PP_2' = PB + P_1B + P_1A + P_1'A \\ &= PB + PA + AB + P_1A + AB + P_1'B \\ &= 4AB = 4a. \\ P_3PP_3' &= 6a \\ P_4PP_4' &= 2na. \end{aligned}$$

Now, when the last formed images coincide, the arcual distance between them must be a whole circumference. Hence if P<sub>n</sub> and P'<sub>n</sub> be the last formed coincident images, we have

$$P_nPP_n' = 2na = 2\pi.$$

Hence  $a = \frac{\pi}{n}$ : that is, the mirrors must be inclined to each other at an angle which is an exact submultiple of two right angles, or, which is the same thing, an even submultiple of 360°.

3. Next suppose that, instead of a point, we put a line as an object in the angle between the mirrors: and, first, let us suppose that the mirrors are inclined to each other at an angle which is an odd submultiple of 360° (as one-fifth of 360° in fig. 3). OA, OB are the mirrors, PQ the line placed between them. The image of PQ formed by OA is PQ<sub>1</sub>, that formed by OB is QP<sub>1</sub>. The image of PQ<sub>1</sub> formed by OB is P<sub>1</sub>Q<sub>2</sub>, and the image of QP<sub>1</sub> formed by OA is Q<sub>1</sub>P<sub>2</sub>. Now it is readily seen that the points P<sub>2</sub> and Q<sub>2</sub> will not, in general, coincide, and hence, a symmetrical picture of the line cannot in general be formed when the angle is an odd submultiple of 360°. If, however, the line OP = OQ, then the points P<sub>2</sub> and Q<sub>2</sub> will coincide, and a symmetrical picture of five lines be formed. Secondly, let us suppose that the angle AOB is an even submultiple of 360°. By following the course of the images it will be seen that the last-formed images of the line coincide in all positions of PQ, and hence a symmetrical figure can, in all cases, be formed.

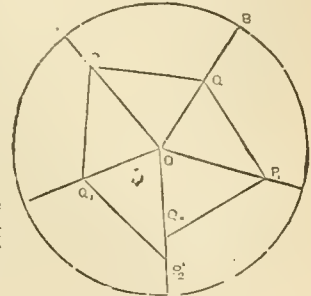

Fig. 3.

As the object of the kaleidoscope is to produce symmetrical figures from objects placed in any position between the mirrors, we are necessarily limited to angles which are even submultiples of 360°.

The simple kaleidoscope consists essentially of two plane mirrors EOA and EOB (fig. 4) inclined to each other at an angle which is an even submultiple of 360°. A very common angle in practice is 60°. The mirrors are usually made of two strips of thin flat glass,—the length of each being from 6 to 12 inches, and the greatest breadth from 1 to 3 inches. The mirrors are first fixed, in any convenient manner, at the

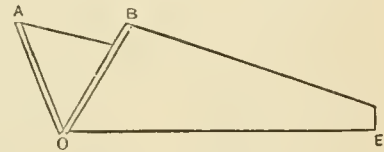

Fig. 4.

proper angle, and then inserted into a cylindrical tube of brass or paper. At the one end of the tube is a small eye-hole opposite the point E, while the other end is closed by what is called the "object box." This consists of a shallow cylindrical box, which fits on to the end of the tube, and contains the objects from whose reflexion the pattern is produced. These objects may consist of petals of differently coloured flowers, scraps of differently coloured paper, or, still better, pieces of coloured glass. Very often the objects consist of small glass tubes filled with differently coloured liquids and then hermetically sealed. These produce a very fine effect. The objects are placed in the box between two circles of thin glass which fit into the box, the one of which is transparent and the other obscured by grinding. When in position the transparent glass is close to the end of both mirrors and fills up the sector AOB, while the other, the obscured one, is fixed into the outer end of the object box. The distance between the two glasses is made as small as possible,—just room enough being left to allow the objects to fall freely by their own weight into any position between the glasses. Suppose now that the angle AOB is 60°, and that the eye is placed at E, a beautiful symmetrical picture of six equal and similar sectors will be seen round the point O: and, by simply turning the tube round, so as to allow the objects to fall into a new position, an endless variety of pictures can be produced.

It is important to notice the proper position of the eye. This should be, as nearly as possible, in the plane



of both mirrors,—first, because in that position only the direct and reflected sectors are all at the same distance from the eye, and, in consequence, no want of symmetry is introduced by the foreshortening of one sector more than another; and, secondly, because in that position the maximum amount of light is reflected to the eye by the mirrors, and, in consequence, the various sectors appear as nearly as possible equally illuminated. Of course a certain amount of light is necessarily lost at each reflexion, and hence there is always a slight difference between the luminosity of the various sectors. However, this is found not to introduce any serious want of symmetry when the instrument is properly constructed.

A modification of the simple kaleidoscope was introduced by Sir David Brewster, whereby the images of large and distant objects can be introduced into the picture. This is effected by removing the object box and replacing it by a tube carrying at its outer end a double convex lens, represented by LL in fig. 5. By a screw adjustment the lens can be so placed as to focus the distant object

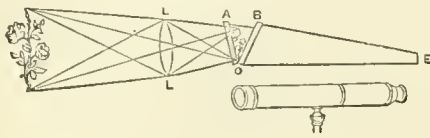

Fig. 5.

exactly in the plane of the sector AOB, and so bring its image into the very best position for producing symmetrical patterns. When this instrument is directed towards a tree in full foliage, or towards an arrangement of flowers in full bloom, a very beautiful effect is produced, which can be varied by gradually moving the instrument. This form was called by Brewster the *telescopic kaleidoscope*.

Another form is called the *polyangular kaleidoscope* (fig. 6). The only essential difference in it is that the mirrors are so arranged that the angle between them can be varied at pleasure. This, being very useful for illustrating the theory of the instrument, is the form usually found in collections of philosophical apparatus.

In all the instruments above described only two mirrors have been employed; but obviously we may have more than two. Suppose we wish to employ three mirrors enclosing a triangular opening, and that we also wish to produce perfectly symmetrical pictures. We are here limited in our choice of angles by the following conditions—first, the sum of the three angles which the mirrors make with each other must be equal to  $180^\circ$ , and, secondly, each angle must be an even submultiple of  $360^\circ$ . By trial it is easily found that the only angles which satisfy these conditions are  $60^\circ, 60^\circ, 60^\circ$ ;  $90^\circ, 60^\circ, 30^\circ$ ; and  $90^\circ, 45^\circ, 45^\circ$ . Hence with three mirrors we must choose one or other of these three sets. The first is that usually chosen.

Suppose similarly we wish to use four mirrors; then, we must put them either in the form of a square, when all the mirrors are of equal breadth, or in the form of a rectangle, when the opposite mirrors are of equal breadth. It is obvious that in these two cases only will the angle between each pair of mirrors be an even submultiple of  $360^\circ$ .

With more than four mirrors kaleidoscopes cannot be constructed

so as to give symmetrical forms, since each of the interior angles of a regular polygon of more than four sides must exceed an even submultiple of  $360^\circ$ .

See Harris's *Optics*; Wood's *Optics*; Parkinson's *Optics*; Brewster's *Treatise on the Kaleidoscope*. The last-mentioned contains an account of the application of the instrument to the art of designing. (J. BL.)

KALGAN, or CHANG-KEA-KOW, a large city of China, in the province of Chih-li, with a population estimated at from 70,000 to 100,000. It lies in the line of the Great Wall, 137 miles north-west of Peking, "commanding one of the most important passes between China and Mongolia and the main road of the overland route between China and Russia" (Bushell). Fritsche gives its position as in  $40^\circ 50'$  N. lat. and  $114^\circ 54'$  E. long., and its height above the sea as 2810 feet. The valley amid the mountains in which it is situated is under excellent cultivation, and thickly studded with villages. Kalgan consists of a walled town or fortress and suburbs 3 miles long. The streets are wide, and excellent shops are abundant; but the ordinary houses have rather an odd appearance, from the fact that, like those of Erzeroum, they are usually roofed with earth and become covered with green sward. Large quantities of soda are manufactured; and the position of the town renders it the seat of a very extensive transit trade. In early autumn long lines of camels come in from all quarters for the conveyance of the tea-chests from Kalgan to Kiakhta; and each caravan usually makes three journeys in the winter. There is an excellent inn in the town frequented by the Russian merchants, some of whom have permanent residences and warehouses just outside the gate. On the way to Peking the road passes over a beautiful bridge of seven arches, ornamented with marble figures of monkeys, lions, tigers, and other animals. The name Kalgan is Mongolian, and means a barrier or "gate-beam."

KĀLIDĀSA is the most illustrious name among the writers of the second epoch of Sanskrit literature, which, as contrasted with the age of the Vedic hymns, may be characterized as the period of artificial poetry. Owing to the utter absence of the historical sense in the Hindu race, it is impossible to fix with chronological exactness the lifetime of either Kālidāsa or any other Sanskrit author. Native tradition places him in the 1st century B.C.; but the evidence on which this belief rests has been shown to be wholly worthless. The works of the poet have been found to contain no allusions by which their date can be directly determined; yet the extremely corrupt form of the Prākṛit or popular dialects spoken by the women and the subordinate characters in his plays, as compared with the Prākṛit in inscriptions of ascertained age, has led the chief authorities, Weber and Lassen, to agree in fixing on the 3d century of our era as the approximate period to which the writings of Kālidāsa should be referred.

The richness of his creative fancy, his delicacy of sentiment, and his keen appreciation of the beauties of nature, combined with remarkable powers of description, which are conspicuous throughout his works, place Kālidāsa in the first rank of Oriental poets. The effect, however, of his productions as a whole is greatly marred by extreme artificiality of diction, which, though to a less extent than in other Hindu poets, not unfrequently takes the form of puerile conceits, and plays on words, the matter being treated merely as a means for displaying dexterity in the manipulation of the language. In this respect his writings contrast very unfavourably with the more genuine poetry of the Vedas. Though a true poet, he is wanting in that artistic sense of proportion so characteristic of the Greek mind, which exactly adjusts the parts to the whole, and combines form and matter into an inseparable poetic unity. Kālidāsa's fame rests chiefly on his dramas, but he is also distinguished as an epic and a lyric poet.

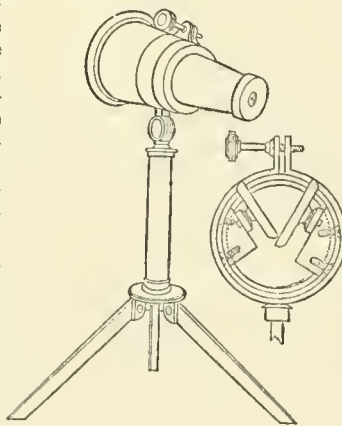

Fig. 6.

He wrote three plays, the plots of which all bear a general resemblance to each other, inasmuch as they consist of love intrigues, which, after numerous and seemingly insurmountable impediments of a similar nature, are ultimately brought to a successful conclusion.

Of these, *Ākuntalā* is that which has always justly enjoyed the greatest fame and popularity. The unqualified praise bestowed upon it by Goethe sufficiently guarantees its poetic merit. There are two recensions of the text in India, the Bengali and the Devanāgarī, the latter being generally considered older and purer. *Ākuntalā* was first translated into English by Sir William Jones (Calcutta, 1789), who used the Bengali recension. It was soon after translated into German, by G. Forster (1791), and by Herder in 1803. An edition of the Sanskrit original, with French translation, was published by Chézy at Paris in 1830. This formed the basis of a translation by Hirzel (Zurich, 1830). Another edition of the Bengali recension was published by Prema Chandra (Calcutta, 1860) for the use of European students. The Devanāgarī recension was first edited by Bohtlingk (Bonn, 1842), with a German translation. On this were based the successive German translations of Meyer (Tübingen, 1851) and Lobedanz (2d ed., Leipzig, 1861). The same recension has been edited by Dr C. Burkhard with a Sanskrit-Latin vocabulary and short Prakrit grammar (Breslau, 1872), and by Professor Monier Williams (Oxford, 2d ed., 1872). Another edition was published at Bombay in 1861.

The *Vikramorvaśī*, or *Urvaśī won by Valour*, abounds with fine lyrical passages, and is of all Indian dramas second only to *Ākuntalā* in poetic beauty. It was edited by Lenz (Bonn, 1833) and translated into German by Hofer (Berlin, 1837), by Hirzel (1838), and by Lobedanz (Leipzig, 1861). The best edition is by Bollenstein (Petersburg, 1845). There is also an English edition by Monier Williams, a metrical and prose version by the late Professor H. H. Wilson, and a literal prose translation by Professor E. B. Cowell (1851).

The third play, entitled *Mālavikāgnimitra*, has considerable poetical and dramatic merit, but is confessedly inferior to the other two. It possesses the advantage, however, that its hero Agnimitra and its heroine Mālavikā are more ordinary and human characters than those of the other plays. It was edited by Dr Tullberg at Bonn, 1840, and more correctly by Shankar P. Pandit, with English notes, in 1869, and ably translated into German by Professor Weber in 1856.

Two epic poems are also attributed to Kālidāsa. The longer of these is entitled *Raghuvansha*, the subject of which is the same as that of the *Rāmāyana*, viz., the history of Rāma, but beginning with a long account of his ancestors, the ancient rulers of Ayodhya (edited by Stenzler, London, 1832). The other epic is the *Kumārasambhava*, the theme of which is the birth of Kumāra, otherwise called Kārttikeya or Skanda, god of war (edited by Stenzler, London, 1838, and by the Rev. K. M. Banerjee, 3d ed., Calcutta, 1872). Though containing many fine passages, it is tame as a whole.

His lyrical poems are the *Meghadūta* and the *Ritusamhāra*. The *Meghadūta*, or the Cloud-Messenger, describes the complaint of an exiled lover, and the message he sends to his wife by a cloud. It is full of deep feeling, and abounds with fine descriptions of the beauties of nature. It was edited with free English translation by H. H. Wilson (Calcutta, 1813), and by Gildemeister (Bonn, 1841); a German adaptation by M. Müller appeared at Königsberg (1847), and one by Schmitz at Bielefeld (1859). It was edited by Johnson, with vocabulary and Wilson's metrical translation (London, 1867). The *Ritusamhāra*, or Collection of the Seasons, is a short poem, of less importance, on the six seasons of the year. There is an edition by Bohlen, with prose Latin and metrical German translation (Leipzig, 1840).

Another poem, entitled the *Nalodāya*, or Rise of Nala, edited by Benary (Berlin, 1830) and by Yates (Calcutta, 1844), which is a treatment of the story of Nala and Damayanti, but describes especially the restoration of Nala to prosperity and power, has been ascribed to the celebrated Kālidāsa, but was probably written by another poet of the same name. It is full of most absurd verbal conceits and metrical extravagances.

So many poems, partly of a very different stamp, are attributed to Kālidāsa that it is scarcely possible to avoid the necessity of assuming the existence of more authors than one of that name. It is by no means improbable that there were three poets thus named; indeed modern native astronomers are so convinced of the existence of a triad of authors of this name that they apply the term Kālidāsa to designate the number three. (A. A. M.)

**KALINGA**, or **CALINGA**, one of the nine kingdoms of southern India in ancient times. Its exact limits varied, but included the eastern Madras coast, from Pulicat to Chicacole, running inland from the Bay of Bengal to the Eastern Ghāts. The name at one time had a wider and vaguer meaning, comprehending Orissa, and possibly extending to the Ganges valley. — The Kalinga of Pliny

certainly included Orissa, but latterly it seems to have been confined to the Telugu-speaking country; and in the time of Hwen Tsang (630 A.D.) it was distinguished on the south and west from Andhra, and on the north from Odra or Orissa. The language of the country is Telugu. Taranatha, the Tibetan historian, speaks of Kalinga as one division of the country of Telinga. Hwen Tsang speaks of Kalinga ("Kie-ling-kia") having its capital at what may now be identified with the site either of Rājāmahendri (Rajahmundry) or Coringa. Both these towns, as well as Sinhapur, Kalingapatam, and Chicacole, share the honour of having been the chief cities of Kalinga at different periods.

**KALINGAPATAM**, or **CALINGAPATAM**, a town and port in Ganjam district, Madras, situated at the mouth of the Vamsadhāra river, 18° 20' 20" N. lat., 84° 9' 50" E. long. Population (1871), 4676. It was the capital of the ancient Hindu kingdom of Kalinga, and one of the early seats of the Mahomctan power in the Teluga country. Signs of its ancient greatness are still visible in the ruins of many mosques and other large buildings. The place is again rising in importance as a harbour, being the only safe roadstead along 400 miles of coast, and now a regular port of call for steamers. The value of the imports in 1875-76 was £16,400; of the exports, chiefly rice, seeds, and sugar, £62,800. Kalingapatam yields a salt revenue to Government of from £40,000 to £50,000 a year.

**KALISH** (Polish, *Kalisz*), the chief town of a government of the same name in Russian Poland, is situated in 51° 46' N. lat. and 17° 7' E. long., 135 miles due west of Warsaw on the banks of the Proсна, which there forms the boundary of Prussia. It is one of the oldest and finest cities of Poland, is the seat of a Roman Catholic bishop, and possesses a castle, a gymnasium, a teachers' institute, a theatre, and a large public park. The industrial establishments comprise a brewery, cloth factories, a ribbon factory, and tanneries. In 1871 the population amounted to 18,088, of whom more than 8000 were Jews.

Kalish is identified with the Calisia of Ptolemy, and its antiquity is indicated by the abundance of coins and other objects of ancient art which have been discovered on the site, as well as by the numerous grave mounds existing in the neighbourhood. In modern times it has been the scene of the decisive victory of Augustus the Strong over the Swedish general Mardefeld on 29th October 1706, of several minor conflicts in 1813, and of the friendly meeting of the Russian and the Prussian troops in 1835, in memory of which an iron obelisk was erected in the town by Nicholas I. in 1841. The treaty of 1813 between Russia and Prussia is dated from Kalish.

**KALITVENS KAYA**, a stanitsa or camp-village in the country of the Don Cossacks, on the left bank of the Donetz, 81 miles east of Novotcherkassk. The name is well known in southern Russia through the excellent building material obtained from the sandstone quarries of the neighbourhood. The population increased from about 1500 in 1860 to 12,700 in 1872.

**KĀLNĀ**, or **CULNA**, a town in Bardwān district, Bengal, India, situated on the right bank of the Bhāgirathī river, 23° 13' 20" N. lat., 88° 24' 30" E. long. It is an important river-side market town, with an extensive trade. The population in 1872 amounted to 27,336,—22,463 of them Hindus.

**KALOCSA**, a town of Hungary, and capital of the former county of Solt (now included in the county of Pest-Pilis-Solt-Kis-Kun), is situated in a marshy but highly productive district, 3 miles distant from a steam-packet station on the left bank of the Danube, and about 69 miles south of Budapest, 46° 31' N. lat., 18° 58' E. long. Kalocsa is the see of the second of the four Roman Catholic archbishops of Hungary, and has a fine cathedral, a seminary for priests, a Roman Catholic (Jesuit) gymnasium, an observatory, and an archiepiscopal palace (formerly a fortress) containing a library of 80,000 volumes and a botanical



collection. The inhabitants of Kalocsa and its wide-spreading communal lands are for the most part employed in the cultivation of the vine, fruit, flax, hemp, and cereals, in the capture of water-fowl, and in fishing. The population in 1880 amounted to 15,770, chiefly Magyars by nationality and Roman Catholics by creed.

Kalocsa is one of the oldest towns in Hungary. The present archbishopric is a development of a bishopric said to have been founded in the year 1000 by King Stephen the Saint. The town was once well fortified, and of far greater relative importance than at present. It suffered much during the 16th century from the desolating hordes of Ottomans who then ravaged the country. Kalocsa is much resorted to as an ecclesiastical centre.

**KÁLPI**, or **CULPEE**, a town in Jaláun district, North-Western Provinces, India, situated on the right bank of the Jumna, 26° 7' 30" N. lat., 79° 47' 15" E. long. Population (1872), 15,570, viz., 11,414 Hindus and 4156 Mahometans. It was founded, according to tradition, by Bāsdeo or Vasudeva, who ruled at Kámbai from 330 to 400 A.D. In 1196 it fell to Kutb-ud-din, the viceroy of Muhammad Ghorí, and during the subsequent Mahometan period it played a large part in the annals of this part of India. About the middle of the last century it fell into the hands of the Marhattás. It was captured by the British in the campaign of 1803, and since 1806 has remained in British possession. In May 1858 Sir Hugh Rose (Lord Strathnairn) defeated there a large force of about 10,000 rebels under the ráni of Jhánsí. Kálpi was formerly a place of far greater importance than at present. It had a mint for copper coinage in the reign of Akbar; and the East India Company made it one of their principal stations for providing the "commercial investment." A bridge of boats on the Jhánsí and Cawnpur road crosses the river during the summer months. Cotton and grain are exported to Cawnpur, Mirzápur, and Calcutta; and paper and sugar candy are manufactured.

**KALUGA**, a central government of European Russia, surrounded by those of Moscow, Smolensk, Orel (Orloff), and Tula. The area is estimated at 25,594 square miles, or according to the maps of the Kaluga surveying office 27,407. For the most part the surface is flat, and the culminating point of the government is a hill in the northern district of Meduin, 910 feet in height. In the north-west there is a considerable tract of peat-bog. The Oka, a main tributary of the Volga, and its confluent (the Zhizdra, the Ugra, &c.), drain all but a strip of country in the west, which is traversed by the Bolva, an affluent of the Dniéper. Strata of Carboniferous Limestone prevail except in the north, where Jurassic rocks take their place. The coal though common enough is of poor quality, and has been comparatively little worked. Clays from the southern districts are employed in the glass-works of Kaluga and the surrounding governments. Iron-ore is obtained in considerable abundance between the left-hand feeders of the Bolva and the upper course of the Zhizdra. According to the reports of the statistical committee for 1880 (*Pamyatnaya Knizhka*, 1881) about 1,246,874 acres were covered with forest (pines, firs, birches), large tracts more especially existing in the Zhizdra district; 20,000 acres consisted of marsh land, 903,580 acres were under tillage, and 2,201,208 were devoted to pasturage. The soil in most parts of the government is composed of sand or clay; and it is only in certain portions of the districts of Peremuishl, Kozelsk, and Meshtchovsk that the famous "black earth" is found. Agriculture is in a comparatively low state in Kaluga, requiring a great increase in the outlay of capital, and especially the keeping of more live stock for the fattening of the soil.

Rye and oats are the principal crops, but the production is less than the local demand. Buckwheat, potatoes, flax, and hemp are also grown. Manufacturing industries are on the increase, the

cloth and cotton factories employing upwards of 2000 men, the iron-works more than 6000, the papermills about 1300, and the match-works more than 1500. The breeding of canaries, which are sent to all parts of Russia, was a source of livelihood to 350 persons in 1880. Railway lines from Moscow to Orel, from Moscow to Smolensk, and from Smolensk to Orel enclose the government in a triangle, but none of them touch its territory. By means, however, of the navigable streams, a good deal of traffic is carried on. The government is divided into eleven districts (*uyezdy*):—Kaluga, Mosalsk, Meshtchovsk, Likhvin, Kozelsk, Zhizdra, Peremuishl, Meduin, Borovsk, Maloyaroslavets, and Tarusa. The following are the towns of more than 5000 inhabitants, according to the returns for 1870:—Kaluga, 38,600; Zhizdra, 11,700; Borovsk, 9500; Meduin, 7800; Kozelsk, 7350; Sukhinitchi, 6050; Meshtchovsk, 5450; Maloyaroslavets, 5150. The government had a population of 1,114,372 in 1880.

**KALUGA**, the chief town of the above government, is situated 475 feet above the sea-level on the left bank of the Oka, at the confluence of the Yatchenka, 114 miles south-west of Moscow, in 54° 31' N. lat. and 36° 6' E. long. Among the public buildings may be mentioned the cathedral of the Trinity (rebuilt in the present century in room of an older edifice dating from 1687), two monastic establishments, a male and a female gymnasium, an ecclesiastical seminary (with 219 students in 1879), an infant asylum, an orphanage, a public hospital, a lunatic asylum, a hospital for incurables, and a house of correction. The principal articles of production are leather, oil, bast mats, wax candles, starch, and a particular kind of cake known in Russia by the name of the town. This last item alone counts for more than 1,000,000 roubles (£156,000) per annum in the local trade. Situated as it is on a navigable river, and at the junction of important roads, Kaluga is naturally the centre of no small commercial activity. Even in the beginning of the century its merchants and manufactures were known in Leipsic, Bremen, and Dantzic. Including the suburban villages of Yamskaya and Podsavalya the town had 36,880 inhabitants in 1870.

The first historical mention of Kaluga occurs in 1389, when Demetrius of the Don assigned it to his son; and its final incorporation with the principality of Moscow belongs to the year 1518. In 1607 it was held by the pretender Bolotnikoff, and vainly besieged for four months by the forces of Shuiski; but in 1619 it fell into the hands of the Zaporogian hetman. Nor was it from war alone that Kaluga suffered. Two thirds of its inhabitants were carried off by a plague; and in 1622 the whole place was laid waste by a conflagration. It recovered, however, and, in spite of several extensive conflagrations (especially in 1742 and 1754) has continued to flourish. The rank of chief town of a province was obtained in 1719. In 1734 the population numbered 13,788, and by 1785 had increased to 17,078. On several occasions Kaluga has been chosen as the residence of political prisoners; among others, the famous Schamyl (see *Russkaya Starina*, 1877) spent his exile there.

**KALVARIYA**, (*i.e.*, Calvary), a district town in the government of Suwalki in Russian Poland, on the right bank of the Shelupa, 40 miles south-west of Kovno. It carries on a considerable trade, and manufactures needles, linen, flannel, leather, and combs. The inhabitants, of whom more than two-thirds are Jews, amounted to 9400 in 1867, and to 10,200 in 1870.

**KALW**, or **CALW**, chief town of a circle in the government district of Schwarzwald, Württemberg, is situated on the Nagold, about 34 miles south-west of Stuttgart by rail. It is the seat of local, civil, and criminal courts, and of a chamber of commerce; and it contains a high school, a commercial gymnasium, and a missionary institution. The industries include a large variety of spinning and weaving operations in wool and cotton. Carpets, cigars, and wool-combs are also manufactured. The timber trade, chiefly carried on with the Netherlands, is important. The prevalence of malaria renders the valley of the Nagold unhealthy. The population in 1875 was 4642.

The name of Kelw emerges as early as 1037. In the Middle Ages the town was under the dominion of an ancient and powerful family of counts, whose possessions finally passed to Württemberg in 1345. In 1634 the town was taken by the Bavarians, and in 1692 by the French.





the eastern side of the peninsula. The active volcanoes are as follows:—Klyutchevskaya Sopka (15,040 feet in height), Shevel'yutch (9898 feet), Bolshaya (*i.e.*, the Great) Tolbatcha (7800 feet), Kizimen, Uzon, Kishpinitch, the Great and the Little Semetchik, Zhupanova Sopka (8496 feet), Avatchinskaya (8360 feet), Asatcha, and Tchaokhtch. The eruptions of Klyutchevskaya are not unworthy of being compared with those of Mount Etna; the most notable chronicled by European observers are those of 1727–1731 (lasting four years), 1737, and 1854. More than twenty hot springs are known. The basic rocks are granite and porphyry, with metamorphic schists, basalts, trachytes, and other volcanic rocks. The sedimentary rocks are mainly of Tertiary and more particularly Eocene origin; those of the Quaternary period have a limited area. Native copper, magnetic iron, lignite, amber, mica, and sulphur are the chief minerals. Of the rivers the largest bears the same name as the peninsula; rising in the highest part of the central range, it flows north for about 310 miles, and falls into the Behring Sea. The valley of the Kamchatka forms the most fertile and most populous portion of the peninsula. For the meteorology of this portion of Asia the materials are of the scantiest; Dr Wild even (*Met. Repertorium*, suppl. vol., St Petersburg, 1881) is obliged to have recourse to observations as far back as 1844. In January the mean temperature appears to be 19.4° Fahr. at the southern point of the peninsula, 17.6° at Petropavlovsk, and -5.8° at the northern extremity. The western coast is very considerably colder in winter than the east, but the snowfall is much heavier in the east than in the west. Towards the south especially snow often lies so thick that the natives cannot keep reindeer. During summer the weather is very uncertain, with frequent rains and fogs; but in the centre of the peninsula especially there is a large amount of warmth. Vegetation, especially on soils of volcanic origin, is remarkably luxuriant; the grass grows nearly 5 feet high, and may be cut three times. In the woods berries, mushrooms, and the Martagon lily abound, the bulbs of the last also furnishing food to the natives. Beyond the forests appear *Rhododendron Kamtschaticum*, *Salix arctica*, and other plants of an alpine type. The Kamchatkan nettle—with richly variegated foliage—is a familiar object in English greenhouses. Besides the Kamchadales proper there are Korysk and Lamut tribes within the limits of the peninsula. By themselves the Kamchadales are called Itelm,—the name by which they are usually known being a corruption of Konchal, their Koryak appellation. There are not in all more than 2000 Kamchadales, and the process of Russification is going on rapidly. They are a strong hardy people, inured to the severities of the climate, capable of any amount of toil in the way of walking. To their women they are affectionate, and even submissive. In winter they live in pits covered in with earth and turf, the interior being reached by means of a ladder. In the summer they occupy slight wooden sheds (*bologans*) raised on high props or stilts. The skill they display in the training of their sledge-dogs is not surpassed by any other people who practice the same art. With their sledges (*narts*)—which measure from 5 to 10 feet in length—they travel 4 to 8 miles an hour. The Kamchadale language cannot be assigned to any known group; its vocabulary is extremely poor. The purity of the tongue is best preserved by the people of the Penzhinsk district on the west coast; many of the inhabitants of the Kamchatka valley speak a broken Russian. Mr Kennan compares the sound of the language to that of water running out of a narrow-mouthed jug. The total population of the peninsula were 7331 in 1853, and 5846 in 1870.

The Russians made their first settlements in Kamchatka in the end of the 17th century; in 1696 Vladimir Atlasoff from Anadisk founded Nizhne-Kamchatsk, and in 1704 Kobleff founded Bolsheryetsk. About twelve years later the Russians came for the first time by sea from Okhotsk. In 1720 a survey of the peninsula was undertaken; in 1725–30 it was visited by Behring's expedition; and from 1733–45 it was the scene of the labours of the Krashenninikoff and Steller expedition. Disturbance among the natives in 1731 led to the building of a fort at Tigilsk. The seat of the government is at Petropavlovsk. In 1855 the country was incorporated with the Maritime Province.

See Krashenninikoff, *Opisanie Kamchatki*, 1786, of which an English translation appeared at Gloucester, 1764, and a German translation at Leipzig, 1774; Lesseps, *Reise durch Kamtschatka*, Berlin, 1791; Erman, *Reise*, vol. iii.; Langsdorff, *Bemerk. auf einer Reise um die Welt*, 1812; Tronson, *Voyage to Japan*, &c., London, 1859; Petermann's *Mittheilungen*, 1860; *Revue d'Anthropologie*, 1872; Kennan, *Tent Life in Siberia*, New York, 1870; and the same author's paper in *Journal of Amer. Geogr. Soc.*, 1876.

KAMENETS (Polish, *Kamieniec*), usually distinguished as Podolian Kamenets, is distinguished from Lithuanian Kamenets in Grodno, is the chief town of the government of Podolia, Russia. It is situated in 48° 40' N. lat. and 26° 25' E. long., 982 miles south of St Petersburg, and occupies a high and rocky peninsula formed by the river Smotritsch, a left-hand tributary of the Dniester. Round about the town lie quite a cluster of suburban villages, the Polish Föiwark, the Russian Fölwark, Zinkövtsvi, Karvasarii, &c.; and on the opposite side of the river, and accessible by a wooden bridge, stands the fine old castle which so long frowned defiance across the Dniester to Khotin. Among the ecclesiastical buildings may be mentioned the Roman Catholic cathedral of St Peter and St Paul, built in 1361, and distinguished by a minaret, which recalls the time when it was used as a mosque by the Turks; the Greek cathedral of John the Baptist, dating from the 16th century, but up to 1798 belonging to the Basilian monastery; the Orthodox monastery of the Trinity; the Catholic Armenian church, founded in 1398, and possessing among its treasures a missal of slightly earlier date and an image of the Virgin Mary that saw the Tartar invasion. The town contains further a Government gymnasium, Orthodox and Roman Catholic seminaries, Jewish colleges, and an infirmary. The population was 20,699 (11,091 males) in 1863, comprising 9965 Jews, 4987 Catholics, 69 Armenians, and 56 Protestants. In 1870 the total was 22,611.

Kamenets appears to be first mentioned in the Russian chronicles in the end of the 12th century, though there is some doubt whether it be the Podolian town that is meant. Laid waste in 1240 by the forces of Baty, the leader of the Golden Horde, it passes out of view for nearly a century. It afterwards appears frequently in the general history of the Podolian region; and in 1434 it was made the chief town of the province of Podolia, instituted by Ladislav III., king of Poland. In the course of the 15th and 16th centuries it suffered frequently from the invasions of Tartars, Moldavians, and Turks, and in 1672 the hetman Doroshenko, assisted by Mahomet IV., made himself master of the place. Restored to Poland by the peace of Carlowitz (1699), it passed with Podolia to Russia in 1795, and on the constitution of the Podolian government in the following year obtained the rank of government town.

KAMENZ, chief town of a department in the circle of Bautzen, Saxony, is situated on the Black Elster, about 21 miles north-east of Dresden. It is the seat of a local court, and has a handsome new town-house and a library. The hospital is dedicated to the memory of Lessing, who was born here in 1729. A colossal bust of the poet was placed opposite the Wend church in 1863; and a monument was raised to him on a neighbouring hill in 1864. The industries of Kamenz include wool-spinning, and the manufacture of cloth, crockery, and stoneware. In 1875 the inhabitants numbered 6785, including the garrison.

Till the 16th century Kamenz was known by the name Dreikretcham. In 1318 it passed by purchase to the margrave of Brandenburg; in 1319 it went to the king of Bohemia; and in 1635, after suffering much in the Hussite and Thirty Years' wars, it came into

the possession of Saxony. In 1706 and 1842 it was visited by conflagration. About 6 miles south-east is the Cistercian monastery of Marienstern.

**KAMES, HENRY HOME, LORD** (1696-1782), a philosopher and Scotch judge, was descended from an old Scotch family, and was the son of George Home of Kames, in the county of Berwick, where he was born in 1696. After receiving a somewhat imperfect education from a private tutor, he was in 1712 bound by indenture to a writer to the signet in Edinburgh, but an accidental introduction to the comfortable and dignified leisure of Sir Hew Dalrymple, then president of the court of session, determined him to aspire to the higher position of advocate. He accordingly set himself with great diligence to remedy the defects of his early education, studying in private the various branches of literature and science which constituted the curriculum of arts in the Scottish universities, and with special interest those of metaphysics and moral philosophy. He was called to the bar in 1723, and, as he was unpossessed of those brilliant qualities which sometimes command immediate success, he employed his leisure in the compilation of a volume which he published in 1728 under the title *Remarkable Decisions in the Court of Session from 1716 to 1728*. This work having attracted attention to his abilities, his power of ingenious reasoning and mastery of law gradually gained him a leading position at the bar. His professional duties did not, however, prevent him devoting a large portion of his time to special studies, as well as to philosophy and literature, while his flow of animal spirits, his affectionate disposition, and his conversational gifts rendered him very partial to social intercourse, especially with persons of cultivated tastes. In 1752 he was appointed a judge in the court of session under the title of Lord Kames, and in 1763 he was made one of the lords of justiciary. Through his wife Agatha Drummond, whom he married in 1741, he in 1761 succeeded to the estate of Blair Drummond, Perthshire, where he put into practice a remarkably bold scheme of agricultural improvement, the removal of a stratum of peat on 1500 acres of land by floating it into the river Forth. He died at Edinburgh, 27th December 1782.

Whatever opinion may be formed of the literary qualities, the originality, or the intrinsic value of the publications of Lord Kames, there can be no question as to the versatility of taste and incessant diligence which they imply. The extent and thoroughness of his legal knowledge is attested by a large number of separate works: *Jus Tertii*, &c., 1732; *Dictionary of Decisions*, 1741; *Essays concerning British Antiquities*, 1747; *Principles of the Law of Scotland*, 1754; *Statute Law of Scotland abridged*, 1757; *Historical Law Tracts*, 1758; *Principles of Equity*, 1760; a second volume of *Remarkable Decisions*, 1766; *Elucidations concerning the Commercial and Statute Law of Scotland*, 1770; and *Selected Decisions of the Court of Session*, 1780. Lord Kames also took a special interest in the agricultural and commercial affairs of the country. In 1755 he was appointed a member of the board of trustees for encouragement of the fisheries, arts, and manufactures of Scotland, and about the same time he was named one of the commissioners for the management of the forfeited estates annexed to the crown. One of his favourite amusements was the embellishment of his estate, in connexion with which he carried into execution a novel plan of a winter garden. On the subject of agriculture he wrote *The Gentleman Farmer*, 1776. In 1765 he published a small pamphlet *On the Flax Husbandry of Scotland*; and, besides availing himself of his extensive acquaintance with the proprietors of Scotland to recommend the introduction of manufactures, he took a prominent part in furthering the project of the Forth and Clyde Canal. He was also one of the founders of the Physical and Literary Society, afterwards the Royal Society of Edinburgh. It is, however, as a writer on philosophy that Lord Kames is best known. In 1751 he published his *Essays on the Principles of Morality and Natural Religion*, in which he endeavoured to maintain the doctrine of innate ideas, but conceded to man an apparent but only apparent freedom of the will. His statement of the latter doctrine so aroused the alarm of certain clergymen of the Church of Scotland that he found it necessary to withdraw what was regarded as a serious error, and to attribute man's delusive sense of freedom, not to an innate conviction implanted by God, but to the influence of the passions. *An Introduction to the*

*Art of Thinking*, which appeared in 1761, was followed in 1762 by *Elements of Criticism*, an ingenious and in some respects suggestive discussion of the principles of taste, but in many ways imperfect and unsatisfactory. In 1774 he published, in two volumes, *Sketches of the History of Man*, a somewhat heterogeneous medley of opinions and speculations on a great variety of subjects, but containing many shrewd suggestions and much curious observation. The works of Kames as a whole are more remarkable for superficial fertility and varied learning than for real originality, and his reasoning is clever and ingenious rather than subtle and comprehensive. His style is loose, frequently incorrect and awkward in construction, and abounds in expressions which border on slang.

See *Life of Lord Kames*, by A. F. Tytler, Lord Woodhouselee, in 2 vols., 1867.

**KAMMIN, or CAMMIN**, the chief town of a circle in the government district of Stettin, Prussia, is situated 2½ miles from the Baltic coast, on the Kamminische Bodden, a lake connected with the sea by the Dievenow. It is the seat of a local court. The venerable cathedral and the church of St Mary are noteworthy. Portland cement and knitted goods are produced in the town, which has also some fishing and shipping industry. There is daily steamer communication with Stettin, about 40 miles south-south west. Kammin is of Wendish origin. From 1175 till 1628 it was the seat of a bishopric, which at the latter date became a secular principality, afterwards incorporated with Brandenburg. Population in 1875, 5499.

**KAMPEN**, a town of Holland, in the province of Overijssel, stretches for nearly a mile along the left bank of the Yssel, about 3½ miles above the mouth of the river. It is connected by railway with Zwolle. The town is traversed in its whole length by a canal, and the old walls have been transformed into promenades and drives. Three of the town gates are good examples of the style of such architecture in the 16th and 17th centuries. Of the seven churches the most noteworthy is St Nicholas, which ranks with the cathedral of Utrecht and St John's of Bois-le-Duc as one of the three great mediæval churches in the Netherlands. The town-hall, dating partly from the 16th century and partly from the 18th, is of interest both from its architecture and decorations and for the value of the archives. There are a theological seminary, a gymnasium, an upper barge school, and a municipal school of design; among the beneficent foundations the most notable is the Great Orphanage. The pasture land of the vicinity fosters a considerable trade in dairy produce; and there are shipyards, rope-walks, a tool factory, cigar factories, paper mills, &c. The inhabitants numbered 7760 in 1840, 11,903 in 1870, and 16,454 in 1876.

Kampen (variously Latinized as *Campyr*, *Campri*, and *Campjanica ad Isulan*) appears as early as 1172, and soon acquired municipal rights. In the 14th century it was the seat of a flourishing cloth manufacture, and as a member of the Hanseatic League it developed a large trade with Denmark and various parts of the Low Countries and Germany. The town was vainly besieged by Duke John of Bavaria in 1400 and by Jan van Ens in 1493. During the great wars of the 16th century it was occupied by the forces of the States in August 1572, a little later captured by Jon Frederick, recovered for the States by Remenbergh in 1578, and attacked without success by Verdugo in 1584. The Munster party obtained possession of Kampen in 1672, but were expelled by the French in 1673.

Kampen is to the Dutch what Gotham is traditionally to the English, or Schilda and Schoppenstahl to the Germans. See F. Moulin, *Histor. Kampen Kronijk*; Havard, *Cities of the Zuider Zee*, 1876.

**KAMPTULICON.** See **FLORR CLOTH**.

**KĀMRŪP**, a district of Assam, India, extending along both banks of the Brahmaputra, between 25° 50' and 26° 53' N. lat., and 90° 40' and 92° 2' E. long., bounded on the N. by Bhutān state, on the E. by Darrang and Nowgong districts, on the S. by the Kāśī hills, and on the W. by Goalpārā district.

The general physical characteristics of Kāmriip are those common to the whole valley of Assam. In the immediate neighbourhood of the Brahmaputra the land is low, and exposed to annual inundation. In this marshy tract reeds



and canes flourish luxuriantly, and the only cultivation is that of rice. At a comparatively short distance from the river banks, the ground begins to rise in undulating knolls towards the mountains of Bhútán on the north, and towards the Khási territory on the south. The hills south of the Brahmaputra in some parts reach the height of 800 feet. It is on the slopes of these hills, amid the primeval jungle, that European planters have set out their trim tea-gardens. The general scenery of Kámrúp is thus agreeably diversified; and the villages are described as very picturesque. The Brahmaputra, which divides the district into two nearly equal portions, is navigable by river steamers and large cargo boats throughout the year, and receives several tributaries navigable by large native boats in the rainy season. The chief of these are the Mòrá, Chául Kboýá, and Barnadi on the north, and the Kúlsí and Dibru on the south bank. Forests cover about 130 square miles of the district, of which 49 square miles have been reserved by the forest department. There is also a plantation reserve, where seedlings of teak, *sál*, *sisu*, *súm*, and *nahor* are reared, and experiments are being made with the caoutchouc tree.

The census of 1871 returned a population of 561,781 (292,688 males and 268,993 females), spread over an area of 3631 square miles. Hindus numbered 514,024; Mahometans, 45,823; Buddhists, 182; Christians, 204, of whom 120 are natives; and "others," 448. Kámrúp is the headquarters of a sect of Vishnuvites, known as Mahápurúshís, who are described as extremely bigoted. The Mahometans are supposed to be the descendants of the early invaders. The native Christian community is under the charge of the American Baptist Mission, which has a station at Gauháti town. The population is entirely rural, the only town with upwards of 5000 inhabitants being Gauháti, with 11,492. The temples of Hajo and Kamákhyá attract many pilgrims from all quarters.

The staple crop of the district is rice, of which there are three crops. The state is the landlord, and the land settlement is made directly with the cultivators. The condition of the cultivators is high, and it is found difficult to obtain labourers for ordinary work. The indigenous manufactures are confined to the weaving of silk and cotton cloths for home use, and to the making of brass cups and plates. The cultivation and manufacture of tea are conducted almost solely by European capital. In 1874 there were twenty-four plantations, with 2638 acres under tea, the out-turn being 375,634 lb. The chief exports are rice, oilseeds, timber, and cotton; the imports are fine rice, salt, piece goods, sugar, betel nuts, cocoa nuts, and hardware. Education in 1872 was afforded by 146 schools, attended by 3969 pupils, including a high school and college in Gunháti town. The mean temperature is 76°, and the average annual rainfall 70.12 inches.

**KAMTHÍ**, or **KAMPTEE**, a large town and cantonment in Nágpur district, Central Provinces, India, 21° 13' 30" N. lat., 79° 14' 30" E. long. Population (1877), 48,831. Considerable trade is carried on here in cattle, country cloth, salt, European piece goods, and timber. The town contains a large market-place, a dispensary, schools, travellers' rest-houses, a Protestant and a Roman Catholic church, five Mahometan mosques, and seventy Hindu temples. An extensive parade ground separates the cantonment from the town, which is built in broad and regular streets.

**KAMUISHIN**, or **KAMYSHIN**, a town of Russia, in the Saratoff government, on the right bank of the Volga, 120 miles south-south-west of Saratoff, on the highway to Astrakhan. The inhabitants carry on a good river-trade in wood, tar, grain, fish, tallow, and garden produce,—the Kamuishin melons especially being sent to various parts of Russia, and forming the raw material for a kind of syrup (*wardk*) manufactured in the town. The population in 1861 was 8644; the St Petersburg calendar for 1873 gives the number as 15,698.

Kamuishin, it is said, was founded in 1668 on the left bank of the Kamuishiuka, for the suppression of the brigandage carried on in the district. Peter I., intending to make a canal from the stream to the Ilovya, erected a fort on its right bank; and in 1710 the inhabitants of the older settlement removed to the same side,

and the town took the name of Dmitrievsk. The present name dates from 1780, when the place became the chief town of a district.

**KANANŪR**, or **CANNANORE**, a town, seaport, and cantonment in Malabar district, Madras, India, 11° 51' 12" N. lat., 75° 24' 44" E. long., with a population in 1871 of 10,265. The sea-borne trade in 1875-76 amounted to £220,244 value of imports, and £115,248 of exports. Anglican, German, and Roman Catholic missions are established in the town. Kananúr belonged to the Kalahasti or Cherakal rájás till the invasion of Malabá by Hyder Ali. In 1498 a Portuguese colony was planted there by Cabral, and seven years later a factory was established by Vasco da Gama. In 1656 the Dutch effected a settlement and built the present fort, which fell into the hands of the Mysore troops in 1766. In 1784 Kananúr was captured by the British, and the reigning princess became tributary to the East India Company. From 1791 it has been the principal British military station on the Malabar coast.

**KÁNARA**, or **CANARA**, **NORTH**, the most southerly of the coast districts of Bombay, India, lying between 13° 52' and 15° 31' N. lat., and between 74° 10' and 75° 7' E. long., bounded on the N. by Belgaum, E. by Dhárwár and Mysore, S. by South Kánara, W. by the Arabian sea and N.W. by the Portuguese territory of Goa, with an area of 4235 square miles. The chief town is Kárwár. The main feature in the physical geography of the district is the Sahyádrí range of the Western Gháts, which, running from north to south, divides it into two parts, a lowland or coast strip (Payanghát), and an upland plateau (Bálághát). The coast-line is only broken by the Kárwár headland in the north, and by the estuaries of four rivers and the mouths of many smaller streams, through which the salt water finds an entrance into numerous lagoons winding several miles inland. The breadth of the lowlands varies from 5 to 15 miles. From this narrow belt rise a few smooth, flat-backed hills, from 200 to 300 feet high; and at places it is crossed by lofty, rugged, densely wooded spurs, which, starting from the main range of the Sahyádrí hills, maintain almost to the coast a height of not less than 1000 feet. Among these hills lie well-tilled valleys of garden and rice land. The plateau of the Bálághát is irregular, varying from 1500 to 2000 feet in height. In some parts the country rises into well-wooded knolls, in others it is studded by small, isolated, steep hills. Except on the banks of streams and in the more open glades, the whole is one broad waste of woodland and forest. The open spaces are dotted with hamlets or parcelled out into rice clearings.

Of the rivers flowing eastward from the watershed of the Sahyádrí hills the only one of importance is the Wardha, a tributary of the Tungabhadra. Of those that flow westwards, the four principal ones, proceeding from north to south, are the Káli, Gungawáli, Tadri, and Sbaravati. The last of these, plunging over a cliff 825 feet in height, about 35 miles from Honáwar town, forms the famous Gersoppa falls. The mineral products of the district consist of iron, limestone, and building stone. Extensive forests clothe the Sahyádrí hills, and are conserved under the rules of the forest department. During the ten years 1866-76 they yielded an average annual revenue of £39,307 to the state. Tigers, leopards, bears, deer, and wild hogs are numerous, and small game is plentiful. North Kánara formed part of Madras till 1861, when it was transferred to Bombay presidency.

The census of 1872 returned a population of 393,406 (206,417 males and 191,989 females), 94 to the square mile. The Hindus numbered 364,402; Mahometans, 21,755; Pársis, 25; Christians, 12,189; and Jews, 34. The most noteworthy class among the Hindus are the Havik Bráhmans, who make their livelihood from spice and areca nut gardens. Besides the regular Mahometan population (de-

scendants from Hindu converts to Islám), there are two special classes of foreign Mahometans,—the Naváiyátas or seamen, representatives of early colonies of Arab merchants, and the Sidís or descendants of African slaves formerly owned by the Portuguese. The Christians are nearly all Roman Catholics, a few families of whom are of Portuguese extraction, though much mixed by intermarriage with the natives; the remainder consist of local converts or their descendants.

The area under cultivation is returned at 333,175 acres, or about 12 per cent. of the total area. Rice forms the staple crop, but *rági*, sugar-cane, and sallow are also grown to a considerable extent; and cocoa-nuts, araca-nuts, cardamoms, and pepper are produced in gardens in large quantities for home consumption and for export. Cochineal is largely exported. Coffee is grown only to a small extent. Kárwár, Kumpta, Ankola, Bhatkal, and Honáwar are the most important seaports. The total value of the trade at these in 1876 was £1,841,173, viz., £1,199,077 exports and £642,096 imports. Carving in saulal wood and ebony forms an important industrial art. Salt is largely manufactured under Government supervision. The total revenue of the district in 1876-77 was £165,597, of which the land tax yielded £82,862, and forests £34,231. There were, in 1875-76, 83 schools, attended by 4425 pupils. Fever of a severe type is the prevalent disease, and occasionally rages in an epidemic form. The average annual rainfall on the coast varies from 100 inches at Kárwár to 163 at Kumpta; in the uplands it averages about 72 inches.

**KÁNARA, or CANARA, SOUTH**, a district on the western coast of the Madras presidency, India, bounded on the north by North Kánara (Bombay), E. by Mysore and Coorg, S. by Malabar, and W. by the Indian Ocean, with an area of 3902 square miles. The chief town is Mangalore. The district is intersected with rivers, none of which exceed 100 miles in length. They all take their rise in the Western Gháts, and many of them are navigable for boat traffic during the fair weather for from 15 to 25 miles from the coast. The chief of these streams are the Netravati, Gátpur, and Chendragiri. The general scenery of the district is varied and picturesque. Abundant vegetation, extensive forests, and numerous groves of cocoa-nut palms extend along the coast, and green rice-fields are seen in every valley. The Western Gháts, rising to a height of from 3000 to 6000 feet, fringe the eastern boundary of the district. Forest land of great extent and value exists, but most of it is private property. Jungle products (besides timber) consist of bamboo, cardamoms, wild arrowroot, gall-nuts, gamboge, catechu, fibrous bark, cinnamon, gums, resin, dyes, honey, and beeswax. The forests formerly abounded in game, which, however, is now rapidly decreasing under incessant shooting.

The census of 1871 returned a population of 919,513 (235 to the square mile), of whom 787,183 were Hindus, 82,803 Mahometans, 49,517 Christians, and 10 "others." The only towns with a population exceeding 2000 are Mulki, Udipi, Karikal, Bantwal, and Mangalore. The staple crop is rice. Cocoa-nut gardens are numerous along the coast, and araca plantations in the interior. Gram, beans, hemp, *rági*, sugar-cane, tobacco, and cotton are also grown, but not to any great extent. The chief articles of import consist of piece goods, cotton twist, yarn, oils, and salt. The total value of imports in 1875-76 was £183,250, and the value of the exports £781,672, of which £109,900 represented coffee and £175,000 rice. The total revenue of the district in 1870-71 was £233,776, of which £116,188 was made up by land tax. Education was afforded in 1871 by 193 Government and inspected schools, attended by 4007 pupils.

**KANAUIJ**, an ancient city in Farrukhabad district, North-Western Provinces, India, 27° 2' 30" N. lat., 79° 58' E. long., with a population in 1872 of 17,093, viz., 10,861 Hindus and 6229 Mahometans. Kanauj in early times formed the capital of a great Aryan kingdom, and the Gupta dynasty extended their sway over a large portion of Upper India. The prosperity of the city dates from a prehistoric period, and seems to have culminated about the 6th century. In 1018 it fell before Mahmúd of Ghazni, and again in 1194 before Muhammad Ghorí. The existing ruins extend over the lands of five villages, and occupy a semicircle fully 4 miles in diameter. Among the antiquities the shrine of Bájá Jaijál ranks first in interest. The

great mosque, which bears the name of Sítá's Kitchen, also dates back to Hindu times. Hinduism in Lower Bengal dates its legendary origin from a Bráhman migration southwards from this city, about 800 or 900. To this day all Bráhmans in the lower provinces trace their descent from one or other of the five Bráhman emigrants from Kanauj.

**KANDIHAR**, the largest city in Afghanistan, is situated in 31° 37' N. lat. and 65° 43' E. long., at a height of 3400 feet above the sea. It is 370 miles distant from Herat on the north-west, by Girishk and Farrah,—Girishk being 75 miles, and Farrah 225 miles from Kandahar. From Cabul, on the north-east, it is distant 315 miles, by Khelat-i-Ghilzai and Ghazni,—Khelat-i-Ghilzai being 85 miles, and Ghazni 225 miles from Kandahar. To the Pishin valley the distance is about 110 miles, and from Pishin to India the three principal routes measure approximately as follows:—by the Zhób valley to Dera Ismail Khan, 300 miles; by the Bóri valley to Dera Ghazi Khan, 275 miles; by Quetra and the Bolán to Dadur, 125 miles; and by Chappar and Nari (the proposed railway route) to Sibi, 120 miles. Sibi is connected by rail with the rest of India. Immediately round the city is a plain, highly cultivated and well populated to the south and west; but on the north-west this plain is barren, and is bounded by a double line of rough and precipitous hills, rising to about 1000 feet above its general level, and breaking its dull monotony with irregular lines of scarped precipices, crowned with fantastic pinnacles and peaks. To the north-west these hills form the watershed between the valleys of the Argandab and the Tarnak, until they are lost in the mountain masses of the Hazarajat,—a wild region inhabited by tribes of Tartar origin, which effectually shuts off Kandahar from communication with the north. On the south-west they lose themselves in the sandy desert of Registan, which wraps itself round the plain of Kandahar, and forms another impassable barrier.

But there is a break in these hills,—a gate, as it were, to the great high road between Herat and India; and it is this gate which the fortress of Kandahar so effectually guards, and to which it owes its strategic importance. Other routes there are, open to trade, between Herat and northern India, either following the banks of the Hari Rud, or, more circuitously, through the valley of the Helmand to Cabul; or the line of hills between the Argandab and the Tarnak may be crossed close to Khelat-i-Ghilzai; but of the two former it may be said that they are not ways open to the passage of Afghan armies owing to the hereditary bitterness of hostility existing between the Eimák and Hazára tribes and the Afghans generally, while the latter is not beyond striking distance from Kandahar. The one great high road from Herat and the Persian frontier to India is that which passes by Farrah and crosses the Helmand at Girishk. Between Kandahar and India new and feasible means of communication are being discovered with every geographical search into the intermediate country. To the north-west, and parallel to the long ridges of the Tarnak watershed, stretches the great road to Cabul, the same which was traversed by Nott in 1842, and by Stewart and, more recently, by Roberts in 1880. Between this and the direct route to Pishin is a road, well known, though never yet traversed by a British force, which leads through Maruf to the Kundar river and the Guleri Pass into the plains of Hindustan at Dera Ismail Khan. This is the most direct route to northern India, but it involves the passage of some rough country, where lies the great watershed between the basins of the Helmand and the Indus. But the best known road from Kandahar to India is that which stretches across the series of open stony plains interspersed here and there with rocky hills of irregular formation leading to the foot of the pass across



the Kojak range, on the far side of which from Kandahar lies the valley of Pishin. The passage of the Kojak involves a rise and fall of some 2300 feet, but an excellent road now crosses the pass. The proposed line of railway to Kandahar follows an easier but comparatively waterless route, turning the Kojak at Gwaja (about 25 miles southwest of the Kojak Pass), and involving no serious gradients. Between the Pishin valley and India are several routes, all more or less open to a force equipped for mountain warfare, of which the best known are the Bolán and the Chappar (or Nari) passes from the plateau of Afghanistan to the plains of Sind at Jacobabad; and the Zhób and the Bóri valley routes leading through the Sulimani range to Dera Ismail and Dera Ghazi Khan respectively. The Bori valley was the line followed by Sir M. Biddulph in 1879, and it diverges but slightly from that known as the Thal-Chotiali route. Thus Kandahar becomes a sort of focus of all the direct routes converging from the wide-stretching western frontier of India towards Herat and Persia, and the fortress of Kandahar gives protection on the one hand to trade between Hindustan and Herat, and on the other it lends to Cabul security from Herat invasion.

Kandahar is approximately a square-built city, surrounded by a wall of about  $3\frac{1}{4}$  miles circuit, and from 25 to 30 feet high, with an average breadth of 15 feet. Outside the wall is a ditch 10 feet deep. The city and its defences are entirely mud-built, with no pretensions to architectural beauty. There are four main streets crossing each other nearly at right angles, the central "chouk" being covered with a dome. These streets are wide and bordered with trees, and are flanked by shops with open fronts and verandahs much after the universal fashion of the East. There are no buildings of any great pretension in Kandahar, a few of the more wealthy Hindus occupying the best houses. The tomb of Ahmed Shah is the only attempt at monumental architecture. This, with its rather handsome cupola, and the twelve minor tombs of Ahmed Shah's children grouped around, contains a few good specimens of fretwork and of inlaid inscriptions. The four streets of the city divide it into convenient quarters for the accommodation of its mixed population of Duranis, Ghilzais, Parsiwans, and Kakuris, numbering in all some 30,000 souls. Of these the greater proportion are the Parsiwans (chiefly Kizilbashes).

It is reckoned that there are 1600 shops and 182 mosques in the city. The mullas of these mosques are generally men of considerable power. The walls of the city are pierced by the four principal gates of "Cabul," "Shikarpur," "Herat," and the "Idgah," opposite the four main streets, with two minor gates, called the Top Khana and the Bardurani respectively, in the western half of the city. The Idgah gate passes through the citadel, which is a square built enclosure with sides of about 260 yards in length. The flank defences of the main wall are insufficient; indeed there is no pretence at scientific structure about any part of the defences; but the site of the city is well chosen for defence, and the water supply (drawn by canals from the Argandab or derived from wells) is good.

About 4 miles west of the present city, stretched along the slopes of a rocky ridge, and extending into the plains at its foot, are the ruins of the old city of Kandahar as it existed until it was sacked and plundered by Nadir Shah in 1738. From the top of the ridge a small citadel overlooks the half-buried ruins. On the north-east face of the hill forty steps, cut out of solid limestone, lead upward to a small, dome-roofed recess, which contains some interesting Persian inscriptions cut in relief on the rock, recording particulars of the history of Kandahar, and defining the vast extent of the kingdom of the emperor Baber. Popular belief ascribes the foundation of the old city to Alexander the Great.

Although Kandahar has long ceased to be the seat of government, it is nevertheless by far the most important trade centre in Afghanistan, and the revenues of the Kandahar province assist

largely in supporting the chief power at Cabul. There are no manufactures or industries of any importance peculiar to Kandahar, but the long lines of bazaars display goods from England, Russia, Hindustan, Persia, and Turkestan, embracing a trade area as large probably as that of any city in Asia. The customs and town dues together amount to a sum equal to the land revenue of the Kandahar province, which is of considerable extent, stretching to Pul-i-Sagin, 10 miles south of Kheilat-i-Ghilzai on the Cabul side, to the Helmand on the west, and to the Hazara country on the north. Although Farrah has been governed from Kandahar since 1863, its revenues are not reckoned as a part of those of the province. The land revenue proper is assessed in grain, the salaries of Government officials, pay of soldiers, &c., being disbursed by "barats" or orders for grain at rates fixed by Government, usually about 20 per cent. above the city market prices. The land revenue for the year 1877-78 amounted to 640,000 rupees English. English goods imported from Kurrachee pay upwards of 18 per cent. on their value at Kandahar. By the time they are exposed for sale at Herat they pay upwards of 28 per cent. *ad valorem*. Nevertheless the greater part of the English goods sold at Herat are imported by Kurrachee and Kandahar—a fact which testifies to the great insecurity of trade between Meshhed and Herat. Some of the items included as town dues are curious. For instance, the tariff on animals exposed for sale includes a charge of 5 per cent. *ad valorem* on slave girls, besides a charge of 1 rupee per head. The kidney fat of all sheep and the skins of all goats slaughtered in the public yard are perquisites of Government, the former being used for the manufacture of soap, which, with snuff, is a Government monopoly. The imports consist chiefly of English goods, indigo, cloth, boots, leather, sugar, salt, iron, and copper, from Hindustan, and of shawls, carpets, "barak" (native woollen cloth), pestins (coats made of skins), shoes, silks, opium, and carpets from Meshhed, Herat, and Turkestan. The exports are wool, cotton, madder, cummin seed, asafetida, fruit, silk, and horses. The system of coinage is also curious: 105 English rupees are melted down, and the alloy extracted, leaving 100 rupees worth of silver; 295 more English rupees are then melted, and the molten metal mixed with the 100 rupees silver; and out of this 808 Kandahari rupees are coined. As the Kandahari rupee is worth about 8 anas (half an English rupee) the Government thus realizes a profit of 1 per cent. Government accounts are kept in "Kham" rupees, the "Kham" being worth about five-sixths of a Kandahari rupee; in other words, it about equals the franc, or the Persian "keran." Immediately to the south and west of Kandahar is a stretch of well-irrigated and highly cultivated country, but it is the valley of the Argandab that possesses the chief local wealth of agriculture, and which, from the luxuriant abundance of its orchards and vineyards, offers the most striking scenes of landscape beauty. The wide extent of the pomegranate fields forms a striking feature in the valley,—the pomegranates of Kandahar, with its "sirdar" melons and grapes, being unequalled in quality by any in the East. The vines are grown on artificial banks, probably for want of the necessary wood to trellis them,—the grapes being largely exported in a semi-dried state. Fruit, indeed, besides being largely exported, forms the chief staple of the food supply of the inhabitants throughout Afghanistan. The art of irrigation is so well understood that the water supply is at times exhausted, no river water being allowed to run to waste. The plains about Kandahar are chiefly watered by canals drawn from the Argandab near Baba-wali, and conducted through the same gap in the hills which admits the Herat road. The amount of irrigation and the number of water channels form a considerable impediment to the movement of troops, not only immediately about Kandahar, but in all districts where the main rivers and streams are bordered by green bands of cultivation. Irrigation by "karez" is also largely resorted to. The karez is a system of underground channelling which usually taps a sub-surface water supply at the foot of some of the many rugged and apparently waterless hills which cover the face of the country. The broad nullahs which seam their sides frequently possess a supply of water some distance below the surface which can be tapped by boring. The water is not brought to the surface, but is carried over long distances by an underground channel or drain, which is constructed by sinking shafts at intervals along the required course, and connecting the shafts by tunnelling. The general agricultural products of the country are wheat, barley, pulse, fruit, madder, asafetida, lucerne, clover, and tobacco.

Of the mineral resources of the Kandahar district not much is known, but an abandoned gold mine exists about 2 miles north of the town. Some general idea of the resources of the Kandahar district may be gathered from the fact that it supplied the British troops with everything except luxuries during the entire period of occupation in 1879-81; and that, in spite of the great strain thrown on those resources by the presence of the two armies of Ayub Khao and of General Roberts, and after the total failure of the autumn crops and only a partial harvest the previous spring, the army was fed without great difficulty until the final evacuation, at one-third of the prices paid in Quetta for supplies drawn from India.

Kandahar has a stormy history. Sultan Mahmud of Ghazni took it in the 11th century from the Afghans who then held it. In the beginning of the 13th century it was taken by Jenghiz Khan, and in the 14th by Timur. In 1507 it was captured by the emperor Baber, but shortly afterwards it fell again into Afghan hands, to be retaken by Baber in 1521. Baber's son, Humayun, agreed to cede Kandahar to Persia, but failed to keep his word, and the Persians besieged the place unsuccessfully. Thus it remained in the possession of the Moghuls till 1625, when it was taken by Shah Abbas. Aurungzebe tried to take it in 1649 with 5000 men, but failed. Another attempt in 1652 was equally unsuccessful. It remained in Persian possession till 1709, when it was taken by the Afghans, but was retaken after a two years' siege by Nadir Shah. Nadir Shah was assassinated in 1749, and immediately on hearing the news of his death Ahmed Shah (Abdalli) seized Nadir Shah's treasure at Kandahar, and proclaimed himself king, with the consent, not only of the Afghans, but, strange to say, of the Hazaras and Baluchis as well. He at once changed the site of the city to its present position, and thus founded the Afghan kingdom, with modern Kandahar as its capital. Ahmed Shah died in 1773, and was succeeded by his son Taimur, who died in 1798, and left the throne to his son Zaman Shah. This prince was deposed by his half brother Mahmud, who was in his turn deposed by Shah Suja, the full brother of Zaman Shah. After a short reign Shah Suja was compelled to abdicate from his inability to repress the rising power of Fatch Khan, a Barakzai chief, and he took refuge first with Runjit Singh, who then ruled the Punjab, and finally secured the protection of British power. Afghanistan was now practically dismembered. Mahmud was reinstated by Fatch Khan, whom he appointed his vizier, and whose nephews, Dost Mahommed Khan and Kohn dil Khan, he placed respectively in the governments of Cabul and Kandahar. Fatch Khan was barbarously murdered by Kamrin (Mahmud's son) near Ghazni in 1818; and in retaliation Mahmud himself was driven from power, and the Barakzai clan secured the sovereignty of Afghanistan. While Dost Mahommed held Cabul, Kandahar became temporarily a sort of independent chiefship under two or three of his brothers. In 1839 the cause of Shah Suja was actively supported by the British. Kandahar was occupied, and Shah Suja reinstated on the throne of his ancestors. Dost Mahommed was defeated near Cabul, and after surrender to the British force, was deported into Hindustan. The British army of occupation in southern Afghanistan continued to occupy Kandahar from 1839 till the autumn of 1842, when General Nott marched on Cabul to meet Pollock's advance from Jalalabad. The cantonments near the city, built by Nott's division, were repaired and again occupied by the British army in 1879, when Sher Ali was driven from power by the invasion of Afghanistan, nor were they finally evacuated till the spring of 1881. (T. H. II.')

KĀNDĪ, a town in Marshidābād district, Bengal, India, in 23° 58' N. lat., 88° 5' 1" E. long., with a population in 1872 of 12,016, viz., Hindus, 10,452; Mahometans, 1516; "others," 48. It is the residence of the rajas of Pāikpārā, a wealthy and devout Hindu family. The founder of this family was Gangā Govind Sinh, the *baria* of Warren Hastings, who was born at Kāndī, and retired thither in his old age with an immense fortune. His name has acquired celebrity for the most magnificent *sradhā*, or funeral obsequies, ever performed in Bengal, celebrated in honour of his mother, at a cost, it is said, of £200,000.

KANDY, a town of Ceylon, formerly the capital of a kingdom of the same name, situated towards the heart of the island, at a height of 1713 feet above the sea, 74½ miles by rail from Colombo. It lies round the margin of an artificial lake constructed by the last king of Kandy in 1806, and is beautifully surrounded by hills. The most striking objects of interest are the temples (of which twelve are Buddhist and four Brahman), the tombs of the Kandian kings, and the various buildings of the royal residence, partly allowed to fall into disrepair, partly utilized by the Government. Of the temples the Dalada Malagawa is worthy of particular mention; it claims, as the name indicates, to be in possession of a Buddha tooth. Kandy is the seat of a Government agent and of a district judge, and regular sessions of the criminal court are held in the town. As a municipality (constituted in 1865, and divided into five wards in 1871) it is governed by a body of eight councillors. Among the public buildings and institutions are the Government house or pavilion, erected in 1824, the planters' association, two libraries, an industrial school, and

Trinity College, established in 1857, and reopened in 1871 after being closed for six years. The Church Missionary Society, to which the college owed its existence, began its labours in 1818.

Kandy was occupied by the Portuguese in the 16th century and by the Dutch in 1763; but in both instances the native kings succeeded in shaking off the foreign yoke. The British got possession of the place in 1803, but the garrison afterwards capitulated and were massacred, and it was not till 1814-15 that the king was defeated and dethroned. The British authority was formally established by the convention of March 2, 1815. In 1848, owing to an attempt at rebellion, the town was for a time under martial law.

KANE, ELISHA KENT (1820-1857), American traveller, seicutist, and arctic explorer, was born in Philadelphia, on February 3, 1820, the eldest of seven children. His father was judge of the eastern district of Philadelphia, and through both parents he inherited a mixture of Irish, English, Scotch, and Dutch blood. In his boyhood, in spite of feebleness of body, he was remarkable for his activity, vivacity, and energy. While still at school he showed a fondness for out-door pastime and enterprise, and a decided leaning towards scientific pursuits. Having chosen civil engineering as a profession, he entered the university of Virginia, where he continued to show his taste for science, especially chemistry, mineralogy, and physical geography. A violent attack of heart disease, however, which stuck to him to the end of his life, induced him to abandon engineering and devote himself to the study of medicine. He obtained his doctor's degree in 1842, having already acquired a reputation in physiological research. In 1843 Kane entered the U.S. navy as surgeon, and was appointed to the "Brandywine," commissioned to carry Mr Webster as U.S. minister to China. While the vessel remained at Rio Janeiro the restless and eager Kane made a journey to the skirts of the Andes and explored their geology. Leaving the ship again at Bombay, he indulged his irrepressible exploring proclivities by a journey up country, rejoining his ship at Ceylon. On his arrival at his destination, Macao, he provided a substitute for his post in the embassy, crossed and explored the island of Luzon, visited the mysterious volcano of Taal, and, amid many difficulties, descended its steep crater, bringing up with him specimens of its lava. Finally resigning his position on the embassy, he practised for a time at Whampoa, where he was stricken down by rice fever. In August 1844 he left China, and, returning by India (where he visited the Himalayas), Persia, Syria, Egypt, Greece, Austria, Germany, and Switzerland, reached home in 1846. In May of that year he was ordered to the west coast of Africa, where he visited the kingdom of Dahomey, and caught the African fever, which told severely on his constitution. On his return in April 1847, he exchanged the naval for the military service, and was sent to join the U.S. army in Mexico, where he had some extraordinary adventures in endeavouring to reach his destination, and where he was again laid down with fever. In February 1849 he was presented with a sword by the city of Philadelphia, and in the same year made a visit to the Mediterranean and afterwards to the West Indies. On the fitting out of the first Grinnell expedition, in 1850, to search for Sir John Franklin, Kane was appointed surgeon and naturalist under Lieutenant De Haven, who commanded the two ships, the "Advance" and "Rescue." The expedition left New York on May 22d; and after an absence of sixteen months, during nine of which the ships were ice-bound, they returned without having found any trace of the missing vessels. Kane was in feeble health, but worked on at his narrative of the expedition, which was published in 1854, under the title of *The U.S. Grinnell Expedition in Search of Sir John Franklin*. He also read a paper at the American Geographical Society on an "Open Polar Sea," a chimera



which was to play so important and delusive a rôle in subsequent Arctic explorations. Kane was determined not to give up the search for Franklin, but Government refused all help. In spite of feeble health, he travelled through the States lecturing to obtain funds, and gave up his pay for twenty months. Mr Grinnell again came to the rescue, with the brig "Advance," which was equipped with the help of Mr Peabody and some of the learned societies. It sailed in the end of June 1853, and on August 23d reached 78° 41' in Rensselaer Bay, off the coast of Greenland, where it remained fast during the whole time the expedition was out. During the first winter a sledge party was sent out, and reached 79° 50', though at the expense of terrible sufferings. During the second winter the expedition suffered greatly from want of food and fuel, as well as from scurvy. Still Kane carried on with incessant diligence his scientific observations—magnetic, meteorological, astronomical, and tidal; and the results were afterwards published in the *Smithsonian Contributions to Knowledge*, vols. x.—xiii., 1858. One of the most notable incidents of this expedition was the journey made by Merton, one of the staff, up Kennedy Channel, as far as Cape Independence, in 81° 22' N. lat., whence he saw what he and Kane firmly believed to be an "open polar sea." No doubt a large area of open water was seen, but a permanent open sea in this direction has long ago been proved a myth, though doubtless the constant shiftings of the ice often leave considerable areas of water uncovered at continually shifting points. After the endurance of the greatest hardships, it was finally resolved to abandon the ship, which was done on May 17, 1855, Upernivik being reached after many difficulties on August 5. Kane reached home in October in good health, and set himself at once to write the narrative of his expedition, which was published in 1856. In October of the same year he left Philadelphia for England in search of health. From England he went to Cuba, where he died at Havana on February 16, 1857, at the early age of thirty-seven. Between his first and second arctic voyages, Kane made the acquaintance of the Fox family, the celebrated spiritualists. With one of the daughters, Margaret Fox, he carried on a lengthened correspondence, which was afterwards published by the lady, who declares that they were privately married before Kane left for England. Notwithstanding his weak health, Kane was a man of restless activity and high intelligence, but much of that activity appears to have been wasted. He certainly did a vast amount of work during his short life, but will be remembered mainly for his chivalrous and self-sacrificing but fruitless search for Franklin, during which he appreciably advanced our knowledge of the Arctic area, and made important contributions to physics and biology.

See, besides the works mentioned above, *Biography of F. K. Kane*, by William Elder, 1858; *Life of E. K. Kane and other American Explorers*, by S. M. Smucker; *The Love-Life of Dr Kane, containing the Correspondence and a History of the Engagement and Secret Marriage between E. K. Kane and Margaret Fox*, New York, 1866; "Discoveries of Dr Kane," in *Jour. of the Roy. Geog. Soc.*, vol. xxviii., reprinted in *R. G. S. Arctic Papers* of 1875.

KANEFF, or KANIEFF, a town of Russia, in the Kieff government, on the Dnieper, 141 miles south-east of Kieff. The population, which in 1863 was returned as 6838, was about 8000 in 1879; but neither the trade nor the industry of the place is of importance.

Vsevolod of Kieff founded a church at Kanieff in 1144, and in the latter part of the same century the place was the annual rendezvous of the forces collected to give protection to the merchant ships returning from Greece. In 1880 Poniatofski, to whom it had passed from Stanislaus Augustus, gave the revenues of the town and the site of the royal court to the prior of the Basilians, who assigned them to the Kanieff schools of the brotherhood. The administration of the Boguslaff district was transferred to Kanieff in 1837 and in 1844 the district took the name of that town.

KANGAROO. When Captain Cook, during his first memorable voyage of discovery, was detained, for the purpose of refitting his ship at Endeavour river, on the north-east coast of Australia, a strange-looking animal, entirely unknown to them, was frequently seen by the ship's company; and it is recorded in the annals of the voyage that, on the 14th of July 1770, "Mr Gore, who went out this day with his gun, had the good fortune to kill one of the animals which had been so much the subject of our speculation, . . . and which is called by the natives kangaroo,"<sup>1</sup> a name which, though it does not appear to be now known to any of the aboriginal tribes of the country, has been adopted for this animal in all European languages, with only slight modifications of spelling. With the exception of a passing glimpse in the beginning of the same century by the Dutch traveller Bruyn of some living examples of an allied species, to be referred to presently, this was the first introduction to the civilized world of any member of a group of animals now so familiar. The affinities of the species, skins of which were brought home by Captain Cook and subsequent voyagers, were recognized by Schreber as nearer to the American opossums (then the only known marsupials) than to any other mammals with which zoologists were acquainted, and consequently it was placed by him, in his great work on the Mammalia, then in the course of publication, in the genus *Dilephus*, with *gigantea* for a specific designation, — the latter having been



FIG. 1.—Kangaroo (*Macropus giganteus*)

bestowed upon it by Zimmerman under the impression that it was a huge species of jerboa. Soon afterwards (1791) Dr Shaw very properly formed a new genus for its reception, which he named *Macropus*, in allusion to the peculiar length of its hind foot. By the name thus formed, *Macropus giganteus*, this kind of kangaroo has ever since been known in zoological literature.

Further explorations in Australia and the neighbouring islands have led to the discovery of a very considerable number of species, which are now included in the family *Macropodidae*, one of the subdivisions of the order *Marsupialia*, for the characters of which see MAMMALIA.

The *Macropodidae*, or kangaroos, taken as a whole, form a very well marked family, easily distinguished from the remaining members of the order by their general conformation, and by peculiarities in the structure of their limbs, teeth, and other organs. They vary in size from that of a sheep down to a small rabbit. The head, especially in the larger species, is small, compared with the rest of the body,

<sup>1</sup> Hawkesworth, *Collection of Voyages*, vol. iii. p. 577 (1773).

and tapers forward to the muzzle. The shoulders and fore limbs are feebly developed, and the hind limbs of disproportionate strength and magnitude, which gives them a peculiarly awkward appearance when moving about on all fours, as they occasionally do when feeding. Rapid progression is, however, performed only by the powerful hind limbs, the animal covering the ground by a series of immense bounds, during which the fore part of the body is inclined forwards, and balanced by the long, strong, and tapering tail, which is carried horizontally backwards. When not moving they often assume a perfectly upright position, the tail aiding the two hind legs to form a sort of supporting tripod, and the front limbs dangling by the side of the chest. This position gives full scope for the senses of sight, hearing, and smell to warn of the approach of enemies, from which they save themselves by their bounding flight. The fore paws have five distinct digits, each armed with a strong, curved claw. The foot of the hind limb is quite different, and very peculiar in construction, being extremely long and narrow, and (with only one, lately discovered, exception) without any hallux or great toe. It consists mainly of one very large and strong toe, corresponding to the fourth of the human or other typically developed foot, ending in a strong curved and pointed claw. Close to the outer side of this lies a smaller fifth digit, and to the inner side two excessively slender toes (the second and third), bound together almost to the extremity in a common integument. The two little claws of these toes, projecting together from the skin, may be of use in scratching and cleaning the fur of the animal, but the toes must have quite lost all connexion with the functions of support or progression.

The dental formula, when completely developed, is incisors  $\frac{3}{2}$ , canines  $\frac{1}{1}$ , premolars  $\frac{2}{2}$ , molars  $\frac{4}{4}$  on each side, giving a total of thirty-four teeth. The three incisors of the upper jaw are arranged in a continuous arched series,

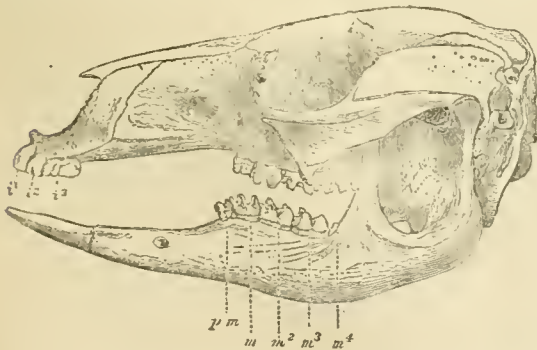

FIG. 3.—Skull and teeth of Bennett's Kangaroo (*Macropus benettii*).  $i^1, i^2, i^3$ , first, second, and third upper incisors:  $p^1, p^2, p^3$ , second or posterior premolar (the first having been already shed);  $m^1, m^2, m^3, m^4$ , the four true molars. The last, not fully developed, is nearly concealed by the ascending ramus of the jaw.

and have crowns with broad cutting edges; the first or middle incisor is often larger than the others. Corresponding to these in the lower jaw is but one tooth on each side, but it is of great size, procumbent or directed



FIG. 2.—Skeleton of hind foot of Kangaroo.

horizontally forwards, narrow, lanceolate, pointed, and with sharp edges. Owing to the laxity of the union of the two rami of the lower jaw at the symphysis, in many species the two lower incisors can be made to work together like the blades of a pair of scissors, a very remarkable arrangement not known to occur in other mammals. The canines are absent or rudimentary, always so in the lower jaw, and often deciduous at an early age in the upper jaw. The premolars are compressed, with cutting longitudinal edges, the anterior one is always deciduous, being lost about the time the second one replaces the milk molar, so that both premolars are never found in place and use in the same individual. The true molars have quadrate crowns, provided with two strong transverse ridges, or with four obtuse cusps. In *Macropus giganteus* and its immediate allies, both premolars and one or two of the anterior true molars are shed during the lifetime of the animal, so that in old examples only the two posterior molars and the incisors are found in place. The milk dentition, as in other marsupials, is confined to a single molar tooth on each side of each jaw, the other molars and incisors being never changed. The dentition of the kangaroos, functionally considered, thus consists of sharp-edged incisors, most fully developed near the median line of the mouth, for the purpose of cropping the various kinds of herbage on which they feed, and ridged and tuberculated molars for crushing it, there being no tusks or canines for offensive or defensive purposes.

The number of vertebrae is—in the cervical region 7, dorsal 13, lumbar 6, sacral 2, caudal varying according to the length of the tail, but generally from 21 to 25. In the fore limb the clavicle and the radius and ulna are well developed, allowing of considerable freedom of motion of the hand. The pelvis has large epipubic or "marsupial" bones. The femur is short, and the tibia and fibula of great length, as is the foot, the whole of which is applied to the ground when the animal is at rest in the upright position.

The stomach is of large size, and very complex, its walls being puckered up by longitudinal muscular bands into a great number of sacculi, like those of the human colon. The alimentary canal is long, and the caecum well developed. All the species have a marsupium or pouch formed by a fold of the skin of the abdomen, covering the mammary glands with their four nipples. In this pouch the young (which, as in other marsupials, leave the uterus in an extremely small and imperfect condition) are placed as soon as they are born; there their growth and development proceeds; and to it they resort temporarily for the purpose of shelter, concealment, or transport, for some time after they are able to run and jump about the ground and feed upon the same herbage which forms the nourishment of the parent. During the early period of their sojourn in the pouch, the blind, naked, helpless young creatures (which in the great kangaroo scarcely exceed an inch in length) are attached by their mouths to the nipple of the mother, and are fed by milk injected into their stomach by the contraction of the muscle covering the mammary gland. In this stage of their existence the respiratory organs are modified much as they are permanently in the *Cetacea*, the elongated upper part of the larynx projecting into the posterior nares, and so maintaining a free communication between the lungs and the external surface, independently of the mouth and gullet, thus averting all danger of suffocation while the milk is passing down the latter passage.

The kangaroos are all vegetable feeders, browsing on grass and various kinds of herbage, the smaller species also eating roots. They are naturally timid, inoffensive creatures, but the larger ones when hard pressed will turn



and defend themselves, sometimes killing a dog by grasping it in their fore paws, and inflicting terrible wounds with the sharp claws of their powerful hind legs, sustaining themselves meanwhile upon the tail. The great majority are inhabitants of Australia and Tasmania, forming one of the most prominent and characteristic features of the fauna of these lands, and in the scenery of the country, as well as the economy of nature, performing the part of the deer and antelopes of other parts of the world, which are entirely wanting in Australia. They were very important sources of food-supply to the natives, and are hunted by the colonists, both for sport and with a view to their destruction, on account of the damage they naturally do in consuming the grass, now required for feeding cattle and sheep. Notwithstanding this, they have in some districts increased in numbers, owing to the suppression of their former enemies, the aborigines and the dingo or native dog. A few species are found in New Guinea and the adjacent islands, which belong, in the zoological sense, to the Australian province, beyond the bounds of which none have been found either existing or in a fossil state.

The *Macropodidae* are divided into two well-marked sections—(1) the true kangaroos (*Macropodinae*), and (2) a group consisting of smaller animals, commonly called rat-kangaroos, or (improperly) "kangaroo-rats," or sometimes potoroos.

I. In the *Macropodinae* (see fig. 3) the cutting edges of the upper incisors are nearly level, or the first pair but slightly longer than the others. The canines are rudimentary and often wanting. The premolars are usually not longer (from before backwards) than the true molars, and less compressed than in the next section. The crowns of the molars have always two prominent transverse ridges. The fore limbs are small with subequal toes, armed with strong, moderately long, curved claws. Hind limbs very long and strongly male. Head small, with more or less elongated muzzle. Ears generally rather long and ovate.

Upwards of thirty species of this group have been described, and many attempts have been made to subdivide it into smaller groups or genera for the convenience of arrangement and description, but these have generally been based upon such trivial characters that it is preferable to speak of most of them as sections of the genus *Macropus*, reserving generic rank only to two forms somewhat aberrant both in structure and geographical distribution. According to this arrangement the genera will be as follows:—

1. *Macropus*, Shaw, divided into the following sections or sub-genera. A. *Macropus* proper, of which the type is *M. giganteus*, spoken of at the beginning of this article as having been discovered in 1770 by the first English explorers of Australia. It is the common great kangaroo, called "boomer," "forrester," or "old man" by the colonists, and frequents the open grassy plains of the greater part of eastern Australia and Tasmania. Some closely allied species or perhaps local varieties, *M. ocydromus*, *M. fuliginosus*, and *M. melanops*, are found in southern and western Australia. B. *Osphranter*, Gould, distinguished from the above by the naked muffle, includes some very large and handsome species, which principally dwell in rocky mountain ranges, as the great red kangaroo, *M. rufus*, *M. antilopinus*, and *M. robustus*. C. *Halmaturus*, F. Cuv. The kangaroos of this section have also the muffle naked, but they are rather smaller species, frequenters of forests and dense impenetrable brushes and scrubs, and hence often called brush kangaroos, though a native name "wallaby" is now generally applied to them. There are many species, of which *M. bennettii*, *M. ruficollis*, *M. ualabatus*, *M. dorsalis*, *M. agilis*, *M. derbianus*, *M. thetidis*, *M. billantieri* are the best known. *M. brachyurus* is remarkable for its comparatively short and slender tail and small ears. The earliest known species of kangaroo, referred to ootore, *M. brunii* (Schreber), may perhaps belong to this section. Several examples were seen by Bruyn in 1711 living in captivity in the garden of the Dutch governor of Batavia, and described and figured in the account of his travels (*Reizen over Moskovic, &c.*) under the name of "Filander." It was quite lost sight of, and its name even transferred by S. Müller to another species (now known as *Dorcopsis mülleri*, Schlegel) until rediscovered in 1865 by Rosenberg, who sent a series of specimens to the Leyden Museum from the islands of Ara and Great Key, thus determining its true habitat. Quite recently three other species of true kangaroo have been discovered out of Australia:—*M. papuanus*, Peters, from the eastern extremity of New Guinea, near Yule Island; *M. crassipes*, Pierson-Ramsay, from near Port Moresby; and *M. browni*, Pierson-Ramsay, from New Ireland. D. *Onychocalca*, Gould, with a hairy muffle and long and slender tail, furnished with a horny-nail-like organ at the apex. *M. vaguifer*, *M. franatus*, and *M. lunatus*. E. *Lagorchestes*, Gould, hare-kangaroos, a group of small hare-like animals, great leapers

and swift runners, which mostly affect the open grassy ridges, particularly those of a stony character, sleeping in forms or seats like the common hare. Their limbs are comparatively small, their claws sharp and slender, and their muffle clothed with velvet-like hairs. *M. fasciatus*, *M. leporoides*, *M. robustus*, *M. conspicillatus*, &c. F. *Petrogale*, Gray. These differ from all the others in having the tail cylindrical and bushy towards the apex instead of tapering. The muffle is naked, the hind foot comparatively short and stout, and densely clothed with coarse hairs, the nails short. These are the "rock kangaroos," making their retreats in caverns and crevices, leaping with surprising agility from one narrow ledge to another, and browsing upon the scanty herbage that the neighbourhood of such situations affords. *M. xanthopus*, *M. penicillatus*, *M. lateralis*, *M. concinnus*, *M. brachyotus*, *M. inornatus*, &c.

2. *Dendrolagus*, Sal. Muller.—A genus formed for the reception of two species, *D. ursinus* and *D. inustus*, commonly known as "tree kangaroos," both inhabitants of New Guinea, and which differ greatly from all the foregoing in being chiefly arboreal in their habits, climbing with facility among the branches of large trees, and feeding on the bark, leaves, and fruit. In accordance with this habit their hinder limbs are comparatively shorter than in the true kangaroos, and their fore limbs are longer and more robust, and have very strong, curved and pointed claws. These differ from all the preceding, and agree with the next genus, in some details of the structure of the molar teeth, and in the circumstance that the fur of the back of the neck is directed forwards or in a reverse position to that of the remainder of the coat.

3. *Dorcopsis*, S. Muller.—Of this genus two species are at present known, both from New Guinea, *D. mülleri*, and another lately discovered by D'Alberty, *D. luctuosa*. In some respects they resemble the last, but they differ from them and all the other *Macropodinae*, and agree with the next section, in the great size and peculiar form of the pre-molar teeth.

II. The second section or sub-family, the *Hypsiprymninae* (see fig. 4), have the first upper incisor narrow, curved, and much exceeding the others in length. Upper canines always persistent, flattened, blunt, and slightly curved. Premolars of both jaws always with large, simple, compressed crowns, with a nearly straight or slightly

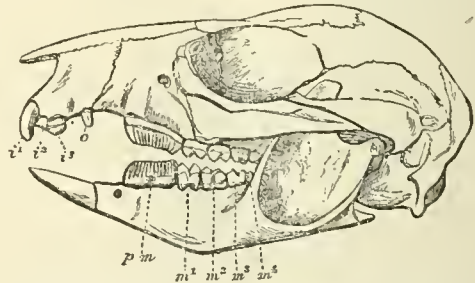

FIG. 4.—Skull and teeth of Gray's Rat Kangaroo (*Bettongia grayii*). c, upper canine tooth. The other letters as in fig. 3.

concave free cutting edge, both outer and inner surfaces usually marked by a series of parallel, vertical grooves and ridges. Molars with quadrate crowns, having a blunt, conical cusp at each corner, the fourth notably smaller than the third, sometimes rudimentary or absent. Fore feet narrow; three middle toes considerably exceeding the first and fifth in length; their claws long, compressed, and but slightly curved. Hind feet as in *Macropus*. Tail long, sometimes partially prehensile, being used for carrying bundles of grass with which they build their nests.

The potoroos or rat-kangaroos are all small animals, none of them exceeding a common rabbit in size. They inhabit Australia and Tasmania, are nocturnal, and feed on the leaves of various kinds of grasses and other plants, as well as roots and bulbs, which they dig up with their fore paws. About ten species are known, presenting a considerable range of diversity in minor characters, and admitting of being grouped in four principal sections, which may perhaps be allowed the rank of genera. These are

1. *Hypsiprymnus*, Illiger.—Head long and slender. Auditory bullae somewhat inflated. Ridges on pre-molars few and perpendicular. Large palatine foramina. Tarsus short. Muffle naked. *H. murinus*, *H. apicalis*, *H. gilberti*, *H. platyops*.

2. *Bettongia*, Gray. Head comparatively short and broad. Auditory bullae much inflated. Tarsus long. Large palatine foramina. Ridges on pre-molars numerous and oblique. Muffle naked. *B. penicillatus*, *B. cuniculus*, *B. gaimardii*, *B. ogilbyi*, *B. grayii*, *B. campestris*, &c.

3. *Epiprymnus*, Garrod.—Head short and broad. Auditory bullae not inflated. No palatine foramina. Tarsus long. Muffle hairy. *E. rufescens*.

4. *Hypsiprymnodon*, Pierson-Ramsay.—Distinguished from all other members of the family by possessing a small prehensile hallux or first toe, without nail. It is, therefore, a form of great interest, as showing a structure of foot connecting that of the kangaroos with that of the phalangians. The single known species, *H. moschatius*, Ramsay, has been lately discovered in north-east Australia. It was described almost simultaneously by Owen under the name of *Pleopus nudicaudatus*.

In seeking among the other marsupials for the nearest allies to the kangaroos, using this word in the comprehensive sense as above, two most striking points in their organization must be borne in mind, the structure of the hind foot and the dentition. Of the former the essential peculiarity is the great predominance of the fourth digit, and the remarkable character of the second and third, which while retaining a considerable length, are of extreme tenacity, and buried up to, the claws in a common integument. Such a structure of foot is quite unknown out of the marsupial order, but in that order it is found in the *Phalangistidae* in a very modified form, associated with a large opposable hallux, and a broad sole of the foot, appropriate for climbing trees; and again, in almost the same form as in the kangaroos, in the ground-dwelling *Peramelidae*, which in their dentition and digestive organs are so widely different. The Australian carnivorous marsupials, *Dasyuridae*, and the American opossums or *Didelphidae*, show no trace of this singular conformation. It is therefore only with the former families, the *Phalangistidae* and the *Peramelidae*, that the kangaroos are allied by this character.

The chief peculiarity of the dentition consists in the presence of three pairs of incisors in the upper jaw, the first or middle one of which is generally the largest, opposed to a single pair in the lower jaw, strong, sharp, and prominent. These are followed by an interval, in which may be, in the upper jaw only, a canine, but always so small, as to be of little functional importance. The premolars are compressed and cutting, and the true molars ridged or tuberculated. Such a dentition is found among the *Phalangistidae* alone of existing marsupials. In this respect the *Peramelidae* are completely separated from the kangaroos, their numerous small incisors, large canines, and cuspidated molars resembling those of the *Dasyuridae* and *Didelphidae*. On the whole then, the kangaroos and the phalangians are groups most nearly allied in essential characters, having both dentition and extremities formed upon the same fundamental type, though with modifications of the latter to suit their respective terrestrial and arboreal habits.

Remains of numerous extinct species of true kangaroos, many of them of much larger size than any now existing, are abundant in the Pleistocene deposits of Australia, and have been described and figured by Professor Owen in the *Philosophical Transactions*. Hitherto they have been found in no other part of the world. Other animals of gigantic size, the *Diprotodon*, as large as a rhinoceros, and the *Nototherium*, but little inferior, with dentition of the same general type, but the structure of whose feet is not yet known, lived with these kangaroos in the same land. An extraordinary modification of the *Hypsiprymnus* type, with the great premolar characteristic of that genus immensely exaggerated in size, and the true molars equally reduced, misnamed *Thylacoleo carnifer*, was another contemporary. Beyond these, which all belong to the most recent geological epoch, we have no knowledge of any extinct animals which can be said to be nearly allied to kangaroos, or to connect them with any other forms of mammals. The only marsupials discovered in European Tertiary resemble the existing opossums of America, and except in their common marsupial characters have no affinities with the kangaroos.

It is, however, a most remarkable fact that in the Pur-

beck basin of the newer Oolitic series, not only in England, but also in deposits of corresponding age in America, lower jaws of small mammals (to which Dr Falconer gave the name of *Plagiaulax*), with a type of dentition showing a considerable resemblance to that described above as peculiar to the kangaroos and their existing allies, have been discovered. Unfortunately no part of the skull or upper teeth, or of the limbs of any of these is as yet known; so whether the resemblance was fully carried out, even in the dentition, is uncertain, and it is almost too great a stretch of the imagination to assume that the modern "diprotodont" marsupials have derived their special type of tooth-structure from such remote ancestry. The evidence of the affinity of the still more ancient *Hypsiprymnopsis* (Boyd Dawkins), founded upon a single and much worn tooth, having some resemblance to one of the large premolars of *Hypsiprymnus*, found in the infra-Liassic beds of Watchet in Somersetshire, is based on still slighter foundation; but, if it should eventually turn out to be well grounded, it would carry back the type to an extraordinary antiquity.

*Literature*.—G. R. Waterhouse, *Nat. Hist. of the Mammalia*, vol. 1, "Marsupialia," 1846; J. Gould, *Mammals of Australia*; R. Owen, article "Marsupialia" in *Cyclop. of Anatomy and Physiology*; various memoirs "On Extinct Mammals of Australia" in *Philosophical Transactions*; "Mesozoic Mammalia," *Paleontographical Society*, 1871; H. Falconer, "On *Plagiaulax*," *Quart. Journ. Geol. Soc.*, August 1857 and November 1862; W. H. Flower, "On the Development and Succession of the Teeth in the Marsupialia," *Phil. Trans.*, 1867; "On the Affinities and Probable Habits of *Thylacoleo*," *Quart. Journ. Geol. Soc.*, August, 1868; A. H. Garrod, "On *Dorcopsis luctuosa* and its Affinities," *Proc. Zool. Soc.*, 1875, p. 48. (W. H. F.)

KĀNGRA, a district in the lieutenant-governorship of the Punjab, India, lying between 31° 20' and 33° N. lat., and between 75° 39' and 78° 55' E. long., bounded on the N.W. by Gurdaspur district and Chamba state, on the N.E. by the Himālaya mountains, on the S.E. by the states of Bashahr, Mandi, and Bilāspur, and on the S.W. by Hoshiarpur district, with an area of 8988 square miles. Kāngra district comprises a vast tract, extending eastward from the plain country of the Bāri and Jalandhar Doābs, across two distinct Himālayan ranges, far into the heart of Thibet. It naturally falls into three parts—the sub-Himālayan country of Kāngra proper, the central valleys of Kullu and Bangāhal, and the rugged outer region of the Tibetan slope. It consists almost entirely of immense mountain ranges, whose three parallel lines, with a transverse ridge, form four main basins, in each of which a great river takes its rise—the Beas (Biās), Spiti, Chenāb, and Rāvi. From the great variety of the different tracts included in the district by modern arrangements, it is impossible to assign any general physical peculiarities to the whole beyond their common characteristic as mountainous regions, intersected by snowy chains and scored by deep river valleys. The western portion, abutting on the Punjab plains, admits of cultivation, and supports a comparatively dense population; while the bare and sterile eastern glens are sparsely inhabited by a Tibetan race.

The census of 1868 disclosed a population of 743,882 (393,571 males and 350,311 females),—82 to the square mile. The Hindus numbered 693,506; Mahometans, 48,618; Sikhs, 1314; Christians, 277; and "others," 173. The six municipal towns with their population are—Nūrpur, 7151; Kāngra, 6344; Harijpur, 3839; Sujarpur Tira, 3393; Jawāla-makhi, 2847; Dharmisala, 2024. The famous Hindu temple of Nāgarokot at Kāngra town is one of the oldest and most wealthy shrines in India, and twice exposed the district to the plunder of the Mahometans.

The cultivated area of the district is returned at 681 square miles, or less than one-thirtieth of the entire surface. The staple crops include wheat and barley for the spring, and rice and maize for the autumn harvest. Rice is the principal crop of the upper valleys, while maize composes the ordinary food of the upland people for six months of the year. Sugar-cane covers a large area in the neighbourhood of Kāngra town. Tea cultivation has taken root as an important industry, both in Kāngra proper and in



Kullu. In 1872-73 the district contained twenty-eight plantations, producing a gross out-turn of 428,655 lb of tea, valued at £65,000. Potatoes also constitute a considerable crop. In Lāhul and Spiti barley is the agricultural staple; but the former tract does not grow a sufficient quantity of grain for its own consumption, being largely supplied by importations from Kullu.

Agricultural produce forms the staple of the export trade; the imports consist of grain, cotton, tobacco, and European piece goods. The Pālampur fair, established by Government with a view to fostering commerce with Central Asia, draws together a small concourse of Yākandi merchants. The Lāhulis carry on an enterprising trade with Ladākh and countries beyond the frontier, by means of pack sheep and goats. The total imperial revenue in 1872-73 amounted to £71,434, of which the land-tax contributed £62,443. Crime is rare, but education is still in a very backward state, only 2936 children being under instruction in 1872-73. The endemic diseases of the district include fever and goitre, but scurvy also prevails to a large extent. The widespread cultivation of rice, by which the whole Kāngra valley is converted into a swamp, has a very prejudicial effect upon the general health. The average annual rainfall varies from 148 inches at Dharmśāla to 76 at Kāngra, 62 at Hamīrpur, and 108 at Pālampur. The mean temperature in the Himalayan station of Dharmśāla in 1874-75 was 70°·35 in May, 73°·5 in July, and 52°·85 in December.

KANIZSA, NAGY (*i.e.*, "Great"), a market-town of Hungary, in the trans-Danubian county of Zala, lies 31 miles north-north-east of Kopeřnitz, and at the junction of the lines of railway from Sopron (Oedenburg) and Szekesfehervár (Stullweissenburg), 46° 28' N. lat., 17° 0' E. long. Among the public and other buildings are a fine Roman Catholic church, a Franciscan monastery, a Piarist gymnasium, a town-hall, royal and magisterial courts of law, and the usual Government offices. In the neighbourhood are the distilleries and brick-making factories. The markets periodically held in the town are much frequented, and the trade in grain, horned cattle, and pigs is generally brisk. The population at the end of 1880 was 18,393.

Nagy-Kanizsa once ranked as the second fortress of Hungary, and consequently played an important part during the wars with the Turks, who, having gained possession of it in 1600, held it until near the close of the 17th century. In 1690, after a siege of two years, it was recovered by the Austrian and Hungarian forces. Its reversion to Hungary was ratified by the treaty of Carlowitz (1699). In 1702 the fortifications were destroyed, and there are now but few traces of their former existence.

KANKAKEE, the chief city and county seat of Kankakee county, Illinois, U.S., is situated on the north bank of the Kankakee river, 56 miles south of Chicago. It is the centre of a very rich and fertile farming district, and has a large trade in agricultural produce. It has fine water-power, and, being within easy reach of extensive coal-fields and deposits of bog-iron ore, does a large manufacturing business. The population of the city and township in 1880 was 5652.

KANO, a town of central Africa, at the head of a province of the kingdom of Sokoto, about 230 miles east of Sokoto and 360 miles west of Kuka. The circuit of the walls is upwards of 15 English miles; but little more than a third of the enclosed area was actually occupied at the time of Barth's visit. The oldest part of the town is that which lies at the foot of the hill Dalá (120 feet), and from this the inhabited portion stretches south for 2½ miles to the walls. To the south of the great market-place lies a deep pond, Jakara, upwards of a mile and a half in length. Two kinds of dwelling-houses are common—square-shaped clay-built structures with flat roofs, and round huts with conical tops. The population, estimated at 30,000, consists of Fellatah, Kanuri (Bornuese), Houssas, and Nupe. Commerce and manufactures go hand in hand, and every family has its share in each. Cotton cloth, woven and dyed in the town, forms a chief article of trade; and to this may be added sandals and shoes, twisted leather straps, and *jebiras* (purses of a peculiar make), kola-nuts, and slaves. About 20,000 loads of natron pass through the town in a year from Bornu to Nupe.

See Clapperton's *Travels*, vol. ii.; and Barth, *Travels in North and Central Africa*, vol. ii. The latter gives a sketch plan of Kano.

KANSAS, the central State of the American Union, lies Plate XIII between 37° and 40° N. lat. and between 94° 38' and 102° W. long. It is bounded on the N. by Nebraska, on the E. by Missouri, on the S. by Indian territory, and on the W. by Colorado. The State is nearly rectangular in shape, with a breadth of about 210 miles from north to south, and a length of 400 miles from east to west. It contains an area of 81,318 square miles, or 52,043,520 acres.

Kansas is an undulating plain, gently sloping from west to east, at an average of nearly 7 feet per mile. There is also an inclination from north to south, as indicated by the course of the rivers, which flow southerly as well as easterly, but never northerly or westerly, except for short distances from local causes. The mouth of the Kansas river, at the east line of the State, is 750 feet above the sea-level; the average altitude of the western boundary is about 3500 feet. The broad prairie surface is diversified by an endless succession of valleys and woodlands. The great central valley is traversed by the Kansas or Kaw river, which, inclusive of the Smokyhill branch, extends the entire length of the State. Lateral valleys on the north are formed by the Saline, Solomon, Republican, and Blue rivers, and other smaller streams. Another broad valley is formed in the southern half of the State by the Arkansas river, with lateral valleys on the north, traversed by the Walnut, Little Arkansas, Pawnee Fork, and other streams. The south-eastern portion contains the important Neosho valley, and the smaller valleys of the Osage and Verdigris. In the extreme south-west and along the southern boundary are the valley of the Cimarron, and a network of the southern tributaries of the Arkansas. Numerous small affluents of the Missouri enrich and diversify the north-eastern quarter of the State. The streams of Kansas are usually fed by perennial springs, and, as a rule, the eastern and middle portions of the State are well watered. The western part is more elevated, and water is less abundant.

*Geology and Minerals.*—The surface presents three distinct geological sections. The eastern portion of the State belongs to the Carboniferous system, in which are found inexhaustible beds of valuable bituminous coal, often at shallow depths or cropping out on the surface. The central portion belongs to the Triassic formation, with magnesian limestone, ferruginous sandstone, and gypsum as the representative rocks. Magnesian limestone, known as dolomite, is especially plentiful along the Blue, Republican, and Neosho rivers and their tributaries. This beautiful stone, resembling white, grey, and cream-coloured marble, is exceedingly useful for building purposes. It crops out in the bluffs in endless quantities, and is easily worked. The western portion of the State belongs to the Cretaceous formation, in which chalks and a species of native quicklime are very prominent in the river bluffs. The white and cream-coloured chalks are much used for building purposes, but the blue is usually too soft for exposure to the weather. The quicklime as quarried from the bluffs slakes perfectly, and with sand makes a fairly good mortar, without calcination or other previous preparations. Lead-mines are extensively worked in the south-eastern portion of the State, and prosperous towns and cities are growing up in connexion with these mines. In the central region, salt is produced from wells, and appears in occasional marshes. Salt industries are carried on at Solomon City, near the mouth of the Solomon river, and an excellent brine is obtained at Junction City. The salt of the south-west is found in beds and dry incrustations, varying in thickness from a few inches to 2 feet. The salts of Kansas are remarkably free from lime and other im-

purities. Gypsum is found in beautiful crystalline form in extensive quarries, but it has not been much utilized. The lignite found near the Colorado line makes a valuable domestic fuel.

*Climate.*—The climate of Kansas is exceptionally salubrious. Extremes of heat and cold occur, as in all open prairie countries, but as a rule the winters are dry and mild, while the summer heats are tempered by the perpetual prairie breezes. The summer nights are invariably cool and refreshing. The mean annual temperature at Fort Riley for twenty-three years ending December 1874 has been 53°. The highest temperature there during the same period was 98° and the lowest 12° below zero. The average annual rainfall at the city of Lawrence for six years (1875-1880) was 32.68 inches, the heaviest rainfalls occurring in May, June, July, and August, the lightest in November, December, January, and February.

*Soil.*—The soil of the upland prairies is generally a deep rich clay loam, of a dark colour. The bottom lands near the streams are a black sandy loam; and the intermediate lands, or "second bottoms," show a rich and deep black loam, containing very little sand. These soils are all easily cultivated, free from stones, and exceedingly productive. There are exceptional spots on the upland prairies composed of stiff clay, not as easily cultivated, but very productive when properly managed and enriched. In the early history of the country the prairies were covered with the short "buffalo grass," very nutritious for pasturage, on which immense herds of buffalo and other animals subsisted, but utterly unfit for hay. With the disappearance of the buffalo, and as the country is settled and cultivated, the short buffalo grass gives place to the tall blue stem and other bladed grasses valuable alike for pasture and for hay. Timber is abundant along the streams in the eastern section of the State, but is less plentiful in the central portion, and very scarce in some parts of the west. The varieties of timber embrace oak, elm, black walnut, cottonwood, mulberry, box, elder, willow, hickory, sycamore, white ash, and other hard and soft woods.

*Agriculture.*—The farm products of 1880 were as follows:—Indian corn, 101,420,718 bushels; winter wheat, 23,507,223; spring wheat, 1,772,661; rye, 676,507; oats, 11,483,796; barley, 287,057; buckwheat, 43,455; Irish potatoes, 4,919,227; sweet potatoes, 391,196; castor beans, 558,974; flax seed, 1,245,279; sorghum syrup, 3,787,585 gallons; cotton, 142,517 lb; hemp, 635,872 lb; millet and Hungarian hay, 629,084 tons; Timothy hay, 79,634 tons; hay from wild or native grasses, 798,707 tons; clover pasture, 5927 acres; blue grass pasture, 33,259 acres; native grass pasture, 901,125 acres; produce of market gardens to the value of \$449,797.

The bright climate and pure atmosphere are admirably adapted to the growth of the apple, pear, peach, plum, grape, and cherry. The smaller fruits also, with scarce an exception, flourish finely. Trees never suffer from sodden or water-soaked roots, and very seldom from the winter's cold, when reasonable judgment and care have been exercised in selecting and managing the grounds. At a national exhibition in Philadelphia in 1869 the great gold medal of the National Pomological Society was awarded to Kansas "for a collection of fruits unsurpassed for size, perfection, and flavour;" and similar awards have been made to Kansas fruits at later exhibitions. In November 1872 the American Institute, at its great show, awarded a diploma for 190 varieties of apples grown in Kansas, as the largest and handsomest exhibited. At the International Exhibition at Philadelphia in 1876, Kansas exhibited ninety-six varieties of apples, and received the diploma of the centennial commission. Estimates based on the tables of 1877 indicate that the number of bearing trees now in the State (1881) is about as follows:—2,500,000 apple, 100,000 pear, 8,000,000 peach, 200,000 plum, and 1,000,000 cherry trees. The planting of trees is still on the increase, and the older orchards are very profitable. The same is true of vineyards and plantations of small fruits.

*Livestock.*—The wide prairies, with their nutritious grasses for hay and grazing and their never-failing springs of pure water, make the State a very paradise to the herdsman and stock-raiser. The following are the statistics for 1880:—horses, 367,589; mules and asses, 58,303; milch cows, 366,640; other horned cattle, 748,672; sheep, 422,442; swine, 1,281,000; value of animals slaughtered

and sold for slaughter, \$12,700,045; value of poultry and eggs sold, \$331,550; wool (clip of 1878), 289,644 lb; wool (1879), 1,194,453 lb; honey (produce of 1879), 370,398 lb; wax (1879), 10,949 lb. The great herds of buffalo which formerly overran the plains have disappeared, the elk is gone, and deer and other game are less plentiful than formerly. There remain, however, the rabbit, hare, turkey, prairie hen, quail, and the usual variety of migratory water-fowl, to gratify the sportsman. The numerous streams are well supplied with fish of choice varieties and of unusually large size.

*Manufactures.*—There is perhaps no tract of country of equal extent better supplied with available water power than Kansas. The streams are fed by living springs, and the inclination of the country insures uniformly rapid currents. Most of the streams maintain a good flow of water in the driest seasons, and in case of heavy rains many of them "underflow" the adjacent bottom lands, saturating the permeable substratum of the country with the surplus water, which in time drains out and feeds the subsiding streams. This feature is particularly true of the Saline, Solomon, and Smokyhill rivers. The Smokyhill river has not risen above the banks of its deep channel at Junction City since 1869, while at the lowest stages it is capable of driving large flouring-mills, having half a dozen sets of buirs. A dam on the Kansas river at Lawrence supplies a water-power capable of developing a great manufacturing centre. In 1870 there were one hundred and ten improvements of water-power in the state. Estimates based on the latest statistics now place the number of utilized mill sites at about three hundred, where flouring-mills, saw-mills, planing-mills, and woollen-mills ran the entire year, with very little hindrance from either high or low water. In the eastern section of the State, where coal is plentiful, steam-power is much used, especially in the manufacture of iron. At Leavenworth there are manufactories of iron bridges, engines, boilers, stoves, railroad iron, and miners' tools. There are also manufactories of wagons, carriages, carpets, soaps, paints, and cement, at Leavenworth, Fort Scott, Lawrence, Columbus, Ottawa, and other places. At Topeka, Parsons, Armstrong, and Argentine there are rolling mills and railroad repair shops, while planing-mills, tanneries, cheese factories, and pork-packing establishments are found in various localities.

*Transport and Trade.*—There are numerous railroads in the State, with an aggregate length of completed track of 3104 miles. The central branch in the north and the Union Pacific (Kansas division) near the centre traverse the northern half of the State from east to west, in nearly parallel lines,—the latter extending by its connexions to San Francisco. The Atchison, Topeka, and Santa Fe line passes from the north-east to the south-west, extending through to the Pacific coast; and the Missouri Pacific (Kansas division), by uniting with the Texas Central, connects the richest portion of Kansas with the Gulf of Mexico at Galveston. Other lines in connexion with these facilitate the internal commerce of the State. Kansas has an eastern front of 150 miles on the Missouri river, which is navigable for steamboats of all sizes. The internal rivers of the State are not utilized for commercial purposes, though the Kansas was formerly considered navigable to Fort Riley, near the mouth of the Republican river, and steamboats have ascended the Smokyhill to the mouth of the Saline, about 50 miles further west. By means of these railroads and the Missouri river immense quantities of wheat, corn, cattle, and swine are sent from Kansas to the eastern markets; flour is sent south, south-west, and west, and butter, poultry, and eggs, with large quantities of vegetables, hay, and garden produce, to the western mining regions.

*Education.*—The public schools are liberally endowed and supported. Two sections of land (1280 acres) are set apart in each congressional district for school fund purposes. These are in the State 5242 public school buildings, and the value of public school property is \$4,633,044. The teachers employed number 6707. The pupils of school age are estimated from statistics of 1875 at 230,000, about half of whom are in actual attendance. The annual expenditure for school purposes, estimated from statistics of 1875, is 1,500,000. The State supports a university at Lawrence, and a normal school at Emporia; and the agricultural college at Manhattan is endowed by the general Government. There are also State institutions for the education of the blind, and the deaf and dumb, and for the care of the insane. A reform school for juvenile offenders is being built at the State capital.

*Religion.*—All the usual religious denominations are represented, owning church property to the amount of \$2,511,520.

*Administration.*—In Kansas, as in all the States of the American Union, the government is vested in three departments, legislative, executive, and judicial. The governor is elected for a term of two years. The legislature consists of a senate and house of representatives. The members of the house are elected for two years, and members of the senate for four. The judiciary consists of a State supreme court and subordinate district courts. The judges are all elected by a direct vote of the people.

*Population.*—The following table gives the population at the last three census enumerations, with the number of inhabitants per square mile at each period:—



	Total.	Males.	Females.	Per Sq. Mlle.
1860	107,266	59,178	48,088	1.3
1870	364,399	202,224	162,175	4.5
1880	995,966	536,725	459,241	12.2

The State is divided into 104 counties. The following are the largest towns, with population in 1880:—Leavenworth, 16,550; Topeka, 15,451; Atchison, 15,106; Lawrence, 8511; Wyandotte, 6149; Fort Scott, 5372; Wichita, 4911; Emporia, 4632; Parsons, 4196; Ottawa, 4032. Topeka, the State capital, is advantageously situated, and is one of the most flourishing towns in the State.

*History.*—Kansas belongs to that immense tract of country, purchased by the American Government from France in 1803, known as the Louisiana purchase. Prior to 1854 it was in the hands of various Indian tribes, some native, and others which had been removed from the older States. It was organized and opened for settlement as a territory by Act of Congress in May 1854, in the midst of a heated contest on the slavery question. The slaveholders and the friends of freedom at once began a vigorous contest for the occupancy and control of the new territory, and thus it was that Kansas became the vanguard in the great struggle which resulted in the overthrow of slavery in the United States. Before the formal beginning of the war, societies were organized by the rival settlers and their friends in the States on both sides of the slavery question, and even rival legislatures were elected and convened. The discussions frequently resulted in personal violence, and the greatest excitement prevailed till the breaking out of the civil war. Kansas was admitted into the Union as a State in January 1861, and took an active part in furnishing troops for the suppression of the rebellion. The State was frequently invaded, and the city of Lawrence was sacked and burned in August 1863. Since the overthrow of slavery, Kansas has shared fully in the general progress of the country. (J. D. F.)

**KANSAS CITY**, in Jackson county, Missouri, U.S., the second city in size and importance in the State, is situated on the right bank of the Missouri immediately below the mouth of the Kansas river, 235 miles west by north of St Louis. It is a large railroad centre, several important lines meeting there, and giving the city large facilities for commanding the trade of western Missouri, Kansas, northern Texas, and part of Colorado and New Mexico. The Missouri at this point is crossed by a bridge 1387 feet long, resting on seven piers. The business in agricultural products is very large, and is constantly increasing, that of packing beef and pork being especially great, and growing with remarkable rapidity. The city was laid out in 1830, but its growth may be said to date from 1860, when its population numbered 4418. In 1870 the population had increased to 32,290, and in 1880 it was 55,787.

**KANT, IMMANUEL (1724-1804).** So far as changes of external fortune are concerned, the life of the greatest philosopher of the 18th century presents little or nothing of interest. Born in humble circumstances, he passed a quiet and almost undisturbed existence within the narrow limits of his native place. Education, both of school and university, he obtained at Königsberg, and during a prolonged academic activity in that retired Prussian town he gave forth the works which have exercised such influence on European thought that, in the estimation of the best historical judges, they may be placed on a level with the great events of the French Revolution as the most important factors in determining the characteristic features of 19th century culture. A biography of Kant can be little more than a record of the successive phases of his literary activity.

The family of Kant was of Scotch extraction, the grandfather of the philosopher having been an emigrant from Scotland who had settled, first at Memel, and afterwards at Tilsit. The name Kant, as it was originally spelled, is not uncommon in the north of Scotland, whence the family is said to have come, and it is not perhaps mere fancy to trace in some of the ethical doctrines of the critical philosophy and in the personal character of its author some of the prominent features of Scottish nationality. The father of the philosopher carried on the business of a saddler in Königsberg, and in that town, on the 22d April

1724, was born Immanuel, the fourth of a large family, most of whom died at an early age. Königsberg was then somewhat noted as a stronghold of what is known as Pietism, a phase of religious thought and life which had in Germany, as elsewhere, too much that was unpleasant, but which nevertheless was capable of exercising a powerful influence for good on the development of a really strong and ample character. "Say what you will of Pietism," writes Kant to his friend Riuk, "no one can deny the real worth of the characters which it formed; they possessed the highest that man can possess—a peace, a cheerfulness, an inner harmony with self, which was disturbed by no passion." To influences of this kind Kant was subjected in his early years, partly from his mother, for whose memory he ever cherished the warmest affection and regard, partly from his excellent friend and patron, Schulz, the director of the Collegium Fredericianum in Königsberg, and afterwards professor of theology in the university. At the Collegium Fredericianum Kant was entered in his tenth year, with the definite view of proceeding to the theological courses of the university. His inclination at this time, determined probably by the high character of his teachers, was towards classics, and he was recognized, with his schoolfellow, the afterwards celebrated David Ruhken, as among the most competent and promising classical scholars of the college. His taste for the greater Latin authors, particularly Lucretius, was never lost, and he acquired through his school training an unusual facility in Latin composition. With Greek authors he does not appear to have been equally familiar.

During his university course, which began in 1740, Kant was principally attracted towards mathematica and physics, doubtless through the influence of Knutzen, who then, as extraordinary professor, lectured on most branches of mathematics and also on philosophy. The lectures on classics do not seem to have satisfied Kant, and, though he attended Schulz's courses on theology, and even preached on one or two occasions, he appears finally to have given up the intention of entering the church. The last years of his university studies were much disturbed by the straitened means of his family, and he was compelled to have recourse to private teaching of the humblest kind. The death of his father, in 1746, destroyed his hopes of remaining at the university until he should have obtained some subordinate academic post. Much against his inclination he undertook the office of private tutor, and for nine years acted in this capacity in various families in the immediate neighbourhood of Königsberg. Although the life was not one which Kant would have chosen, and one for which he was not specially qualified—as he used to say regarding the excellent precepts of his *Pædagogics*, he was never able to apply them—yet it gave him an extended knowledge of the world, and added to his other accomplishments the grace and polish of refined society, which he displayed ever afterwards to a degree somewhat unusual in a philosopher by profession.

In 1755 Kant returned to Königsberg as tutor in the family of Count Kayserling. By the kindness of a friend named Richter, he was enabled again to take up his university career, and in autumn of that year he graduated as doctor and qualified as "Privatdozent." Two of the theses publicly defended on the occasion are printed in his works; an address, on the easier and harder styles of philosophical exposition, has not been published. For fifteen years he continued to labour in this subordinate position, his fame as writer and lecturer steadily increasing. On two occasions he was disappointed in the hope of obtaining a professorship in his own university, but during this time, as in later years, he refused all offers that would have withdrawn him





# KANSAS

SCALE OF MILES

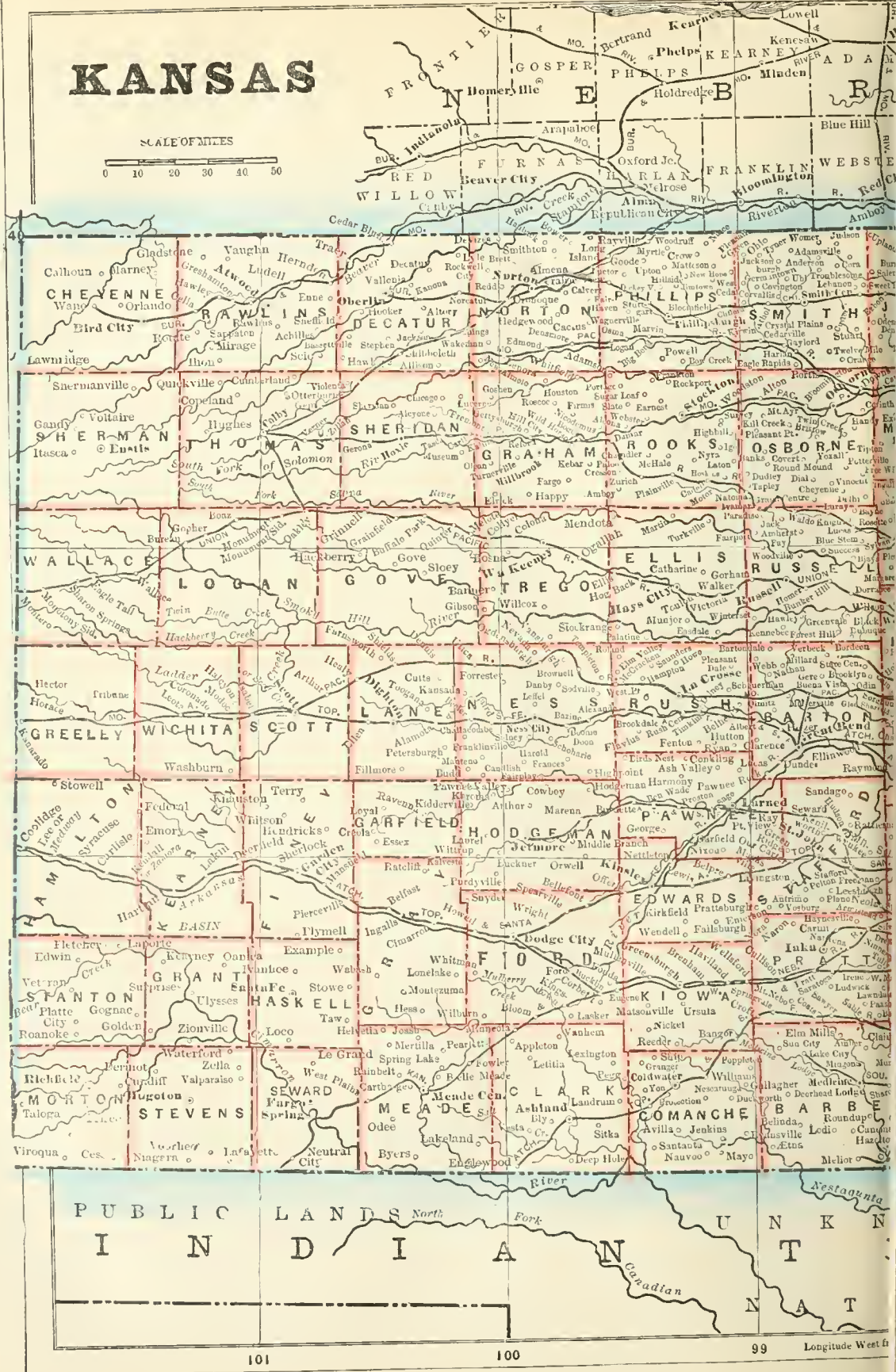
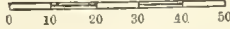



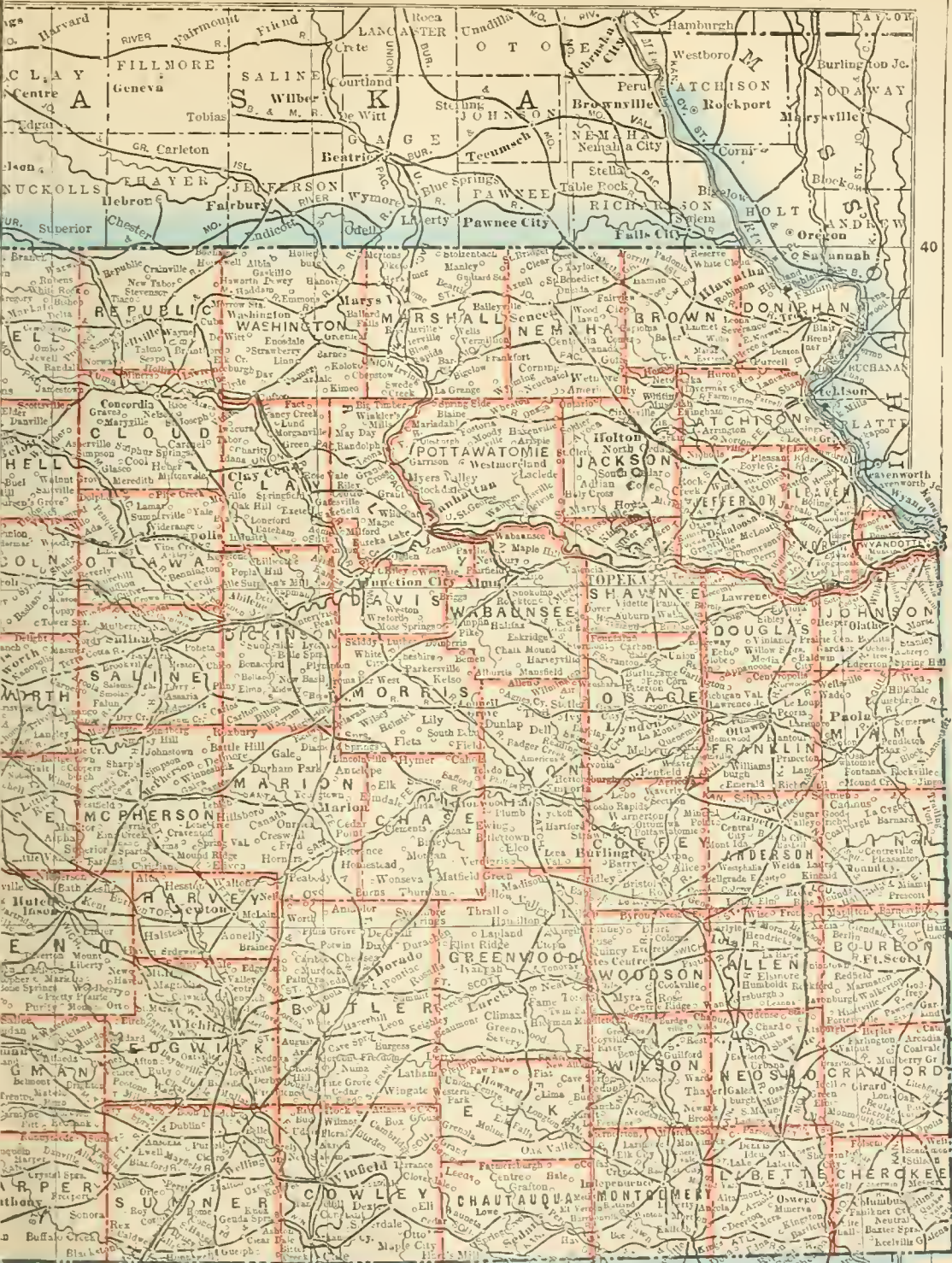





from Königsberg. The only academic preferment received by him during the lengthy probation was the post of under-librarian, to which he was appointed in 1766. His lectures, at first mainly upon physics, gradually expanded until nearly all descriptions of philosophy were included under them. A most interesting programme of his courses on metaphysics, logic, ethics, and physical geography for the session 1765-66 has been printed in his works (i. 289-299). The history of his literary activity during this period will be given in connexion with the notice of his writings.

In 1770 he obtained the chair of logic and metaphysics at Königsberg, and delivered as his inaugural address the dissertation *De Mundi Sensibilis et Intelligibilis Forma et Principiis*. Eleven years later appeared the *Kritik of Pure Reason*, the work towards which he had been steadily advancing, and of which all his later writings are developments.

In 1783 he published the *Prolegomena*, intended as an introduction to the *Kritik*, which had been found to stand in need of some explanatory comment. A second edition of the *Kritik*, with some modifications, appeared in 1787, after which it remained unaltered.

In spite of its frequent obscurity, its novel terminology, and its declared opposition to prevailing systems, the Kantian philosophy made rapid progress in Germany. In the course of ten or twelve years from the publication of the *Kritik of Pure Reason*, it was expounded in all the leading universities, and it even penetrated into the schools of the Church of Rome. Such men as Schulze in Königsberg, Kiesewetter in Berlin, Jakob in Halle, Born and Heydenreich in Leipsic, Reinhold and Schmid in Jena, Buhle in Göttingen, Tenuemann in Marburg, and Snell in Giessen, with many others, made it the basis of their philosophical teaching, while theologians like Tieftrunk, Ständlin, and Ammon eagerly applied it to Christian doctrine and morality. Young men flocked to Königsberg as to a shrine of philosophy. The Prussian Government even undertook the expense of their support. Kant was hailed by some as a second Messiah. He was consulted as an oracle on all questions of casuistry,—as, for example, on the lawfulness of inoculation for the small-pox. This universal homage for a long time left Kant unaffected; it was only in his later years that he spoke of his system as the limit of philosophy, and resented all further progress. He still pursued his quiet round of lecturing and authorship, and contributed from time to time papers to the literary journals. Of these, among the most remarkable was his review of Herder's *Philosophy of History*, which greatly exasperated that author, and led to a violent act of retaliation some years after in his *Metakritik of Pure Reason*. Schiller at this period in vain sought to engage Kant upon his *Horen*. He remained true to the *Berlin Journal*, in which most of his criticisms appeared.

In 1792 Kant, in the full height of his reputation, was involved in a painful collision with the Government on the question of his religious doctrines. Wöllner had replaced Von Zedlitz as minister of spiritual affairs, and, in an age peculiarly lax and heterodox, an unwise attempt was made to apply a rigid censorship to works of philosophical theology. It was not wonderful that the philosophy of Kant had excited the declared opposition of all adherents of historical Christianity, since its plain tendency was towards a moral rationalism, and it could not by any process of interpretation be reconciled to the literal doctrines of the Lutheran Church. It would have been much better to permit his exposition of the philosophy of religion to enjoy the same literary rights as his earlier works, since Kant could not be interdicted without first silencing a multitude of theologians who were at least equally separated from positive Christianity. The Government, however, judged

otherwise; and after the first part of his book, *On Religion within the Limits of Reason alone*, had appeared in the *Berlin Journal*, the publication of the remainder, which treats in a more rationalizing style of the peculiarities of Christianity, was forbidden. Kant, thus shut out from Berlin, availed himself of his local privilege, and, with the sanction of the theological faculty of his own university, published the full work in Königsberg. The Government, who were probably as much influenced by hatred and fear of the French Revolution, of which Kant was supposed to be a partisan, as by love of orthodoxy, resented the act; and a secret cabinet order was received by him intimating the displeasure of the king, Frederick William II., and exacting from him a pledge not to lecture or write at all on religious subjects in future. With this mandate Kant, after a struggle, complied, and kept his engagement till 1797, when the death of the king, according to his construction of his promise, set him free. This incident, however, produced a very unfavourable effect on his spirits. He withdrew in 1794 from society; next year he gave up all his classes but one public lecture on logic or metaphysics; and in 1797, before the removal of the interdict on his theological teaching, he ceased altogether his public labours, after an academic course of forty-two years. He previously, in the same year, finished his treatises on the *Metaphysics of Ethics*, which, with his *Anthropology*, completed in 1798, were the last considerable works that he revised with his own hand. His *Lectures on Logic*, on *Physical Geography*, on *Pædagogics*, were edited during his lifetime by his friends and pupils. By way of asserting his right to resume theological disquisition, he also issued in 1798 his *Strife of the Faculties*, in which all the strongest points of his work on religion were urged afresh, and the correspondence that had passed between himself and his censors was given to the world.

From the date of his retirement from the chair Kant declined in strength, and gave tokens of intellectual decay. His memory began to fail, and a large work at which he wrought night and day, on the connexion between physics and metaphysics, was found to be only a repetition of his already published doctrines. After 1802, finding himself attacked with a weakness in the limbs, attended with frequent fits of falling, he mitigated a little the Spartan severity of his life, and also consented to receive medical advice. A constant restlessness oppressed him; his sight gave way; his conversation became an extraordinary mixture of metaphors; and it was only at intervals that gleams of his former power broke out, especially when some old chord of association was struck in natural science or physical geography. A few days before his decease, with a great effort he thanked his medical attendant for his visits in the words, "I have not yet lost my feeling for humanity." On the 12th of February 1804, he breathed his last, having almost completed the eightieth year of his age.

It is superfluous to characterize the genius of Kant; but a few words may be added as to his personal appearance and habits of life, study, and teaching. His stature was small, and his appearance feeble. He was little more than 5 feet high; his breast was almost concave, and, like Schleiermacher, he was deformed in the right shoulder. His hair was light, his complexion fresh, his forehead high and square, while his eye of light blue showed an expression of unusual depth and power. His senses were quick and delicate; and, though of weak constitution, he escaped, by strict regimen, all serious illness till the close of life.

His life was arranged with mechanical regularity; and, as he never married, he kept the habits of his studious youth to old age. His man-servant awoke him summer



and winter at five o'clock; and, on being appealed to on one occasion, testified that Kant had not once failed in thirty years to respond to the call. After rising he studied for two hours, then lectured after two, and spent the rest of the forenoon, till one, at his desk. He then dined at a restaurant, which he frequently changed, to avoid the influx of strangers, who crowded to see and hear him—till in later years his growing means enabled him to invite a friend or two daily to his own home. This was his only regular meal; and, as he loved the *ducere canam* of the Romans, he often prolonged the conversation till late in the afternoon. He then walked out for at least an hour in all weathers, and spent the evening in lighter reading, except an hour or two devoted to the preparation of his next day's lectures, after which he retired between nine and ten to rest. The furniture of his house was of the simplest character; and, though he left a considerable sum, the produce of his writings, to his relatives, he indulged in no luxury, and was a pattern of that superiority to fashion and appearance so often met with in the literary life of Germany. In his earlier years he often spent his evenings in general society, where his overflowing knowledge and conversational talents made him the life of every party. He was especially intimate with the families of two English merchants of the name of Green and Motherby, where he found many opportunities of meeting ship-captains, and other travelled persons, and thus gratifying his passion for physical geography. This social circle included also the celebrated Hamann—the Magus or Wizard of the North—the friend of Herder and Jacobi, who was thus a mediator between Kant and these philosophical adversaries.

Kant's reading was of the most extensive and miscellaneous kind. He cared comparatively little for the history of speculation, being in this department more a discoverer than a scholar. But his acquaintance with books of science, general history, travels, and belles lettres was boundless. He was well versed in English literature, chiefly of the age of Queen Anne, and had read English philosophy from Locke to Hume, and the Scottish school. He was at home in Voltaire and Rousseau, but had little or no acquaintance with the French sensational philosophy. He was familiar with all German literature up to the date of his *Kritik*, but ceased to follow it in its great development by Goethe and Schiller. It was his habit to obtain books in sheets from his publishers Kauter and Nicolovius; and he read over for many years all the new works in their catalogue, in order to keep abreast of universal knowledge. He was excessively fond of newspapers and works on politics; and this was the only kind of reading that could interrupt his studies in philosophy.

As a lecturer, Kant avoided altogether that rigid style in which his books were written, and which was only meant for thinkers by profession. He sat behind a low desk, with a few jottings on slips of paper, or text-books marked on the margin, before him, and delivered an extemporaneous address, opening up the subject by partial glimpses, and with many digressions and interspersed anecdotes or familiar illustrations, till a complete idea of it was presented. His voice was extremely weak, but sometimes rose into eloquence, and always commanded perfect silence. Like Adam Smith, he fixed his eye on one student, and marked by his countenance whether the lecture was understood. The least irregularity in the appearance or dress of this selected hearer disconcerted him; and the story is well known of the missing button, which defeated a lecture. Though kind to his students, he refused on principle to remit their fees, as this, he thought, would discourage independence. It was another principle that his chief exertions should be bestowed on the intermediate class of talent, as the geniuses would help themselves, and the

dunces were beyond remedy. Hence he never delivered his deeper doctrines, such as are found in his *Kritik*, from the chair. His other avocations allowed him little personal intercourse with his numerous hearers, and he often complained of the want of lively sympathy and ascertained progress inseparable from such a system.

Simple, honourable, truthful, kind-hearted, and high-minded as Kant was in all moral respects, he was somewhat deficient in the region of sentiment. He had little enthusiasm for the beauties of nature, and indeed never sailed out into the Baltic, or travelled more than 40 miles from Königsberg. Music he disregarded, and all poetry that was more than sententious prose. His ethics have been reproached with some justice as setting up too low an ideal for the female sex. Though faithful in a high degree to the duties of friendship, he could not bear to visit his friends in sickness, and after their death he repressed all allusion to their memory. His engrossing intellectual labours no doubt tended somewhat to harden his character; and in his zeal for rectitude of purpose he forgot the part which affection and sentiment must ever play in the human constitution. Those who count these defects most grave will yet find much to admire in the lofty tone of his character, and in the benevolence which could thus express itself: "Whoever will suggest to me a good action left undone, him will I thank, though he suggest it even in my last hour!"

This brief notice of his life may appropriately close with Herder's beautiful sketch of Kant's character, all the more interesting that it was written in 1795, after their quarrel:—"I have had the good fortune to know a philosopher who was my teacher. In the vigour of life he had the same youthful gaiety of heart that now follows him I believe into old age. His open forehead, built for thought, was the seat of imperturbable cheerfulness and joy; the most pregnant discourse flowed from his lips; wit, humour, and raillery came to him at will, and his instructions had all the charm of an entertainment. With the same easy mastery with which he tested the doctrines of Leibnitz, Wolf, Baumgarten, Crusius, and Hume, or pursued the discoveries of Newton, Kepler, and other lights of science, he also took up the current writings of Rousseau, such as the *Émile* or *Héloïse*, or any new phenomenon of the natural world, and from the criticism of each came back to the impartial study of nature, and to the enforcement of the dignity of man. History in all its branches, natural science, physics, mathematics, and experience were the materials that gave interest to his lectures and his conversation; nothing worthy of study was to him indifferent; no faction or sect, no selfishness or vanity, had for him the least attraction, compared with the extension and elucidation of truth. He excited and pleasantly impelled us to mental independence; despotism was foreign to his nature. This man, whom I name with the deepest gratitude and respect, is Immanuel Kant; his image rises before me surrounded with pleasing recollections!"

#### *The Writings of Kant.*

From the preceding sketch of Kant's academic activity it must be evident that he combined in a quite unusual degree knowledge of physical science with speculative acuteness and devotion to the special work of philosophy. No other thinker of modern times has been throughout his work so penetrated with the fundamental conceptions of physical science; no other has been able to hold with such firmness the balance between empirical and speculative ideas. Beyond all question much of the influence which the critical philosophy has exercised and continues to exercise must be ascribed to this characteristic feature in the training of its great author.

The early writings of Kant are almost without exception on questions of physical science. It was only by degrees that philosophical problems began to engage his attention, and that the main portion of his literary activity was turned towards them. It will be convenient, therefore, in enumerating the varied writings of Kant, to place in a separate group those which bear directly on physical science. The following are the most important in this group:—

1. *Thoughts on the True Estimate of *Vis Viva**, 1747: an essay dealing with the famous dispute between the Cartesians and Leibnitzians regarding the expression for the amount of a force. According to the Cartesians, this quantity was directly proportional to velocity; according to their opponents, it varied with the square of the velocity. The dispute has now lost its interest, for physicists have learned to distinguish accurately the two quantities which are vaguely included under the expression amount of force, and consequently have been able to show in what each party was correct and in what it was in error. Kant's essay, with some fallacious explanations and divisions, criticizes acutely the arguments of the Leibnitzians, and concludes with an attempt to show that both modes of expression are correct when correctly limited and interpreted.

2. *Whether the Earth in its Revolution has experienced some Change since the Earliest Times*, 1754. In this brief essay Kant throws out a notion which has since been carried out, in ignorance of Kant's priority, by Delaunay (1865) and Adams. He points out that the action of the moon in raising the waters of the earth must have a secondary effect in the slight retardation of the earth's motion, and refers to a similar cause the fact that the moon turns always the same face to the earth.

3. *General History and Theory of the Heavens* ("Allgemeine Natur-Geschichte und Theorie des Himmels"), published anonymously in 1755. In this remarkable work Kant, proceeding from the Newtonian conception of the solar system, extends his consideration to the entire sidereal system, points out how the whole may be mechanically regarded, and throws out the important speculation which has since received the title of the nebular hypothesis. In some details, such, e.g., as the regarding of the motion of the entire solar system as portion of the general cosmic mechanism, he had predecessors, among others J. Wright of Durham, but the work as a whole contains a wonderfully acute anticipation of much that was afterwards carried out by Herschel and Laplace. The hypothesis of the original nebular condition of the system, with the consequent explanation of the great phenomena of planetary formations and movements of the satellites and rings, is unquestionably to be assigned to Kant.

4. *Brief Account of some Thoughts on Fire* ("Meditationum quarundam de Igno succincta delineatio"), 1755: an inaugural dissertation, containing little beyond the notion that bodies operate on one another through the medium of a uniformly diffused, elastic, and subtle matter (ether) which is the underlying substance of heat and light. Both heat and light are regarded as vibrations of this diffused ether.

5. *On the Causes of Earthquakes*, 1755; *Description of the Earthquake of 1755, 1756*; *Consideration of some Recently Experienced Earthquakes*, 1756.

6. *Explanatory Remarks on the Theory of the Winds*, 1756. In this brief tract, Kant, apparently in entire ignorance of the explanation given in 1735 by Hadley, points out how the varying velocity of rotation of the successive zones of the earth's surface furnishes a key to the phenomena of periodic winds. His theory is in almost entire agreement with that now received. See the parallel statements from Kant's tract and Dove's essay on the influence of the rotation of the earth on the flow of its atmosphere, 1835, given in Zöllner's work, *Ueber die Natur der Cometen*, pp. 477-482.

7. *On the Different Races of Men*, 1775; *Determination of the Notion of a Human Race*, 1785; *Conjectural Beginning of Human History*, 1786: three tracts containing some points of interest as regards the empirical grounds for Kant's doctrine of teleology. Reference will be made to them in the notice of the *Kritik of Judgment*.

8. *On the Volcanoes in the Moon*, 1785; *On the Influence of the Moon on the Weather*, 1794. The second of these contains a remarkable discussion of the relation between the centre of the moon's figure and its centre of gravity. From the difference between these Kant is led to conjecture that the climatic conditions of the side of the moon turned from us must be altogether unlike those of the face presented to us. His views have been restated by Hansen.

9. *Lectures on Physical Geography*, 1822: published from notes of Kant's lectures, with the approval of the author.

Consideration of these works is sufficient to show that Kant's mastery of the science of his time was complete and thorough, and that his philosophy is to be dealt with as having throughout a reference to general scientific conceptions. For more detailed treatment of his importance in science, reference may be made to

Zöllner's essay on "Kant and his Merits on Natural Science" contained in the work on the *Nature of Comets* (pp. 426-484); to Dietrich, *Kant and Newton*; to Schultze, *Kant and Darwin*; and to Reuschle's careful analysis of the scientific works in the *Deutsche Vierteljahrs-schrift*, 1863.

The notice of the philosophical writings of Kant need not be more than bibliographical, as in the account of his philosophy it will be necessary to consider at some length the successive stages in the development of his thought. Arranged chronologically these works are as follows.—

1755. *Præcipiorum Primorum cognitionis Metaphysicæ nova Dilucidatio*.

1756. *Metaphysicæ cum geometria junctæ usus in philosophia naturali, cujus Specimen I. continet Monadologiam Physicam*.

1762. *Die falsche Spitzfindigkeit der vier syllogistischen Figuren, "The False Subtlety of the Four Syllogistic Figures."*

1763. *Versuch den Begriff der negativen Grössen in die Weltweisheit einzuführen*, "Attempt to introduce the Notion of Negative Quantities into Philosophy."

1763. *Der einzig mögliche Beweisgrund zu einer Demonstration des Daseins Gottes*, "The only possible Foundation for a Demonstration of the Existence of God."

1763. *Untersuchung über die Deutlichkeit der Grundsätze der natürlichen Theologie und Moral*, "Essay on the Evidence (Clearness) of the Fundamental Propositions of Natural Theology and Ethics."

1766. *Träume eines Geistessehers, erläutert durch Träume der Metaphysik*, "Dreams of a Ghost-seer (or Clairvoyant), explained by the Dreams of Metaphysic."

1768. *Von dem ersten Grunde des Unterschiedes der Gegenden im Räume*, "Foundation for the Distinction of Positions in Space."

The above may all be regarded as belonging to the pre-critical period of Kant's development. The following introduce the notions and principles characteristic of the critical philosophy.

1770. *De Mundi Sensibilibus et Intelligibilibus forma et principiis*.

1781. *Kritik der reinen Vernunft*, "Kritik of Pure Reason."

1783. *Prolegomena zu einer jeden künftigen Metaphysik die als Wissenschaft wird auftreten können*, "Prolegomena to all Future Metaphysic which may present itself as Science."

1784. *Idee zu einer allgemeinen Geschichte in weltbürgerlicher Absicht*, "Notion of a Universal History in a Cosmopolitan Sense." With this may be coupled the review of Herder in 1785.

1785. *Grundlegung der Metaphysik der Sitten*, "Foundations of the Metaphysic of Ethics."

1783. *Metaphysische Anfangsgründe der Naturwissenschaft*, "Metaphysical Elements of Natural Science."

1788. *Ueber den Gebrauch teleologischer Principien in der Philosophie*, "On the Employment of Teleological Principles in Philosophy."

1788. *Kritik der praktischen Vernunft*, "Kritik of Practical Reason."

1790. *Kritik der Urteilskraft*, "Kritik of Judgment."

1790. *Ueber eine Entdeckung, nach der alle neue Kritik der reinen Vernunft durch eine ältere entbehrlich gemacht werden soll*, "On a Discovery by which all the recent Critique of Pure Reason is superseded by a more ancient (i.e., by Leibnitz's philosophy)."

1791. *Ueber die wirklichen Fortschritte der Metaphysik seit Leibnitz und Wolff*, "On the Real Advances of Metaphysics since Leibnitz and Wolff."

1794. *Die Religion innerhalb der Grenzen der blossen Vernunft*, "Religion within the Bounds of Reason only."

1794. *Ueber Philosophie überhaupt*, "On Philosophy generally."

1797. *Metaphysische Anfangsgründe der Rechtslehre, and Metaphysische Anfangsgründe der Tugendlehre*.

1798. *Der Streit der Facultäten*, "Contest of the Faculties."

1798. *Anthropologie*.

#### The Kantian Philosophy.

Historians are accustomed to divide the general current of speculation into epochs or periods marked by the dominance of some single philosophic conception with its systematic evolution. Perhaps in no case is the character of an epoch more clearly apparent than in that of the critical philosophy. The great work of Kant absolutely closed the lines of speculation along which the philosophical literature of the 18th century had proceeded, and substituted for them a new and more comprehensive method of regarding the essential problems of thought, a method which has prescribed the course of philosophic speculation in the present age. The critical system has thus a twofold aspect. It takes up into itself what had characterized the previous efforts of modern thought, shows the imperfect nature of the fundamental notions therein employed, and offers a new solution of the problems to which these notions had been applied. It opens up a new series of questions upon which subsequent philosophic attention has been directed, and gives to them the form, under which it is possible that they should be



fruitfully regarded. A work of this kind is essentially epoch-making.

In any complete account of the Kantian system it is therefore necessary that there should be constant reference, on the one hand, to the peculiar character of the preceding 18th century philosophy, and, on the other hand, to the problems left for renewed treatment to more modern thought. Fortunately the development of the Kantian system itself furnishes such treatment as is necessary of the former reference. For the critical philosophy was a work of slow growth. In the early writings of Kant we are able to trace with great definiteness the successive stages through which he passed from the notions of the preceding philosophy to the new and comprehensive method which gives its special character to the critical work. Scarcely any great mind, it has been said with justice, ever matured so slowly. In the early essays we find the principles of the current philosophies, those of Leibnitz and English empiricism, applied in various directions to those problems which serve as tests of their truth and completeness; we note the appearance of the difficulties or contradictions which manifest the one-sidedness or imperfection of the principle applied; and we can trace the gradual growth of the new conceptions which were destined, in the completed system, to take the place of the earlier method. To understand the Kantian work it is indispensable to trace the history of its growth in the mind of its author.

Of the two preceding stages of modern philosophy, only the second, that of Locke and Leibnitz, seems to have influenced practically the course of Kant's speculation. With the Cartesian movement as a whole he shows little acquaintance and no sympathy, and his own philosophic conception is never brought into relation with the systematic treatment of metaphysical problems characteristic of the Cartesian method. The fundamental question for philosophic reflexion presented itself to him in the form which it had assumed in the hands of Locke and his successors in England, of Leibnitz and the Leibnitzian school in Germany. The transition from the Cartesian movement to this second stage of modern thought had doubtless been natural and indeed necessary. Nevertheless the full bearings of the philosophic question were somewhat obscured by the comparatively limited fashion in which it was then regarded. The tendency towards what may be technically called subjectivism, a tendency which differentiates the modern from the ancient method of speculation, is expressed in Locke and Leibnitz in a definite and peculiar fashion. However widely the two systems differ in details, they are at one in a certain fundamental conception which dominates the whole course of their philosophic construction. They are throughout individualist, *i. e.*, they accept as given fact the existence of the concrete, thinking subject, and endeavour to show how this subject, as an individual conscious being, is related to the wider universe of which he forms part. In dealing with such a problem, there are evidently two lines along which investigation may proceed. It may be asked how the individual mind comes to know himself and the system of things with which he is connected, how the varied contents of his experience are to be accounted for, and what certainty attaches to his subjective consciousness of things. Regarded from the individualist point of view, this line of inquiry becomes purely psychological, and the answer may be presented, as it was presented by Locke, in the fashion of a natural history of the growth of conscious experience in the mind of the subject. Or, it may be further asked, how is the individual really connected with the system of things apparently disclosed to him in conscious experience? what is the precise significance of the existence which he ascribes both to himself and to the objects of experience? what is the nature of the relation between himself as one part of the system, and the system as a whole? This second inquiry is specifically metaphysical in bearing, and the kind of answer furnished to it by Leibnitz on the one hand, by Berkeley on the other, is in fact prescribed or determined beforehand by the fundamental conception of the individualist method with which both begin their investigations. So soon as we make clear to ourselves the essential nature of this method, we are able to discern the specific difficulties or perplexities arising in the attempt to carry it out systematically, and thus to note with precision the special problems presented to Kant at the outset of his philosophic reflexions.

Consider, first, the application of the method on its psychological side, as it appears to Locke. Starting with the assumption of conscious experience as the content or filling-in of the individual mind, Locke proceeds to explain its genesis and nature by reference to the real universe of things and its mechanical operation upon the mind. The result of the interaction of mind, *i. e.*, the individual mind, and the system of things, is conscious experience, consisting of ideas, which may be variously compounded, divided, compared, or dealt with by the subjective faculties or powers with which the entity, Mind, is supposed to be endowed. Matter of fact and matter of knowledge are thus at a stroke dis severed. The very notion of relation between mind and things leads at once to the counter notion of the absolute restriction of mind to its own subjective nature. That Locke was unable to reconcile these opposed notions is not surprising; that the difficulties and obscurities of the *Essay* arise from

the impossibility of reconciling them is evident on the slightest consideration of the main positions of that work. Of these difficulties the philosophies of Berkeley and Hume are systematic treatments. In Berkeley we find the resolute determination to accept only the one notion, that of mind as restricted to its own conscious experience, and to attempt by this means to explain the nature of the external reality to which obscure reference is made. Any success in the attempt is due only to the fact that Berkeley introduces alongside of his individualist notion a totally new conception, that of mind itself as not in the same way one of the matters of conscious experience, but as capable of reflexion upon the whole of experience and of reference to the supreme mind as the ground of all reality. It is only in Hume that we have definitely and completely the evolution of the individualist notion as groundwork of a theory of knowledge; and it is in his writings, therefore, that we may expect to find the fundamental difficulty of that notion clearly apparent. It is not a little remarkable that we should find in Hume, not only the sceptical dissolution of all fixity of cognition, which is the inevitable result of the individualist method, but also the clearest consciousness of the very root of the difficulty. The systematic application of the doctrine that conscious experience consists only of isolated objects of knowledge, impressions or ideas, leads Hume to distinguish between truths reached by analysis and truths which involve real connexion of the objects of knowledge. The first he is willing to accept without further inquiry, though it is an error to suppose, as Kant seems to have supposed, that he regarded mathematical propositions as coming under this head (see HUME); with respect to the second, he finds himself, and confesses that he finds himself, hopelessly at fault. No real connexions between isolated objects of experience are perceived by us. No single unit of fact necessarily implies the existence of any other. In short, if the difficulty be put in its ultimate form, no existence thought as a distinct individual can transcend itself, or imply relation to any other existence. If the parts of conscious experience are regarded as so many distinct things, there is no possibility of connecting them other than contingently, if at all. If the individual mind be really thought as individual, it is impossible to explain how it should have knowledge or consciousness at all. "In short," says Hume, "there are two principles which I cannot render consistent, nor is it in my power to renounce either of them, *viz.*, that all our distinct perceptions are distinct existences, and that the mind never perceives any real connexion among distinct existences. Did our perceptions either inhere in something simple or individual, or did the mind perceive some real connexion among them, there would be no difficulty in the case" (App. to *Treatise of Human Nature*).

Thus, on the one hand, the individualist conception, when carried out to its full extent, leads to the total negation of all real cognition. If the real system of things, to which conscious experience has reference, be regarded as standing in causal relation to this experience, there is no conceivable ground for the extension to reality of the notions which somehow are involved in thought. The same result is apparent, on the other hand, when we consider the theory of knowledge implied in the Leibnitzian individualism. The metaphysical conception of the monads, each of which is the universe *in se*, presents insuperable difficulties when the connexion or interdependence of the monads is in question, and these difficulties obtrude themselves when the attempt is made to work out a consistent doctrine of cognition. For the whole mass of cognizable fact, the *mundus intelligibilis*, is contained *implicite* in each monad, and the several modes of apprehension can only be regarded as so many stages in the developing consciousness of the monad. Sense and understanding, real connexion of facts and analysis of notions, are not, therefore, distinct in kind, but differ only in degree. The same fundamental axioms, the logical principles of identity and sufficient reason, are applicable in explanation of all given propositions. It is true that Leibnitz himself did not work out any complete doctrine of knowledge, but in the hands of his successors the theory took definite shape in the principle that the whole work of cognition is in essence analytic. The process of analysis might be complete or incomplete. For finite intelligences there was an inevitable incompleteness so far as knowledge of matters of fact was concerned. In respect to them, the final result was found in a series of irreducible notions or categories, the *prima possibilia*, the analysis and elucidation of which was specifically the business of philosophy or metaphysics.

It will be observed that, in the Leibnitzian as in the empirical individualism, the fundamental notion is still that of the abstract separation of the thinking subject from the materials of conscious experience. From this separation arise all the difficulties in the effort to develop the notion systematically, and in tracing the history of Kant's philosophical progress we are able to discern the gradual perception on his part that there was to be found the ultimate cause of the perplexities which became apparent in considering the subordinate doctrines of the system. The successive essays which have already been enumerated as composing Kant's precritical work are not to be regarded as so many imperfect sketches of the doctrines of the *Kritik*, nor are we to look in them for anticipations of the



critical view. They are essentially tentative, and exhibit with unusual clearness the manner in which the difficulties of a received theory force on a wider and more comprehensive view. There can be no doubt that some of the special features of the *Kritik* are to be found in these precritical essays, e.g., the doctrine of the *Aesthétik* is certainly foreshadowed in the *Dissertation* of 1770; the *Kritik*, however, is no patchwork; and what appears in the *Dissertation* takes an altogether new form when it is wrought into the more comprehensive conception of the later treatise.

The particular problem which gave the occasion to the first of the precritical writings is, in an imperfect or particular fashion, the fundamental question to which the *Kritik* is an answer. What is the nature of the distinction between knowledge gained by analysis of notions and knowledge of matters of fact? Kant seems never to have been satisfied with the Wolfian identification of logical axioms and of the principle of sufficient reason. The tract on the *False Subtlety of the Four Syllogistic Figures*, in which the view of thought or reason as analytic is clearly expressed, closes with the significant division of judgments into those which rest upon the logical axioms of identity and contradiction and those for which no logical ground can be shown. Such immediate or indemonstrable judgments, it is said, abound in our experience. They are, in fact, as Kant presently perceived, the foundations for all judgments regarding real existence. It was impossible that the question regarding their nature and legitimacy and their distinction from analytic judgments should not present itself to him. The three tracts belonging to the years 1763-64 bring forward in the sharpest fashion the essential opposition between the two classes of judgments. In the *Essay on Negative Quantities*, the fundamental thought is the total distinction in kind between logical opposition (the contradictoriness of notions, which Kant always viewed as formed, definite products of thought) and real opposition. For the one the adequate explanation is found in the logical axiom of analytical thinking; for the other no such explanation is to be had. Logical ground and real ground are totally distinct. "I can understand perfectly well," says Kant, "how a consequence follows from its reason according to the law of identity, since it is discoverable by mere analysis of the notion contained in it. . . . But how something follows from another thing and not according to the law of identity, this I should gladly have made clear to me. . . . How shall I comprehend that, since something is, something else should be?" Real things, in short, are distinct existences, and, as distinct, not necessarily or logically connected in thought. "I have," he proceeds, "reflected on the nature of our knowledge in relation to our judgments of reason and consequent, and I intend to expound fully the result of my reflexions. It follows from them that the relation of a real ground to that which is thereby posited or denied cannot be expressed by a judgment but only by means of a notion, which by analysis may certainly be reduced to yet simpler notions of real grounds, but yet in such a way that the final resort of all our cognition in this regard must be found in simple and irreducible notions of real grounds, the relation of which to their consequents cannot be made clear."

The striking similarity between Kant's expressions in this *Essay* and the remarks with which Hume introduces his analysis of the notion of cause has led to the supposition that at this period of his philosophical career Kant was definitely under the influence of the earlier empirical thinker. Consideration of the whole passage is quite sufficient to show the groundlessness of this supposition. The difficulty with which Kant is presented was one arising inevitably from reflexion upon the Leibnizian theory of knowledge, and the solution does not in any way go beyond that theory. It is a solution, in fact, which must have been impossible had the purport of Hume's empirical doctrine been present to Kant's mind. He is here at the point at which he remained for many years, accepting without any criticism certain fundamental notions as required for real cognition. His ideal of metaphysics is still that of complete analysis of given notions. No glimmering of the further question, Whence come these notions and with what right do we apply them in cognition? is yet apparent. Any direct influence from Hume must be referred to a later period in his career.

The prize-essay *On the Principles of Natural Theology and Morals* brings forward the same fundamental opposition,—though in a special form. Here, for the first time, appears definitely the distinction between synthesis and analysis, and in the distinction is found the reason for the superior certainty and clearness of mathematics as opposed to philosophy. Mathematics, Kant thinks, proceeds synthetically, for in it the notions are constructed. Metaphysics, on the other hand, is analytical in method; in it the notions are given, and by analysis they are cleared up. It is to be observed that the description of mathematics as synthetic is not an anticipation of the critical doctrine on the same subject. Kant does not, in this place, raise the question as to the reason for assuming that the arbitrary syntheses of mathematical construction have any reference to reality. The deeper significance of synthesis has not yet become apparent.

In the *Only Possible Ground of Proof for the Existence of God*, the

argument, though largely Leibnizian, advances one step further towards the ultimate inquiry. For there Kant states as precisely as in the critique of speculative theology his fundamental doctrine that real existence is not a predicate to be added in thought to the conception of a possible subject. So far as subjective thought is concerned, possibility, not real existence, is contained in any judgment.

The year 1765 was marked by the publication of Leibnitz's posthumous *Nouveaux Essais*, in which his theory of knowledge is more fully stated than in any of his previous tracts. In all probability Kant gave some attention to this work, though no special reference to it occurs in his writings, and it may have assisted to give additional precision to his doctrine. In the curious essay, *Dreams of a Clairvoyant*, published 1766, he emphasizes his previously reached conclusion that connexions of real fact are mediated in our thought by ultimate notions, but adds that the significance and warrant for such notions can be furnished only by experience. He is inclined; therefore, to regard as the function of metaphysics the complete statement of these ultimate, indemonstrable notions, and therefore the determination of the limits to knowledge by their means. Even at this point, where he approximates more closely to Hume than to any other thinker, the difficulty raised by Hume does not seem to occur to him. He still appears to think that experience does warrant the employment of such notions, and when there is taken into account his correspondence with Lambert during the next few years, one would be inclined to say that the *Architektonik* of the latter represents most completely Kant's idea of philosophy.

On another side Kant had been shaking himself free from the principles of the Leibnizian philosophy. According to Leibnitz, space, the order of coexisting things, resulted from the relations of monads to one another. But Kant began to see that such a conception did not accord with the manner in which we determine directions or positions in space. In the curious little essay, *On the Ground of distinguishing Particular Divisions in Space*, he pointed out that the idea of space as a whole is not deducible from the experience of particular spaces, or particular relations of objects in space, that we only cognize relations in space by reference to space as a whole, and finally that definite positions involve reference to space as a given whole.

The whole development of Kant's thought up to this point is intelligible when regarded from the Leibnizian point of view, with which he started. There appears no reason to conclude that Hume at this time exercised any direct influence. One may go still further, and add that even in the *Dissertation* of 1770, generally regarded as more than foreshadowing the *Kritik*, the really critical question is not involved. A brief notice of the contents of this tract will suffice to show how far removed Kant yet was from the methods and principles of the critical or transcendental philosophy. Sense and understanding, according to the *Dissertation*, are the two sources of knowledge. The objects of the one are things of sense or *phenomena*; the objects of the other are *noumena*. These are absolutely distinct, and are not to be regarded as differing only in degree. In *phenomena* we distinguish *matter*, which is given by sense, and *form*, which is the law of the order of sensations. Such form is twofold—the order of space and time. Sensations formed by space and time compose the world of appearance, and this when treated by the understanding, according to logical rules, is *experience*. But the logical use of the understanding is not its only use. Much more important is the *real* use, by which are produced the pure notions whereby we think things as they are. These pure notions are the laws of the operation of the intellect; they are *leges intellectus*.

Apart, then, from the expanded treatment of space and time as subjective forms, we find in the *Dissertation* little more than the very precise and definite formulation of the slowly growing opposition to the Leibnizian doctrines. That the pure intellectual notions should be defended as springing from the nature of intellect is not out of harmony with the statement of the *Träume eines Geistessehers*, for there the pure notions were allowed to exist, but were not held to have validity for actual things except on grounds of experience. Here they are supposed to exist, discovered from experience, and are allowed validity as determinations of things in themselves.

The stage which Kant had now reached in his philosophical development was one of great significance. The doctrine of knowledge expressed in the *Dissertation* was the final form which the Wolfian rationalism could assume for him, and, though many of the elements of the *Kritik* are contained therein, it was not really in advance of the Wolfian theory. The doctrine of sense and time as forms of sense-perception, the reference of both space and time and the pure intellectual notions to the laws of the activity of mind itself, the distinction between sense and understanding as one of kind, not of degree, with the correlative distinction between phenomena and noumena,—all of these reappear, though changed and modified, in the *Kritik*. But, despite this resemblance, it seems clear that, so far as the *Dissertation* is concerned, the way



had only been prepared for the true critical inquiry, and that the real import of Hume's sceptical problem had not yet dawned upon Kant. From the manner, however, in which the doctrine of knowledge had been stated in the *Dissertation*, the further inquiry had been rendered inevitable. It had become quite impossible for Kant to remain longer satisfied with the ambiguous position assigned to a fundamental element of his doctrine of knowledge, the so-called pure intellectual notions. These notions, according to the *Dissertation*, had no function save in relation to things-in-themselves, i.e., to objects which are not directly or immediately brought into relation to our faculty of cognition. They did not serve as the connecting links of formed experience; on the contrary, they were supposed to be absolutely dis severed from all experience which was possible for intelligence like ours. In his previous essays, Kant, while likewise maintaining that such pure, irreducible notions existed, had asserted in general terms that they applied to experience, and that their applicability or justification rested on experience itself, but had not raised the question as to the ground of such justification. Now, from another side, the supreme difficulty was presented—how could such notions have application to any objects whatsoever? For some time the correlative difficulty, how objects of sense-perception were possible, does not seem to have suggested itself to Kant. In the *Dissertation* sense-perception had been taken as receptivity of representations of objects, and experience as the product of the treatment of such representations by the logical or analytical processes of understanding. Some traces of this confused fashion of regarding sense-perceptions are left even in the *Kritik*, specially perhaps in the *Aesthetik*, and they give rise to much of the ambiguity which unfortunately attaches to the more developed theory of cognition. So soon, however, as the critical question was put, on what rests the reference of representations to us to the object or thing? in other words, how do we come to have knowledge of objects at all? it became apparent that the problem was one of perfect generality, and applied, not only to cognition through the pure notions, but to sense-perceptions likewise. It is in the statement of this general problem that we find the new and characteristic feature of Kant's work.

There is thus no reason to doubt the substantial accuracy of Kant's reference to the particular occasion or cause of the critical inquiry. Up to the stage indicated by the *Dissertation*, he had been attempting, in various ways, to unite two radically divergent modes of explaining cognition—that which would account for the content of experience by reference to affection from things without us, and that which viewed the intellect itself as somehow furnished with the means of pure, rational cognition. He now discovered that Hume's sceptical analysis of the notion of cause was really the treatment of one typical or crucial instance of the much more general problem. If experience, says Hume, consists solely of states of mind somehow given to us, each of which exists as an effect, and therefore as distinct from others, with what right do we make the common assumption that parts of experience are necessarily connected? The only possible answer, drawn from the premises laid down, must be that there is no warrant for such an assumption. Necessity for thought, as Kant had been willing to admit and as Hume also held, involves or implies something more than is given in experience—for that which is given is contingent—and rests upon an *a priori* or pure notion. But *a priori* notions, did they exist, could have no claim to regulate experience. Hume, therefore, for his part, rejected entirely the notion of cause as being fictitious and delusive, and professed to account for the habit of regarding experience as necessarily connected by reference to arbitrarily formed custom of thinking. Experience, as given, contingent material, had a certain uniformity, and recurring uniformities generated in us the habit of regarding things as necessarily connected. That such a resort to experience for explanation could lead to no valid conclusion has been already noted as evident to Hume himself.

The dogmatic or individualist conception of experience had thus proved itself inadequate to the solution of Hume's difficulty regarding the notion of cause,—a difficulty which Kant, erroneously, had thought to be the only case contemplated by his predecessor. The perception of its inadequacy in this respect, and the consequent generalization of Hume's problem, are the essential features of the new critical method. For Kant was now prepared to formulate his general inquiry in a definite fashion. His long-continued reflection on the Wolffian doctrine of knowledge had made clear to him that synthetic connexion, the essence of real cognition, was not contained in the products of thinking as a formal activity of mind operating on material otherwise supplied. On the other hand, Hume's analysis enabled him to see that synthetic connexion was not contained in experience regarded as given material. Thus neither the formal nor the material aspect of conscious experience, when regarded from the individualist point of view, supplied any foundation for real knowledge, whether *a priori* or empirical. An absolutely new conception of experience was necessary, if the fact of cognition was to be explained at all, and the various modes in which Kant expresses the business of his critical philosophy were merely different fashions of stating the one ultimate problem, differ-

ing according to the particular aspect of knowledge which he happened to have in view. To inquire how synthetic *a priori* judgments are possible, or how far cognition extends, or what worth attaches to metaphysical propositions, is simply to ask, in a specific form, what elements are necessarily involved in experience of which the subject is conscious. How is it possible for the individual thinking subject to connect together the parts of his experience in the mode we call cognition?

The problem of the critical philosophy is, therefore, the complete analysis of experience from the point of view of the conditions under which such experience is possible for the conscious subject. The central ideas are thus self-consciousness, as the supreme condition under which experience is subjectively possible, and the manifold details of experience as a varied and complex whole. The solution of the problem demanded the utmost care in keeping the due balance between these ideas; and it can hardly be said that Kant was perfectly successful. He is frequently untrue to the more comprehensive conception which dominates his work as a whole. The influence of his previous philosophical training, nay, even the unconscious influence of terminology, frequently induces in his statements a certain laxity and want of clearness. He selects definitely for his starting point neither the idea of self-consciousness nor the details of experience, but in his actual procedure passes from one to the other, rarely, if ever, taking into full consideration the weighty question of their relation to one another. Above all, he is continuously under the influence of the individualist notion which he had done so much to explode. The conception of conscious experience, which is the net result of the *Kritik*, is indefinitely profounder and richer than that which had ruled the 18th century philosophizing, but for Kant such experience still appears as somehow the arbitrary product of the relation between the individual conscious subject and the realm of real facts. When he is actually analysing the conditions of knowledge, the influence of the individualist conception is not prominent; the conditions are stated as quite general, as conditions of knowledge. But so soon as the deeper, metaphysical problems present themselves, the shadow of the old doctrine reappears. Knowledge is regarded as a mechanical product, part furnished by the subject, part given to the subject, and is thus viewed as mechanically divisible into *a priori* and *a posteriori*, into pure and empirical, necessary and contingent. The individual as an agent, conscious of universal moral law, is yet regarded as in a measure opposed to experience, and the Kantian ethical code remains purely formal. The ultimate relation between intelligence and natural fact, expressed in the notion of end, is thought as problematic or contingent. The difficulties or obscurities of the Kantian system, of which the above are merely the more prominent, may all be traced to the one source, the false or at least inadequate idea of the individual. The more thorough explanation of the relation between experience as critically conceived and the individual subject was the problem left by Kant for his successors.

In any detailed exposition of the critical system it would be requisite in the first place to state with some fulness the precise nature of the problems immediately before Kant, and in the second place to follow with some closeness the successive stages of the system as presented in the three main works, the *Kritik of Pure Reason*, the *Kritik of Practical Reason*, and the *Kritik of Judgment*, with the more important of the minor works, the *Metaphysics of Nature* and the *Metaphysics of Ethics*. It would be necessary, also, in any such expanded treatment, to bring out clearly the Kantian classification of the philosophical sciences, and to indicate the relation between the critical or transcendental investigation of the several faculties and the more developed sciences to which that investigation serves as introduction. As any detailed statement of the critical system, however compressed, would be beyond the limits of the present article, it is proposed here to select only the more salient doctrines, and to point out in connexion with them what advance had been effected by Kant, and what remained for subsequent efforts at complete solution of the problems raised by him. Much that is of interest and value must necessarily be omitted in any sketch of so elaborate a system, and for all points of special interpretation reference must needs be made to the many elaborate dissertations on or about the Kantian philosophy.

The doctrine from which Kant starts in his critical or transcendental investigation of knowledge is that to which the slow development of his thought had led him. The essence of cognition or knowledge was a synthetic act, an act of combining in thought the detached elements of experience. Now synthesis was explicable neither by reference to pure thought, the logical or elaborative faculty, which in Kant's view remained analytic in function, nor by reference to the effects of external real things upon our faculties of cognition. For, on the one hand, analysis or logical treatment applied only to objects of knowledge as already given in synthetic forms, and, on the other hand, real things could yield only isolated effects and not the combination of these effects in the forms of cognitive experience. If experience is to be matter of knowledge for the conscious subject, it must be regarded as the conjoint product of given material and synthetic combination. Form and matter



may indeed be regarded separately and dealt with in isolation for purposes of critical inquiry, but in experience they are necessarily and inseparably united. The problem of the *Kritik* thus becomes for Kant the complete statement of the elements necessarily involved in synthesis, and of the subjective processes by which these elements are realized in our individual consciousness. He is not asking, with Locke, whence the details of experience arise; he is not attempting a natural history of the growth of experience in the individual mind; but he is endeavouring to state exhaustively what conditions are necessarily involved in any fact of knowledge, *i.e.*, in any synthetic combination of parts of experience by the conscious subject.

So far as the elements necessarily involved in conscious experience are concerned, these may be enumerated briefly thus:—given data of sense, inner or outer; the forms of perception, *i.e.*, space and time; the forms of thought, *i.e.*, the categories; the ultimate condition of knowledge, the identity of the pure ego or self. The ego or self is the central unity in reference to which alone is any part of experience cognizable. But the consciousness of self is the foundation of knowledge only when related to given material. The ego has not in itself the element of difference, and the essence of knowledge is the consciousness of unity in difference. For knowledge, therefore, it is necessary that difference should be given to the ego. The modes under which it is possible for such given difference to become portion of the conscious experience of the ego, the modes under which the isolated data can be synthetically combined so as to form a cognizable whole, make up the form of cognition, and upon this form rests the possibility of any *a priori* or rational knowledge.

The notion of the ego as a purely logical unity, containing in itself no element of difference, and having only analytic identity, is fundamental in the critical system, and lies at the root of all its difficulties and perplexities. To say that the ego as an individual does not produce the world of experience is by no means the same as to say that the ego is pure unity without element of difference. In the one case we are treating the ego as one of the objects of experience and denying of it productive efficacy; in the second case we are dealing with the unity of the ego as a condition of knowledge, of any experience whatsoever. In this second sense, it is wholly wrong to assert that the ego is pure identity, pure unity. The unity and identity of the ego, so regarded, are taken in abstraction, *i.e.*, as dis severed from the more complex whole of which they are necessary elements. When the ego is taken as a condition of knowledge, its unity is not more important than the difference necessarily correlated with it. That the ego as a thing should not produce difference is quite beside the mark. The consequences of the abstract separation which Kant so draws between the ego and the world of experience are apparent throughout his whole system. Assuming at the outset an opposition between the two, self and matter of knowledge, he is driven by the exigencies of the problem of reconciliation to insert term after term as means of bringing them together, but never succeeds in attaining a junction which is more than mechanical. To the end, the ego remains, partly the pure logical ego, partly the concrete individual spirit, and no explanation is afforded of the relation between them. It is for this reason that the system of forms of perception and categories appears so contingent and haphazard. No attempt is made to show how or why the difference supplied for the pure logical ego should present itself necessarily under these forms. They are regarded rather as portions of the subjective mechanism of the individual consciousness. The mind or self appears as though it were endowed with a complex machinery by which alone it could act upon the material supplied to it. Such a crude conception is far, indeed, from doing justice to Kant's view, but it undoubtedly represents the underlying assumption of many of his cardinal doctrines. The philosophy of Fichte is historically interesting as that in which the deficiencies of Kant's fundamental position were first discerned and the attempt made to remedy them.

Unfortunately for the consistency of the *Kritik*, Kant does not attempt to work out systematically the elements involved in knowledge before considering the subjective processes by which knowledge is realized in consciousness. He mixes up the two inquiries, and in the general division of his work depends rather upon the results of previous psychology than upon the lines prescribed by his own new conception of experience. He treats the elements of cognition separately in connexion with the several subjective processes involved in knowledge, *viz.*, sense and understanding. Great ambiguity is the natural result of this procedure. For it was not possible for Kant to avoid the misleading connotation of the terms employed by him. In strictness sense, understanding, imagination, and reason ought to have had their functions defined in close relation to the elements of knowledge with which they are severally connected, and as these elements have no existence as separate facts, but only as factors in the complex organic whole, it might have been possible to avoid the error of supposing that each subjective process furnished a distinct, separately cognizable portion of a mechanical whole. But the use of separate terms, such as sense and understanding, almost unavoidably led to phraseology only interpretable as signifying that each furnished a specific kind of

knowledge, and all Kant's previous training contributed to strengthen this erroneous view. Especially noteworthy is this in the case of the categories. Kant insists upon treating these as *Begriffe*, notions, and assigns to them certain characteristics of notions. But it is readily seen, and in the *Logik* Kant shows himself fully aware of the fact, that these pure connective links of experience, general aspects of objects of intelligible experience, do not resemble concepts formed by the so-called logical or elaborative processes from representations of completed objects. Nothing but harm can follow from any attempt to identify two products which differ so entirely. So, again, the *Asthetik* is rendered extremely obscure and difficult by the prevalence of the view, already noted as obtaining in the *Dissertation*, that sense is a faculty receiving representations of objects. Kant was anxious to avoid the error of Leibnitz, who had taken sense and understanding to differ in degree only, not in kind; but in avoiding the one error he fell into another of no less importance.

The consideration of the several elements which in combination make up the fact of cognition, or perception, as it may be called, contains little or nothing bearing on the origin and nature of the given data of sense, inner or outer. The manifold of sense, which plays so important a part in the critical theory of knowledge, is left in an obscure and perplexed position. So much is clear, however, that according to Kant sense is not to be regarded as receptive of representations of objects. The data of sense are mere *stimuli*, not partial or confused representations. The sense-manifold is not to be conceived as having, *per se*, any of the qualities of objects as actually cognized; its parts are not cognizable *per se*, nor can it with propriety be said to be received successively or simultaneously. When we apply predicates to the sense-manifold regarded in isolation, we make that which is only a factor in the experience of objects into a separate, independent object, and use our predicates transcendently. Kant is not always in his language faithful to his view of the sense-manifold, but the theory as a whole, together with his own express definitions, is unmistakable. On the origin of the data of sense, Kant's remarks are few and little satisfactory. He very commonly employs the term *affection* of the faculty of sense as expressing the mode of origin, but offers no further explanation of a term which has significance only when interpreted after a somewhat mechanical fashion. Unquestionably certain of his remarks indicate the view that the origin is to be sought in things-in-themselves, but against hasty misinterpretations of such remarks there are certain cautions to be borne in mind. The relation between phenomena and noumena in the Kantian system does not in the least resemble that which plays so important a part in modern psychology—between the subjective results of sense affection and the character of the objective conditions of such affection. Kant has pointedly declared that it would be a gross absurdity to suppose that in his view separate, distinct things-in-themselves existed corresponding to the several objects of perception. And, finally, it is not at all difficult to understand why Kant should say that the affection of sense originated in the action of things-in-themselves, when we consider what was the thing-in-itself to which he was referring. The thing-in-itself to which the empirical order and relations of sense-experience are referred is the divine order, which is not matter of knowledge, but involved in our practical or moral beliefs. Critics who limit their view to the *Kritik of Pure Reason*, and there, in all probability, to the first or constructive portion of the work, must necessarily fail to interpret the doctrines of the Kantian system, which do not become clear or definite till the system has been developed. Reason was, for Kant, an organic whole; the speculative and moral aspects are never severed; and the solution of problems which appear at first sight to belong solely to the region of speculative thought may be found ultimately to depend upon certain characteristics of our nature as practical.

Data of sense-affection do not contain in themselves synthetic combination. The first conditions of such combination are found by Kant in the universal forms under which alone sense-phenomena manifest themselves in experience. These universal forms of perception, space and time, are necessary, *a priori*, and in characteristic features resembling intuitions, not notions. They occupy, therefore, a peculiar position, and one section of the *Kritik*, the *Asthetik*, is entirely devoted to the consideration of them. It is important to observe that it is only through the *a priori* character of these perceptive forms that rational science of nature is at all possible. Kant is here able to resume, with fresh insight, his previous discussions regarding the synthetic character of mathematical propositions. In his early essays he had rightly drawn the distinction between mathematical demonstration and philosophic proof, referring the certainty of the first to the fact that the constructions were synthetic in character and entirely determined by the action of constructive imagination. It had not then occurred to him to ask, With what right do we assume that the conclusions arrived at from arbitrary constructions in mathematical matter have applicability to objects of experience? Might not mathematics be a purely imaginary science? To this question he is now enabled to return an



answer. Space and time, the two essential conditions of sense-perception, are not data given by things, but universal forms of intellect into which all data of sense must be received. Hence, whatever is true of space and time regarded by imagination as objects, *i.e.*, quantitative constructions, must be true of the objects making up our sense-experience. The same forms and the same constructive activity of imagination are involved in mathematical synthesis and in the constitution of objects of sense-experience. The foundation for pure or rational mathematics, there being included under this the pure science of movement, is thus laid in the critical doctrine of space and time.

The *Asthetik* isolates sense perception, and considers its forms as though it were an independent, complete faculty. A certain confusion, arising from this, is noticeable in the *Analytik* when the necessity for justifying the position of the categories is under discussion, but the real difficulty in which Kant was involved by his doctrine of space and time has its roots even deeper than the erroneous-isolation of sensibility. He has not in any way "deduced" space and time, but, proceeding from the ordinary current view of sense-experience, has found these remaining as residuum after analysis. The relation in which they stand to the categories or pure notions is ambiguous; and, when Kant has to consider the fashion in which category and data of sense are to be brought together, he merely places side by side as *a priori* elements the pure connective notions and the pure forms of perception, and finds it, apparently, only a matter of contingent convenience that they should harmonize with one another and so render cognition possible. To this point also Fichte was the first to call attention.

Affection of sense, even when received into the pure forms of perception, is not matter of knowledge. For cognition there is requisite synthetic combination, and the intellectual function through which such combination takes place. The forms of intellectual function Kant proceeds to enumerate with the aid of the commonly received logical doctrines. For this reference to logic he has been severely blamed, but the precise nature of the debt due to the commonly accepted logical classification is very generally misconceived. Synthetic combination, Kant points out, is formally expressed in a judgment, which is the act of uniting representations. At the foundation of the judgments which express the types of synthetic combination, through which knowledge is possible, lie the pure general notions, the abstract aspect of the conditions under which objects are cognizable in experience. General logic has also to deal with the union of representations, though its unity is analytic merely, not synthetic. But the same intellectual function which serves to give unity in the analytic judgments of formal logic serves to give unity to the synthetic combinations of real perception. It appeared evident, then, to Kant that in the forms of judgment, as they are stated in the common logic, there must be found the analogues of the types of judgment which are involved in transcendental logic, or in the theory of real cognition. His view of the ordinary logic was wide and comprehensive, though in his restriction of the science to pure form one can trace the influence of his earlier training, and it is no small part of the value of the critical philosophy that it has revived the study of logic and prepared the way for a more thorough consideration of logical doctrines. The position assigned to logic by Kant is not, in all probability, one which can be defended; indeed, it is hard to see how Kant himself, in consistency with the critical doctrine of knowledge, could have retained many of the older logical theorems, but the precision with which the position was stated, and the sharpness with which logic was marked off from cognate philosophic disciplines, prepared the way for the more thoughtful treatment of the whole question.

Formal logic thus yields to Kant the list of the general notions, pure intellectual predicates, or categories, through which alone experience is possible for a conscious subject. It has already been noted how serious was the error involved in the description of these as notions, without further attempt to clear up their precise significance. Kant, indeed, was mainly influenced by his strong opposition to the Leibnitzian rationalism, and therefore assigns the categories to understanding, the logical faculty, without consideration of the question,—which might have been suggested by the previous statements of the *Dissertation*,—what relation these categories held to the empirical notions formed by comparison, abstraction, and generalization when directed upon representations of objects. But when the categories are described as notions, *i.e.*, formed products of thought, there rises of necessity the problem which had presented itself to Kant at every stage of his pre-critical thinking,—with what right can we assume that these notions apply to objects of experience? The answer which he proceeds to give altogether explodes the definition of the categories as formed products of thought, and enables us to see more clearly the nature of the new conception of experience which lies in the background of all the critical work.

The unity of the ego, which has been already noted as an element exterior to the synthesis of cognition, is a unity of a quite distinct and peculiar kind. That the ego to which different

parts of experience are presented must be the same ego, if there is to be cognition at all, is analytically evident; but the peculiarity is that the ego must be conscious of its own unity and identity, and this unity of self-consciousness is only possible in relation to difference not contained in the ego but given to it. The unity of apperception, then, as Kant calls it, is only possible in relation to synthetic unity of experience itself, and the forms of this synthetic unity, the categories, are, therefore, on the one hand, necessary as forms in which self-consciousness is realized, and, on the other hand, restricted in their application and validity to the data of given sense, or the particular element of experience. This experience presents itself as the organic combination of the particular of sense with the individual unity of the ego through the universal forms of the categories. Reference of representations to the unity of the object, synthetic unity of apperception, and subsumption of data of sense under the categories, are thus three sides or aspects of the one fundamental fact.

In this deduction of the categories, as Kant calls it, there appears for the first time an endeavour to connect together into one organic whole the several elements entering into experience. It is evident, however, that much was wanting before this essential task could be regarded as complete. Kant has certainly brought together self-consciousness, the system of the categories and data of sense. He has shown that the conditions of self-consciousness are the conditions of possible experience. But he has not shown, nor did he attempt to show, how it was that the conditions of self-consciousness are the very categories arrived at by consideration of the system of logical judgments. He does endeavour to show, but with small success, how the junction of category and data of sense is brought about, for according to his scheme these stood, to a certain extent at least, apart from and independent of one another. The failure to effect an organic combination of the several elements was the natural consequence of the false start which had been made.

The mode in which Kant endeavours to show how the several portions of cognition are subjectively realized brings into the clearest light the inconsistencies and imperfections of his doctrine. Sense had been assumed as furnishing the particular of knowledge, understanding as furnishing the universal; and it had been expressly declared that the particular was cognizable only in and through the universal. Still, each was conceived as somehow in itself complete and finished. Sense and understanding had distinct functions, and there was wanting some common term, some intermediary which should bring them into conjunction. Data of sense as purely particular could have nothing in common with the categories as purely universal. But data of sense had at least one universal aspect,—their aspect as the particular of the general forms, space and time. Categories were in themselves abstract and valueless, serviceable only when restricted to possible objects of experience. There was thus a common ground on which category and intuition were united in one, and an intermediate process whereby the universal of the category might be so far individualized as to comprehend the particular of sense. This intermediate process—which is really the junction of understanding and sense—Kant calls productive imagination, and it is only through productive imagination that knowledge or experience is actually realized in our subjective consciousness. The specific forms of productive imagination are called *schemata*, and upon the nature of the schema Kant gives much that has proved of extreme value for subsequent thought.

Productive imagination is thus the concrete element of knowledge, and its general modes are the abstract expression of the *a priori* laws of all possible experience. The categories are restricted in their applicability to the schema, *i.e.*, to the pure forms of conjunction of the manifold in time, and in the modes of combination of schemata and categories we have the foundation for the rational sciences of mathematics and physics. Perception or real cognition is thus conceived as a complex fact, involving data of sense and pure perceptive forms, determined by the category and realized through productive imagination in the schema. The system of principles which may be deduced from the consideration of the mode in which understanding and sense are united by productive imagination is the positive result of the critical theory of knowledge, and some of its features are remarkable enough to deserve attention. According to his usual plan, Kant arranges these principles in conformity with the table of the categories, dividing the four classes, however, into two main groups, the mathematical and the dynamical. The mathematical principles are the abstract expression of the necessary mode in which data of sense are determined by the category in the form of intuitions or representations of objects; the dynamical are the abstract expression of the modes in which the existence of objects of intuition is determined. The mathematical principles are constitutive, *i.e.*, express determinations of the objects themselves; the dynamical are regulative, *i.e.*, express the conditions under which objects can form parts of real experience. Under the mathematical principles come the general rules which furnish the ground for the application of quantitative reasoning to real facts of experience. For as data of sense are only possible



objects when received in the forms of space and time, and as space and time are only cognized when determined in definite fashion by the understanding through the schema of number (quantity) or degree (quality), all intuitions are extensive quantities and contain a real element, that of sense, which has degree. Under the dynamical principles, the general modes in which the existence of objects are determined, fall the analogies of experience, or general rules according to which the existence of objects in relation to one another can be determined, and the postulates of experience, the general rules according to which the existence of objects for us or our own subjective existence can be determined. The analogies of experience rest upon the order of perceptions in time, *i.e.*, their permanence, succession, or coexistence, and the principles are respectively those of substance, causality, and reciprocity. It is to be observed that Kant in the expression of these analogies reaches the final solution of the difficulty which had so long pressed upon him, the difficulty as to the relation of the pure connective notions to experience. These notions are not directly applicable to experience, nor do we find in experience anything corresponding to the pure intellectual notions of substance, cause, and reciprocity. But experience is for us the combination of data of sense in the forms of productive imagination, forms determined by the pure intellectual notions, and accordingly experience is possible for us only as in modes corresponding to the notions. The permanent in time is substance in any possible experience, and no experience is possible save through the determination of all changes as in relation to a permanent in time. Determined sequence is the causal relation in any possible experience, and no experience is possible save through the determination of perceived changes as in relation to a determined order in time. So with coexistence and reciprocity.

The postulates of experience are general expressions of the significance of existence in the experience of a conscious subject. The element of reality in such experience must always be given by intuition, and, so far as determination of existence is assumed, external intuition is a necessary condition of inner intuition. The existence of external things is as certain as the existence of the concrete subject, and the subject cannot cognize himself as existing save in relation to the world of facts of external perception. Inner and outer reality are strictly correlative elements in the experience of the conscious subject.

Throughout the positive portion of his theory of cognition, Kant has been beset by the doctrine that the categories, as finished, complete notions, have an import or significance transcending the bounds of possible experience. Moreover, the manner in which space and time had been treated made it possible for him to regard these as contingent forms, necessary for intelligences like ours, but not to be viewed as absolutely necessary. The real meaning of these peculiarities is hardly ever expressed by him, though it is clear that the solution of the matter is to be found in the inadequacy of the positive theory to meet the demands of reason for completed explanation. But the conclusion to which he was led was one of the greatest importance for the after development of his system. Cognition is necessarily limited. The categories are restricted in their application to elements of possible experience to that which is presented in intuition, and all intuition is for the ego contingent. But to assert that cognition is limited and its matter contingent is to form the idea of an intelligence for whom cognition would not be limited and for whom the data of intuition would not be given, contingent facts, but necessarily produced along with the pure categories. This idea of an intuitive understanding is the definite expression for the completed explanation which reason demands, and it involves the conception of a realm of objects for such an understanding, a realm of objects which, in opposition to the *phenomena* of our relative and limited experience, may be called *noumena* or things-in-themselves. The *noumenon*, therefore, is in one way the object of a non-sensuous intuition, but more correctly is the expression of the limited and partial character of our knowledge. The idea of a *noumenon* is thus a limiting notion.

Assuredly, the difficult section of the *Kritik*, on the ground of the distinction between *phenomena* and *noumena*, would not have led to so much misconception as it has done, had Kant then brought forward what lies at the root of the distinction, his doctrine of reason and its functions. Understanding, as has been seen, is the faculty of cognition strictly so called; and within its realm, that of space, time, and matter, positive knowledge is attainable. But the ultimate conception of understanding, that of the world of objects, quantitatively determined, and standing in relation of mutual reciprocity to one another, is not a final ground of explanation. We are still able and necessitated to reflect upon the whole world of *phenomena* as thus cognized, and driven to inquire after its significance. In our reflexion we necessarily treat the objects, not as *phenomena*, as matters of positive, scientific knowledge, but as things-in-themselves, as *noumena*. The distinction between *phenomena* and *noumena* is, therefore, nothing but the expression of the distinction between understanding and reason, a distinction which, according to Kant, is merely subjective.

The specific function of reason is the effort after completed ex-

planation of the experience presented in cognition. But in such effort there are no notions to be employed other than the categories, and these, as has already been seen, have validity only in reference to objects of possible experience. We may expect, then, to find the transcendent employment of the categories leading into various difficulties and inconsistencies. The criticism of reason in its specific aspect throws fresh light on the limits to human knowledge and the significance of experience.

Experience has presented itself as the complex result of relation between the ego or subject and the world of phenomena. Reason may therefore attempt a completed explanation either of the ego of the world of phenomena or of the total relation between them. The three inquiries correspond to the subjects of the three ancient metaphysical sciences, rational psychology, rational cosmology, rational theology. It is readily seen, in regard to the first of them, that all attempts to determine the nature of the ego as a simple, perdurable, immaterial substance rest upon a confusion between the ego as pure logical unity and the ego as object of intuition, and involve a transcendent use of the categories of experience. It profits not to apply such categories to the soul, for no intuition corresponding to them is or can be given. The idea of the soul must be regarded as transcendent. So too when we endeavour, with the help of the categories of quantity, quality, relation, and modality to determine the nature and relation of parts of the world, we find that reason is lauded in a peculiar difficulty. Any solution that can be given is too narrow for the demands of reason and too wide for the restrictions of understanding. The transcendent employment of the categories leads to antinomy, or equally balanced statements of apparently contradictory results. Due attention to the relation between understanding and reason enables us to solve the antinomies and to discover their precise origin and significance. Finally, the endeavour to find in the conception of God, as the supreme reality, the explanation of experience, is seen to lead to no valid conclusion. There is not any intuition given whereby we might show the reality of our idea of a Supreme Being. So far as knowledge is concerned, God remains a transcendental ideal.

The criticism of the transcendental ideas, which is also the examination of the claims of metaphysics to rank as a science, yields a definite and intelligible result. These ideas, the expression of the various modes in which unity of reason may be sought, have no objects corresponding to them in the sphere of cognition. They have not, therefore, like the categories, any *constitutive* value, and all attempts at metaphysical construction with the notions or categories of science must be resigned as of necessity hopeless. But the ideas are not, on that account, destitute of all value. They are supremely significant, as indicating the very essence of the function of reason. The limits of scientific cognition become intelligible, only when the sphere of understanding is subjected to critical reflexion and compared with the possible sphere of reason, that is, the sphere of rationally complete cognition. The ideas, therefore, in relation to knowledge strictly so called, have *regulative* value, for they furnish the general precepts for extension and completion of knowledge, and, at the same time, since they spring from reason itself, they have a real value in relation to reason as the very inmost nature of intelligence. Self-consciousness cannot be regarded as merely a mechanically determined result. Free reflexion upon the whole system of knowledge is sufficient to indicate that the sphere of intuition, with its rational principles, does not exhaust conscious experience. There still remains, over and above the realm of nature, the realm of free, self-conscious spirit; and, within this sphere, it may be anticipated that the ideas will acquire a significance richer and deeper than the merely regulative import which they possess in reference to cognition.

Where, then, are we to look for this realm of free self-consciousness? Not in the sphere of cognition, where objects are mechanically determined, but in that of will or of reason as practical. That reason is practical or prescribes ends for itself is sufficiently manifest from the mere fact of the existence of the conception of morality or duty, a conception which can have no corresponding object within the sphere of intuition, and which is theoretically, or in accordance with the categories of understanding, incognizable. The presence of this conception is the datum upon which may be founded a special investigation of the conditions of reason as practical, a *Kritik* of pure practical reason, and the analysis of it yields the statement of the formal precepts of morality.

The realization of duty is impossible for any being which is not thought as free, *i.e.*, capable of self-determination. Freedom, it is true, is theoretically not an object of cognition, but its impossibility is not thereby demonstrated. The theoretical proof rather serves as useful aid towards the more exact determination of the nature and province of self-determination, and of its relation to the whole concrete nature of humanity. For in man self-determination and mechanical determination by empirical motives coexist, and only in so far as he belongs and is conscious of belonging both to the sphere of sense and to the sphere of reason does moral obligation become possible for him. The supreme end prescribed by reason in its practical aspect, namely, the complete subordination of the empirical



side of nature to the precepts of morality, demands, as conditions of its possible realization, the permanence of ethical progress in the moral agent, the certainty of freedom in self-determination, and the necessary harmonizing of the spheres of sense and reason through the intelligent author or ground of both. These conditions, the postulates of practical reason, are the concrete expressions of the three transcendental ideas, and in them we have the full significance of the ideas for reason. Immortality of the soul, positive freedom of will, and the existence of an intelligent ground of things are speculative ideas practically warranted, though theoretically neither demonstrable nor comprehensible.

Thus reason as self-determining supplies notions of freedom; reason as determined supplies categories of understanding. Union between the two spheres, which seem at first sight disparate, is found in the necessary postulate that reason shall be realized, for its realization is only possible in the sphere of sense. But such a union, when regarded in *abstracto*, rests upon, or involves, a notion of quite a new order, that of the adaptation of nature to reason, or, as it may be expressed, that of end in nature. Understanding and reason thus coalesce in the faculty of *judgment*, which mediates between, or brings together, the universal and particular elements in conscious experience. Judgment is here merely *reflective*; that is to say, the particular element is given, so determined as to be possible material of knowledge, while the universal, not necessary for cognition, is supplied by reason itself. The empirical details of nature, which are not determined by the categories of understanding, are judged as being arranged or ordered by intelligence, for in no other fashion could nature, in its particular, contingent aspect, be thought as forming a complete, consistent, intelligible whole.

The investigation of the conditions under which adaptation of nature to intelligence is conceivable and possible makes up the subject of the third great *Kritik*, the *Kritik of Judgment*, a work presenting unusual difficulties to the interpreter of the Kantian system. The general principle of the adaptation of nature to our faculties of cognition has two specific applications, with the second of which it is more closely connected than with the first. In the first place, the adaptation may be merely *subjective*, when the empirical condition for the exercise of judgment is furnished by the feeling of pleasure or pain; such adaptation is æsthetic. In the second place, the adaptation may be objective or logical, when empirical facts are given of such a kind that their possibility can be conceived only through the notion of the end realized in them; such adaptation is teleological, and the empirical facts in question are organisms.

Æsthetics, or the scientific consideration of the judgments resting on the feelings of pleasure and pain arising from the harmony or want of harmony between the particular of experience and the laws of understanding, is the special subject of the *Kritik of Judgment*, but the doctrine of teleology there unfolded is the more important for the complete view of the critical system. For the analysis of the teleological judgment and of the consequences flowing from it leads to the final statement of the nature of experience as conceived by Kant. The phenomena of organic production furnish data for a special kind of judgment, which, however, involves or rests upon a quite general principle, that of the contingency of the particular element in nature and its subjectively necessary adaptation to our faculty of cognition. The notion of contingency arises, according to Kant, from the fact that understanding and sense are distinct, that understanding does not determine the particular of sense, and, consequently, that the principle of the adaptation of the particular

to our understanding is merely supplied by reason on account of the peculiarity or limited character of understanding. End in nature, therefore, is a subjective or problematic conception, implying the limits of understanding, and consequently resting upon the idea of an understanding constituted unlike ours,—of an intuitive understanding in which particular and universal should be given together. The idea of such an understanding is, for cognition, transcendent, for no corresponding fact of intuition is furnished, but it is realized with practical certainty in relation to reason as practical. For we are, from practical grounds, compelled with at least practical necessity to ascribe a certain aim or end to this supreme understanding. The moral law, or reason as practical, prescribes the realization of the highest good, and such realization implies a higher order than that of nature. We must, therefore, regard the supreme cause as a moral cause, and nature as so ordered that realization of the moral end is in it possible. The final conception of the Kantian philosophy is, therefore, that of ethical teleology. As Kant expresses it in a remarkable passage of the *Kritik*, "The systematic unity of ends in this world of intelligences, which, although as mere nature it is to be called only the world of sense, can yet as a system of freedom be called an intelligible, *i.e.*, moral world (*regnum gratiæ*), leads inevitably to the teleological unity of all things which constitute this great whole according to universal natural laws, just as the unity of the former is according to universal and necessary moral laws, and unites the practical with the speculative reason. The world must be represented as having originated from an idea, if it is to harmonize with that use of reason without which we should hold ourselves unworthy of reason—*viz.*, the moral use, which rests entirely on the idea of the supreme good. Hence all natural research tends towards the form of a system of ends, and in its highest development would be a physico-theology. But this, since it arises from the moral order as a unity grounded in the very essence of freedom and not accidentally instituted by external commands, establishes the teleology of nature on grounds which *a priori* must be inseparably connected with the inner possibility of things. The teleology of nature is thus made to rest on a transcendental teleology, which takes the ideal of supreme ontological perfection as a principle of systematic unity, a principle which connects all things according to universal and necessary natural laws, since they all have their origin in the absolute necessity of a single primal being" (p. 538).

*Editions of Kant's Works.*—The standard collective editions are (1) that by Rosenkranz and Schubert, 12 vols., 1838-42, containing in vol. ii. the *Life* by Schubert, and in vol. xi. a *History of the Kantian Philosophy* by Rosenkranz; (2) that by Hartenstein, in 10 vols., 1838-39; (3) a second edition by Hartenstein, in 8 vols., 1867-69, in which the arrangement is strictly chronological; (4) that by Kirchmann, in 8 vols., 1868. Convenient editions of the three *Kritiks* have been published by Kehrbach, and critical editions of the *Prolegomena* and *Kritik d. r. Vernunft* by B. Erdmann, whose treatise *Kants Kriticismus in d. ersten und zweiten Auflage d. Kr. d. r. Vernunft*, 1878, and pamphlet, *Nachtrage zu K. Kr. d. r. Vernunft*, 1881, contain much interesting matter.

Of works upon the Kantian philosophy the number is very great. A brief notice of them is given in the bibliographical references in Ueberweg's *Gesch. d. Philosophie*, Bd. iii., §§ 18-20. A very comprehensive survey is contained in the recent work by H. Vaihinger, *Commentar zu Kants Kritik der reinen Vernunft*, 1881, where the older and more recent literature is elaborately classified and briefly characterized. (R. AD.)

APPENDIX

AMERICAN REVISIONS AND ADDITIONS

TO THE

ENCYCLOPÆDIA BRITANNICA

(NINTH EDITION.)

A DICTIONARY OF

ARTS, SCIENCES AND GENERAL LITERATURE

BY

W. H. DE PUY, DD., LL.D.,

ASSISTED BY A CORPS OF TRAINED WRITERS.

CHICAGO

R. S. PEALE COMPANY

1892



---

COPYRIGHT 1891,  
BY R. S. PEALE & CO.

---

ally in many counties; and these fairs embrace usually mechanical products of city and country throughout their districts. See *WORLD'S FAIRS*, in these Revisions and Additions.

**INFANTE**, the title given in Spain and Portugal to the princes of the royal family, the corresponding title of *infanta* being given to the princesses. The personal domain of an infante or infanta is called the *infantado*.

**INFANTRY, AMERICAN**, see *ARMY OF THE UNITED STATES*, in these Revisions and Additions.

**INFANT SCHOOLS**. Pastor Oberlin may be regarded as the founder of infant schools. The education and training of young children were also matters of great interest and study to Pestalozzi. The most successful system of educating quite young children is the Kindergarten. See *Britannica*, Vols. XIV, p. 79; XVII, p. 704.

**INFERTMENT**, a Scotch law term, used to denote the symbolical giving possession of land, which was the completion of the title, the mere conveyance not being enough. The instrument of sasine was the notarial instrument embodying the fact of infertment.

**IN FORMA PAUPERIS** ('in the character of a poor person'). Persons are said to sue *in forma pauperis* when the law allows them to conduct lawsuits without paying fees to court-officers, counsel, or solicitors. A suitor *in forma pauperis* is not entitled to costs unless by order of the court.

**INFUSIONS**, aqueous solutions of vegetable substances obtained without the aid of boiling. In this respect they differ from decoctions, in the manufacture of which boiling is resorted to. Infusions are prepared by digesting the vegetable substance in hot or cold water in a covered earthenware vessel. In preparing the infusion of calumba, cold water is preferable, because it takes up the bitter principle, which is the essential ingredient, and leaves the starch-matter undissolved. In most cases, however, boiling water is employed. Infusions are preferred to decoctions when the active principle volatilises at a boiling heat, or when ebullition readily induces some chemical change. Infusions may also be prepared by percolation, a process extensively employed in the preparation of tinctures. When thus prepared they are less liable to decay than when prepared on the old system.

**INGALLS, JOHN JAMES**, a United States Senator, born in 1833. He graduated at Williams College in 1855 and was admitted to the Massachusetts bar in 1857, and the following year went to Kansas. In 1860 he was secretary of the Territorial Council; was Secretary of State in 1861, and a member of the State Senate in 1862. In 1873 he became a member of the United States Senate as a Republican, and was reelected in 1879 and 1885. His term of office expired March 3, 1891.

**INGELOW, JEAN**, an English poetess, born at Boston, Lincolnshire, in 1830. Her father being of superior culture gave Jean, who was very reserved, an unusually good education. A volume of *Poems* published in 1863 established her reputation as a poetess, and the *Songs of Seven* and the *High Tide on the Coast of Lincolnshire*, etc., increased her fame. Her prose works include *Studies for Stories*; *Stories Told to a Child*; *Mopsa, the Fairy*; *Off the Skelligs*; *Fated to be Free*; *Sarah de Berenger*, and *Don John*.

**INGERSOLL, CHARLES JARED** (1782-1862), an American statesman. He was admitted to the Pennsylvania bar, and was attached to the United States embassy to France. From 1813 to 1815 he was in Congress, and then became United States district attorney, which office he held till 1829.

Shortly afterward he served in the legislature, and in 1837 became secretary of legation to Prussia. From 1841 to 1847 he was again in Congress, and distinguished himself as a Democratic leader. He contributed extensively to various periodicals, and wrote *Edwy and Elgira* (1801); *Inchiquin the Jesuit's Letters on American Literature and Politics* (1810); and *Historical Sketch of the Second War Between the United States and Great Britain* (1852).

**INGERSOLL, JARED** (1749-1822), an American jurist. He became a prominent lawyer, and espoused the cause of the colonies in the Revolution. He was twice attorney-general of Pennsylvania, and was United States district attorney for the eastern district of Pennsylvania. At the time of his death he was judge of the district court of Pennsylvania county.

**INGERSOLL, JOSEPH REED** (1786-1868), an American lawyer. He began the practice of law in Philadelphia, Pa., and from 1835 to 1837, and again from 1843 to 1849 was a member of Congress. In 1852 he was appointed minister to England, but the following year retired to private life and devoted himself to literature. He wrote *Secession a Folly and a Crime*; *Memoir of Samuel Breck* (1863); and a translation from the Latin of Roccus's tracts *De Navibus et Naulo* and *De Assecuratione* (1809).

**INGERSOLL, ROBERT GREEN**, an American lawyer, born in 1833. He began the practice of law in Shawneetown, Ill., but in 1857 removed to Peoria. In 1866 he was appointed attorney-general for Illinois, and in 1877 refused the post of minister to Germany. He is well known as a campaign orator, and also by his books and speeches. He has published *The Gods* (1878); *Ghosts* (1879); *Some Mistakes of Moses* (1879); *Lectures Complete* (1883); *Prose Poems and Selections* (1884); and a large number of minor works.

**INGERSOLL**, a town of Oxford county, Ont., Canada, on the Thames River. It contains fine public buildings, and manufactories of woolen goods, cheese, and farm-implements, and carries on a brisk trade in lumber and grain.

**INGLEBY, CLEMENT MANSFIELD**, an English author and Shakespearean scholar, born at Edgbaston, near Birmingham, in 1823, died in 1886. He was professor of logic and metaphysics at the Midland Institute from 1855 to 1858; became foreign secretary to the Royal Society of Literature in 1870, and afterwards vice-president to the society. Among his works on Shakespeare we have his *Complete View of the Shakespeare Controversy*; *Shakespeare Hermeneutics*, and *Shakespeare, the Man and the Book*. His other works include *Outlines of Theoretical Logic*, and an *Introduction to Metaphysics*.

**INGRAHAM, DUNCAN NATHANIEL**, a naval officer, born in 1802. He entered the United States navy as midshipman in 1812; became lieutenant in 1818; commander in 1838; captain in 1855, and chief of the Bureau of Ordnance and Hydrography of the Navy Department in 1856. In 1861 he entered the Confederate naval service, as chief of ordnance, construction and repair, and rose to the rank of commodore. He has served in every war since the Revolution.

**INHAMBANE**, a Portuguese station, capital of a district on the east coast of Africa. It is just south of the tropic of Capricorn, and is beautifully situated at the head of a deep bay, 200 miles northeast of Delagoa Bay. The town dates from 1764, and has 6,500 inhabitants, of whom some 70 only are Europeans. It has a trade in wax, ivory, etc.

**INJECTIONS**, a term applied in medicine to fluids thrown into the passages or cavities of the body by means of a syringe or elastic bag. The fluids thus injected into the rectum or lower bowel



are termed clysters. Hypodermic injections are treated under that head.

INKBERRY, the popular name for *Ilex Glabra*, an elegant shrub found on the Atlantic coast of North America, and much cultivated by florists. It grows from 2 to 4 feet high, has slender, flexible stems, shining evergreen leaves, and produces small black berries.

INLAND BILL OF EXCHANGE, a bill of exchange drawn by and upon persons living in the same country. The rules applicable to foreign bills differ in some respects from those applicable to inland bills.

INMAN, HENRY (1801-1846), an American painter. He entered the studio of John Wesley Jarvis, in New York City, as an apprentice, and at the age of twenty-one opened a studio of his own. He soon acquired a high reputation as a painter of portraits. Among his productions were pictures of William Wirt, Nicholas Biddle, DeWitt Clinton, Martin Van Buren, William Penn, and many other noted persons. He also produced numerous valuable *genre* paintings and landscapes.

INNER HOUSE, the name given in Scotland to the higher divisions of the court of session.

INNES, COSMO, a Scottish antiquary and historian, born at Durris, on Deeside, Sept. 9, 1798, died at Killin, July 31, 1874. He was educated at the Edinburgh high-school, at Glasgow and Oxford, and in 1822 passed as an advocate. In 1840 he became sheriff of Moray and was subsequently appointed clerk to the court of sessions. In 1846 he was elected to the chair of history in the University of Edinburgh. Author of *Scotland in the Middle Ages* (1860), and *Sketches of Early Scotch History* (1861). He also prepared the first volume of *Acts of the Scottish Parliament*, and published a volume of lectures on *Legal Antiquities*.

INNES, THOMAS, a Scottish historian, born at Drumgask, Aberdeenshire, in 1662, died at Paris, Jan. 28, 1744. At fifteen he was sent to Paris, where he studied at the College of Navarre and the Scots College. In 1692 he received priest's orders, and after three years of mission work in Bauffshire returned to Paris, and became prefect of studies in the Scots College. His *Critical Essay on the Ancient Inhabitants of Scotland* (2 vols. 1729) is much the earliest of all scientific histories. It was meant for an introduction to a *Civil and Ecclesiastical History of Scotland*, one volume of which, coming down to Columba's death, he prepared for the press, while another, bringing down the narrative to 831, was left incomplete. The work retains a permanent value.

INNESS, GEORGE, an American landscape-painter, born in 1825. At the age of twenty-one he began landscape-painting in New York City. He then made visits to Europe, and resided in Florence and Rome for some time. He returned to New York about 1868, and from 1871 to 1875 again lived in Italy. Among his best paintings are *The Sign of Promise; Peace and Plenty; Going Out of the Woods; The Valley of the Shadow of Death; Summer Sunshine and Shadow; Pine Grove; American Sunset; St. Peter's; Rome, from the Tiber; A View Near Meadfield, Mass.; An Old Roadway; Long Island; Under the Greenwood; A Summer Morning; In the Woods, and Sunset on the Sea-Shore*.

INNISHERKIN, small island on the south coast of Ireland, belonging to the county of Cork, from the shore of which it is separated by a channel a quarter of a mile in width. It is well cultivated, and contains some extensive slate-quarries. Population about 1,000.

INNOCENTS, HOLY, FEAST OF, OR INNOCENTS' DAY. See CHILDREMAS in these Revisions and Additions.

INNOMINATE ARTERY (*Arteria innominata*), the first large branch given off from the arch of the aorta.

INNUENDO, a part of a pleading in cases of libel and slander, pointing out what was meant and who was meant by the libelous matter or description.

INOCARPUS EDULIS, an evergreen tree of the Pacific islands whose seeds when roasted are said to be used as food by the natives, and to resemble chestnuts in flavor. The tree is allied to the Daphnes, of the order *Thymelaceæ*, and the fruit of the plants of the order is generally poisonous.

INOSIC ACID, a name given by Liebig to an acid found in the mother-liquid in preparing creatine from flesh-juice.

IN PARTIBUS INFIDELIUM (Lat., "in the regions of the unbelievers"). Titular bishops in the Church of Rome were from the 13th century until the pontificate of Leo XIII styled bishops *in partibus infidelium*. They were originally bishops who had no diocese, and took their titles from places where there was no longer a bishop's see. The places conquered by the crusaders in the East were furnished with Roman Catholic bishops, but when these conquests were again lost the popes continued to appoint and consecrate the bishops as a continual protest against the power which had prevailed over their alleged right, and to signify their hope of restitution. In Britain, the assumption of territorial titles being illegal and dangerous, the Roman Catholic bishops actually resident long bore titles derived from such distant places.

INSANITY: in law, a mental condition that does away with individual responsibility through incapacity to distinguish between right and wrong. In its various phases it is fully treated in *Britannica*, Vol. XIII, pp. 95-113.

INSECTIVORA (Lat., insect-eating), an order of mammals, the members of which—shrews, moles, etc.—are mostly terrestrial, nocturnal in habit, and small in size. They feed mainly on insects and small animals, and in adaptation to this diet the summits of the molar teeth are beset with small conical tubercles. A few, as the moles, burrow; a few are aquatic; while the divergent Galeopithecus, if included in this order, has a peculiarity of gliding through the air. Over two hundred living species are known, and many fossils, especially from Tertiary strata. See *Britannica*, Vol. XV, pp. 400-405.

INSECTS AND INSECTICIDES. For an extended article on INSECTS, see *Britannica*, Vol. XIII, pp. 141-154.

"*Insects proper*" have their bodies divided or cut into three very marked portions, the head, thorax, and abdomen, and have usually six legs, two antennæ, or feelers, and two pairs of membranous wings; they breathe through air-holes, called *stigmata*, placed along the sides of the abdomen and connected with air-tubes, called *tracheæ*, which carry the inspired air into every part of the body. Spiders, crabs, and myriapods are not insects proper. Most insects pass through a metamorphosis or several changes of form and habits. In their period of infancy insects are known as *larvæ*. They are worm-like, very voracious, and cast off their skins repeatedly. Grubs, caterpillars, maggots, silkworms, etc., are *larvæ*. Some of them lose their larva form after a while, take no food, and remain at rest in a death-like sleep. This is called their *pupa* state, because in this condition they resemble an infant trussed in bandages. The pupæ from caterpillars are called *chrysalides*, as some of them are adorned with yellow spots, as if they were gilt. Grubs, after their first transformation, are often called *nymphs*. At the end of the second period insects again shed their skins, and come forth fully grown

and usually provided with wings. The winged state is called *imago*. In this, their perfect state, they provide for the continuation of their kind. The larva state lasts the longest, and the adult state the shortest; for they often die immediately after they have laid their eggs. Bees, wasps, and ants, however, continue much longer in their adult state. After this short introduction we mention the most common insects injurious to vegetation.

I. INSECTS INJURIOUS TO GARDEN VEGETABLES.—The *Asparagus Beetle* (*Crioceris Asparagi*) was accidentally introduced into Long Island, N. Y., from Europe in 1860, and has since so multiplied there as to cause a dead loss of some \$50,000 to the asparagus growers on the island. It has recently spread west on the main land of the State of New York. [Fig. 1.] This beetle is blue-black, but the thorax is brick-red. The wing-cases have various markings on their sides. The insect passes the winter in the beetle state under loose bark. When the asparagus is ready to be cut for the table, the beetle comes forth from its winter quarters and lays its eggs. After being hatched out the brood of larvæ eats the tender parts of the plants, and afterwards consumes also the tougher and harder bark of the main stalks. At the end of June the larvæ hide under some rubbish or in the loose ground, form slight cocoons there, and pass into the pupa state. From these pupæ there bursts forth the same season a second brood of beetles, which lays its eggs on the asparagus, and produces in the middle of August a second brood of larvæ or grubs, whence in the same manner, as before, there comes forth in September the brood of beetles destined to reproduce the species in the following spring. These beetles become so numerous as to destroy many asparagus farms of 20 acres in extent. But in 1863 a deliverer appeared in the form of a small, shining, black parasitic fly. This fly lays its eggs in the eggs or larvæ of the asparagus beetles. It develops faster than the latter and destroys it. The damage done by this beetle has therefore been slight since 1863. The straight line in the illustration shows the actual size.

*The American Bean and Pea Weevils.*—(*Bruchus fabæ* and *Bruchus pisi*). The first [Fig. 2] has spread from Rhode Island since 1861. It is similar to the latter, but a little smaller. As many as fourteen larvæ have been counted in a single bean. The little spots where the larvæ entered a pea can always be detected, even in a dry pea; but in the beans these points of entrance become obliterated. The larvæ grow in the beans and peas, while they eat the seeds, and in the end there is nothing but an excrementitious powder left in the pods. The body of these weevils is oval, slightly convex; their feelers are small and bent sideways; their wing-cases do not cover the end of the abdomen. These beetles frequent the leguminous plants. They wound the skin of the tender pods and lay their eggs singly into the wounds. Each of the maggot-like grubs hatched therefrom enters a seed and feeds upon its pulp until fully grown. Persons indulging in early green peas swallow these larvæ very frequently. The pea-weevil is a native of the United States. It has spread from Pennsylvania over the Eastern States. A simple method of checking the ravages of these bugs is to keep seed-beans and seed-peas in tight vessels over one year before planting them, and to put them in hot water just before they are planted, so as to kill the weevils.

*Cabbage Butterfly, White Butterfly, Potherb Butterfly* (*Pieris oleracea*).—In May and June these butterflies are seen fluttering over cabbage, radish and turnip beds for the purpose of depositing their eggs. These are fastened to the undersides of the

leaves. Their wings are white with little black marks; their antennæ short; and their flight lazy and lumbering. [Fig. 3.] Their eggs are hatched in a week, and the caterpillars produced from them are one and one-half inches long, and of pale green color. In devouring the cabbage, they begin at any place on the under-side of the leaves and eat irregular holes through them. Besides cabbages they eat cauliflower, spinach, turnips, beets carrots, mignonettes, etc.

To the same species of insects belong the *Rape Butterfly* (*Pieris rapæ*) and the *Southern Cabbage Butterfly* (*Pieris protodice*).

*The Zebra Caterpillar* [Fig. 4], is also destructive to cauliflowers, cabbages and beets. It is two inches in length, velvety black, with a red head, red legs, and with two longitudinal yellow lines on the sides, between which are numerous transverse white lines that give it the name. It changes to the chrysalis [Fig. 5], within a rude cocoon formed just under the surface of the ground by interweaving a few grains of sand or particles of dirt with silken threads. The moth, which is called the "Painted Mamestra" (*Mamestra picta*) appears in mid-summer. It is a prettily marked species; the front wings are purple-brown with round spots; the hind wings are white. There are two broods of this insect each year, one in August and the other in October. On account of the gregarious habit when young they are easily destroyed in their larva state.

The *Squash-bug* (*Coreus tristis*) punctures the leaves of squashes. It lays its eggs at the end of June (in the Northern States), depositing them in little patches, brownish-yellow, and glued to the squash leaves. They soon hatch, and the larvæ, or young bugs, are more rounded in shape than the perfect insects. [Fig. 6.] They remain in clusters until grown, penetrate the leaves with their beaks, living upon the juice of the leaves until they wither and die. Then the bugs pass to fresh leaves. Where the squash-bugs are numerous they become very destructive. Their eggs are not all laid at one time, and being hatched in successive broods, they are found in various stages of growth during the summer. During September and October they appear in their perfect state, that is, they get their wings and wing-covers. In color they are them rusty-black above and dirty ochre-yellow beneath. Their odor is that of an "over-ripe" pear, but more repulsive. Squash-bugs must be destroyed before they have laid their eggs. This is easily done by hand picking. If it has been omitted, the patches of eggs and clusters of young bugs must be crushed between the thumb and forefinger.

II. INSECTS INJURIOUS TO ROOT CROPS AND INDIAN CORN. *The Corn-worm, Boll-worm* (*Heliothis armigera*).—Although the corn-worm feeds on corn and the boll-worm on cotton bolls, they are identically the same insect, producing exactly the same species of moth. It attacks corn in the ear, at first feeding on the "silk," but afterwards devouring the kernels at the top end, being securely sheltered the while within the husk. But they generally disappear when the corn fully ripens. Besides ravaging corn and cotton crops this gluttonous worm eats itself into tomatoes, young pumpkins, and various green fruit, causing such fruit to rot. [Fig. 7.] It also eats green peas and beans. In 1860—the year of the great drouth in Kansas—the crop in that State was mostly ruined by the corn-worm. In color the young worms are from pale-green to dark-brown. The body has longitudinal light and dark lines and is covered with black spots which give rise to soft hairs. When full-grown the worm descends into the ground, and there forms an oval



cocoon of earth interwoven with silk, wherein it changes to a bright chestnut-brown chrysalis. After 3-4 weeks the moth makes its escape. In this last and perfect state the front wings are clay-yellow, marked and variegated with olive and yellowish brown, a dark spot near the middle of each wing being conspicuous. The hind wings are paler and have a dark brown band at the edge. [Fig. 8.]

The only remedy when the corn-worms infest corn is to kill them by hand. Their presence can be detected in the corn fields by the silk becoming prematurely dry and partly eaten.

*The White Grub, June Bug (Lachnosterna fusca).—* Few people are aware that the frequent White Grub and the familiar May-bug or June-bug are

different forms of the same insect. These beetles come often into the lighted rooms in May and June, buzz about and knock themselves against the walls [Fig. 9a]. Vast swarms of them are outside upon the trees. They are very voracious, and therefore destructive to trees and shrubs, sometimes completely denuding them of their foliage. They attack fruit-trees and ornamental trees alike, but always only at night. The beetle is an inch long, has long and slender legs and sharp claws, by which it can hold to the foliage. It is of a dark chestnut color and finely punctured.

Soon after pairing the female bug deposits from 40 to 50 eggs in the ground, and soon dies. The eggs hatch in a month. The young grubs subsist

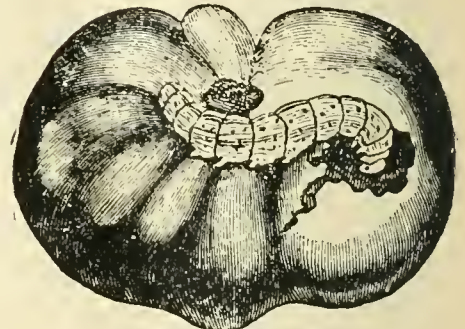
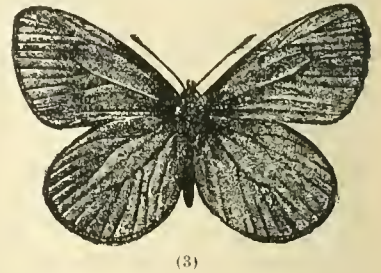
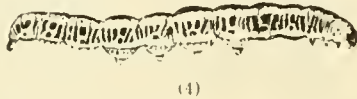

(7) BOLL WORM (*Heliothis armigera*) FEEDING UPON TOMATO.



(9a) JUNE BUG.

(9b) WHITE GRUB.

on small roots for two years. They cut them off below the surface, and the plant wilts and dies. This happens to Indian corn, to grass, to tender lettuce in the garden, to strawberries, potatoes, and all kinds of flowering plants. When two years old, this grub is as large as one's little finger. [Fig. 9b.] It is soft, dirty-white, and has a mahogany colored head. It is usually found with its body curved in a semi-circle, though it can straighten itself out and crawl slowly. In the third year the May-bugs form an egg-shaped chamber by sticking particles of earth together with an adhesive fluid. In this they pass their pupa state. In June of the same year the change into the perfect beetle is completed.

An insect related to the June-bug is known in England as cockchafer and in France as *Hanneton*. The French government has offered a prize for a remedy against it.

The best destroyer of this insect is the crow. The skunk also kills large numbers of them. In some parts of Europe children follow the plow and pick the larvæ up as they are exposed. The perfect beetles are often shaken from the trees into sheets and collected by pailfuls. This must be done in the early morning, when they do not attempt to fly.

*The Potato-stalk Weevil (Baridius trinotatus).—* This insect is abundant in the southern parts of Illinois,

Indiana and Missouri. [Fig.10.] The female deposits an egg in a slit made in a potato stalk with its beak. The larva, after being hatched, bores into the heart of the stalk, and then works itself down towards the root. After passing through the pupa state within the stalk it comes forth in the beetle state at the end of August. The stalk inhabited by the larva always wilts and generally dies. The perfect beetle must live through the winter to reproduce its species in the following spring. In many potato-fields the vines become prematurely decayed by the ravages of the insect, and look as if they had been scalded.

The *Potato-worm* or *Tomato-worm* (*Sphinx quinquemaculata*). This is a large green caterpillar with a kind of thorn or horn upon its tail, and oblique whitish stripes on the sides of the body. [Fig. 20.] It devours the leaves of the potato to the injury of the plant. It grows to the thickness of the fore-finger and the length of three inches. At the beginning of September it crawls down the stem of the plant

and buries itself in the ground. Here in a few days it throws off its caterpillar-skin, and becomes a chrysalis of a bright brown color, with a long and slender tongue-case bent over from the head, so as to touch the breast only at the end, and somewhat resembling the handle of a pitcher. [Fig. 21.] In the following summer the chrysalis-skin bursts open, a large moth crawls out of it, mounts upon some neighboring plant, and in the evening it flies around in search of food. This large insect measures 5 inches across its spread wings, is of gray color with blackish lines and bands, and has five round orange-colored spots on each side of the body, for which the English entomologists call it the "Five-spotted Sphinx." Its tongue can be unrolled to the length of 5 or 6 inches; but when not in use is coiled like a watch-spring. [Fig. 22.]

The *Colorado Potato Beetle* (*Doryphora decemlineata*). Mr. Thomas Say, the zoölogist of the Government expedition to the Northwest Territories in 1819 and 1820, found numerous specimens of

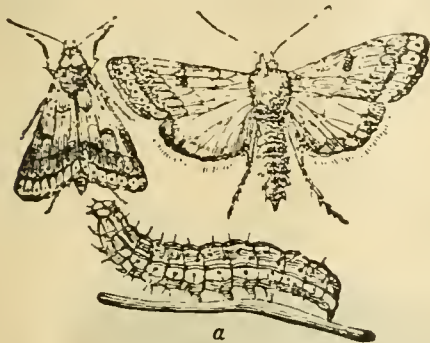

(18) a. LARVA; b. MOTH, WINGS OPEN; c. MOTH, WINGS CLOSED.



(13)



(17)



(17)



(19)



(16)



(14)

a beetle on the Upper Missouri, near the base of the Rocky Mountains. It fed on a wild species of *Solanum* (*S. rostratum*), a plant belonging to the same genus as the cultivated potato (*Solanum tuberosum*). These beetles spread eastwards at the rate of 60 to 75 miles each year, after they once found food in the potato fields of Colorado, Kansas, Missouri, Iowa, Nebraska and Illinois. They increased so enormously as to become the greatest pest that ever afflicted western farmers.

The female beetles deposit their eggs on the under side of the potato leaves, in clusters of from 20 to 50, or more. They are orange-colored, and hatch in a week after being laid. The grubs feed on the leaves till fully grown. Then they bury themselves in the ground, and after ten days come forth as perfect winged insects. Two to four broods are perfected during the summer. The last brood descends into the ground in the beetle state and remains dormant during winter, reappearing in the next spring to devour the first shoots of the potato plants. In the larvæ of the potato-beetle the sides

are ornamented with two rows of black dots, and the head is black. The perfect beetle has ten black stripes on its front wings, which give it the name of the "10-lineata."

To destroy this insect, some kill the females as they come out of the ground in spring; others destroy the larvæ a few days later, when they have commenced feeding upon the leaves. This is done by dusting Paris green or other arsenical poisons, mixed with powdered plaster or flour, over the potato plants while wet with dew or rain. The operator must be careful not to inhale any of these poisons while at work.

III. INSECTS INJURIOUS TO THE CEREAL GRAINS AND GRASS CROPS.—The Chinch Bug (*Lygus leucopterus*). The mature chinch-bug is  $\frac{1}{8}$  of an inch long, has white wing-covers with a large black spot [Fig. 12]. The rest of the body is black and downy. It lives in most of our states. Such chinch-bugs as survive the autumn pass the winter as perfect insects in some hiding place, as under dead leaves, rubbish, straw, etc., in the usual torpid state. In



the spring the female lays its eggs, about 500, in the ground, generally upon the roots of plants. The larvæ, after they hatch out, remain under ground for some time, sucking the sap from the roots. The roots of wheat plants in a field infested with chinch-bugs have large clusters of these larvæ sticking to them. They look like so many moving little red atoms.

The chinch-bugs infest dry loose ground in the Southern and Southwestern States. They travel in immense solid columns from field to field, like locusts, destroying everything as they proceed, but especially corn and wheat fields. They sometimes cover the roads, fences, teams, workmen—pass through houses, corn-cribs, orchards, meadows—one creeping mass of stinking life, like the lice-pest in Egypt. But they are generally gone after a few days.

A simple and cheap method of treating this pest has been devised by Wilson Phelps, of Crete, Ill. It is this: With twelve bushels of spring wheat mix

one bushel of winter rye, and sow in the usual manner. The rye not heading out, but spreading out close to the ground, the bugs content themselves with eating it until the wheat is too far advanced to be injured by them.

*The Hessian Fly* (*cidomyia destructor*) [Fig. 13].—This insect obtained its name from the supposition that the Hessian troops in the British service had brought it here. As no such fly can be found in Germany or any other part of Europe, this supposition must be erroneous. The Hessian fly has two broods, one is hatched in May, the other in September. Its eggs are laid in the creases of the leaves of young wheat. The maggots, or larvæ, crawl down to the sheathing base of the leaves, and remain between the base of the leaves and the stem, causing the stalks to swell [Fig. 14] and the plants to turn yellow and die. They suck the sap of the stalks. During their first winter they are in the pupa state, looking like flaxseed.

The head, antennæ, and thorax of the Hessian

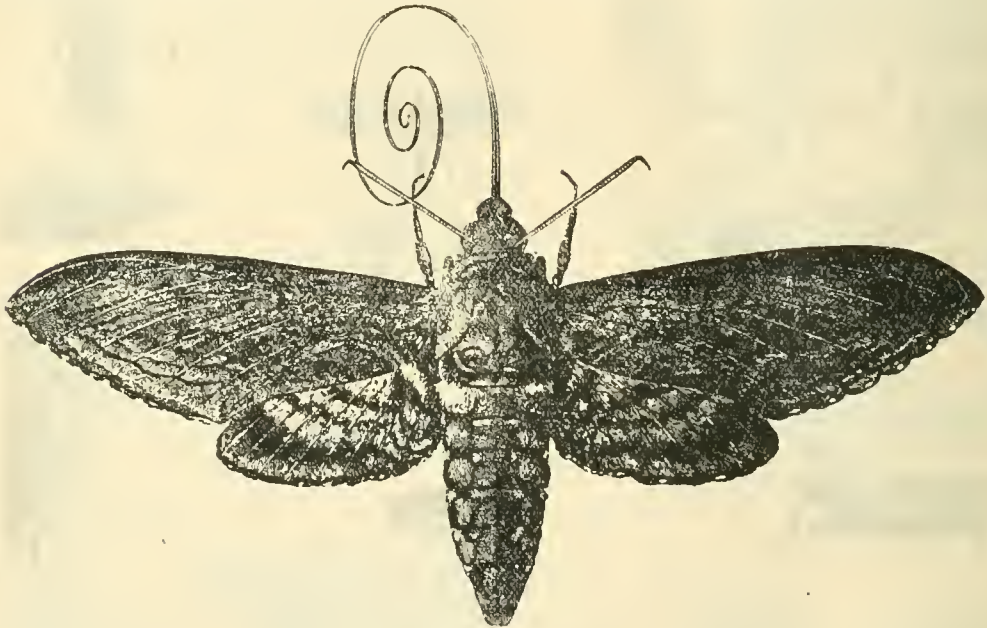

(22) MOTH.

fly are black, the wings dull smoky brown, and the legs are pale brown. Its spread of wing is only about  $\frac{1}{2}$  inch. As precautions against this insect, pasturing the wheat-fields with sheep in November, and rolling the ground have been recommended, in order to kill the eggs and larvæ; also the use of lime, soot, or salt, scattered over the young wheat. The Hessian fly infests the Eastern, Atlantic and Middle States, and the Valley of the Mississippi River.

*The Army-Worm* is the larva of a night-flying moth (*Leucania unipuncta*). The perfect insect is plain and unadorned in appearance [Fig. 15], of a yellowish-drab color, with a white spot in the center of its fore-wings; and it has a spread of wings of  $1\frac{3}{4}$  inches. The eggs are laid in the spring of the year between the folded sides of grass blades, and glued along the creases with a white, glistening, and adhesive fluid, which draws the two sides of the blades close around them. The worms hatch out in ten days. They are dark-gray, with three narrow yellowish stripes above and a broader one on

each side. When fully grown, the army worm measures from  $1\frac{3}{4}$  to 2 inches, and is about as thick as a goose-quill. Its chrysalis is of a mahogany-brown color,  $\frac{3}{4}$  inch in length, and tipped at the end with a short spine. [Fig. 16].

Sometimes the army-worm becomes very numerous and destructive. This occurs at the time when winter wheat is in the milk, and again in August. The easiest way to arrest its ravages is by plowing a double furrow around the field. This furrow must be deep and have the steep side next to the unharmed crop. A ditch with the side toward a field perpendicular is still better. When the worms are collected in the ditch, cover them with straw and burn it.

IV. INSECTS INJURIOUS TO FRUIT TREES.—The apple-tree borer (*Saperda bimittata*) causes the apple-trees on the ridges to be shorter lived than those grown on our lowerlands. It is a native American insect [Fig. 17], and has for ages inhabited our crab-apple trees. It also attacks the quinces, mountain-ash, hawthorn, pear, and June-berry, and

does a great deal of damage to orchards in various localities, but especially in New England and the Middle States. The borer is the larva of the insect. When fully grown it is about an inch long, and the first segment a quarter of an inch thick. Its color is light-yellow; but the head is chestnut-brown, polished and horny, and the jaws are deep-black. The perfect beetle comes forth from the trunks of the trees at night, early in June, and moves and flies about in search of companions and food.

Notwithstanding the pains that have been taken to destroy and exterminate these pernicious borers, they continue to reappear in our orchards and nurseries year after year. They can be killed by thrusting a wire into the hole made by them; also by cutting the grub out with a knife or gouge. But these are slow ways, because the borer always penetrates into the hearts of the trees, and such means are not better than locking a stable after the horse has been stolen from it. As the female beetle will not lay her eggs upon trees protected by alkaline washes, a good preventive is found in applying soft soap mixed with the lye from wood ashes, thinned with water, to the base of the tree. The wash need not reach up to the crotch of the tree, because the borer is rarely found as high up as that. But if a piece of lye soap is placed in the crotch, the rains will produce the necessary wash.

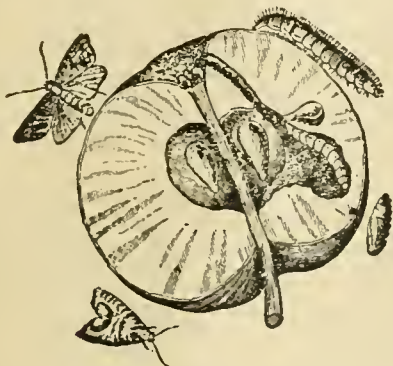

(18) APPLE WORM—CODLING MOTH.

V. INSECTS INJURIOUS TO SMALL FRUITS.—*The Grape Phylloxera (Phylloxera vastatrix)*. This minute insect is a native of America, but it has wrought its greatest mischief in Europe. There are two types of it: The Leaf-gall type (*Gallicola*), which produces galls on the underside of the leaves of the grape-vines; and the root-inhabiting type (*Radicola*), which hides in the creases, sutures and depressions of the roots. The *Gallicola* lives in the leaf-galls, which are of the size of a pear, while she surrounds herself with eggs scarcely  $\frac{1}{10}$  inch long and less than half as thick. The mother-louse is only  $\frac{1}{10}$  inch long, nearly spherical in shape, of a dull orange color, and looks much like an unripe purslane seed. Having exceedingly small limbs and a round body she looks clumsy, and as if she were swollen. The eggs she lays hatch into little oval lice of a bright yellow color. Issuing from the mouth of the gall, the young ones scatter over the vine, most of them finding their way to the tender terminal leaves, from which they suck out the sap. Each young louse produces a gall for its habitation. In this new home she begins a parthenogenetic maternity by the deposition of fertile eggs as her parent had done before. She increases in bulk with pregnancy, and one egg follows another in quick succession until the gall is crowded.

The mother dies, and the young, as they hatch, issue and produce new galls. The number of eggs in each gall is from 200 to 500. The family is wonderfully prolific. As there are at least five generations in a season, these lice cover the leaves with their galls completely till fall. The consequence is that the vine loses its leaves prematurely. Before the end of September the young lice attach themselves to the roots of the vine, and thus they hibernate. The male gall-louse is not known, perhaps it does not exist.

The *Radicola* is in its first larva state like the *Gallicola*. But, instead of the smooth skin, it soon



(20) CATERPILLAR.

acquires raised warts or tubercles, and retains a more elongated form than the *Gallicola*. Neither of them get wings, and both are occupied, from adolescence till death, with the laying of eggs. The eggs of the *Gallicola* are, however, smaller and more numerous than those of the *Radicola*. With pregnancy the *Radicola* becomes quite tumid and pear-shaped, and it remains with scarcely any motion in the quite secluded parts of the roots, such as creases, sutures, and depressions between the knots.

For a winged female *Phylloxera*, which seems to be different from those hereinbefore described, see *Britannica*, Vol. XXIV, p. 239.

The result of the punctures made by the root-louse is an abnormal swelling beginning at the tips of the rootlets. These swollen tips soon rot, when the lice attack fresh roots. At last the entire system of small roots wastes away. The only practicable way of combating this insect is by drowning it. For this purpose the soil is irrigated. Another way of evading its ravages is to graft the vines upon stocks, the roots of which are *Phylloxera*-proof. To this end American varieties have been sent to Europe in large numbers, both as cuttings and as rooted plants. An enterprising grape-growing firm has even established nurseries in Europe for the production of American vines that resist the *Phylloxera*.

*Locusts (Locustidae)*, often called *Grasshoppers*. (Fig. 19.) The *Rocky Mountain Locust* is at home on the plains between the Mississippi River and the Rocky Mountains where it is hot and dry. There they breed and multiply. When they have reached a certain stage of their existence they take



(21) CHRYSALIS.

to flight, and come, generally with the prevailing wind, eastward in countless millions. They overrun Kansas, Missouri, Nebraska, Iowa, etc., and eat every green thing they meet. When the season comes for depositing their eggs, the swarms which happen to be in favorable localities, such as sandy sunny hillsides, proceed to do so, after which most of them soon die, and the pest disappears. If the succeeding winter is mild the young grasshoppers will appear next spring in great swarms with the earli-



est vegetation. At this time they are the most destructive, because one young grasshopper eats as much as a dozen old ones. They feed voraciously. After attaining their full growth, they take to flight, as did the generation before them. This happens generally in August. But the grasshopper years are, happily, far between.

Various methods are used for combating the attacks of the locusts. Their eggs are destroyed by harrowing the ground, especially with revolving harrows, in autumn and early winter; also by plowing and irrigating. Broad pans, similar to the scrapers used in roadmaking, are covered with coal-tar or crude petroleum, and placed across the fields infested by locusts. On approaching, the latter jump into the oil and die there. In places where straw is plenty, it is placed in windrows and burnt on the approach of the locust swarms. To stop the young insects, ditching and trenching is effectual. The ditches must be at least 2 feet wide and 2 feet deep, and have perpendicular sides. The young locusts tumble into such ditches and die at the bottom in large numbers. Where lumber is cheap, a board-fence 2 feet high is an effectual barrier, if a 3-inch batten is nailed horizontally over the top and the edge at the side from which the locusts are coming is smeared with tar. The destruction of the winged insects, when they swoop down upon a country in prodigious swarms, is immense. Man is powerless in the presence of the mighty host.

On the subject of beneficial insects, as the *Honey-bees*, and the various insects that destroy harmful ones, as the *Lion-beetles*, which devour the Cut-worms; the *Lady-bugs*, which eat the Plant-lice (*Aphides*); the parasitic *Ichneumon-flies*, which deposit their eggs into Tomato-worms and other caterpillars, a great deal might be said. But we conclude this article by stating that most plants would disappear from the face of the earth if it were not for the countless insects which assist in their fertilization and cross-fertilization. Red-clover, for instance, plauted in New Zealand, would thrive quite well as far as the single plants were concerned; but it could not be made to spread there because of the absence of humble-bees, which assist in cross-fertilizing it. Most countries would be entirely uninhabitable during the hot seasons if it were not for the countless millions of insects acting as scavengers by devouring putrefying vegetable and animal matters, and thereby making the air fit for breathing, whereas it would be directly poisonous without the action of these bated little scavengers.

INSESSORES or PERCHING BIRDS, an order of birds called by Cuvier passerine or "sparrow-like." The order includes more than half the known birds, but can hardly be defined, since the members are marked rather by a combination of characters than by any uniqueness.

INTERCONTINENTAL RAILWAY. A projected railway extending through Mexico, and the Central American States southward for the purpose of opening railway communication between the various American republics. In Dec., 1891, surveys were in progress for the connecting links of this railway, not only in Mexico but also at various other points along the route. Three surveying parties were at that time in the field under the direction of the Commission. Nearly 1,000 miles of the proposed road had already been surveyed including the most difficult part—that part through Ecuador and the southern part of Colombia. The report showed less engineering difficulties than had been anticipated.

The following abstract of the report of the

Commission was published in Washington, D. C., Jan. 6, 1892:

*United States and Mexico*—The railways in these two countries being in perfect communication, the Commission has only been occupied with their continuation, and the choice of the most available point of departure; it has decided for Ayutla, on the Guatemala frontier.

*Guatemala*.—From Ayutla the Intercontinental line will descend by the Pacific Coast, passing in the neighborhood of Rotahuleu and Mazatonango, as far as Santa Lucia. Thence will be used the branch, in course of construction, of the Central Railway from Guatemala to Escuintla, and the road will pass from Cujinijilapa to Santa Ana, in the Republic of Salvador.

*Salvador*.—In this Republic the route of the proposed Central line will be utilized, passing by Santa Ana, Nuevo San Salvador, Cujutepeque, San Vincent and San Miguel, entering Honduras by Guascoran.

*Honduras*.—From Guascoran the line will continue by the shore of Gulf Fonsoca, crossing the State of Chuluteca by way of the town of that name, going thence to the south toward Nicaragua.

*Nicaragua*.—In this republic the line will arrive at the town of Chinandega, where it will join the railway from Corinto to Lake Managua, utilizing this line up to an available point—for example, Pueblo, Viojo—skirting the lake and coming to the town of Managua, where it will take the line already constructed from Managua to Massaya. From Massaya the line will pass to Rivas, will cross the proposed Nicaragua Canal and will enter into the Republic of Costa Rica.

*Costa Rica*.—Following the shores of the Lake Nicaragua, and penetrating the country by the plains of Guatuso and San Carlos, the line will continue as far as the town of Alajuela, where there is a branch to the capital. From Alajuela a continuation will be made by the railway from San José to Puerto Limon, thence, by points which are not yet determined, the length of the Isthmus of Panama, as far as the entry of the Altrato Valley, in Colombia, will be traversed.

*Colombia*.—Colombia being reached, the Intercontinental will traverse the Western Cordillera of the Andes, entering into the Cauca Valley and reaching the environs of the town of Antioquia. It will ascend by this valley, connecting the principal localities met with, and arriving at Popayan. The Central Cordillera will be crossed, in order to survey the branch intended to connect Bogota with the main line. From Popayan the line will pass into the Patia Valley, making toward Pasto or Ipiales, with continuation toward Ecuador. The passage of the Cordillera on the route from Popayan to Pasto will be one of the greatest difficulties met with in Colombia; it is at this point that the great ramifications of the Colombian Andes begin.

*Venezuela*.—In order to place this Republic in communication with the trunk line, a branch will start from a point (still undetermined) of the route in the Cauca Valley, going to Medellin, where it will rejoin the line running from that town to Puerto Berrio, on the Magdalena. Thence it will go to Bubaromanga, and thence to San Jose de Cucua (frontier) and San Christobal, La Grita, Merida, Trugillo, Barquisimeto, in terminating at Valencia. From Valencia to Caracas, by way of La Victoria, a railway is in course of construction, and will be completed in a few years. Other lines having been conceded, are being surveyed in the regions just indicated. The route of the Intercontinental will undoubtedly adapt itself to circum-

stances at the time of the execution of the project, whenever that may be.

*Ecuador*—The line will touch at the town of Tulcan, then, descending by the central valley of Quito, will serve the towns of Ibarra, Quito, Latacunga, Ambato, Cuenca and Loja, entering Peru.

*Peru*—The line will traverse the Department of Cajamarca, or the Amazonas, till it meets the River Marañon, and will ascend by that valley as far as Carro de Pasco. From the latter point it will follow the course of the Perene up to a proper point for a deviation to Santa Ana, then to Cuzco, Santa Ana; then to Cuzco, Santa Rosa and Puno, skirting Lake Titicaca in order to penetrate Bolivia.

*Bolivia*—The Intercontinental will connect the towns of La Paz, Oruro and Huanchaca, where it will divide into several branches, going to Chili, the Argentine Republic, Brazil, Paraguay and Uruguay.

*Chili*—The Chilian branch goes from Huanchaca to Antofagasta, a port on the Pacific.

*Argentine Republic*—This branch, which has already been surveyed, goes from Huanchaca to Junuy, the extreme point of the railway system of this Republic.

*Paraguay and Uruguay*.—The line which is to connect these two countries to the proposed system will start from Huanchaca, will follow the left bank of the Pilcomayo, in order to rejoin the Osborn concession, which, from Asuncion, goes to north of Paraguay. From Asuncion, use will be made of the lines already constructed or in course of construction, as far as Montevideo.

*Brazil*—The Brazilian branch starts from Huanchaca, going eastward, clearing the Paraguay River at Curuna, where, penetrating Brazilian territory, it follows the River Taguary as far as Coxim. A railway, if the concession for it shall be granted, will go from this point to Urberaba. From this latter locality the existing lines continue to Rio de Janeiro.

The scientific commissions are authorized to search out and survey the best directions and routes. The above plan must only be considered as a general idea, which according to the plans drawn up at the Washington Central Bureau, would appear to serve most effectually the interests of the American republics.

**INTERNATIONAL LAW.** For the scope and maintenance of PUBLIC INTERNATIONAL LAW, see *Britannica*, Vol. XIII, pp. 190-197. We speak here exclusively of PRIVATE INTERNATIONAL LAW. Here the questions arise: If a marriage is valid in the state A, is it also valid in the state B? If a child is legitimate in A, is it also legitimate in B? If a will made in A is valid there, is it also valid in B? If by the laws of A the property of a deceased person (the property lying in the state of B) passes to certain heirs, does it also pass to them by the laws of B? Such questions are determined by private international law. The subjects of this branch of jurisprudence are private individuals, and its rules are administered by municipal courts. Its doctrines resolve themselves into the doctrine of jurisdiction and nothing more. It determines no legal relations whatever.

Formerly, the private international law was based on the famous rule of Foelix and Auber, that all the effects which foreign laws can produce within the territory of any nation depend absolutely on the consent of that nation, either express or tacit. This rule has been abandoned by the majority of noted jurists, and in 1874 it was formally repudiated by the Institute of International Law at Geneva. The whole principle of this branch of law is

a direct corollary, or inference, from the doctrine of "Recognition." We recognize a foreign state as a sovereign and an equal, and the comity, or courtesy, between nations (*comitas gentium*) involves our duty to enforce the definitions which that state has imposed on legal relations. This rule holds good even when the definitions so imposed differ from those that are applied to the same legal relations when existing among our own citizens. Private international law rests, therefore, not upon the definition of the laws ruling in the recognizing state, but entirely upon the principles ruling in the recognized state; provided, there is nothing in these principles that contravenes the domestic policy of the latter state.

The increasing intercourse between individuals of different nations gives a growing importance to this branch of law, the rules being enforced by the various states as parts of their local laws. The rights to real property are, however, regulated by the law of the country wherein such property is situated. This *lex loci rei sitæ*, as it is called, governs the tenure, title, descent of such property, the questions relating to letting, hiring, mortgaging, public burdens, taxation, etc., whether it belongs to an alien proprietor or a citizen. In most states of Europe, and in all American States, real and personal property of every description may now be acquired, held, and disposed of by an alien in the same manner as by a citizen of the State; and a title to real and personal property of every description may now be derived through, from, or in succession to an alien, in the same manner as through from, or in succession to a citizen of the State.

I. MARRIAGE falls under the private international law. In this country the prevailing rule is, that no specific form of solemnizing marriage is required to its validity. If two persons competent to marry consent to it and accept each other as husband and wife before witnesses, there is a valid marriage. No license, magistrate, or clergyman is necessary for its validity. But in Massachusetts and Rhode Island a license must be taken out, and a magistrate or a domiciled minister of a religious denomination must solemnize it, else it is held to be invalid. Similar rules are enforced in all European states. Now, the private international law makes it obligatory to acknowledge as valid any marriage performed in another State, if the same is valid in the latter State, even if no clergyman or magistrate has officiated at its solemnization.

II. DIVORCES *a mensa et toro* are not granted in the United States, though in some States married women can obtain decrees of court permitting them to act independently as *feme sole* traders. In all our States divorces *a vinculo matrimonii* are granted for adultery, cruelty, and desertion. But in some of the States the petitioner must reside there for six months, and in others for twelve months. In cases of desertion, the supreme court of Pennsylvania holds, that the petitioner can only sue in the State where the deserted party is domiciled. In most of the States it is now held that no divorce is extra-territorially valid unless granted by a State in which the petitioner was domiciled in accordance with the rules of international law. If only the petitioner is domiciled in the adjudicating State, and the defendant's residence is known to the plaintiff, there must be personal notice given to the defendant. But this rule is not yet universal.

III. DOMICIL is the legal conception of residence. A mere transient residence is no domicile; nor is a place selected for exceptional business purposes. There must be an intention to remain (*animus manendi*) in the particular place as a fixed abode, or



permanent home. The law of domicile determines the questions of personal status, legitimacy, marital rights, and succession to personal property. The place which a man selects as his permanent home properly supplies the law by which the legitimacy of his children is regulated, his personal status is determined, his taxes to the government are fixed, and by which the distribution of his personal estate is made.

IV. The law of domicile also regulates the validity and interpretation of CONTRACTS. The law of the State in which a contract was entered into (*lex loci contractus*), determines the validity of the contract anywhere else, provided that the State where it is to be enforced, or where suit is brought does not declare its performance illegal in the place specified by the contract. If, for instance, suit is brought in the State of Rhode Island for the price of spirituous liquor to be delivered in New York, where such delivery is lawful, the Rhode Island courts will sustain such suit, although it would be unlawful to deliver spirituous liquor in Rhode Island.

V. Although the SUCCESSION to the real estates of deceased persons is governed by the *lex situs*, their personal property descends according to the *lex domicilii*, even if it is scattered over the whole civilized world. All the American and European states unite on this rule.

VI. In regard to CRIMINAL LAW, it is held, that the State in which a supposed offender is arrested, has jurisdiction over the offence. This so-called "cosmopolitan" theory is based on the assumption that each sovereign has the right to punish offenders for past misdeeds; but it is limited to offenses against his own country only. Numerous statutes have been passed by Congress making it an offense to forge, in a foreign country, United States securities and notes, and to take false oaths before United States consuls, and many convictions have been had under these statutes. We have also had many rulings that the State where an offense takes effect, has jurisdiction to punish the offender. If, for instance, a conspiracy is organized in Canada for the purpose of cheating parties in New York by letter, and the conspiracy is carried into effect in New York, then New York has jurisdiction over the offense, and can try the offenders, if found within her boundaries. If a shot is fired on the Mexican side of the boundary line between Mexico and Texas, and a man is killed by this shot, the offender can be prosecuted in Texas, if caught there. The place of consummation has jurisdiction over such and similar crimes. Were this not so, there is not a home that would be safe from explosive machines and other missiles sent by express from other places; business men would be daily exposed to the machinations of foreign swindlers; public and corporation securities would be forged abroad with impunity; imported goods would be entered in the custom houses under false affidavits, etc. With the present facilities for travel the right to punish for offenses operating in one State but concocted abroad, would be seriously impaired, if it were not for the "extradition," or surrender, of alleged criminals by one State to another. Adroit offenders would defy the laws by escaping to foreign lands, where they would be secure. Extradition is now made obligatory by treaties between all civilized countries. For extraditing an alleged offender the crime must be distinctly specified; it must be a common crime, not one of a political nature (except regicide); there must be a probable cause of guilt, such as would justify the finding of a bill by a grand jury; and the surrender must not be made to a State in which punishments are inflicted arbitrarily and capriciously.

INTER-OCEANIC CANAL, THE. In Britannica, Vol. XVIII, pp. 208, 209, will be found a description of the Isthmus of Panama, with an account of the difficulties to be overcome in constructing the proposed ship canal to connect the Atlantic and Pacific oceans at that point, and of the contemplated measures for accomplishing the work. M. De Lesseps's first estimate of the entire cost of the work was 658,000,000 francs; he afterwards reduced this estimate to 600,000,000, and upon opening his subscription lists twice as many shares as he deemed necessary were subscribed for in a short time. He announced that the canal would be opened to the traffic of the world in 1888. Soon after actual work had been begun, in 1881, it was found that the cost would rise above the estimated amount. Excavations were made at several points along the line. A very large plant of machinery was sent to the isthmus, and the preparations, in workshops, hospitals, means of transportation, etc., were designed for a vigorous prosecution of the work. The digging proceeded with more or less vigor till May, 1885. At that time the engineers reported to have excavated  $12\frac{2}{3}$  millions of cubic meters out of a total of 125 millions of cubic meters required to be dug in order to complete the canal. The tide-lock, the breakwater at Aspinwall and the excavations in the Bay of Panama had not yet been commenced. The money expended up to that time exceeded 500 millions of francs and the obligations contracted amounted to over 766 millions, on which the company had to pay  $30\frac{1}{2}$  millions of francs yearly interest. From May till the end of 1885 very little progress was made in the work, because the Chagres River inundated a large portion of the district and caused a great deal of damage. A disastrous storm occurred also in the Bay of Aspinwall in December, 1885.

After this it became more and more difficult for the company to raise the necessary funds for the prosecution of the work. Still it went on, with some interruptions, till March, 1889. The cost was enormous. In December, 1888, the actual outlay had already exceeded the sum of 1,000 millions of francs = \$200,000,000. Still De Lesseps was hopeful. When asked by the then German Crown Prince Frederick where the money for the completion of the canal was to come from, he answered airily: "From the woolen stockings of the French people," alluding to the custom of French workmen, peasants and tradespeople, storing their small weekly savings in stockings. He asked the government to sanction a lottery for the raising of the money. It was refused. Although the public authorities favored his last effort to obtain further subscriptions from the French people, it failed entirely. Only a guaranty by the government could put his scheme on a sure basis, and this the French government was bound not to give.

Work ceased in 1889 for lack of funds and the whole enterprise is now in the hands of a liquidator appointed by the government. A commission of French engineers has made a general survey of the isthmus, the condition of affairs and the state of the work. This commission has sent in a very unfavorable report, which was laid before the French Chamber of Deputies. According to this report the construction of the canal at the calculated level would cost 1,737 millions of francs = \$347,400,000, and the work could only be completed on the basis of an international agreement or a syndicate of the states interested. The report further states that, taking into account the interest to be paid during so long a period without any receipts, and also the general financial charges, the capital necessary for the completion of the canal must be es-

estimated at three milliards of francs, or, say, \$600,000,000.

Meanwhile, the unfortunate shareholders have petitioned the French congress, asking that the liquidator shall prepare a statement showing what has been done with all the money received by M. de Lesseps and his directors. More than twice the sum they stated would be required, has been subscribed and paid in, and the creditors now believe it was obtained upon false representations. They seek to have the directors made personally responsible for their losses, and hope in that way to recover at least a portion of their contributions to the Panama canal project, which may be considered dead now. American engineers who had studied the subject were of the opinion that the sea level canal, on which so much money was being expended, was impracticable, and would never be completed. Afterwards, when Mr. Eiffel (well known as the designer of the Eiffel Tower at the late Paris Exhibition) designed eight locks, four on the Atlantic side and four on the Pacific side, they were doubtful of the lock plan also, thinking the water too scarce at some seasons for the locks to work well.

**INTERSTATE COMMERCE LAW OF THE UNITED STATES.** On April 5, 1887, an act of Congress became effective, bearing the title "An act to Regulate Commerce." Its authority rests upon the constitutional provision which confers upon Congress the power to regulate commerce among the several States. This law was a new departure in Federal legislation, because up to 1887 there was no governmental supervision of railway construction. Each State and Territory authorized the building of new lines, and by their consolidation with existing railroads the State lines were often entirely disregarded. The charters of the roads usually contained a clause authorizing them to fix their rates and fares, and the States relied solely on the influence of competing lines to keep rates and fares within proper limits.

But very soon competition bred discrimination, unjust partiality. A great deal of wrangling and litigation ensued, until the country was surprised in 1886 by a decision of the United States Supreme Court in the case of the Wabash Railway Company vs. the State of Illinois, which declared that a State law against discrimination was not valid in respect to "interstate shipments." Upon the heels of this decision the report of the Select Committee on Interstate Commerce came up for consideration in the Senate. This report complained bitterly against the discriminations practiced by the railroads all over the United States. Large shippers had private rates, rebates, free passes, and enjoyed various other concessions, generally kept secret. Small shippers and the public at large did not enjoy these favors.

The Select Committee recommended a bill forbidding all unjust discriminations under pains and penalties. This was the essence of the interstate commerce law. Its weak point was that it did not regulate competition nor restrict its excesses. The law as it first passed in the Senate imposed upon interstate carriers the three obligations of just and reasonable rates, the avoidance of all unjust discrimination, and the cessation of undue preferences or advantages. Thus far it was good. But the House of Representatives insisted on stamping out the evils of competition, and passed an amended bill which radically changed the proposed enactment of the Senate. In the closing days of the session of the Forty-ninth Congress an agreement was patched up between the two houses which resulted in the present "Act to Regulate Com-

merce." The two principal features grafted upon it by the House are on the "short-haul" clause, and the "anti-pooling" clause. The short-haul rule requires that rates at intermediate points shall be shrunk whenever competition forces lower rates at more distant points on the same line. Another beneficial rule demands that any rate made to one shipper must be granted to all and must for this purpose be published and open. The anti-pooling clause is especially severe against the pooling of freight, providing a fine of \$5,000 for the offense, counting each day the pooling agreement continues as a separate offense.

In 1887 and 1888, many small roads found that a great portion of their former traffic flowed to the direct and larger lines, which could give better service. Business was leaving them. As the "rebates," "drawbacks," and "other devices," by which they formerly secured traffic, were now forbidden, these roads resorted to the payment of "commissions" to a friend of the shippers, also to the payments of rent, clerk hire, dock charges, elevator fees, drayage, free transportation within a single State, and many other specious forms of evading the plain spirit of the law. Rates upon interstate traffic are usually "joint." It was soon found that, although the law requires the exact maintenance of the tariffs of each road, this important provision had been omitted to apply to "joint tariffs," in which two or more roads participate. Large shippers were prompt to strike for every advantage which they could obtain; to inform other lines of the favors offered them by this or that road for their patronage, thus playing one road against the other; and generally received the benefit of the violation of the law by one ingenious device or another. Therefore, Congress passed amendments to the law by which shippers as well as carriers were made subject to its penalties, and the punishment of imprisonment was added to the fine in cases of unjust discrimination. Joint tariffs were also distinctly brought within the jurisdiction of the Interstate Commerce Commission. These amendments became effective March 2, 1889, and their influence was felt immediately. Illegitimate methods of securing business ceased almost entirely.

But in 1890, the spirit of obedience relaxed; the law was secretly evaded in many cases; shippers again clamored for favors under the term of "relief," and no prosecutions were commenced. It soon became a common statement among shippers and freight agents that the interstate commerce law was, after all, a dead letter, and that its penalties need not be feared. Irregularities existed, but were carefully concealed. In a few cases, however, freight agents were indicted by grand juries and fined, and some shippers were also indicted and fined for fraudulent practices. But the railway officials, as a final resort, refused to testify before grand juries upon the plea that by so doing they would incriminate themselves or their companies. This point was held by the local courts not to be well taken; but it is now pending before the United States Supreme Court for review.

At the commencement of 1891, a number of roads west of Chicago and the Mississippi River associated themselves for the purpose of cutting down, by concerted action, the cutting of freight rates. These lines appear to be determined to obey the law, and it is only fair to state here, that in the Southern States there has been little complaint with regard to unjust discriminations between large and small shippers, and none with regard to the maintenance of the tariff rates for all. The difficulty in our Eastern, Central, and Western States arises from the multiplicity of lines, many of which would find



themselves impoverished by that strict maintenance of rates which is the most important requirement of the public.

The "railway pool," as it formerly existed, was an agreement by which at stated periods, the common business of competing lines was aggregated and apportioned upon agreed percentages, the lines in excess paying over to the lines in deficit such sums of money as were required to produce the necessary equalization among the shares of traffic assigned to the several roads. This custom exists in England to-day. Our interstate commerce law has abolished it at short order. No railway pools exist now in the United States.

Most railroads charged greater proportionate rates upon a shorter than upon a longer haul on the same line of transportation. This was abolished by the "short-haul" section of the law. It overturned customs, rate-sheets, and classifications of long standing in every part of the land, and involved a great loss of revenue to the roads. But it was generally submitted to by the companies, in spite of being felt as a grievous burden. Soon, however, it was found that this section of the law is limited by the words "under substantially similar circumstances and conditions." These "conditions" were held to include other carriers not subject to this law, with which the interstate roads had to compete. The commission therefore ruled that, if in cases of actual competition other carriers not subject to the law, as carriers by water or by roads confined to a single State, make a lesser charge for a longer than for a shorter haul, the interstate railroads are entitled to do the same under these particular conditions; and also in the rare and peculiar cases of competition with other railroads subject to the law where the general rule would be destructive of legitimate competition. The conclusion thus reached was generally accepted by the roads, and the section as thus constructed has been quite uniformly obeyed. Taking everything into consideration the interstate commerce law has had a beneficial effect and justifies the new line of Federal legislation fully.

INTONING, a modern popular term for the utterance in musical recitative of the versicles, responses, etc., in a church service. This recitative consists mainly of a monotone, but may be varied by the introduction of certain simple inflections, which have the sanction of custom or tradition.

INTUS-SUSCEPTION, or INVAGINATION, the term applied to the partial displacement of the bowel in which one portion of it passes into the portion immediately adjacent to it, just as one part of the finger of a glove is sometimes pulled into an adjacent part in the act of withdrawing the hand. It is one of the most frequent and fatal causes of obstruction of the bowels in children, but less common in adults. Even when inflammation is set up, the affection, although in the highest degree perilous, is not of necessity fatal.

INULIN, a vegetable principle, isomeric with starch, derived from elecampane.

INUNDATIONS, overflows of the land by the waters of streams and seas. We speak here only of the overflows caused by rivers. They are annual phenomena, though irregular. In spring they are produced by mountain snows, in summer and fall by rainstorms. The cure for floods is thought to lie in the planting of trees and forests in the regions above the inundated districts. This has been done in certain parts of France, but not sufficiently to prevent occasional floods. The scarping and terracing of the hills had a better effect, as the sudden descent of the waters was thereby checked. But this is only a temporary make-

shift. The method mostly employed is the embanking of the rivers with solid and substantial embankments, so as to hold back the flood-waters when the pressure becomes great. This system has been largely practiced on the Mississippi and Missouri rivers. It has undoubtedly prevented many inundations. The proposal to build large reservoirs on the upper course of streams, to receive and hold back their waters in the season of flood and give it out gradually in the season of low water, would be quite practicable on many small rivers, but would require immense basins to prevent rivers like the Mississippi from overflowing their banks. As forests retard the movement of the waters, they ought to be replanted wherever the land is not very valuable. This would retard the flow of the storm waters into the streams, and produce a more equable distribution of beneficial rains during the season when growing crops need them. In the United States the forests have been cut down regardless of any climatic effects; the land surface has been levelled, and the marshes and swamps have been drained as much as possible. We must therefore expect to hear of many freshets in the up-countries and of yearly inundations in low valleys. See RIVER ENGINEERING, Britannica, Vol. XX, pp. 571-581, and HYDRO-MECHANICS, Vol. XII, pp. 502-535.

INVALIDING, the return home, or to a more healthy climate, of soldiers or sailors who have been rendered incapable of active duty by wounds or the severity of foreign service.

INVENTORY, a list or schedule of articles, describing each separately and distinctly.

INVERCARGILL, a town of New Zealand, in Southland county, at the mouth of New River, and at a railway junction. It has a hospital, newspapers, saw-mills, and ships much timber, wool, preserved meats, etc. The surrounding district is principally taken up with pastoral operations. Population, 4,500.

INVERSION, in music, is of three kinds. (1) Of a chord, when any other of its component notes than the root is placed lowest. (2) Of an interval (within the octave), when the lower note is transposed an octave higher, or *vice versa*. (3) Of a subject or theme, when it is imitated in contrary motion; that is, the melody progresses by the same intervals as the original theme, but ascends or descends always in a contrary direction.

INVOLUCRE. In a shortened inflorescence, as the umbel, the bracts, unless suppressed, are necessarily close together, and form an apparent whorl around the group of pedicels. This is the involucre. In compound umbels the whorl of bracts of the secondary umbel is a secondary involucre, and is commonly called an involucrel.

IOLA, a city, railroad junction, and county-seat of Allen county, Kan., situated on Neosho River. The region is a fine agricultural locality and the city manufactures furniture and other goods. An artesian well supplies mineral water and sufficient gas to heat and light the town.

IONIA, a city and county-seat of Ionia county, Mich., situated on Grand River. Agriculture and the lumber business are the leading industries. The place contains railroad repair-shops and various mills and factories. Population, 4,999.

IONIAN SEA, that part of the Mediterranean which lies between Greece and European Turkey on the east, and Italy and Sicily on the west. It forms the gulfs of Taranto and Patras, and communicates with the Adriatic Sea by the Strait of Otranto. It contains all the Ionian Islands except Cerigo.

IOWA AGRICULTURAL COLLEGE, THE, was established as a State institution in 1858, and bene-

fitd by the land grants made by Congress in 1862, to such States as had established or should establish colleges of agriculture and the mechanic arts. These land-grants formed the basis of the present endowment of the college—about \$650,000. The college is equipped with a farm of 900 acres, buildings costing about \$270,000, apparatus required by the courses of study, a library, and a museum containing large collections.

IOWA CITY, the county-seat of Johnson county, Iowa, and the capital of the State from 1839 to 1856, situated in Lucas township, on the east bank of the Iowa River, 120 miles east of Des Moines, and 54 miles west by north of Davenport. It is the seat of the Iowa State University, organized in 1860. It contains, besides many important public buildings, a large paper mill, a foundry, manufactories of carriages, alcohol, flour, beer, linseed oil, pumps, plows, etc. Population in 1880, 7,123; in 1890, 5,628.

IOWA COLLEGE. See COLLEGES, in these Revisions and Additions.

IOWA FALLS, a railroad junction of Hardin county, Iowa, on the Iowa River, the falls of which, at this point, give the name to the town. It is 143 miles west of Dubuque.

IOWA, STATE OF, for general article on Iowa see Britannica, Vol. XIII, pp. 207-209. The census of 1890 reports the area at 56,025 square miles; population 1,911,896; population of the State capital, Des Moines, 50,067. The population by counties, as reported by the census of 1890, is given in the subjoined table:

Counties.	1890	1880
Adair	14,534	11,667
Adams	12,292	11,888
Allamakee	17,907	19,791
Appanoose	18,961	16,636
Audubon	12,412	7,448
Benton	24,178	24,888
Black Hawk	24,219	23,913
Boone	23,772	20,838
Bremer	14,630	14,081
Buchanan	18,997	18,541
Buena Vista	13,548	7,537
Butler	15,463	14,293
Calhoun	13,107	5,595
Carroll	18,828	12,351
Cass	19,645	16,943
Cedar	18,253	18,936
Cerro Gordo	14,864	11,461
Cherokee	15,659	8,240
Chickasaw	15,019	14,534
Clark	11,332	11,513
Clay	9,309	4,248
Clayton	26,733	28,829
Clinton	41,199	36,763
Crawford	18,894	12,413
Dallas	20,479	18,746
Davis	15,258	16,468
Decatur	15,643	15,396
Delaware	17,349	17,950
Des Moines	35,324	33,099
Dickinson	4,328	1,901
Dubuque	49,548	42,996
Emmet	4,274	1,550
Fayette	23,141	22,258
Floyd	15,424	14,677
Franklin	12,871	10,249
Fremont	16,842	17,652
Greene	15,797	12,727
Grundy	13,215	12,639
Guthrie	17,380	14,394
Hamilton	15,319	11,252
Hancock	7,621	3,453
Hardin	19,003	17,807

Counties.	1890	1880
Harrison	21,356	16,649
Henry	18,895	20,986
Howard	11,182	10,837
Humbolt	9,836	5,341
Ida	10,705	4,382
Iowa	18,270	19,221
Jackson	22,771	23,771
Jasper	24,943	25,963
Jefferson	15,184	17,469
Johson	23,082	25,429
Jones	20,233	21,052
Keokuk	23,862	21,258
Kossuth	13,120	6,178
Lee	37,715	34,859
Linn	45,303	37,237
Louisa	11,873	13,142
Lucas	14,563	14,530
Lyon	8,680	1,968
Madison	15,977	17,224
Mahaska	28,805	25,202
Marion	23,058	25,111
Marshall	25,842	25,752
Mills	14,548	14,137
Mitchell	13,299	14,363
Monona	14,515	9,055
Monroe	13,666	13,719
Montgomery	15,848	15,895
Muscatine	24,504	23,170
O'Brien	13,060	4,155
Osceola	5,574	2,219
Page	21,341	19,667
Palo Alto	9,318	4,131
Plymouth	19,568	8,566
Pocahontas	9,553	3,713
Polk	65,410	42,395
Pottawattamie	47,430	39,850
Poweshiek	18,394	18,936
Ringgold	13,556	12,085
Sac	14,522	8,774
Scott	43,164	41,256
Shelby	17,611	12,696
Sioux	18,370	5,426
Story	18,127	16,906
Tama	21,651	21,585
Taylor	16,384	15,635
Union	16,900	14,980
Van Buren	16,253	17,043
Wapello	30,426	25,285
Warren	18,269	19,578
Washington	18,468	20,374
Wayne	15,670	16,127
Webster	21,582	15,951
Winneshiek	7,325	4,917
Winesheik	22,528	23,928
Woodbury	55,632	14,996
Worth	9,247	7,053
Wright	12,057	9,062

The census of 1890 reports the population of the cities of the State of Iowa having a population of 3,000 and over, as follows: Burlington, 22,528; Cedar Rapids, 17,997; Clinton, 13,629; Council Bluffs, 21,388; Davenport, 25,161; Des Moines, 50,067; Dubuque, 30,147; Keokuk, 14,075; Muscatine, 11,432; Ottumwa, 13,996; Sioux City, 37,862; Boone, 6,518; Preston, 7,195; Fort Madison, 7,906; Osceola, 7,300; Waterloo, 6,679; Iowa City, 5,628; Lyons, 5,791; Fort Dodge, 4,869; Independence, 4,120; Mason City, 4,002; Mt. Pleasant, 4,918; Cedar Falls, 3,598; Fairfield, 3,379; Grinnell, 3,327; Washington, 3,234. The population of the State of Iowa was 1,624,615 in 1880; 1,753,980 in 1885 (State census); and 1,906,729 in 1890. The State ranked 10 in total population, and retained the same place in 1890.

About one-half the State is underlaid with coal. The northern extremity of the great Fourth Coal Field occupies the southern portion of the State, ex-



tending across the southeastern counties of Nebraska, thence southward into Texas and the Indian Territory. Coal is produced in 26 counties, and in quality it is adapted to steam and heating purposes. No cannel or gas coal has thus far been found in the State. The product in 1880 was 1,461,116 tons; in 1889, 4,061,704 tons, valued at \$5,392,220. The number of persons employed during the year was 9,198, receiving as wages \$3,903,291.

For other products of the State as reported in the census of Iowa, in 1890, see the article on such products, severally; also the article UNITED STATES. See Revisions and Additions.

The subjoined table gives the complete list of governors, Territorial and State, from the date of the organization of the State:

TERRITORIAL.

Robert Lucas,..... 1834-41 John Chambers, .....1841-46  
James Clark, 1846.

STATE.

Ansel Briggs,..... 1846-50 Samuel Merrill,.....1868-72  
Stephen Hemstead, ... 1850-54 Cyrus C. Carpenter,....1872-76  
James W. Grimes,.....1854-58 Samuel J. Kirkwood,....1876-78  
Ralph P. Lowe,..... 1858-60 John H. Gear,..... 1878-80  
Samuel J. Kirkwood, ... 1860-64 Buren R. Sherman,....1882-86  
Wm. M. Stone, ..... 1864-68 William Larrabee,.... 1886-90  
Horace Boies, 1890-(94.)

IOWA STATE UNIVERSITY. See COLLEGES, in these Revisions and Additions.

IPSARA, or PSARA, a small island belonging to Turkey, in the Grecian Archipelago, 9 miles west of Scio. It was very prosperous before the Greek revolution; but, taken by the Turks in 1824, its industries fell into decay and its population diminished. Its inhabitants are chiefly engaged in fishing.

IPSWICH, a village of Essex county, Mass., on Ipswich River, 3 miles from the Atlantic, and 27 miles northeast of Boston. The town was settled in 1642, and was originally the county-seat. It has manufactories of silk, hosiery, shoes, isinglass, soap, and woolen fabrics. It contains the Manning high-school, the Heard public library, a ladies' seminary, a house of correction, and an insane asylum.

IRBY, JOHN L. M., a United States Senator from South Carolina, a lawyer, born in Laurens county, South Carolina, Sept. 10, 1854. He was educated at the University of Virginia and Princeton College, and entered the profession of law in 1876. In politics he is a Democrat, and an active member of the Farmers' Alliance. He was elected a member of the State house of representatives in 1886, 1888 and 1890. In 1890 he was elected by the South Carolina legislature to the United States Senate, to succeed Wade Hampton.

IREDELL, JAMES (1750-99), an American jurist. He was admitted to the North Carolina bar in 1775, and from 1774 until the Revolution, was collector of customs at Edenton. In 1777 he was chosen a judge of the supreme court, and in 1787 was appointed a commissioner to compile and revise the laws of the State. In 1790 he became associate justice of the United States Supreme Court.

IREDELL, JAMES (1788-1853), a United States Senator, son of the preceding. He was admitted to the North Carolina bar, and in 1816 became a member of the legislature, serving for many years. In 1827 he became governor of the State, and from 1828 to 1831 was in the United States Senate. He afterwards practiced his profession in Raleigh, and for many years was reporter of the decisions of the supreme court. He published a *Treatise on the Law of Executors and Administrators*, and a *Digest of All the Reported Cases in the Courts of North Carolina, 1778 to 1845*.

IRELAND. See Britannica, Vol. XIII, pp. 214-72; also GREAT BRITAIN, in these Revisions.

IRELAND ISLAND, one of the Bermudas.

IRIDEÆ, or IRIDACEÆ, a natural order of endogenous plants, mostly herbaceous, with bulbous, tuberous, or creeping root-stocks. The leaves are generally sword-shaped and in two rows. The colored perianth is six-partite. The stamens are three, with anthers turned outwards. The ovary is inferior; there is one style, with three stigmas which are often petal-like. The fruit is a three-celled, three-valved capsule. About seven hundred species are known, of which the greater number are natives of warm countries. *Iris Gladiolus* and *Crocus* are examples.

IRISH SEA, a body of water lying between the North of Ireland and the North of England, with the southwestern counties of Scotland on the north. It is connected with the Atlantic on the northwest by the north channel, and on the south by St. George's channel. The Irish Sea has a width of 150 miles, its length north and south is about the same. Within its boundaries lie the Isle of Man, Anglesey, Holyhead, and other islands.

IRON, PRODUCTION OF IN UNITED STATES. For the general article on iron, see Britannica, Vol. XIII, pp. 278-359. The latest reliable statistics of the production of iron in the United States are those of the census of 1890, reported by Doctor William M. Sweet, of Philadelphia, from which we quote the following summaries:

The production of Pig-Iron during the year ended June 30, 1890, was the largest in the history of the iron industry of this country, amounting to 9,579,779 tons of 2,000 pounds, as compared with 3,781,021 tons produced during the census year 1880 and 2,052,821 tons during the census year 1870. From 1870 to 1880, the increase in production amounted to 1,728,200 tons, or nearly 85 per cent., while from 1880 to 1890, the increase was 2,798,758 tons, or over 153 per cent.

The pig-iron industry of New England has been practically stationary during the past twenty years, while during the same period, and especially since 1880, there has been a wonderful development of the manufacture of pig-iron in all other sections of the country.

The relative rank of the various States is seen to have undergone many changes since 1880. Pennsylvania still retains its leadership as the producer of about one-half of the pig-iron that is annually made in the United States, producing 51 per cent. of the total production in the census year 1880, and over 49 per cent. in 1890. Ohio was second in rank in both 1880 and 1890, the output of pig-iron in the former year being over 14 per cent. of the total production in the United States, and in the latter year over 13 per cent. Alabama, which occupied tenth place in 1880, with an output of 62,336 tons, is now the third largest producer of pig-iron, the production of this State in 1890 amounting to 890,432 tons, an increase of more than 1,328 per cent. over the production of 1880. Illinois which was seventh in rank in 1880, is fourth in 1890; and New York, which was third in 1880, occupies fifth place in 1890. Virginia, which was seventeenth in rank in 1880, is now sixth; while Tennessee has gone from thirteenth to seventh place.

Notwithstanding the fact that the production of pig-iron has increased from 3,781,021 tons of 2,000 pounds in 1880, to 9,579,779 tons in 1890, the total number of completed furnaces has decreased during the ten years from 681 to 562. Many furnaces which were in the active list in 1880, have since been abandoned, owing to their inability to profitably compete with the larger, better located, and more modern furnaces of the present day. The majority of these abandoned furnaces were of small

capacity, and were able to produce and market pig-iron only during periods of great demand and consequent high prices, while the large number of new and improved furnaces which have been built during recent years, and which are favorably located for the supply of materials at low cost and within easy access to market, have now made the operation of these antiquated furnaces unremunerative even in periods of the greatest activity.

Pennsylvania shows a decrease of 45 furnaces from 1880 to 1890, and during the same period the total number of furnaces in Ohio has decreased by 32. These figures, however, merely exhibit the net decrease in the number of furnaces, as many large bituminous coal and coke furnaces have been erected during this period in these as well as in other States to take the place of small stacks abandoned. Since 1880 there have been 282 furnaces abandoned in the United States, owing either to unfavorable location or to give place to larger and more modern plants, while during the same period 163 new furnaces have been built, in addition to a large number of plants that have been scientifically remodeled and enlarged by the addition of new and more efficient machinery.

At the close of the census year 1890, the total number of blast furnaces which were active or likely to be some day active was 562, of which 169 were anthracite or anthracite and coke furnaces, 253 coke and bituminous coal furnaces, and 140 charcoal furnaces. Of the total number of furnaces at the close of 1880, there were 229 anthracite or anthracite and coke furnaces, 195 coke and bituminous coal furnaces, and 257 charcoal furnaces. In the decade from 1880 to 1890, there is seen to have been a decrease of 60 in the number of anthracite or anthracite and coke furnaces, a decrease of 117 in the number of charcoal furnaces, and an increase of 58 in the number of coke and bituminous coal furnaces.

Of the 562 completed furnaces at the close of the census year 1890, there were 338 in blast, of which 110 were anthracite or anthracite and coke furnaces, 165 coke and bituminous coal furnaces, and 63 charcoal furnaces. The number of furnaces building at the date mentioned was 39, of which 9 were in Virginia, 7 in Alabama, 5 in Pennsylvania, 4 in Illinois, 3 each in Kentucky, Tennessee and Michigan, 2 in Maryland, and 1 each in Georgia, Ohio and Wisconsin.

One of the most noticeable features in the growth of the manufacture of pig-iron in this country during the past decade is the development of the blast-furnace industry of the southern States. In 1880, the South already commenced to appreciate the value of the extensive deposits of iron ore and coal within her borders and to realize the superior advantages which she possessed for the cheap production of pig-iron, owing to the close proximity to each other of these materials, and a number of large coke furnaces were built in that year and the few succeeding years. The greatest activity, however, in undertaking new furnace plants was in 1887, during which year 5 new furnaces were blown in and 25 others were under construction. There has been but little abatement in this activity to the present time.

The greatest activity in the development of the Southern pig-iron industry during the past decade is seen to have been in Alabama. This State produced in the census year 1890 one-half of all the pig-iron made in the South, and was only exceeded in production in the United States by Pennsylvania and Ohio. Virginia and Tennessee now occupy, respectively, second and third places among the

pig-iron producing States of the South. Prior to the census year 1890, Tennessee was the second leading manufacturer of pig-iron in that section, but the activity which has been noticeable during the past few years in Virginia in the erection of new furnaces has placed this State next to Alabama among Southern States in the quantity of pig-iron produced. In 1880 West Virginia was the leading producer of pig-iron in the South, but in 1890 it was fourth in rank.

The production of Bessemer pig-iron in the United States during the census year 1890, which is included in the figures of total production of pig-iron, amounted to 4,233,372 tons. Of this quantity Pennsylvania made 2,567,813 tons; Illinois, 616,659 tons; Ohio, 526,654 tons; New York, 174,574 tons; West Virginia, 101,178 tons; Maryland, 77,754 tons; Missouri, 68,629 tons; Wisconsin, 43,728 tons; New Jersey, 41,479 tons, and all other States a total of 14,904 tons. Of the total production of Bessemer pig-iron in Pennsylvania in the census year 1890, the Lehigh Valley produced 257,844 tons; the Schuylkill Valley, 148,026 tons; the Upper Susquehanna Valley, 132,886 tons; the Lower Susquehanna Valley, 493,288 tons; the Juniata Valley, 23,378 tons; the Shenango Valley, 298,792 tons; Allegheny county, 995,721 tons, and the remainder of the State, 217,848 tons. Of the total production of Bessemer pig-iron in Ohio in the census year 1890, the Mahoning Valley produced 96,605 tons; the Hocking Valley, 29,453 tons, and the remainder of the State, 400,596 tons.

The production of spiegeleisen in the census year 1890, which is included in the figures of total production of pig-iron, amounted to 149,959 tons, as compared with 12,875 tons produced in the census year 1880. Four States made spiegeleisen in 1890, viz., New Jersey, Pennsylvania, Illinois, and Colorado, while in 1880, only New Jersey and Pennsylvania were engaged in its manufacture.

IRON BARK TREE, a name given in Australia to certain species of *Eucalyptus*, particularly *E. resinifera*, or red gum, on account of the extreme hardness of the bark.

IRON CROSS, a Prussian order, instituted March 10, 1813, by Frederick William III. to be conferred for distinguished services in war. The decoration is a Maltese cross of iron edged with silver.

IRON MOUNTAIN, or IRON MOUNT, a hill in St. François county, Mo., 81 miles southwest of St. Louis. It is about 300 feet higher than the adjacent plain and covers 500 acres. It yields from 50 to 60 per cent. of good iron, free from sulphur, magnetic, and softer than that of Pilot Knob. The amount of iron appears to be immense as it is 50 feet in thickness and of unknown depth. Iron Mountain village contains blast furnaces and factories.

IRONTON, a city, the county-seat of Lincoln county, Ohio, situated on the Ohio River, 3 miles above Portsmouth, about 140 miles above Cincinnati, and 50 miles southwest of Pomeroy. The city is built on a small plain or bottom at the base of hills which abound in iron ore and bituminous coal. At Ironton there are several rolling-mills, iron foundries, furnaces, and other manufactories. Iron is the chief article of export. Population in 1880, 8,857; in 1890, 10,922.

IRONY (Gr. *eirōneia*, *eiron*, "a dissembler"), the name applied to a figure which enables the speaker to convey his meaning with greater force by means of a contrast between his thought and his expression. It is properly a weapon of controversy, by means of which weight and point may be added to the gravest part of the argument. The dialogues of Plato are admirable examples of subtle irony,



and in modern literature the *Provincial Letters* of Pascal.

**IROQUOIS.** See **INDIANS, AMERICAN** in these Revisions and Additions.

**IRRATIONAL NUMBERS,** a term applied to those roots of numbers which cannot be accurately expressed by a finite number of figures. For instance,  $\sqrt{2}$  is an irrational number. If the diameter of a circle is one foot the circumference is an irrational number. Irrational numbers have been defined to be numbers which are incommensurable with unity. They are also termed *Surds*.

**IRRITABILITY** in plants, a term employed to designate phenomena very interesting and curious, but still imperfectly understood. Such are the sleep of plants, the motion of the spores of many cryptogamic plants by means of cilia; the motions of insectivorous plants, etc.

**IRVING, HENRY,** the stage name of John Henry Brodrib, an English actor. He was born at Keinton, Glastonbury, in 1838 and educated at the school of Dr. Pinches in London, becoming a clerk in that city. In 1856 he made his first appearance on the stage in a London theater; then played in Scotland for nearly three years before returning to London, afterward in Glasgow, Liverpool and Manchester with increasing success until in 1874, in London, he created genuine interest by his rendering of Hamlet. This established his reputation as a tragedian of real power and originality. Mr. Irving has made three successful tours in the United States; in 1883, 1884 and 1886. In 1878 he entered on the management of the Lyceum Theater in London, England, and has written several papers on his art for the *Nineteenth Century*, as well as an introduction to the English translation of Diderot's *Paradox of Acting*.

**IRVING, THEODORE** (1809-1880), an American educator. In 1836 he became professor of history and belles-lettres in Geneva college, and in 1848 in the free academy of New York. He resigned in 1852, and in 1854 was ordained priest of the Protestant Episcopal church. He held rectorships in Bay Ridge, L. I., Staten Island, and New York. He published *The Conquest of Florida by Hernando de Soto* (1835); *The Fountain of Living Waters* (1854); *Tiny Footfalls* (1869); and *More than Conqueror* (1873).

**IRVINGTON,** a village of Westchester county, N. Y., on the Hudson River Railroad, 24 miles from New York. Sunny Side, the former residence of Washington Irving, is in the immediate vicinity.

**IRWIN,** a post-borough of Westmoreland county, Penn., at the junction of the Pennsylvania and Youghiogheny railroads, 22 miles S.E. of Pittsburgh. Several coal companies operate in mines here.

**IRWIN, JARED** (1750-1818), an American statesman. During the last four years of the Revolution he served in a Georgia regiment, and was a member of the first legislature that convened after the independence of the colonies was established, remaining in that body continuously, except while governor of the State, from 1790 till 1811. He was a member of the State constitutional conventions of 1789, 1795, and 1798.

**ISAAH.** See *Britannica*, Vol. XIII, pp. 377-384.

**ISAMBERT, FRANÇOIS ANDRÉ,** lawyer, born at Aunay, France, in 1792, died at Paris in 1857. In 1818 he began to practice as an advocate, soon attaining political prominence as an opponent of the Restoration government, and later was prominent as a friend of liberty and opponent of the Jesuits. He was the author of several legal works and compiled the old laws of France (29 Vols. 1821-1833). He also wrote a *Life of Justinian* (1856), and at the time of his death was engaged in compiling the

modern French laws, edicts and ordinances.

**ISAR, or ISER,** a river of Bavaria, rises in the Tyrol, northeast of Innsbruck, and flows 220 miles, generally in a north and northeast direction, till it falls into the Danube near Deggendorf. Munich and Landshut are on its banks. Hohenlinden is twenty miles away. In the first part of its course it is an impetuous mountain torrent, and large quantities of wood are floated down from the mountains. Area of its drainage basin, 3,545 square miles.

**ISEO, LAKE** (*Lacus Serenus*), a lake of Northern Italy, situated between the provinces of Bergamo and Brescia. Length, twelve and a half miles; maximum breadth, three and two-fifth miles; area, twenty-four square miles. It contains two small islands, and is fed by the Oglio.

**ISHPEMING,** a post-town in Ishpeming township, Marquette county, Michigan, 15 miles W. SW. of Marquette, and 3 miles west of Negaunee. It contains a foundry, a machine-shop, a blast-furnace, and a carriage-factory, besides several important public institutions. It is supported mainly by the iron-mines, which are very rich, and there are several iron-furnaces in the vicinity. Population in 1880, 6,039; in 1890, 11,184.

**ISIAC TABLE,** a flat rectangular bronze-plate, about 5 feet long and 3 feet high. It was bought of a locksmith by Cardinal Bembo in 1527, after the sack of Rome by Charles V, and finally passed to Turin where it still remains. It is much mutilated and was supposed to be a genuine relic of ancient Egypt, although more recently considered a very late monument. It is a representation of Isis, surrounded by most of the Egyptian deities.

**ISLAND** (*A. S. igland, ig 'island,' and land*), land surrounded by water. The larger masses of land surrounded by water, or parts of them, are continents, and the term island is usually restricted to the smaller. Two classes of islands may be distinguished—continental and oceanic. Continental islands are closely allied by the structure of their rocks to the nearest continental land, from which they are rarely far distant, although sometimes, as in the case of Madagascar and New Zealand, they are separated by depths exceeding 1,000 fathoms, and generally lie to the south and east of the continent with which they are associated; the only exceptions to this rule being islands separated by depths less than a hundred fathoms. With the exception of Madagascar and New Zealand, whose separation is unusually complete, the plants and animals of continental islands are similar to those on the adjacent continent, and from the differences detected the period of separation has sometimes been calculated. Groups of continental islands inclosing seas stretch from the southeast peninsula of each of the northern continents towards the nearest southern continent. Oceanic islands rise abruptly from great depths, and show no geological continuity with the continents. They appear above the surface either as *volcanic islands*, usually rugged peaks or vast accumulations of lava, nearly as precipitous below the surface as above, or as *coral islands*. Numerous submarine mountains have been discovered in parts of the ocean, which only require moderate elevation, or the deposition of sediment or coral growth, to appear on the surface as islands.

**ISLE LA MOTTE,** an island in Lake Champlain, about 30 miles north of Burlington, constituting the township of Isle la Motte, Grand Isle county, Vt. It is six miles long, and has extensive quarries of gray, black, and variegated marble.

**ISLES OF SHOALS**, a group of eight small islands, 10 miles S. E. of Portsmouth, N. H., inhabited chiefly by fishermen. On White Island is a revolving light, 87 feet above the level of the sea, and on Appledore and Star Islands there are hotels for the accommodation of summer visitors who resort to the islands to enjoy the sea-air.

**ISLIP**, a township and village of Suffolk county, Long Island, N. Y., situated on Great South Bay. It has flour, paper and planing-mills, a marine railroad, a shipyard and establishments for putting up canned goods. This is the headquarters of several sporting clubs, and here fishing and the rearing of trout are important industries. Population of township, 8,747.

**ISMAIL PASHA**, ex-Khedive of Egypt, born at Cairo in 1830. His father was Ibrahim Pasha. After Ismail's education at Paris had been finished he returned to Egypt in 1849, his father having died. Said Pasha, viceroy of Egypt in 1856, employed Ismail in various missions to European courts; and in 1862, when Said Pasha visited Europe, he left the administration in charge of Ismail, and when Said Pasha died, in 1863, Ismail succeeded as viceroy. By means of his wealth he obtained in 1866 from the Sultan of Turkey the privilege of succession in direct line for his dynasty, and soon afterwards he obtained other concessions, which freed him from Turkish supervision, and procured for him the title of "Khedive." He introduced many foreign customs; opened the first Egyptian parliament in 1866; and pushed his conquests in the valley of the White Nile with the aid of Sir Samuel W. Baker. In 1869 he performed the ceremonies connected with the opening of the Suez Canal. By contracting many loans in England and France he created a public debt of 400 million dollars, which forced him in 1875 to sell his shares in the Suez Canal to the British government. In 1876 he suspended payment of interest on the bonds he had issued, and was compelled to relinquish his estates to the creditors. As the army and the people became discontented, especially at his introduction of many foreign officials, and the heavy taxation, Ismail abdicated in 1878 in favor of his son Tewfik Pasha.

**ISOCHRONISM** (Gr. *isos*, "equal;" *chronos*, "time"), the property of the pendulum which causes it to perform its vibrations in equal time. The character of being isochronous. A pendulum can only possess this property by being constrained to move in a cycloidal arc. See *Britannica*, Vol. VI, p. 14.

**ISOLA GROSSA**, or **ISOLA LUNGA** (Great or Long Island), a long, narrow island in the Adriatic, twenty-seven miles by three, running parallel to the coast of Dalmatia. It belongs to Austria. Population, 12,000.

**ISONANDRA GUTTA**, or **DICHORIS GUTTA**, a large tree, of the order of *Sapotaceæ*, whose inspissated juice is known as "gutta percha." For an account of the methods of collecting and using the juice see *Britannica*, Vol. XI, pp. 337-339.

**ISRAEL**. See *Britannica*, Vol. XIII, pp. 396-432.

**ISRAELS**, JOSEF, artist, born at Gröningen, in the Netherlands, in 1824, studied at Amsterdam and in Paris. His first exhibited work was historical, and attracted attention, but he has since devoted his skill to the portrayal of scenes from humble life, and his work is highly esteemed. In 1867 he was awarded the ribbon of the Legion of Honor and in 1875 the cross. Besides his work in oil and water-colors he is favorably known as an etcher. He resides at the Hague.

**ISSUE**, in law, means the point of fact in dispute which is submitted to a jury.

**ITALIC VERSION**, a translation of the Scriptures into Latin. It preceded the Vulgate and is supposed to date from about the middle of the 3d century. The Italic Version was in general use down to the time of Jerome, who, dissatisfied with its imperfections, undertook to revise it, but produced the translation known as the Vulgate. The Old Testament he translated from the Septuagint.

**ITALY**. For general article on the kingdom of ITALY, see *Britannica*, Vol. XIII, pp. 434-516.

The area of Italy in 1891 is the same as in 1881 when it was in official census reported at 286,588 square kilometres, or 110,620 square miles. The latest published census, that of Dec. 31, 1881, reported a total population of 28,459,628, a net increase during the previous decade of 1,657,474. Rome, the capital city, had a population of 273,268. Rome was rapidly increasing in population, the total in the city, reaching in 1877, 372,778.

A later semi-official census, *estimated*, in 1885, increased the above figures making the totals as follows: Area, 110,655 square miles (91,277 mainland, 19,378 islands), with a population of 29,699,781. The coast-line of the mainland is estimated at 1,999 miles; of Sardinia, Sicily, and Elba, at 1,389 miles; of the minor islands, at 557 miles; in all 3,945 miles.

**REIGNING KING AND ROYAL FAMILY**.—Umberto I., was born March 14, 1844. He is the eldest son of King Vittorio Emanuele II. of Italy and of Archduchess Adelaide of Austria. He succeeded to the throne on the death of his father, Jan. 9, 1878. He was married April 22, 1868, to Queen Margherita, born Nov. 20, 1851, the only daughter of the late Prince Ferdinando of Savoy, Duke of Genoa.

*Son of the King and Heir Apparent*.—Vittorio Emanuele, Prince of Naples, born Nov. 11, 1869.

*Sisters of the King*.—1. Princess Clotilde, born March 2, 1843; married Jan. 30, 1859, to Prince Napoleon Joseph Charles Paul Bonaparte, born Sep. 9, 1822; offspring of the union are Napoleon Victor, born July 18, 1862; Louis, born July 16, 1864; and Lætizia, born Dec. 20, 1866. 2. Princess Pia, born Oct. 16, 1847; married, Sep. 27, 1862, to the late King Luis. I. of Portugal.

*Nephews of the King*.—Prince Emanuele Filiberto, Duke of Puglie, born Jan. 13, 1869; Prince Vittoria Emanuele, Count of Turin, born Nov. 24, 1870; Prince Luigi Amedeo, born Jan. 30, 1873; Prince Umberto-Maria, born June 22, 1889—children of the late Prince Amedeo, Duke of Aosta.

*Aunt of the King*.—Princess Elisabetta, born Feb. 4, 1830, the daughter of King Johann of Saxony; married April 30, 1850, to Prince Ferdinando of Savoy, Duke of Genoa; widow Feb. 10, 1855; re-married, in 1856, to the Marquis of Rapallo. Offspring of the first union are:—1. Princess Margherita, born Nov. 20, 1851; married, April 22, 1868, to King Umberto I. 2. Prince Tommaso of Savoy, Duke of Genoa, vice-admiral, born Feb. 6, 1854, married, April 14, 1883, to Princess Isabella, daughter of the late Prince Adalbert of Bavaria; offspring, Prince Ferdinando Umberto, born April 21, 1884.

The '*Dotazione della Corona*', or civil list for the support of the King has been settled at 14,290,000 lire or \$2,858,000. Out of this the children of the late Prince Amedeo, Duke of Aosta have an '*Appannaggio*,' or State allowance, of 400,000 lire; his cousin Prince Tommaso, Duke of Genoa, an allowance of 400,000 lire. The private domains of the reigning family were given up to the State in 1848.

**CONSTITUTION AND GOVERNMENT**.—The constitution of Italy in 1891 is the expansion of the '*Stat-*



*uto fondamentale del Regno,* granted on March 4, 1848, by King Charles Albert to his Sardinian subjects. According to this charter, the executive power of the state belongs exclusively to the sovereign, and is exercised by him through responsible ministers; while the legislative authority rests conjointly in the King and Parliament, the latter consisting of two Chambers—an upper one, the Senato, and a lower one, called the *Camera de' Deputati.* The Senate is composed of the princes of the royal house who are of age, and of an unlimited number of members, above forty years old, who are nominated by the King for life; a condition of the nomination being that the person should either fill a high office, or have acquired fame in science, literature, or any other pursuit tending to the benefit of the nation, or finally, should pay taxes to the annual amount of 3,000 lire, or 120l. On April 14, 1886, there were 315 senators. The deputies of the lower House are elected according to the electoral law of Sept. 24, 1882, which introduced the *scrutin de liste*, by ballot, by all citizens who are twenty-one years of age, can read and write, and pay taxes to the amount of 19 lire, or 80 centesimi. Members of academies, professors, persons who have served their country under arms for twenty years, and numerous other classes, are qualified to vote by their position. The number of deputies is 508, or 1 to every 57,000 of the population (census 1888). The number who had the right to vote in 1886 was 2,420,327. The number who voted in 1886 was 1,415,801, or 58.5 per cent. of those who had the right to vote. For electoral purposes the whole of the kingdom is divided into 135 electoral colleges or districts, and these again into several sections. No deputy can be returned to parliament unless at least one-eighth of the inscribed electors appear at the poll. A deputy must be thirty years old, and have the requisites demanded by the electoral law. Incapable of being elected are all salaried government officials, as well as all persons ordained for the priesthood and filling clerical charges, or receive pay from the state. Officers in the army and navy, ministers, under-secretaries of state, and various other classes of functionaries high in office, may be elected, but their number must never be more than forty, not including the ministers and the under-secretaries of state. Neither senators nor deputies receive any salary or other indemnity, but are allowed to travel free throughout Italy by rail or steamer.

The duration of parliaments is five years; but the king has the power to dissolve the lower House at any time, being bound only to order new elections, and convoke a new meeting within four months. It is incumbent upon the executive to call the parliament together annually. Each of the chambers has the right of introducing new bills, the same as the government; but all money bills must originate in the house of deputies. The ministers have the right to attend the debates of both the upper and the lower House; but they have no vote unless they are members. The sittings of both chambers are public; and no sitting is valid unless an absolute majority of the members are present.

The executive power is exercised, under the king, by a ministry divided into 11 departments.

The two principal elective local administrative bodies are the communal councils and the provincial councils. According to the law of Feb. 10, 1889, each commune has a communal council, a municipal council, and a syndic. Both the communal councils and municipal councils vary according to population, the members of the latter

being selected by the former from among themselves. The syndic is the head of the communal administration, and is a government official; he is elected by the communal council from among its own members, by secret vote, in all the chief communes of provinces and districts, and in other communes having more than 10,000 inhabitants. Electors must be Italian citizens, twenty-one years of age, able to read and write, be on the parliamentary electoral list, or pay a direct annual contribution to the commune, of any nature, or comply with other conditions of a very simple character.

**MOVEMENT OF POPULATION.**—Of the total population in 1881, there were 11,258,968 males, and 11,292 females, exclusive of children under 9 years of age. Of proprietors of land there were 378,786 males, and 335,016 females; proprietors of buildings, 482,058 males, and 299,876 females.

In 1889 there were 229,094 marriages; 1,148,249 births; and 766,131 (exclusive of stillborn) deaths. The number of emigrants from the country reached in 1889, a total of 218,412, of whom 30,238 were to the United States.

The following figures show the increase of the present territory of Italy from 1800, onward in round numbers:

Year.	Population.	Increase per cent. per annum.
1800	18,124,000	
1816	18,383,000	0.089
1825	19,727,000	0.812
1838	21,975,000	0.876
1848	23,617,000	0.747
1861	25,000,000	0.450
1871	26,800,000	0.400
1881	28,460,000	0.619

The agglomerated (not communal) population of the principal cities in Italy, as reported in last official census, was the following:

Towns.	Population.	Towns.	Population.
Naples	463,172	Ferrara	28,314
Milan	295,543	Caltagirone	28,119
Rome	273,268	Mantova	28,048
Turin	230,183	Vicenza	27,694
Palermo	205,712	Como	25,560
Genoa	138,081	Taranto	25,246
Florence	134,992	Trani	24,173
Venice	129,445	Caltanissetta	23,027
Bologna	103,998	Ragusa	21,183
Catania	96,017	Reggio di Cal.	23,853
Leghorn	78,998	Bergamo	23,519
Messina	78,438	Siena	23,445
Verona	60,768	Udine	23,254
Bari	58,266	Termini Imerese	22,733
Padua	47,534	Bitonto	22,726
Parma	44,492	Cerignola	22,659
Brescia	43,354	Acireale	22,431
Modica	38,390	Salerno	22,328
Pisa	37,704	Castellammare di	
Alcamo	37,697	Stabia	22,207
Foggia	36,852	Bisceglie	21,765
Andria	36,795	Vittoria	21,755
Cagliari	35,588	Lecce	21,742
Piacenza	34,987	Torre del Greco	21,588
Trapani	32,020	Partinico	21,000
Barietta	31,994	Catanzaro	20,931
Sasari	31,596	Terlizzi	20,442
Ancona	31,277	Lucca	20,421
Cremona	31,083	Chioggia	20,381
Modena	31,053	Aversa	20,183
Alessana	30,761	Vercelli	20,165
Corato	30,428	Torre Annunziata	20,060
Pavia	29,836	Castelvetrano	20,053
Molfetta	29,697		

AREA AND POPULATION BY PROVINCES.—The kingdom of Italy is now (1891) divided into 69 provinces, whose names, area in English square miles, official census of 1881 and carefully estimated census of 1888, are as follows:

Provinces and Com-partimenti.	Area in square miles.	Census 1881. Total.	Estimated Population 1888.
Alessandria.....	1,976	729,710	790,545
Cuneo.....	2,755	635,400	671,183
Novara.....	2,533	675,926	725,154
Torino.....	4,068	1,029,214	1,077,506
Piedmont.....	11,332	3,070,250	3,264,388
Genova.....	1,572	760,122	802,102
Porto Maurizio.....	467	132,251	136,121
Liguria.....	2,039	892,373	938,223
Bergamo.....	1,088	390,775	424,145
Brescia.....	1,644	471,568	496,860
Como.....	1,050	515,050	558,627
Cremona.....	632	302,138	320,349
Milano.....	1,155	295,728	318,275
Mantua.....	961	1,114,991	1,210,662
Pavia.....	1,284	469,831	507,531
Sondrio.....	1,261	120,534	126,938
Lombardy.....	9,075	3,680,615	3,963,387
Belluno.....	1,271	174,140	191,288
Padova.....	755	397,762	430,771
Rovigo.....	651	217,700	235,464
Treviso.....	941	375,704	414,267
Udine.....	2,515	501,745	547,381
Venezia.....	849	356,708	378,742
Verona.....	1,061	394,065	423,287
Vicenza.....	1,016	396,349	434,241
Venice.....	9,059	2,814,173	3,055,441
Balogna.....	1,391	457,474	492,074
Ferrara.....	1,010	230,807	246,701
Forli.....	719	251,110	270,563
Modena.....	966	279,254	300,195
Parma.....	1,251	267,306	282,840
Piacenza.....	965	226,717	239,408
Ravenna.....	742	225,764	230,439
Reggio Emilia.....	877	244,959	262,928
Emilia.....	7,921	2,183,391	2,325,148
Perugia (Umbria).....	3,719	572,060	616,263
Ancona.....	736	267,338	286,255
Ascoli Piceno.....	809	209,185	227,491
Macerata.....	1,057	239,713	257,947
Pesaro e Urhino.....	1,144	223,043	237,529
Marches.....	3,746	939,279	1,009,222
Caltanissetta.....	1,455	266,379	294,275
Catania.....	1,970	563,457	615,183
Girgenti.....	1,491	312,487	348,330
Messina.....	1,768	460,924	502,556
Palermo.....	1,964	699,151	766,250
Siracusa.....	1,427	341,526	384,692
Trapani.....	1,214	283,977	314,273
Sicily.....	11,289	2,927,901	3,225,550
Cagliari.....	5,257	420,635	447,056
Sassari.....	4,142	261,367	283,184
Sardinia.....	9,399	682,002	730,240
Total.....	114,410	28,459,682	30,565,253

COLONIES.—The government and people of Italy have long been seeking to come into possession of colonies, and since the annexation of Tunis to France, the opinion seems to have been strongly cherished, that in the probable breaking up of the Turkish Empire, Italy should get Tripoli and Barka as her part of the plunder. At present (1891), Italy claims possessions in Africa on the coast of the Red Sea, extending from Cape Kasar (18° 2' N.) to the southern limit of the Sultanate of Raheita, on the strait of Bab-el-Mandeb (12° 30' N.). This tract comprises Massowah and its territory (with the adjacent Dahlak archipelago), and Assab and its territory, with Beilul and Gubbi to Cape Rakhmat and Cape Sintiar. The territory of Assab, on the Red Sea, apposite Aden, has an area of 548 square miles, with a population of 6,800 (1888). The length of coast is about 670 miles, and the population, which is to a great extent nomadic, is roughly estimated at 219,600; Massowah having 16,000 inhabitants, of whom 500 are Italians (exclusive of the garrison), 700 Greeks, 50 other Europeans, and 100 Banians (Indians). Trade of Massowah in 1887 (imports and exports), by land, 158,930 lire; by sea, 12,614,447 lire; vessels entered, 2,065 (1,241 Italian) of 200,997 tons; cleared, 1871, 1,200 Italian, of 211,143 tons. There are 17 miles of railway from Massowah to Saate. During the year 1889 Keren was occupied in June, Asmara in August, and the Sultanate of Obbia, on the Somali coast, was brought within the Italian protectorate in February 1889.

In consequence of a recent treaty with the sultan of the Mijertain Somalis, placing the northern part of his territory under the protection of Italy, the sphere of Italian influence on the east Somali coast now reaches northwards to Cape Hafun, where it is interminous with British protected territory. From this point it stretches southwards to the mouth of the river Jub, a few miles south of the equator, making a total coast line of about 800 geographical miles, with undefined landward limits.

In 1889 an arrangement was concluded with the king of Abyssinia, whereby the whole of that country, including Shoa, was placed under the protection of Italy.

According to Professor Guido Cora, of Turin, the area and population of the territories under Italian influence (including Abyssinia and Shoa) are the following:

Country.	Area in sq. miles.	Population
<i>Possessions:</i>		
Country around Massowah, with Keren and Asmara.....	3,100	250,000
Dahlak Archipelago.....	420	2,000
Assab Territory.....	550	6,800
<i>Protectorate:</i>		
Territory of the Habab, Rogos, Beni-Amer, etc.....	18,000	200,000
Territory of the Afar or Danakil, including the Suetanate of Aussa... Somali coast (Oppia, etc.), with a tract of the interior country extending to Wadi, Nogal and Mudug.....	34,000	200,000
Kingdom of Abyssinia (Tigré, Lasta, Amhara, Gojam, Shoa, Kaffa, Harrar, etc.).....	190,000	5,000,000
Total.....	336,070	5,958,800

\*The Italian *lira* is equivalent to the French *franc*.

REVENUE, EXPENDITURE AND FINANCIAL CONDITION.—The official Budget estimates the revenue and expenditure for the financial year ending June 30, 1861, as follows: Ordinary revenue, 1,652,354,663 lire; extraordinary revenue, 197,893,509 lire; total, 1,850,248,142 lire. Ordinary expenditures, 1,579,911,316 lire; extraordinary expendi-



tures, 292,221,957 lire; total for year ending 1891, 1,872,133,271. Excess of expenditures over income for the year, 21,885,129.

The following figures, compiled from the official exhibits, show the variations of the government balance sheet for the last seven years, and are exceedingly suggestive to financial readers:

Years.	Total revenue.	Total Expend.	Difference.
	Lire.	Lire.	Lire.
1884-85	1,709,741,994	1,674,409,463	+ 35,333,531
1885-86	1,745,515,911	1,730,598,335	+ 14,917,576
1886-87	1,801,185,804	1,789,418,851	+ 11,771,953
1887-88	1,936,724,649	1,963,875,769	-- 27,151,120
1888-89	1,913,946,799	2,105,765,840	-- 191,819,041
1889-90	1,801,397,772	1,857,906,850	-- 56,509,078
1890-91	1,890,248,142	1,872,133,271	-- 21,885,129

On July 1, 1890, the capital of the consolidated and redeemable public debt was 11,241,000,000 lire, or about \$2,255,000,000. The burden per head of the population was about \$75. The value per head of the special exports in 1889 was about \$6.12. On June 30, 1889, the public property of Italy was estimated at a total of 6,506,401,645 lire.

Direct taxes are those on lands, on houses, and on incomes derived from movable capital and labor. The tax on lands, amounting to about 96,000,000, with an additional tenth, is spread over the nine cadastral compartimenti. That on houses is at the rate of 12.5 per cent (with three-tenths additional) of the amount taxable, which is two-thirds of the real annual value in the case of factories, and three-fourths in the case of dwelling-houses. The tax on incomes from movable capital and labor is 13.2 per cent. of the sum taxable. This, in incomes from capital alone, is the whole amount stated as income; in those from capital and labor (trade industries), it is six-eighths, and in those from labor alone (professions), it is five-eighths of the income stated. In the case of state, provincial, or communal employes, half the income is taxable. The communes and provinces also tax lands and buildings. The state grants to the communes one-tenth of the proceeds of the tax on incomes as compensation for other communal revenues made over to the State by various laws.

The principal indirect taxes are: the customs duties, the octroi, the taxes on manufactures, the salt and tobacco monopolies, lotto.

**RELIGION AND EDUCATION.**—The Roman Catholic Church is nominally the ruling State Church of Italy; but many acts of the legislature, passed since the establishment of the kingdom, and more especially since the suppression of the temporal government of the supreme pontiff, have subordinated the power of the church and clergy to the authority of the civil government, and secured perfect religious freedom to the adherents of all creeds without exception. However, scarcely any other creeds as yet exist but Roman Catholicism. At the census of 1881, of the total population about 62,000 were Protestants, and 38,000 Jews. Of the Protestants 22,000 belonged to the Waldensian Church of Piedmont, about 10,000 to the other evangelical Italian churches, and 30,000 belonged to foreign Protestant bodies. In 1861 (exclusive of Veneto and the province of Rome), the total number of Protestants was 32,684, and Jews, 22,458; and in 1871 (inclusive of the Veneto and Rome), 58,651 Protestants, and 35,356 Jews. For article on ROMAN CATHOLIC CHURCH, see said topic in Britannica and in these Revisions and Additions.

The State regulates public instruction, and maintains, either entirely or in conjunction with the communes and provinces, public schools of every grade. Every teacher in a public institution main-

tained by the state, or by any other public body, must have the qualifications required by law; and in all public institutions not belonging to the state, the same programme must be followed, and the same rules observed. No private person can keep a school without having obtained the authorization of the state.

Elementary education is compulsory for children between six and nine years of age. (Of these, according to the census of 1881, there were 1,808,129.) The compulsory clause is by no means strictly enforced. The enactment, however, provided that education for children of school age should be compulsory only when the supply of teachers should reach the proportion to population, in the least populous communes, of one to every 1,000 inhabitants; in the most populous, one to every 1,500 inhabitants. The law (1889) has been applied to 8,173 communes out of 8,527. Schools in Italy may be classified under four heads, according as they provide: (1) elementary instruction; (2) secondary instruction—classical; (3) secondary instruction—technical; (4) higher education.

Of these various educational institutions, the elementary schools are supported by the communes, subsidies or free loans being occasionally granted by the state. In the normal schools and *licei*, the state provides for the payment of the staff and for scientific material. The *ginnasi* and technical schools should, according to the general law, be supported by the communes; but in many cases, the cost of these is borne, in great part, by the state. In the technical institutes, half the sum paid to the staff is provided by the state. The universities are maintained by the state and by their own ancient revenues, such expenses as those for scientific material, laboratories, etc., being, in some cases, borne by the various provinces of the university region. The higher special schools are maintained conjointly by the state, the province, the commune, and, sometimes, the local chamber of commerce.

**ARMY AND NAVY.**—The Italian army in 1888, including the local and active militia, had a total nominal strength of 2,590,172 men on the war footing. The force is divided into regular army in peace, 265,889, in war, 630,582; movable militia, 379,908; local militia, 1,313,793. The navy in 1888, including ships building, consisted of 228 vessels manned by about 16,000 men; 21 of the ships are ironclads, several of the most powerful construction. There are also 15 torpedo vessels and 156 torpedo boats. Naples, with a population of more than 500,000, is the chief naval and military port of the kingdom, and will shortly take the precedence of Genoa.

In Italy, universal liability to arms forms the basis of the military organization of Italy. A certain portion of all the young men who have completed their twentieth year, amounting to about 200,000, is levied annually, 82,000 of whom are drafted into the standing army, while the rest are entered in a second and third category.

According to the law of August 6th, 1888, the time of service in the standing army for the first category of recruits is five years in the infantry, four years in the cavalry, and three years in the other arms. Having completed their service under arms, the men of the first category are granted unlimited leave, but are enrolled in the permanent army, the infantry for four years, the cavalry five years, when they are both transferred to the territorial militia. The men belonging to the other arms are enrolled in the permanent army for five or six years, when they are transferred to the mobile militia, in which they complete twelve years of service before being transferred to the territorial

militia. Those of the second category are entered in the permanent army for eight years, and the mobile militia for four years, when they form part of the territorial militia. The men of the third category are entered at once in the territorial militia, but are given unlimited leave. The total period of service is 19 years. As in the German army, young men of superior education are permitted under certain conditions to serve as one-year volunteers.

On Jan. 1, 1890, there were on the registers of the Italian mercantile marine 6,442 sailing vessels with a total tonnage of 642,225 tons; and 279 steam vessels, with a total of 182,249 tons. Also at that date there were building for the navy three iron-clads with a total displacement of 40,456 metric tons; 6 torpedo rams of a total tonnage of 17,329 tons; also one gunboat and three torpedo cruisers. Total tonnage building, 63,810, and horse power, 116,700.

**INTERNAL COMMUNICATIONS.**—A large portion of the Italian railways belong to the state, but in accordance with a law of April 27, 1885, the working of the state lines has been transferred to private enterprise. The contracts are for 60 years, but at the end of 20 and 40 years they may be terminated.

On December 31, 1887, there were 7,625 kilometres of state railway, 344 kilometres jointly state and companies', and 3,862 kilometres of companies' railway; in all 11,831 kilometres. On June 30, 1888, the total was 11,984 kilometres. On June 30, 1889, the length of the principal lines was: Mediterranean, 4,744 kilometres; Adriatic, 5,145 kilometres; Sicilian, 700 kilometres; Sardinian, 411 kilometres; various, 1,831 kilometres; total, 12,891 kilometres.

In 1887 the total receipts were 236,266,276 lire, of which 95,132,681 lire were for passenger traffic. In the same year the expenses were 156,604,100 lire. By slow trains there were forwarded 15,051,341 tons of goods, and by fast trains 7,496,673 quintals of goods, to the value of 855,211,000 lire. The number of passengers was in all 45,518,604.

Up to October 1, 1888, there had been constructed 2,262 kilometres of tramway.

Statistics regarding the river and canal traffic do not exist. The Po is navigable for 543 kilometres, the Adige for 212 kilometres, the Tiber for 144 kilometres, and the Arno for 103 kilometres. There are besides upwards of 1,054 kilometres of navigable canal.

The public telegraph service is a monopoly of the government, certain concessions, however, being made to the railway and tramway companies. On June 30, 1888, the length of line and wire on land was: Government lines, 31,512 kilometres; railway lines, 2,336 kilometres; Government wire, 90,675 kilometres; railway wire, 27,830; total railways, 33,848 kilometres; total wire, 118,503 kilometres.

**ITASCA LAKE**, a lake in Beltrami and Cass counties, Minn., the supposed source of the Mississippi River. Its elevation is 1,575 ft. and it receives various streams one of which is several miles in length; this gives color to the theory that Itasca is not the source of the great river which here leaves the lake as a stream 12 ft. wide and 2 ft. deep.

**ITHACA**, a village and county-seat of Gratiot county, Mich. It contains a furniture-factory, a foundry, a newspaper office and several hotels and churches.

**ITHACA**, the county-seat of Tompkins county, N. Y., situated at the south end of Cayuga Lake, 37 miles south of Auburn, 40 miles E.S.E. of Geneva, and 35 miles N.N.E. of Elmira. Ithaca is built partly on an alluvial plain, and partly on the slopes of high hills which inclose that plain on all sides except the north and are nearly 600 feet higher than the lake. The town contains many public buildings, and also manufactories of flour, paper, carriages, farming implements, iron castings, machinery, etc. It is the seat of Cornell University. Population in 1880, 9,105; in 1890, 11,557.

**ITU**, a town of Brazil, in the province of San Paulo, forty miles north-northwest of the town of San Paulo, on the Tiete, in a very fertile district, surrounded by lofty hills. Most of the houses are built of earth in a frame of wood. Sugar-cane is extensively cultivated in the surrounding district.

The town contains a hospital, a prison, and several churches and schools. Population 10,000.

**ITTÄS**, Central American Indians, whose capital was Chichen Itza, in Yucatan. Tribes of this name are still found near Lake Peten, in Guatemala. See *Britannica*, Vol. XXIV, p. 759.

**IUKA**, a post-village, capital of Tishomingo county, Miss., situated on the railroad, 115 miles from Memphis, Tenn. It has a female institute, a male academy, and valuable mineral springs. Here occurred an indecisive battle between General Rosecrans and General Price on Sept. 19, 1863.

**IVES**, LEVI SILLIMAN (1797-1867), an American Protestant Episcopal clergyman. In 1822 he was made deacon and in the following year was ordained priest. He held pastorates in Batavia, N. Y., Philadelphia and Lancaster, Pa., and in 1831 was elected bishop of North Carolina. In 1852 he became a Roman Catholic, and was made professor of rhetoric in St. Joseph's theological seminary, Fordham, N. Y. He afterwards established the Roman Catholic protector for destitute children, and became its first president. He was the author of a *Catechism; Manual of Devotion; Humility a Ministerial Qualification; Sermons on the Obedience of Faith*, and *The Trials of a Mind in Its Progress to Catholicism; A Letter to His Old Friends*.

**IVISA**, IVIZA or IVICA, the most southerly of the Balearic Isles. See *Britannica*, Vol. III, p. 278.

**IVORY BLACK**, a black pigment prepared from calcined ivory or bones. See *Britannica*, Vol. XIX, p. 88.

**IVY**. See *Britannica*, Vol. XIII, pp. 526-527.

**INCAQUIXTLA**, the chief town of the Chucón Indians, situated in the southern part of the state of Puebla, Mexico. It is noted in Mexican history as the scene of a battle fought Jan. 1, 1817, between Mexican insurgents under General Mier of Terán and Spanish troops under La Madrid. There are extensive remains of antiquity in the vicinity.

**IXTAPALAPA**, a town of Mexico, 10 miles southeast of the capital. It was a large and important city at the time of the conquest of Mexico, and was celebrated for its splendid gardens belonging to the Aztec emperors. Few traces of its former importance now remain. Near the town is the Cerro de la Estrella, or Star Hill, where the Aztec priests performed peculiar religious rites. Remains of the ancient altar and temple still exist on the summit of the hill.

**IXTLAN**, a town of Mexico, in the State of Oaxaca, 40 miles from the capital of the state. There are silver mines in the neighborhood. The inhabitants are mostly Indians.

**IZARD**, GEORGE (1777-1828), an American soldier. In 1794 he was appointed a lieutenant of artillery; in 1798, engineer of fortifications in Charleston harbor; in 1799, captain; in 1812, colonel of artillery; in 1813 brigadier-general; and in 1814, major-general. From 1825 until his death he was governor of the territory of Arkansas. He published in 1816, *Official Correspondence With the War Department in 1812 and 1815*.

**IZARD**, RALPH (1742-1804), an American statesman. In 1776 Congress appointed him a commissioner at the court of the grand-duke of Tuscany, and in 1780 he returned to the United States. In 1782-83 he was a delegate to the Continental Congress, and from 1789 to 1795 was a United States Senator from South Carolina. His *Correspondence from 1774 to 1784*, was published in 1844.

**IZUCAR**, a town of Mexico, State of Puebla, at the foot of the volcano Popocatepetl, in a fine sugar district. It is sometimes called Matamoros Izucar, in honor of the Mexican patriot of that name. Population about 12,000.



## J

## JACK—JACKSON

JACK, JAK, or JACA (*Artocarpus integrifolia*), a tree of the same genus as the bread-fruit, a native of the East Indies. It is a larger tree than the bread-fruit, and has larger fruit. See *Britannica*, Vol. IV, p. 242; also *ARTOCARPUS*, in these Revisions and Additions.

JACK, a name generally used as the equivalent of John, the most common of Christian names, but it is really the French Jacques. The contempt that follows on excessive familiarity attaches itself in most European languages to the name, as in such vulgarisms as "Jack-of-all-trades," "Jack-fool," etc. "Jack the Giant-killer," and "Jack and the Bean-stalk" show the same sense of familiarity without the accompanying contempt.

JACK-BOOTS, tall boots of tough thick leather, reaching above the knee, formerly worn by cavalry. In some instances, as an additional protection against sword-cuts, they were lined with thin plates of iron.

JACKSON, the county-seat of Amador county, Cal., 55 miles southeast of Sacramento, situated at the confluence of the north, middle, and south forks of Jackson Creek. It has quartz mills and the chief occupations are gardening, farming, quartz and placer mining.

JACKSON, a city and county-seat of Jackson county, Mich., situated on Grand River, 76 miles west of Detroit, 37 miles south of Lansing, and 94 S. E. of Grand Rapids. It contains the State prison, several churches, schools, and banks, gas-works, water-works, flouring-mills, machine-shops, foundries, sash-and-blind factories, planing-mills, breweries, manufactories of furniture, agricultural implements, carriages and wagons, railroad-cars, pumps, and cigars, and also has several coal mines. Population in 1860, 4,799; in 1870, 11,447; in 1880, 16,105; in 1890, 20,779.

JACKSON, the capital of the State of Mississippi, and the county-seat of Hinds county, situated on the west bank of the Pearl River, 183 miles north of New Orleans, 45 miles east of Vicksburg, and 96 miles west of Meridian. Lat. 32° 18' N., long. 90° 6' W. It contains the state-house, the penitentiary, and several charitable and educational institutions. Many thousand bales of cotton are annually shipped from this place. Population in 1880, 5,204; in 1890, 6,041.

JACKSON or JACKSON COURT-HOUSE, a railroad junction and county-seat of Jackson county, Ohio, containing pig-iron furnaces and coal mines.

JACKSON, a city and county-seat of Madison county, Tenn., on the south fork of the forked Deer River, 90 miles E.N.E. of Memphis, and 107 miles south by east of Cairo, Ill. It is the seat of the Southwestern Baptist University, and has a court-house, a bank, an opera-house, several white and colored female seminaries, gas-works, planing-mills, an iron foundry, and railroad workshops. Cotton is the chief article of export. Population in 1870, 4,119; in 1880, 5,377; in 1890, 10,022.

JACKSON, CHARLES THOMAS (1805-1880), an American scientist. After studying medicine in America and Europe, he settled in Boston, Mass., and began the practice of his profession. In 1838 he opened a laboratory for research in analytical chemistry, the first of its kind in the United States.

In 1836 he was made State geologist of Maine, in 1839 of Rhode Island, and in 1841 of New Hampshire, retaining the last office until 1844. In 1847 Congress appointed him to survey the mineral lands of Michigan, but, after two years devoted to this work, he was displaced in consequence of political changes. Dr. Jackson made many important scientific discoveries, one of the most valuable being that of etherization, for which he received a prize of 2,500 francs from the French Academy of Science. He published many papers and reports, besides a *Manual of Etherization, with a History of its Discovery* (1861).

JACKSON, CHARLES (1775-1855), an American jurist. In 1796 he was admitted to the practice of law in Newburyport, Mass., and in 1803 removed to Boston, where he attained a high rank at the bar. From 1813-24 he was judge of the Massachusetts supreme court, and in 1833 was chairman of a commission to codify the State laws. In 1828 he published a treatise on *Pleadings and Practice in Real Actions*.

JACKSON, HELEN MARIA FISKE, an American authoress, born at Amherst, Mass., Oct. 18, 1831, died at San Francisco, Cal., Aug. 12, 1885. She was educated at the Ipswich, Mass., female seminary, and in 1852 became the wife of Major E. B. Hunt (1822-63), of the United States Engineers. In 1875 she contracted a second marriage, to William S. Jackson, of Colorado Springs, Colo., where much of her after-life was spent. In 1879 she became interested in the treatment of the Indians by the United States Government, and in 1883 was appointed special commissioner to examine into the condition of the Mission Indians of California. Her literary productions, over signature "H. H." began to attract attention about 1870, and soon won a brilliant popularity. Among her published works are *Verses, Bits of Travel, A Century of Dishonor, Ramona, Easter Bells, Glimpses of Three Coasts, and Between Whites*.

JACKSON, ISAAC W. (1805-1877), an American educator. From 1826 to his death he was a professor at Union College. He did much toward developing the art of landscape-gardening and horticulture, and contributed largely to the introduction, perfecting, and distribution of the choicest flowers. Professor Jackson wrote *Elements of Conic Sections* (1854), and a *Treatise on Optics* (1854).

JACKSON, JAMES (1757-1806), an American soldier. He studied law in Savannah, Ga., and in 1776 was active in repelling the British from that city. He afterwards took part in many important battles, and attained the rank of brigadier-general. In 1788 he was chosen governor of Georgia, but declined to serve, and from 1789 to 1791, was a member of the first Congress. From 1793 to 1795, he was United States Senator from Georgia, from 1798 to 1801, governor of the State, and from 1801 to his death was again Senator.

JACKSON, JOHN ADAMS (1825-1879), an American sculptor. After studying in Boston, Paris, and New York, he settled in Florence, where he produced numerous popular works. Among his portrait busts are those of *Daniel Webster* (1851); *Adelaide Phillips* (1853); and *Wendell Phillips* (1854). Some of his other productions are *Eve and the Dead Abel*

(1862); *Autumn*; *Cupid Stringing his Bow*; *Titania and Nick Bottom*; *The Culpit Fay*; *Dawn*; *Peace*; *Cupid on a Swan*; *The Morning Glory*; *Reading Girl* (1869); *Musidora* (1873); *Hylas* (1875), and *Il Pas-torello*.

JACKSONVILLE, a city and county-seat of Morgan county, Ill., situated 34 miles west by south of Springfield, 80 miles east-southeast of Quincy, 67 miles north of Alton, and 90 miles north of St. Louis, Mo. Jacksonville contains many handsome buildings, and is noted for its educational and charitable institutions. It is the seat of Illinois College, a high-school, a ladies' atheneum, the Illinois Female College, the Jacksonville Female College, a State asylum for the insane, an asylum for the idiotic, an institute for the education of the blind, and an institute for the deaf and dumb. The institutions for the blind and deaf and dumb are supported by the State. The city has a large woolen mill, car-works, water-works, a foundry, and manufactories of candy, paper, furnishing goods, boilers, etc. Population in 1860, 5,528; in 1870, 9,203; in 1880, 10,927; in 1890, 12,357.

JACKSONVILLE, the most populous city of Florida, and the county-seat of Duval county, situated on the left or west bank of the St. John's River, about 20 miles from its mouth. It is 30 miles southwest of Fernandina, 155 miles south by west of Savannah, and 165 miles east of Tallahassee. Latitude 30° 19' 38" north, by longitude 81° 30' west. Jacksonville has several churches and banks, a high-school, the Stanton Institute, and manufactories of lumber, marmalade, moss, soap, and machinery. Lumber is the chief article of export. Population in 1860, 2,118; in 1870, 6,912; in 1880, 7,650; in 1890, 17,160.

JACMEL, or JACQUEMEL, a port and city on the south coast of Hayti, 30 miles southwest of Port Au Prince. It has a deep, commodious harbor and carries on commerce with the United States.

JACOB, BIBLIOPHILE. See LACROIX, Paul, in these Revisions and Additions.

JACOBÆAN LILY (*Spreckelia Formosissima*), a plant of the order *Amaryllidæ*. The leaves are directly from the bulb, which is long necked, protruding above the surface of the ground; the flowers are large, irregular, and of a brilliant crimson color. It is native in Mexico, and cultivated elsewhere.

JACOBI, ABRAHAM, an American physician, born in 1830. After studying medicine for several years in Germany, he settled in New York City. In 1861 he was made professor of diseases of children in the New York Medical College, from 1867 to 1870, held a similar chair in the medical department of the university of the city of New York, and in the latter year in the college of physicians and surgeons. He has held important offices in various scientific societies, and is the author of many valuable works on medical topics.

JACOBI, MARY PUTNAM, an American physician, wife of the preceding, born in 1842. She studied medicine in Philadelphia, New York, and Paris. For twelve years she was dispensary physician in Mount Sinai hospital, was professor of materia medica in the woman's medical college of the New York infirmary, and later became professor in the New York post-graduate medical school. She has contributed much to medical literature.

JACOB'S LADDER (*Polemonium caruleum*), an herbaceous perennial plant of the natural order *Polemoniaceæ*, common in the centre and south of Europe, and found also in the temperate parts of Asia and North America. It has pinnate leaves, with ovato-lanceolate leaflets, a smooth stem 1½ to 2 feet high, and a terminal panicle of bright blue

(sometimes white) flowers, with wheel shaped, five-lobed corolla. See *Britannica*, Vol. XII, p. 252; also *Phlox*, Vol. XVIII, p. 798.

JAGERNDORF, or KARNOW, a walled town of Austrian Silesia, 34 miles west of Ratibor. It has manufactories of woolen cloth, linen, organs, etc. Population 11,792.

JAHN, FRIEDRICH LUDWIG, known as Turnvater Jahn, born at Lanz, in Prussia, Aug. 11, 1778, died at Freiburg, Oct. 15, 1852. He studied theology at Halle and Göttingen, and in 1805 went to Jena to continue his studies, but soon afterward decided to enlist in the Prussian army. In 1809 he went to Berlin, and in the following year became a teacher in a gymnasium and published his *Das Deutsche Volksthum*. In 1811 he opened the first turn establishment in Berlin, and rendered the science of gymnastics so popular that it soon attracted the attention of the youth throughout the kingdom. It at once formed centres around which German patriotism gathered and developed, and its influence on the whole system of education was lasting and beneficial. In 1814 Jahn was placed in command of a volunteer corps, served in the subsequent campaigns, and entered Paris in 1815. After the war, however, he opposed the reactionary policy of the government, the turn-places became nurseries of liberal thought, and in 1818 he was seized by the Prussian government and imprisoned. He was liberated in 1825, but was not allowed to reside in any university town. He settled at Freiburg, where he wrote *Neue Runenblätter* in 1828, and *Merken Zum Deutschen Volksthum* in 1833. In 1848 he was elected to the national assembly, but took no prominent part.

JAIL FEVER, known also as putrid or pestilential fever, probably a severe form of typhus. Owing to improved sanitary regulations this form of disease is at present almost unknown.

JAMAICA, the county-seat and railroad junction of Queen's county, N. Y., on Long Island, 10 miles east of New York City. The chief occupations are manufacturing carriages, and market-gardening.

JAMES, HENRY (1811-1882), an American theologian. He studied theology both in America and abroad, and became a follower of the tenets of the Sandemanian sect. For many years he resided in New York City, and for some time in Newport, R. I., but in 1866 went to Cambridge, Mass., where he remained until his death. He was a constant contributor to periodical literature, and published *Moralism and Christianity, or Man's Experience and Destiny* (1850); *The Church of Christ Not an Ecclesiasticism* (1854); *Christianity the Logic of Creation* (1857); *Substance and Shadow, or Morality and Religion in their Relation to Life* (1863); *The Secret of Swedenbourg, Being an Elucidation of His Doctrine of the Divine Natural Humanity* (1879); and *Society the Redeemed Form of Man*, besides many other works.

JAMES, HENRY, an American novelist, born in 1843. He studied in the United States and in Europe, and began to write novels at an early age. In 1869 he went to Europe where he has since resided, alternating between England and Italy. Among his works are: *The Story of a Year*; *Poor Richard* (1867); *Gabrielle de Bergenac* (1869); *Watch and Ward* (1871); *Roderick Hudson* (1875); *A Pious Pilgrim* (1875); *The American* (1878); *Daisy Miller* (1878); *The Europeans* (1878); and *Penion Beaurepas*, besides numerous essays and short novels.

JAMES, SIR HENRY, Q. C., M. P., born at Hereford, England, in 1828, received his education at Cheltenham College, and was called to the bar of



the Middle Temple in 1852. In 1850, as again in 1851, he attained legal distinction as lecturer's prizeman at the Inner Temple. He became the Queen's Counsel in 1869, a bencher of his Inn in 1870; and in 1869 entered the house of commons for Taunton, which he continued to represent in the Liberal interest until 1885. In 1873 he was appointed solicitor-general, and was attorney-general in 1873-74 and again in 1880-85. During the latter period he introduced and carried through parliament the Corrupt Practices Act. Returned for Bury in 1885, he refused to follow Mr. Gladstone upon the Home Rule question, and since then has been one of the active leaders of the Liberal Unionist party. Sir Henry defended the case for the "Times" before the commission appointed to investigate the charge against Mr. Parnell and the Irish members.

JAMES, SIR HENRY, an English engineer and inventor, born near St. Agnes, in Cornwall, in 1803, died at Southampton, June 15, 1877. He was educated at the Royal Military Academy, Woolwich, and in 1825 passed into the Royal Engineers. In 1844 he was appointed director of the Geological Survey of Ireland, in 1846 head of the Admiralty works at Portsmouth; in 1852 director of the Ordnance Survey of the United Kingdom, and in 1857 chief of the Statistical and Topographical Department of the War Office. He was knighted in 1860, and made major-general in 1868. He is best known for his successful efforts to introduce applications of photography into the service of the exact sciences. By means of photozincography, a process which he invented in 1859, he produced fac-similes of *Domesday Book*, and of national manuscripts of England, of Scotland, and of Ireland. He is the author of several works on geology, surveying, etc.

JAMES BAY, the southerly arm of Hudson Bay, about 250 miles long from north to south, and 175 miles wide. It is greatly beset with islands, and its navigation is dangerous.

JAMES ISLAND, one of the sea islands of Charleston county, S. C., having James Island Creek on the landward side, and being bounded north by Ashley River and Charleston harbor. Several spirited engagements occurred upon this island during the late civil war.

JAMESON, JOHN ALEXANDER, an American jurist, born in 1824. He was tutor at the University of Vermont from 1850 to 1853, and then began the practice of law in Freeport, Ill., where he remained three years. In 1856 he removed to Chicago, and from 1865 to 1883 was judge of the superior court of that city. He wrote *The Constitutional Convention, Its History, Powers, and Modes of Proceeding* (1867.)

JAMES RIVER, 450 miles in length, is formed by the union of Jackson's and Cowpasture rivers in the west of Virginia, and has its entire course in that State. It flows in a general east-southeast direction, passing Lynchburg and Richmond, and falls into the Atlantic at the southern extremity of Chesapeake Bay.

JAMES'S POWDER, the modern representative of an old nostrum of Dr. Robert James of London. The preparation in the pharmacopœa which is supposed to have similar virtues in febrile affections, consists of oxide of antimony and phosphate of lime. Medical opinion is divided as to its efficacy, and it is now but little used.

JAMESTOWN, the county-seat of Stutsman county, N. Dak., 93 miles west of Fargo. It is on the North Pacific Railroad and contains an insane asylum.

JAMESTOWN, a town of Chautauqua county, N. Y., on the navigable outlet of Chautauqua

Lake, 27 miles east-northeast of Corry, Pa., 20 miles southeast of Mayville, and 69 miles south by west of Buffalo. It contains several churches, national banks, and hotels, and also has a union school, the Jamestown Collegiate Institute, a piano-factory, a woolen-mill, a large manufactory of alpaca, a manufactory of tools, etc. Population in 1879, 5,336; in 1880, 9,357; in 1890, 15,991.

JAMESTOWN, a ruined village of James City county, Va., where in 1607 the first permanent English settlement was made in America. The place was burned by Bacon in 1676 and never rebuilt.

JAMNOTRI, or JUMNOTRI, hot springs near the source of the Jumna, or Jamuna, 10,849 feet above the sea, in lat. 30° 59' N., and long. 78° 35' E. Their temperature is 104° 7 F., nearly that of boiling water at their elevation. They are overhung by three connected mountains known as the Jumnotri Peaks, 25,500 feet high.

JANES, EDMUND STORER (1807-1876), an American Methodist Episcopal bishop. In 1830 he was admitted to the Philadelphia conference, and from 1840 to 1844 was financial secretary of the American Bible Society. In the latter year he was elected and ordained bishop, and in 1854 he visited Europe as a delegate to the British Wesleyan conference. From his election to the episcopacy until his death he resided in New York City. For an extended and appreciative biography of Bishop James, see *Bishops of M. E. Church*, Methodist Book Concern, New York.

JANESVILLE, a city and county-seat of Rock county, Wis., situated on both sides of Rock River, 70 miles W.S.W. of Milwaukee, 13 miles north of Beloit, and 91 miles N.W. of Chicago. It contains a court-house, several churches and banks, a high-school, a State institution for the education of the blind, a cotton-factory woolen factories, flouring-mills, machine-shops, foundries, and manufactories of farming implements, carriages, boots, shoes, etc. Population in 1880, 9,018; in 1890, 10,631.

JANET, PAUL, a French author, born at Paris April 30, 1823, and educated at the Ecole Normale, graduating in 1848. He was in turn teacher in the gymnasium at Bourges, and professor of philosophy in the faculty at Strasburg and of logic in the lyceum Louis-le-Grand. In 1864 he was elected to the Academy of Moral and Political Sciences, and since that year has lectured in the Sorbonne at Paris. M. Janet is a leading representative of modern French philosophy. Among his numerous works are: *Histoire de la Philosophie Morale et Politique* (1858); *Le Materialisme Contemporain en Allemagne* (1864); *Les Causes Finales* (1876); and *Les Origines du Socialisme Contemporain* (1883).

JANNEY, SAMUEL MACPHERSON (1801-1880), an American preacher and author. He was a minister of the Society of Friends, and traveled extensively in that capacity. In 1869 he was made United States Superintendent of Indian affairs in the northern superintendency. Among other works, he was the author of *Conversations on Religious Subjects* (1835); *The Last of the Lenape, and Other Poems* (1839); *The Teacher's Gift* (1840); *An Historical Sketch of the Christian Church During the Middle Ages* (1847); and a *History of the Religious Society of Friends, from Its Rise to the Year 1828* (1860).

JANS, ANNEKE (1600-1663) a Dutch woman, born about 1600; came to America with her husband, Reelof Jansen. They settled in New Amsterdam, now New York, and in 1636 obtained from Gov. Wouter Van Twiller, a grant of 62 acres lying between Broadway and the North River. Jansen died soon and his widow married in 1637 Evardus Bogardus, a Dutch clergyman. Ten years later the latter was ship-wrecked and drowned near

Wales, England. Anneke Jans obtained in 1864 from Gov. Peter Stuyvesant a patent for the farm in her own name, and this grant was confirmed by the English government in 1664. But in the meantime she had died in 1663, leaving the estate to her 8 children. In 1671 five of the heirs deeded the farm to Gov. Francis Lovelace, as representative of the proprietary, the Duke of York. In 1705 the same estate, then known as the King's Farm, was granted by the colonial government to Trinity Church, which owns the larger part of the land up to the present time.

JANSEN, KRISTOFER, a Norwegian clergyman, born in 1841. While in Norway he was interested in the movement which had in view the replacing of the Danish language, which is the Norwegian language of literature, by the truly Norwegian language, and he wrote a large series of novels in this language. In 1882 he came to this country, and settled in Minneapolis, Minn., taking charge of the Unitarian parish in that city. Among his books translated into English are *The Spellbound Fiddler*; *The Children of Hell*; and *Wives, Submit Yourselves to Your Husbands*.

JANTHINA, a genus of violet-colored ocean snails living in mid-ocean. They float on the open sea supported by a cartilaginous raft which contains numerous air-cells. Their eggs and young are attached below the float. They are carnivorous gasteropods, feeding on little medusæ, sea-nettles, jelly-fishes, etc. See Britannica, Vol. XVI, pp. 648, 651.

JANUARIUS, ST., ORDER OF, an order founded by King Charles of Sicily in 1738. It was abolished after the French invasion of 1806, and re-introduced in 1814.

JAPAN. For general article on the Empire of JAPAN, see Britannica, Vol. XIII, pp. 569-595.

The official returns of 1888 report the area of Japan as 147,526 square miles, with a population of 39,069,007 (19,731,354 males, and 19,337,653 females) as follows:

	Sq. M.	Population.	Density per sq. mile.
Central Nippon.....	36,588	15,112,169	413
Northern ".....	30,198	5,898,191	195
Western ".....	20,682	8,994,962	435
<b>Total Nippon.....</b>	<b>87,468</b>	<b>30,005,322</b>	<b>343</b>
Shikoku.....	6,932	2,802,066	404
Kiushiu.....	16,839	6,021,458	357
Hokkaido.....	36,287	239,566	6.6
<b>Grand total.....</b>	<b>147,526</b>	<b>39,069,007</b>	<b>265</b>

Tokio (formerly called Yedo) is the present capital.

The following is a list of the principal cities, with their populations:

Tokio.....	1,165,048
Osaka.....	432,005
Kioto.....	264,559
Nagoya.....	149,756
Kanazawa.....	96,639
Hiroshima.....	84,094
Yokohama.....	115,012
Tokushima.....	59,857
Wakayama.....	56,495
Sendai.....	71,517
Toyama.....	51,914
Kagoshima.....	49,858
Fukuoka.....	50,442
Sakai.....	43,836
Niigata.....	44,470
Kumamoto.....	47,602
Hyogo & Kobe.....	103,969
Fukui.....	39,182
Nagasaki.....	40,187
Hakodate.....	47,110
Shizuoku.....	35,699

Takamatsu.....	38,361
Okayama.....	41,967
Morioka.....	32,646
Shimonoseki.....	33,725
Matsue.....	35,687
Kochi.....	32,680
Okinawa.....	31,112
Matsuyama.....	31,057
Akita.....	30,343

The population was divided among the various classes as follows: Imperial family, 38; kwazoku, or nobles, 3,816; shizoku, or knights (formerly retainers of the daimos), 1,954,669; common people, 37,111,260. The number of foreigners was 7,560, of which 4,209 were Chinese, 1,421 English, 711 Americans, 467 Germans, 267 French. The number of Japanese residents abroad in 1886 was 11,580.

There are four principal islands named above, and a large number of very small islands—the whole number being estimated as high as 4,223.

EMPEROR AND ROYAL FAMILY.—The present Mikado (1891) is *Mutsuhito*, born at Kioto, November 3, 1852. He succeeded his father, Kōmei Tenno, Feb. 13, 1867. He was married, Feb. 9, 1869, to Princess Haruko, born May 28, 1850, daughter of Prince Ichijo. *Offspring*.—Prince Yoshihito, born Aug. 31, 1877; Princess Masa, born Sept. 30, 1880. The Prince was installed "Crown Prince" Nov. 6, 1889.

By the Imperial House Law of February 11, 1889, the succession to the throne has been definitely fixed upon the male descendants. In case of failure of direct descendants, the throne devolves upon the nearest Prince and his descendants. The civil list for 1889-90 amounts to 3,000,000 yen—the gold yen being about equal to an American gold dollar.

GOVERNMENT.—The system of government which had long been that of an absolute monarchy, has been greatly modified by a constitution promulgated Feb. 11, 1889. By the provisions of this new constitution the emperor is the head of the empire, combining in himself the rights of sovereignty, and exercising the whole of the *executive powers* with the advice and assistance of the cabinet ministers, who are responsible to him, and are appointed by himself. There is also a privy council, who deliberate upon important matters of state when they have been consulted by the emperor. The emperor can declare war, make peace, and conclude treaties. The emperor exercises the legislative power with the consent of the imperial parliament. It is the prerogative of the emperor to give sanction to laws, to convoke the imperial parliament, to open, close, and prorogue it, and to dissolve the house of representatives.

The imperial parliament consists of two houses, —a house of peers and a house of representatives. Every law requires the consent of the imperial parliament. Both houses may respectively initiate projects of law; can make representations to the government as to laws or upon any other subject, and may present addresses to the emperor.

The house of peers is composed of (1) male members of the imperial family of the age of 20 and upwards; (2) princes and marquises of the age of 25 and upwards (11 princes and 28 marquises); (3) counts, viscounts, and barons of the age of 25 and upwards, and who have been elected by the members of their respective orders, never to exceed one-fifth of each order (80 counts, 355 viscounts, 29 barons); (4) persons above the age of 30 years, who have been nominated members by the emperor for meritorious services to the state or for erudition; (5) persons who shall have been elected in each Fu and Ken from among and by the 15 male inhabitants thereof, of above the age of 30 years, paying therein the highest amount of direct nation-



al taxes on land, industry, or trade, and have been nominated by the emperor. The term of membership under (3) and (5) is seven years; under (1), (2), and (4) for life. The number of members under (4) and (5) not to exceed the number of other members. The entire membership of House of Peers is to be about 300.

The members of the House of Representatives number 300, a fixed number being returned from each election district. The proportion of the number of members to the population is about one member to 128,000. The qualifications of electors are (1) male Japanese subjects of not less than full 25 years of age; (2) fixed permanent and actual residence in the Fu or Ken for not less than a year; (3) payment of direct national taxes to the amount of not less than 15 yen for one year in the Fu or Ken, and in case of income tax for three years.

The qualifications of persons eligible for election are generally the same as those of electors, except that they must be of not less than 30 years, and need not have fixed residence in the Fu or Ken. The term of membership is four years.

Disqualified for members of the House of Representatives are officials of the imperial household, judges, auditors, officials connected with the collection of taxes, police officials, officials of electoral districts within their own districts, military and naval officers, and priests or ministers of religion. The president and vice-president of the House of Peers are nominated by the emperor from among the members, and president and vice-president of the House of Representatives are nominated by the emperor from among three candidates elected by the house. The presidents of both houses receive annual salary of 4,000 yen; vice-presidents, 2,000 yen; elected and nominated members of the House of Peers and members of the House of Representatives, 800 yen, besides traveling expenses. No one is allowed to decline these annual allowances.

The Imperial Parliament has control over the finances and the administration of justice. Voting is by secret ballot, and the system is that of *scrutin de liste*. The Parliament must be assembled once every year. The first general election for members was held in July, 1890. The first session was opened with elaborate ceremonies Nov. 29, 1890.

At the head of local administration in the provinces are the governors, one of them residing in each of the 46 districts (3 Fuses and 43 Kens) into which Japan is divided. In 1879 city and prefectural assemblies were created, based on the principle of election; their power is confined to fixing the estimates of the local rates, subject to the confirmation of the governors, and finally of the minister of the interior. Eligible to the assembly are all male citizens 25 years of age, resident in the district at least three consecutive years, and paying land tax of more than ten yen annually. The franchise is conferred on all male citizens of 20 years, residing in the district, and paying more than five yen land tax. Annually, or in every other year, governors are summoned to the department of the interior to deliberate upon matters of local administration. Each district is subdivided into cities (*ku*), and counties (*gun*), each with its chief magistrate (*chō*), who manage local affairs. The island of Hokkaidō (Yezo) has a governor and a special organization.

To further carry out the principle of decentralization and self-government a system of local administration in *shi* (municipality), *cho* (town), and *son* (village) was established by imperial rescript. April 17, 1888, which came into effect April 1,

1889, and is to be applied gradually, according to the circumstances and requirements of these localities.

ARMY AND NAVY.—The emperor has the supreme command of the army and navy. Since the restoration of imperial authority and the consequent abolition of the feudal system, the army of the empire has been organized on a uniform system on the basis of conscription. According to the present law all males of the age of 20 are liable to serve in the standing army for seven years, of which three must be spent in active service, and the remaining four in the army of reserve. After quitting the army of reserve they have to form part of the *landwehr* for another five years; and every male from 17 to 40 years of age, who is not either in the line, the reserve, or the *landwehr*, must belong to the *landsturm*, and is liable to be called to service in times of national emergency.

The army, on Jan. 1, 1891, consisted of 60,455 men, on a peace footing. It may be increased in war to 245,311.

The navy numbered 31 vessels of which there were one iron-clad, 5 protected cruisers, and 26 "miscellaneous," with 22 torpedo boats.

TRADE, REVENUE, AND EXPENSES.—Under treaties the ports of Yedo (Tōkiō), Kanagawa (Yokohama), Hiogo, and Osaka (on the inland sea), Hakodate (in Yezo) Niigata, and Nagasaki, are open to trade. Of the total trade in 1888 about 36 per cent. was with the United Kingdom, 21 per cent. with the United States, 16 per cent. with China.

Estimated public revenue, 1889-90 .....	£11,606,240
Estimated public expenditure, 1889-90 .....	11,606,502
Total debt, Jan. 1889 .....	60,452,450
Total imports, 1888 .....	11,395,358
Total exports, 1888 .....	10,067,206

There were in May, 1890, open 1,079 miles of railway, and several lines in process of construction. The progress in education, as well as in commercial and in individual pursuits during the last few years, has been marvellous both in respect of rapidity and methods.

JAPAN, GREAT EARTHQUAKE IN. On Oct. 28, 1891, one of the severest earthquakes ever known in Japan occurred. Without any previous warning shocks were felt from Tokio to beyond Kobe, a distance of more than 500 miles. The damage done in Tokio and Yokohama was very slight and no lives were lost, but as the rumbling and roaring of the earthquake gradually passed these cities, it seemed to gather strength, and at Nagoya, Gifu and Ogaki the damage done was severe indeed.

The city of Nagoya, with a population of 165,000 and 40,000 houses, was almost totally destroyed. According to the police reports, it lost 2,007 in killed and 2,158 wounded, with a total destruction of 31,764 houses. Gifu, with a population of 28,000 and 7,000 houses, lost in killed more than 2,000 and about an equal number wounded, with the total destruction of more than one-half of the city; of the remaining half, the streets were so badly littered with the débris caused from above and below, that it is doubtful if the city can ever be rebuilt. Ogaki, with a population of 20,000, lost in killed 1,000 (estimated) and in wounded about an equal number, with the almost complete destruction of the city; in fact, only four streets are said to remain, the others being completely upheaved and filled with wreckage. The Imperial Arsenal, situated in Osaka, and the electric-light works were wrecked and the Naniwa Cotton Mills, employing 700 operatives, was destroyed, but fortunately only 23 lives were lost and 45 persons injured, the remainder of the workmen having gained the open

street before the buildings collapsed. Great damage was done to the railway and telegraph lines, an iron bridge over the Nagaragowa River being demolished.

Near Lake Biwa saline water was forced from the earth, and rose to height of several feet; but the flow soon ceased from these cracks. Immediately following the convulsion the water in Owori Bay became greatly agitated, the waves rising to an unusual height and seeming to flow from all directions, causing the wreck of a great many junks and other vessels. The bay continued very rough for two days following the disturbance, and steamers usually plying on it remained at anchor rather than attempt to get out to sea.

Near Hamamotsu the railway sunk several inches for a space of more than five miles, and at Maizaka it settled down more than twelve inches. The entire roadbed had to be relaid in a great many places, and none of the bridges were regarded as safe until the government engineers had inspected them. Much loss of life and property was experienced at all the small cities and villages lying in the path of the earthquake, but as yet no trustworthy returns have been received from them. It is thought that more than 10,000 lives were lost with fully double this number in wounded. The shock was the severest felt since 1854 and 1855. In 1854 the city of Simoda was destroyed, and the resulting tidal wave swept a Russian frigate from her anchorage a couple of miles over the land. In the earthquake of 1855 the city of Tokio suffered severely, a large part being destroyed and several thousand lives lost.

JASPER, the county-seat of Dubois county, Ind., situated on the Patoka River. Block-coal is mined here, and lumber, flour, carriages, and farm-implements are manufactured.

JASTROW, MARCUS MORDECAI, a Polish-American rabbi, born at Rogasen, Prussia, in 1829. After studying at Berlin and graduating at Halle, he became preacher and assistant rabbi at Warsaw in 1858. Being banished in 1862 he became rabbi at Mannheim, but was soon recalled to Warsaw, where he remained till 1864. In 1866 a German-Hebrew congregation called him to Philadelphia, Pa., where he has since acted as rabbi. He published *Die Lage der Juden in Polen; Vorläufer der Polnischen Revolution; Vier Jahrhunderte*, a history of the Jews of the second commonwealth, and a valuable *Hebrew-German Lexicon*.

JATAKA (literally 'relating to birth'), the name of a collection of legends, containing an account of the 550 previous births of Sākya Muni, or the Buddha. It forms a part of the *Suttapitaka* of Pali literature. These are of great importance as the earliest collection of popular stories.

JAVELIN, a short spear intended to be thrown by the hand. It was anciently used by horsemen and foot soldiers, and is a common weapon among modern savage tribes.

JAY, BLUE JAY, one of our most common and most noxious birds. It is in the habit of destroying the broods of other small birds, and commits depredations on the fruits and seeds of farms and gardens. Both the European and American jays are fully described in *Britannica*, Vol. XIII, pp. 610, 611.

JAY, JOHN, an American diplomatist, born in 1817. He was admitted to the New York bar in 1839, and in 1869 was sent as minister to Austria. He resigned in 1875, and in 1877 was chairman of the commission to investigate the system

of the New York custom-house. Mr. Jay is a member of various geographical and historical societies, and has published many speeches and pamphlets.

JAY, WILLIAM (1789-1858), an American jurist. In 1818 he was appointed to the bench of Westchester county, N. Y., and was re-appointed until 1843. He was active in anti-slavery and temperance movements. Among his published works are *Memoir on the Subject of a General Bible Society for the United States* (1815); *Life and Writings of John Jay* (1833); *Inquiry Into the Character and Tendency of the American Colonization and American Anti-Slavery Societies* (1834); *A View of the Action of the Federal Government in Behalf of Slavery* (1837); *The Condition of the Free People of Color in the United States* (1839); *War and Peace; the Evils of the First, With a Plan for Securing the Last* (1848); *Kossuth Excitement* (1852); and *Causes and Consequences of the Mexican War* (1849); besides many addresses and letters.

JEAFFERSON, JOHN CORDY, an English author, born at Framlingham, Suffolk, in 1831. Beginning the practice of law in 1859, he was employed in 1874 as one of the inspectors of records in various parts of England. He has published a long series of novels of which the most notable is *Not Dead Yet*, partly occasioned by the famous Tichborne case. Among his books bearing on the social history of England are *A Book About Doctors; A Book About Lawyers; A Book About the Clergy; A Book About the Table; Brides and Bridals; Annals of Orford; A Young Squire of the Seventeenth Century, Etc.* His books are chatty, full of anecdotes, and very entertaining.

JEBB, RICHARD CLAVERHOUSE, a distinguished Greek scholar, born at Dundee, Scotland, Aug. 27, 1841. He passed with marked distinction through St. Columba's College, Dublin, Charterhouse School, London, and Trinity College, Cambridge, graduating as senior classic in 1862. Soon after he was elected Fellow of his college, and took a prominent part in organizing the system of inter-collegiate classical lectures, and served as secretary of the newly founded Cambridge Philological Society. In 1869 he became public orator of the university, in 1872 classical examiner in the university of London, and tutor of his own college, in 1875 professor of Greek in the university of Glasgow, and in 1889 regius professor of Greek at Cambridge. He has received from the King of Greece the Gold Cross of the Order of the Savior, in recognition of his services in promoting the study of both classical and modern Greek. Amongst the most important of his works are *The Attic Orators, Modern Greece*, and a *Life of Richard Bentley*. Dr. Jebb has for some time past been engaged in editing the complete works of Sophocles.

JEFFERSON, a railroad junction and the county-seat of Greene county, Iowa, on Coon River, 50 miles northwest of Des Moines.

JEFFERSON, a dairying and farming town of Schoharie county, N. Y. It has manufactories of cabinet-wares and shoes.

JEFFERSON, a city, railroad centre and county-seat of Marion county, Tex., at the head of navigation on Big Cypress Bayou. It is a thriving manufacturing city, the largest of northeastern Texas, and the center of river commerce, exporting cattle, barreled beef, tallow, hides, wool, osage orange seed, and large quantities of cotton. Large beds of coal and iron are found in the vicinity. Population, 3,070.

JEFFERSON, a post-village, capital of Ashtabula county, Ohio, situated on the Franklin division of the Lake Shore Railroad, 13 miles south



of Lake Erie. It is surrounded by a rich grazing and dairy country.

JEFFERSON, a city and county-seat of Jefferson county, Wis., situated at the union of Crawford and Rock rivers. It is the seat of Jefferson Liberal Institute, and has manufactories of cream-brick.

JEFFERSON CITY, the capital of the state of Missouri, and the county-seat of Cole county, situated on the south bank of the Missouri River, 150 miles from its mouth—lat. 38° 36' N., long. 92° 9' W. It is 125 miles west of St. Louis, and 158 miles east-southeast of Kansas City. Jefferson City contains a state-house, a court-house, a state-prison, the Lincoln Institute, a female seminary, several banks and churches, and manufactories of farming-implements and wagons. Coal and limestone are found in the vicinity. Population in 1870, 4,420; in 1880, 5,271; in 1890, 6,732.

JEFFERSON, JOSEPH, an American actor, born in 1829. At the age of three he figured as the child in "Pizarro, or the death of Rolla," and in 1843 traveled through Texas and Mexico with a party of strolling players. He has since appeared in nearly every city of note in the United States, and in many of various other countries. He is best known through his performance as "Rip Van Winkle."

JEFFERSONIA, a genus of *Berberidaceæ*, containing two species, one American and one Chinese. *J. dyphylla*, popularly known as *twin-leaf*, is indigenous to the eastern interior of the United States. It has two-parted leaves, rising in a tuft from the roots, and white blossoms, appearing in April or May. The root is reputed to have tonic and emetic properties, and in some places the plant is called "rheumatism root." It was named in honor of *Thomas Jefferson*.

JEFFERSONVILLE, a city of Clark county, Ind., on the Ohio River, opposite Louisville, Ky., 5 miles above New Albany, and 108 miles south of Indianapolis. It contains several churches and banks, the Southern State prison, an arsenal, high-school, iron foundries, machine-shops, and manufactories of railroad-cars, steamboats, farm-implements, etc. Population in 1880, 9,357; in 1890, 11,274.

JEFFRIES, JOHN (1745-1819), an American physician. He began the practice of medicine in Boston, Mass., in 1769, and from 1771 to 1774 was surgeon of a British ship of the line at that port. In 1776 he went to Halifax, where Lord Howe made him surgeon-general of the British forces in Nova Scotia, and in 1780 he became surgeon-major to the forces in America. He resigned in less than a year, however, and went to London, where he practiced with marked success. In 1789 he returned to Boston, and gave a series of public lectures on anatomy. He published in 1786, *A Narrative of Two Aerial Voyages*, which he took while in London.

JELALPUR, a town of India, in the Punjab, on the River Jhylum, or Jhelum.

JENKINS, EDWARD, a British author, born in 1838. He was admitted to the bar in London in 1864, and practiced till 1873, when he entered politics. From 1874 to 1876 he was agent-general for Canada, and then became a member of parliament. Among his published works are *Ginx's Baby* (1870); *The Colonies and Imperial Unity* (1871); and *The Coolie* (1871).

JENKINS, THORNTON ALEXANDER, a United States naval officer, born in 1811. He entered the navy in 1828 as a midshipman; was made a lieutenant in 1839; was engaged in several important actions during the Mexican war; in 1852 became secretary of the light-house board; was promoted commander in 1855; was made captain in 1862; commo-

dore in 1866; and rear-admiral in 1870. He was retired in 1873, and at the Centennial exhibition at Philadelphia in 1876 had charge of the exhibit of the navy department. Admiral Jenkins wrote many reports for the government.

JENNER, SIR WILLIAM, an English physician, born at Chatham in 1815, and educated at University College, London, where he himself was professor from 1848 till 1879. He was appointed physician in ordinary to the Queen in 1862, and to the Prince of Wales in the following year; was made a baronet in 1868, and a K. C. B. in 1872; and was elected F. R. S. and president of the College of Physicians. His professional eminence is chiefly based upon his discovery of the symptoms which differentiate typhus from typhoid fever.

JEREMIAH. See *Britannica*, Vol. XIII, pp. 626-629.

JERKIN-HEAD, a form of roofing which is half-gable, half-hip. The gable generally goes as high as the ties of the couples, above which the roof is hipped off.

JERUSALEM CHERRY, the popular name of *Solanum Pseudo-capsicum*. It is cultivated as an ornamental house plant, grows only two or three feet high, and bears berries about the size of cherries. It is also called *Winter Cherry*.

JERROLD, WILLIAM BLANCHARD, an English author, born in London in 1826, died in 1884. After being educated partly in France, he became a journalist, and also produced many farces and comedies. In 1855 he attended the Paris exhibition as agent of the London "Daily News." In 1862 he wrote a series of articles on the "London poor" for the "Morning Post," and during the next year he went to Paris to examine its institutions for the poor, and some years later he visited Netherlands for the same purpose. Among his published writings are *At Home in Paris*; *Trip Through the Vineyards of Spain*; *The Cocaynes*; *London*, illustrated by Doré, and *Life of Napoleon III*.

JERSEY CITY, a city and county-seat of Hudson county, N. J., on the right or west bank of the Hudson River, opposite New York City, with which constant communication is maintained by five ferries. The streets are generally laid out at right angles, and are of good width, well paved, sewered, lighted with gas and electricity, and bordered by many handsome residences. The most prominent public buildings are the city-hall, court-house, and school-houses. Jersey City is the terminus of the Red Star line of steamships to Europe, and of a dozen railroads running in various directions. Immense quantities of iron, coal, produce, and general merchandise are brought to and shipped from this city. There are horse and electric railroads to Hoboken and various parts of the city itself. It contains upwards of 60 churches, a high-school, a normal-school, several banks, and many charitable and educational institutions. The city is supplied with water conveyed in pipes from the Passaic River by means of hydraulic works which are at Belleville, 6 miles distant. Jersey City has many and various manufacturing establishments, among which the more important are the works of the United States Watch Company, several extensive glass-works, crucible-works, steel-works, foundries, machine-shops, boiler-works, locomotive and railroad supply works, sugar refineries, zinc-works, breweries, planing-mills, potteries, manufactories of chemicals, jewelry, fireworks, lead pencils, candles, soap, hydrants, chains, rubber goods, castor and linseed oil, copper ware, oakum, chains and spikes, car springs, etc. The mines of Europe, as well as those of this country, obtain their crucibles from the works of Jersey City. Here are located large

stock-yards and an extensive *abattoir* where vast quantities of cattle and sheep are slaughtered for the New York markets. This city is governed by a mayor and board of aldermen, assisted by numerous executive boards. There is an efficient police force, and a well equipped fire department. Public education is directly controlled by a board of education, who elect a city superintendent. The site whereon Jersey City stands was formerly called Paulus Hook, but in 1820 was chartered "as the City of Jersey," and in 1838 as "Jersey City." Population in 1850, 6,856; in 1860, 29,226; in 1870, 82,546; in 1880, 120,722; in 1890, 163,987.

JERSEY SHORE, a post-borough of Lycoming county, Pa., 10 miles southwest of Williamsport, on the west branch of the Susquehanna. The region has fine scenery, is fertile and produces lumber and tobacco.

JERSEYVILLE, a city, railroad junction and county-seat of Jersey county, Ill., 50 miles north of St. Louis. It manufactures flour, plows, reapers, and carriages.

JESSEL, SIR GEORGE, an English jurist, born in London, of Jewish parents in 1824, died March 21, 1883. After studying at the University College, London, he was called to the bar at Lincoln's Inn in 1847, and in 1865 he became a queen's counsel. In 1871 he was appointed solicitor-general by Mr. Gladstone, knighted in 1872; made master of the rolls in 1873, and became the usual president of the court of appeals. He was the first Jew to hold a judicial office in England. In 1880 Jessel was made vice-chancellor of the University of London.

JESUITS IN NORTH AMERICA. On JESUITS in general, see *Britannica*, Vol. XIII, pp. 645-656. In 1611 the Jesuit Fathers Biard and Masse, accompanied the French expedition which laid the foundation of Acadia. Called upon by the original Recollet missionaries to take part in their labors in the then new colony of Quebec, the Jesuits settled in the valley of the St. Charles, near the confluence of that river with the Lairet, and there established the nursery of their order in America known as Notre-Dame des Anges, in 1625. When Quebec was captured by the English, four years later, the Jesuit mission was suspended and the fathers driven off. In 1632 when the French recaptured the St. Lawrence River, the Jesuits returned; opened schools, especially the College of Quebec, and sent out missionaries who went up the river in canoes. After many hardships and a travel of 900 miles by land and water, the missionaries found themselves in the Huron country, near the shores of Lake Huron. Here they founded mission schools, preached, farmed, and traded in furs with the French of Montreal and Quebec. But, alas! in 1649 the Iroquois conquered the Hurons, burnt their villages, devastated their corn-fields, took their women and children prisoners, and burnt and tomahawked the Jesuit fathers.

But the Jesuits did not give up the task of establishing missions among the Indians. In 1649 they had establishments at Montreal, Three Rivers, and Quebec, a missionary post on the island of Miscon, in the gulf of the St. Lawrence, another at Tadousac near the mouth of the Great Saguenay River; and also posts along the Algonquins on the Kennebec River, in Maine. Besides their activity as missionaries we find the Jesuits in North America taking part in many exploring expeditions. In 1671, when the Intendant Talon of New France, resolved to take possession of the large valley of the Ottawas, in the name of the king of France, the Jesuit Father Claude Allouez assisted him very materially, and took the chief part in the ceremonies incident to the great meeting of Indian tribes at Sainte-

Marie-du-Sant. In the following year the French under St. Simon and the Jesuit Father Albanel, re-discovered Hudson's Bay.

Talon also sent in the same year a Quebec merchant named Joliet, and the Jesuit Father Marquette west to discover "Cathay" and the "South Sea." After wintering at Machelimackinac, these two explorers advanced early the next spring into the valley of the Illinois River, passing by way of the Fox River and the Wisconsin into the Mississippi as far as its confluence with the Arkansas, they returned in the fall and wintered at St. Francis Xavier, a missionary station on the west of Lake Michigan. As La Salle descended the Mississippi to the gulf in 1681, we see that Marquette and Joliet preceded him by 8 years in discovering the "Father of Waters."

For the next hundred years the Jesuits continued their missionary, farming, teaching and exploring work with undiminished zeal and gratifying success, so that in 1720, when Charlevoix, a member of their society, visited Canada, he was prompted to congratulate his brethren warmly on their eminent services. But the English were at war with the French everywhere. So it came that Father Sebastian Rasle was shot down on the battle-field at Norridgewock, Maine, surrounded by his Indian neophytes; and when in 1769 the British conquered New France, the College of Quebec, after flourishing for nearly 150 years, received its first severe blow. But it was still further crippled in 1773, when Pope Clement XIV, suppressed the whole Jesuit order by a papal bull. Father Well, the last Jesuit survivor in Montreal, died in 1791; and Father Cazot, the last one in Quebec, passed away in 1800. After this the British government took all the Jesuit property in Canada, and turned the College of Quebec into barracks. It served as such until 1869, when England withdrew her troops from Canada. In 1880 the college building was torn down by order of the Provincial government. At present, the Jesuit property at Quebec, Three Rivers, Montreal and elsewhere, summing up thousands upon thousands of acres, is under litigation between the Dominion government and the Pope in Rome.

The work of the Jesuits begins in the United States, when it ends in New France. After the war of independence, Father John Carroll, an ardent Jesuit in Maryland, corresponded with the Holy See with a view to establishing a hierarchy in the United States. His scheme was accepted, and he himself was appointed and consecrated first bishop of Baltimore in 1790. The diocese of Baltimore remained for years the only Roman Catholic diocese in the United States, and embraced all the States and Territories of the Union. Carroll was the founder of Georgetown College, near Washington, in 1791, and he established a theological seminary in connection with this college, which in 1792, was merged in that of St. Mary's, Baltimore. In 1815 Georgetown College was chartered as a university by act of Congress, and in 1833 it was empowered by the Holy See to confer degrees in philosophy and theology. This university is at present the largest school under Jesuitic control in the Union, and withal one of the best in the land. One of its principal offshoots is the college of the Holy Cross, at Worcester, Mass.

In 1823 two Jesuits from Maryland traveled to Missouri and took 10 young Marylanders with them. At Florissant, a few miles north, northwest of St. Louis, Mo., they opened a school for Indian boys. In 1828 the Missouri Jesuits founded the St. Louis University, which was the first scholastic institution west of the Mississippi, and stands to-day high



on the roll of American schools. Similar schools were gradually established by the Missouri fathers in Cincinnati, O.; Louisville and Bardstown, Ky.; Grand Coteau, La.; Chicago, Ill.; Milwaukee, Wis.; Detroit, Mich., and Omaha, Neb. They have also auxiliary stations in all the important towns of the West.

In their efforts to convert and civilize the Indians, the Jesuits penetrated into the various Indian countries, beginning with the Pottowattomies in Kansas, ascending the Missouri to the Sioux encampment, and the Yellowstone to the Blackfeet. They labored among the Flatheads and the various other tribes of Indians west of the Rocky Mountains. One of them, Father De Smet, was on several occasions deputed by the United States Government to pacify the Indians, when they became violent by their unjust treatment at the hands of Indian agents or swindling traders. Father De Smet visited many of the tribes, and obtained from the government even the right of nominating agents for Catholic tribes.

During the revolutionary troubles in Europe in 1847-48, many Jesuits were driven from their colleges and sought refuge in America. The provinces of Maryland and Missouri, obtained large reinforcements from these refugees. A number of the latter went to California in 1854, and began there a mission and a school, the College of Santa Clara, near San Francisco. The mission has since spread into Oregon and New Mexico. Some French Jesuits took possession of St. Mary's College, Marion county, Ky., in 1833, and laid also the foundation of another college in Louisville Ky., in 1845. Early in 1846 they left the latter to take charge of St. John's College, N. Y., and also to establish a college for externs in New York City. About the same time a number of Jesuits went to New Orleans, where they opened a house, and took soon after also the flourishing college of Springhill, near Mobile, Ala. They have since added several stations throughout the Southwest.

The order of Jesuits was restored in 1814 by Pope Pius VII. After an absence of more than 40 years from Canada, the Jesuit fathers appeared once more on the banks of the St. Lawrence in 1839; and the old College of Quebec was soon replaced by St. Mary's College at Montreal, which stands unrivaled among the many flourishing institutions in Canada. In 1865 the Jesuits opened their beautiful church in Montreal, which is the counterpart of the Gesie, the mother temple of their society in Rome. In 1885 the college of St. Boniface, opposite Winnipeg, in Manitoba, was transferred to the Jesuits of the Dominion.

The preceding array of facts shows that the Jesuits of America represent a large percentage of the whole number of educational institutions, both in the United States and the Dominion of Canada. And we may add that their schools and colleges are generally crowded with students. Taking priests, scholastics, novices, and lay-brothers together, they number about 1,000 men. But the mental and moral influence on the large number of their pupils can scarcely be estimated. The recruits of their order are taken from the most gifted and promising native American youth. At Woodstock, Md., a central institute has been established in which young Jesuits are thoroughly instructed in philosophy, physical science, mathematics, and theology, with a view of preparing them for the priestly offices, and also for teaching all the higher branches of learning in the colleges and schools of their order.

JETTIES are pier-like structures of wood or stone and earth built on either side of a river's

mouth in order to contract its current and to cause it to scour away the mud and sand of the bar, thus deepening the channel. Many of the river-mouths along our great lakes have been converted into good ports by harbor-works embodying the jetty-system, but the most conspicuous examples of this kind of river engineering are Captain J. B. Eads' jetties at the mouth of the Mississippi River. For the details, see MISSISSIPPI, BRITANNICA, Vol. XVI, pp. 520, 521, and RIVER ENGINEERING, pp. 580, 581.

We add the following remarks: Eads built two jetties along the South Pass. The east jetty is 12,100 feet long, the west one is somewhat shorter. They consist mainly of willow-mattresses. The willows for these mattresses were obtained in large quantities from the "jump," a sub-delta 12 miles above the head of the passes. Willow rods  $2\frac{1}{2}$  inches thick at the butt and from 15 to 30 feet long were used, and the brushy tops left on them. Barges carried them to Port Eads, a town of small houses built just above the mouth of the South Pass on both banks of the latter. The mattresses were about 2 feet thick and many of them as much as 100 feet long. They were towed by a steam-tug to their places and were sunk there by placing rubblestones evenly upon them. These stones had to be brought down the Mississippi from quarries at Rosiclair, in Southern Illinois. Guide-piles marked out the course of each jetty. For the greater part of their length four courses of mattresses and stones were laid. Towards the seaward ends the works were protected by cribs of palmetto logs filled in with stone; and towards the landward end some portions were constructed of yellow pine sheet piling. But as the current tended to undermine the latter part of the work, it had to be protected by willow mattresses lowered between the rows of piles. Afterwards an "inner east jetty" was built to reinforce the landward end of the east jetty.

The west jetty is connected with the main land by a dam of willow mattresses 550 feet long and running at right angles with the main work. After both jetties were constructed, temporary wing-dams were built inside to hasten the erosive action of the current, and they served their purpose well. Three years after the jetties were laid, when all the work was well settled together, their tops were capped toward their seaward ends with huge blocks of concrete, and their sides were protected with a revetement of stone and gravel. The jetties are still slowly settling, and a slight shoaling to seaward is reported. But the entire pass is now all along at least 30 feet deep.

JEVONS, WILLIAM STANLEY, an English political economist, born at Liverpool in 1835, died in 1882. After being educated at the University College, London, he spent 5 years at Sydney, Australia, as an employé in the mint there. In 1866 he was appointed professor of logic, political economy, and mental philosophy at Owen's College, Manchester. In 1875 he became professor of political economy at University College, London. After 1881 he devoted himself entirely to literary work, but was accidentally drowned at Bexhill in 1882. His main published works are *A Serious Fall in the Price of Gold*, which treated of the economic results of the gold discoveries in California; *The Coal Question*, speaking of the future exhaustion of the British coal mines; *A Theory of Political Economy*; *The State in Relation to Labor*; a treatise on *Money*, and the *Principles of Science*.

JEW FISH, one of the several different fishes of the family *Serranidae*. The jew-fish of the southern and eastern coasts of the United States is

the *Promicrops guasa*, which sometimes attains a weight of 700 pounds; that of California is *Stereolepsis gigas*.

**JEWSBURY, MARIA JANE** (c 1800-1833), an English writer, born in Warwickshire about 1800, and resided in Manchester during the greater part of her life. In 1833 she married Rev. William Fletcher, a missionary to India, and died at Bombay in the same year. Author of *Phantasmagoria, Letters to the Young, Lays of Leisure Hours, and Three Histories*.

**JEW'S EAR**, a fungus, one of the Hymenomyces, which grows on decaying parts of living trees, and bears some resemblance to a human ear. It is soft but cartilaginous, wrinkled, generally brown, and stemless. The spores are produced on the upper surface. See *Britannica*, Vol. XVIII, p. 267.

**JIB-BOOM**, an extension of the bowsprit towards the front, running out beyond it. It gives greater spread for jib-sails, and a more extended base for the top-gallant-mast-stay. In large vessels, a flying jib-boom is run out in a similar manner beyond the jib-boom.

**JIMENA, or XIMENA**, a town of Spain, twenty-one miles north of Gibraltar. It has some remarkable caves and the remains of a Moorish castle. Population, 8,500.

**JINN**, in Mohammedan mythology, spirits made of fire, and capable of assuming any form at will. They inhabit a world called Jinnistan, but often visit the earth, and exert an influence over mankind for both good and evil. In the *Arabian Nights' Entertainments* they are called genii. The word in this form is sometimes regarded as singular, with a plural *jinns*.

**JOACHIM, JOSEPH**, a German violinist, born near Pressburg, in Hungary, in 1831. Already famous as a youthful prodigy, he went to Leipzig in 1843, to the Conservatoire founded by Mendelssohn, who saw his genius and encouraged him. He made his first visit to London in 1844, and has since made annual visits there. In 1869 he became the head of the newly developed Academy of Music at Berlin. Herr Joachim has written several works for his instrument and the orchestra, the chief being the Hungarian Concerto. In 1887 he visited Paris, and had an enthusiastic reception. In 1877 the University of Cambridge conferred on him the degree of Musical Doctor and the University of Oxford recently conferred upon him the honorary degree of D. C. L.

**JOB**, Book of. See *Britannica*, Vol. XIII, pp. 697-703.

**JOGUES, ISAAC** (1607-1646), a French missionary. He was ordained a Jesuit priest in 1636, and then went to Canada as a missionary to the Hurons and Chippewas. In 1642 he was captured by the Mohawks, but after over a year's confinement and torture escaped to the Dutch at Albany, N. Y. He then visited France, but returned shortly afterward, and in 1646 concluded a peace with the Mohawks. The same year, however, he was murdered by a member of that tribe. He wrote *Description of New Netherlands in 1642, a Notice of René Goupil, and a Journal*, all of which have been published.

**JOHN O'GROAT'S HOUSE**, the most northerly in Scotland, in Caithness, 13 $\frac{1}{4}$  miles west of Duncan's Bay Head, was, according to tradition, an octagonal building with eight doors and windows and an eight-sided table within, built by John O'Groat to prevent dissensions as to precedence among the eight different branches of his family.

**JOHN HOPKINS UNIVERSITY**. See COLLEGES in these Revisions and Additions.

**JOHNSON, OLIVER** (c 1799-1889), an American editor. He served an apprenticeship in the printing office of the Montpelier Vt., "Watchman," and in 1831 became editor of the "Christian Soldier," from 1865 to 1870 he managed the "Independent," and then accepted the editorship of the New York "Tribune," which post he resigned two years later, in order to take charge of the "Christian Union." He was active in the cause of anti-slavery, and was an organizer of the New England anti-slavery society in 1832. He was the author of *William Lloyd Garrison and His Times, or Sketches of the Anti-slavery Movement in America* (1880).

**JOHNSON, REVERDY** (1796-1876), an American statesman. He was admitted to the bar in 1815, and began practice in Prince George county, Md. In 1817 he removed to Baltimore, and in 1821 became a member of the state senate. He was appointed attorney-general in President Taylor's cabinet, and from 1845 to 1849 was in the United States Senate. In 1868 he went to England as minister, and while there negotiated the "Johnson-Clarendon" treaty for the settlement of the Alabama claims, besides settling several other important controversies. On his return to the United States in 1869 he resumed the practice of law, which he continued to within a few days of his death.

**JOHNSON, RICHARD MENTOR** (1781-1850), a vice-president of the United States. He was admitted to the Kentucky bar, and from 1804 to 1807 was in Congress as a Republican. He was reelected in 1807, and served, with the exception of a few months, until 1819. At the beginning of the war of 1812 he raised a battalion of three companies, and commanded it in active service for ten months. Shortly afterwards he raised a regiment of one thousand mounted volunteers, and was himself in command until the fall of 1813 when he was wounded several times in the battle of the Thames, and compelled to give up his post. From 1819 to 1829 he was a United States Senator, and then was again a member of the house till 1837, when he was chosen vice-president on the ticket with Martin Van Buren. He was afterward sent to the legislature, and was a member of that body at the time of his death.

**JOHNSON, SAMUEL** (1696-1772), an American educator. From 1716 to 1719 he was a tutor at Yale, and then was ordained pastor of the Congregational church in West Haven, but in 1722 was converted to episcopacy. He was assigned to a mission at Stratford, where he remained until his death, with the exception of the years from 1754 to 1763, when he was president of King's (now Columbia) college, New York. Among his works are *A System of Morality* (1746); *A Letter from a Minister of the Church of England to his Dissenting Parishioners* (1733); *A Second Letter* (1734); *A Third Letter* (1737); *A Demonstration of Reasonableness, Usefulness, and Great Duty of Prayer* (1760); and *An English and Hebrew Grammar* (1767), besides many pamphlets and sermons.

**JOHNSON, SAMUEL** (1822-1882), an American Unitarian minister. His first charge was the church in Harrison square, Dorchester in 1847, and from 1851 to 1870 he was pastor at Lynn, Mass. He lectured often upon anti-slavery topics. His most important published work is *Oriental Religions*, comprising *India* (1872), *China* (1877), and *Persia* (1885).

**JOHNSON, SIR JOHN** (1742-1830) Baronet, son of Sir William Johnson, born near Albany, N. Y., and during a visit to England in his youth knighted by George III, as a compliment to his father. He was made a major-general of militia in 1774, and when American independence was declared he went to



Canada, and returning at the head of troops raised there by himself took an active part in aid of the British in central New York. After the war he resided in Canada, where he was given large tracts of land by the British government.

JOHNSON, SIR WILLIAM, Baronet (1715-1774), a British soldier. He emigrated to America in 1738, and established himself on a tract of land on the south side of the Mohawk, a few miles west of Schenectady. He became a trusted friend of the Indians, and was appointed superintendent of Indian affairs in 1743. In 1750 he was appointed by the king a member of the governor's council, and in 1755 was created a baronet of Great Britain. During the French war he distinguished himself at Crown Point, Ticonderoga, and other places, and concluded several treaties with the Indians, among them the great treaty of Fort Stanwix in 1768. His extensive correspondence with the British and colonial governments is extremely valuable for a correct understanding of the early history of New York and of America in general.

JOHNSON, WILLIAM SAMUEL (1727-1819), an American jurist. He was admitted to the bar in 1746; and in 1761, and again in 1765, represented Stratford Conn., in the general assembly. In the latter year he was chosen a member of the first colonial congress that met to consider the Stamp Act, and in 1766 was sent to the upper house, or governor's council. In 1772 he became a judge of the superior court, but held office only a few months. From 1784 to 1787 he was a member of the Continental Congress, and in 1789 became the first United States Senator from Connecticut. From 1787 to 1800 he was president of Columbia College.

JOHNSTON, ALEXANDER (1849-1889), an American author. In 1876 he was admitted to the New Jersey bar, and then taught in the Rutgers college grammar school till 1879. He then became principal of the Norwalk Latin-school and from 1883 to the time of his death was professor of jurisprudence and political economy at Princeton. He published a *History of American Politics* (1879); *The Genesis of a New England State* (1884); *Representative American Orations, with an Outline of American Political History* (1885); *History of the United States for Schools* (1886), and *History of Connecticut* (1887).

JOHNSTON, JAMES F. W., a Scottish chemist, born at Paisley in 1796, died at Durham, Sept. 18, 1855. He studied at Glasgow University, and was afterwards the pupil of Berzelius, the chemist. In 1833 he was invited to take the leadership in chemistry and mineralogy in the newly-established university of Durham. It is as an agricultural chemist that he is chiefly known. His *Catechism of Agricultural Chemistry and Geology* has gone through more than fifty editions, and has been translated into almost every European language; and his *Lectures on Agricultural Chemistry and Geology* (1842; 13th ed. 1883) are held in high esteem. The last of his works, *Chemistry of Common Life* (1854) has passed through several editions.

JOHNSTON, JOSEPH EGLESTON (1809-1891), an American soldier. In 1829 he entered the artillery service, and served with distinction against the Seminole Indians, and in the war with Mexico. At the beginning of the civil war he had attained the rank of brigadier-general in the United States Army, but resigned and immediately became major-general in the Confederate Army. Later he commanded in all the peninsular battles, in Tennessee, and in Carolina, where he surrendered to Gen. W. T. Sheridan, April 26, 1865, after receiving intelligence of Gen. Lee's surrender. After the war Gen. Johnston became president of a railroad in Arkansas, and also of the National express company

in Virginia. Later President Cleveland appointed him commissioner of railroads of the United States. He wrote *Narrative of Military Operations* (1874).

JOHNSTOWN, a post-village, capital of Fulton county, N. Y., situated on the railroad four miles from Fonda, and on a branch of the Mohawk River. It has an academy, gas works, skin and leather dressing establishments, and glove and mitten factories.

JOHN THE PARRICIDE, commonly called John of Swabia, son of Rudolph II., and grandson of Rudolph I. of Austria, was born in 1289. After many attempts to induce his uncle, Albert I. of Austria, to resign to him some estates in Swabia, he formed a conspiracy with others and murdered Albert in 1308 and then fled to Italy, where he died. See *Britannica*, Vol. X, p. 493.

JOINTURE, a law term signifying that portion of an estate which is settled upon a woman before her marriage to be enjoyed by her after her husband's decease. The jointure bars a wife from her dower, if the deed of conveyance states that it shall take effect immediately upon the death of the husband; that it is for her own life; that it is made to herself and no other in trust for her; and that it shall be in full satisfaction of her dower, and not of any particular part of it.

JOINVILLE, FRANÇOIS FERDINAND PHILIPPE LOUIS MARIE D'ORLÉANS, PRINCE DE, a French soldier and author, born at Neuilly in 1818, being the third son of King Louis Philippe. In 1836 he became a lieutenant of the French navy, and in 1840 he commanded the frigate which brought the remains of Napoleon I. from St. Helena to France. In 1843 he married the daughter of Dom Pedro I., Emperor of Brazil. Being made rear-admiral in 1844 he commanded the fleet which bombarded Tangiers. His father being driven from the throne in 1848 Prince Joinville relinquished his command and went to England. Afterward he devoted himself to travel and study; came to America in 1861; and accompanied Gen. McClellan during his command of the Army of the Potomac. Since 1870 he has lived in retirement in France, and has published *L'Angleterre* and *La Campagne du Potomac*.

JOKAI, MAURIS, a Hungarian novelist, born at Komorn, Feb. 19, 1825. He qualified for an advocate, but never practiced, and after 1849 devoted himself exclusively to literary pursuits. Among the best of his works are *The Turks in Hungary* (1852); *The Magyar Nabob* (1853), and its continuation *Zoltan Kárpáthy* (1854); *The New Landlord* (1862); *The Romance of the Coming Century* (1873); *The Comedians of Life* (1876); *The White Woman of Lentschau* (1884); and *Timar's Two Worlds* (1888). Most of his novels have been translated into German, and several of them into English. Jokai has gained fame as a journalist, as editor first of the revolutionary weekly "Pictures of Life", then of the political daily "Fatherland", and lastly of the humorous weekly "The Comet" and the government organ "Nemzet". He is a prominent member of the House of Representatives, being one of the cleverest debaters of the party of the liberal government.

JOLIET, a city and county-seat of Will county, Ill., on Des Plaines River, 37 miles southwest of Chicago, 44 miles east-northeast of Ottawa, and 22 miles south-southwest of Anrora. It contains many handsome stone buildings, several churches, chapels, schools, banks, a Catholic academy, a convent, and a State prison. Joliet has extensive flour-mills, machine-shops, breweries, lime-kilns, brick-yards, foundries, manufactories of boots and shoes, cigar-factories, Bessemer steel-

works and rolling-mills, carriage-shops, marble-works, and manufactories of builders' hardware, cooperage, farming implements, stoves, sash doors, and blinds. At this place there are large quarries of excellent Silurian limestone, called Joliet limestone. Population in 1880, 11,657; in 1890, 27,407.

JOLIETTE, the county-seat of Joliette county, Quebec, Canada. It has excellent water-power, building-stone, a college, mechanics' institute, convent, and manufactories of castings, lumber and leather.

JOLLY-BOAT (Dutch, *jolle* a yawl), a small boat kept on board ship for the purpose of communicating with the shore. It is a broad, safe boat, rowed with four oars.

JOMARD, EDMÉ FRANÇOIS, a French geographer and archæologist, born at Versailles, Nov. 17, 1777, died at Paris, Sept. 22, 1862. He studied in the École Polytechnique, and accompanied the expedition to Egypt as a member of the scientific committee. After his return to Paris he devoted more than twenty years to the preparation of the celebrated work, *Description de l'Égypte*. He was one of the founders of the Geographical Society of Paris, and held a position in the geographical department of the Royal Library.

JONAH. See Britannica, Vol. XIII, pp. 736-737.

JONES, ANSON (1798-1858), a president of Texas. He began the practice of medicine in 1820 at Litchfield, Conn., and in 1833 settled in Brazoria county, Texas. During the war between Texas and Mexico he was a surgeon in the Texan army, and in 1837 was chosen to the Texan congress. From 1837 to 1839 he was minister to the United States Government, in 1840 President of the Senate, from 1841 to 1844 Secretary of State, and from 1845 to its annexation to the United States was president of Texas. His last years were devoted to agriculture.

JONES, CHARLES COLCOCK, Jr., an American lawyer and antiquarian. In 1856 he was admitted to the Savannah, Ga., bar, and was mayor in 1860-61. During the civil war he was a lieutenant-colonel in the Confederate army. He has since devoted much time to the history of Georgia and the antiquities of southern Indians. Among his published works are *Monumental Remains of Georgia* (1861); *Historical Sketch of the Chatham Artillery during the Confederate struggle for Independence* (1867); *Historical Sketch of Tomo-chi-chi, Mico of the Yamocraws* (1868); *Reminiscences of the Last Days of Gen. Henry Lee* (1870); *Antiquities of the Southern Indians* (1873); *Siege of Savannah in 1779* (1874); *Dead Towns of Georgia* (1878); *Hernando de Soto and his March through Georgia* (1880); *History of Georgia* (1883), and *Life, Labors, and Neglected Grave of Richard Henry Wilde* (1885).

JONES, HUGH BOLTON, an American artist, born in 1848. He studied in Baltimore, Md., and later in Europe, and in 1877 made a sketching tour in Brittany and Spain. Among his pictures are *Tangier*; *Return of the Cows*; *Brittany*; *October*; *On Herring Run*; *Baltimore*; *Summer on the Blue Ridge*; *The Poplars*; *The Wayside Pool*, and *The Ferry Inn*.

JONES, JAMES KRINBROUGH, a United States Senator, born in 1839. He was a Confederate soldier in the civil war; commenced the practice of law in 1873; and became a member of the Arkansas state senate the same year. He was chosen to the 47th Congress, and was reelected to the 48th and 49th. He was then elected to the United States senate, and took his seat in 1885. His term expired in 1891.

JONES, JOHN PERCIVAL, a United States Senator, born in 1830. In the early part of the California excitement he went to that State, and engaged in farming and mining in one of the inland counties,

which he subsequently represented in both houses of the state assembly. In 1867 he went to Nevada, and since then has been engaged in the development of the mineral resources of that State. In 1873 he was elected as a Republican to the United States Senate, and has been twice reelected. His term of service expired in 1891.

JONESBORO', a city and county-seat of Clayton county, Ga., 20 miles south of Atlanta. It has a large cotton trade and manufactures flour and furniture.

JONESBORO', a city and county-seat of Union county, Ill., celebrated for the fine fruit grown in the region. It has good building stone, a state insane asylum, mills and factories.

JONESBOROUGH, the county-seat of Washington county, Tenn., 100 miles northeast of Knoxville. It is the oldest town in the state, was the first capital, contains a female academy, and a normal institute.

JONESIA, a genus of trees of the natural order *Leguminosæ*, sub order *Cesalpinea*, having a two-leaved calyx, a funnel-shaped corolla, seven stamens, and a scimitar shaped pod. The leaves are abruptly pinnate. The asoca of Sanskrit poetry (*J. asoca*) is one of the loveliest trees in the east. Its orange and crimson flowers grow in graceful racemes. Indian poetry abounds in its praises.

JONESVILLE, a railroad junction of Hillsdale county, Mich. It has manufactories of carriages, cotton and woolen goods.

JONQUIL, the name given to a species of *Narcissus* with rush-like leaves, allied to the daffodil. The common Jonquil (*N. Jonquilla*) has from two to six yellow or white flowers at the summit of its scape. The sweet-scented Jonquil (*N. odoratus*) is very generally cultivated. Both species are indigenous to the South of Europe. Perfumed waters are made from the flowers.

JORDAN, DAVID STARR, an American naturalist, born in 1851. In 1870 he became instructor in botany at Cornell, in 1875 professor of biology at Butler university, and in 1879 at Indiana university. He has held many appointments as assistant to the United States fish and other commissions. Besides numerous papers on ichthyology, he has written a *Manual of the Vertebrates of the Northern United States* (1876).

JORDAN, MRS. DOROTHEA, DORA BLAND, an Irish actress, born near Waterford, about 1762, died at St. Cloud, France, July 3, 1816. She appeared first in Dublin, under the name of Miss Francis, and soon became popular in the roles of romps and boys. In 1782 she crossed the channel and obtained an engagement from Wilkinson, of the York circuit, with whom she acted for three years. It was during this period that she assumed the name of Mrs. Jordan. She made her debut at Drury Lane in "The Country Girl" in 1785, became at once very popular and retained her hold on the public for nearly thirty years. In 1790 commenced her connection with the Duke of Clarence, afterwards William IV., which continued until 1811. Notwithstanding her youthful follies there is no reason to doubt that she was faithful to him, and in return he was warmly attached to her. There was no satisfactory explanation of the sudden breaking-off of their relations, but it is supposed to have been for political reasons. She played in London and the provinces until 1814, when she retired to France, and though not in actual want, died their friendless and alone. In 1831 King William raised her eldest son to the peerage, as Earl of Münster, and gave the other Fitz-Clarences the rank and precedence of the younger sons and daughters of a marquis.



JORDAN, THOMAS, an American general, born in 1819. He entered the United States Infantry service in 1840, and served in the war against the Seminole Indians, and later in the war with Mexico. At the outbreak of the civil war he resigned his commission and entered the Confederate army as adjutant-general, becoming brigadier-general shortly afterward. In 1869 he became chief-of-staff to the revolutionary army in Cuba, and the same year succeeded to the chief command, but a little later resigned. He has since devoted himself to literature, and has written *The Campaigns of Lieut.-Gen. Forrest* (1868.)

JORDAN, a village in Anondaga county, N. Y., 17 miles west of Syracuse. It has good water-power, and among its manufactures are wheelbarrows, sleds, furnaces, wagons and flour.

JOUFFROY, D'ARBANS, CLAUDE, MARQUIS DE, a French mechanician, born in Francha-Comté about 1751, died at Paris in 1832. In early manhood he served in the army, and while in Provence studied the navigation of sailing vessels. The application of steam to navigation was suggested to him by the sight of a fire engine, and in 1783 he served in the army, and while in Provence succeeded in making a small paddle-wheel steamboat sail up the Rhone at Lyons. The vessel was, however, too defective to be available for purposes of actual navigation, and a patent was refused by the French government. Compelled by the Revolution to emigrate, he failed on account of financial ruin, to float a company till after Fulton had made his successful experiments on the Seine in 1803. In 1816, having obtained a patent, Jouffroy formed a company, and in the same year launched a steamer on the Seine, but he was unable to compete with other enterprises of the same kind.

JOUGS, JOUGS, or JOOGS, the name given in Scotland to a form of pillory which was used also in Holland and probably in other countries. The jogs were an iron ring or collar, fastened by a chain to a pillar or wall in some public place, such as a market-cross, a prison-door, a churchyard gate, etc. The ring or collar opened by a hinge, so as to enclose the culprit's neck, when it was secured by a loop or staple and a padlock. The jongs were employed as a punishment as well for ecclesiastical as for civil offenses. They may be traced as far back as the 16th century, and although they have not been in use for the last hundred years, they may still be found hanging at few country churches.

JOULE. JAMES PRESCOTT, an English physicist, born at Salford in 1818, died in 1889. Instructed in science by Dr. John Dalton, he became a chemical experimenter; and afterwards he discovered the law that all mechanical motion has its equivalent in heat, and *vice versa*. The final result of his experiments is expressed in this statement, known as "Joules Law:" "To raise the temperature of one pound of water one degree Fahr. requires as much heat as is produced when 772 pounds of metal or stone, etc., fall through a height of one foot, or one pound falls through a height of 772 feet." In other words: "The heat required for raising 1 pound of water 1° Fahr. is equal to 772 foot-pounds." Joule announced this law in 1878. With Sir William Thompson he prosecuted researches on the thermal effects of fluids in motion, and with Dr. L. Playfair on the varying volume of space occupied by the same body in the solid and in the liquid state. Joule's experiments demonstrated the doctrine of correlation of forces, and also that of the kinetic theory of gases. The universities of Dublin and Edinburg conferred upon him the degree of L. L. D. and the university of Oxford gave him the de-

gree of D. C. L. He also received many marks of honor from abroad; and in 1878 a civil-list pension of £200 was conferred upon him.

JOURNALISM is the art of making newspapers. For the history and development of newspapers in the Old and New World see *NEWSPAPER*, *Britannica*, Vol. XVII, pp. 412-437.

The newspaper is the product of skilled labor. For successful results this labor must be nicely divided and systematized. To the daily newspapers of our large cities more than one hundred intelligent minds and as many skilled hands contribute. The former may be located in widely separated parts of the world, even at the opposite ends of a diameter of the globe. Each contributor has his space to fill; and when all the contributions are fitted together, the whole must not contain any repetitions, and still less any contradictions. All must be harmonious.

Information considered desirable for publication is called "news." It is bought, sold, copy-righted, and traded in like stocks or grain. Its value is perishable. Only *news* has real value. It must therefore be obtained and published with promptness. The reporters and special correspondents furnish most of the daily items. The former satisfy the curiosity for local information, and the latter send news in from abroad. Since the curiosity for news developed faster than the literary taste and culture of the readers, the literary nicety of the newspaper was often sacrificed to the tendency for satisfying mere curiosity, and since the advertising columns furnish the financial backbone of the enterprise, every proprietor of a newspaper strives to outdo his competitor in obtaining the largest amount of advertising matter.

But of late newspaper readers want more than a dry statement of the daily occurrences accompanied with lists of advertisements. The majority clamors for graphic illustrations, and descriptive embellishments; for attractive, entertaining, and sometimes even sensational narratives; and above all for a fearless and unbiased presentation of the truth about all public measures and men in public life. No paper published to-day supplies all these demands. Charles A. Dana at first in the New York "Tribune" and afterwards in the New York "Sun", was the first to foster the demand for a higher literary standard, and did it with good effect. Many editors throughout the country followed his example; but some, with a tendency for "fine writing and cultured style," pitched their key too high and wrote far above the ideas and vocabulary of their constituency, so that their papers could not be sold in paying numbers. The ideas and the language of a newspaper must be before everything be within the grasp of its readers.

As to the *personnel* of a newspaper, there is first and foremost the "editor-in-chief" who directs the *political* policy of the journal. The editor-in-chief has a staff of sub-editors. These include the city editor, with his staff of reporters; the foreign editor; the telegraph editor; the commercial editor; the financial editor or Wall street reporter; the literary editor; all the special correspondents, paragraph writers, theatrical editors, sporting editors, art reviewers, the agricultural editor, live-stock reporter, and special essayists. The "city editor" is, after the chief-editor, the most important person of the editorial department. This applies particularly to papers in large cities, like New York, Boston, Chicago, etc., where only a man of keen judgment, prompt decision, and unusual energy can fill this office well. He and his reporters must have the faculty of seeing or finding out every oc-

currence worth telling, and of describing it with a lively interest.

The "reporter," who is on the lowest rung of the editorial ladder, begins his career without a salary, and is at first paid only for what he writes. After he has had two or three years' experience in gathering news and writing it up, first of unimportant meetings and small matters generally, the city editor assigns to him work of a higher plane, as of important gatherings, of startling murders, of new social movements, etc., and his future will depend on how quickly, completely, and spicily he writes them up and gets them into his paper next morning. If he fails in this his discharge and disgrace will follow; because his paper is bound to bring the first, most accurate, and most lively news every day, and he cannot allow it to "be beaten" by any other paper. If the reporter is slow and inefficient on important occasions, and loses an interesting piece of news for his paper, every one of the many thousand readers will constitute himself a censor and pass the verdict of inferiority, carelessness, and insufficiency upon the paper. This verdict means decline of circulation, shrinkage of advertising patronage, and, in consequence, a loss of money to the publisher, because the reader, after looking in vain for the details of the coveted news in his favorite journal, if he finds it more fully in a rival paper, is very apt to take in the future the paper that gives the most detailed news, even if it is colored with sensationalism and wrong-sided politics.

The various sub-editors are recruited from the ranks of the reporters. In a morning journal the "night-editor" puts the paper to press. He decides in what part of the paper this or that matter shall appear; in what type it shall be set and how much "display" shall be given to it. As there is usually twice as much matter collected daily as can be printed, the night editor also decides what matter shall be thrown away or kept for another issue. In making up a large paper, say, of 8, 10, 12, or more pages, he apportions the reading matter in a miniature folio page by page. At 9 p. m. he rings for the foreman of the composing room. The latter has by this time "cast up," or estimated, all the advertisements already in type or to be given out to the compositors. He can, therefore, state how many columns of advertisements he has. And the night editor thereupon casts up his paper, by calculating how many columns he requires for editorials, for foreign news, for Washington, State capital and city news; for domestic telegrams, for shipping, commercial, and financial news, and for emergencies. If he finds that the matter on hand is for one or two pages more than his paper will hold, some of the items are "boiled down" into shorter paragraphs, some portions are kept for another issue, and other ones are thrown into the waste basket. Telegrams are treated according to their internal value, no matter how much their procurement may have cost. The autocratic night editor does not hesitate to curtail the articles of every other editor or reporter, the city editor not excepted. Even the leading articles are sometimes contracted. Paragraphs written by reporters, if they do not contain some startling news, are very often thrown into the waste basket, in order to make room for other matter. No advertisements can be left out, because they have been paid for in advance. The question arises: "Shall the size of the journal be increased in order to make room for all the reading matter on hand? This question is for the proprietors to decide; the night editor has no authority over it.

When a reporter is assigned to write up some out-of-town disaster, as the wrecking of a railroad

train or a great conflagration in another city, this raises him to the grade of a "special correspondent." He gathers the facts with all the harrowing details as rapidly as possible, dashes them down on his pad, and hands page by page to a telegraph operator to be forwarded to the telegraph editor of his paper with the utmost dispatch. After five or six years' experience in the hunt for stray news the reporter is sent to the State capital while the legislature is in session. Here he begins the study of State politics. Not only in the hall of the Senate and Assembly, but especially in the committee rooms, the lobbies, and the corridors of the capitol, he has to pursue his unceasing quest for news. He finds that every one he meets here is a politician, and that politics is the most interesting news matter. He now makes numerous acquaintances, establishes friendly relations with the governor, the chairmen of committees, the officials of the capitol building, and a goodly number of political hod-carriers. He visits the party rallying-places, interviews the party leaders, and stuffs his mind and reports with all sorts of party ideas, not omitting the party fustian, bombast, and glittering generalities.

After working himself successfully through a few legislative sessions at the State capital, the reporter is sent to Washington while the United States Congress is in session. Here he is at the fountain-head of national politics. His political views now widen with the wider field of his studies. The United States capital interests him greatly, although its "magnificent distances" soon tire him. He hears and reports a great deal of very wise talk. The new members he finds talk too much in order to get into the Congressional Record. Nineteenths of all their talk he finds is for mere rhetorical effect or political reasons. He encounters political falsehood wherever he goes. If he does not stand like a moral rock, the avalanche of deceit, perfidy, falsity, and treachery which he encounters will swallow him up. But he sifts out the truth and sticks to it in his dispatches.

After a while a great event, as a war, may occur in Europe. Our reporter is sent there as a compliment to his worth. Most of our large papers have offices in Paris and London. At one of these points the news of the continent is gathered, digested, and cabled to America. Alert correspondents send the cream of the news in the London morning journals here in time to be printed in our morning papers of the same date. They can do this by taking advantage of the five hours difference of time in favor of this country. Our reporter is assigned to one of these European bureaus for the collection of news.

In the *personnel* of a large newspaper the "managing editor" is very often not the same person as the editor-in-chief. As general manager he selects the working force of the establishment and controls it. This gives him the greatest influence on the success or failure of the paper. He assigns the various sub-editors to their special posts, and sends the special correspondents to all parts of the world. He is therefore the main-spring in making the newspaper "pay." The work of the sub-editors is mostly mechanical and technical. Each of them reports and reviews the occurrences in his particular branch, as commerce, finance, theatres, livestock exhibitions, etc. Our reporter may be promoted to any one of the editorial chairs according as he develops a fitness for one or the other, and as vacancies in the staff occur.

The commercial value of news to the management of a daily journal may be learned from the following figures which give the percentages of in-



crease of copies sold on the occasions mentioned: Presidential elections 73 per cent.; State and municipal elections 35 per cent.; last days of a well-advertised walking match 20 per cent.; elections in "October States" in Presidential years 18 per cent.; great fires 9 per cent.; notable disasters, such as the wrecking of a passenger train, the sinking of a passenger steamer, etc., 9 per cent.; great crimes (excepting Presidential assassinations) 7 per cent., etc. We see from this that great crimes are not especially desirable news. The better class of newspapers will, therefore, not cater to depraved tastes by publishing narrations of such crimes more than is expected of them by the better class of their readers. We also see from the extras sold on the mornings after Presidential, State and municipal elections, that American readers are pre-eminently interested in politics. The sooner our rising journalist learns to know this fact in all its bearings the better it will be for him.

On the importance of writing attractive "advertisements" for the newspapers, see the article ADVERTISING in these Revisions and Additions.

In studying the art of making up newspapers we must not forget the publisher. He is the commercial factor of the enterprise. He procures the materials from which each day's issue of his paper is to be fashioned. These include white paper, ink, addressed wrappers, machine oil, etc., also the stereotype plates, cast from a matrix of *papier maché* paste and plaster of Paris. His printing presses are of the most improved patterns, using long rolls of paper, cutting, folding, gumming, and counting the number of papers printed. He procures safe steam boilers and powerful engines to do the work of the press-room expeditiously. Lately, the publishers provide also various machines for setting the ordinary type used in the news column.

JOWETT, BENJAMIN, an English classical scholar, born at Camberwell in 1817. After being educated at Oxford he became a tutor in 1842 and in the same year he was ordained as a clergyman. He served afterwards as an examiner of classical schools and for the Indian civil service. In 1855 he was appointed Regius professor of Greek, in 1870 master of Balliol College, and in 1886 vice-chancellor of the University. His most important published works are *Commentary on the Epistles of St. Paul to the Thessalonians, Galatians, and Romans; The Dialogues of Plato*, translated into English with analysis and introductions, and his translations of *Thucydides* and *Aristotle*. The degree of Hon. LL.D. was conferred on him by Cambridge in 1890.

JOY, CHARLES ARAD, an American chemist, born in 1823. In 1853 he became professor of chemistry in Union College, remaining there till 1857 when he accepted a similar position in Columbia. He retired in 1877 on account of failing health. For a time he was editor of the "Scientific American," and later of the "Journal of Applied Chemistry." Died 1891.

JUBÆA, a genus of palms of the same tribe as the cocoa-nut. *J. Spectabilis*, a native of Chili, is a palm 30 or 40 feet high, with a spreading crown of pinnate leaves. The Chilians cut off the crown and collect the sap, which, when boiled down to a syrup of the consistency of treacle, is an important article of the domestic economy of their country. See PALM SUGAR, Britannica, Vol. XXII, p. 628.

JUDD, SYLVESTER (1813-1853), an American Unitarian clergyman and author. In 1840 he became pastor of the church at Augusta, Me., and remained there until his death. Among other works he published *Margaret* (1845); *Philo* (1850), and *Richard Edney and the Governor's Family* (1850).

JUDGES, Book of. See Britannica, Vol. XIII, pp. 763-764.

JUDGMENT (By default), is a judgment rendered in consequence of the non-appearance of the defendant. It is against the defendant when he has failed to appear after being served with the writ; to plead, after being ruled so to do, or, in Pennsylvania and some other states, to file an affidavit of defence within the prescribed time, or, generally, to take any step in the cause incumbent on him.

JUJUY, the most northerly province of the Argentine Republic. It is a mountainous tract, bounded on the west and north by Bolivia, and has an area of about 27,000 square miles. Its minerals are rich, but not worked to any extent. The chief industries are agriculture and cattle-raising; sugar and wheat are the principal crops. The exports (mainly to Bolivia) consist of cattle, mules, fruit, chicha brandy, skins, gold-dust, and salt. Population 90,000. The capital, Jujuy, on the San Francisco River, has 6,000 inhabitants.

JULIA, the only child of the Roman Emperor Augustus, his daughter by his second wife, Scribonia, was born B. C. 39, died A. D. 14. See Britannica, Vol. I, p. 418; XVIII, p. 79; XXIII, p. 336.

JUNCEÆ, or JUNCACEÆ, a natural order of endogenous plants of which the common rush is the type. The species are about two hundred in number.

JUNCTION CITY, the capital of Davis county, Kan., finely situated between Smoky Hill and Republican rivers, at the junction of several railroads. Its manufactures are various and in a thriving condition, comprising, among other items, flour, furniture, etc. Population, in 1890, 4,477.

JUNE-BERRY (*Amelanchier Canadensis*), a shrub or small tree of North America, of the natural order *Rosacea*. The size of the tree differs greatly in the varieties, in some attaining a height of 39 feet, and in others not more than 3 or 4. It is covered in spring with abundant white flowers, and yields later a small berry-like fruit of a deep purple color and pleasant flavor. The June-berry is variously known in different localities as the shad-bush, service-berry, and mountain whortle-berry.

JÜNGFRAU ("The Maiden"), a peak of the Bernese Alps, surrounded by precipices and capped with perpetual snow. The summit was first reached in 1811; it is 13,671 feet high.

JUNGLE, a term adopted into the English language from Bengal (Sanskrit *jungala*, "desert") and employed to designate a dense overgrowth of vegetation, as the thickets in many parts of India, particularly in the unhealthy tract along the southern base of the Himalayas, and in the Sundarbans, at the mouth of the Ganges. The jungles are often impassable from the thick growth of underwood, tall grasses and climbing plants. The soil is generally swampy, and fever and other diseases abound. Beasts of prey and gigantic snakes may be found in great numbers in these thickets, and the flora and fauna are very peculiar.

JUNGLEY GAU (*Bos Sylhetanus*), a species of ox inhabiting Sylhet and other mountainous parts of the north-east of India. It is nearly allied to the common ox, and is easily domesticated.

JUNK, a Chinese vessel, often of large dimensions, which, although clumsy and incapable of much seamanship or speed, has proven seaworthy on voyages extending even to America and Europe. Junk is also a popular term for the salt meat supplied to vessels for long voyages.

JUNKER, WILHELM, an African traveler, born of German parents resident in Moscow in 1840, and studied medicine in Göttingen, Berlin, and Prague. Proceeding to Africa in 1874, in the first instance to

Tunis and Egypt, he in 1876-88 carefully explored the Makaraka country. After spending some time in Kabayendi itself, he made Khartoum the centre from which he traveled on various excursions. A friend of Gordon and of Stanley, Dr. Junker holds a high place among those who have thrown light on "Darkest Africa." His *Reisen in Africa* was translated by A. H. Keane in 1890.

JUNKIN, GEORGE (1790-1868), an American clergyman and educator. In 1819 he was made pastor of the Associate Reformed church at Milton, Pa., with the majority of whose members in 1822 he entered the Presbyterian church. In 1832 he became president of Lafayette college, which he had assisted in founding. From 1841 to 1844 he was president of Miami university, then again of Lafayette college, and from 1848 to 1861 of Washington College, Lexington, Va., but resigned at the beginning of the war and went to Philadelphia, where he resided until his death. He wrote *The Vindication* (1836); *Treatise on Justification* (1839); *Lectures on the Prophecies* (1844); *Political Fallacies* (1862); *Treatise on Sanctification* (1864); *Two Commissions* (1864), and *The Tabernacle* (1865).

JUPITER SERAPIS, TEMPLE OF, a temple at Pozzuoli (near Naples), whose ruins afford a remarkable instance of the changes which have taken place and are still taking place in the relative position of the land and water on the earth. Only three of the original forty-six pillars exist. They rise out of the water, the pavement of the temple being at present submerged; but they bear evidence that they were at one time submerged to half their height, which is 42 feet. The base of the pillars as high as 12 feet is quite smooth; for the next nine feet they are completely riddled with the burrows of a species of stone-boring mollusk, the *Lithophaga lithophaga* of conchologists, which still inhabits the Mediterranean waters. The water must have covered this portion of the pillars, and while the mollusks were busy, the lower 12 feet must have been protected from their ravages by being buried in mud. The changes of level have been so gradual that the pillars have not been moved from their original position.

JURY-MAST, a temporary spar used to replace a mast which has been lost or broken.

JUSHPORE, or JASHPORE, India, one of the seven tributary states of Chutia Nagpur. See Britannica, Vols. XIII, p. 594; V, p. 768.

JUS MARITA, a phrase used in Scotch law to denote the legal right accruing to a husband over his wife's property.

JUS RELICTÆ: in Scotch law, the right of a widow to share in the movable or personal property of her deceased husband.

JUSTE, THEODORE, a Belgian historian, born at Brussels in 1818, died in 1888. After finishing his education the minister of the interior employed him first, and soon afterward he became secretary of the board for public instruction. In 1858 he be-

came custodian of the royal museum of antiquities at Brussels, and in 1870 he was appointed professor of history in the military school. Juste published many valuable works on history, especially *Histoire de Belgique*; *Précis de l'histoire du moyen âge*; *La Révolution des Pays Bas sous Philippe II.*; *Histoire du Congrès national*, and *Les Fondateurs de la Monarchie belge*.

JUSTICE-GENERAL, LORD, the highest judge in Scotland, also called the Lord President of the Court of Session. For the legal system of Scotland, see Britannica, Vol. XXIII, p. 417.

JUSTICE'S CLERK, an officer, generally a solicitor, appointed by justices of the peace in England to assist them in their duties. He is, properly speaking, not a public officer, but in the nature of a servant of the justice.

JUTE, the fibre of several plants belonging to the family of Corchorus, has been largely imported into the United States for making gunny sacks and for other purposes. It comes mostly from Bengal. In order to encourage the cultivation of this fibre at home, the Department of Agriculture distributed in 1870 jute seed to the planters in the Gulf States. The results showed afterwards that the jute plant can be successfully grown wherever there is a hot damp climate and a moist soil of sandy clay or alluvial mould. While the crop in Bengal is about 1,500 pounds of jute per acre, it was in South Carolina from 2,000 to 3,500 pounds per acre. It grows luxuriantly in the damp bottoms of all our Gulf States. For preparing the fibre machines have been invented which do as much work with three persons as is done by one hundred and sixty Hindoos at hand labor. The jute culture is increasing gradually in our Southern States, especially in Louisiana. Where jute is grown the caterpillars so destructive to the cotton fields are driven away. The imported fibre cost from 8 to 12½ cents per pound, and our planters can raise it of a superior quality at four cents per pound. It is claimed that the jute culture yields a net profit of \$70 per acre, when the new machines are available for the preparation of the fibre. Jute is now very largely used for making coarse paper stock for the so-called manilla wrapping paper; it also enters largely into the manufacture of carpets, mats, and various low-priced fabrics. See Britannica, Vol. XIII, pp. 798-803.

JYNTEAH, or JAINTIA, a district of India, in the province of Assam. See JAINTIA HILLS, Britannica, Vol. XIII, p. 544, and KHATI and JAINTIA HILLS, Vol. XIV, p. 58.

JYNX, IYXX, or YUNX, a genus of birds including the wryneck or "snake bird." See Britannica, Vol. XXIV, p. 698. In Grecian mythology Jynx was the daughter of Pan, or of Pierus, transformed into a bird, and also the name of the bird given by Aphrodite to Jason by which he won the love of Medea.



## K

## KAOLIN—KAMEHAMEHA

KAOLIN, PORCELAIN-CLAY. See *Britannica*, Vol. XIV, pp. 1, 90, 651; XVI, p. 424; XIX, pp. 600, 633.

KABA-NAGY, a small town of Hungary, situated in a plain twenty miles southwest of Debreczin. Population, 6,600.

KAGOSHIMA, or KAGOSIMA, a town of Japan, situated on a large bay of the same name, at the south end of Kiu-siu Island. It has manufactories of pottery and porcelain, arms, and cotton. Population, 49,855. It was bombarded in 1863 by the English, who thus compelled the execution of the murderers of an English subject.

KAHNIS, KARL FRIEDRICH AUGUST, a German theologian, born at Greitz in 1814. After being educated at Halle, he became a *privat-docent* at Berlin in 1842 and professor-extraordinary at Breslau in 1844. Here he published *Lehre vom Heiligen Geist* and *Lehre vom Abendmahl*, which gained him a call to Leipzig as professor of theology in 1850. Among his other works are *Lutherische Dogmatik*; *Christenthum und Lutherthum*; *Die Deutsche Reformation und Christenthum und Philosophie*.

KALAKAUA, DAVID (1836-1891), a king of Hawaii. See HAWAII, in these Revisions and Additions.

KALAMAZOO, the capital of Kalamazoo county, Mich., a village, though it ranks as the sixth town in the State. It is surrounded by a rich farming region with which it carries on an active trade. Four lines of railway, intersecting at this point, afford excellent shipping facilities. It is largely engaged in the manufacture of plows, harrows, wind-mills, steel-springs, paper, and sash, doors, and blinds. The town is noted for its beautiful streets and public places, and for its excellent institutions. Kalamazoo is an important educational center. Population, 17,857. See *Britannica*, Vol. XIII, p. 826.

KALGUEV, or KOLGUEF, an island in the Arctic Ocean, belonging to the government of Archangel, Russia. Area 1,350 square miles. It is visited in summer by fowling on account of the multitude of eider-ducks, swans, and other sea-birds which breed there, and whose feathers and eggs are valuable. The only permanent inhabitants are a few Samoyedes.

KALISCH, DAVID, a German humorist of Jewish parentage, born at Breslau in 1820, died in Berlin in 1872. As a young man he was in Paris as correspondent of German newspapers. Returning to Germany in 1846 he became a contributor to the *Charivari*, a humorous paper published at Leipzig. But in 1848 he founded the *Kladderadatsch*, a similar paper, published at Berlin. He also published some humorous plays, such as *Hunderttausend Thaler*; *Peschke*; *Berlin, wie es weint und lacht*; *Einer von unsere Leut'*, etc.

KALISCH, MARCUS, a Jewish theologian, born at Treptow, Prussia, in 1828, died in 1885. After being educated both at the Berlin University and the Rabbinical College he became embroiled in the political troubles of 1848 and went to England, where he was secretary to the chief rabbi. Subsequently he wrote *A Historical and Critical Commentary on the Old Testament*; *Exodus*; *Genesis*; *Leviticus*; *The Prophecies of Balaam*; and *The Book of Jonah*. He also published a Hebrew grammar.

KALKASKA, the county-seat of Kalkaska county, Mich., 137 miles north of Grand Rapids. The region produces much lumber while the neighboring streams afford a large supply of brook trout.

KALM, PETER (1715-1779), a Swedish botanist. From 1748 to 1751 he was investigating the botany and natural history of North America for the Swedish government, and then became professor of natural history at Abo, Sweden. He published, besides other scientific works, *A Voyage to North America* (1753), which was an account of the soils and natural curiosities of this country.

KALMIA, a genus of North American plants of the natural order *Ericaceæ* consisting of beautiful, poisonous evergreen shrubs, mostly about two or three feet high, with red, pink, or white flowers, generally in corymbs. The flowers are delicate and beautiful, and the corolla is in the shape of a wide, shallow bell. There are four species, one of which, *K. latifolia*, the mountain laurel, was proposed by Darlington as the national emblem. It grows to the height of ten feet, and is one of the most widespread of American shrubs, being common on the Atlantic slope from Canada to Florida, and extending west to Ohio, Kentucky and Tennessee. In the mountains from Pennsylvania southward it forms dense thickets and often attains a height of 30 feet. The wood, which is very hard, is sometimes called "spoon-wood," as it was used by the Indians for making spoons. *K. angustifolia*, known as "sheep-laurel" and "lambkill," from the reputation it has for poisoning animals, is a common shrub from 1 to 3 feet high, growing on hillsides from Newfoundland to Michigan, south to Georgia. The flowers are two-thirds smaller than those of the preceding species. *K. glauca* (pale laurel) is a shrub about 1 foot high found in peat-bogs on mountains from Newfoundland to Pennsylvania, and across the continent to Alaska. *K. hirsuta*, a shrub 1 foot high, is found in pine-barren swamps from Virginia to Florida.

KALNOKY, COUNT GUSTAV SIEGMUND, an Austrian diplomatist, born at Lettowitz, Moravia, in 1832, served for a few years in the army, and in 1850 entered the diplomatic service. From 1860 to 1870 he was councillor of legation at the Austrian embassy in London, and in 1874 went as minister to Copenhagen, whence he was transferred in 1880 as ambassador to St. Petersburg. In the following year he was recalled to assume the important office of the joint Austro-Hungarian minister of foreign affairs, in succession to Baron Baymerle—a post which Count Kalnoky has since filled with much ability, pursuing the peace policy which is the foundation of the Central European Alliance.

KAMEHAMEHA I. (1753-1819), the conqueror and first King of the entire group of the Hawaiian Islands, better known as the Sandwich Islands. With the aid of some European vessels and firearms he subdued one chief and one island after the other until he became master of the whole group in 1809. He was very vigilant, crafty, and courageous. Among the many social reforms he introduced were the abolition of human sacrifices, the promotion of agriculture and commerce, the suppression

of the taboo system, and the introduction of skilled mechanics.

KAMEHAMEHA II., LIHOTIHO (1797-1825), son of the preceding, was born in Hawaii in 1797. He was intemperate and given to pleasure. After succeeding to the throne in 1819 he abolished idolatry, and prepared the way for the missionaries, who came from Boston in 1820 and soon taught the Hawaiian people to read and write, to cipher and sew. The King and Queen visited London in 1824, where both died of the measles in 1825.

KAMEHAMEHA III, KAVIKEAVULI (1814-1854), brother of the preceding, was born in 1814 and came to the throne in 1833. Though educated by the American missionaries, he was wild and dissipated in his youth, but in 1840 he granted his people a written constitution and a code of laws, and made considerable progress in educating and civilizing his subjects. In 1842 and 1843 the independence of the Hawaiian Kingdom was acknowledged by the United States and by the French and English governments. The King died childless at Honolulu in 1854.

KAMEHAMEHA IV, ALEXANDER LIHOLIHO (1834-1863), nephew of the preceding, was born in 1834. He was also educated by the American missionaries. After visiting the United States, England, and France, he succeeded to the throne in 1854. He was handsome, amiable, fond of sports and military parades, but when excited with wine he became passionate and reckless. Through his son he hoped to perpetuate his dynasty; but the child died when 5 years old. This loss grieved the King so badly that his health gave way. He died at Honolulu in 1863.

KAMEHAMEHA V, LOT (1830-1872), elder brother of the preceding. While his brother was King, he was commander-in-chief of the forces and minister of the interior. Although dissipated while young, he reformed when he succeeded to the throne in 1863. Thinking that the constitution was too democratic for the good of the people, he granted the present constitution and took the oath to support it. He was strong-minded, fearless, and firm, yet superstitious; generous and confiding toward some people, yet close, avaricious, and suspicious toward others. He was never married, and left no heir to the throne.

KAMELA, or KAMILA, an East Indian dye-stuff consisting of a reddish-brown powder which invests the capsules of the tree *Mallotus Philippinensis* (*Rottlera tinctoria*). It is extensively used for dyeing silk, to which it imparts a deep orange color. It is also used in medicine as a vermifuge.

KÄMPFER, ENGELBERT, a German botanist and traveler, born at Lemgo, in Lippe, Sept. 16, 1651, died Nov. 2, 1716. After studying medicine at Königsberg, he in 1663 accompanied a Swedish embassy to Persia, and during the following ten years traveled in India, Java, Siam, and Japan. He published *Amenitates Exoticæ* (1712), and after his death appeared his *History of Japan and Siam*. Most of his writings exist in manuscript in the British Museum.

KANE, JOHN KINTZING (1795-1858), an American jurist. In 1817 he began the practice of law in Philadelphia, Pa., and in 1823 was sent to the legislature. From 1828 to 1830 he was solicitor of Philadelphia, and in 1832 was appointed a commissioner of the French spoliation claims. In 1845 he was made attorney-general of Pennsylvania, and the following year United States judge for that district. From 1856 to his death he was president of the American philosophical society.

KANE, SIR ROBERT, an Irish chemist, born in Dublin in 1810, died Feb. 16, 1890. He was educated for the medical profession, in 1832 was received as

a member of the Royal Irish Academy, and in the same year projected the *Dublin Journal of Medical Science*. In 1840 he received the gold medal of the Royal Society of London for his researches into the coloring matter of lichens, and in 1847 the Cunningham gold medal of the Royal Irish Academy for his discoveries in chemistry. From 1834 to 1847 he was professor of natural philosophy to the Royal Dublin Society. In 1846 he originated the Museum of Industry in Ireland, was appointed the first director, and the same year received from the Lord-lieutenant the honor of knighthood. He was for a number of years president of the Queen's College, Cork, resigning this position, together with the directorship of the museum, in 1873. In 1876 he was elected president of the Royal Irish Academy. His chief books are *Elements of Chemistry* (1842), and *Industrial Resources of Ireland* (1844).

KANGAROO APPLE, a species of *Solanum*, with a somewhat shrubby, succulent stem, smooth pinnatifid or entire leaves, and lateral racemes of flowers; a native of Peru, New Zealand, Australia, and Tasmania. When perfectly ripe it is wholesome.

KANGAROO GRASS (*Anthistiria Australis*), the most esteemed fodder-grass of Australia, to which island-continent, however, it is not confined but stretches through Southern Asia and also through the whole of Africa. It affords abundant herbage. The genus is allied to *Andropogon*, and has clusters of flowers with an involucre. The awns are very long and twisted. Several species of *Anthistiria* occur variously dispersed from South Africa to Japan, deserving introduction and naturalization in countries of warm-temperate or tropical climates.

KANIZSA, OLD, a town of Hungary, on the Theiss, fifteen miles from Szegedin. Population about 4,000.

KANSAS CITY, Mo., the chief city in Western Missouri and the second city of importance and population in the State. It is situated on the western boundary of Jackson county, on the right bank of the Missouri River, near its confluence with the Kansas River. Kansas City is a very important railroad center, numerous trains going out and coming in daily at its Union depot, and the trains of several lines here cross the Missouri River on a great railroad bridge built by O. Chanute. The location of Kansas City in the midst of a region of great agriculture resources, and the nearness of iron, coal and lead mines, with the enterprising spirit of the citizens, account for the city's very rapid growth in size and wealth, and insure its future prosperity. Kansas City is doing a large business in grain, live-stock, agricultural implements, in the packing of pork and beef, in manufacturing railroad iron, flour, butterine, soap, furniture, ear wheels, bricks, cigars, beer, cooperage, boxes and machinery. It is the wholesale distributing point for the vast regions to the westward and southward, and the chief collecting point of the products from the same regions. The growth of this city has been so rapid that from a town of a few thousand inhabitants immediately after the civil war it has become a place containing 132,416 inhabitants, not including KANSAS CITY, KANS., its western suburb, which contains 38,170 inhabitants and fully shares its progressive spirit. See Britannica, Vol. XIII, p. 844.

KANSAS (or KAW) RIVER, formed by the union of Republican and Smoky Hill rivers about 10 miles west of Abilene, Kan., flows eastward and enters the Missouri River at the western boundary of the State of Missouri, about 1 mile above Kansas City. The main stream is about 300 miles in length, but is not very important for navigation. The valley



of the Kansas includes about a third of the surface of the state.

KANSAS, STATE OF. For general article on the State of KANSAS, see Britannica, Vol. XIII, pp. 842-844. The United States Census of 1890, reported the area as 81,700 square miles; population 1,425,096; capital, Topeka, with a population of 31,007. The following is a list of the other cities of the State which had a population of 8,000 or over in 1890: Arkansas City, 8,347; Atchison, 13,963; Fort Scott, 11,946; Kansas City, 38,316; Lawrence, 9,997; Wichita, 23,853.

The population and area in 1890 by counties were as follows:

Counties.	Area.	Population.	
		1890.	1880.
Allen.....	504	13,509	11,303
Anderson.....	576	14,203	9,057
Arapahoe.....			3
Atchison.....	423	26,758	26,668
Barber.....	1,134	7,973	2,661
Barton.....	900	13,172	10,318
Bourbon.....	639	28,575	19,591
Brown.....	576	20,319	12,817
Buffalo.....			191
Butler.....	1,428	24,055	18,586
Chase.....	750	8,233	6,081
Chautauqua.....	651	12,297	11,072
Cherokee.....	576	27,770	21,905
Cheyenne.....	1,020	4,401	37
Clark.....	975	2,357	163
Clay.....	660	16,146	12,320
Clond.....	720	19,295	15,343
Coffey.....	648	15,856	11,438
Comanche.....	795	2,549	872
Cowley.....	1,122	34,478	21,538
Crawford.....	592	30,286	16,851
Decatur.....	900	8,414	4,180
Dickinson.....	851	22,273	15,251
Doniphan.....	378	13,585	14,257
Douglas.....	469	23,961	21,760
Edwards.....	612	3,600	2,409
Elk.....	151	12,216	10,623
Ellis.....	625	7,942	6,179
Ellsworth.....	720	9,272	8,494
Finney.....	864	3,350	
Foote.....			411
Ford.....	1,040	5,308	3,122
Franklin.....	576	20,279	16,797
Garfield.....	432	881	
Geary.....	407	10,423	6,994
Gove.....	1,020	2,994	1,196
Graham.....	900	5,029	4,258
Grant.....	576	1,308	9
Gray.....	864	2,415	
Greeley.....	780	1,264	3
Greenwood.....	1,155	16,309	10,548
Hamilton.....	922	2,027	165
Harper.....	810	13,266	4,133
Harvey.....	540	17,601	11,451
Haskell.....	576	1,077	
Hodgeman.....	864	2,395	1,704
Jackson.....	658	14,626	10,718
Jefferson.....	568	16,620	15,363
Jewell.....	900	19,349	17,475
Johnson.....	480	17,385	16,853
Kansas.....			9
Kearny.....	864	1,571	159
Kingman.....	864	11,823	3,713
Kiowa.....	720	2,873	
Labette.....	649	27,586	22,735
Lane.....	720	2,060	601
Leavenworth.....	455	38,485	32,355
Lincoln.....	720	9,709	8,582
Linn.....	637	17,215	15,298
Logan.....	1,080	3,384	
Lyon.....	858	23,196	17,326
McPherson.....	900	21,614	17,143

Counties.	Area.	Population.	
		1890.	1880.
Marion.....	594	20,539	12,453
Marshall.....	900	23,912	16,236
Meade.....	975	2,542	296
Miami.....	588	19,614	17,802
Mitchell.....	720	15,037	14,911
Montgomery.....	648	23,104	18,213
Morris.....	684	11,381	9,265
Morton.....	729	724	
Nemaha.....	720	19,249	12,462
Neosho.....	576	18,561	15,121
Ness.....	1,080	4,944	3,722
Norton.....	900	10,617	6,998
Osage.....	720	25,062	19,642
Osborne.....	900	12,083	12,517
Ottawa.....	720	12,581	10,307
Pawnee.....	756	5,204	5,396
Phillips.....	900	13,661	12,014
Pottawatomie.....	848	17,722	16,350
Pratt.....	720	8,118	1,890
Rawlins.....	1,080	6,756	1,623
Reno.....	1,260	27,079	12,826
Republic.....	720	19,002	14,913
Rice.....	720	14,451	9,292
Riley.....	612	13,183	10,430
Rooks.....	900	8,018	8,112
Rush.....	720	5,204	5,490
Russell.....	900	7,333	7,351
Saline.....	720	17,442	13,808
Scott.....	720	1,262	43
Sedgwick.....	1,008	43,626	18,753
Sequoyah.....			568
Seward.....	648	1,503	5
Shawnee.....	558	40,172	29,093
Sheridan.....	900	3,733	1,567
Sherman.....	1,080	5,261	13
Smith.....	900	15,613	13,833
Stafford.....	792	8,520	4,755
Stanton.....	672	1,031	5
Stevens.....	728	1,418	12
Sumner.....	1,188	30,271	20,812
Thomas.....	1,080	5,538	161
Trego.....	900	2,535	2,535
Wabaunsee.....	804	11,720	8,756
Wallace.....	900	2,468	686
Washington.....	900	22,894	14,910
Wichita.....	720	1,827	14
Wilson.....	576	15,286	13,775
Woodson.....	504	9,621	6,535
Wyandotte.....	160	54,407	19,143

Population of Kansas by decades: In 1860, 107,206; 1870, 364,399; 1880, 996,096; 1890, 1,425,096.

That part of Kansas east of the 100th meridian was a part of the Louisiana purchase in 1803, and was embraced at different periods in Louisiana and Missouri territories. By the "Missouri Compromise" (Congressional Act, of 1820) in all the region north of latitude 36° 30' except such part as was included in the State of Missouri, slavery was forever prohibited. As one of the results of the war with Mexico, the United States territory was extended westward from the 100th meridian to the Pacific Ocean, and southward to 32° 30' north latitude. In May, 1854, Congress passed the Act organizing the territories of Kansas and Nebraska, and declaring that the Missouri Compromise should be inoperative and void with regard to them. During the ensuing five years many of the citizens of Eastern Kansas who were largely opposed to slavery resisted the introduction of slaves from Missouri and other southern states; and in some cases hostile conflicts arose between the opposing partisans and the general condition of society was one of turbulence and apprehension. Governors of the territory were frequently changed, and four successive

constitutions were voted upon by the people during the four years previous to October, 1859. The constitution finally adopted was that passed by the Wyandotte Convention July 5, 1850, and ratified Oct. 4, 1859. Kansas was admitted as a State, Jan. 29, 1861. The following is a complete list of the governors, both territorial and state:

## TERRITORIAL.

A. H. Reeder.....1854-55	Robert J. Walker.....1857-58
Wilson Shannon.....1855-56	James W. Denver.....1858
John W. Geary.....1856-57	Samuel Medary.....1858-59
Frederick P. Stanton, 1859-61.	

## STATE.

Charles Robinson.....1861	George T. Anthony....1877-79
Thomas Carney.....1861-65	John P. St. John.....1879-83
Samuel J. Crawford.....1865-69	George W. Glick.....1883-85
James M. Harvey.....1869-73	John A. Martin.....1885-89
Thomas A. Osborn.....1873-77	Lyman U. Humphrey...1889-91
Lyman U. Humphrey,* 1891-93.	

\*Term expires Jan. 11, 1893.

The Census Educational report of 1890 contains the following summaries for Kansas State: Public schools, 12,260; with 12,175 white teachers, and 85 colored teachers; also 399,322 white pupils, and 9,619 colored pupils. The gain of population during the decade was 43.27 per cent; the gain of enrollment in public schools, 62.24 per cent. There were reported 8,811 school-houses. There were also reported over 5,500 pupils in Catholic, near 3,000 in Lutheran, some in Mennonite, and a few in German Evangelical schools.

Kansas had in 1890, 5,542 acres in vineyards, with an average yield per acre of 2 tons, with a market value per ton of \$58; 8,294 tons of grapes were sold for table use, and 790 tons for wineries,—yielding 130,990 gallons, valued at 80 cents per gallon.

For numerous other items of interest relating to Kansas, see the numerous tables embraced in the article UNITED STATES, in these Revisions and Additions.

KAPP, FRIEDRICH (1824-1884), a German author. He practiced law in Hamm, Unna, and Frankfurt-on-the-Main, and from 1850 to 1870 in New York city. In 1867 he was made commissioner of emigration, and in 1871 became a member of the German Diet. He published *The Slave Question in the United States* (1854); *Life of the American General Friedrich Wilhelm von Steuben* (1858); *History of Slavery in the United States of America* (1858); *The Trading in Soldiers of the German Princes with America, 1775-'83* (1864); *A History of the German Migration into America* (1867); *On Immigration and the Commission of Emigration* (1870); *Life of the American General Johann Kalb* (1870), and *Frederick the Great and the United States* (1871).

KARAGUE, one of the large Central African states formed after the dissolution of the former empire of Kitwara. It was for many years peacefully and wisely governed by the late King Rumaika, who died in 1888 and was succeeded by his son. The present territory is bounded on the east by Lake Victoria Nyanza, on the north by the river Kagera (Tangurè), separating it from Uganda, and on the west by the upper course of the same river, separating it from Ruanda. Southwards Karagwe merges in the region between Lakes Victoria and Tanganyika—total area, about 6,000 square miles; population consists mainly of Bantu peasants, governed by Wa-Huma (Galla) chiefs. Warahanje, the capital, is on a terrace overlooking the Lake Raveru, Windermere. Near the capital the Arabs have founded the trading station of Kufro (Kafuro), where they take ivory, coffee, and other produce in exchange for salt, textiles, and European wares.

KARELIA, an old name for the southeast part of Finland, annexed to Russia by Peter the Great in 1721. The Karelians properly so called are a branch of the Finnic race, about 303,000 in number, who inhabit the eastern parts of Finland and the adjoining provinces of Russia.

KARR, JEAN BAPTISTE ALPHONSE, a French author, born at Paris in 1808. After being educated at the College Bourbon he became an instructor there. He wrote his personal love-romance under the title *Sous les Tilleuls*, which was succeeded by other romances entitled *Une heure trop tard*, and *Vendredi soir*. In 1839 Karr became chief editor of *Figaro*, and soon after issued *Les Guêpes*, a satirical review, which became very popular; and his fanciful romantic outpouring *Voyage autour de mon Jardin* (1845). For many years he practiced floriculture and horticulture at Nice. His miscellaneous writings have been gathered and a selection from them was published in 1877, called *L'Esprit d'Alphonse Karr*. He died in 1890.

KARSTEN, HERMANN, a German botanist and traveler, born at Stralsund, Prussia, in 1817. He spent the years 1843-47 and again 1848-56 in scientific journeys in Venezuela, Colombia, and Ecuador. On his return to Germany he was appointed professor of botany in the University of Berlin, and in 1868 he was called to a similar professorship in Vienna. After his resignation in 1872 he went to Switzerland and gave private lessons there. His published writings are *Die Vegetations-Organe der Palmen*; *Flora Colombiæ*; *Anatomie und Physiologie der Pflanzen*; *Chemismus der Pflanzenzelle*; *Zur Geschichte der Botanik*, and *Deutsche Flora, pharmaceutico-medicinische Botanik*, all exclusively on botany.

KARTTIKEYA, the Hindoo Mars, or god of war, a being represented by the Puranic legends as having sprung miraculously from Siva.

KASKASKIA, a post-village of Randolph county, Ill., on the right bank of the Kaskaskia River, about 7 miles from its mouth. It was settled by the French in 1673, and was the first capital of Illinois. It was once a large and important place, but has declined.

KASKASKIA, a river of Illinois, rising in the east center of the State, flowing southwest, and entering the Mississippi at Chester. Its length is nearly three hundred miles. On its right bank, a few miles from the mouth, is the village of Kaskaskia, which was the first capital of Illinois Territory.

KATAHDIN, the highest mountain of Maine. Its summit is 5,385 feet above the sea.

KATKOFF, MICHAEL NIKIFOROVITCH, a Russian politician and journalist, born at Moscow in 1818, died at Snamensky, Aug. 1, 1887. He studied at the University of Moscow, Königsberg, and Berlin, and for some time filled the chair of philosophy at Moscow. In 1861 he became editor of the *Moscow Gazette*, the organ of the university, and eventually made it the most influential journal in Russia. At first an advocate of parliamentary government and reform, Katkoff was converted by the Polish rising of 1863 into a leader of the Pan Slavist movement, and a supporter of reactionary government in Russia. He acquired much influence in the government, and is said to have been mainly instrumental in determining Alexander III. to his conservative and reactionary policy.

KATTIMUNDŌO, or CATTIMANDŌO, a substance somewhat resembling gutta-percha. It is the milky juice of the East Indian plant, *Euphorbia cattimandoo*, used in India as a cement. See *Britannica*, Vol. II, p. 339.

KATYDID, a name applied to numerous American insects nearly related to grasshoppers, which





























PLEASE DO NOT REMOVE  
CARDS OR SLIPS FROM THIS POCKET

---

UNIVERSITY OF TORONTO LIBRARY

---

AE                    The encyclopaedia britannica  
5                     9th ed.  
E363  
1892  
v.13

For use in  
the Library  
ONLY

Roberts



