

# RETURN OF THE BUNNY SUICIDES

'WATERSHIP DOWN FOR THE DEEPLY SICK.' RICHARD CURTIS

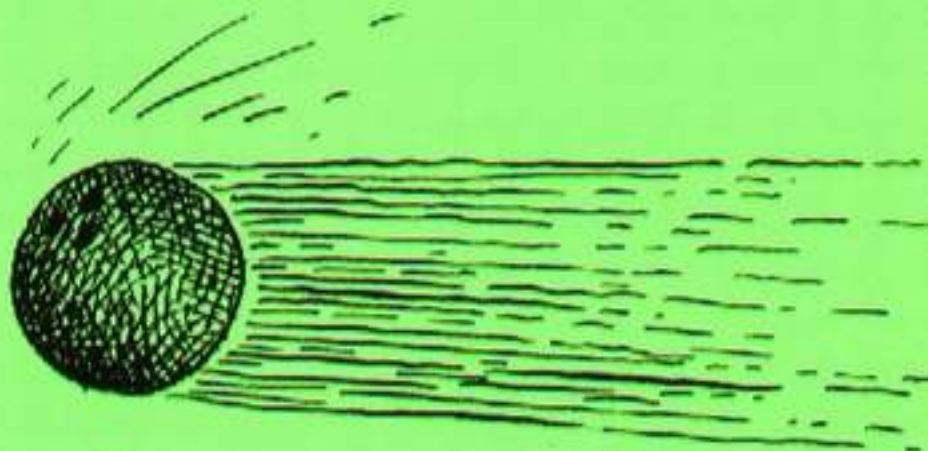
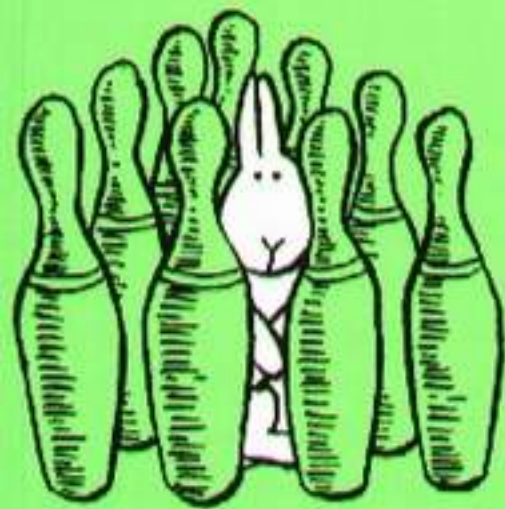

## ANDY RILEY

# RETURN OF THE BUNNY SUICIDES

ANDY RILEY



Hodder & Stoughton

# RETURN OF THE BUNNY SUICIDES



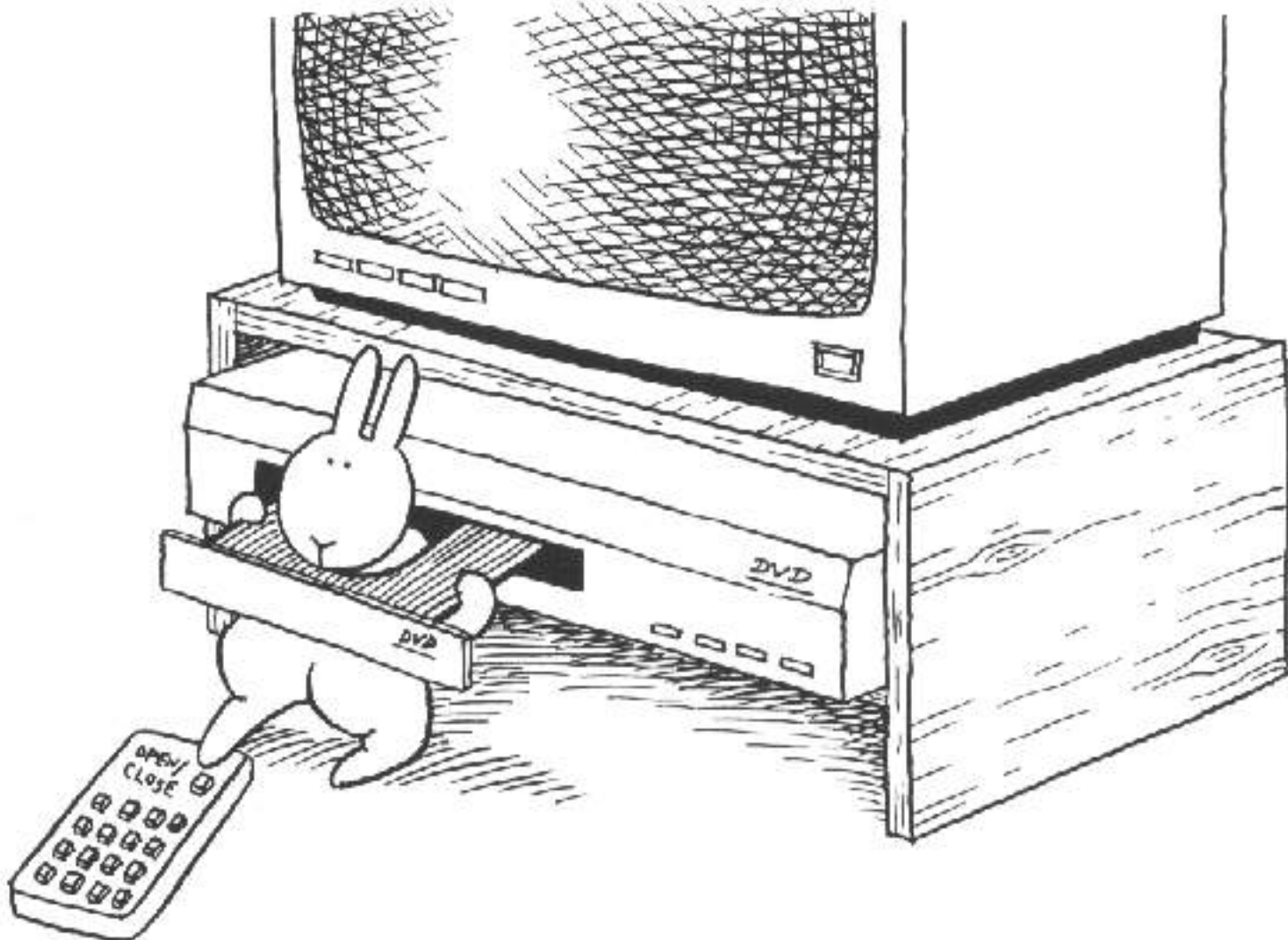

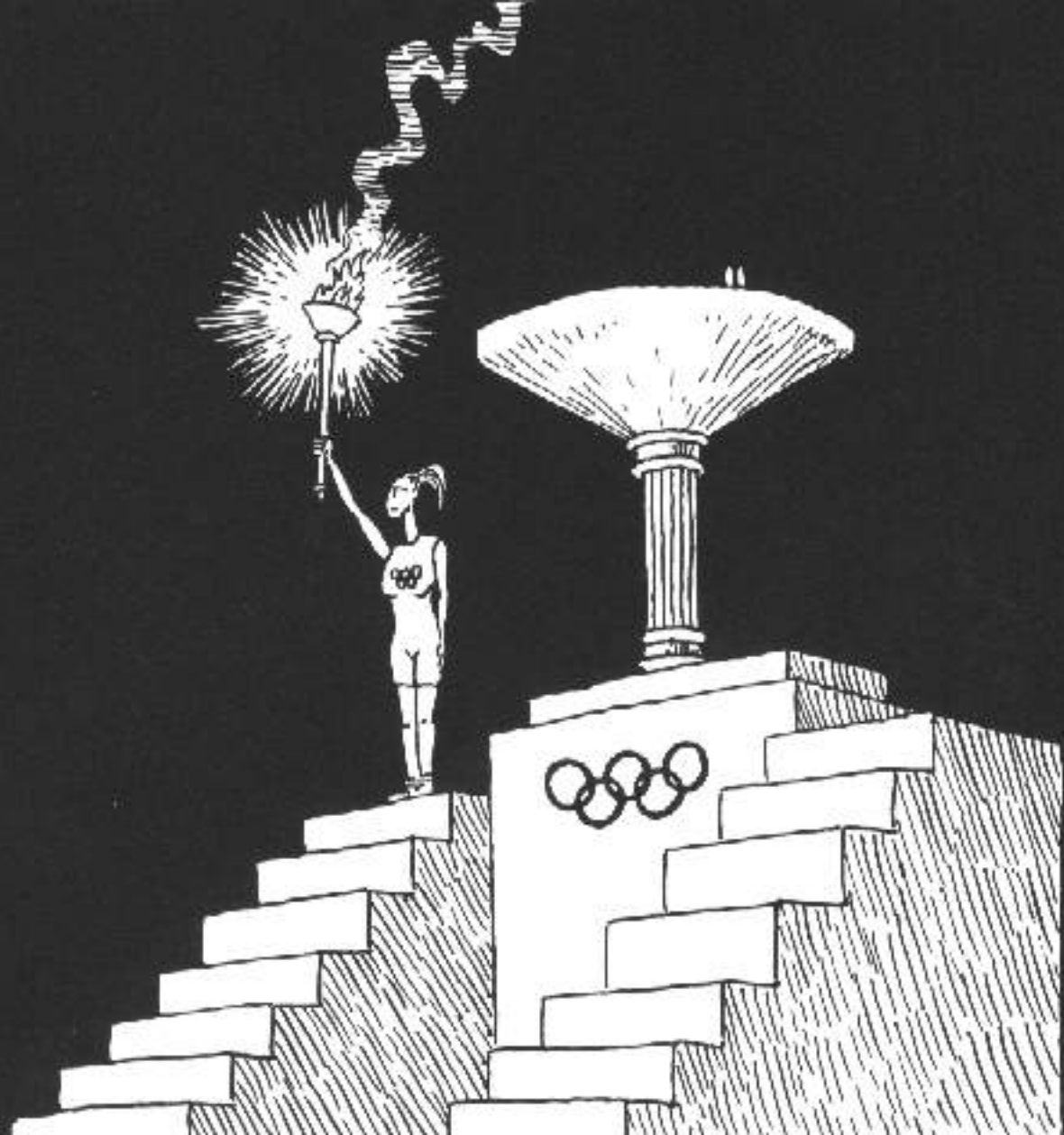

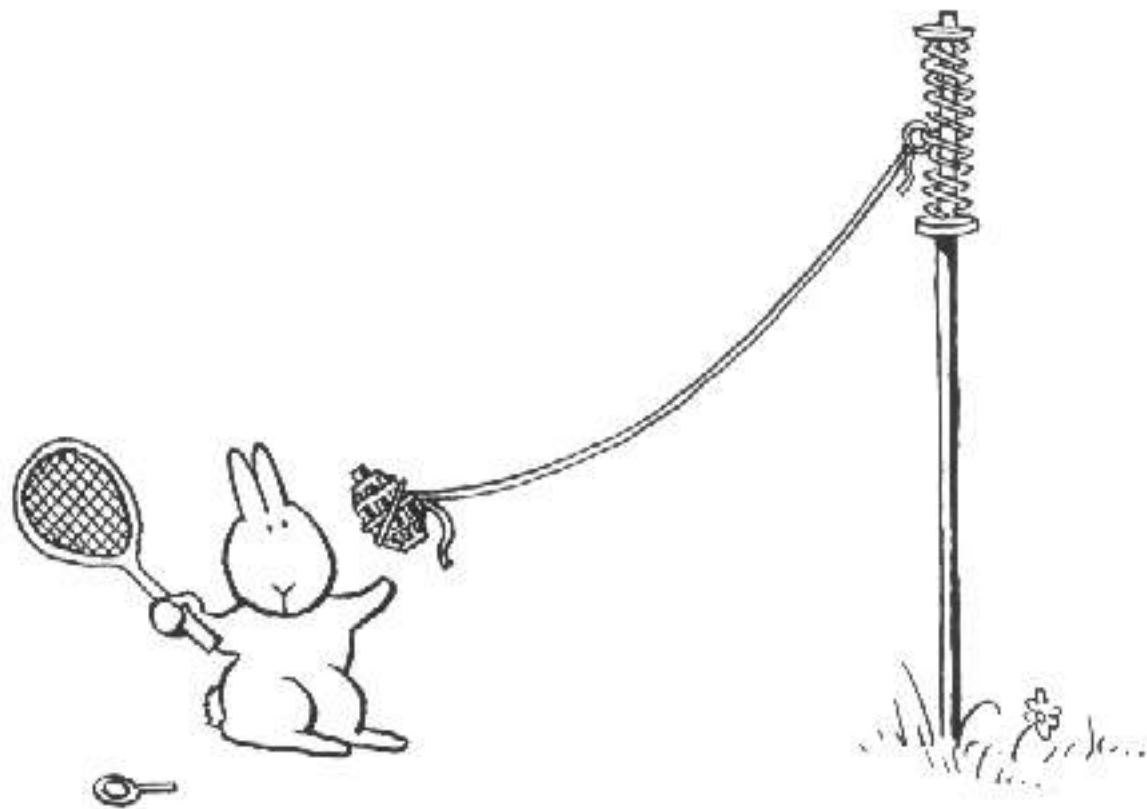



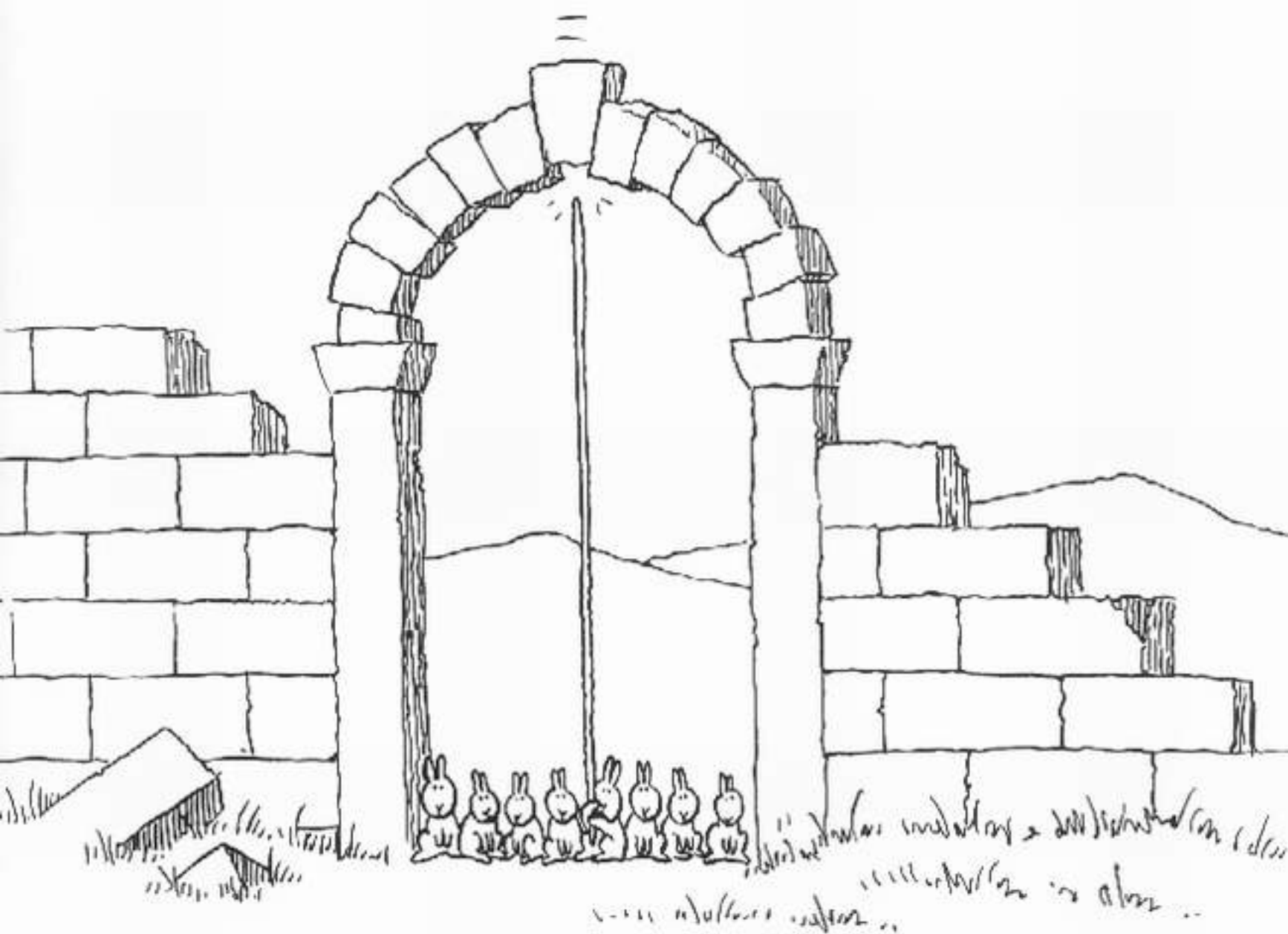





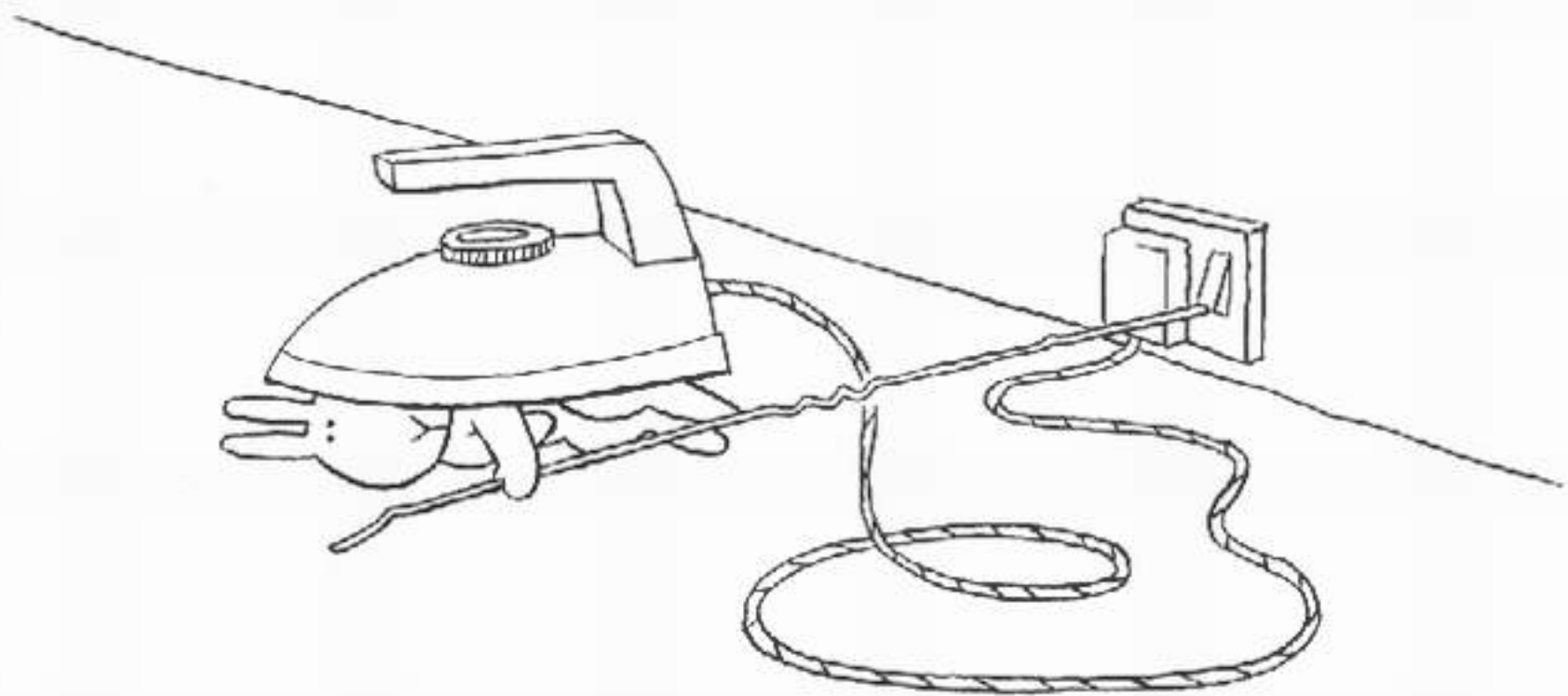

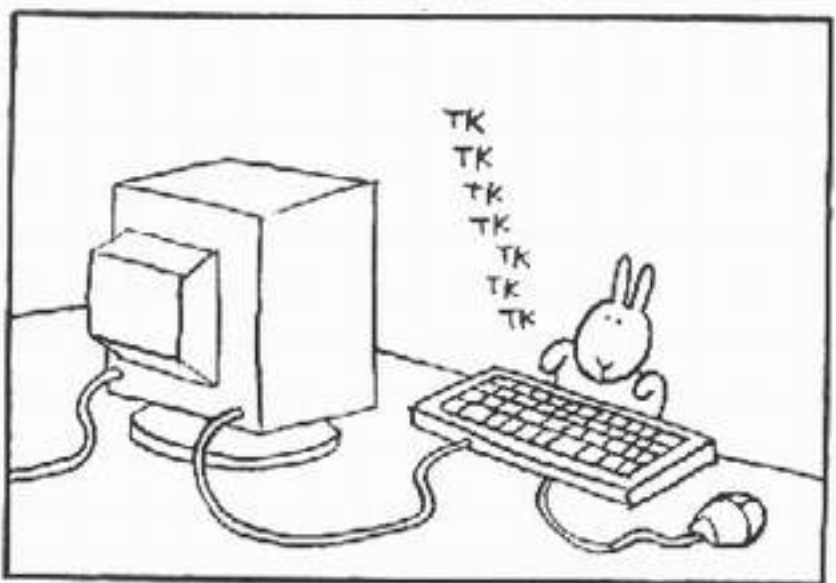
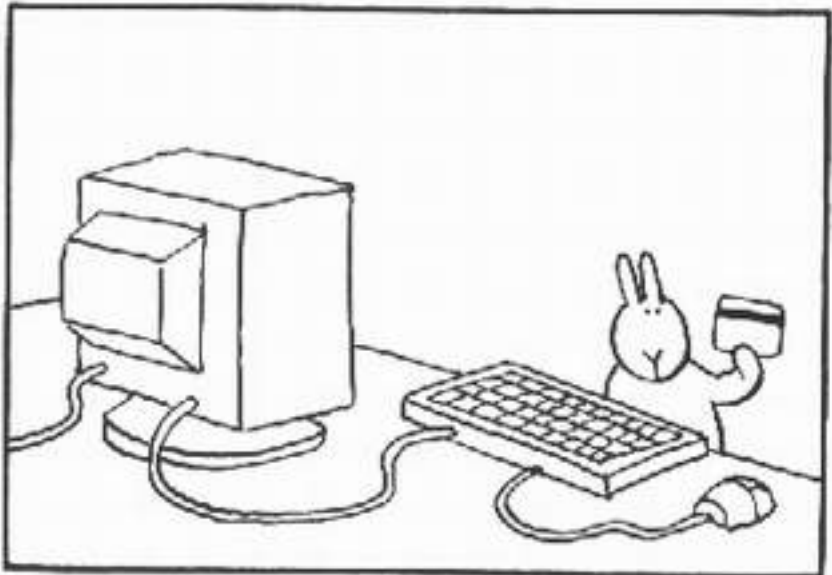
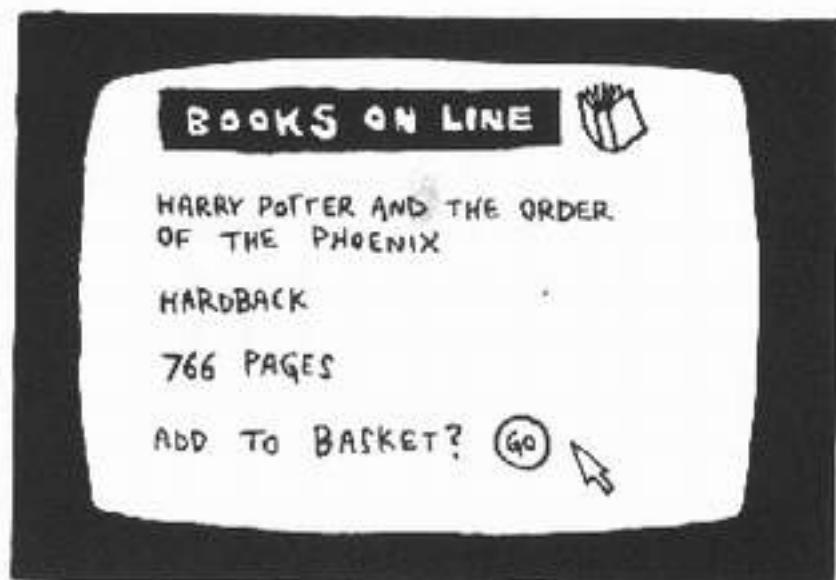
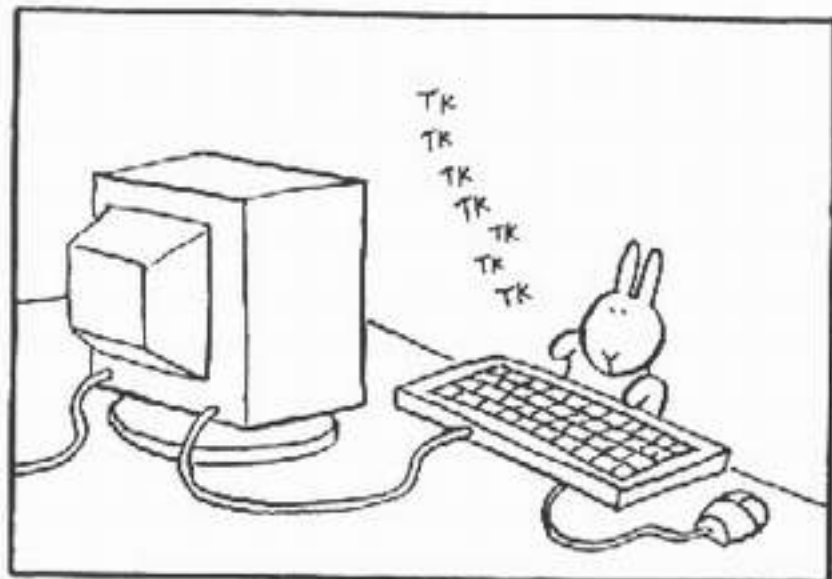

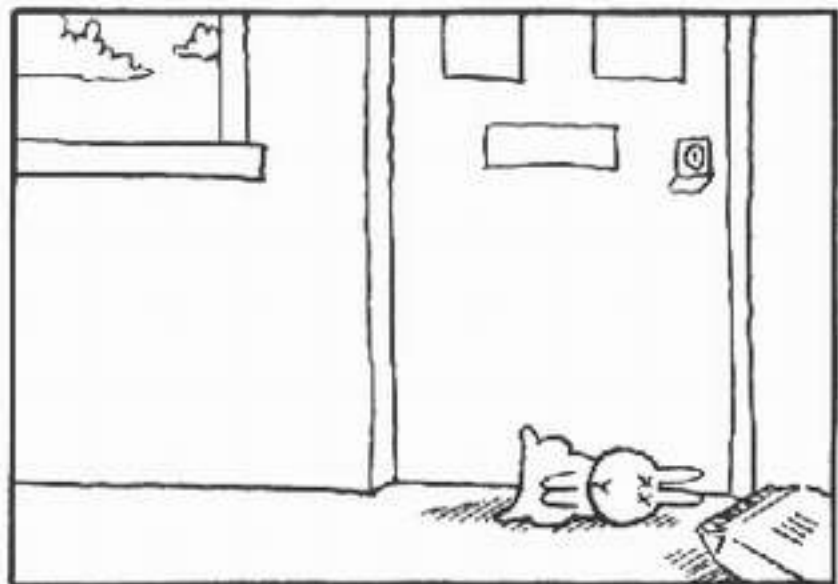
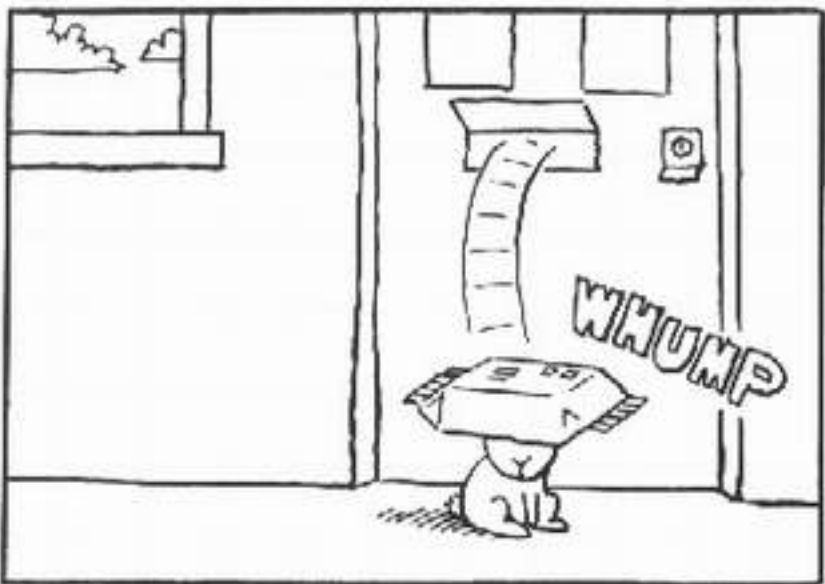
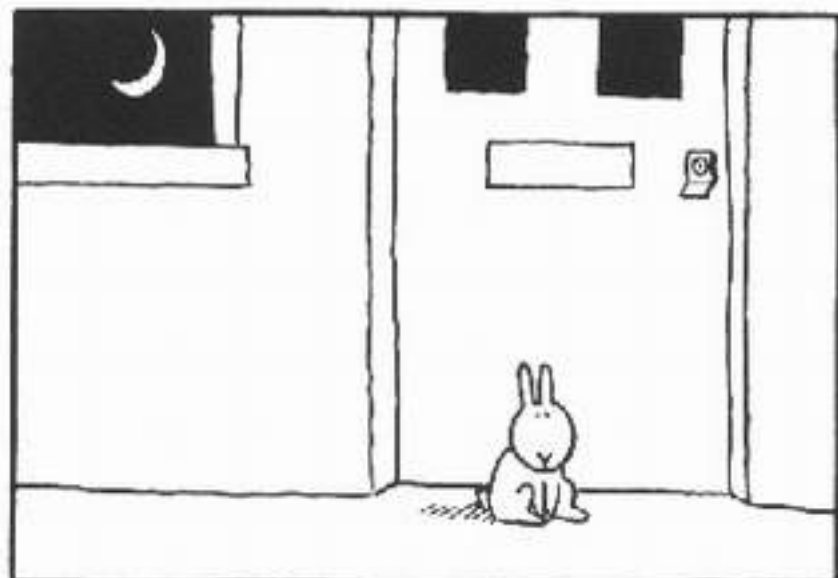
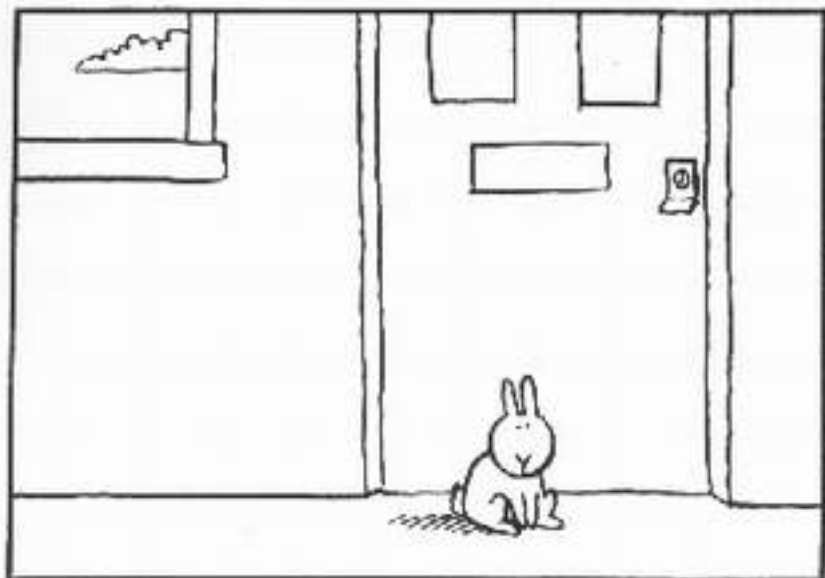





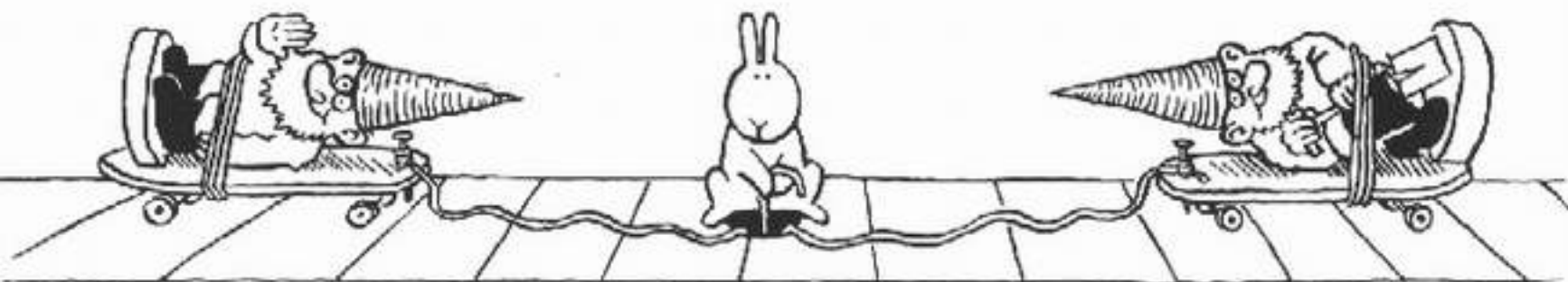





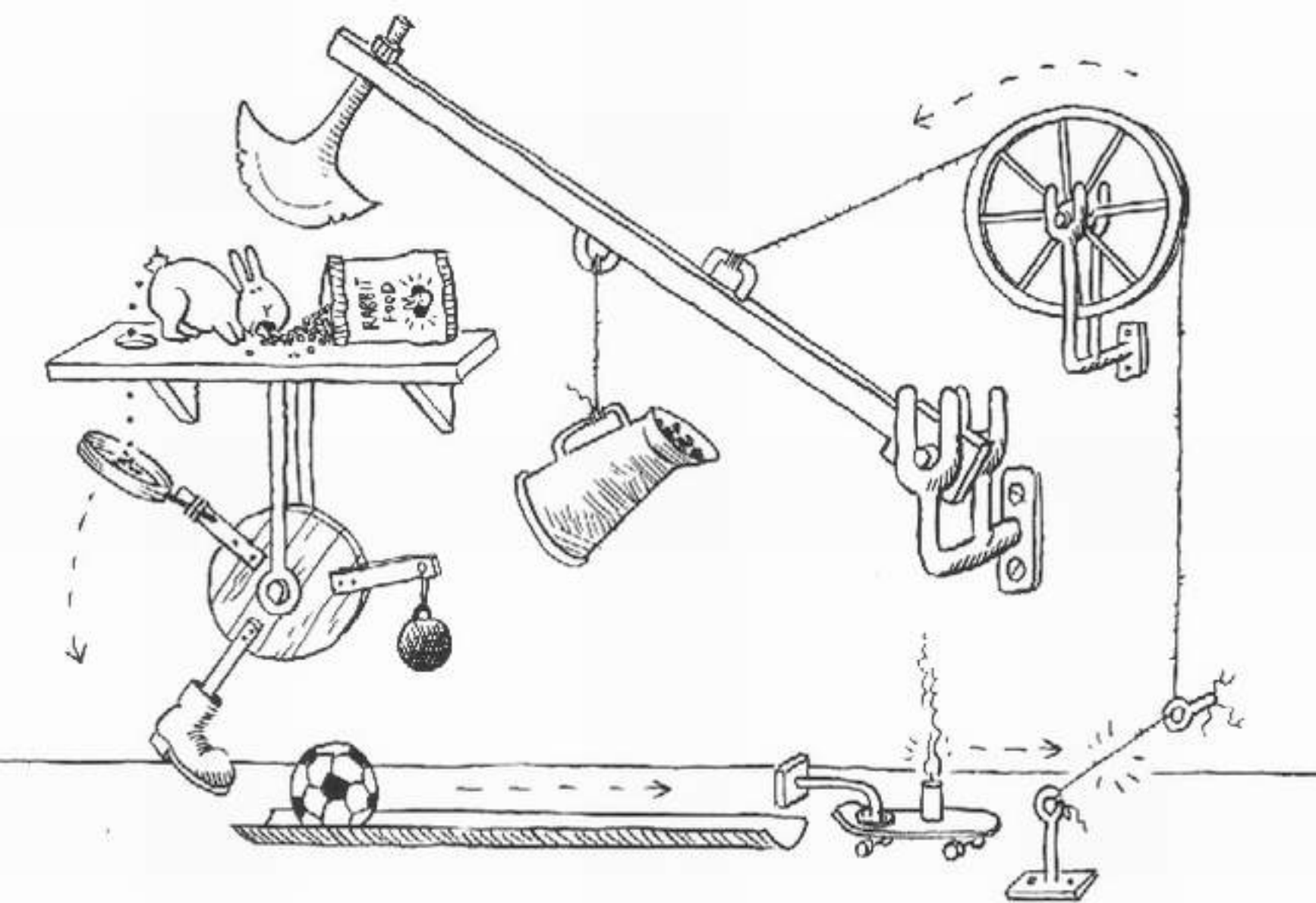

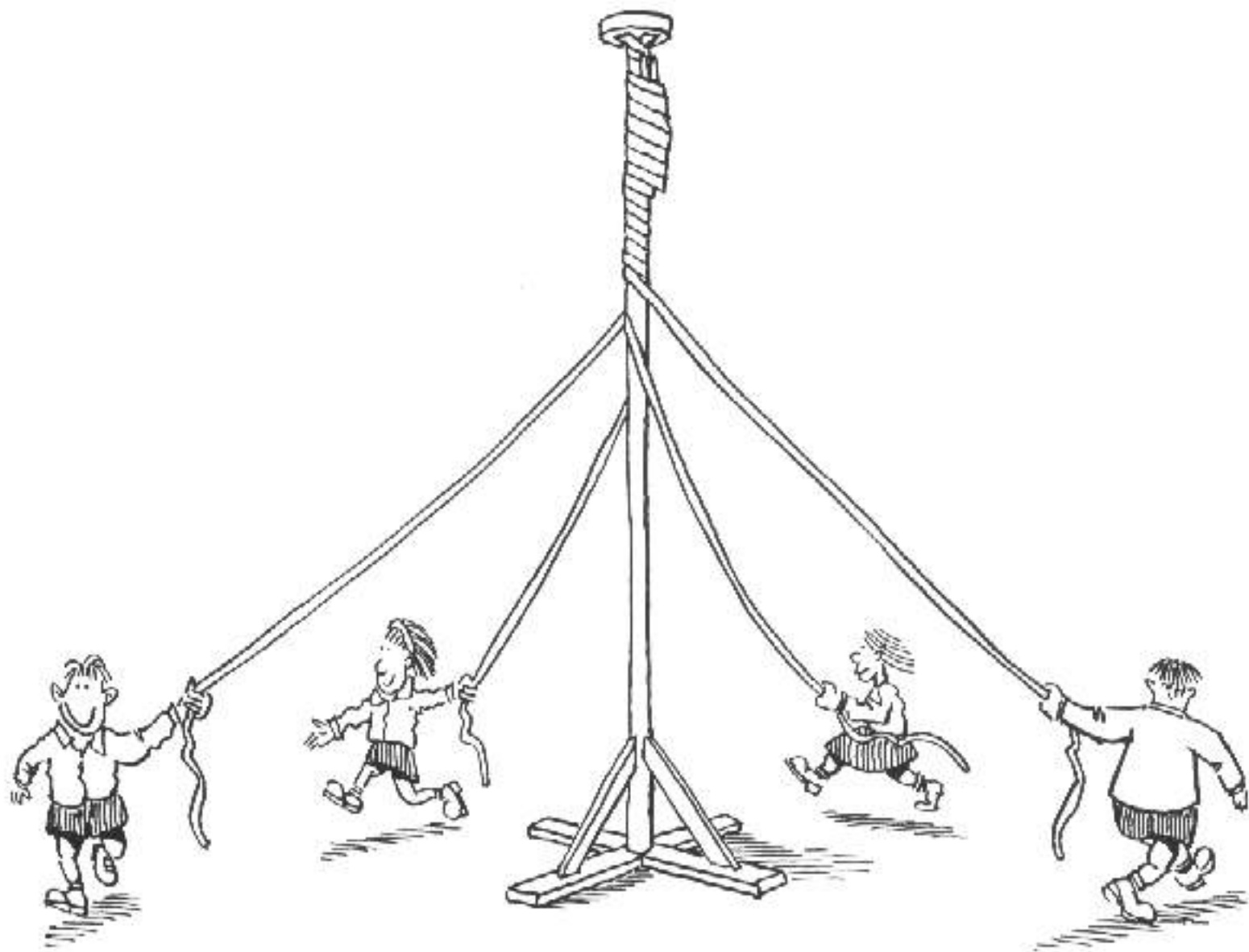

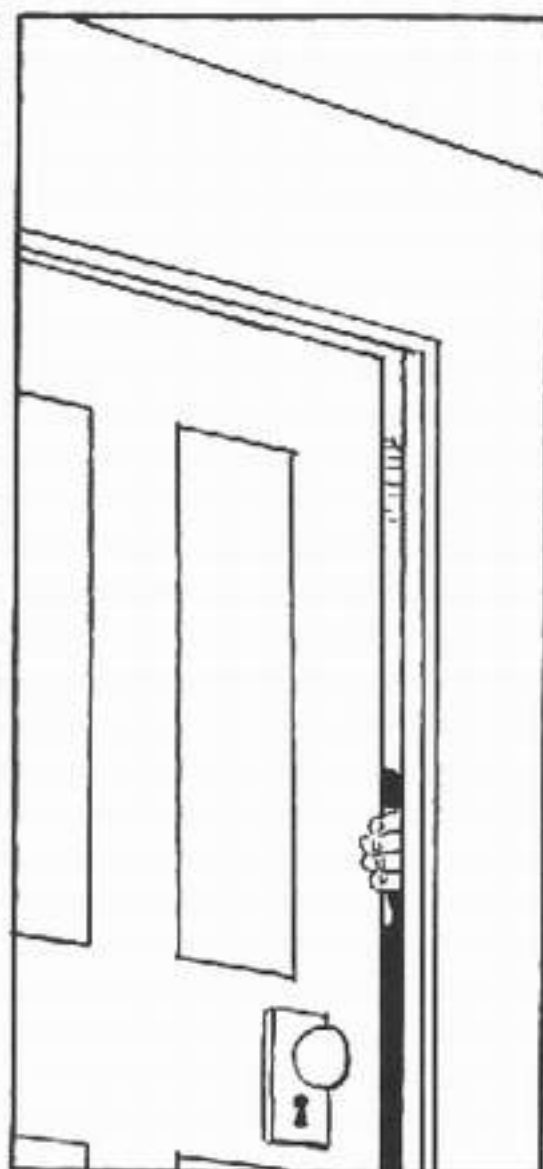
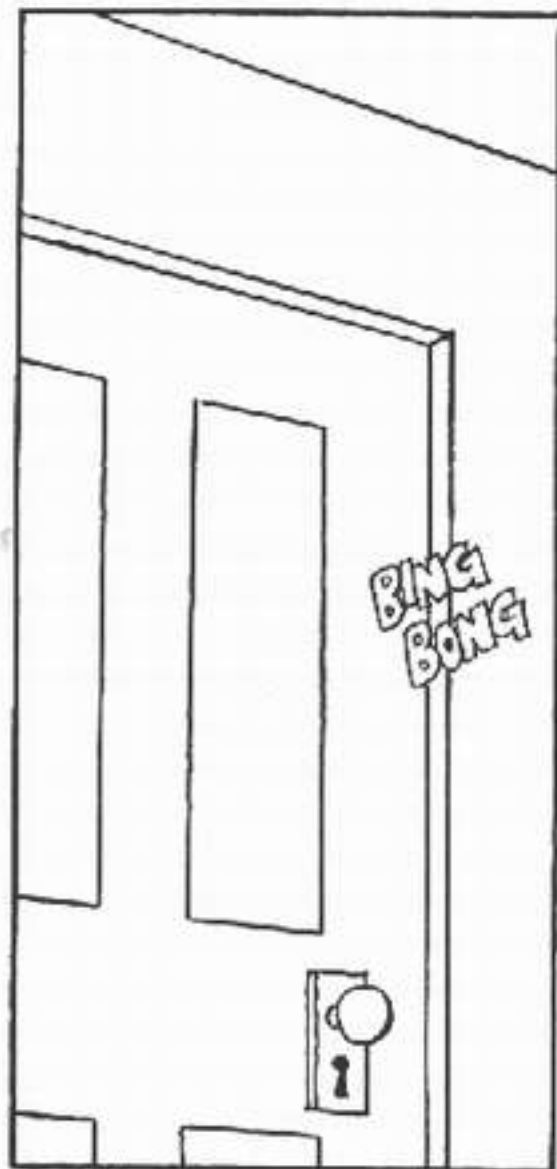



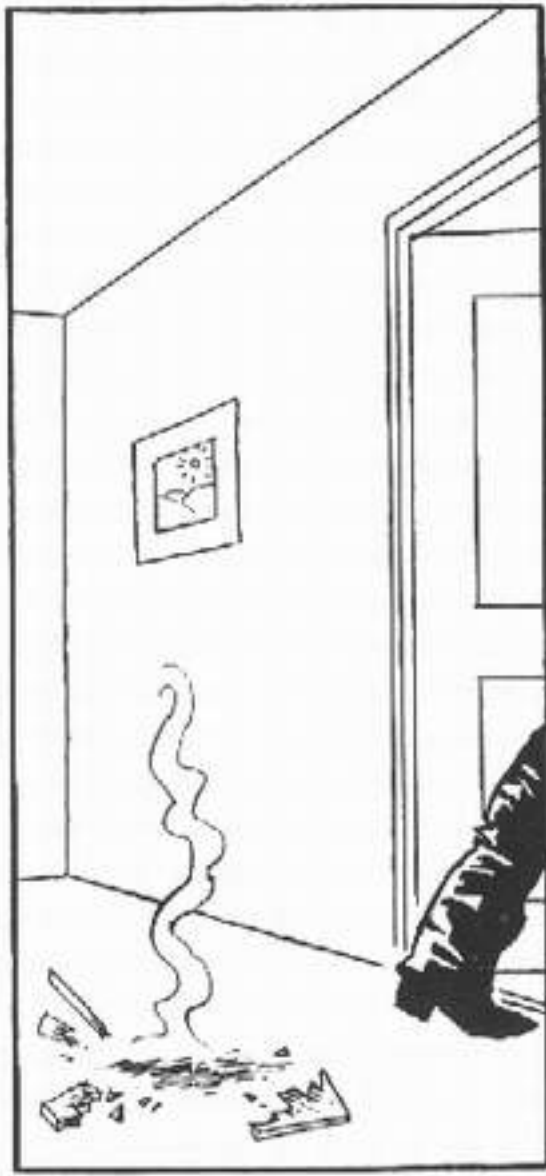

> TARGET:  
SARAH CONNOR

> TERMINATED  
INDIVIDUAL:



\*MISMATCH\*  
\*MISMATCH\*  
\*MISMATCH\*



> SELECT OPTION  
> A: INFORM OTHER  
EVIL MACHINES OF ERROR  
> B: TRY NOT TO THINK  
ABOUT IT

OPTION B SELECTED



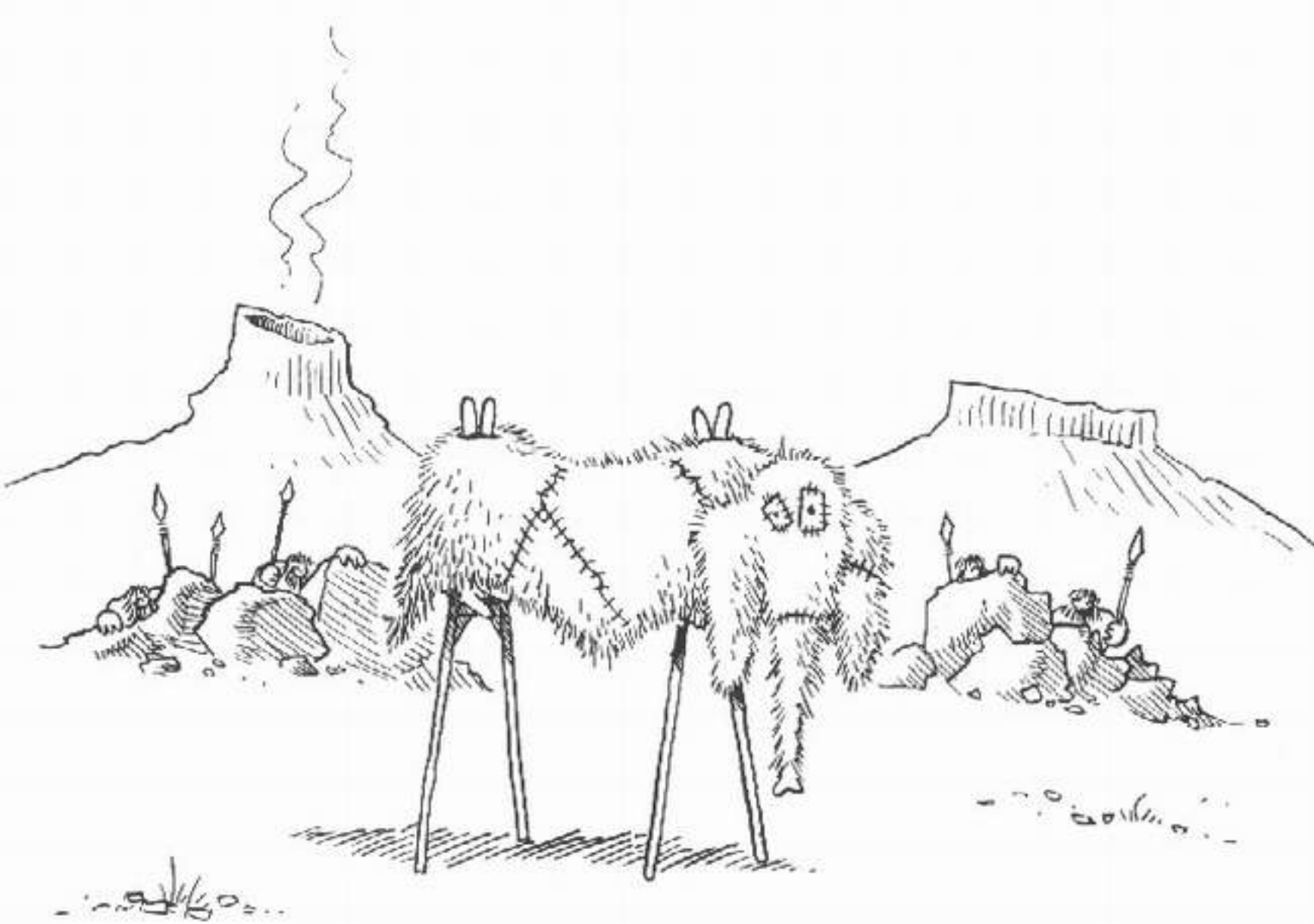

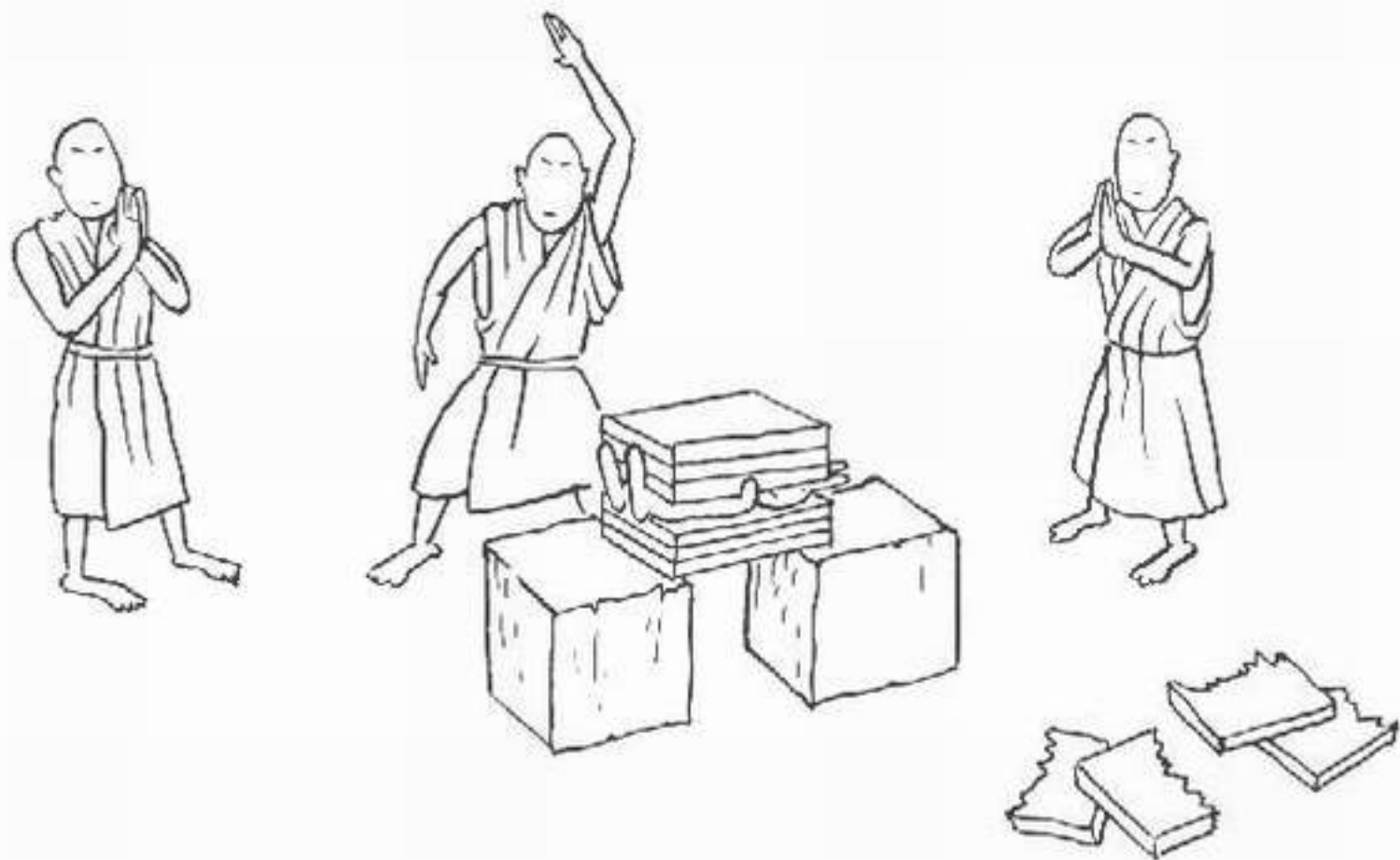





HOLLYWOOD



HOLLYWOOD

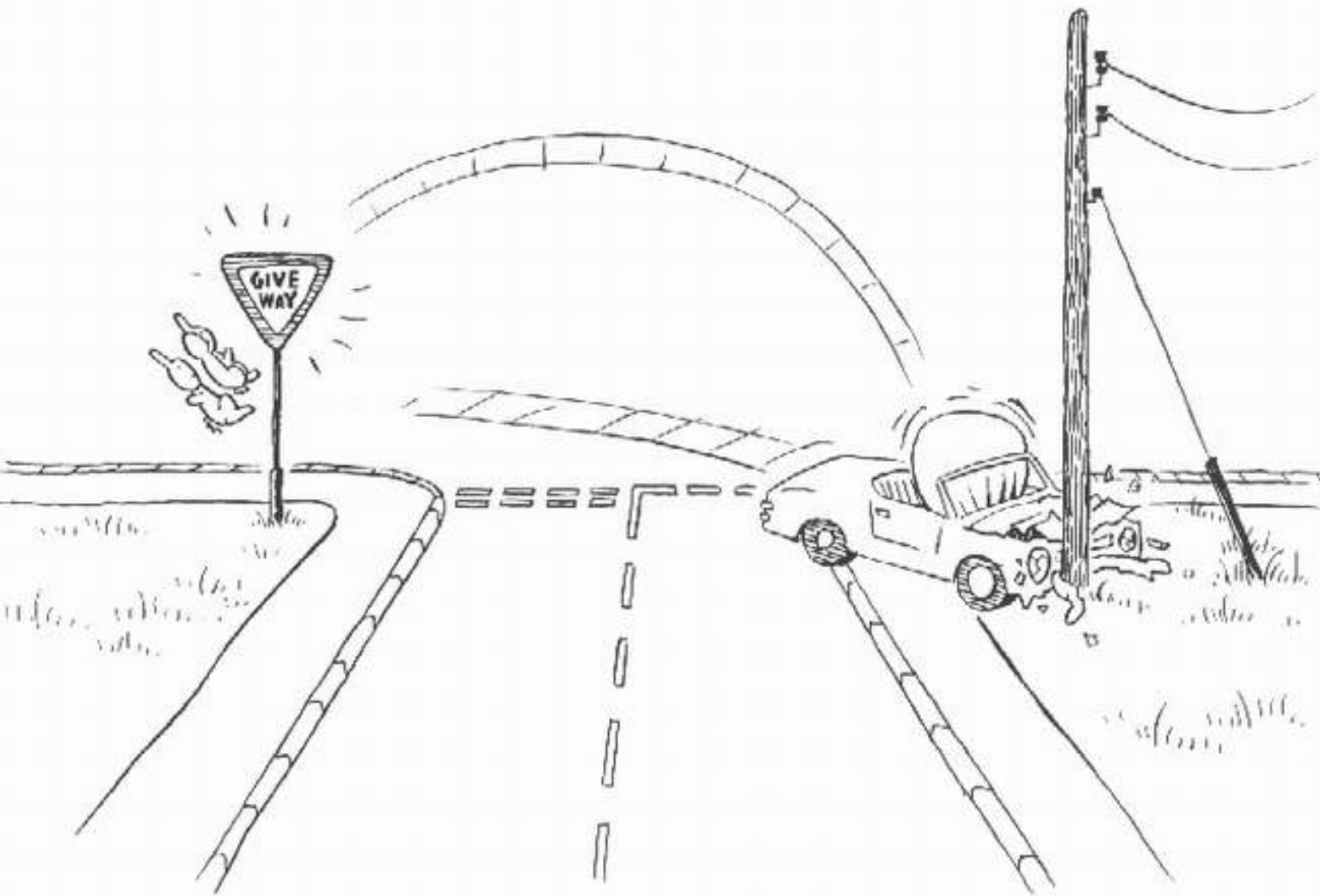







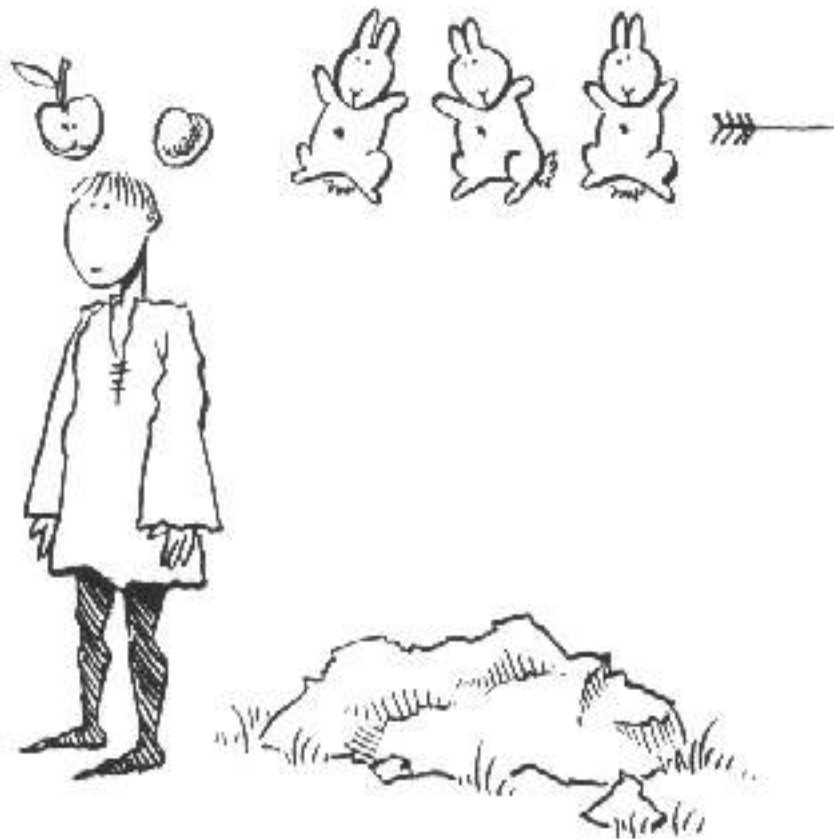

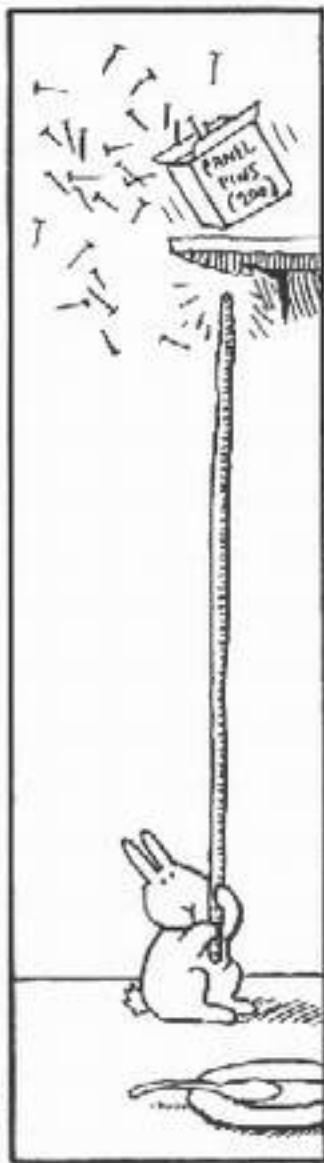
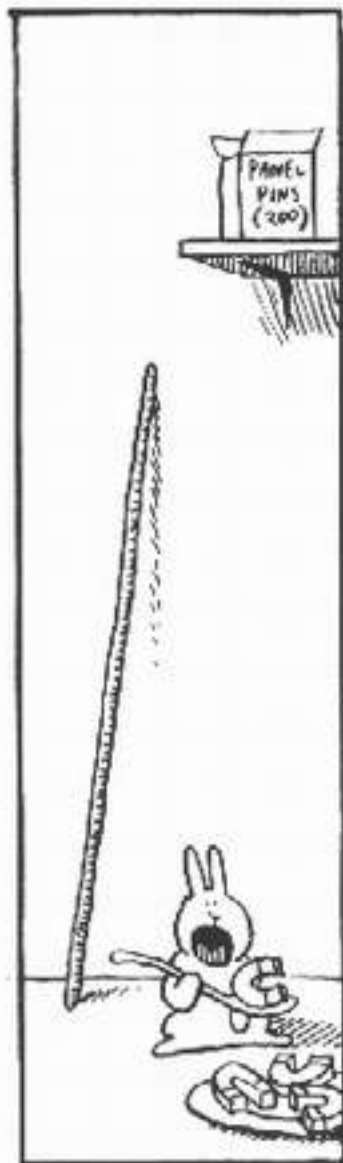

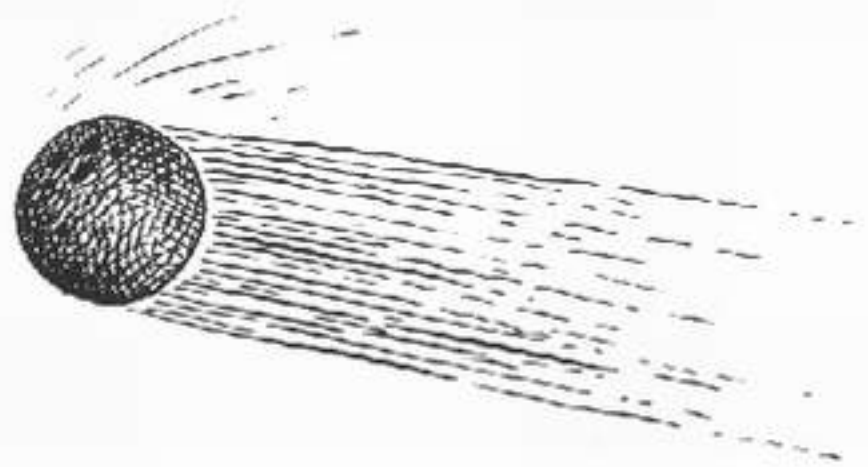
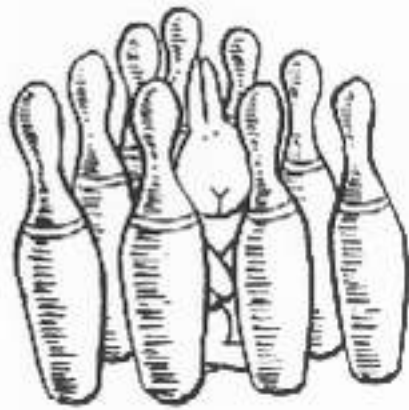





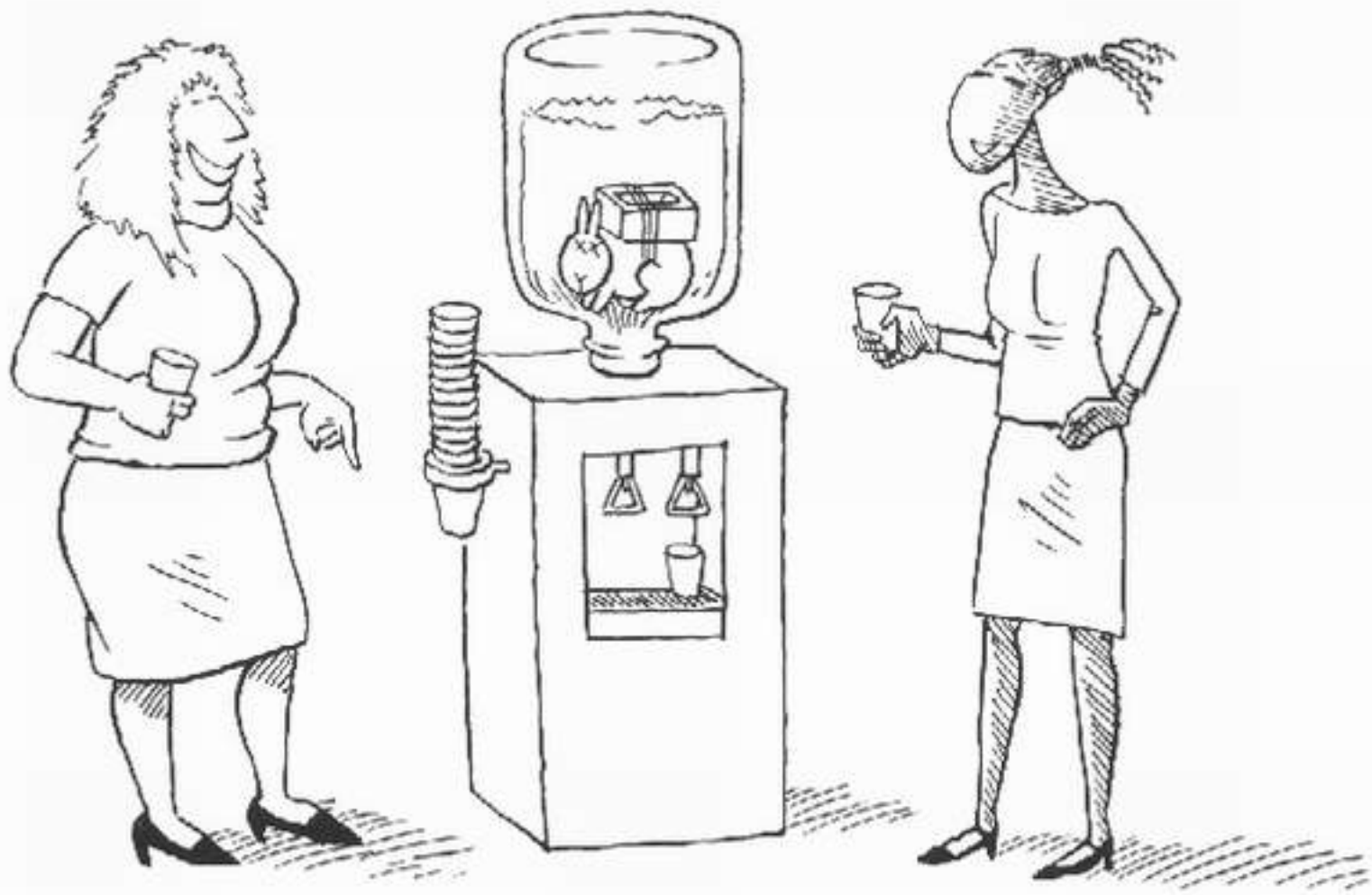





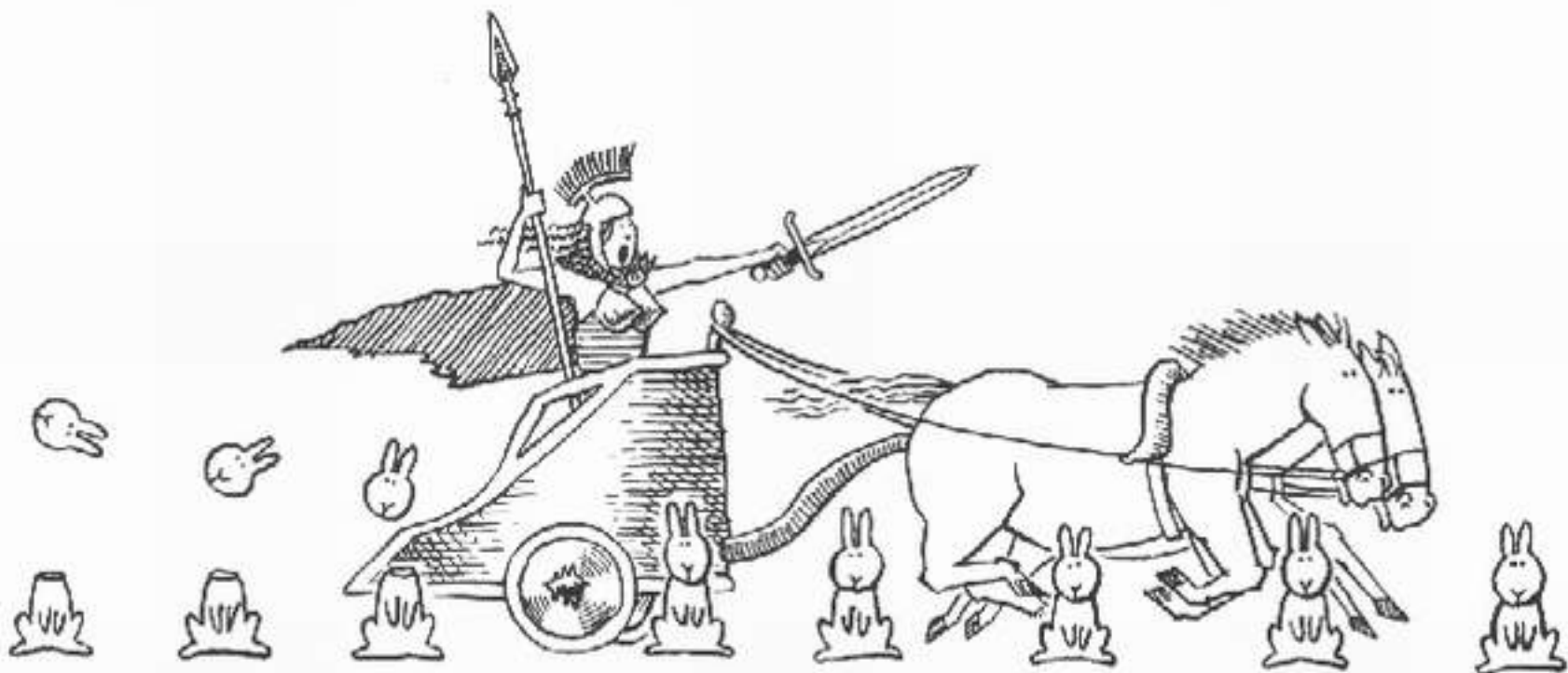

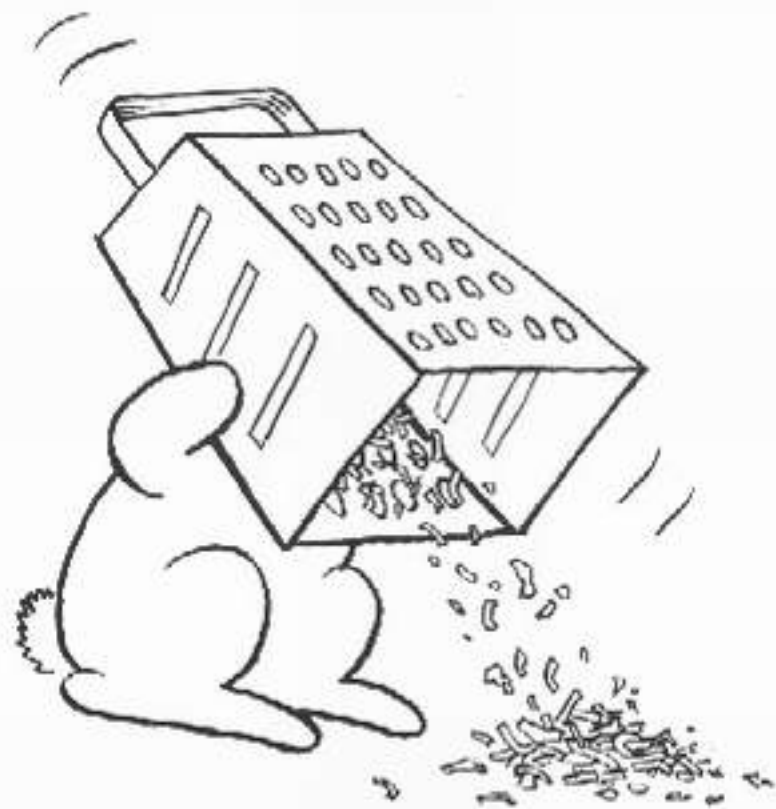

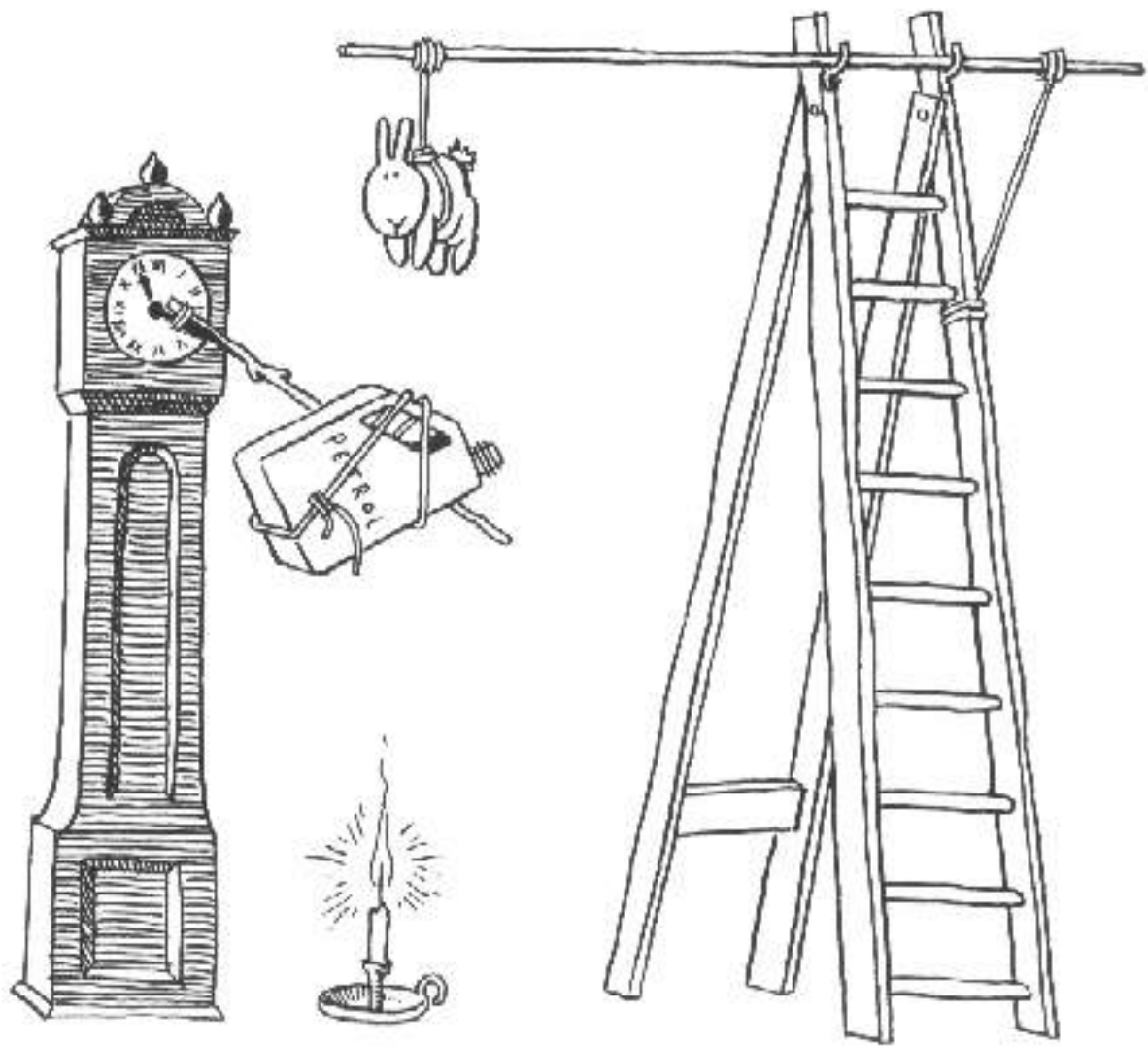





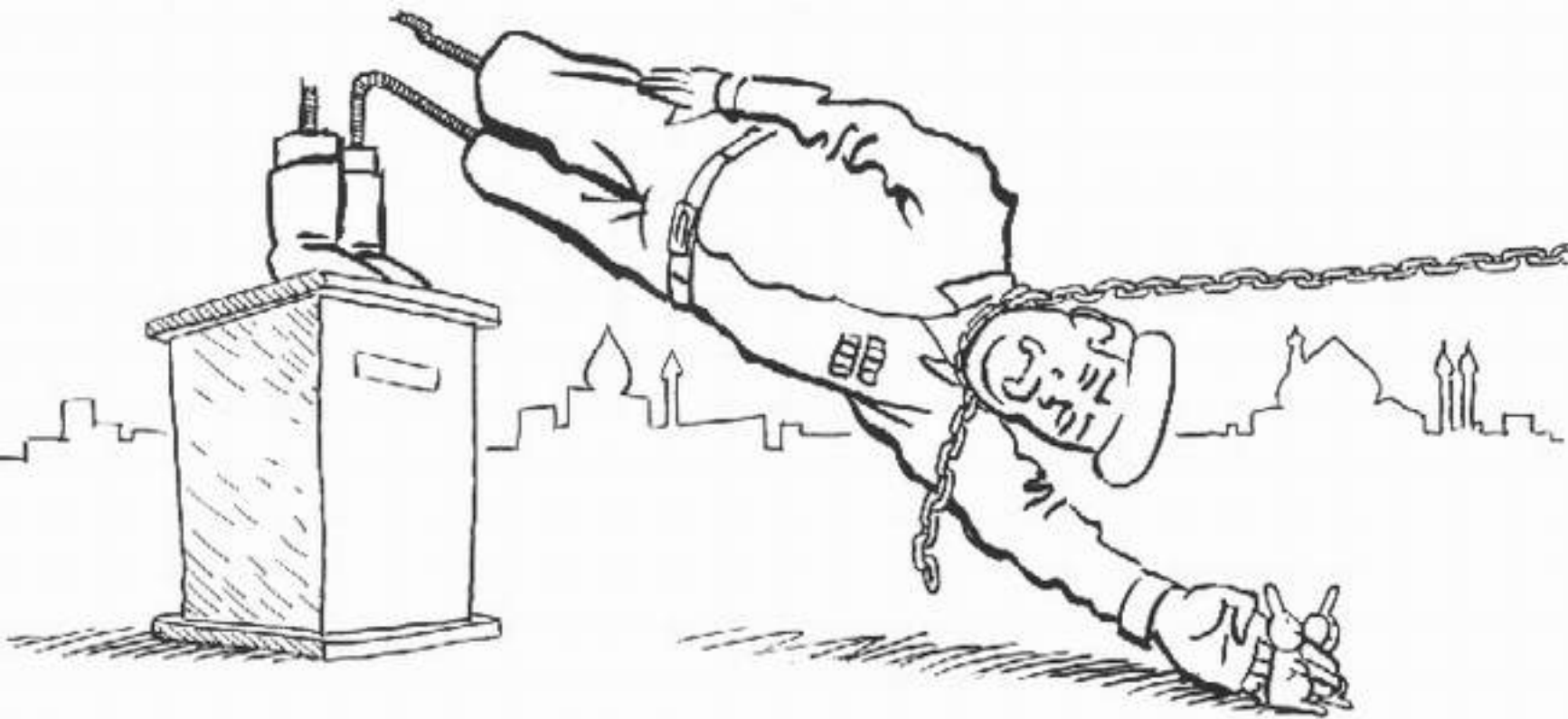

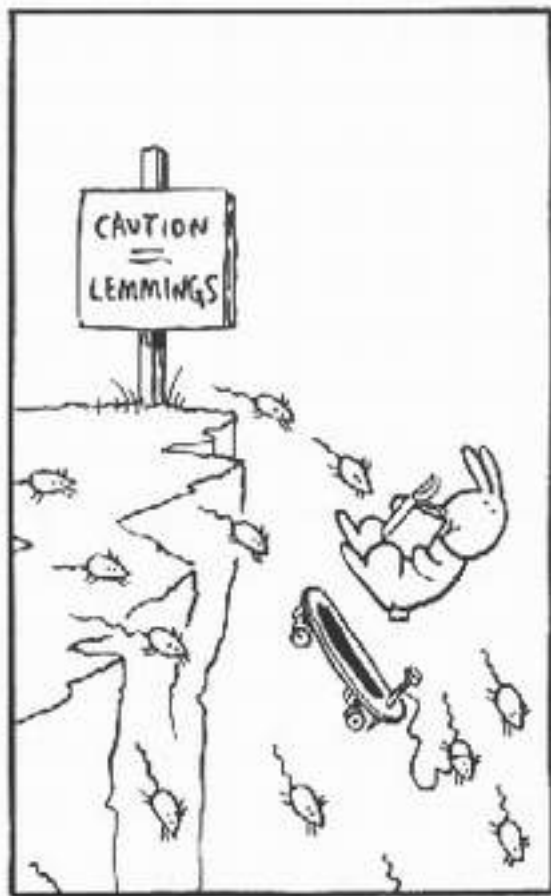

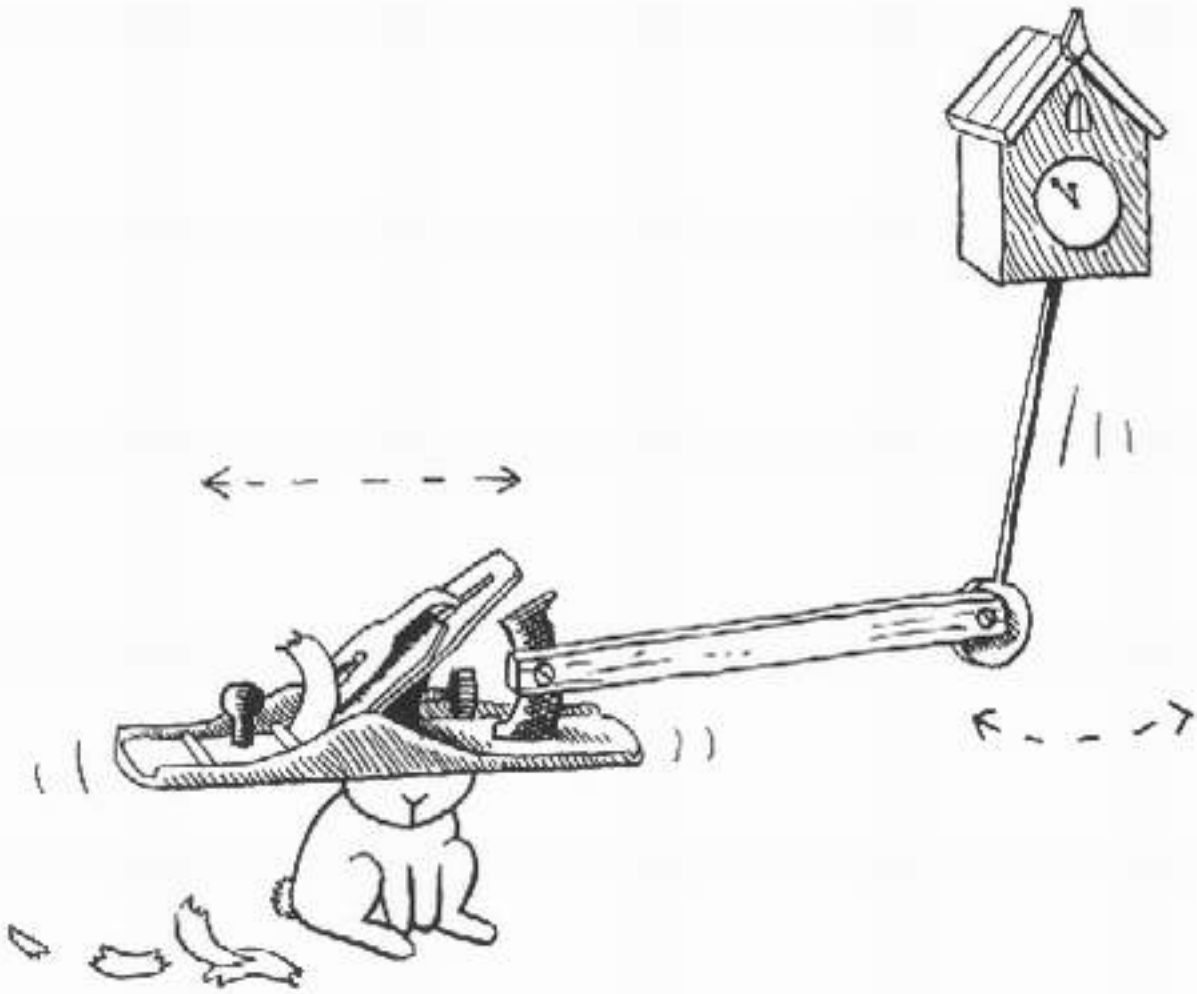

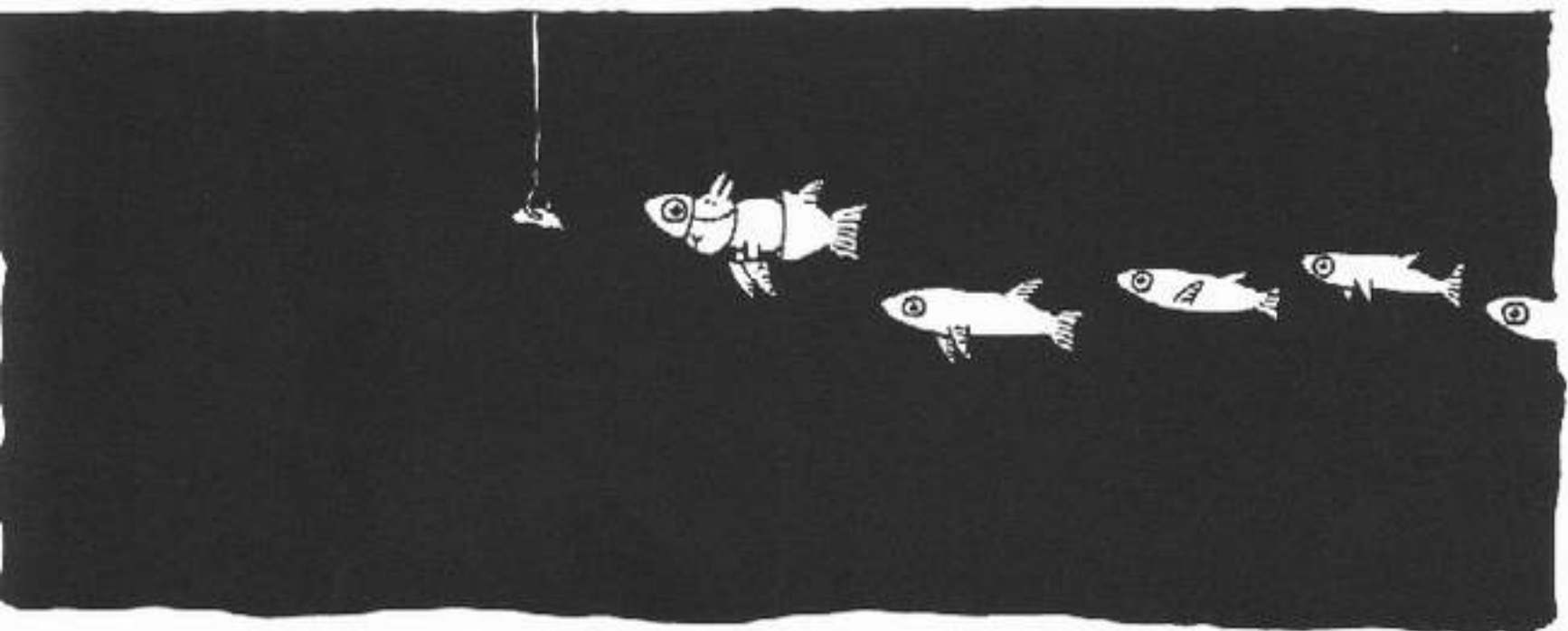

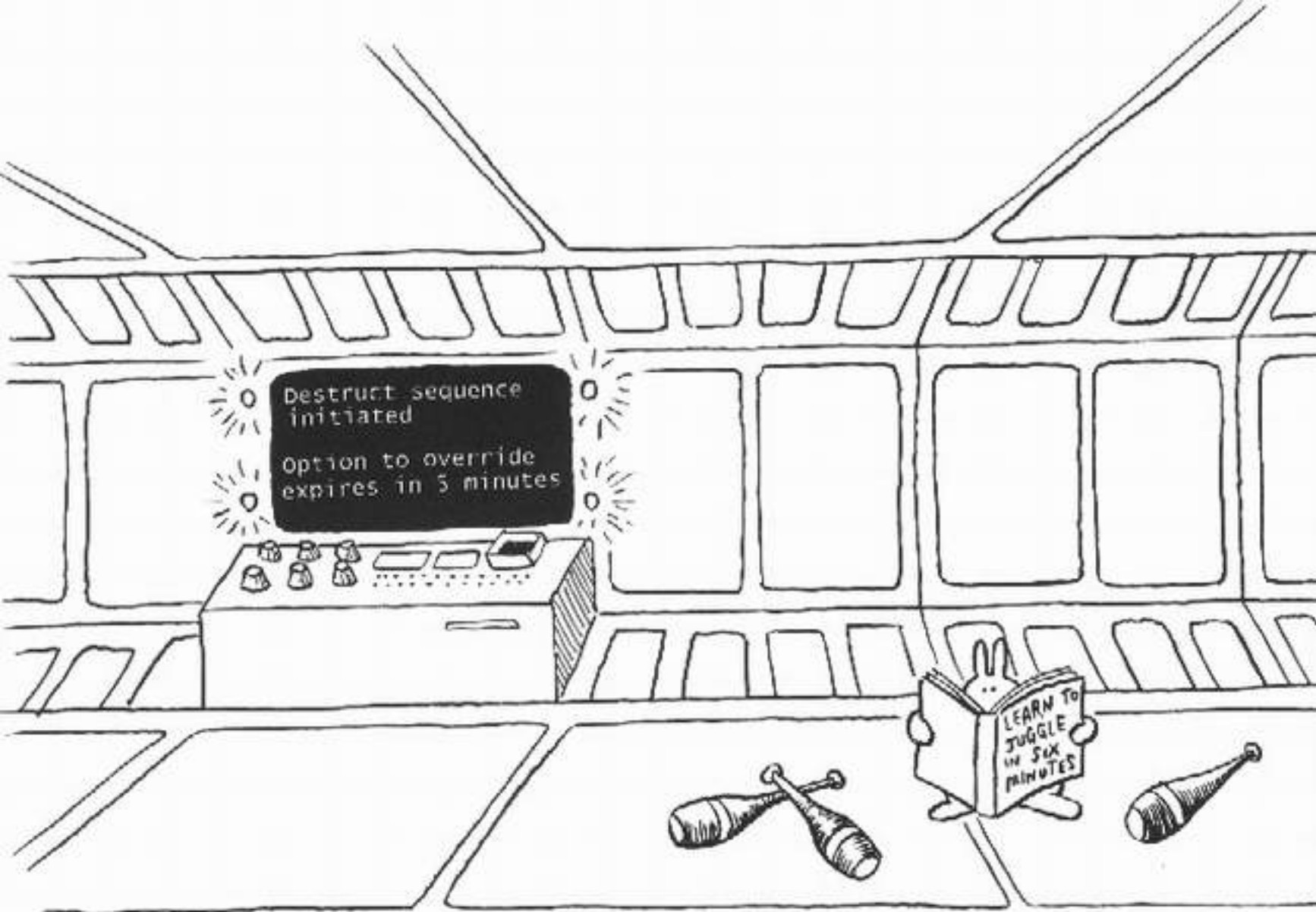

Destruct sequence  
initiated

Option to override  
expires in 5 minutes

LEARN TO  
JUGGLE  
IN SIX  
MINUTES

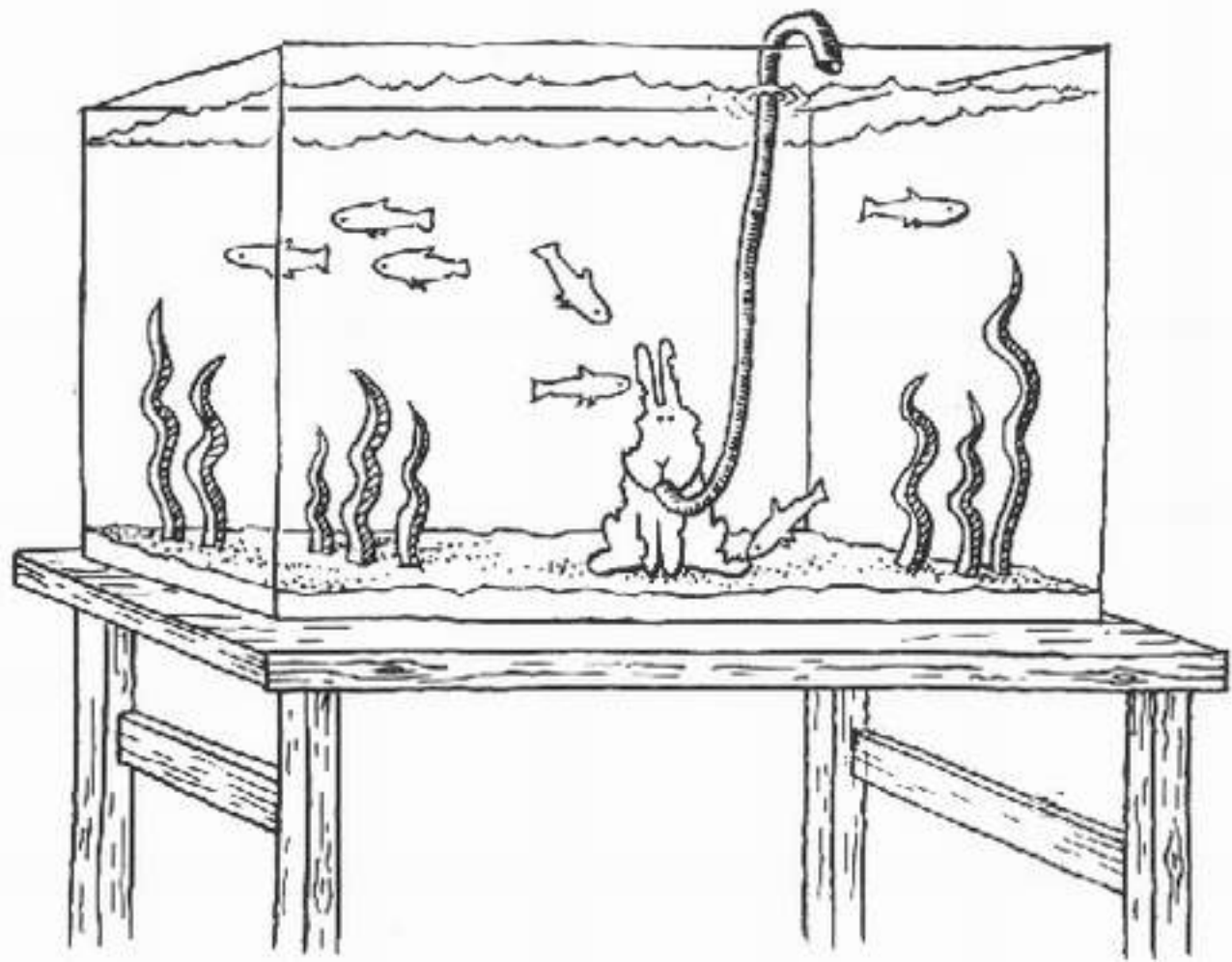

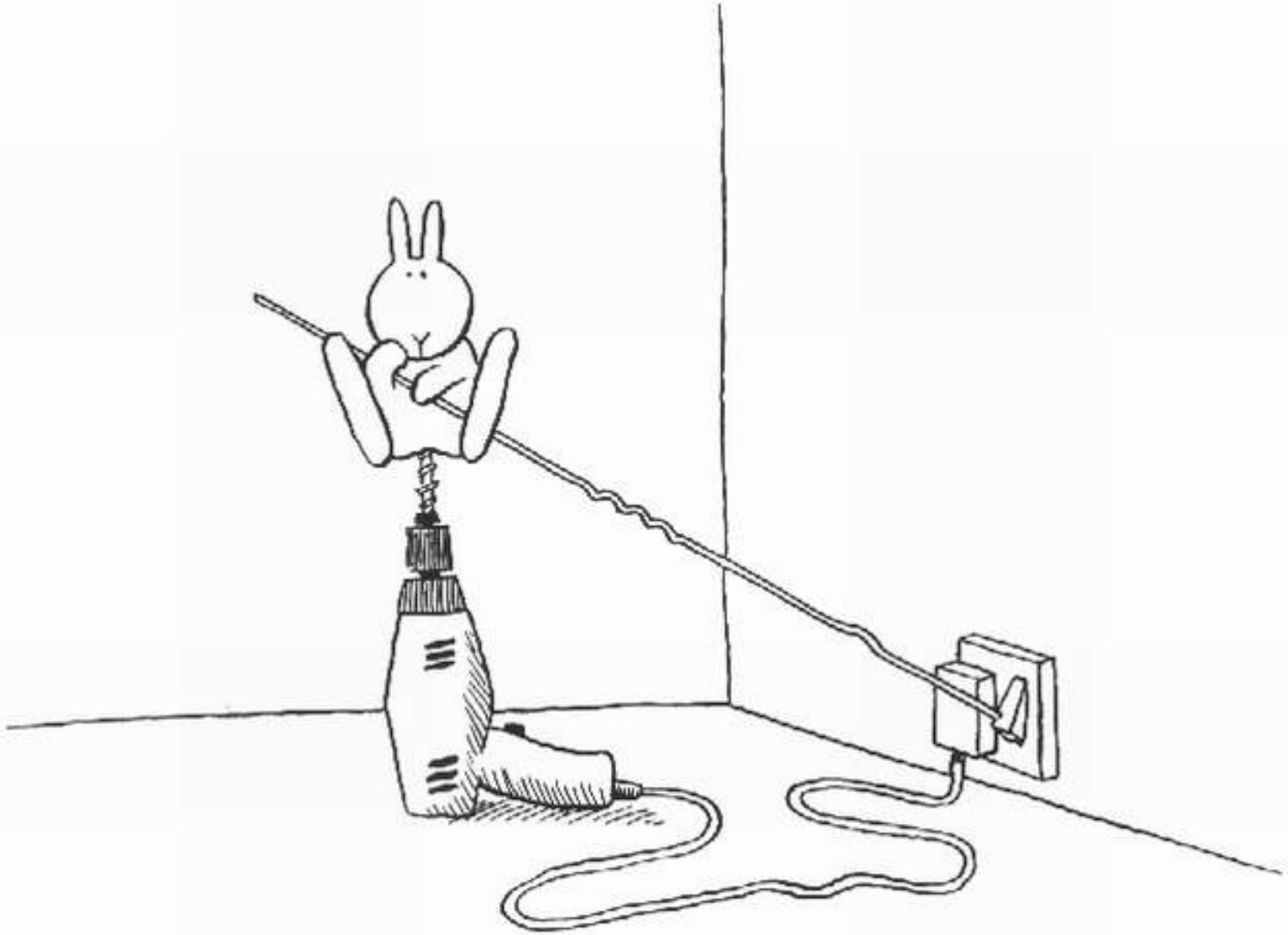
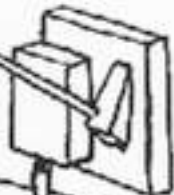
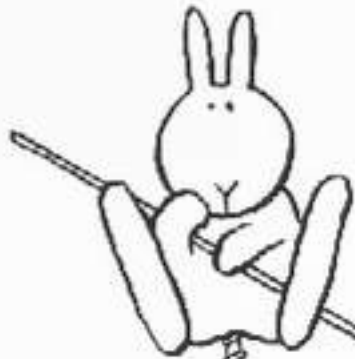

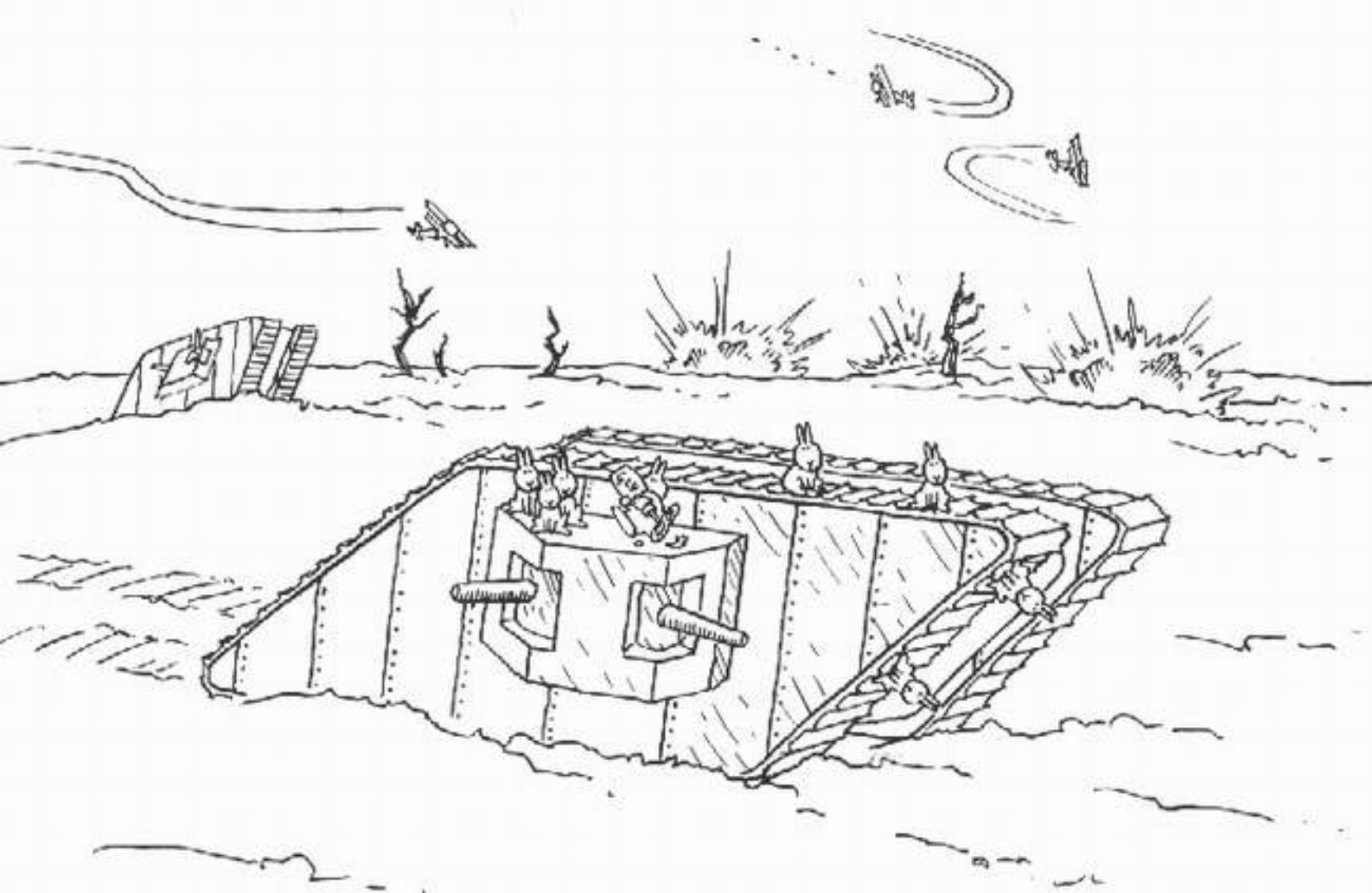



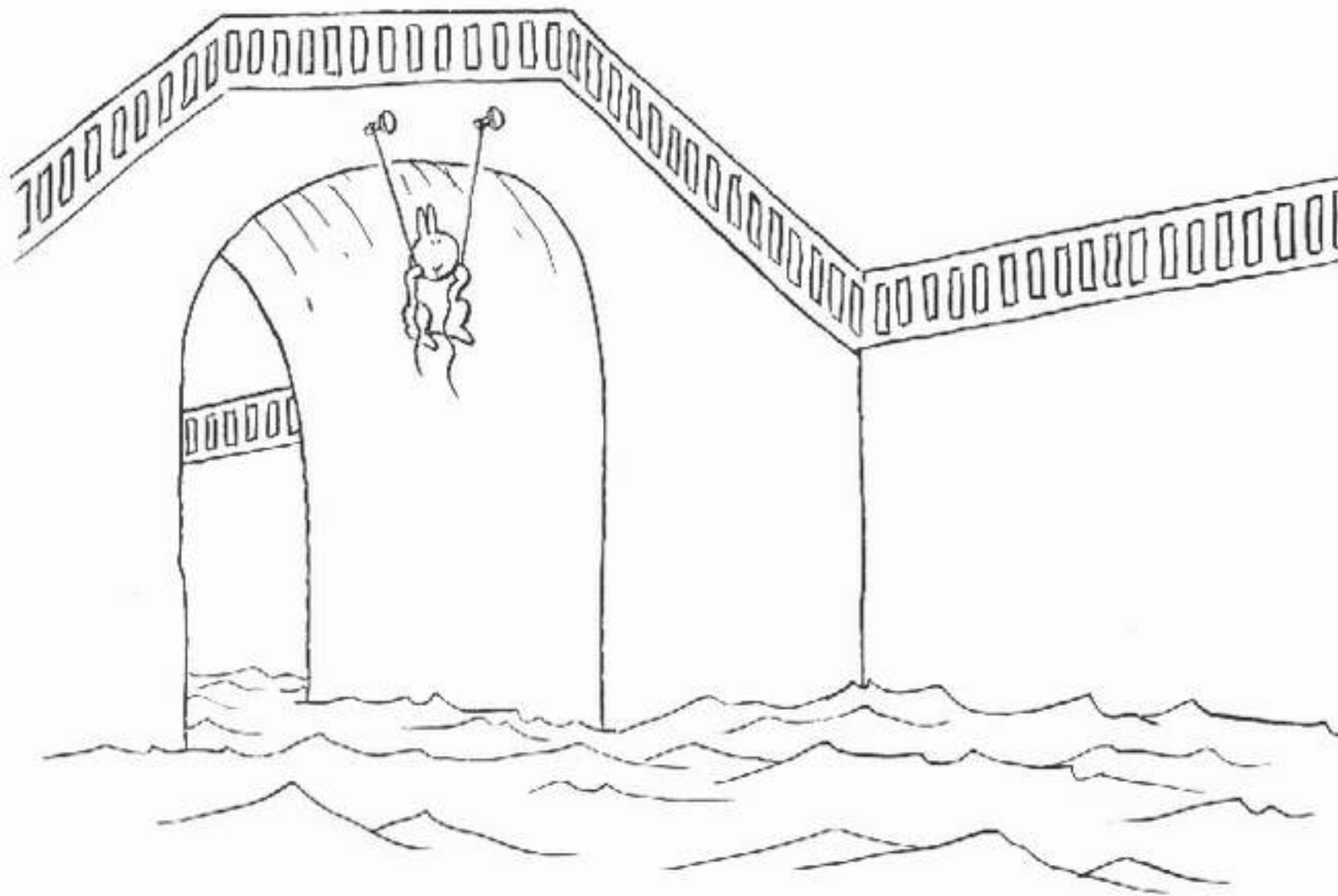

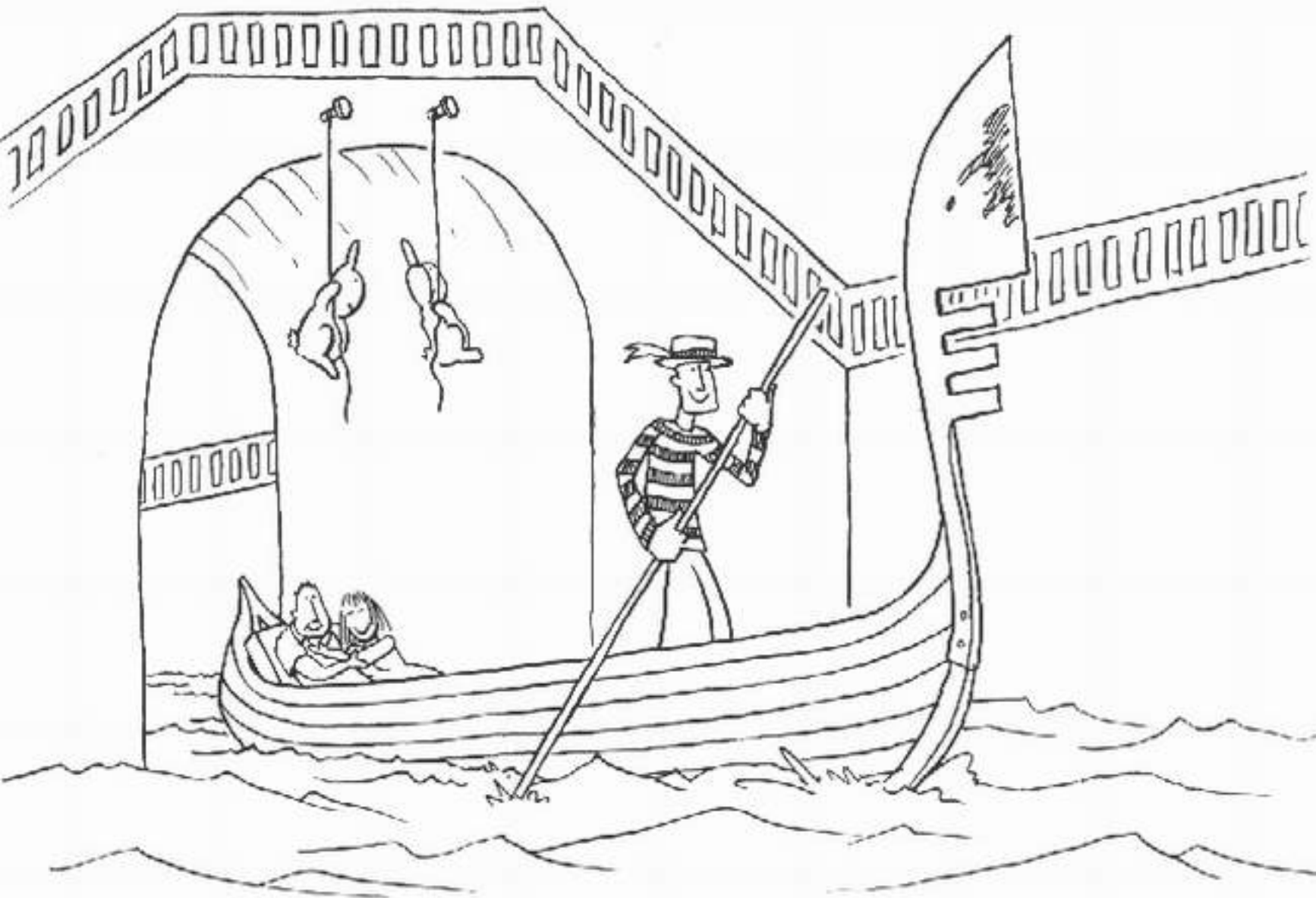

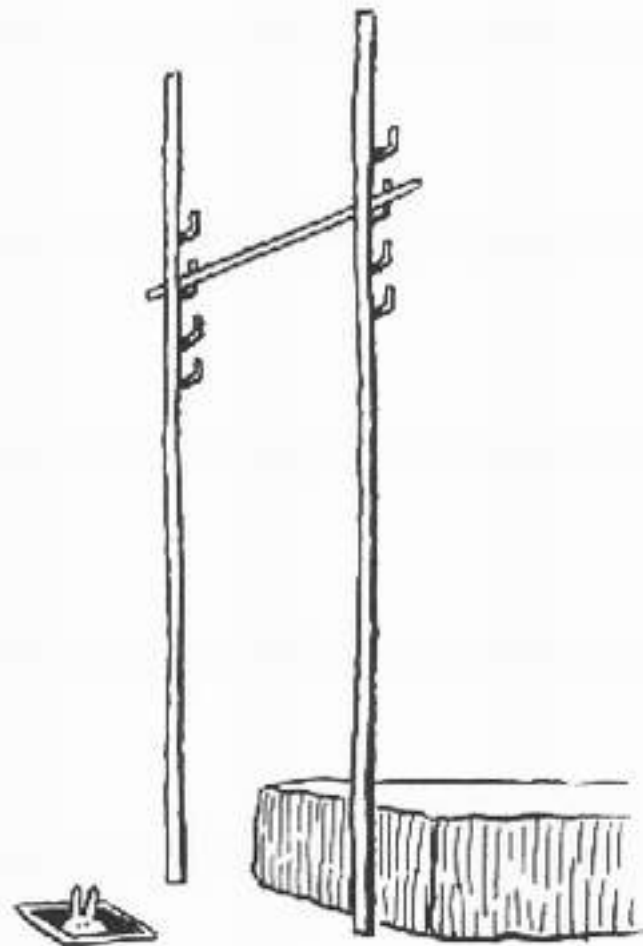
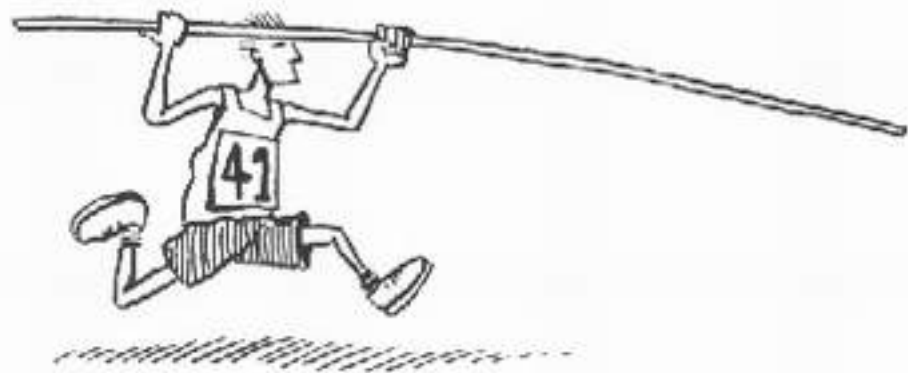

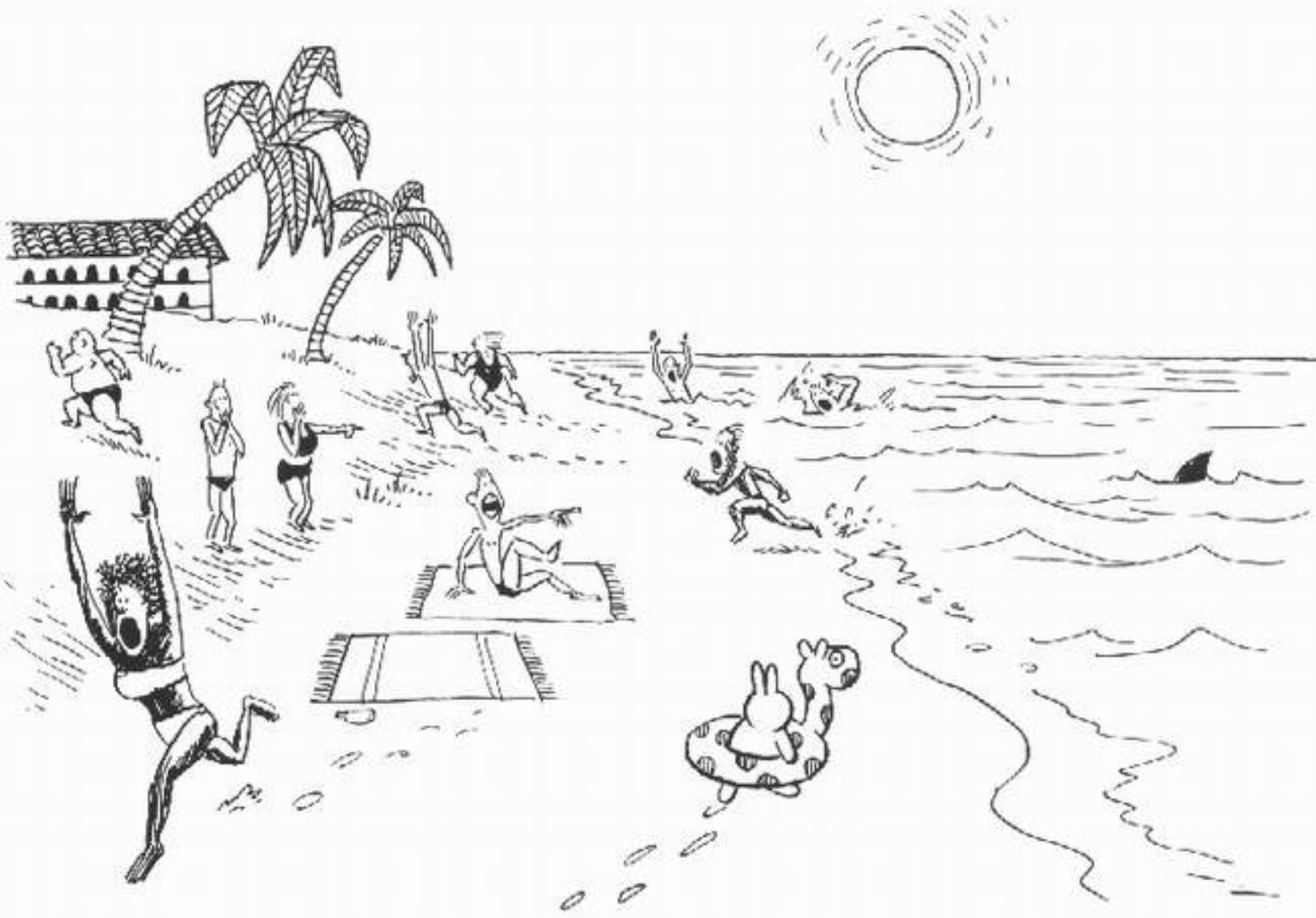

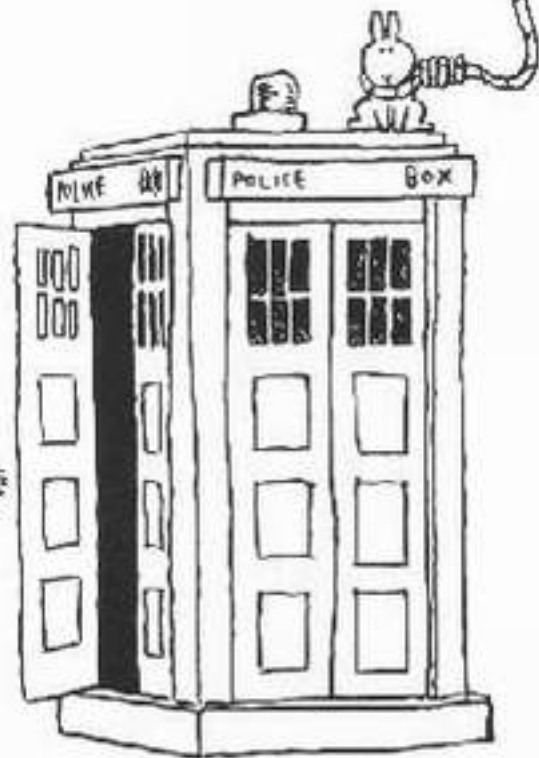
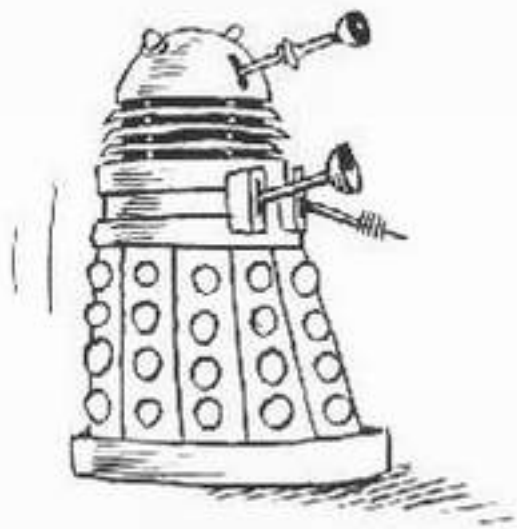



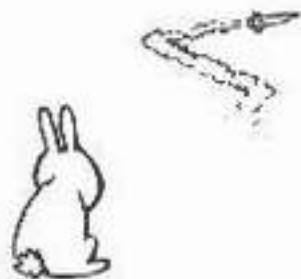
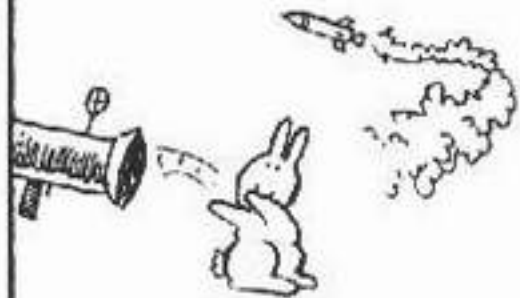
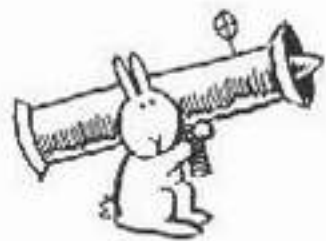





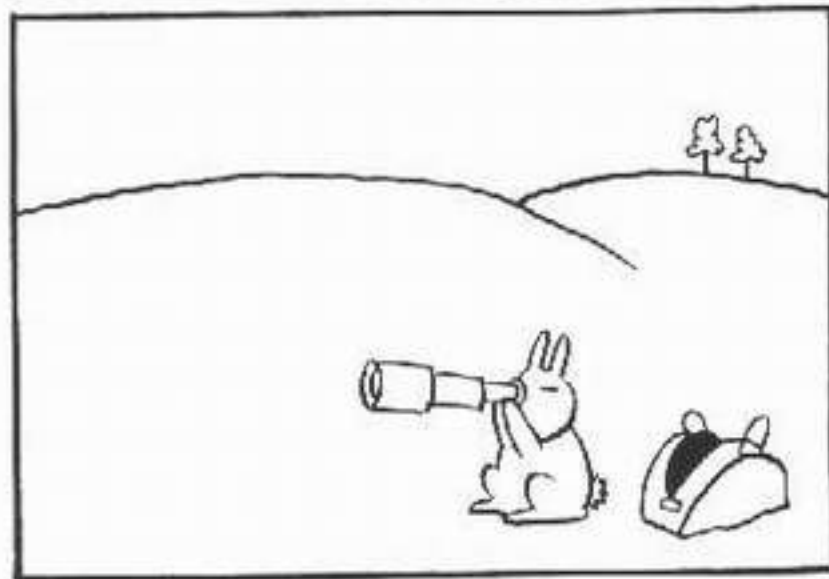
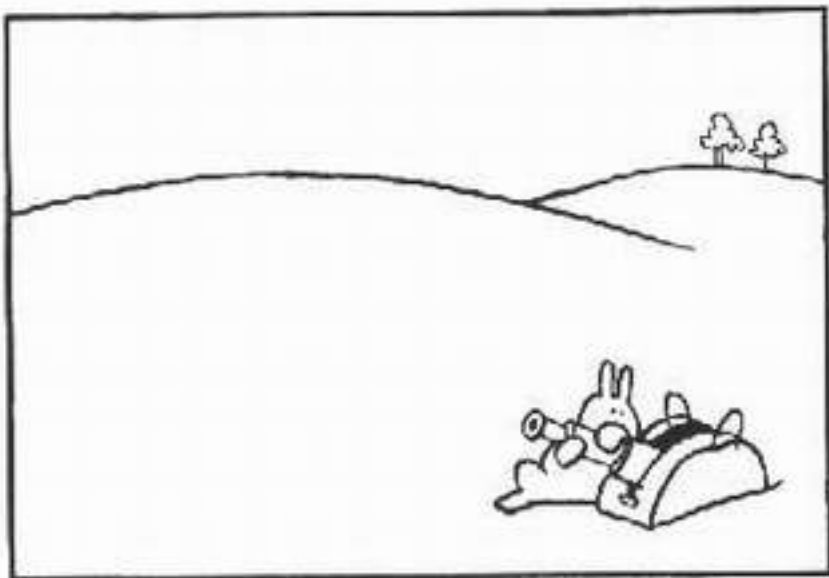
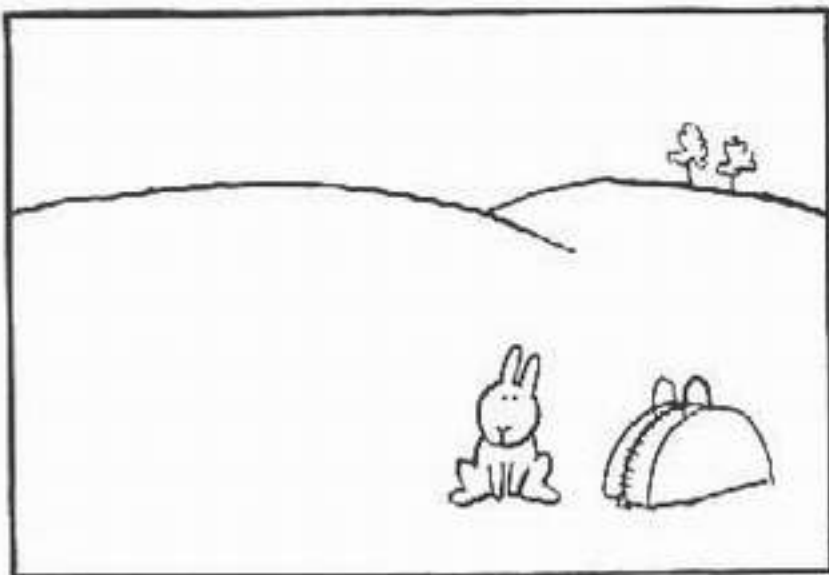

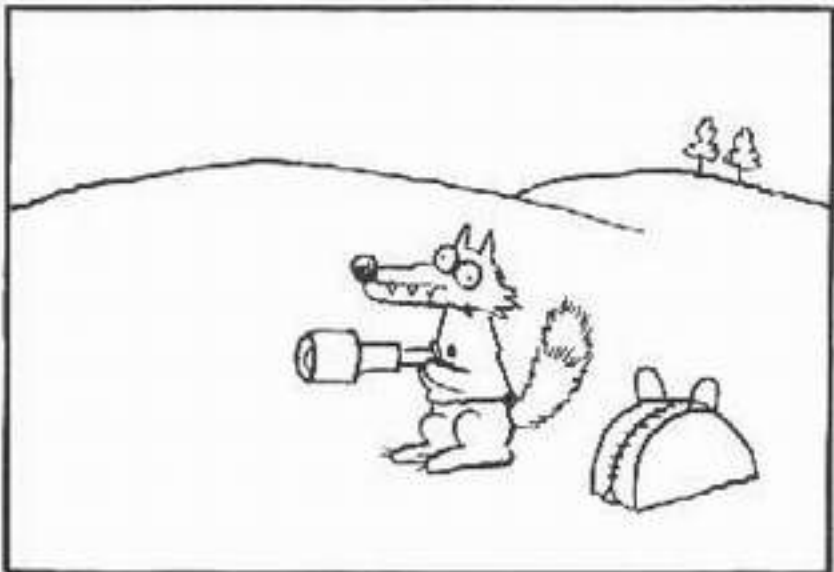
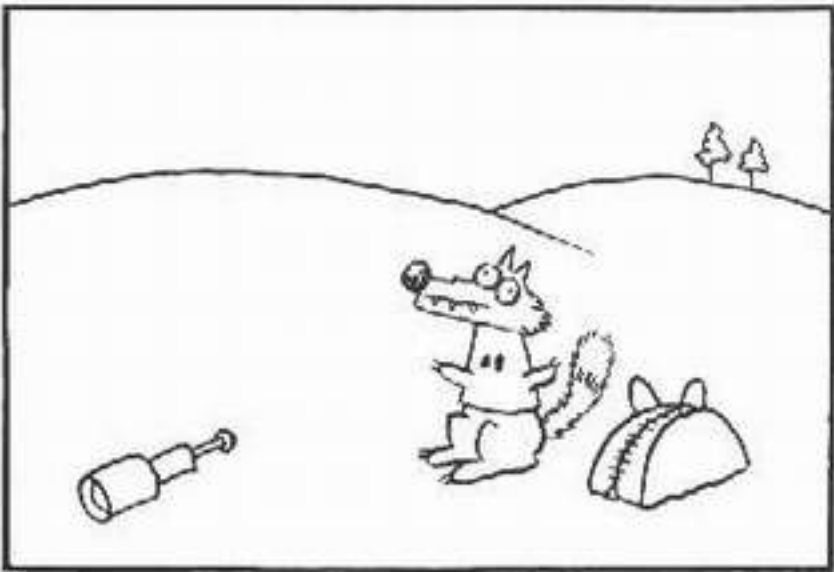
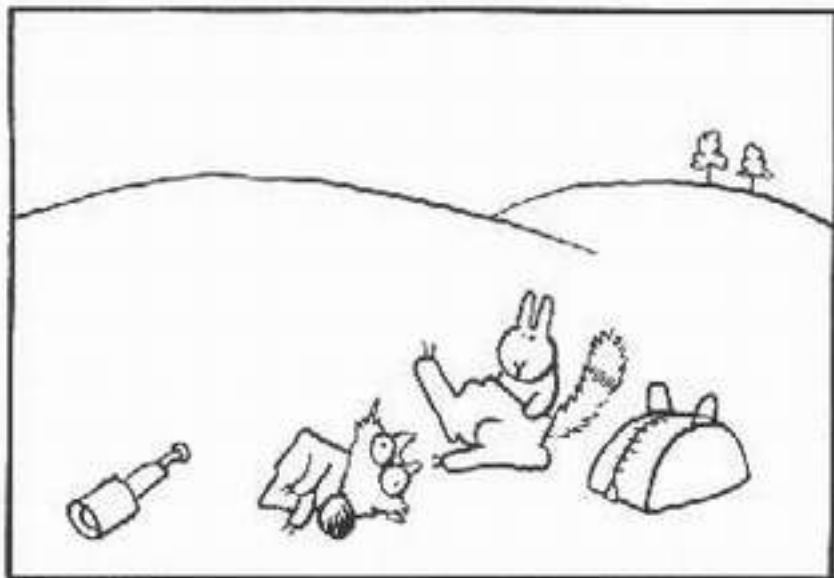
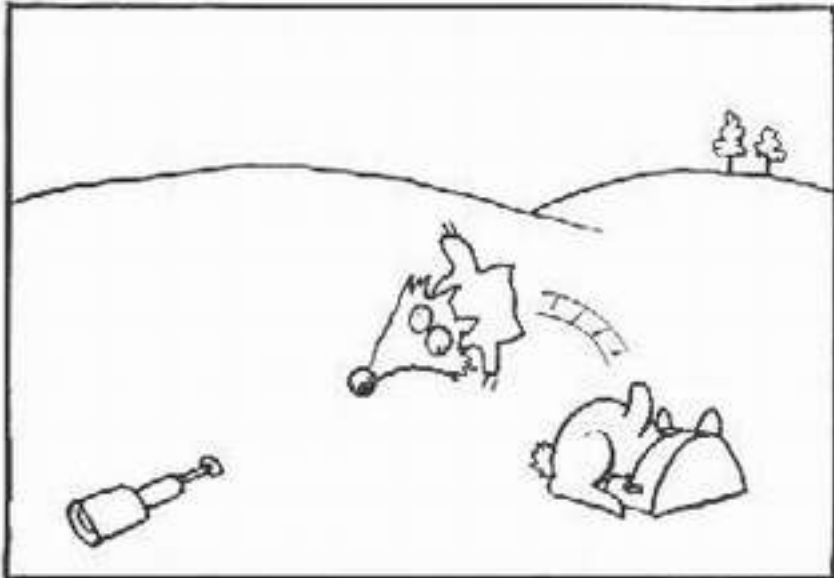

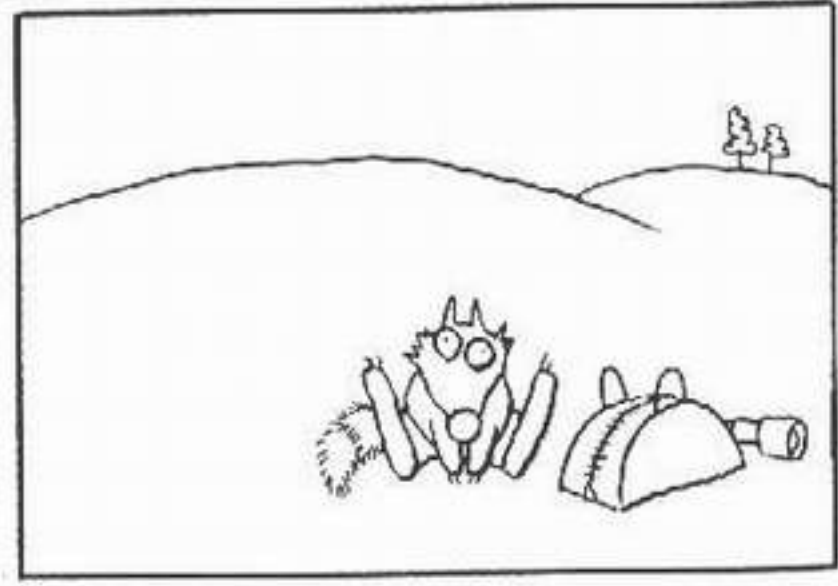
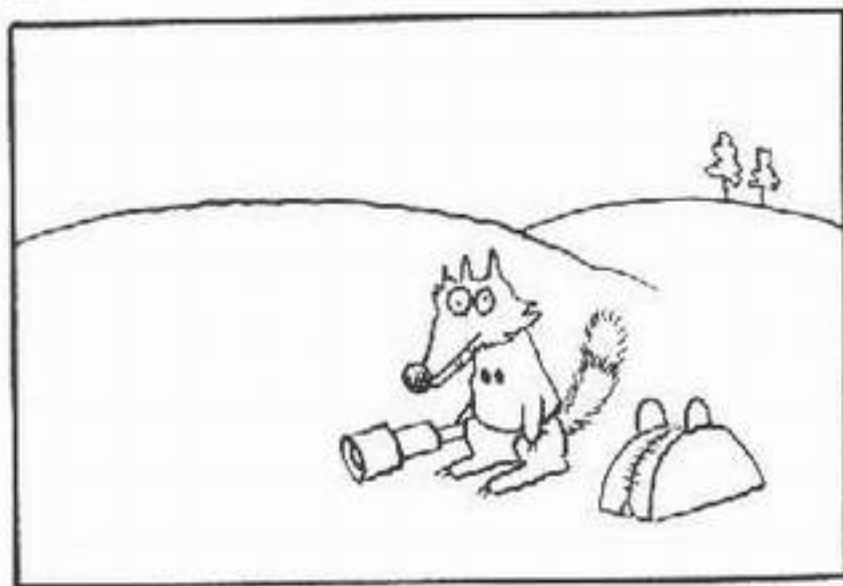
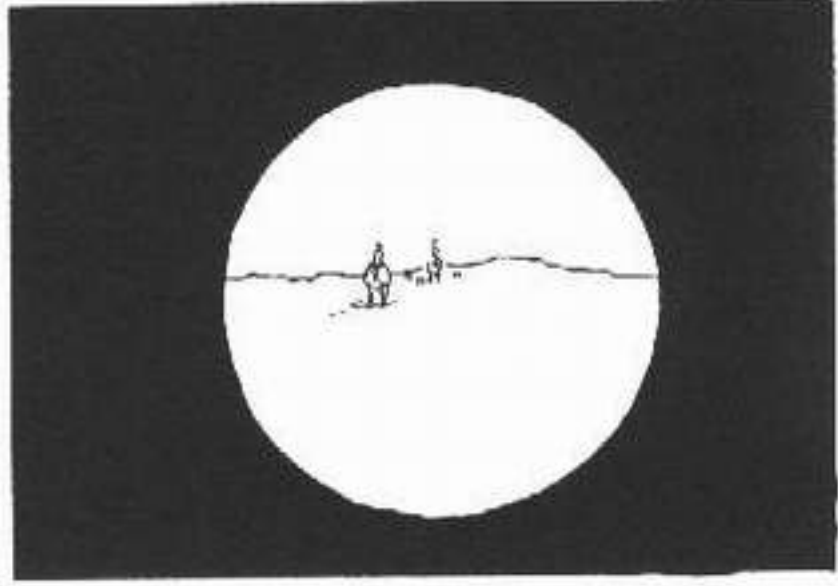
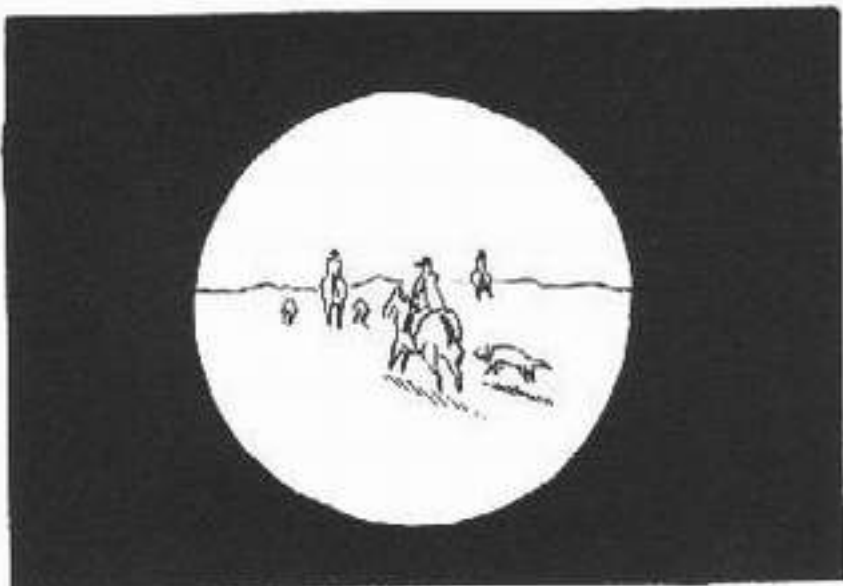

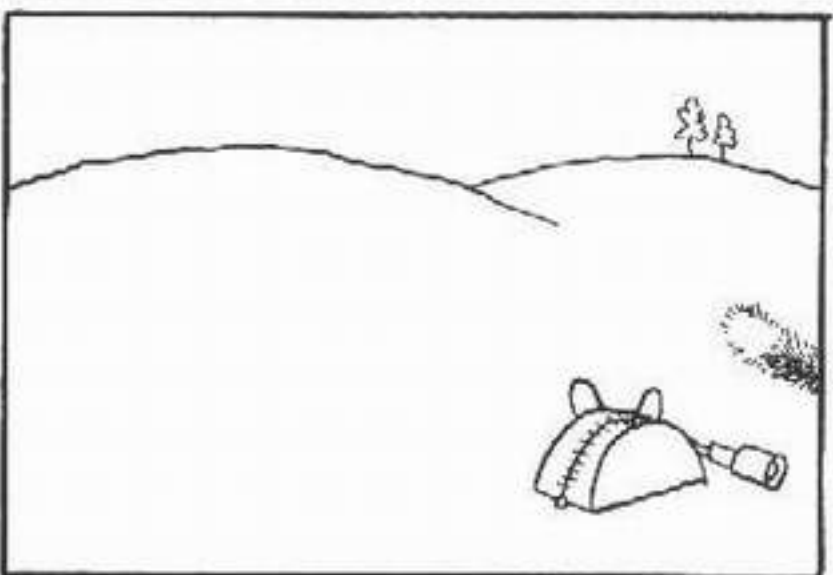
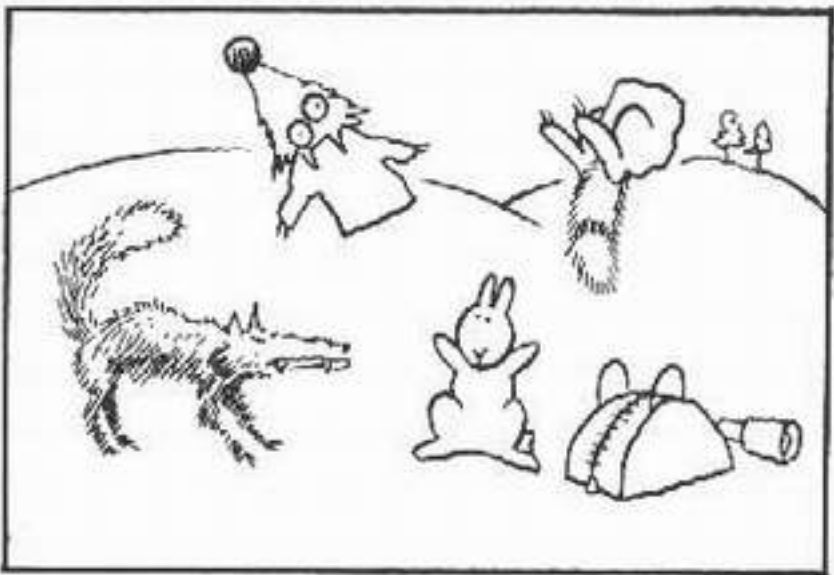
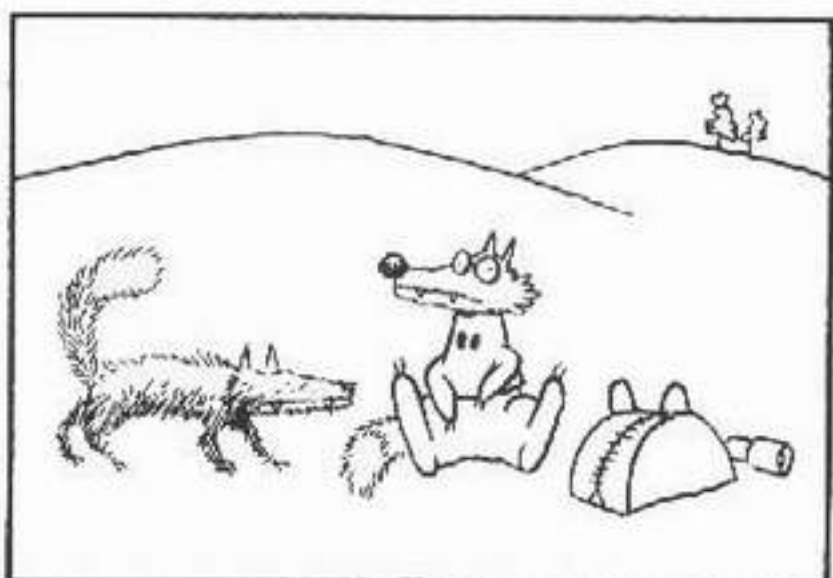
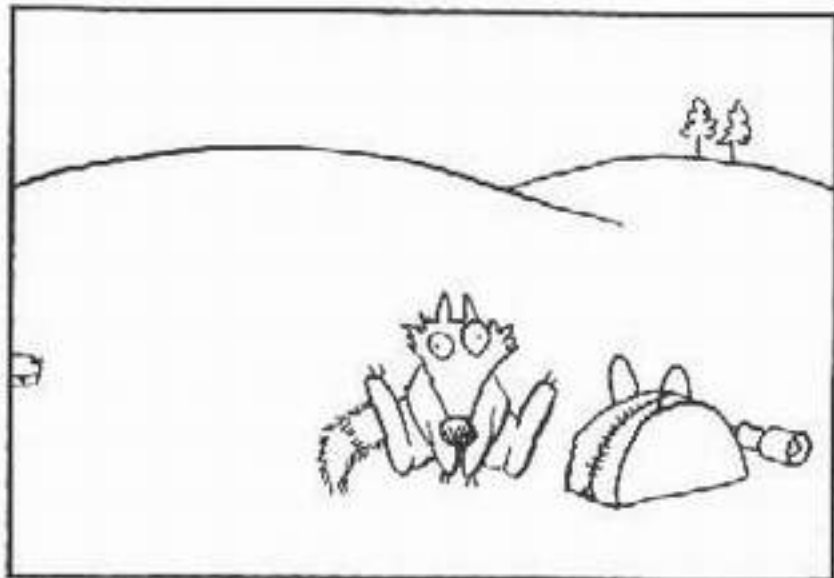

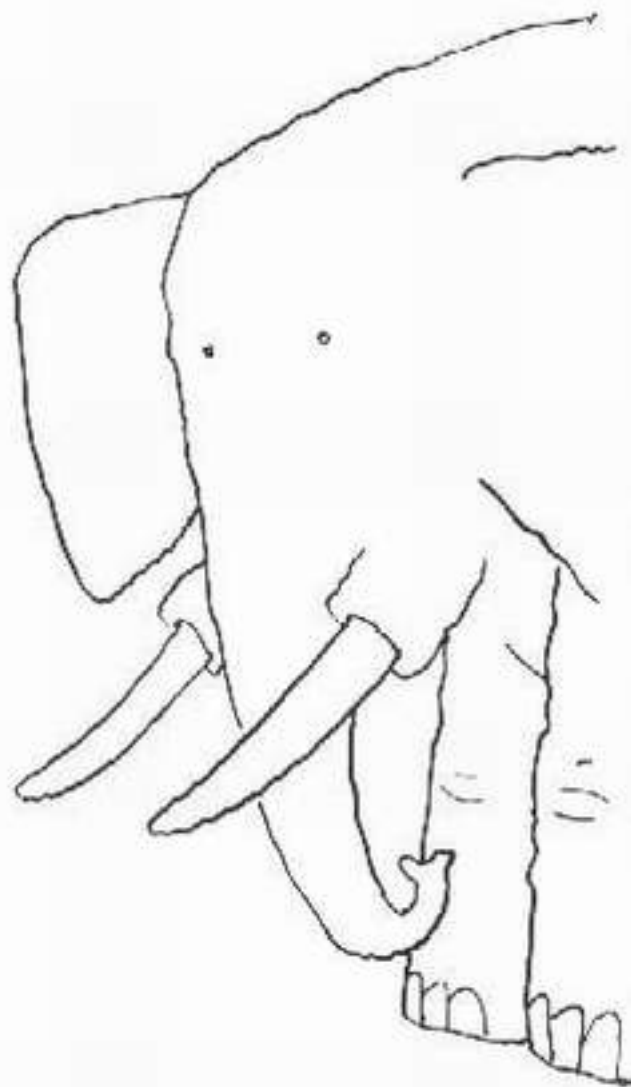
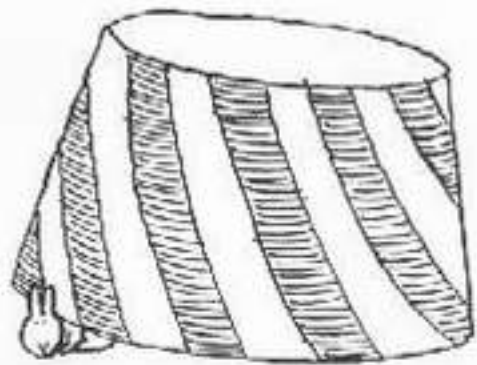

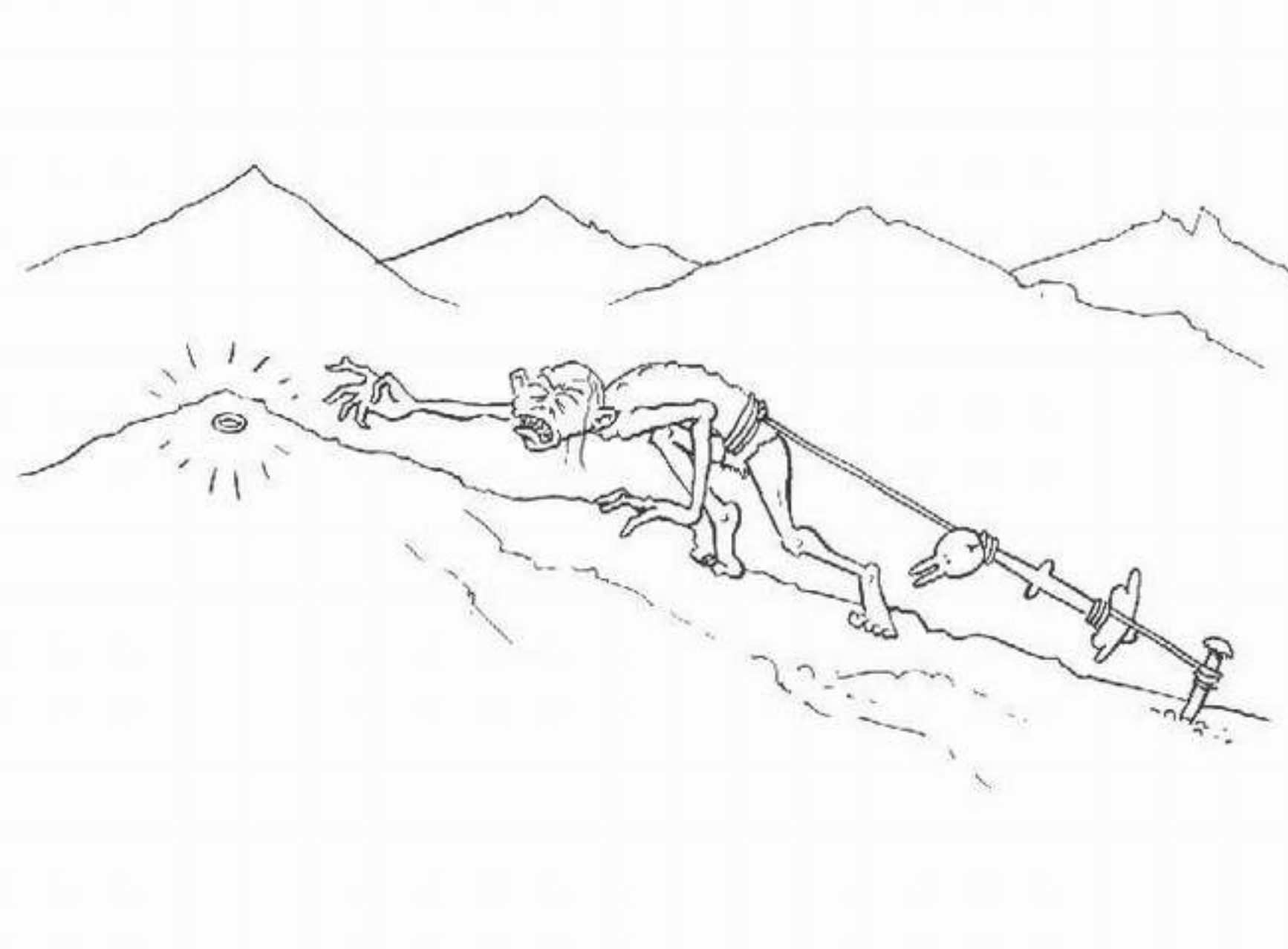

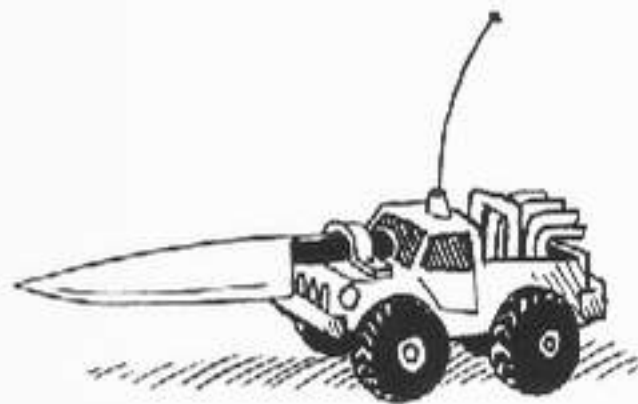
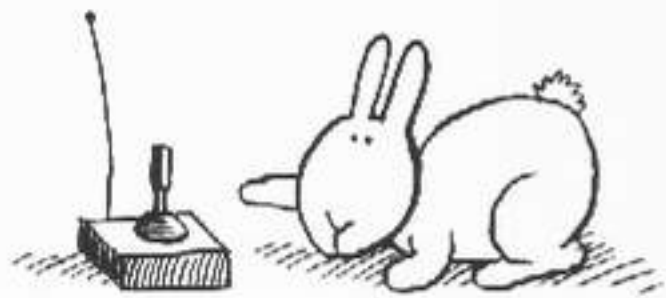

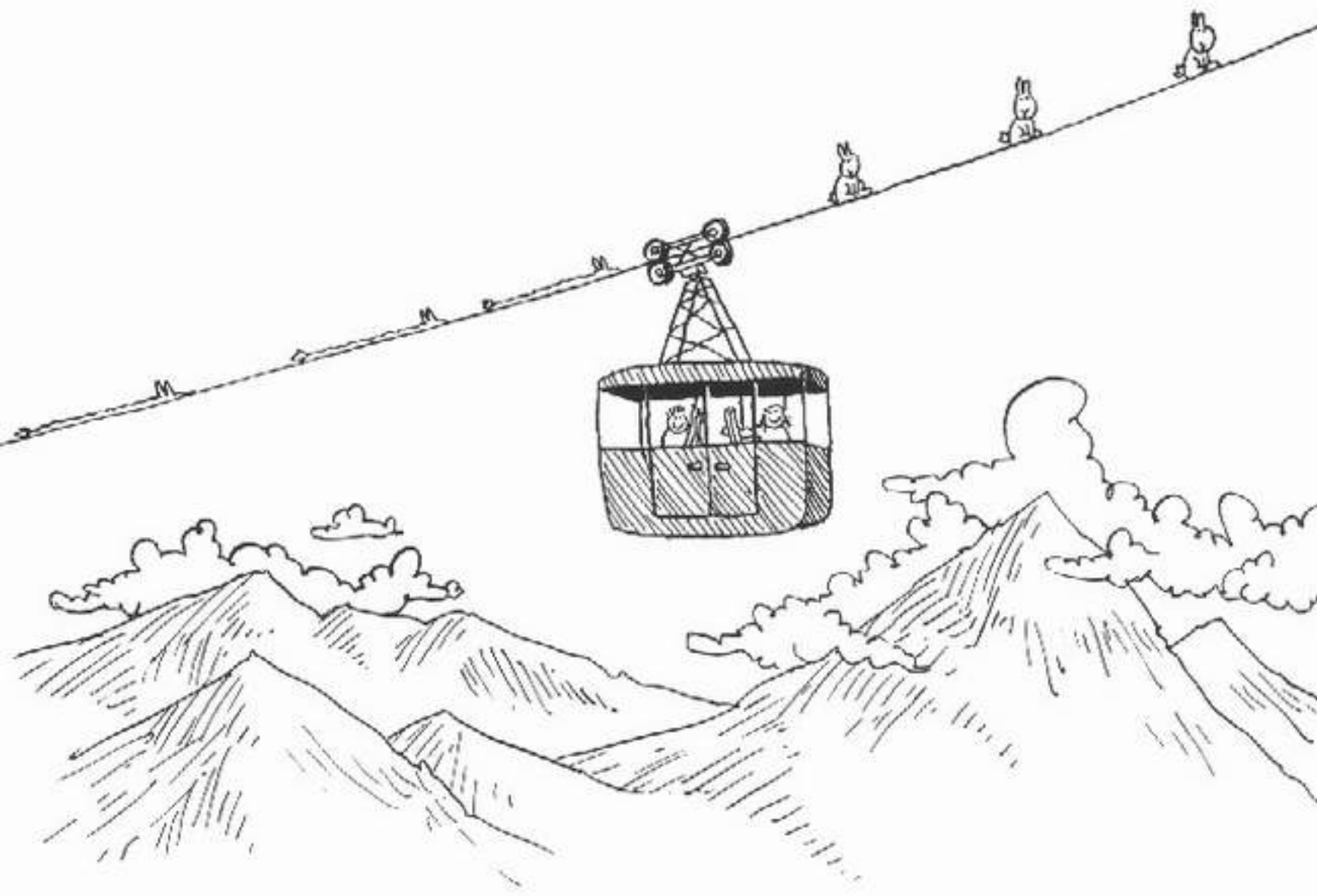



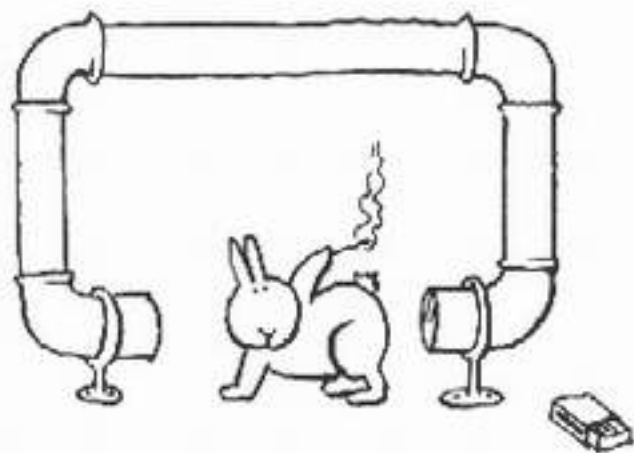
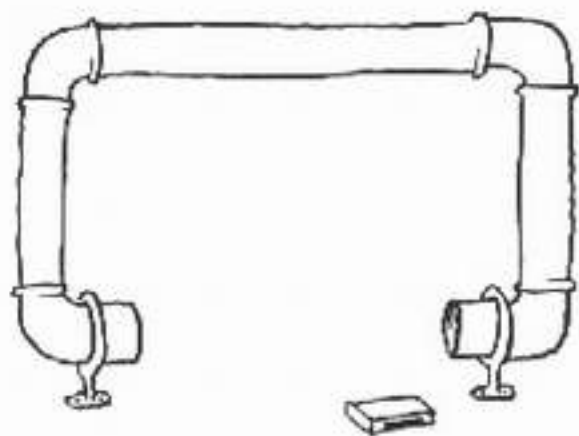

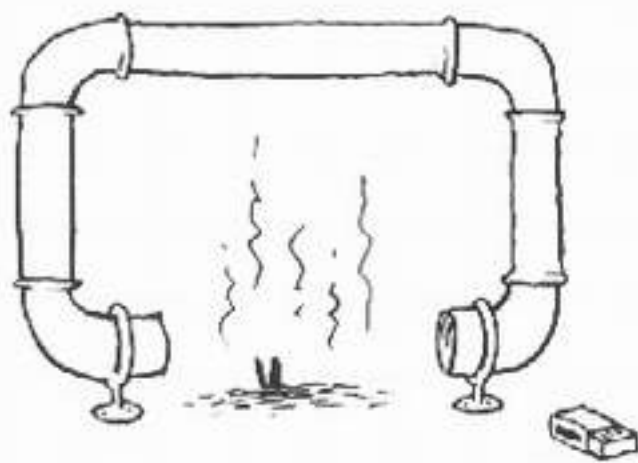
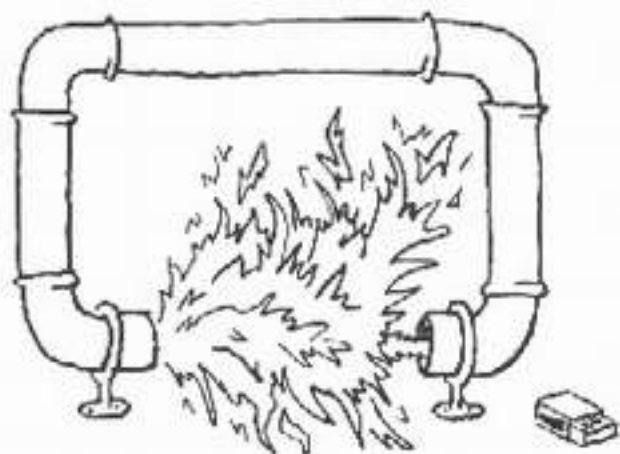

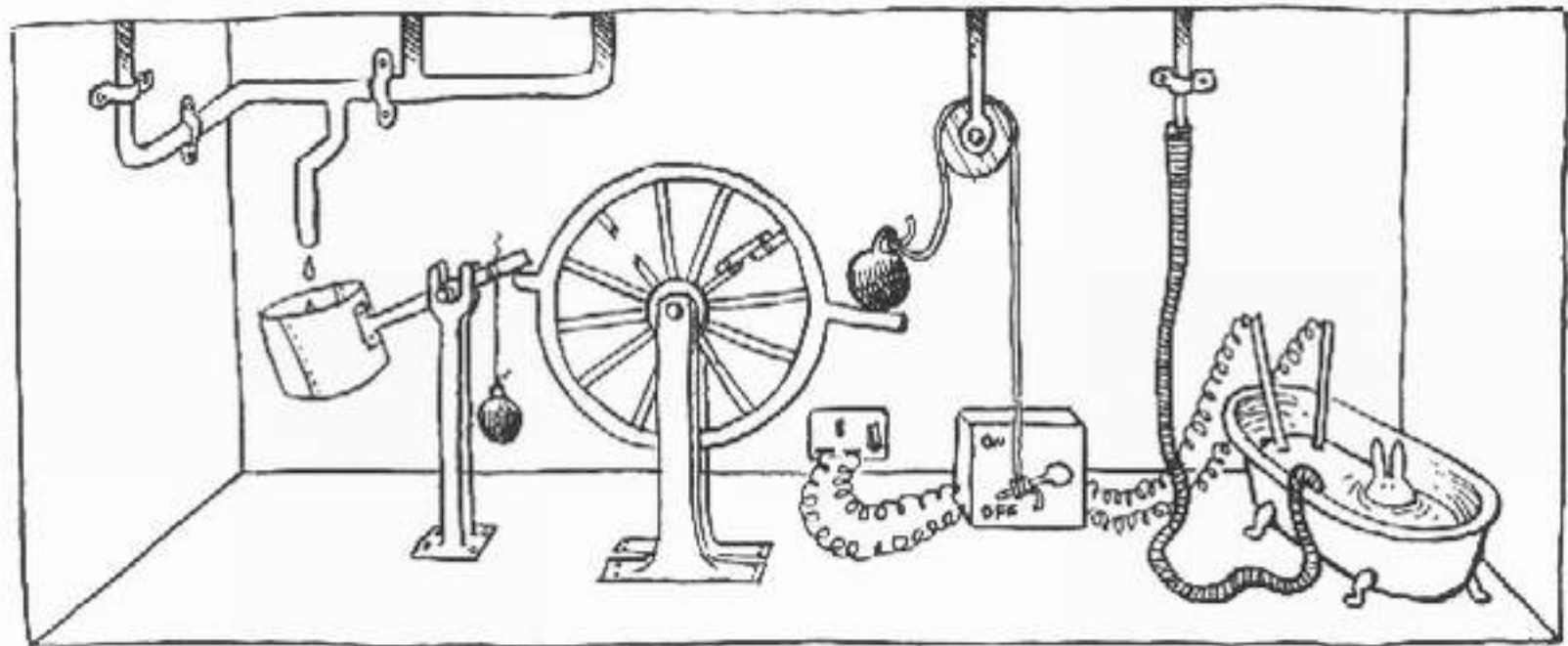
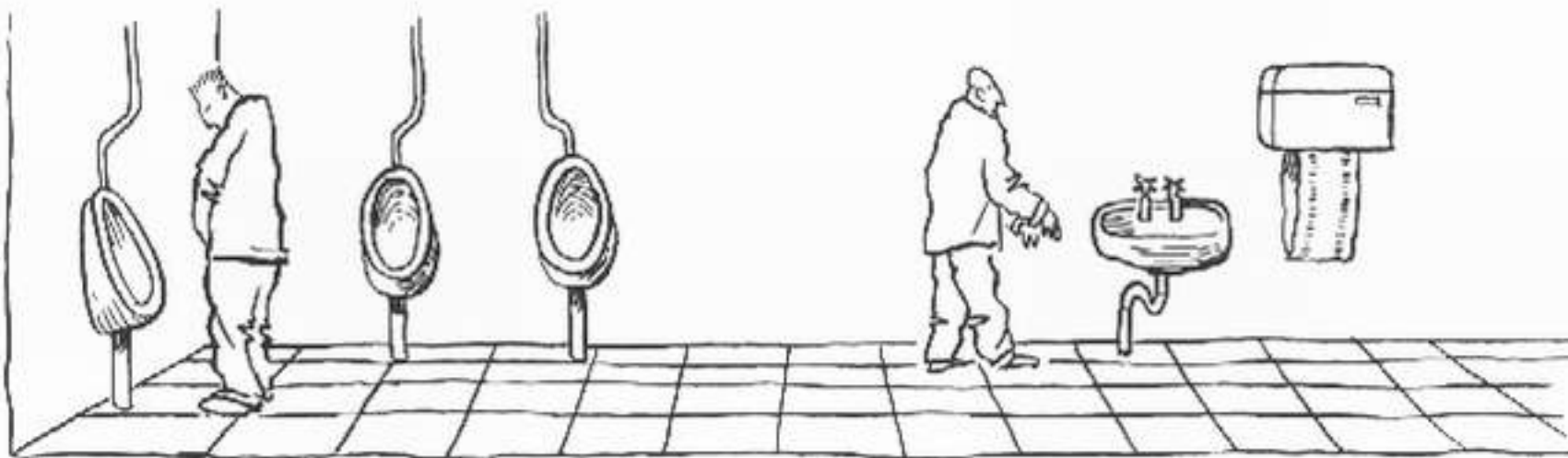

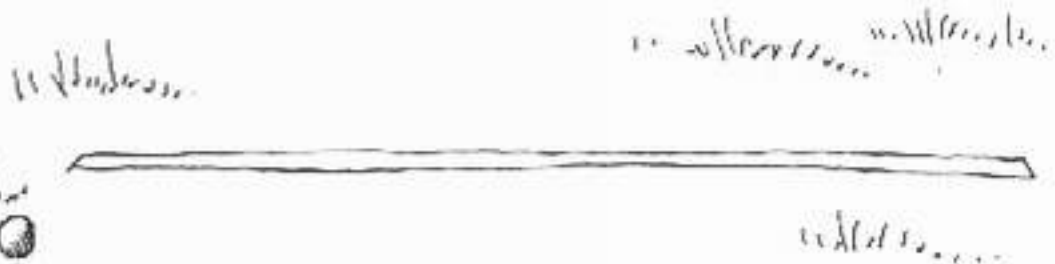
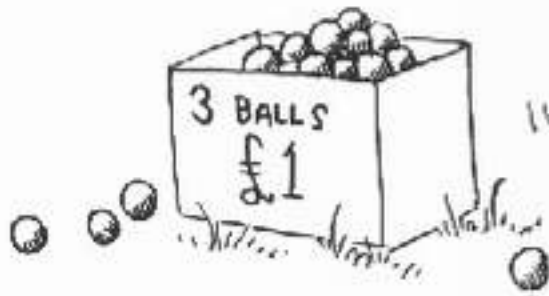
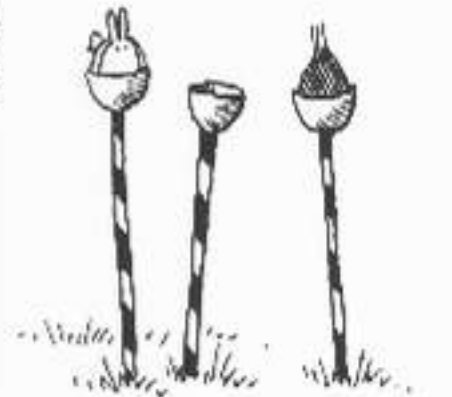

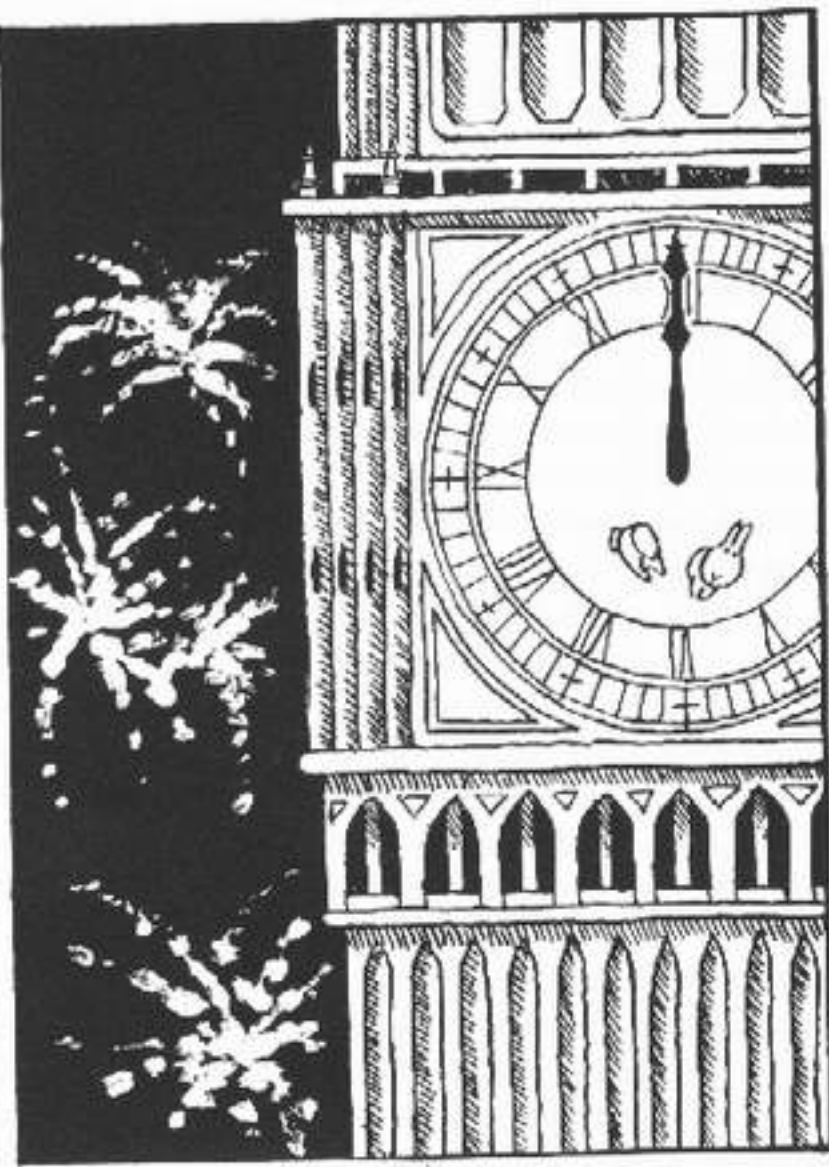
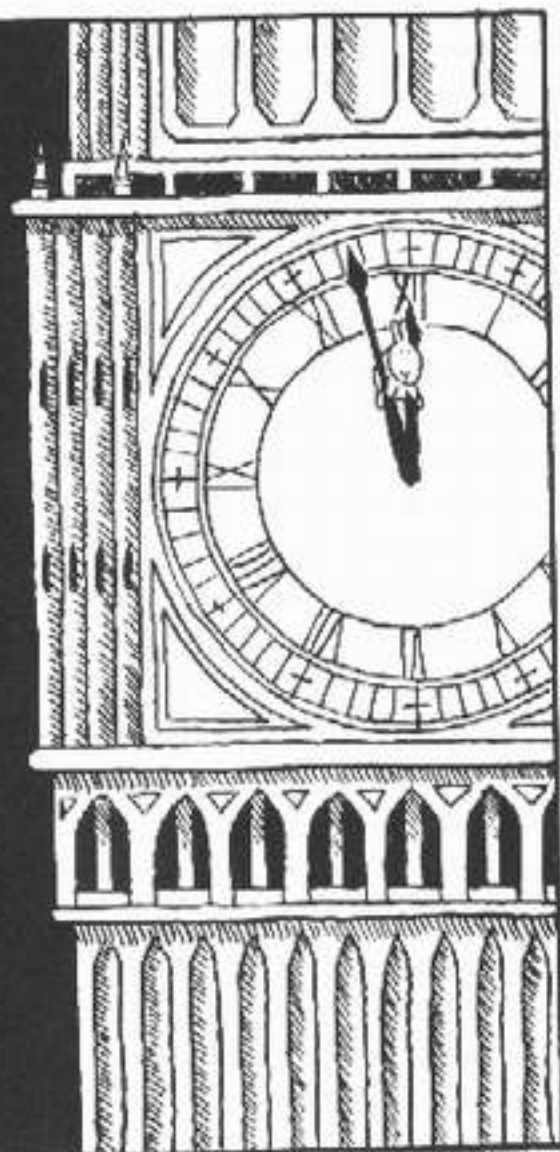



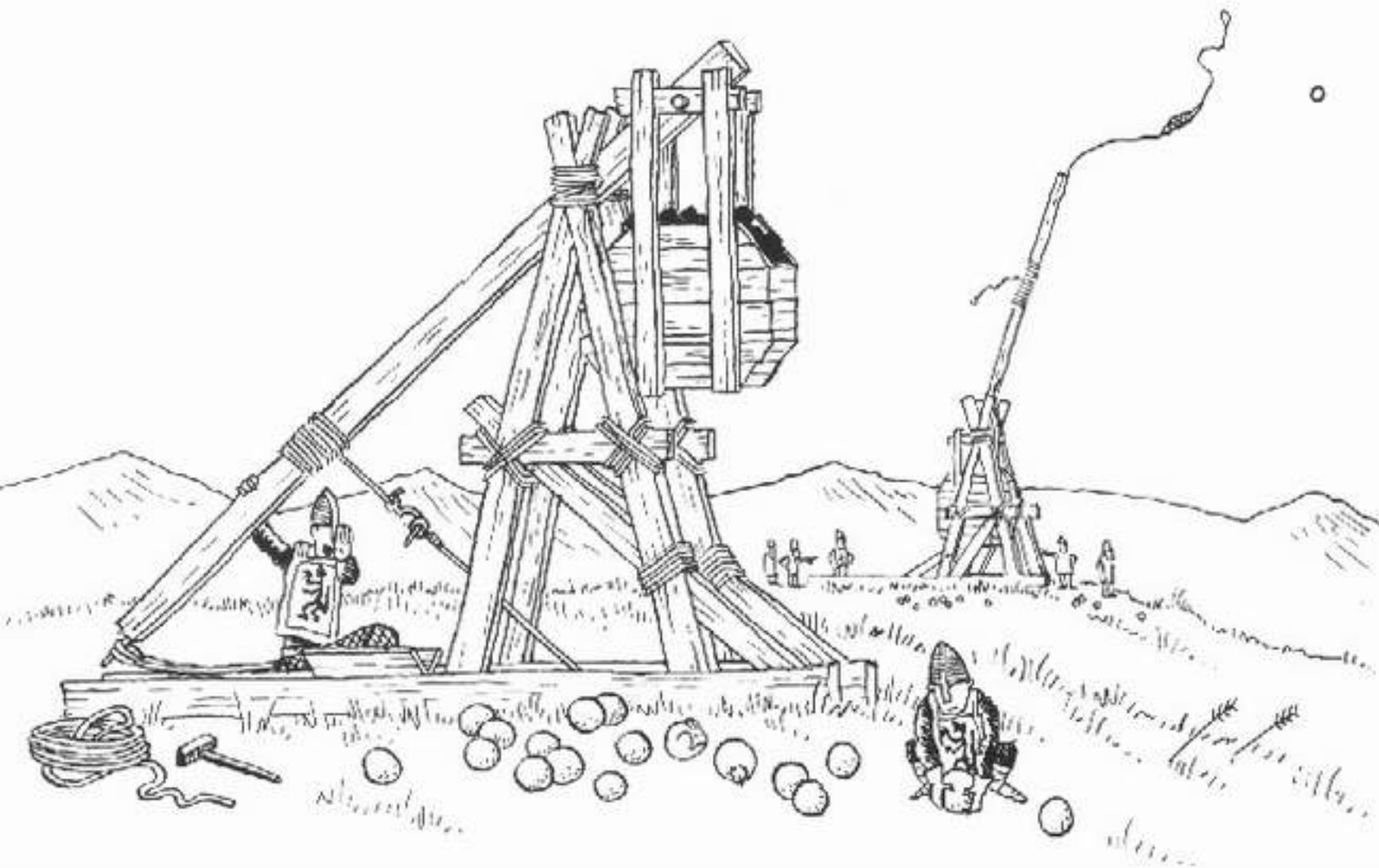

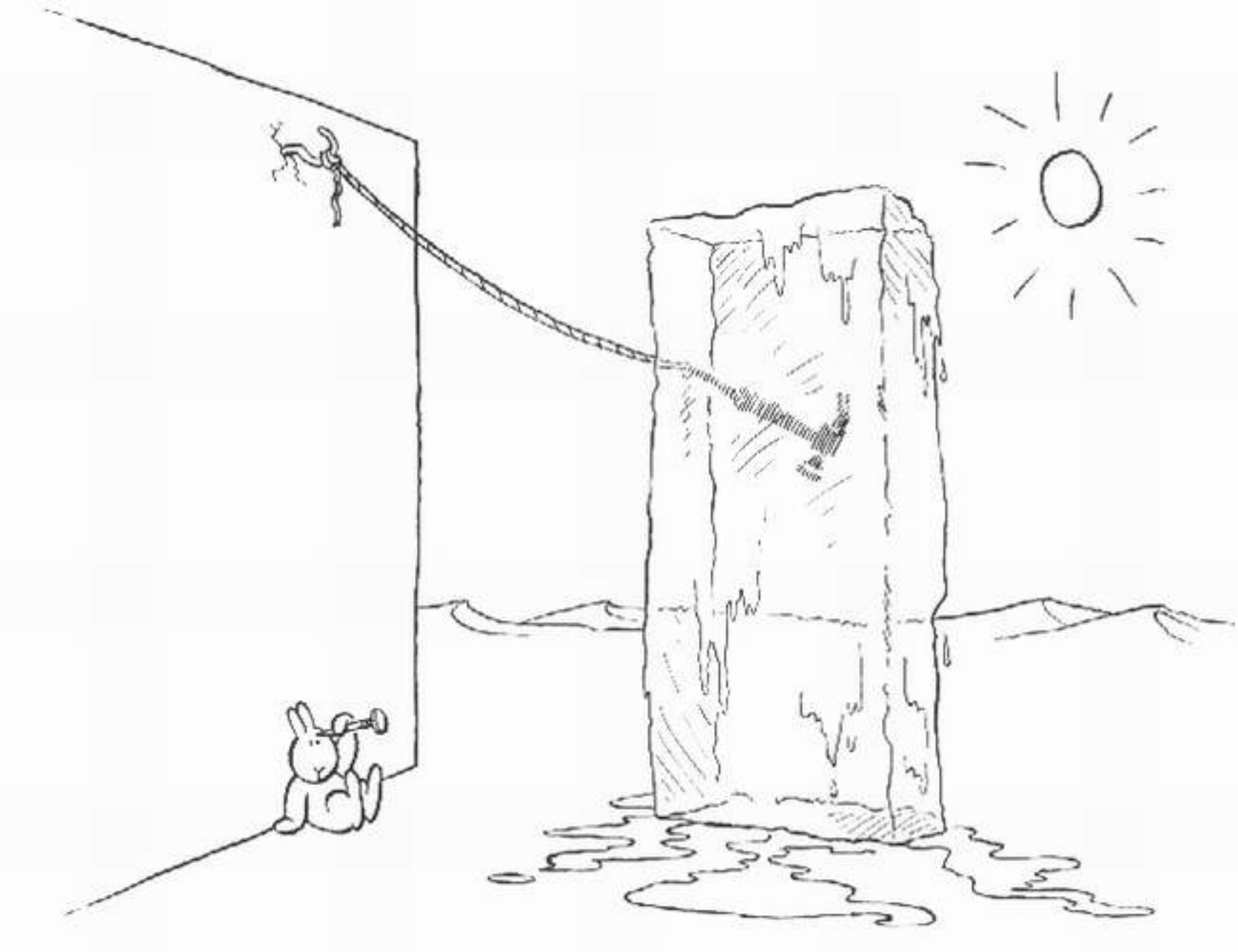



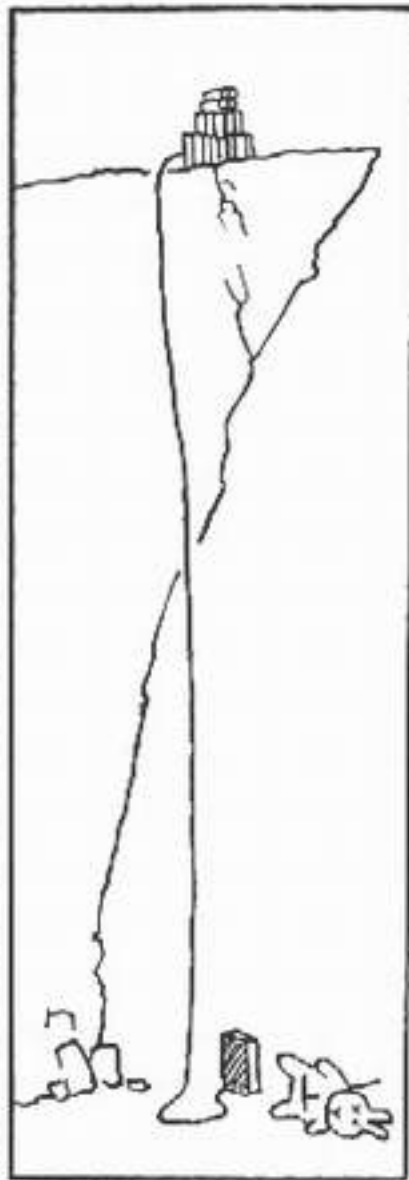
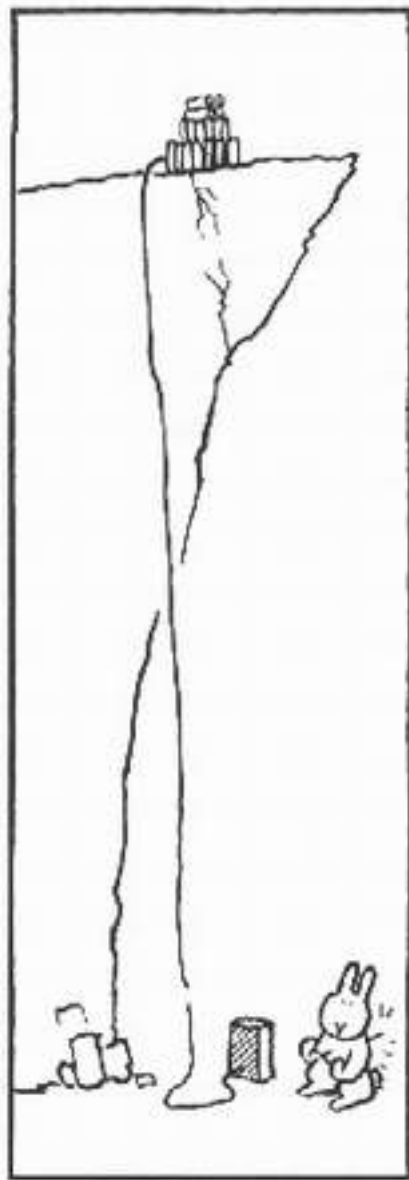
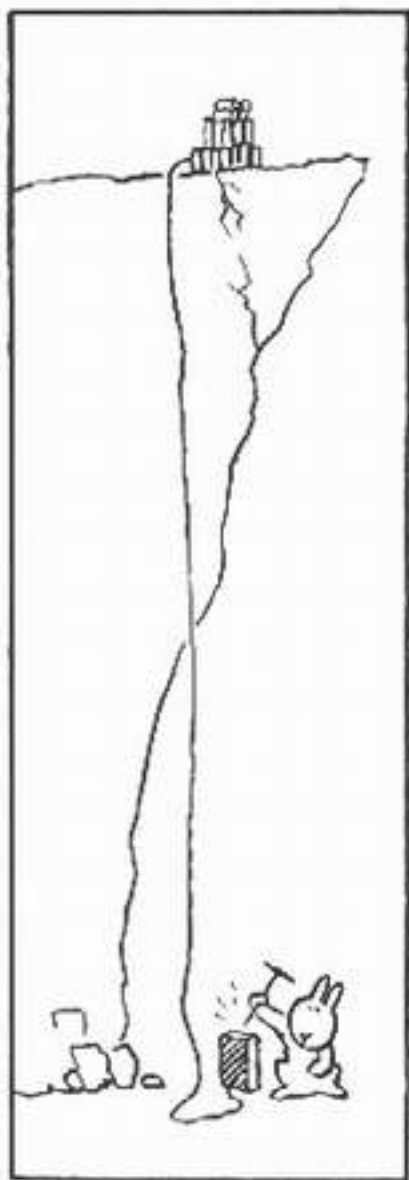
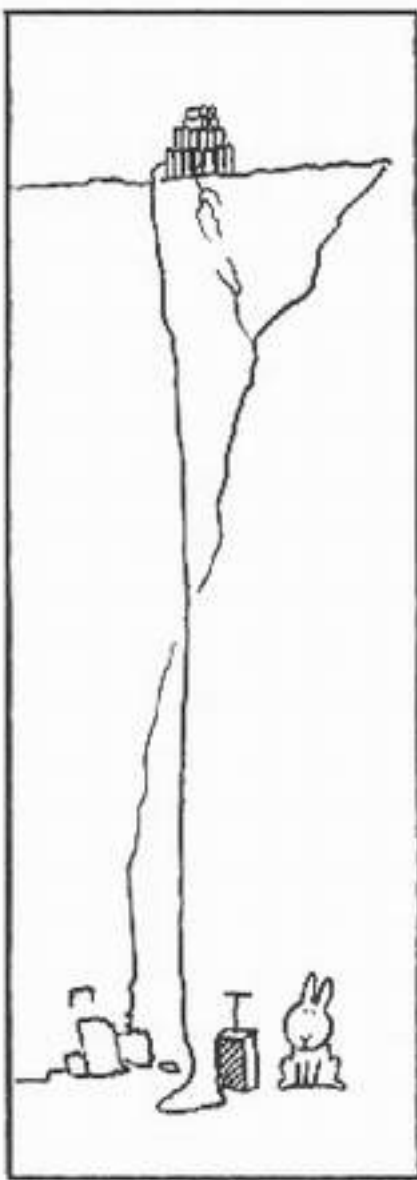

£ 0 1 7 0 0

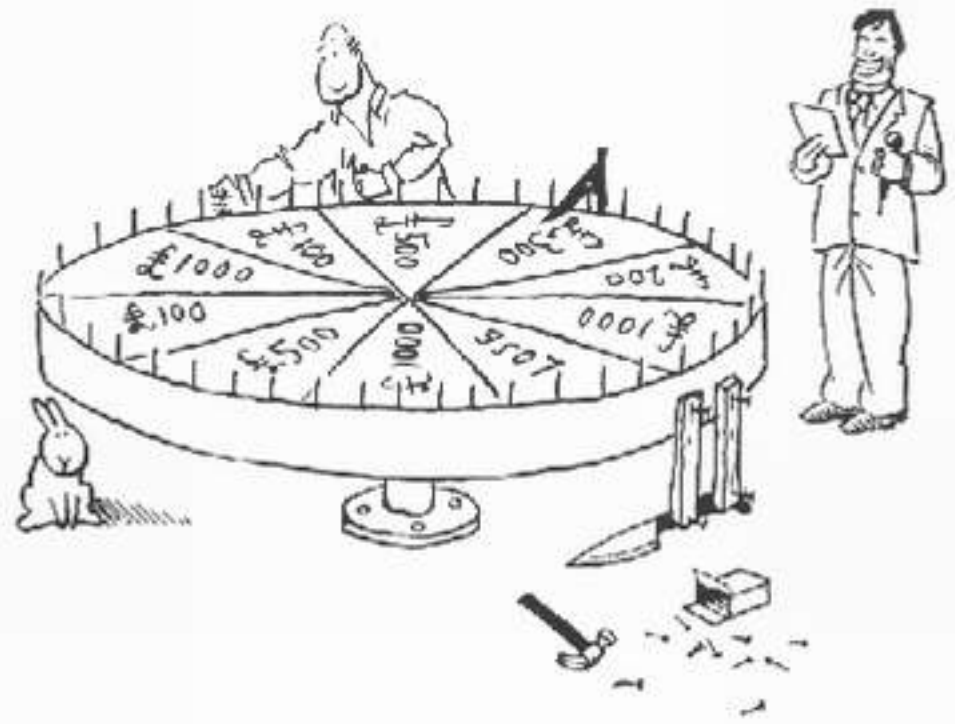







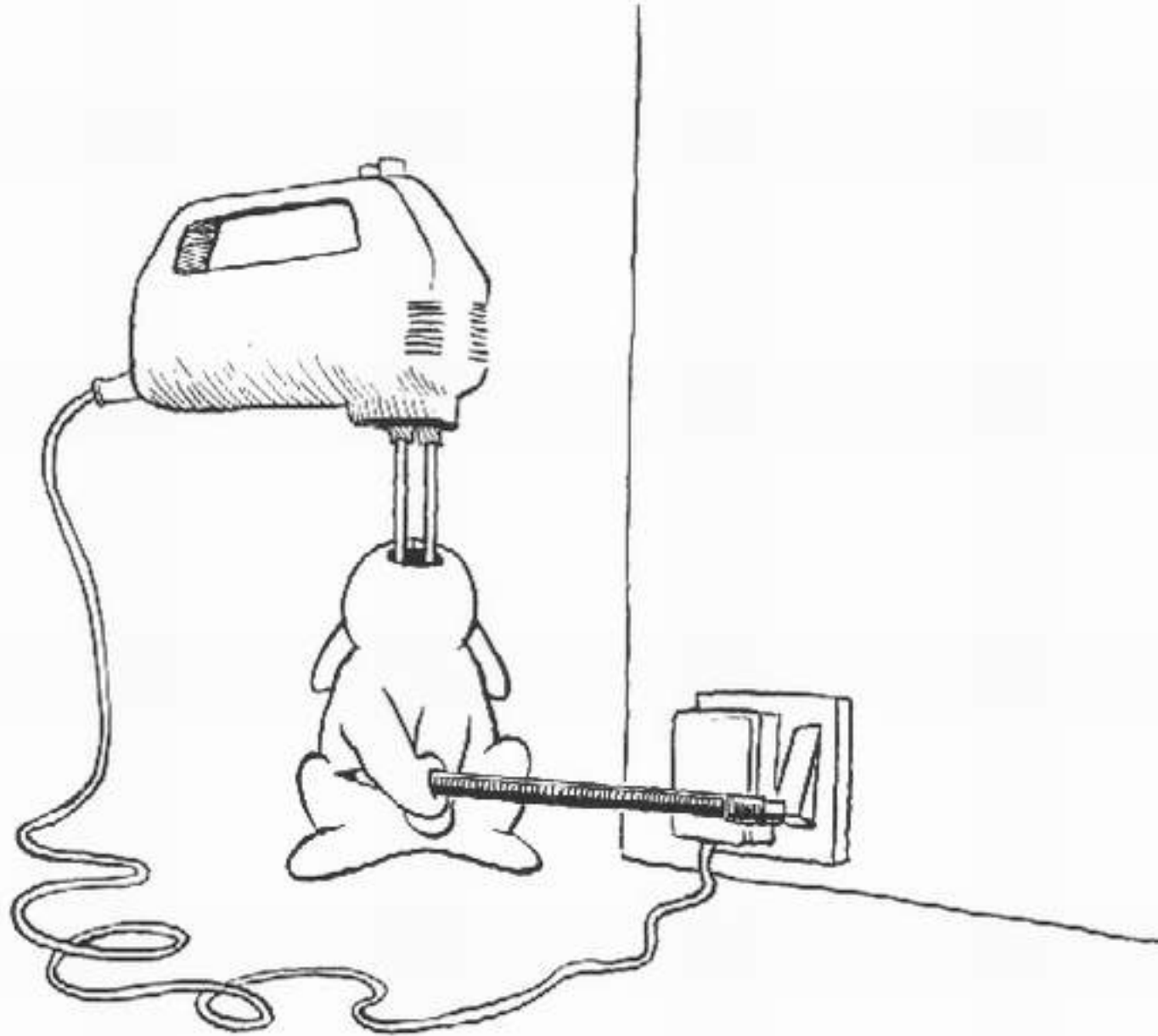

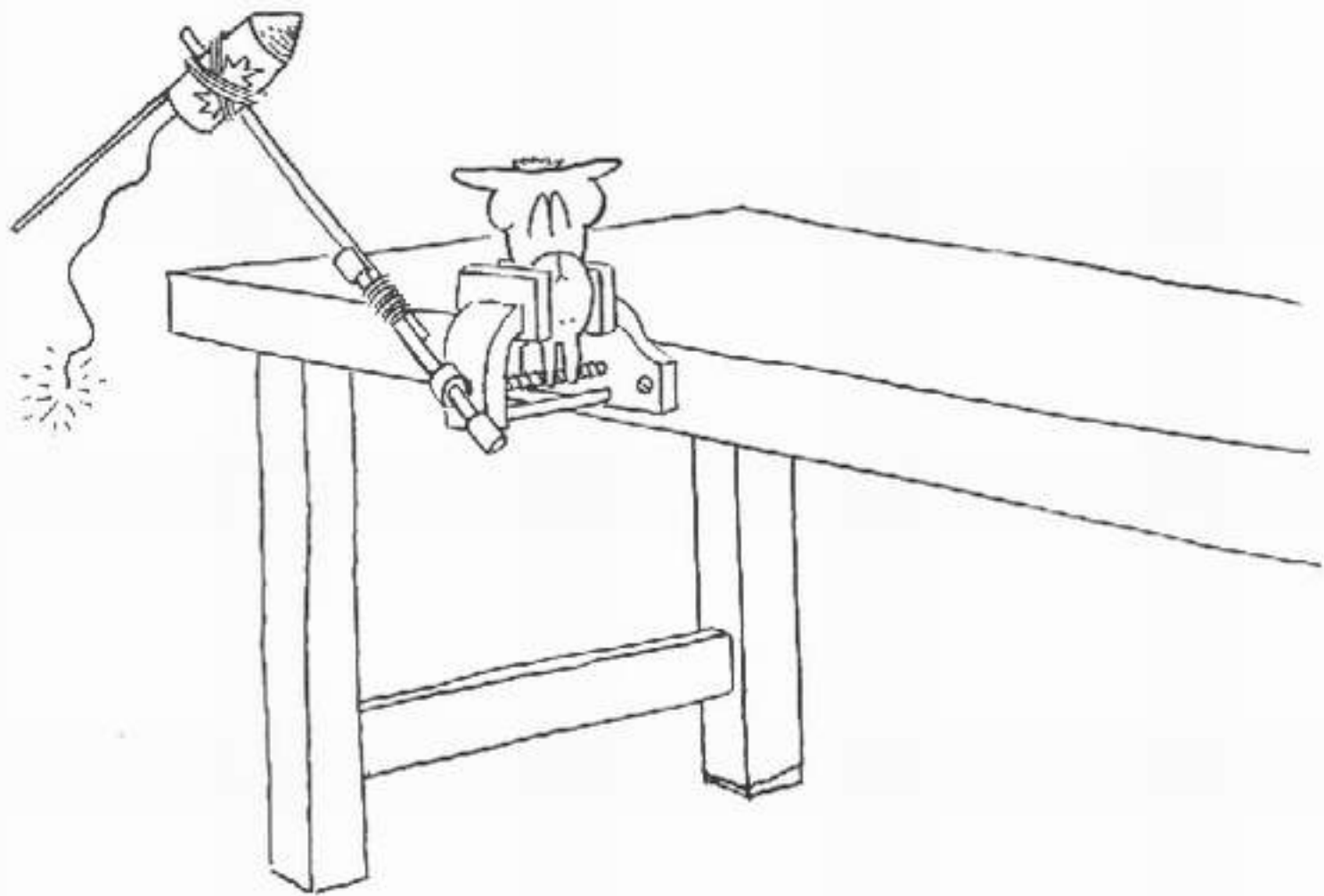





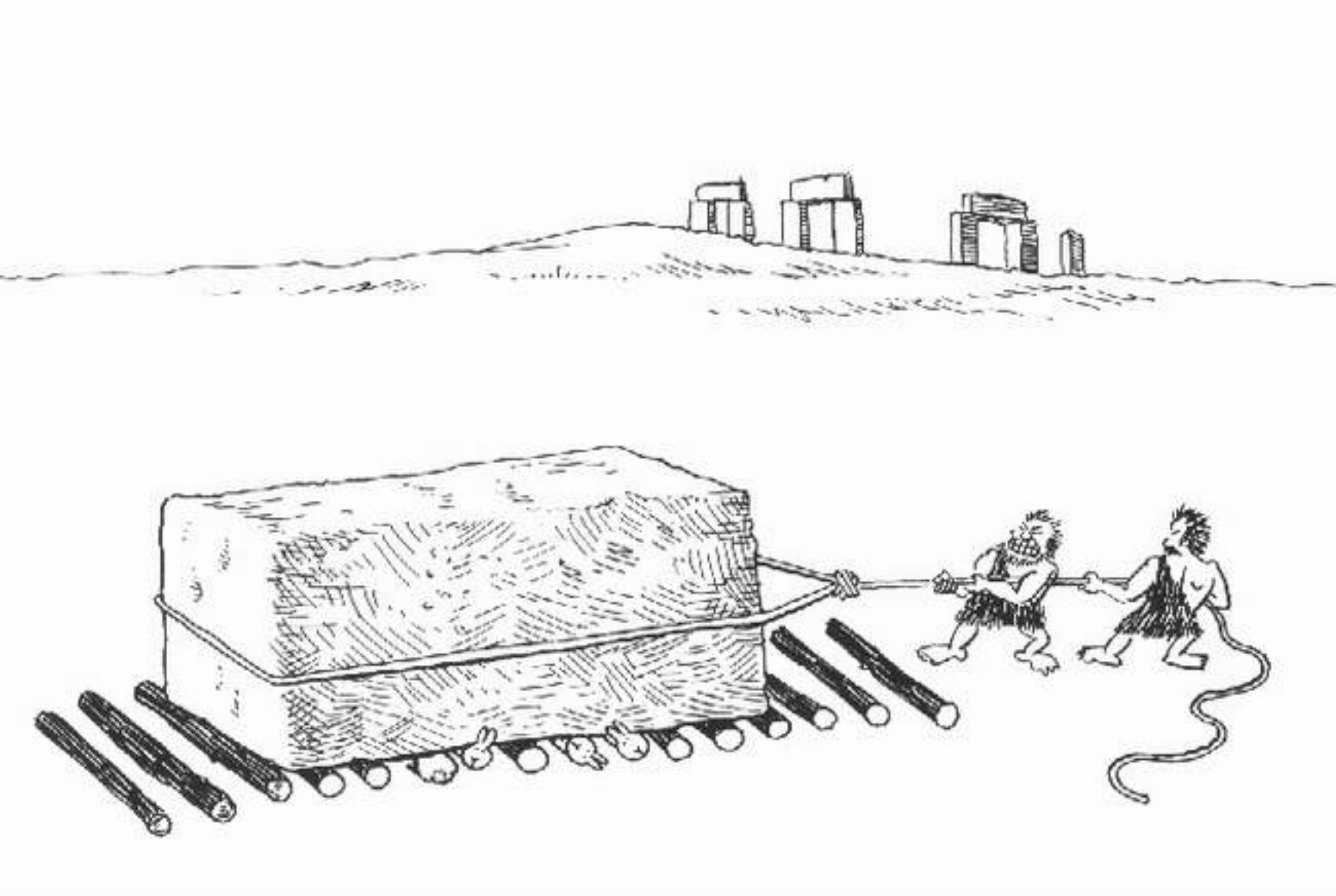

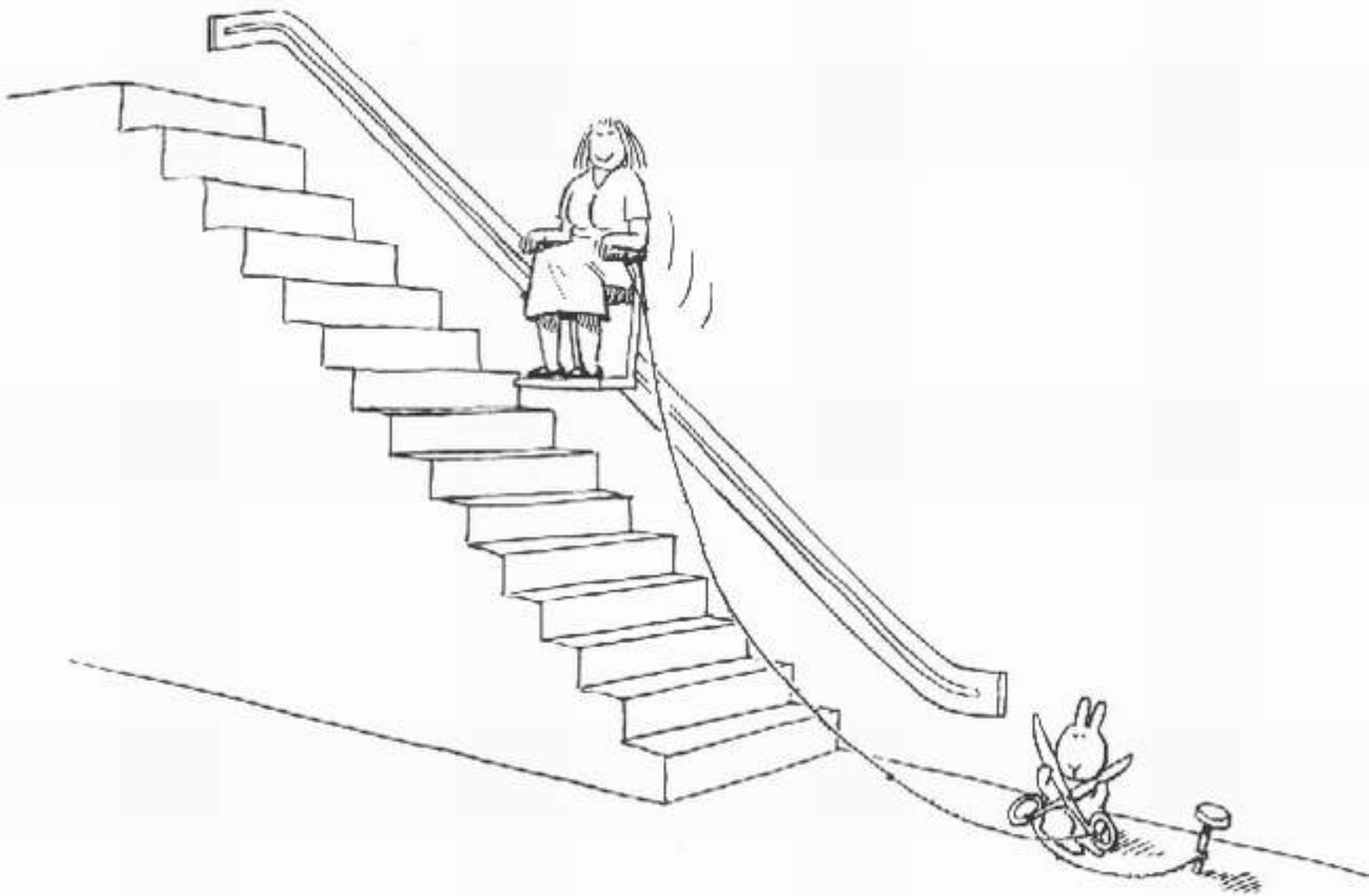

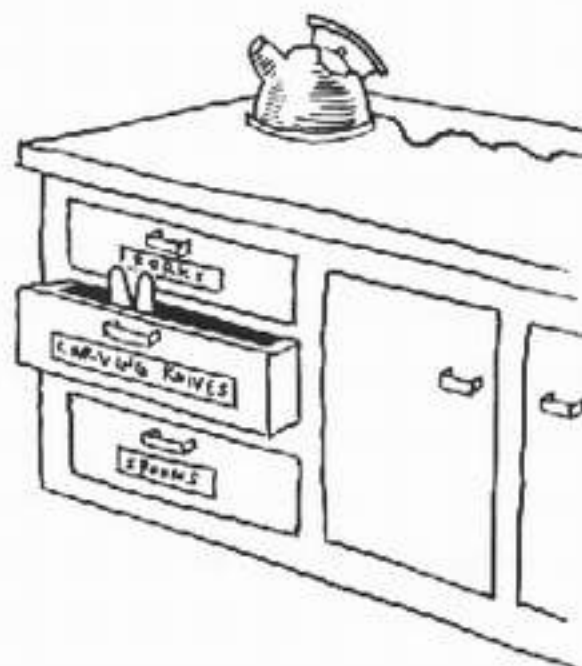

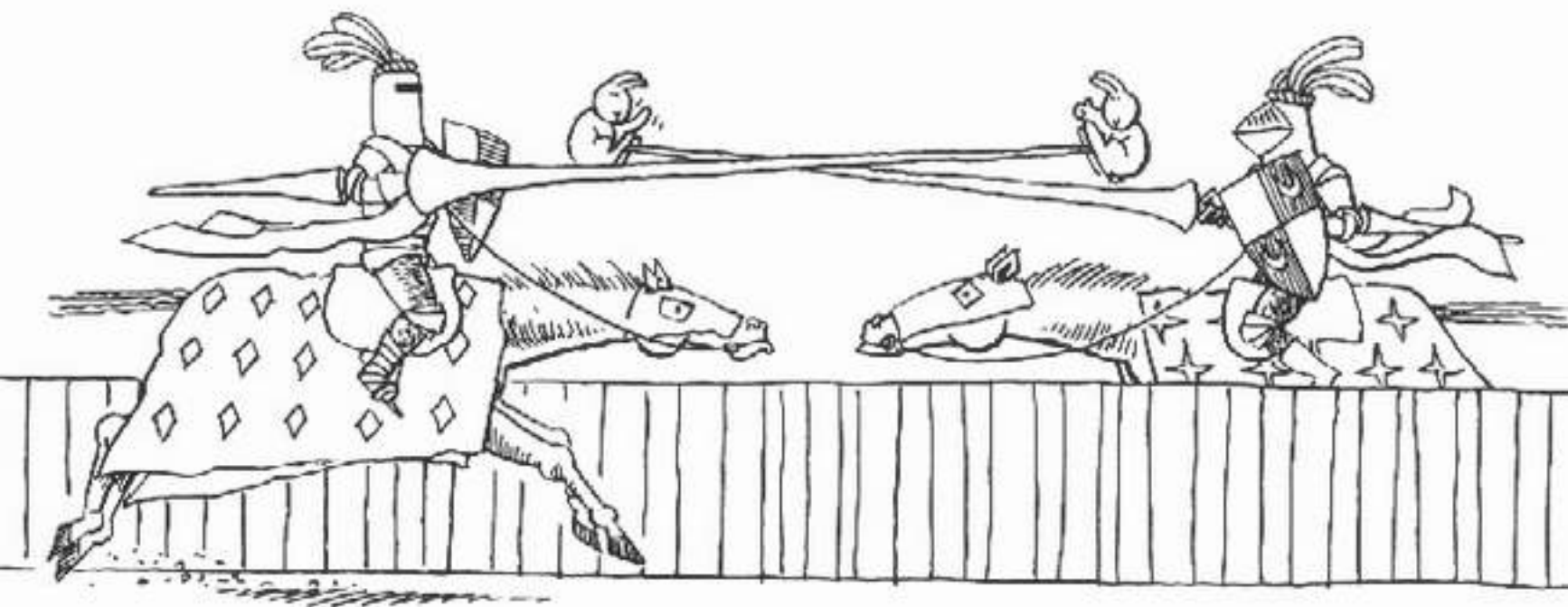

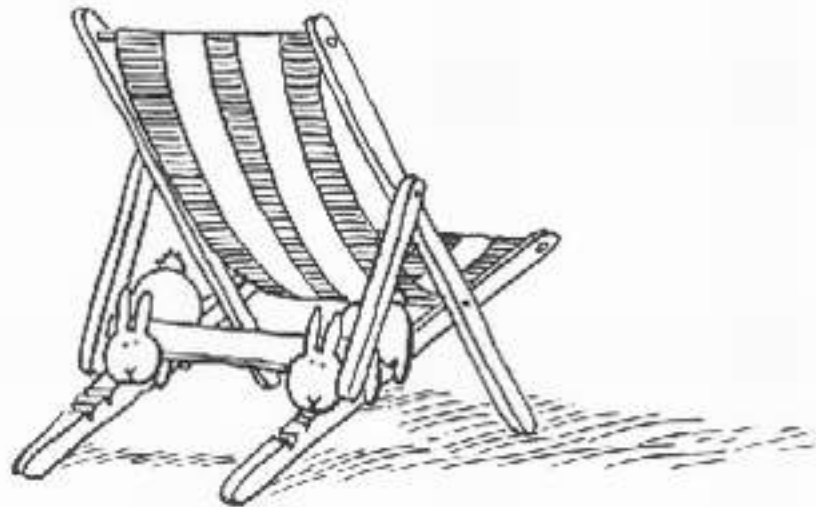

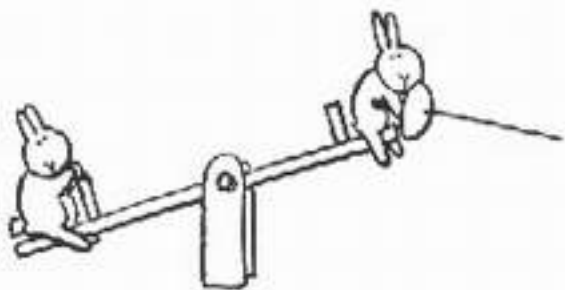
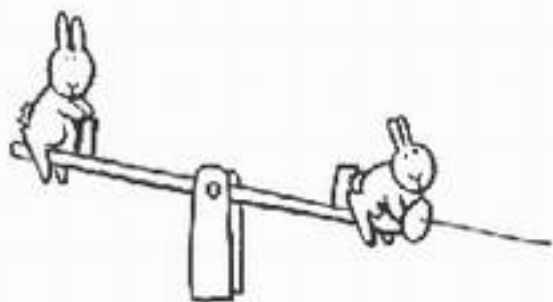

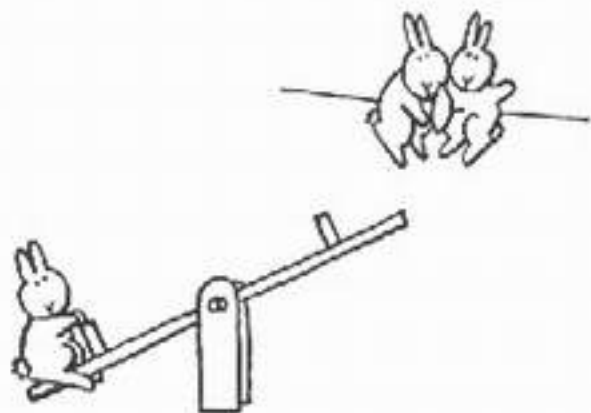
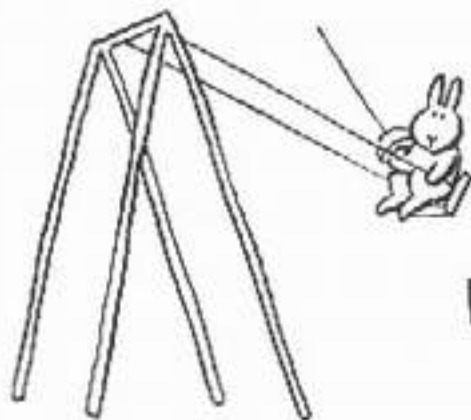
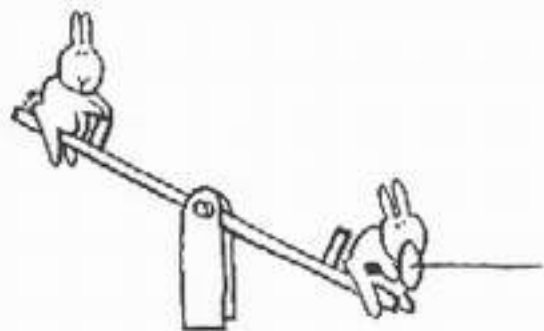

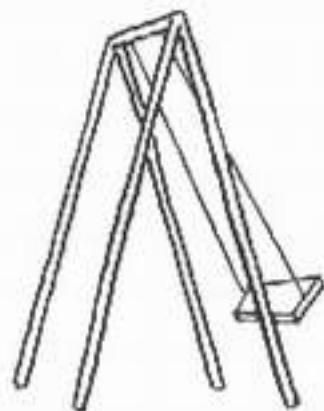
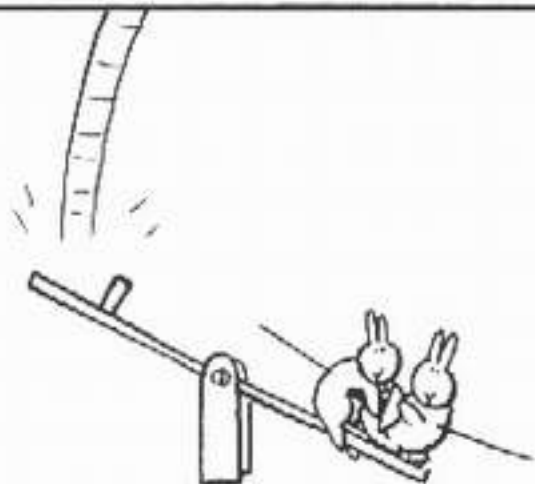



# EPILOGUE

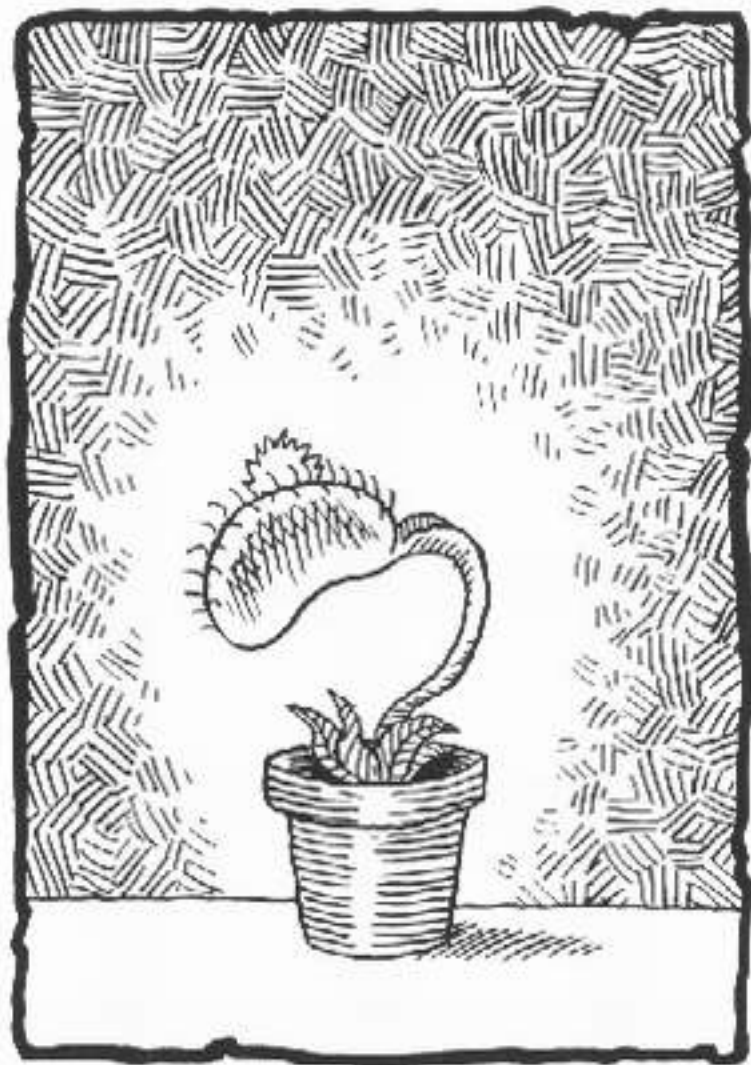

PRAISE FOR THE BESTSELLING  
**THE BOOK OF BUNNY SUICIDES**

'IT'S THE FUNNIEST, BUNNIEST BOOK  
I'VE EVER READ' **ELTON JOHN**

'ONE OF THE MOST IMPORTANT  
BOOKS OF THE YEAR' **HUGH GRANT**



[WWW.MADABOUTBOOKS.COM](http://WWW.MADABOUTBOOKS.COM)

ISBN 0-340-83404-8



9 780340 834046

€5.99