

A History of Rife's Instruments and Frequencies

Updated 10/9/10

This article from its first writing has been an evolving document. When original Rife instruments or schematics have been found it has been updated according to the information that was obtained. This paper is being updated at this time because an original 1938 Beam Rays Corporation Clinical Instrument has been found and analyzed. The analyzing of this instrument finally shows where the audio frequency instruments came from which Dr. Rife used in the 1950s. The last revision of this paper was on 6/4/08 and we will continue to update this paper when new information is obtained about Dr. Rife's instruments.

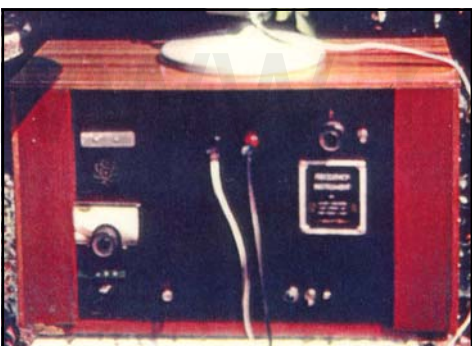
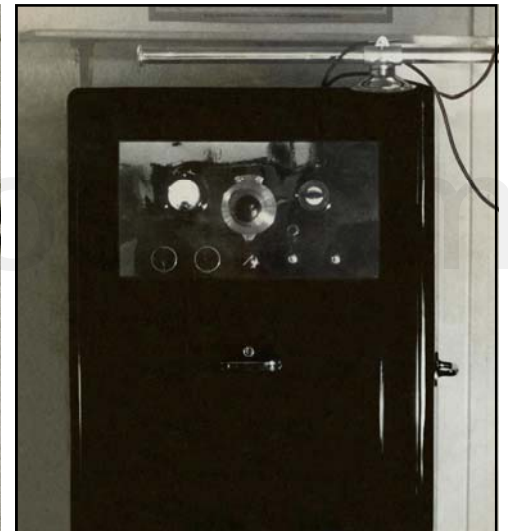
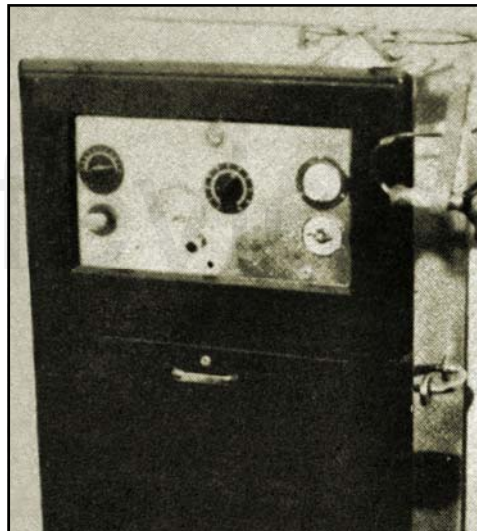
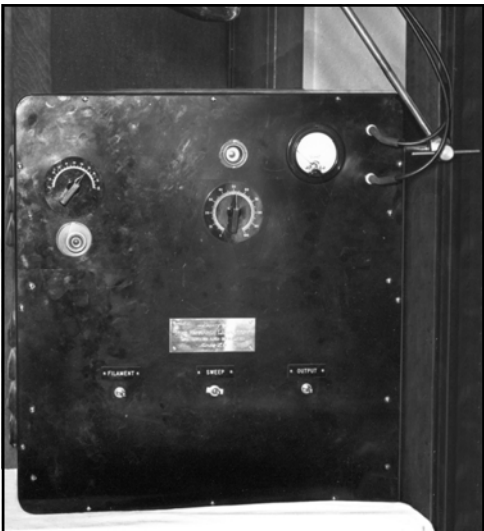
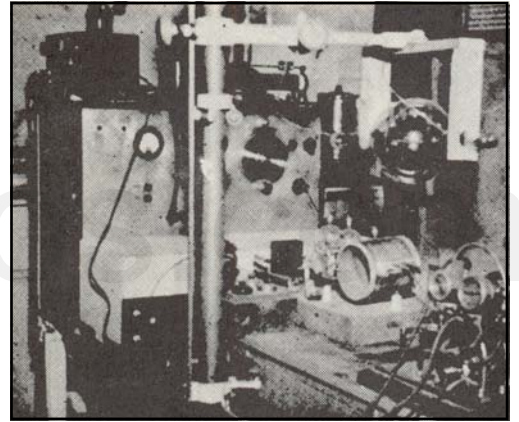
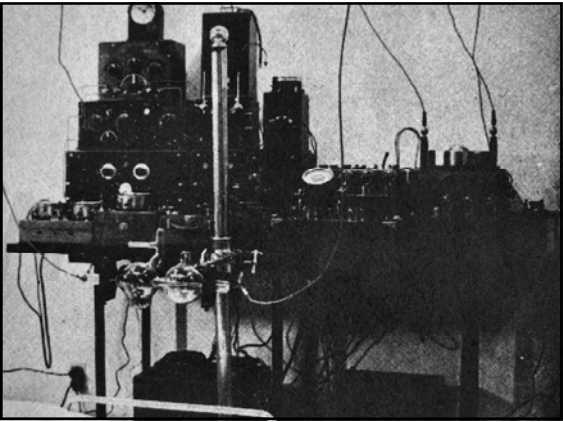

In this article we will examine the way Dr. Rife's instruments were built. We will look at the evidence by quoting the sources such as Dr. Rife, John Crane, John Marsh, Dr. Couche, Dr. Lara, Dr. Stafford and Bertrand L. Comparet (Dr. Rife's attorney in the 1939 Beam Rays Corporation trial, and later John Crane's attorney for Life Labs' trial in 1961). Hopefully anyone who reads this article will

have a better understanding about Dr. Rife and the methods he used. Our goal is to try to give people information so that they will know how Dr. Rife's equipment worked so that they will not be fooled by all the misinformation that has been published on this subject. This will be explained in layman's terms.

What is a ray tube and how does it work?

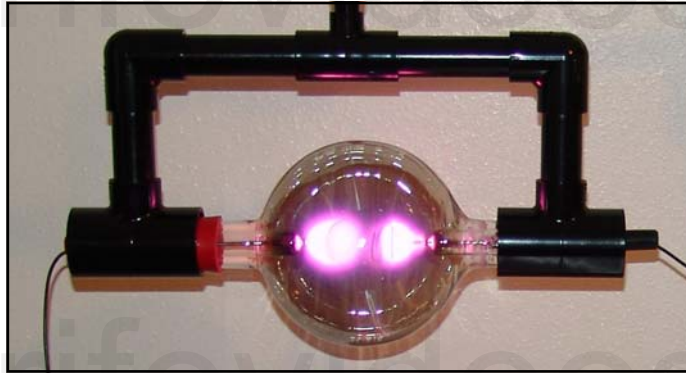

Dr. Rife used a ray tube with his instruments. A ray tube was made out of glass, quartz or Pyrex and was filled with a noble gas or a mixture of noble gases. Dr. Rife used different mixtures of gases but finally ended up using only helium. He stated:

RIFE: *"We have experimented with various inert gases and we found that helium stood up by the bombardment better than any of the other gases. That's why we use it. We don't care about the color or anything of that sort. It stood up better over many more hours of bombardment than the argon and the crypton and those different gases that we tried."* ([John Marsh Collection, Gonin and Siner Papers, Pages 25 & 26. www.rife.org](#))

The ray tube was connected to the instrument by two wires. These wires were connected to two round metal bars that went into the glass tube and they had round disks connected to their ends. One disk was straight and the other one was on a 45 degree angle. This gave it a directional effect towards the patient. Dr. Rife stated that the ray tube was "a partial directional antenna". Because the scientific technology behind ray tubes had already been perfected, Dr. Rife worked with that technology and only had to make some adjustments for it to work the way he wanted it to in his applications. Bertrand L. Comparet, Dr. Rife's attorney, stated in an interview:

COMPARET: *"Now, the original instrument had a tube, like an X-ray tube. That was the way in which Rife developed it. You see, all the X-ray work necessarily was done with a beam projected from a tube. So, Rife worked on the same basis."* ([1970's Bertrand Comparet Interview #32](#))

There are limitations to ray tubes that need to be understood which have to do with the laws of physics. This is a simple explanation but should suffice since we are trying to stay in layman's terms and make it easy to understand. Ray tubes when properly tuned are very efficient. About 95% of the energy that you put into a ray tube comes out but only if the impedance is matched properly. Dr. Rife's #3 instrument put out about 50 watts. This means about 50 watts came out of the ray tube. When it comes to metal antennas and an output of 50 watts you have to divide the 50 watts that come out of the metal antenna by four for every foot that you move away from the antenna in order to take into account the laws of physics on signal loss. The exact power loss in the output of a ray tube is not known, but for our illustration in this article we will use the standard loss with metal antennas as the power loss ratio for a ray tube. Therefore, at one foot away from the ray tube you only have 12.5 watts. At two feet you only have 3.125 watts and at 3 feet you only have about .78 of a watt. The laws of physics are important to understand because Dr. Rife and the doctors that used his equipment put the ray tube within a few inches of the patient's body. Dr. Couche said that he would sometimes touch the body of

the patient in the area that needed to be treated. When we discussed this with Dr. Robert P. Stafford, he said that when he treated cancer patients he would put the ray tube within a few inches of the body and treat a 6 inch square area. He would move the ray tube up and down and back and forth so that the whole 6 inch area was treated. He said that he did this because of the way the phanotron (ray tube nickname) ray tube worked. The design of a phanotron ray tube makes it partially directional and concentrates its energy or power into a small area. With the power loss from the ray tube it is easy to understand why Dr. Stafford, Dr. Couche, Dr. Rife and the other doctors used the ray tube right next to the body.

We built both the Aubrey Scoon Beam Rays replica ray tube instrument and the 1950's AZ-58 Beam Rays replica ray tube instrument. The AZ-58 (a 1950's Rife instrument made by Life Labs) was built from schematics that are on Stan Truman's site, <http://www.rife.org>, under AZ-58 research information. This AZ-58 instrument is nearly the same as the original Beam Rays instrument and schematics can be found at <http://www.scoon.co.uk/Electrotherapy/Rife/BeamRay/index.htm>. Both Aubrey Scoon's instrument and the original Beam Rays instrument we have use sine wave audio frequencies and the 1950s AZ-58 uses square wave audio frequencies. We tested the AZ-58 and Aubrey Scoon's replica for penetration and found that at about 32 inches from the body full penetration of the carrier frequency emitted from the ray tube was lost. John Crane listed the AZ-58 as outputting 50 watts out of the ray tube but we tested it and found it only puts out 40 watts. The 1940s Aubrey Scoon instrument puts out about 40 watts also. The audio frequencies broadcast out of the ray tube from both these machines could only resonate a crystal designed to test resonance through about two inches of tissue. From the tests made, it takes a carrier frequency of at least 0.125 watts to penetrate all the way through the body. It could take an output of 50 watts from a ray tube to resonate a crystal through 14 inches of tissue. These tests showed that it takes more power to penetrate all the way through the body when modulating an audio frequency on a carrier frequency than when a single un-modulated frequency is used. The tests were done using the AZ-58 replica and the Aubrey Scoon replica machine using a phanotron ray tube outputting 40 watts. Another interesting thing worth noting is when we turned the ray tube more than 45 degrees either to the right or the left of center we could not resonate the crystal. Another test showed we could not resonate the crystal at all on the backside of the phanotron ray tube proving what Dr. Rife said: "The ray tube is a partially directional antenna." One interesting fact worth noting is, the ray tubes that do not use the internal electrodes like the phanotron ray tube have a greater output. These ray tubes use copper collars or wire wrapping around the ray tube.

What power levels did Dr. Rife use?

According to the documents we have, Dr. Rife's #4 instrument and the instruments built by Beam Rays Corporation in the 1930's put out from 50 to 100 watts out of the ray tube. The 1950s AZ-58 Life Labs instrument and the Aubrey Scoon 1940's instrument only output about 40 watts. Because some of Dr. Rife's information about instrument power levels is confusing, most have believed Dr. Rife's instruments put out 400 to 600 watts to the ray tube: however, the new information from the building of some of these instruments shows this is not correct. The problem has been that the people who wrote down this information were incorrectly giving the power usage of Dr. Rife's instruments as the output power. Dr. Rife's instruments used 400 to 600 watts but they only output about 50 to 100 watts out of the ray tube. In the paper entitled "*Development of the Rife Ray and use in devitalizing of pathogenic micro-organisms*" it states: "*The frequencies were generated by a tube oscillator with many stages of amplification, the final stage being a 50 watt output tube.*" This part of the description is of his pre-1935 instrument. The output tube was not the ray tube. It appears from the documents that Dr. Rife's pre-1935 instruments did not output any more power than about 50 watts out of the ray tube. He said he lit the tube from another power source then input the frequencies into the ray tube. When Dr. Rife, John Crane and John Marsh were working on sea water conversion - a process that used frequencies - they boosted the output power in the instrument. Concerning that instrument and some 1930's Beam Rays instruments that Dr. Yale had increased the power level on, Dr. Rife said the following:

RIFE: *"Now this outfit here - the way we have it boosted up here now with an extreme lot of power behind the actual output that is coming out of the thing...I wouldn't want to use this - or I wouldn't want to use this instrument here the way it is souped up there for this salt water proposition to treat a patient with."*

GONIN: "No."

RIFE: *"You can get beyond the limit."*

GONIN: *"Yes, quite."*

CRANE: *"That's what Dr. Yale did. You see, he stepped it up and up and up..."*

RIFE: *"When Verne Thompson used to go down there and take care of Yale's machines - when he began stepping them up and so...where you get up into that extreme power...oh yes, that is not good. With the power that is in these [50 to 100 watts of power coming out of the ray tube], there is absolutely no harm because I had my microscope here - I had my tube [ray tube] right here in front of it - oh, about 11 or 12 inches away from the slide in the microscope and here I was with this thing all around like that and that tube going here and my specimens and the microscope year after year tuning that thing and it never harmed me any." [\(1950's Gonin, Rife, Crane and Marsh Paper #27-32\)](#)*

Dr. Yale's 1936-39 Beam Rays Corporation instruments were putting out a lot more power than Dr. Rife felt was safe. If Dr. Yale's instruments were changed to put out the maximum power that the main output tube could produce then they may have been putting out far more than 100 watts out of the ray tube. It may be that Dr. Rife was just overly cautious but his statement should be considered when one starts using power levels in excess of 100 to 300 watts.

Is it necessary to use a ray tube to output the frequencies?

We really shouldn't care if an instrument uses a ray tube or a pad as long as it will devitalize the microorganism we desire. In the strictest sense of the word just because a ray tube is used doesn't mean it's "Rife". By the time you read this whole article you will find out that very few are doing exactly what Dr. Rife did. But does this mean that these instruments don't work? Those who are building pad instruments are not using ray tubes, and most are not using Dr. Rife's original frequencies. Those who are building ray tube instruments are also not using Dr. Rife's original frequencies or methods. We have quite a paradox. This is the problem we face. If we were to build a ray tube instrument that worked exactly the way Dr. Rife's did and use frequencies from 139,200 to 1,604,000 Hertz then we would have an instrument that could cause interference with radio stations if we were too close to them. These ray tube instruments may have to be used with a Faraday cage which is a conducting cage used to stop electromagnetic fields. We can use them as long as we do not operate them within one half of a mile of a radio station on that stations particular wavelength or call number. We can build a pad instrument that will use all the frequencies Dr. Rife used but then we are not using a ray tube. When we consider the problems we face today with building instruments, the least expensive instrument we can build is a pad instrument. This type of instrument can produce all of Dr. Rife's frequencies. Therefore we should look at this method carefully and not reject it out of personal bias.

As we already said, it really shouldn't matter if an instrument uses pads or a ray tube as long as it works. With this in mind let's look at the reasons why pad instruments were built in the first place. John Crane and John Marsh had really good reasons why they built pad instruments. After nearly 50 years of research and use, there is enough evidence that a pad instrument works just as well as a ray tube instrument, as long as there is sufficient power used. In some cases, because of the electrical stimulation like a T.E.N.S. instrument, they work even better than a ray tube on some problems. We will now take a look at some of the reasons that prompted John Crane and John Marsh to use pads:

RIFE: *“But the principle of this thing is basically built on a coordinative vibration. Just like one tuning fork pitched to the C. Another one here—you strike this one and this one vibrates.”*

DR. LARA: *“What kind of vibration is it? Electromagnetic vibration?”*

RIFE: *“We won’t say magnetic, we will say electronic frequency vibration. The same as put out on a broadcasting station for the radio. The same thing you know, only it’s transmitted into a tube. And the tube acts as a partial directional antenna you see.”* ([John Marsh Rife CDs - CD 6 track 2](#))

In the John Marsh papers describing his trip to Ohio we read a statement made by Dr. Rife:

RIFE: *“You know we had an idea when we had our Clinic in La Jolla, of course that was battery and motor generator operated that set, you know, and boy it would sure raise the devil with all the radios so we had a couple of cars that was equipped with car radios and we sent them out and we would take the switch of that thing, and had a code you know like an S.O.S., and one of them went up north, and one of them went south from La Jolla. Before we started in we wanted to see how far we were going to disturb things with it you know, and incidentally we had it in a steel room, a steel lined vault about this size at the old Ellen Scripp’s home. It was the vault in the library of the Scripp’s home where they kept their valuable manuscripts and books in all steel lined and a door on it like a safe. We had the thing inside of that too, but it didn’t make much difference, but we started in, and one car lost the pick up on top of Torry Pines, and the other one half ways through Mission Beach picked it up, and then they could go a hundred feet and lose and then they would have to pick it up again. Old Henry [Henry Siner] the boy that was with us out there, one of the lab boys, boy he went up in the air. He says, “By God” he says “look, we’re going to fix them up right. At two o’clock we’ll hook this up to a big radio station, a big transmitting station, and at two o’clock next week we’ll broadcast for tuberculosis, and at half past three the week after we will broadcast for cancer, and everybody at the radio will pick it up”. See, boy I said Henry that really is an idea.”* ([1957 John Marsh Trip to Ohio Paper #24](#))

This last statement made by Dr. Rife was made over 20 years after the 1934 clinic. Dr. Rife knew that the frequencies would broadcast from a metal antenna just as well as from a ray tube. The fact that he felt that Henry Siner’s idea was a good one even after more than 20 years shows that Dr. Rife knew a metal antenna would give the same results as a ray tube. It is apparent from what we have read that Dr. Rife believed it was the frequency that was devitalizing the organism and the method of application really didn’t matter. He understood that the frequencies could be broadcast by a radio station if it had enough power. Metal antennas are equal to or more, efficient than a ray tube. When John Crane and John Marsh (Dr. Rife’s two business partners in the 1950’s) came to understand this, they eliminated the ray tube and used pads or hand cylinders to apply the frequencies. The pads and hand cylinders work just like an antenna except you do not want too much power so that they are safe to use. The body also becomes an antenna when you hold the hand cylinders or use the pads and this is why pad instruments work. Bertrand Comparet stated this in his interview:

COMPARET: *“Now, Crane said “Well now look, Rife himself admits that no matter how much tube and ray, and so on, you have, you can’t get any results unless you’ve got the right frequency. Therefore the real clue to the thing is the frequency and not the means by which you deliver it.” Comparet also said: “Well, Crane originally was, with more modern techniques, duplicating the Rife machine, tube and all for early experiments. And, as I say, he came to the conclusion that you just weren’t getting anything additional by the use of the tube. If you didn’t get the frequency, you could run the rest of it indefinitely and nothing happened. So, what Crane did, he got an audio frequency generator. Now, you could make them up yourself by an awful lot of work, or you could buy a Heathkit audio frequency generator and get all the same results with a lot less time and effort. So he was using these Heathkit generators. Now, instead of a beam projected from a tube, a ray, he simply had two wires. I think they were aluminum knobs on the end of them, which would be used. They would be put on the body in*

such a position that the natural flow of the current from one to the other would go through the diseased area, and he got astonishing results. ([1970's Bertrand Comparet Interview #33 & 47](#))

These pads or hand cylinders act just like an antenna when in contact with the body, but only if you have an RF carrier frequency. This is where John Crane and John Marsh made a critical error and the reason Dr. Rife probably did not like their pad instrument. Without an RF carrier frequency the audio frequencies will only go through the connective tissue and not the cell. There are exceptions to this and they have to do with the wave form of the frequency. If a square wave audio frequency is used then the higher harmonics produced from this wave form may penetrate the cell to some degree. How much power from these harmonics penetrates the cell is not known. This may explain why instruments that do not use an RF carrier frequency work to some degree. Dr. Rife expressed his dislike for John Crane and John Marsh's instrument that did not use a carrier frequency when Bertrand Comparet asked him about it:

COMPARET: *"And I asked Rife, because I thought Rife would certainly say that the way Crane was working on it then was still using the Rife principle, but he indignantly denied it."* (Comparet interview papers - 1970's)

We know that Dr. Rife knew that a metal antenna would work and we also know that the pad instrument worked on this principle. Logically it must have been the fact that it did not use an RF carrier frequency that upset Dr. Rife. Pad instruments that do not use a carrier frequency are limited in power. The highest power output that can be safely used from a non RF carrier pad instrument is about 1/5 of one watt (0.20 to 0.40). Any more power than this and the muscles of the body will begin to lock up. If you use an RF carrier frequency then you can output a hundred times more power safely. It is apparent that it was the lack of power that concerned Dr. Rife. All of Dr. Rife's original frequencies were in the (RF) Radio frequency broadcast band of frequencies. We will cover these frequencies and the audio frequencies along with the importance of a carrier frequency later in this article.

Some people have thought that it was the light from the ray tube that made it work. But the evidence doesn't seem to support that concept either because in the Gonin Papers of John Marsh, Dr. Rife said this with regard to the light that came from the ray tube:

RIFE: *"We don't care about the color or anything of that sort."* ([John Marsh Collection, Gonin Papers, Page 25, www.rife.org](#))

Dr. Couche, while visiting Dr. Rife's lab with some other men, said:

DR. COUCHE: *"There was fifteen inches of concrete on the floor so as to stop any earthquake shocks from interfering with his work. And in his laboratory upon the ground floor he had a microscope with a slide on it that this group of people and myself looked at. And this was not stained, there was no killing of the bacteria on it. It was just a fresh culture of the colon bacillus.....Well we all went down under the stairs into the cellar right immediately under the microscope upon the floor above us and the Rife machine was down in underneath there under the culture in the cellar probably I suppose about ten feet away, eight or ten feet away. And he turned the machine on and gave it less than a half minute's frequency for the colon bacillus...Then he turned the machine off and we all came upstairs and waited for ten or fifteen minutes. And presently he came back to his microscope and he said, "Well gentlemen come and look at the slide now." Well to my astonishment the bacilli all had been killed and they were all stacked up on the slide."* ([John Marsh Rife CDs - CD 3 track 1](#))

There is no possible way the light from the ray tube could have penetrated that fifteen inch concrete floor. It is obvious that the light didn't make any difference but that it was the frequencies that were broadcast through the ray tube. It is easy to see that there is more than one way to deliver the

frequencies. The ray tube could be easily replaced with metal hand cylinders and foot pads. It is interesting to note here that Dr. Rife said Abrams' Oscilloclast would devitalize the BX cancer virus and it was a contact type device. The wave form the Oscilloclast produced is shown in Dr. Rife's 1936 film. John Crane and John Marsh probably used this contact method because of the success of Abrams' instrument. The Abrams' instrument proved that a contact type device would work and it was used before Dr. Rife even started using a ray tube. In fact Abrams' contact instrument predates all of Dr. Rife's work. Pad instruments like Abrams' instrument came in contact with the body. Abrams instrument worked on the same RF principles as Dr. Rife's instruments. Pad instruments with an RF carrier turn the body into an antenna and work on the same principle as a metal antenna or ray tube. People have been using pad instruments without an RF carrier for almost 50 years now and have had very good results. But, in order to work the way the ray tube instruments do, an RF carrier frequency is necessary.

Are RF frequencies safe to use?

Today there are many who profess to believe in Dr. Rife and his method of coordinative resonance using frequencies but claim the RF is bad or harmful. Some of these people build and sell instruments that do not use any RF carrier frequencies and put in their sales information that RF frequencies are harmful. This is a great disservice to Dr. Rife. The instruments they build use low audio frequencies like those used in Beam Rays clinical instrument and 1950's instruments (these frequencies will be discussed later).

When it comes to Dr. Rife and the method he used you cannot "have your cake and eat it too." Dr. Rife's principles were all based on coordinative resonance through RF frequencies. Any method used that does not use RF frequencies cannot be called Rife's method. Today, regardless of the method used, people call their instruments "Rife Machines" no matter how they are built. Dr. Rife specifically asked that his name not be put on any instrument, yet this is exactly what people do. There is nothing wrong with people building non RF instruments, but claiming that RF is bad or unsafe just to sell their instruments is where the problem lies. Dr. Rife's Colin B. Kennedy equipment (which will be discussed later in detail) had a frequency range of about 12,000 hertz to about 2,000,000 hertz. With this equipment Dr. Rife found the many frequencies that would eliminate or devitalize the various organisms he tested. In Dr. Rife's tests he would have naturally started in the low frequency range and slowly worked his way higher until he found a frequency that would eliminate the organism. All of the frequencies that he found were in the RF range. They went from 139,200 hertz for Anthrax to 1,604,000 hertz for the BX cancer virus. It was only these frequencies that Dr. Rife found that would resonate the organisms and devitalize them. Since Dr. Rife found that only these RF frequencies would resonate and kill the organism then it is impossible to separate RF from coordinative resonance. It would also be impossible to build an instrument that truly worked on Dr. Rife's principles without the use of RF or radio frequencies. In order to prove the safety of Dr. Rife's work we must quote him since he is the person that everyone believes in. Below are two of his quotes on the safety of using RF frequencies in the range and power level that he used. The first quote comes from a letter sent to Dr. Stein in 1956:

RIFE: *"I have operated the frequency instrument since 1921. I have watched it advance in style and performance with the advancement of electronics. In the many years I have used this equipment in my research, I have never suffered an injury or any ill effects whatsoever. I found it reliable in performance and efficient in results."* ([Letter from Dr. Rife to Dr. Justin Stein, July 3, 1956](#))

On the John Marsh, Rife audio CDs Dr. Rife also made this statement about his RF frequency instrument:

RIFE: *"I stood in front of that thing for thirty years finding these different frequencies that devitalize these different bacteria. And that thing [RF ray tube] was shooting on me right here [his chest], but it is*

absolutely harmless to normal tissue and each individual bacteria requiring a different frequency to devitalize.” ([John Marsh Rife CDs](#))

Dr. Milbank Johnson, M.D. also used the instrument for many years and conducted clinics and found the instrument safe to use. [Dr. James B. Couche, M.D.](#) used the instrument in his private practice for over 22 years and also said he found the instrument safe to use. [Dr. Tully, D.D.S.](#) purchased one of Dr. Couche’s instruments and used it for several years and found it completely safe to use. [Dr. Robert P. Stafford, M.D.](#) used the frequency instrument for over 5 years and also expressed that he found the instrument completely safe to use. These statements along with Dr. Rife’s that we quoted above show that Dr. Rife found that his RF frequencies in the ranges he used were as safe to use as the frequencies output by any radio station. These frequencies are broadcast through the air day and night passing through our homes without any harm to the human body. There may be some people with RF sensitivity but this does not mean that RF is unsafe to use. This only means that these people are sensitive to RF and should avoid it if they find a problem using it.

Did Dr. Rife use audio frequencies?

In Dr. Rife’s 1961 deposition he revealed the fact that he was using some form of audio modulation from the beginning of his work with frequency instruments:

RIFE: *“Initially I worked with loose couplers to get an audio oscillation and then with the use of transmitters, I tried to balance the audio and modulate the audio on a carrier wave to transmit the audio energy.”* ([Dr. Rife’s 1961 Deposition, answers page 5](#))

Dr. Rife stated that at the beginning of his work, back in the days when loose couplers were used in generating frequencies, he was using audio modulation with an RF or radio frequency carrier. Below are photos of loose couplers courtesy of "Henry Rogers, Western Historic Radio Museum" ([www.radioblvd.com](#)). These loose couplers worked by moving one coil inside the other in order to change the frequencies.

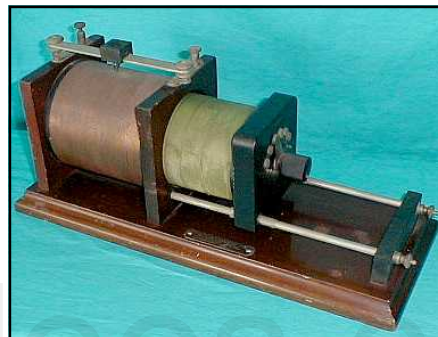
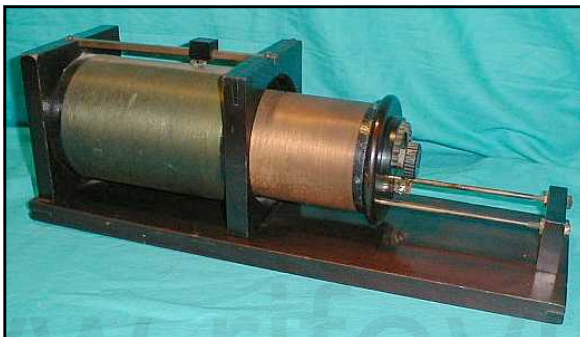

In Dr. Rife’s high frequency instruments he used a specific audio circuit which gated or pulsed his frequencies. This circuit modulated a fixed audio frequency with all his high frequencies which he used on the various organisms. This circuit will be discussed later when we discuss these instruments.

It is apparent that Dr. Rife first tested audio frequencies on organisms in his search for the frequency which would devitalize them. The audio range would be the logical place to start. If he couldn’t find a frequency in the audio range, he then moved up into higher frequency ranges until he found a frequency that would devitalize an organism. In Dr. Rife’s early lab notes, he listed only two organisms that had an audio frequency M.O.R. Later when Dr. Rife found out that he was reading his frequencies incorrectly, one of those audio frequencies was changed to a much higher RF frequency. There are other statements made by Dr. Rife which show that he tested the audio range. In fact Dr. Rife gave the full range of his frequencies:

RIFE: “Some of them are in the visible band, or I mean not only the visible band but, uh, band of frequencies audible [audio] to the human ear. Some of them are way beyond either way. They run through a very, very large gamut. Some of them are very, very broad, long. Some of them are...not extremely short. There are none of them what we call our ultra short wave that I have found yet. Well there’s many of them...we would, uh, classify in the ultrasonic band because they’re not visible [sic] with the human ear. They’re way beyond you know. And some of them are even in the broadcast band. Your cancer is very high. You can’t hear it, the oscillation. But now you take your T.B. [Tuberculosis]. Now that’s down. A little more you see...if you don’t have an absolute coordinative resonance, you have nothing. One tenth of one meter off and you have nothing. Its got to be absolutely correct for that individual organism. It’s got to be precise...the virus of cancer has a certain frequency. And it has to be there, otherwise if it’s a little one way or the other, no good, no good for nothing. Infrared will penetrate, yes, but the heat is not the thing because the heat is not the frequency, it’s [Infrared] way down in the very low band of frequencies and the laboratory rate of the BX is up into the high band.” ([John Marsh Rife CDs - CD 5 track 2, CD 6 track 2, CD 7 track 1 and CD 9 track 1](#))

In these statements Dr. Rife clearly explains the broad range of his frequencies. Some were audio and could be heard by the human ear; others were in the ultrasonic range, and some were even in the broadcast band. Cancer he said was very high. He states the frequencies have to be very accurate to work. One tenth of one meter off and they would not work at all. We will talk about this later. Here are two additional statements that also verify that Dr. Rife’s instruments could output a modulated audio frequency:

RIFE: “You know we had an idea when we had our [1934] Clinic in La Jolla, of course that was battery and motor generator operated that set, you know, and boy it would sure raise the devil with all the radios so we had a couple of cars that was equipped with car radios and we sent them out and we would take the switch of that thing, and had a code you know like an S.O.S., and one of them went up north, and one of them went south from La Jolla. Before we started in we wanted to see how far we were going to disturb things” ([John Marsh Collection, Trip to Ohio Papers, Page 7, www.rife.org](#))

In order to be able to put out an S.O.S. type signal he would have had to modulate the audio frequency onto a carrier in order for the car radios to pick up the signal. This audio frequency would also create a problem with radio stations. On the John Marsh Collection of Dr. Rife’s audio CDs, Dr. Couche makes an interesting comment about the #3 instrument. He was present at the 1934 clinic sponsored by Dr. Johnson and the University of Southern California. He stated:

DR. COUCHE: “They gave him a treatment of the Rife frequencies which are in the auditory band.” ([John Marsh Rife CDs - CD 3 track 1](#))

The cancer and tuberculosis frequencies used in the 1934 clinic were not audio frequencies. Why would Dr. Couche make this statement? The evidence shows that Dr. Couche was getting things mixed up. The Beam Rays Clinical instruments which Dr. Couche used for over 22 years used audio frequencies. Dr. Couche purchased two or three of these clinical instruments and used them until 1952 when he retired. We will cover this instrument later in this paper. Everything which we have quoted shows that the equipment from 1934 and earlier could output audio frequencies and that Dr. Rife tested audio frequencies right from the beginning of his work in 1920.

Although we have been able to prove that Dr. Rife tested the audio range of frequencies, as any good scientist would have done, it should be pointed out that by 1935 when the Rife Ray #4 was built, he no longer felt that he needed to test audio frequencies any longer. This is indicated by the fact that no variable audio oscillator was included in this new frequency instrument. The Rife Ray #4 will be discussed later in this article.

History of Dr. Rife's instruments and changes made

There is finally enough information to know what Dr. Rife did in the early years, from 1923 to about 1934. This is because we now know exactly what instruments he used and their output ranges. His lab notes detailing 26 conditions and their frequencies have also been preserved. The earliest information, which we now know is incorrect, indicated that he used frequencies ranging from the audio range to just over 17,000,000 Hertz (17 Megahertz). We also now know Dr. Rife's frequency instrument did not have this frequency range, except through harmonics which came from the ray tube. We also know from the Beam Rays Trial manuscript that Dr. Rife misread his frequencies prior to 1935. The equipment that he used prior to the fall of 1935 was called the Rife Ray #3. In 1935 the Rife Ray #4 was built and used by Dr. Milbank Johnson and Dr. Rife. The Beam Rays Laboratory instrument was built after the Rife Ray #4 sometime in 1936 or 1937. We know how these instruments worked.

The Beam Rays Clinical instrument used audio frequencies modulated onto a fixed RF frequency and was built by Philip Hoyland in 1936. This instrument became the primary instrument sold by the 1938-39 Beam Rays Corporation. This instrument was called the Clinical instrument and we now have an original instrument that we were able to test and do a spectrum analysis of its method of operation. This information is presented in detail in this paper.

All of Dr. Rife's instruments after the #3 instrument were built by Philip Hoyland. The Beam Rays Laboratory instrument is understood thanks to Jim Peters who corrected the Beam Rays schematics.

In the Beam Rays Trial of 1939 Philip Hoyland said Dr. Rife's frequencies were in the upper bands (139,000 to 1,604,000 Hertz) inferring that his frequencies were in the lower bands. Thanks to the Beam Rays Trial manuscript given to us by Steven Ross and the Rife Ray #4 machine paperwork we now know the correct high RF frequencies that Dr. Rife used.

Thanks to Aubrey Scoon and his Beam Rays Clinical instrument replica we now have those frequencies which range from 1200 to 21275 Hertz. There is strong evidence that these audio frequencies were used by Philip Hoyland in one of his Clinical instruments. These frequencies were taken off Aubrey Scoon's instrument using an oscilloscope. These frequencies helped us to understand how the Beam Rays instrument worked. The 1950's AZ-58 Beam Rays replica ray tube instrument used by Dr. Rife, John Crane and John Marsh was built and updated from the Beam Rays Clinical instrument. Today the AZ-58 has been rebuilt from schematics. The frequencies used in it are even lower than Aubrey Scoon's audio frequencies. The frequencies used in the AZ-58 went from 120 to 2128 Hertz. The correlation between the Beam Rays clinical instrument and Aubrey Scoon's instrument and the 1950's AZ-58 instruments will also be discussed in greater detail in this article.

In order to follow the evolution of Dr. Rife's technology, we will first examine the Rife Ray #3 (built prior to 1934), then his next instrument, the Rife Ray #4 (built by Philip Hoyland in 1935), then the Beam Rays Clinical ray tube instrument and the Beam Rays Laboratory ray tube instrument built around 1936 and sold by the 1938-39 Beam Rays Corporation. Then we will look at Aubrey Scoon's instrument and the 1950s AZ-58 Beam Rays replica ray tube instrument along with the 1950s pad instrument built by Life Labs. We will also take a look at some of John Marsh's instruments.

1934 Rife Ray #3 instrument used in the 1934 clinic

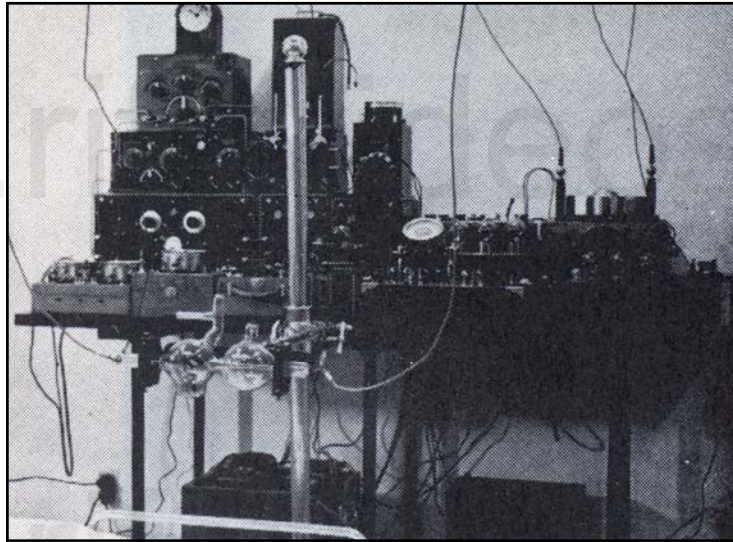

- 1) This was a regenerative instrument that used a ray tube.
- 2) It consisted of two Kennedy Regenerative Receivers (the model numbers were the 110 and 281). These two receivers made it possible to have a combination of one low frequency oscillator and one high frequency oscillator or two high frequency oscillators.
- 3) The output was sine wave.
- 4) Power usage was from batteries. Output to the ray tube was about 50 RF watts?

This instrument was used in the 1934 clinic by Dr. Milbank Johnson ([photo](#)). If you look at the bottom of the above photo you can see part of the bed railing and mattress where they treated the patients. If you look at the table you can see that the instrument was not a one piece instrument but had many components. This instrument has always been considered the best instrument used by Dr. Rife because it produced the results of the 1934 cancer and tuberculosis clinic. Those interested in the work of Dr. Rife have always wanted to know how this instrument worked. They have also wondered what equipment he used. This has been one of the biggest Rife mysteries. There has been all kinds of speculation on how his first instrument worked. What was its waveform? What was the frequency range? Could it generate audio frequencies? Was it super-regenerative (as he wrote on his lab notes), or was it just regenerative? All of these things have remained mysteries for over fifty years. It was generally believed that the 1934 instrument was custom made for Dr. Rife. However, if the equipment had not been custom made, the mystery would be over. And today, thanks to some great detective work done by James Peters, the mystery, in fact, is now over. The instruments were not custom made. They were standard off-the-shelf frequency generating equipment that Dr. Rife purchased. The equipment and frequency ranges are now known.

A better photo of the equipment Dr. Rife used appears on the top right of page 12. He most likely stacked it all up on a table and took a picture of it after he started to use the newer equipment built for him in 1935. This photo, amongst others, made it possible to figure out the equipment Dr. Rife used. This photo has been provided courtesy of Jason Ringas of Rife Research Group of Canada. Here in this paper you will be able to see the actual equipment along with the selling advertisements of the 1920s that give the specifications of the equipment.

We will now look at each piece of equipment and take an in-depth look at the specifications of each. All pieces of equipment except the ray tubes and possibly the five stage amplifier were considered off-the-shelf equipment. This means that this was standard frequency generation equipment which could be purchased from companies in the 1920's. Although they are regenerative receivers, they could output whatever frequency Dr. Rife wanted to use when the regenerative circuit was turned up. Dr. Rife used top-of-the-line Kennedy equipment from the Colin B. Kennedy Company, which built some of the most accurate, high quality equipment that could be purchased in 1923. It was also some

of the most expensive equipment to purchase. We will now take a look at the photo below on the left. It is one of several photos of Dr. Rife's lab instruments. The bottom two pieces of equipment were the Kennedy Receiver Model 110 connected to the Kennedy Two-Stage Audio Amplifier Model 525. The other piece of equipment sitting on top of the Kennedy Receiver Model 110 we will look at later. Below this lab photo is a better photo of this old antique equipment. To the right of these photos is the 1923 advertisement from the Colin B. Kennedy Company which provides the frequency range and features of this regenerative receiver. It also gives the effective frequency range from 175 to 25,000 meters or from 12,000 Hertz to 1,700,000 Hertz.

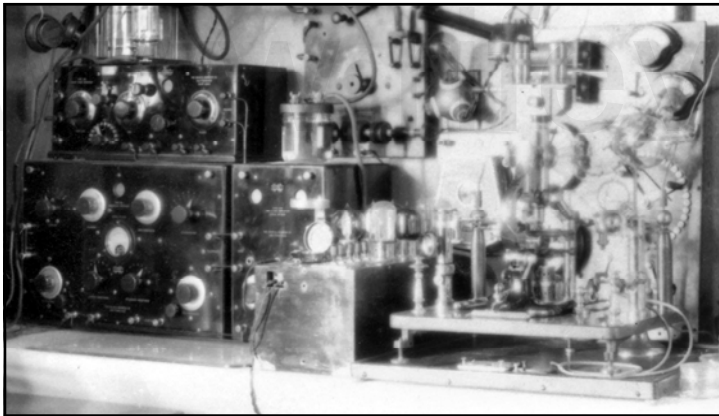
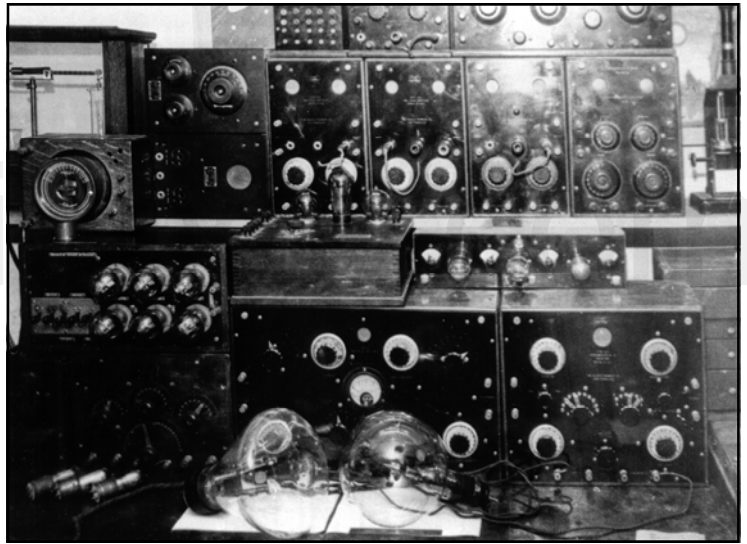

This instrument could actually go from 150 meters to 25,000 meters giving it a range from 12,000 to 2,000,000 Hertz. The Kennedy Company was just being conservative in its advertisement. The next instrument that is on top of the Receiver Model 110 in the lab photo is the Kennedy Short-Wave Regenerative Receiver Model 281. And on the top left of page 13 is a photo of the Kennedy Receiver Model 281 and to the right is the Kennedy advertisement. This instrument had an effective range from 185 meters to 620 meters or from 483,000 Hertz to 1,620,000 Hertz. This instrument could actually go from 150 meters to 620 meters giving it a range from 483,000 to 2,000,000 Hertz. Kennedy Company again being conservative. In the photo, on the top of this page, that has all of Dr. Rife's equipment was another Kennedy Regenerative Receiver, this being the Kennedy Model 220. A photo of it is on page 13 below the Kennedy Model 281 photo with the Kennedy Company advertisement for it on the right. Its effective frequency range was from 175 meters to 3250 meters or from 92,000 Hertz to 1,700,000

KENNEDY
EQUIPMENT

ANNOUNCING

**THE NEW KENNEDY UNIVERSAL REGENERATIVE
RECEIVER
TYPE 110
EFFECTIVE RANGE: 175 TO 25,000 METERS**

DETECTS
REGENERATES
OSCILLATES
On all wave
lengths in
common use.

Licensed
under
Armstrong
U. S.
Patent
No. 1,113,149

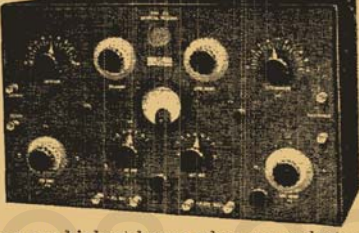

Surpassing even our highest hopes when we undertook its development, this latest addition to the Kennedy line is of interest to everyone who uses a radio receiving set.

Our engineering staff spent many months in developing this unit and released it for production only when its performance surpassed every requirement we had set for it. By our long specialization in receiving equipment we have built up a reputation which is so precious that we can afford to put the Kennedy trade-mark on only the highest quality product.

We have spared no effort to make this the best receiver on the market. We honestly believe that it is.

These are some of its features:

- Variable inductive coupling between primary and secondary.
- Extremely sharp tuning because of very efficient inductance units.
- Special Kennedy bank-wound moisture-proof inductors.
- Generous overlap between inductance steps.
- Large balanced primary and secondary variable condensers.
- Micrometer adjustment of secondary condenser
- Variable grid condenser with air dielectric, permitting most effective use of all types of available receiving tubes.
- Adjustable feed-back circuit.
- Fine adjustment of plate voltage by means of potentiometer connected between terminals of filament battery.
- Weston ammeter for measuring filament current.
- Bus-bar type insulated wiring.

Further details in Bulletin 101, mailed on request.

Ask your dealer for a demonstration. Compare the performance of this receiver with any other you have ever seen. The users of Kennedy Equipment are our best advertisers.

THE COLIN B. KENNEDY COMPANY
INCORPORATED

RIALTO BUILDINGSAN FRANCISCO



Hertz. It could also go from 150 meters to 3250 meters, which gives it a true range from 92,000 to 2,000,000 Hertz.

Now that we have all the frequency generating equipment identified we can now come to some conclusions. All of this Kennedy equipment was sine wave. Square wave was not used or even generated in this old equipment. The Kennedy Receiver Model 110 had a frequency range from 12,000 to 2,000,000 Hertz or 2 MHz. This shows that Dr. Rife's instruments had the ability to output audio frequencies, a fact that he mentioned in his 1961 deposition. The only audio frequencies he would have used would have been modulated from this equipment. Dr. Rife also mentioned in his 1961 deposition that he balanced the audio on a carrier which would have been a modulated waveform.

What is really surprising is the fact that none of the Kennedy equipment that Dr. Rife used could output a frequency higher than about 2 Megahertz (MHz). This fact changes a lot of things with regard to his lab notes dated before 1934. It was impossible for him to produce 11,780,000 Hertz or 17,033,000 Hertz using this equipment. These are the two frequencies that Dr. Rife listed on his lab notes for the BX cancer virus. The frequency range of the Kennedy equipment now explains why Dr. Rife's Engineer, Philip Hoyland, said that Dr. Rife had misread his frequencies prior to 1935.

With Dr. Rife's approval, Philip Hoyland was hired by Dr. Milbank Johnson, M.D. and the University of Southern California Special Medical Research Committee in 1935 to build a more up to date portable frequency instrument to be used for their research. Dr. Rife's 1934 instrument was cumbersome because it was not just one, but several, pieces of equipment which were difficult to move and use. In order to build the new instrument, Philip Hoyland needed to know what frequencies Dr. Rife was using. So he brought to Dr. Rife's lab an oscillator to read the frequencies. It was difficult to read the correct frequencies prior to this time unless you were very proficient at doing it. Philip Hoyland had to know exactly what frequencies Dr. Rife was using in order to build the new instrument. While testify-

**KENNEDY
EQUIPMENT**

Our new improved
Type 281

**SHORT-WAVE
REGENERATIVE
RECEIVER**

is designed for high efficiency
on wave lengths of 185 to 620
meters. The ideal set for relay work. It embodies all the features of correct design
and superior workmanship that have established the reputation of Kennedy Equipment.

You will be interested in the details of this new short wave set. Ask your dealer
about it. If he cannot supply you we will send you Bulletin 201 on request.

The high quality of Kennedy apparatus is being appreciated by those who want
the best results. We again find it necessary to greatly increase our factory capacity
to meet the demand.

THE COLIN B. KENNEDY COMPANY
INCORPORATED

RIALTO BUILDING SAN FRANCISCO

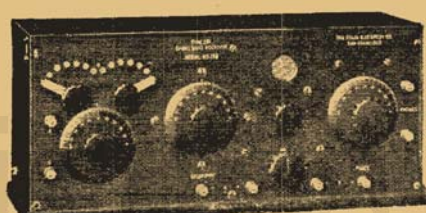

Licensed under Armstrong U. S. Pat. No. 1,113,149

Announcing

the new
KENNEDY
Intermediate-Wave
Regenerative Receiver
Type 220

Range 175 to 3250 Meters

We believe there is no other receiver on
the market which represents so much concentrated
quality value.

See it at your dealer's. Examine it thor-
oughly, have a demonstration and form your
own opinion. We don't ask you to accept
ours.

Licensed under Armstrong
U. S. Patent No. 1,113,149

Bulletin 201, giving full details mailed on request

Ask Your Dealer

THE COLIN B. KENNEDY COMPANY
INCORPORATED

RIALTO BUILDING SAN FRANCISCO



ing on the stand in the 1939 Beam Rays trial, Philip Hoyland stated this about how he obtained the frequencies: (Beam Rays Trial Papers www.rife.org)

HOYLAND: *"They were taken off the last machine [the Kennedy equipment] that was built by Dr. Rife. I transferred them from one machine to another."*

At another point during the trial the transcript reads as follows:

COMPARET: *"In June of 1935 was when you made an agreement with the [transcript missing words] medical research to build a Rife Ray machine, [the Rife Ray #4] you did build it soon after that?"*

HOYLAND: *"Yes."*

COMPARET: *"You had an agreement with them that all work was to be done under Dr. Rife's direction?"*

HOYLAND: *"That's what the contract called for."*

COMPARET: *"Did you do this work without getting the frequencies from Dr. Rife?"*

HOYLAND: *"I calibrated the machine according to the bacteria."*

COMPARET: *"What specifically did you do that constituted this recalibration?"*

HOYLAND: *"I used a standard oscillator against his machine to see what frequencies he was using."*

COMPARET: *"He set his machine and you measured his frequencies?"*

HOYLAND: *"Yes."*

COMPARET: *"Did you make any memorandum of these particular frequencies?"*

HOYLAND: *"Yes, I gave Dr. Johnson and Dr. Rife a list of them."*

Later during the trial Dr. Rife was asked where the frequencies came from:

JUDGE KELLY: *"When you constructed this Beam Ray machine [from Kennedy equipment] you had a dial representing the frequencies or harmonics?"*

RIFE: *"We had many dials on the original machine [Kennedy Model 110]."*

JUDGE KELLY: *"Is that the machine Mr. Hoyland got the frequencies from?"*

RIFE: *"Yes, he took them off that old machine [Kennedy Model 110]."*

From the court testimony given by Dr. Rife and Philip Hoyland we see the frequencies were read by Philip Hoyland off of the Kennedy Model 110 and 281 and used in the next instrument which was the Rife Ray #4 (We will be discussing this instrument next). Now let's continue on reading the court testimony:

COMPARET: *"Now going back to your assumption that Dr. Rife knew the frequencies, had Mr. Hoyland ever told you that Dr. Rife knew them?"*

EDWARDS: *"No, he told me that Dr. Rife only thought he had them."*

COMPARET: *"What did you think that meant?"*

EDWARDS: *"Well, Mr. Hoyland told me about that time [1934 and before], that Dr. Rife measured the frequencies only by the length of the wire and that he did not take other factors into consideration."*

Here in the court testimony we just read that Dr. Rife had not read the frequencies correctly when he measured them. This would have been a mistake easy to make in the 1920's and 1930's. The frequencies which Philip Hoyland read off of Dr. Rife's #3 instrument, which consisted of the Kennedy equipment, were different from the earlier lab note frequencies recorded by Dr. Rife. This has caused a lot of confusion because the frequencies that Philip Hoyland read were all lower than 2,000,000 Hertz. Dr. Rife had written down in his lab notes frequencies as high as 11,780,000 and 17,033,000 Hertz for the BX cancer virus. However, the Kennedy Models 110, 220 and 281 could not output these high frequencies. It is apparent that Philip Hoyland was absolutely correct when he said in court that Dr. Rife had misread his frequencies. Also, Philip Hoyland testified in court that he gave both Dr. Rife and Dr. Johnson a list of the correct frequencies he read off of the Kennedy Model 110. This verifies the truth of what Philip Hoyland said in court.

There is another verification that Dr. Rife had misread his frequencies. On the Rife audio CDs, Henry Siner, Dr. Rife's lab assistant, read from a lab note of the BX cancer virus. All the information was the same as Dr. Rife's earlier pre-1935 lab notes except the frequencies. On that corrected lab note Henry Siner read 187 meters for the wave length and 1,604,000 Hertz for the cycles per second frequency for the BX cancer virus. Both the meter frequency and the cycles per second frequency were the same frequency. However, on the pre-1935 lab note, both were different. One frequency was 11,780,000 and the other was 17.6 meters or 17,033,000 Hertz. This also verifies that Dr. Rife had not read his frequencies correctly. The frequency of 1,604,000 Hertz was the frequency Philip Hoyland read and gave to Dr. Rife and Dr. Johnson and it was used in the new instrument built in 1935 called the Rife Ray #4.

There is one thing we need to consider. Dr. Rife could have read a harmonic of the frequency instead of the correct frequency. It appears this is in fact what Dr. Rife did. Dr. Rife understood how easy it was to read a harmonic frequency instead of the correct frequency and recognized that he may not have had true fundamental frequencies. He stated:

RIFE: *"I've talked to you [John Crane] and Verne [Verne Thompson] and other people too that there may be some of the frequencies that we are using that may be harmonics, you know...It's not an impossibility that some of those frequencies may be a harmonic. We may not know the true frequencies of some of them. But it does the business. Maybe if we had the true frequency it would do it better because it has more power than a harmonic."* ([John Marsh Rife CDs - CD 7 track 2](#))

The frequency that Philip Hoyland read off of Dr. Rife's 1934 instrument was 1,604,000 Hertz. Dr. Rife had written two frequencies down on his pre-1934 lab notes. One was 11,780,000 Hertz and the other was 17,033,000 Hertz. The seventh harmonic of 1,604,000 is 11,228,000 which is close to the 11,780,000 especially if you consider that Dr. Rife was not reading his frequencies correctly. We now know Dr. Rife was not even reading the harmonic correctly. Now the eleventh harmonic of 1,604,000 is 17,644,000 which is close also to 17,033,000 Hertz. Had Dr. Rife read the frequencies correctly then both the meter frequency and the cycles per second frequency should have been the same. This was the case with the new lab note when it was corrected by Dr. Rife and read by Henry Siner in the 1950's. The evidence is absolutely overwhelming that Dr. Rife was not reading his frequencies correctly because the frequencies Philip Hoyland read were used in the next instrument which was called the Rife Ray #4. In the space of about 60 days all Dr. Rife's frequencies changed.

We wondered where these harmonics that Dr. Rife read might of come from. Did the Kennedy Model 110 have harmonics in its waveform? Did it output a sine wave waveform? Was the waveform

distorted? The only way to answer these questions was to find a working Kennedy 110 and put it on a spectrum analyzer. Jason Ringas of the Rife Research Group of Canada and I contacted Henry Rogers the owner of the Western Historic Radio Museum (www.radioblvd.com) who owns two Kennedy 110s that are still operational. Henry Rogers knew nothing about Dr. Rife but agreed to let me come visit his location to check the readings of the Kennedy Model 110. He also owns a Kennedy 220 and a Kennedy Model 281, both of which are also in working condition. The Kennedy Company built top-of-the-line equipment and we were surprised to find out even after over 80 years, they still worked as well as they did when they were new. Very little attention is ever needed to get these instruments back in working condition because of the quality of their construction. So with spectrum analyzer in hand, I went to see Henry Rogers and we put the Kennedy 110 on the spectrum analyzer to get the answers to our questions. Below is the reading of the waveform of the Kennedy Model 110 at 417,000 Hertz using a PicoScope 3205 spectrum analyzer. On the left is the waveform which proves that Dr. Rife was using

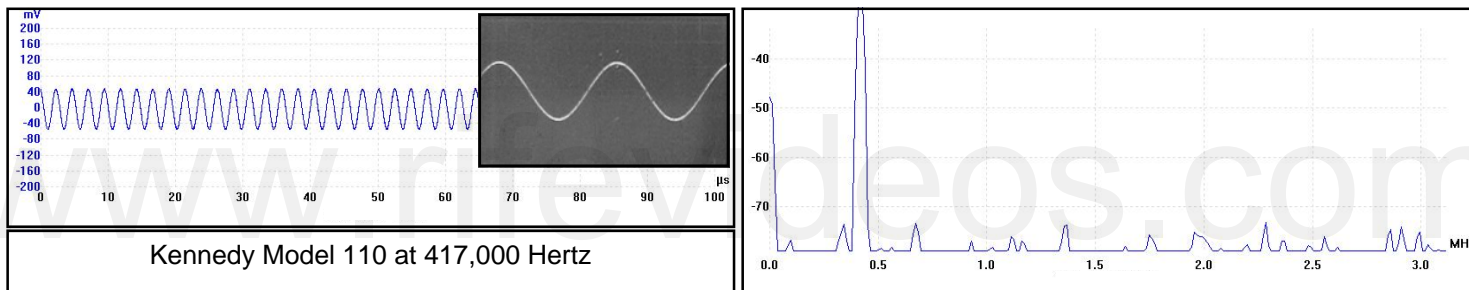

sine wave. That question is finally answered. The spectrum analyzing of the frequency revealed that there were no harmonics in the waveform. The noise which shows up as little spikes are from the power supply. These old receivers ran on batteries and when they are hooked up to batteries the noise in the circuit is greatly reduced. The amazing thing about the Kennedy Model 110 sine wave waveform was that it was picture perfect. This amazed us because everyone believed that the equipment that Dr. Rife used would have had a distorted waveform. No one that I have ever talked with believed that this old equipment was capable of producing a nearly-perfect waveform. It was as good as we can do today with our sophisticated modern frequency generating equipment. The fact that it produced no harmonics also totally amazed us. Below are the readings of the Kennedy Model 110 at 770,000 and

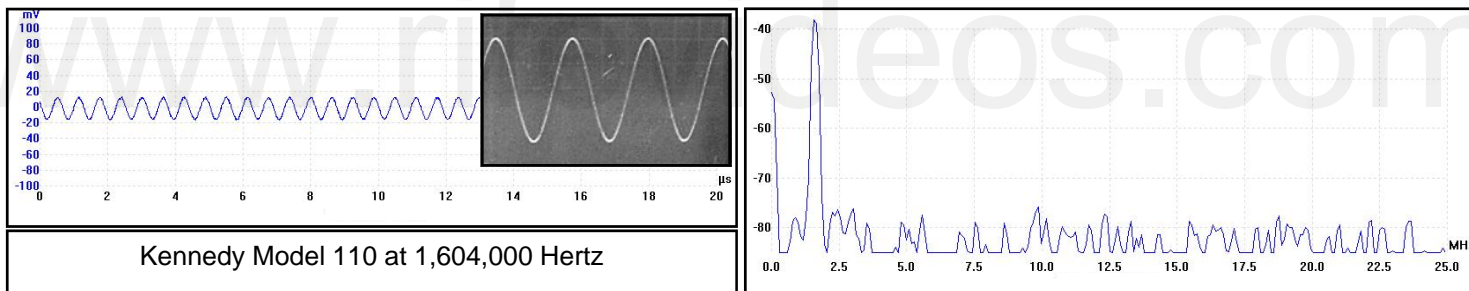
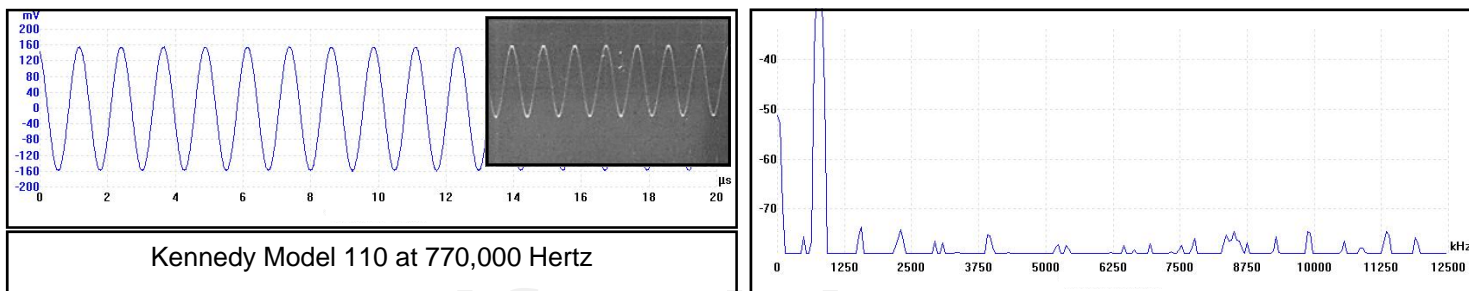

1,604,000 Hertz. At 1,604,000 Hertz the sine wave was still nearly perfect and it did not produce any harmonics. We checked all frequencies out to 50 Megahertz for harmonics and found none.

This testing showed that Dr. Rife's equipment output a sine wave waveform with no harmonics. So where did the frequencies come from that Dr. Rife read and recorded on his old lab notes? Why did he record two frequencies in his lab notes? We now knew what equipment he used. His pre-1935 lab

notes just didn't make any sense. We knew from Henry Siner's reading of the corrected BX lab note that the meter frequency and the cycles per second frequency should be the same. It is apparent that Dr. Rife used two different pieces of equipment to read his frequencies. One piece of equipment gave a reading in meters and the other piece of equipment gave a reading in cycles per second. However even knowing this did not explain where the harmonics came from.

We knew that the noble gas he used in his ray tube could double the frequency that went through it. These types of tests have been done with plasma in laboratories in the past. So we decided to make some tests. We tested the Icom 718 which we hooked up to a phanotron ray tube. This is the type of ray tube Dr. Rife used and is the only one we tested. We first tested to see what the sine wave looked like coming out of the Icom 718. We wanted to make sure that it did not produce any harmonics, and in fact, our testing showed it did not produce any harmonics. Then we hooked it up to the antenna tuner to see if the tuner distorted the waveform and produced any harmonics. We found it did not distort the waveform or produce harmonics through the antenna tuner except at 1,604,000 Hertz. This is only because the Icom is not supposed to output a frequency below 2,000,000 Hertz. Below this frequency it will produce two harmonics (see graph on page 18). The other two frequencies we tested were 11,780,000 and 17,033,000 Hertz. These were the frequencies Dr. Rife recorded on his pre-1935 lab notes and neither of these produced harmonics through the antenna tuner. Then we put it through the ray tube. The ray tube didn't just double the frequency - it also produced all the harmonics that Dr. Rife would have read. We now had the answers as to where the harmonics came from. The ray tube produces the harmonics. You can put a harmonic-free sine wave through a ray tube and get all the harmonics that Dr. Rife recorded in his lab notes. On the next three pages are the readings taken in this testing.

www.rifevideos.com

www.rifevideos.com

www.rifevideos.com

Testing done with PicoScope 3205 spectrum analyzer at 1,604,000 Hertz using Icom 718

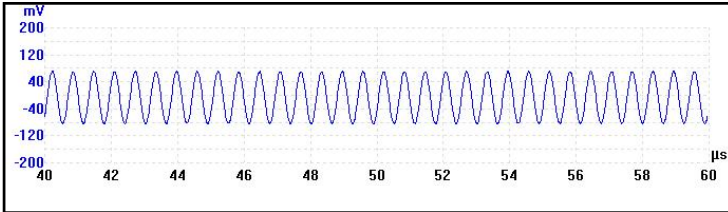

Sine wave out of Icom 718 at 1,604,000 Hertz.

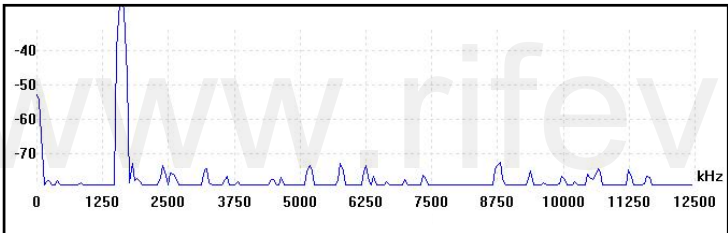

Icom 718 at 1,604,000 Hertz measured with spectrum analyzer showing no harmonics.

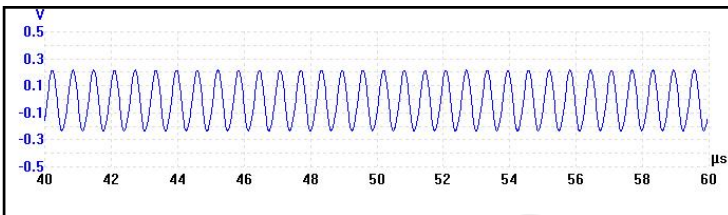

Sine wave out of Icom 718 at 1,604,000 Hertz using the antenna tuner.

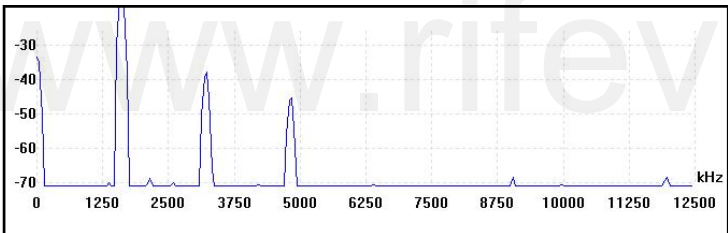

Icom 718 and antenna tuner at 1,604,000 Hertz measured with spectrum analyzer showing two harmonics. These two harmonics are only produced because the Icom is not designed to go below 2,000,000 Hertz. If you output 2,000,000 Hertz it produces no harmonics.

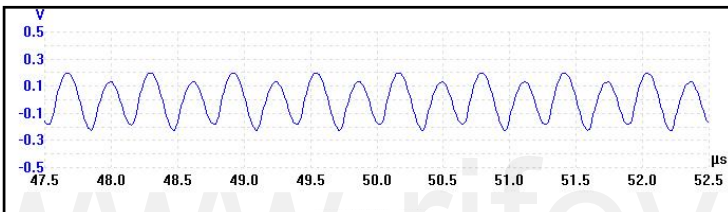

Sine wave out of Icom 718 at 1,604,000 Hertz using antenna tuner and ray tube. Sine wave is distorted. In all tests done the sine wave was always distorted when put through a ray tube.

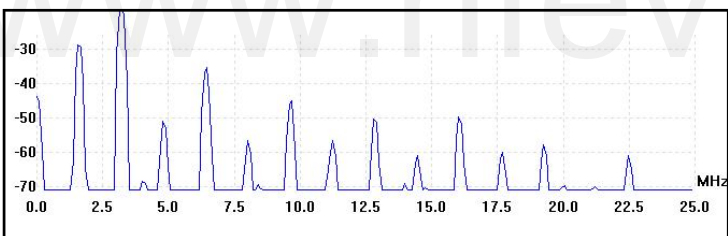

Icom 718 at 1,604,000 Hertz using antenna tuner and ray tube. Measured with spectrum analyzer showing harmonics all the way up to 22,000,000 Hertz. This shows that Dr. Rife's Kennedy Model 110 which only had a top range of 2,000,000 Hertz did produce harmonic frequencies in the 11,000,000 and 17,000,000 hertz range.

Below are the measurements taken with the PicoScope 3205 spectrum analyzer from the Icom 718 using the antenna tuner and ray tube at 11,780,000 Hertz. This was the first frequency Dr. Rife listed on his pre-1934 lab notes which was later changed to 1,604,000 Hertz.

Testing done with PicoScope 3205 spectrum analyzer at 11,780,000 hertz using Icom 718

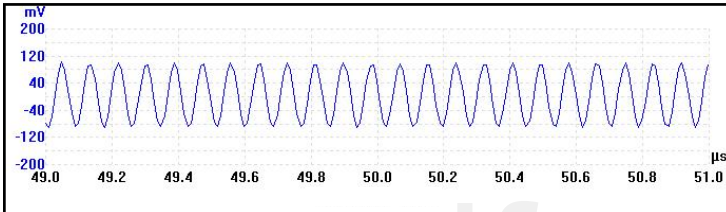

Sine wave out of Icom 718 at 11,780,000 Hertz.

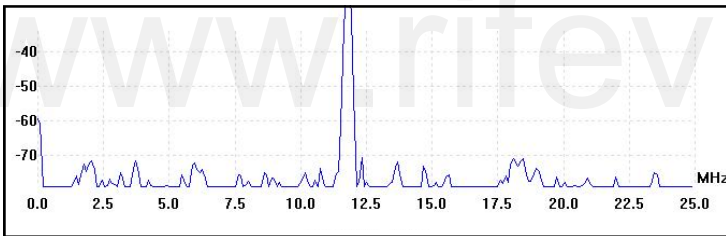

Icom 718 at 11,780,000 Hertz measured with spectrum analyzer showing no harmonics.

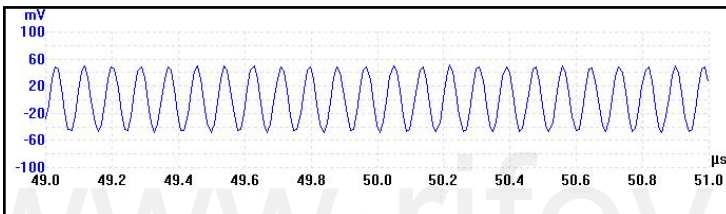

Sine wave out of Icom 718 at 11,780,000 Hertz using the antenna tuner.

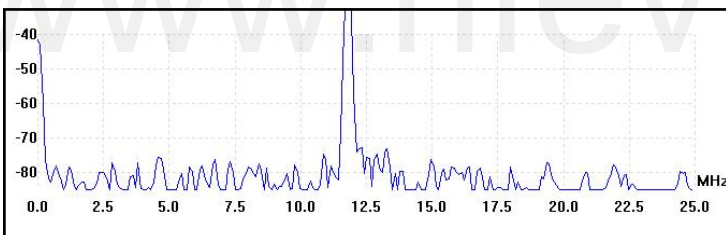

Icom 718 and antenna tuner at 11,780,000 Hertz measured with spectrum analyzer showing no harmonics.

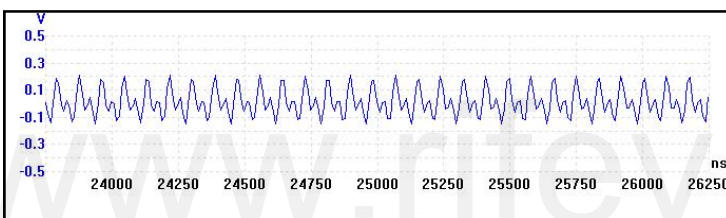

Sine wave out of Icom 718 at 11,780,000 Hertz using antenna tuner and ray tube. The sine wave does not look like a sine wave. In all cases the sine wave is distorted to some degree when put through a ray tube.

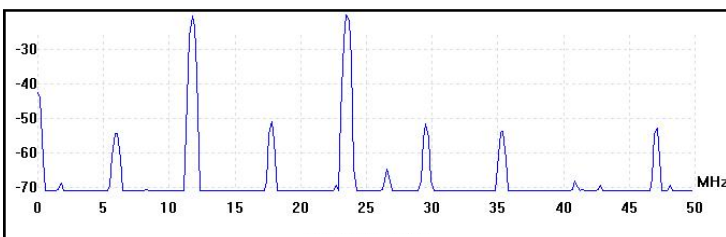

Icom 718 at 11,780,000 Hertz using antenna tuner and ray tube. Measured with spectrum analyzer showing harmonics all the way up to 50 MHz.

Below are the measurements taken with the PicoScope 3205 spectrum analyzer from the Icom 718 using the antenna tuner and ray tube at 17,033,000 Hertz. This was the second frequency on his pre-1934 lab notes which was recorded in meters. This was later changed to 187 meters which would give us a frequency of about 1,604,000 Hertz. This confirms that Dr. Rife was just reading a harmonic at 17,033,000.

Testing done with PicoScope 3205 spectrum analyzer at 17,033,000 hertz using Icom 718

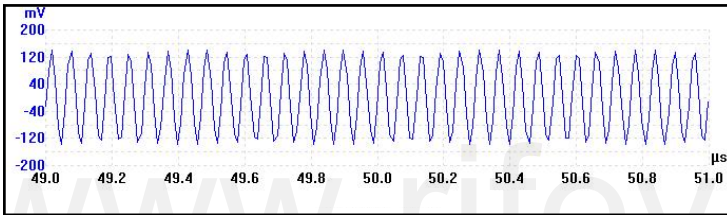

Sine wave out of Icom 718 at 17,033,000 Hertz. Some distortion was in the sine wave.

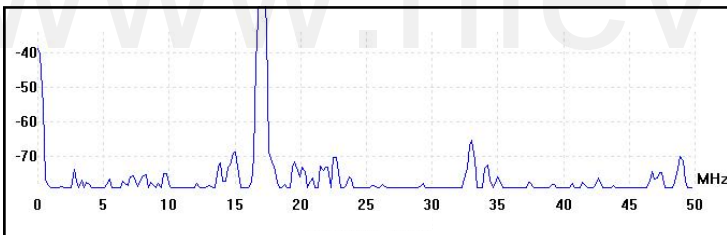

Icom 718 at 17,033,000 Hertz measured to 50 MHz with spectrum analyzer showing no harmonics.

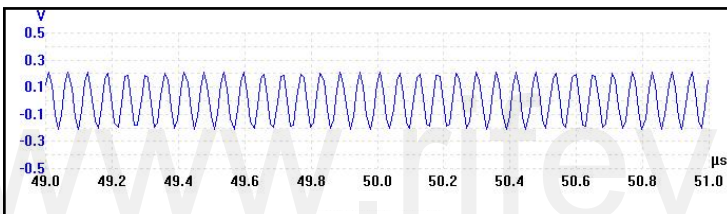

Sine wave out of Icom 718 at 17,033,000 Hertz using the antenna tuner. Same slight distortion noticed.

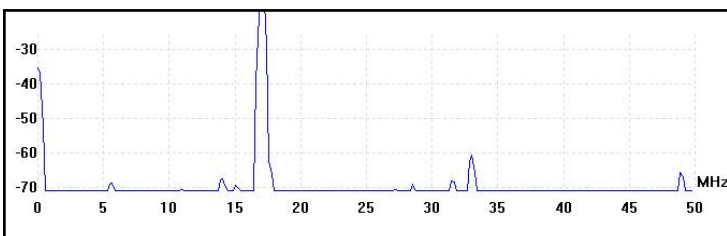

Icom 718 and antenna tuner at 17,033,000 Hertz measured to 50 MHz with spectrum analyzer showing no harmonics.

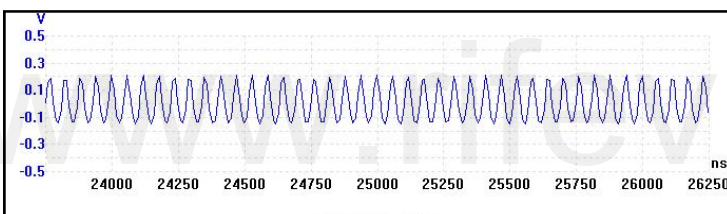

Sine wave out of Icom 718 at 17,033,000 Hertz using antenna tuner and ray tube. Sine wave was distorted even more when put through a ray tube.

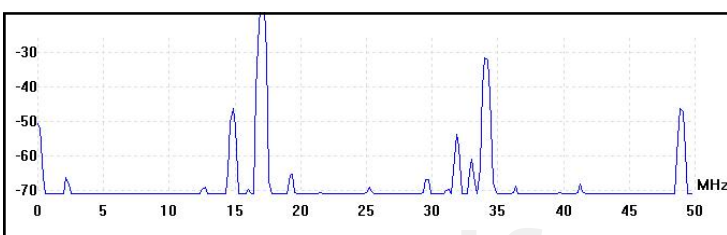

Icom 718 at 17,033,000 Hertz using antenna tuner and ray tube. Measured with spectrum analyzer showing harmonics all the way up to 50 MHz.

Westinghouse RC Receiver & Amplifier

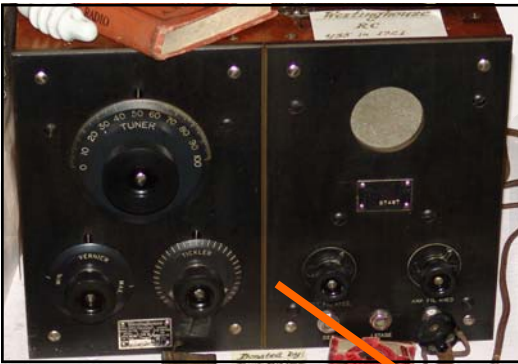

Western Electric Audio Amplifier 7A



Kennedy Model 281 Receiver



Photo of Rife's equipment that he used in his lab for doing M.O.R. work.

Five stage 50 watt class A cascade RF amplifier

The three photos of Rife's lab on this page are courtesy of the Rife Research Group of Canada.

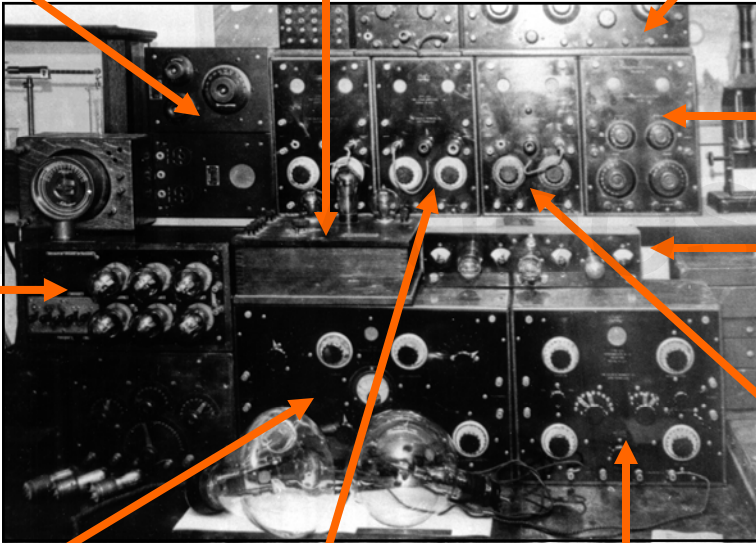

Kennedy RF Amplifier

Remler 700 I.F. Amplifier 3.5 MHz



Kennedy Model 110 and 525 Audio Amplifier



Kennedy Model 220 and 525 Audio Amplifier

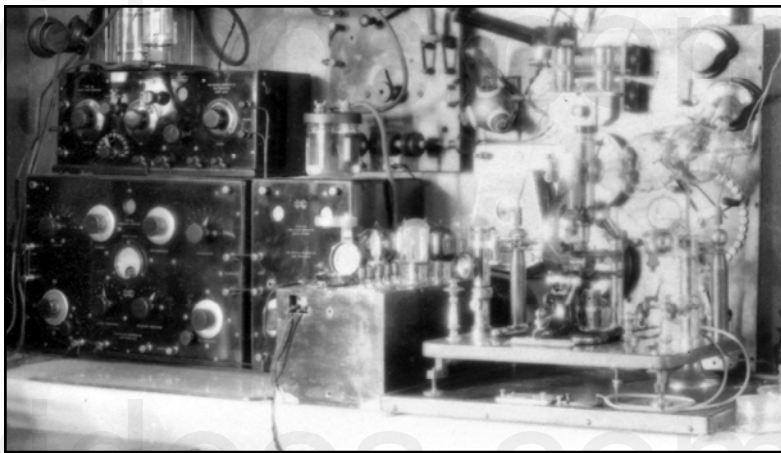
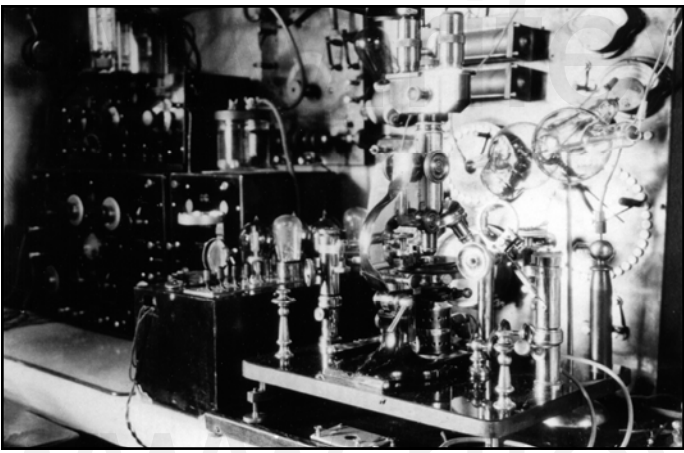

Kennedy Model 110, 281 and 525 Audio Amplifier Set Up In Rife's Lab For Doing M.O.R Work

After having done all this spectrum analysis testing we now know how Dr. Rife misread his frequencies. The ray tube gave him the harmonics that he read. Also, he evidently did not read the harmonics correctly. Philip Hoyland read the frequencies correctly because he was an electronics engineer and had the ability to read the frequencies properly. We wish to mention that we do not feel this in any way diminishes or questions the brilliance of Dr. Rife. Even Dr. Rife himself said he was not an electronics man and never claimed to be one. He made a mistake that any untrained person could have easily made.

Having said this, let's move on to the facts. Philip Hoyland read 1,604,000 Hertz for the frequency of the BX cancer virus. Dr. Rife corrected his lab notes to this frequency. This frequency was used in the later Rife Ray #4 instrument. With these documented facts, we now know what must have happened. Dr. Rife read the seventh harmonic of 1,604,000 Hertz and recorded it on his pre-1934 lab notes. The only problem was he was unable to read the seventh harmonic correctly and misread it as 11,780,000 Hertz. It should have been 11,228,000 Hertz because this is the actual harmonic frequency that came out of the ray tube. Dr. Rife had two different pieces of equipment for reading frequencies - one which read in cycles per second and the other which read in meters. These types of meters to measure wavelengths were common electronic equipment, just as digital frequency counters are in common use today. Wavelength meters were much harder to use and measure frequencies with if you don't really understand how to use them. We know that this was the case. Dr. Rife then misread the eleventh harmonic of 1,604,000 Hertz. This harmonic should have been 17,644,000 Hertz instead of the 17,033,000 Hertz. Again, we know from the corrected lab note read by Henry Siner that the cycles per second and meters frequencies should match. In these early pre-1934 lab notes none of the cycles per second and meter frequencies matched. This shows he used two different pieces of equipment to read the frequencies. The final fact is the Kennedy Company equipment could only output frequencies to about 2,000,000 Hertz (far below the 11 and 17 MHz range).

When we read the Kennedy Model 110 the instrument was surprisingly accurate. Dr. Rife could have very easily hit the frequency he wanted within the tolerances he gave. He gave "one tenth of one meter" as a gage to show how close you had to be to an organism's M.O.R. At 1,604,000 Hertz this would be 858 Hertz. He said if you were off by this amount the frequency wouldn't work. With that in mind it would be necessary to be within a few hundred Hertz of the BX M.O.R. in order to make sure the frequency was effective. The Kennedy instrument could hit within 200 to 300 Hertz very easily at 1,604,000 Hertz. After changing the dials and then coming back to the same dial settings you could get within 2000 to 6000 Hertz at 417,000 Hertz. This is less than 1% inaccuracy which is quite amazing. Even Philip Hoyland, when he measured the frequencies rounded off all but one frequency to the nearest thousandth. The testing of the Kennedy Model 110 shows that the frequency for the BX is most likely somewhere between 1,600,000 and 1,608,000 Hertz, however it could be as much as 10,000 Hertz plus or minus of 1,604,000 Hertz. All of the frequencies are only close and this should be considered when using them. One fact that helps to point this out is Philip Hoyland read 1,604,000 Hertz for the frequency of the BX. He also gave 187 meters as the frequency. One hundred and eighty seven meters is 1,603,168 Hertz. This is a difference of 832 Hertz and shows why the frequencies are only close. Today's frequency generating equipment is very accurate at hitting a specific frequency but in Dr. Rife's era this was not the case. Dr. Rife's microscope gave him an advantage that we do not have. He could see the organism die.

So now that we know that Dr. Rife's Kennedy Model 110, 220 and 281 only went to 2,000,000 Hertz with harmonics going to about 20,000,000 Hertz (see graph below). We have to ask this question: What frequency is really the true M.O.R? Is it the 1,604,000 Hertz or a harmonic of it? The ac-

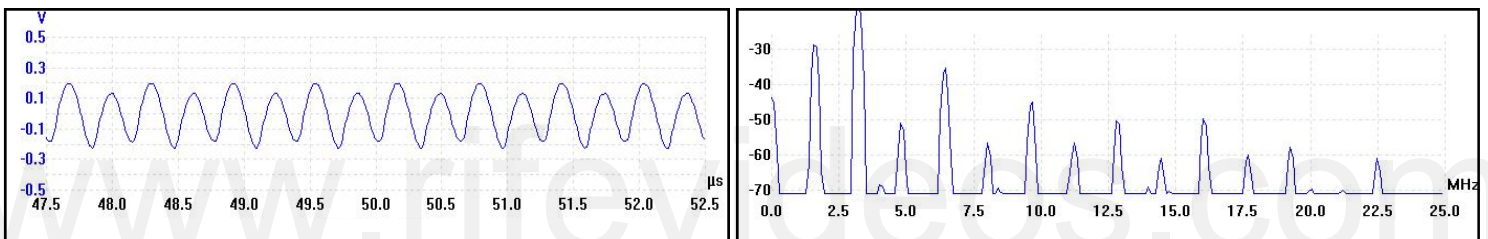

tual M.O.R. frequency could have been very easily a harmonic, and Dr. Rife would have never known it. The below spectrum analyzer graph of 1,604,000 Hertz shows it could be any one of these harmonics. Since the ray tube is what produces these harmonics it may be very important to have all these harmonics. Myth Busters, a cable television program did a test to see if they could break a crystal glass with sound waves. They found when they used only the fundamental frequency without the harmonics they could not break the glass. But when they used the harmonics along with the fundamental frequency then they were able to break the glass. This may or may not be pertinent but it is something that should be considered.

With this in mind we decided to see if there was a way that we could duplicate the harmonics without having to use a ray tube. The below reading with the spectrum analyzer below showed that if we distorted the sine wave no more than what the ray tube did we could produce the same harmonics as a ray tube. The reading was done at 1,604,000 Hertz taken from an off-the-shelf GB-4000 Function Generator. This test showed it was very easy to duplicate the harmonics produced by a ray tube. We decided to test a triangle wave since the distorted sine wave out of the ray tube resembled it. It also produced the same harmonics as a ray tube. Then we gated an undistorted sine wave and it produced the harmonics. It is apparent that any sine wave frequency from any frequency generator, when gated will produce harmonics.

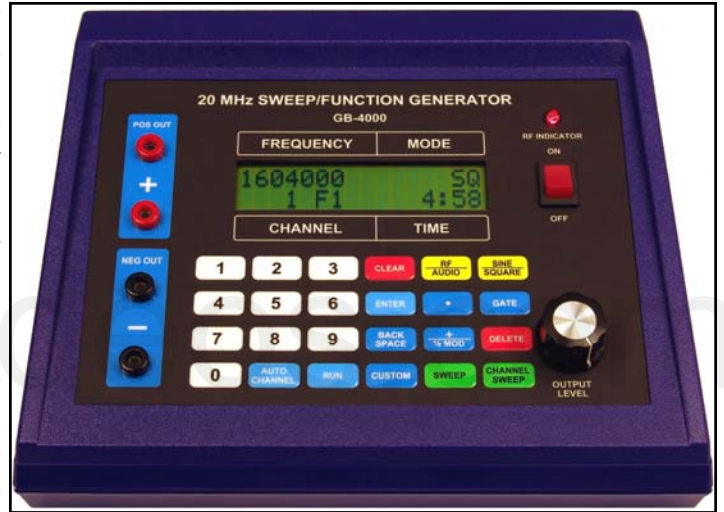

GB-4000 20 MHz Sweep Function Generator. Instrument used for the tests.

GB-4000 at 1,604,000 hertz using PicoScope 3205 Spectrum Analyzer

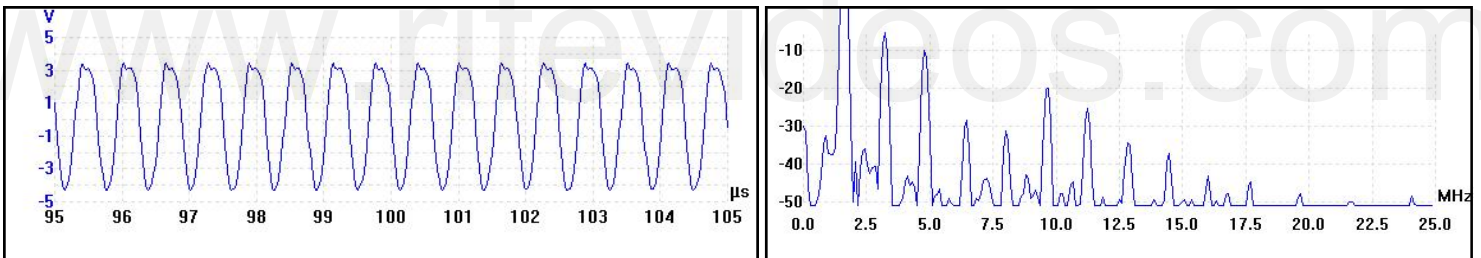

www.rifevideos.com

www.rifevideos.com



We will now discuss Dr. Rife's tuning of the Kennedy Receiver Model 110 using headphones. In the photo above, on the left, you can see a set of headphones on the Model 525 audio amplifier. Headphones were used to tune the Kennedy Receiver Model 110 and Dr. Rife's earlier instrument that he used before purchasing the Kennedy equipment. When Dr. Rife first tested the audio range of frequencies he would tune his instrument using headphones. Bertrand Comparet, Rife's attorney for the Beam Rays trial of 1939 made this statement when he was interviewed by Dr. John Hubbard:

COMPARET: *"Way back in the old days, way, way back, Rife told me that the way he used to tune his instrument, which in those primitive days was, I guess, garbled. He would hook up headphones and turn the thing. He had a very keen musical sense of pitch and so on, and he would tune it in his headphones until he got the right pitch, and that was the frequency."* ([1970's Bertrand Comparet interview #89](#))

The headphones were used for tuning the audio frequencies in Dr. Rife's early tests when he used loose couplers. The headphones also played an important role in the tuning of the Kennedy Receivers. In the second photo, above on the right, you can see the regeneration dial of the Kennedy Receiver Model 110. When you turned up the regeneration you would listen for clicks or some static in the headphones, this would tell you that the instrument was oscillating. If you turned the regeneration up too high you would hear feedback in the headphones. This feedback meant you did not have a pure sine wave waveform. The photo below, on the left, is the waveform with the feedback from the Kennedy Receiver Model 110. It is a form of audio modulation. The other photo, below on the right, is what is produced when there is no feedback. Dr. Rife always wanted to use a pure waveform. The fact that we could actually listen to the original type of equipment that he used made it so we could understand what Dr. Rife was doing.

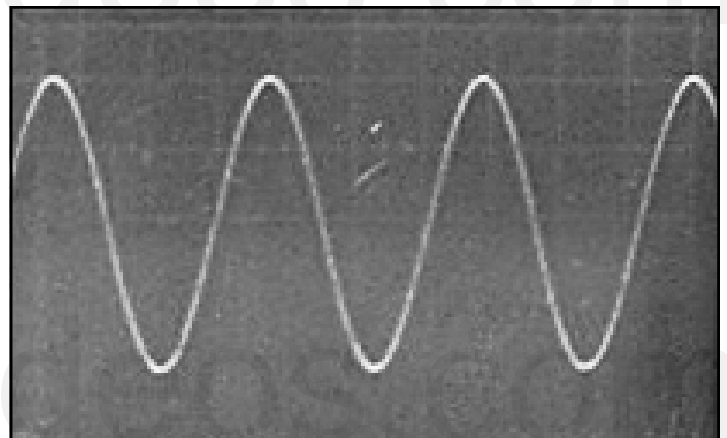
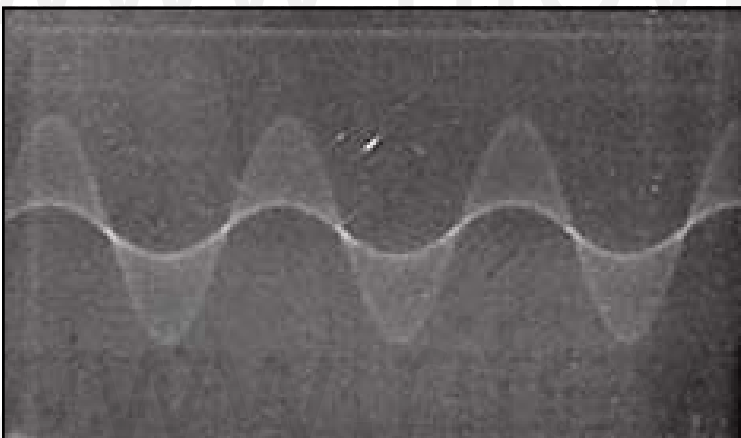

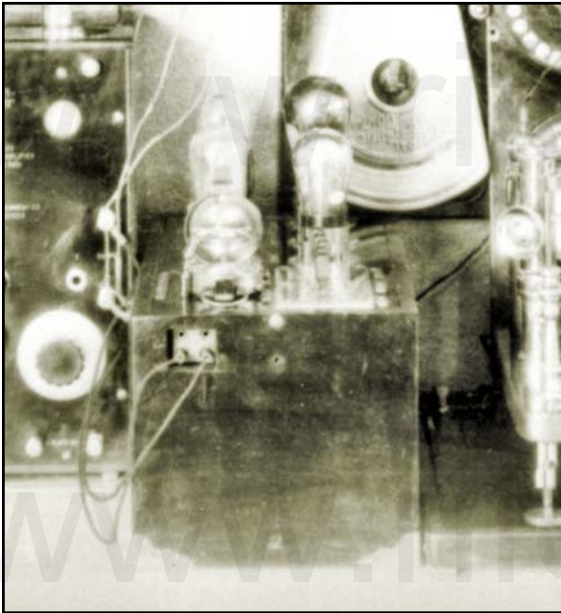
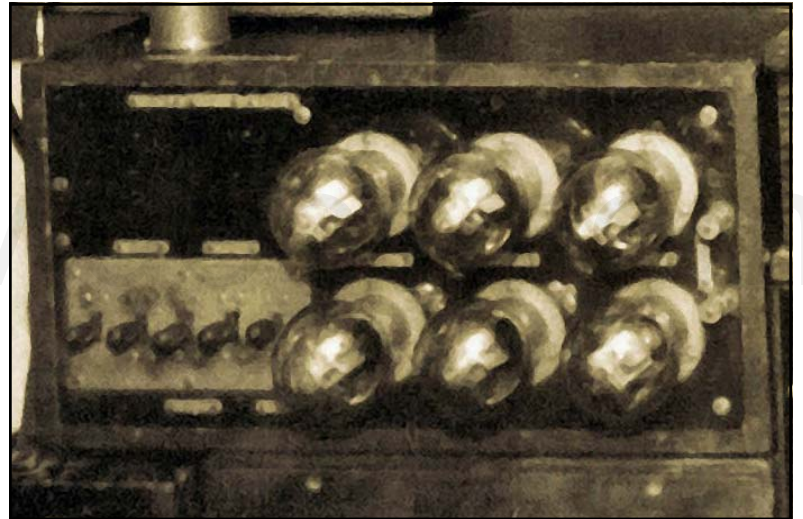

We will now discuss Dr. Rife's multi-stage-amplifier that he used with the Kennedy equipment. This was most likely a class A RC coupling cascade style amplifier. Daven Company started building this type of amplifier back in about 1925. Dr. Rife may have had Daven custom build his multi-stage-amplifier but we cannot be sure. The two photos, at the bottom of this page, are Daven amplifiers. One is a three stage amplifier and the other is a four stage amplifier. The Kennedy Receiver Model 110 only output about 1.5 to 3 volts. Dr. Rife needed to be able to amplify the signal to a high enough power level to make it effective. In the three old lab photos above we see Dr. Rife's multi-stage-amplifier. In the above photo, bottom right, you can see the type of tubes he would have used in the early to mid 1920s. These tubes would have made it so Dr. Rife could amplify the signal from the Kennedy Receiver Model 110 to about 50 watts in multi-stages. If you look at the above three photos of Dr. Rife's multi-stage-amplifier you will see five switches. These five switches (representing five-stages) made it so he could choose different power levels determined by how many stages of amplifi-

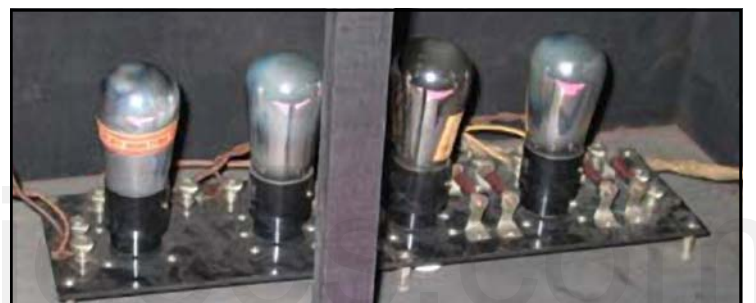

cation he wanted to use. With this configuration he could have easily produced the 50 watts he said he used. This 50 watts, was the power level that was mentioned in the Rife CDs for this instrument.

Ben Cullen, a close friend of Dr. Rife's, mentions on the Rife CDs that Dr. Rife would light the ray tube with a separate power source. His lab photos show a spark gap transmitter which he used to light the ray tube. If you look at Dr. Rife's lab photo, top right, you can see the spark gaps. The photo below the lab picture shows a spark gap transmitter diathermy from the 1920s. We purchased it so we could test the lighting of a ray tube with it. The next photo below the spark gaps shows the lighting of the ray tube using this spark gap transmitter. It lit the ray tube with ease and could output more power than the ray tube could handle.

This spark gap transmitter would make it so Dr. Rife didn't have any difficulties tuning the ray tube when he changed frequencies from a low frequency of 139,000 hertz to a higher frequency of 1,604,000 hertz. The spark gap transmitter had a damped waveform and would have given him a damped wave carrier frequency (see the photo, bottom right) most likely somewhere around one Megahertz. This transmitter we purchased has a frequency of 920 KHz. Dr. Rife would not have modulated frequencies onto this carrier frequency but would have just mixed the frequencies in the ray tube (photo below is of sine & spark mix).

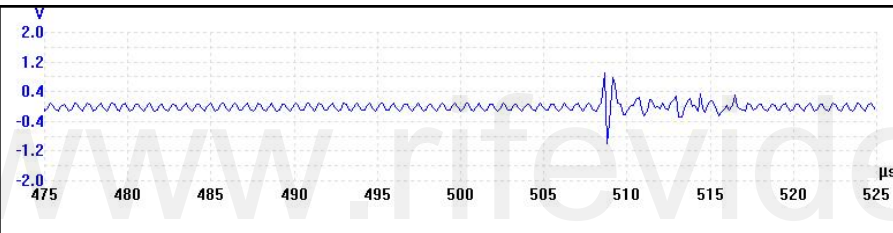
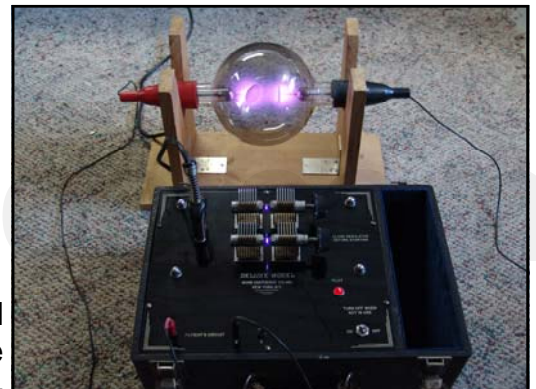
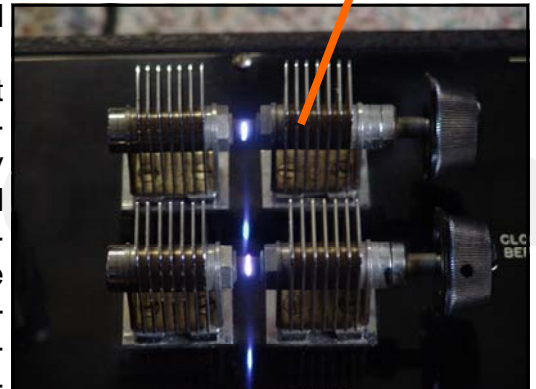
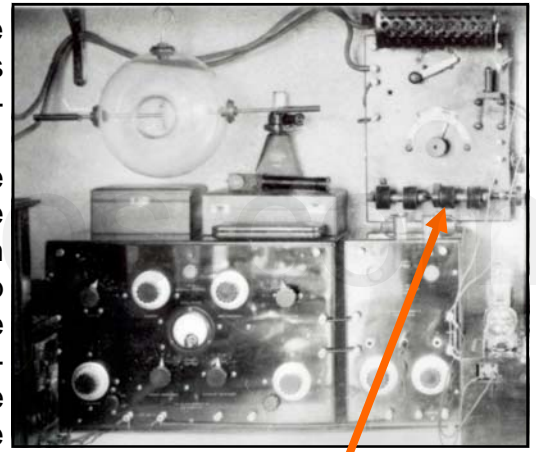

Mixing would have given him the combination of a damped wave and one or two sine wave frequencies, depending on if he used two sine wave frequencies simultaneously. We do not believe that Dr. Rife continued to use a spark gap transmitter because it would have made it impossible for him to read the ray tube harmonic frequencies that his ray tube output. This is because a spark gap outputs broadband noise that makes it impossible to read any harmonic frequencies. Dr. Rife must have only used the spark gap transmitter in his early work. The Beam Rays instrument built by Philip Hoyland used an audio frequency to gate the RF frequencies it output. This audio frequency gate will be discussed when we look at the Beam Rays instrument.

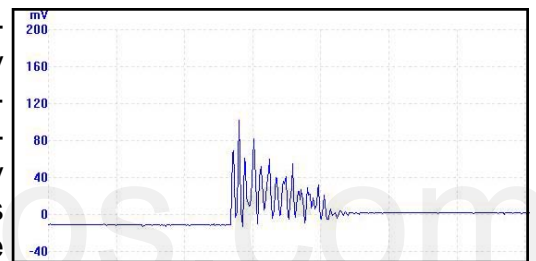

Spark gap damped waveform

This gating would have given Dr. Rife's frequencies a very high potential voltage spike almost identical to a damped wave. John Crane made this statement when he was narrating Dr. Rife's lab film.

CRANE: "Now the spikes that you see on the frequencies are the lethal part that kill and devitalize the virus. They are the resonant peaks of the frequencies which increase the voltage to a very high potential which the cells of the virus wall can not tolerate and they break up into many pieces and are destroyed." (Dr. Rife's Lab Film Narrated by John Crane in the 1970s)

The audio gate frequency is the reason why Dr. Rife was able to devitalize the many microorganisms he tested. We will now discuss Dr. Rife's frequencies. He described the method he used to find these frequencies on the Rife audio CDs.

RIFE: *"Because when I check on that thing and look through that microscope hour after hour day after day, tuning that damn thing [Kennedy 110] to find something that will kill that bug. And every hour or half an hour, whatever is required, I put a new fresh culture under the microscope and keep that on and I find something that folds it up, alright!"* ([John Marsh Rife CDs - CD 7 track 2](#))

Below in the chart are Dr. Rife's misread lab note frequencies which he recorded prior to 1935. Each lab note had two frequencies. One was listed in cycles per second and the second was listed in meters. For the purpose of making this article easier to understand the meter frequencies on Dr. Rife's lab notes have been converted to cycles per second or hertz. You will notice that there are two audio frequencies listed for organisms that are above 12,000 hertz. They are the only audio frequencies ever listed by Dr. Rife for any organisms. One of them was changed to a higher RF frequency when Philip Hoyland read the correct frequencies. Most likely the other audio frequency was really a higher RF frequency.

Dr. Rife's Misread Lab Note Frequencies From Before 1935		
Microorganism	First Frequency In Hertz	Second Frequency Meters To Hertz
Actinomycosis (Streptothrix)	678,000 Hz	186,554 Hz
Anthrax	900,000 Hz	272,539 Hz
Anthrax Symptomatic	400,000 Hz	16,655 Hz
B. Coli (Rod form)	683,000 Hz	317, 914 Hz
B. Coli (Filterable virus)	8,581,000 Hz	11,103,424 Hz
Bacillus X Cancer	11,780,000 Hz	17,033,662 Hz
Bubonic Plague	160,000 Hz	512,466 Hz
Catarrh	1,800,000 Hz	1,713,100 Hz
Cholera Spirillum	851,000 Hz	960,873 Hz
Contagious Conjunctivitis	1,206,000 Hz	2,025,625 Hz
Diphtheria	800,000 Hz	1,090,154 Hz
Glanders	986,000 Hz	736,591 Hz
Gonorrhoea	600,000 Hz	150,649 Hz
Influenza	1,674,000 Hz	1,946,704 Hz
Leprosy	743,000 Hz	251,926 Hz
Pneumonia	1,200,000 Hz	381,901 Hz
Spinal Meningitis	927,800 Hz	1,795,164 Hz
Staphylococcus Pyogenes Aureus	998,740 Hz	555,171 Hz
Staphylococcus Pyogenes Albus	Found in Dr. Rife's papers	549,070 Hz
Streptococcus Pyogenes	1,214,000 Hz	2,111,214 Hz
Syphilis (Treponema Pallidum)	900,000 Hz	2,775,856 Hz
Tetanus	700,000 Hz	15,779 Hz
Tuberculosis (Rod form)	583,000 Hz	541,142 Hz
Typhoid Fever (Rod form)	900,000 Hz	868,964 Hz
Typhoid Fever (Filter passing)	9,680,000 Hz	13,943,835 Hz

1935 Rife Ray #4 instrument

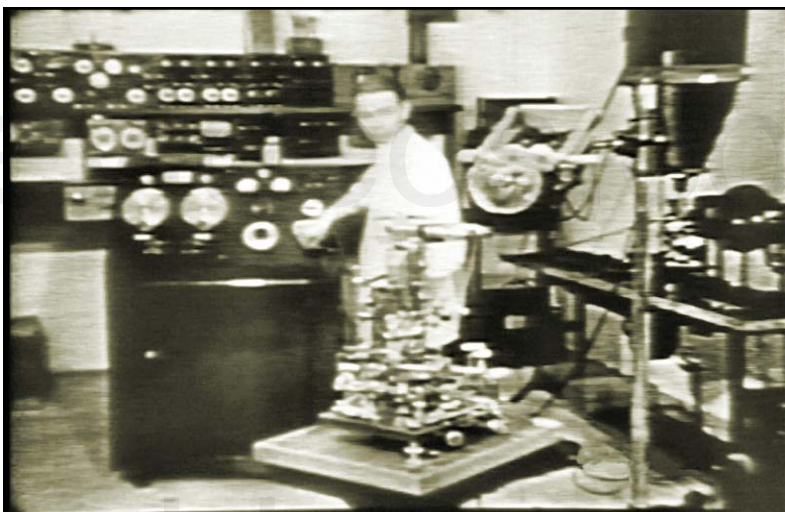
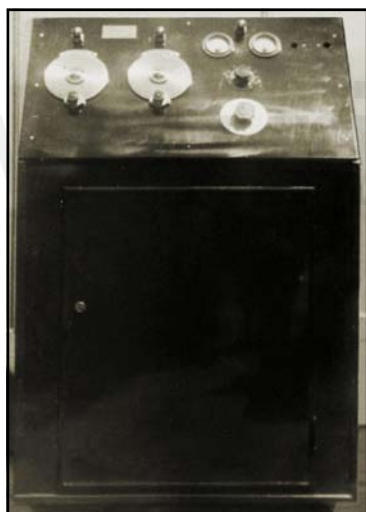

- 1) Used a ray tube.
- 2) Had two separate oscillators so it could output two frequencies at a time. Frequency range was from 87,000 Hertz to 22.5 MHz.
- 3) Power usage was about 450 to 600 watts. Output to the ray tube was variable (50 to 100 RF watts).

Some have asked how we can be sure these photos we have are of the Rife Ray #4. It is a simple process of deductive reasoning. John Crane, one of Dr. Rife's 1950's business partners, incorrectly dated the Rife Ray #4 as a 1942 instrument and this has led to the confusion which we will now attempt to clear up. In the photo above on the right we see Dr. Rife using the instrument which John Crane dated as built in 1942. However, the lab film this picture was taken from was made in the summer of 1936 for use at a conference which Dr. Rife planned to attend in the autumn of that same year. He was presenting this film at this conference to demonstrate the isolation of the BX cancer virus. This properly dates the instrument as having been built before the summer of 1936 and indicates that John Crane was incorrect. In the background of this photo, behind the instrument Dr. Rife is using, we see his Kennedy Company equipment back against the wall. Therefore this instrument would have been built in late 1935 or early 1936. The Rife Ray #4 documents show it was completed in the fall of 1935. This logically dates the instrument he is using in the 1936 film as the Rife Ray #4. Bertrand Comparet, Dr. Rife's attorney, said three of these instruments were built. Dr. Milbank Johnson, M.D., used one in his clinic in 1936 and Dr. Rife had one in his lab. It is not known what became of the third instrument.

With the proper dating of this instrument (which shows it is the Rife Ray #4) we will now discuss it in detail. As pointed out earlier in this article Philip Hoyland built the Rife Ray #4 instrument for Dr. Rife and Dr. Johnson in 1935. The Rife Ray #4 instrument documents show it could put out two RF or radio frequencies simultaneously. Dr. Rife's previous Kennedy Model 110 when connected to the Model 281 could output two frequencies simultaneously like the Rife Ray #4. The Rife Ray #4 also had a fixed audio frequency gate or pulse circuit. The waveform that it output was shown in Dr. Rife's lab film and is the photo, lower right corner, of this page. The other photo, lower left, is a clearer photo of what a damped wave looks like.

How Dr. Rife created this waveform was not known until a circuit from an original Beam Rays Laboratory instrument was rebuilt. This circuit will be discussed in detail later in this paper when we cover that instrument.

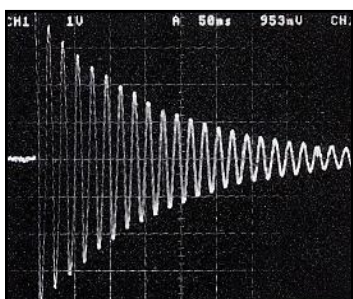

Though we will discuss the building of this circuit later the importance of that gating circuit will be discussed now. The reason for this is without this gating circuit no organism could have been devitalized. This gating circuit was the secret to making Dr. Rife's high RF frequency instruments work. Bertrand Comparet, Dr. Rife's attorney said this in his 1970s interview:

COMPARET: *"The whole secret of the Rife thing was the audio frequency because Rife, way back in the old days, way, way back, Rife told me that the way he used to tune his instrument...he would hook up headphones and turn the thing. He had a very keen musical sense of pitch and so on, and he would tune it in his headphones until he got the right pitch, and that was the frequency."*

This audio frequency gate was put into the Rife Ray #4 as a fixed audio frequency. It was not a variable audio frequency circuit. The Rife Ray #4 instrument documents show it had no variable audio oscillator which indicates that Dr. Rife believed that it was no longer necessary for M.O.R. work. All of the frequencies that Philip Hoyland read from the Kennedy Model 110 and transferred to the Rife Ray #4 were RF frequencies. The lowest frequency was for Anthrax at 139,200 Hertz; the highest was 1,604,000 Hertz for the BX organism that caused cancer. The Rife Ray #4 would have also been a sine wave instrument just as the Kennedy Company equipment was. Since the Rife Ray #4 had two high RF frequency oscillators it could allow for the oscillators to be set at two different M.O.R.s. This instrument was probably built much like the Beam Rays Laboratory instrument which connected the ray tube between the two RF oscillator tank coils. The reason for this is the fact that the bandwidth of the RF tank coils could only pass a frequency of about 250,000 hertz and Dr. Rife was using frequencies much higher than this. However, Dr. Rife in some of the documents mentioned a carrier wave. It is doubtful the Rife Ray #4 instrument had a fixed carrier frequency but this cannot be positively excluded. The gate pulsing circuit would modulate the fixed damped wave audio frequency with any RF frequencies output from the instrument. The Kennedy equipment could output only two frequencies, one from the 110 and the other from the 281. With the Kennedy equipment he used a third frequency which would have been the carrier frequency. The carrier frequency would have been used to make sure the ray tube stayed lit while he output two other frequencies simultaneously. This carrier frequency was probably only used with the Kennedy equipment because the #4 instrument could easily light the ray tube throughout its full frequency range without the need of it. This statement of Dr. Rife's verifies the fact that with the Kennedy equipment he did use a third frequency as a carrier frequency.

RIFE: *"We found the frequency of the virus, we found the frequency of the rod, which we had for years of course. But if we use the two of them simultaneously over the same carrier wave, the patient gets well and the Guinea pig gets well, but if you use one or either individually you either kill the patient or you don't do nothing". ([Marsh collection, Rife audio CDs](#))*

Dr. Rife used the Rife Ray #4 in his lab for years. Dr. Johnson used his Rife Ray #4 instrument in at least three medical trials. On page 31 is one of his release cards that each patient had to sign in order to be treated with the frequencies output by the Rife Ray #4 instrument. When Dr. Johnson was using his Rife Ray #4 instrument in his lab he had an interesting effect take place when he was testing some other band of frequencies. He wrote about what happened in a letter which he sent to Dr. Gruner and Dr. Rife on November 4, 1936:

DR. JOHNSON: *"Last summer, in hunting for the M.O.R. for the other two reproductive forms of the cryptomyces pleomorphia, we ran into a new band of oscillations which introduced itself to us by killing all three forms - those that we called BX, our filter-passing form; then a transitional form such as you found in the monocytes in the blood; and then the third or highly developed form coming from the sporangium forming from the hyphae of the mycelium. At the same time that this new wave band arrived, we broke all the glass in the laboratory of a certain shape, not only in the room where we were working but in all the other rooms...we had been troubled a great deal with a mold because in the microscope room there were no windows, but this band not only destroyed that mold, which was growing on the*

leather objects in the room, but every bacteriological culture that we had in the laboratory! It cleaned us out completely so we had to start from scratch and replace our losses. In fact, we were all so surprised that we began to feel each other's pulses to see if we were still alive. As no harm had been done to us, we proceeded to test the new band out on mice, rats, rabbits, guinea pigs and dogs. So far as we were able to discover, it is not at all destructive or injurious to normal cell tissue. While we have been forced to modify our machine so as to produce this new band, still it is so much more effective clinically that we look upon it as a very advantageous discovery. However, our experience has forced us to do all of our experimenting with the new ray completely outside of our laboratory building or abandon all form of bacteriological experiments, because it instantly kills them all." (Page 1, Page 2)

It appears the Rife Ray #4 oscillators somehow malfunctioned. What happened is not really made clear from this letter only the fact that they were using a different frequency band and different frequencies on the organisms which devitalized them. It is apparent from this letter that these frequencies most likely were harmonics of the original frequencies Dr. Rife found. These frequencies would have been higher frequencies, not lower frequencies, since Dr. Rife already found the lowest frequency when he found the original M.O.R.s. The Rife Ray #4 instrument didn't have a variable audio oscillator so this rules out any audio frequency. Since Dr. Rife felt that many of his frequencies were harmonics, or in reality sub harmonics of higher frequencies then this indicates that there are probably many harmonics of these frequencies that will devitalize the organisms. This is an important concept since Philip Hoyland started working on a harmonic instrument during the summer of 1936. It is possible that he came up with this new instrument concept because of what had taken place with Dr. Johnson. This harmonic instrument became the Beam Rays Clinical instrument and we will talk about it later.

Below are the sine wave frequencies read off of the Kennedy Company equipment and used in the Rife Ray #4 instrument. We now know these frequencies were the frequencies used in the 1934 clinic.

Rife Ray #4 Sine Wave High RF Frequencies	
Actinomycosis (Streptothrix)	192,000 Hz
Anthrax	139,200 Hz
B. Coli (Rod form)	417,000 Hz
B. Coli (Filterable virus)	770,000 Hz
Bacillus X or BX (Cancer Carcinoma)	1,604,000 Hz
Bacillus Y or BY (Cancer Sarcoma)	?1,530,000 Hz
Gonorrhea	233,000 Hz
Spinal Meningitis	427,000 Hz
Staphylococcus Pyogenes Aureus	478,000 Hz
Staphylococcus Pyogenes Albus	549,070 Hz
Streptococcus Pyogenes	720,000 Hz
Syphilis	789,000 Hz
Tetanus	234,000 Hz
Tuberculosis (Rod)	369,000 Hz
Tuberculosis (Virus)	?769,000 Hz
Typhoid Fever (Rod)	760,000 Hz
Typhoid Fever (Virus)	1,445,000 Hz

[The Rife Ray #4 document](#) that the frequencies in the previous chart on page 30 were taken from is located at www.rife.org. This same document along with its [additional page](#) was mentioned in a letter written by Dr. Milbank Johnson to Dr. Rife dated October 15, 1935:

Dr. JOHNSON: *I am also inclosing a copy of a chart prepared for me by Phil [Philip Hoyland] which show the frequencies in kilocycles of the different M.O.R.'s we have worked with. Opposite these frequencies you will find the proper switch and settings on both groups. Now, in looking over the frequencies representing the M.O.R. of certain organisms, I find that the typhoid rod has 760 kc. And just above that you will find that the typhoid filter passing has 1445 kc. - that is almost an exact harmonic of the rod. Assuming that the banana might represent the rod form of the cryptomyces pleomorphia - on the same plan let us assume that the B.X. is the filter passing form of this organism. If that is so, we should kill the rod, it being the harmonic of the rod form, at 800 kc. [this statement verifies that the BX M.O.R. frequency was 1.604 kc. - or 1,604,000 hertz]. This 800 kc. Will come in group No. 2 on switch 6. A reference to the proper chart under Group No. 2 would give the exact setting to get 800 kc. This is just a chance and I have no assurance that it will work out, but I think it is worth trying so I think I would try on switch 6 in Group N. 2 for your first effort to kill the fungus, or rather to kill the bananas. ([Letter from Dr. Milbank Johnson to Dr. Rife, October 15, 1935](#))*

RELEASE

It has been determined that I, F. G. Adamson, am suffering from a malignant disease

which I believe to be Sinus infection and I am informed that Dr. Milbank Johnson and his associates have been experimenting with a new method of treatment of said disease upon the lower animals with sufficient success to lead me to hope that it may be successful in my case. However, I wish it distinctly understood that neither Dr. Milbank Johnson nor his associates have made any promises, claims, representations or other assertions as to the outcome of their new method of treatment; Dr. Milbank Johnson and his associates have agreed to subject me to their new method of treatment without charge to me and in consideration of their services in this connection, I hereby consent to allow Dr. Milbank Johnson and his associates to subject me to their new method of treatment of my disease and further do consent to allow said Dr. Milbank Johnson and his associates to subject me to any other type of treatment, whether operative or otherwise, that they may in their opinion deem necessary or advisable in connection therewith or as a result thereof; and further, I hereby release said Dr. Milbank Johnson, his associates, employees and attendants, from any and all liability for any untoward results that I may suffer in connection with or as a result of any such treatment or treatments, whether operative or otherwise, with the full realization on my part of the experimental character of said new method of treatment. I agree that this consent and release shall be binding upon my heirs and legal representatives and that the same shall extend to and release the heirs and legal representatives of said Dr. Milbank Johnson, his associates, employees, and attendants. It is further understood that this release shall extend to and include any hospital or clinic that Dr. Milbank Johnson or his associates may be associated with, and also their respective staffs, employees, and attendants.

I have asked certain of my relatives to agree to the terms of this instrument and they have signed below.

Dated at San Diego this 24th day of August 1936

Witness: _____

F. G. Adamson
PATIENT

I or we hereby agree to be bound by the above: _____

RELATIONSHIP

RELATIONSHIP

1938-39 Beam Rays Corporation Clinical instrument

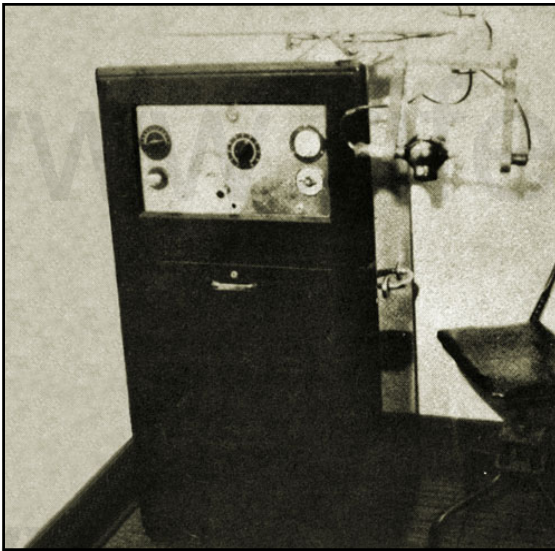

- 1) The instrument used a ray tube.
- 2) Had one variable Audio oscillator and one Fixed RF oscillator set at 3.80 MHz.
- 3) Power usage was about 450 to 600 watts. Output to the ray tube about 50 to 60 RF watts.

Just as with the Rife Ray #4 we must determine what a Beam Rays Corporation instrument looked like. The reason we need to determine this is because unless we know what those instruments really looked like we may think we have a true Beam Rays instrument and find out later that it is not one. Beam Rays built two different instruments, one was called the Clinical instrument and the other was called the Laboratory instrument. The fact that Beam Rays built two different instruments was pointed out in the Beam Ray Trial manuscript:

COMPARET: *"The four machines bought by the British were two so called laboratory types and two so called clinical types, what was the difference between the two?"*

HOYLAND: *"The clinical type was similar in all respects to the Rife machine except that it did not have (word missing) of the (word missing) used on Mrs. Henderson."*

We now know that Beam Rays built two different instruments of which one was built using the original Rife principles and it was considered the Laboratory instrument. The other was built using a different method of generating the frequencies and we will show that it was the Clinical instrument. First we will prove the photos we have are photos of Beam Rays instruments. The instrument above on the left is a photo of one of two instruments owned by Dr. James B. Couche which he purchased from Beam Rays Corporation. Dr. Hamer also purchased one of these instruments. This information was pointed out during the Trial and gives us the proof we are looking for:

COMPARET: *"Before this agreement was signed did the company manufacture any Rife ray machines?"*

HOYLAND: *"They started to about the first of May (May 1, 1938). Dr. Hamer was sold one."*

COMPARET: *"How was the price of these machines fixed?"*

HOYLAND: *"The price was decided from the costs of what it cost to manufacture the first machine that was sold to Dr. Hamer."*

COMPARET: "Were the clinical machines the same as were made for Dr. Hamer?"

HOYLAND: "Yes."

COMPARET: "Was that the same as the machine used on Mrs. Henderson?"

HOYLAND: "No, but the same type."

SAPIRO: "These machines are perfectly good, they are just the same as the [Dr.] Couche machines and the one that gave Mrs. Henderson such relief."

These quotes show that Beam Rays sold the Clinical style Machines to Dr. Hamer and Dr. Couche. Dr. Couche sold one of his Beam Rays Clinical instruments to Dr. Tully in 1951.

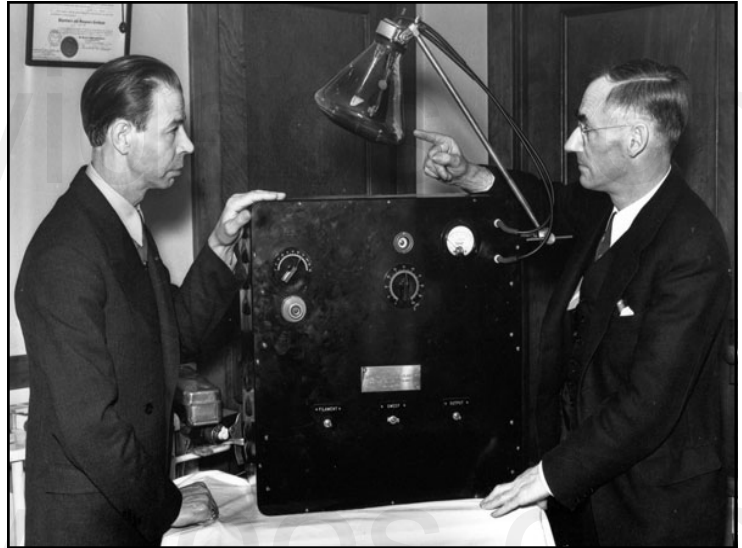
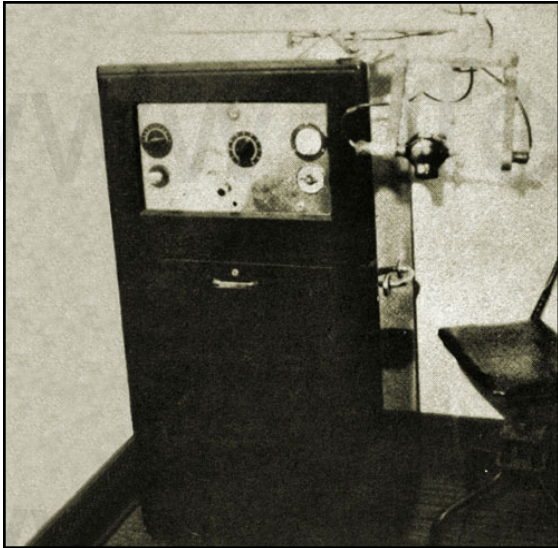

This photo shown above, on the left, is a photo of Dr. Couche's instrument which he sold to Dr. Tully. Since this is an original Beam Rays instrument we can make comparisons against it when looking at other instruments. The above photo, on the right, is of Dr. Rife and Philip Hoyland his engineer and business partner in Beam Rays Corporation. In this photo is an instrument. We will prove that this instrument is also a Beam Rays instrument by making some comparisons. This photo of Dr. Rife and Philip Hoyland was taken for a [May 6, 1938 newspaper](#) article published by the San Diego Tribune. In the newspaper the caption below the photo said: "Royal Raymond Rife, left and Philip Hoyland with Rife ray apparatus". On May 1, 1938 Beam Ray Corp. started selling its instruments to doctors and this front page newspaper article had the capability of selling many instruments. It is only logical they

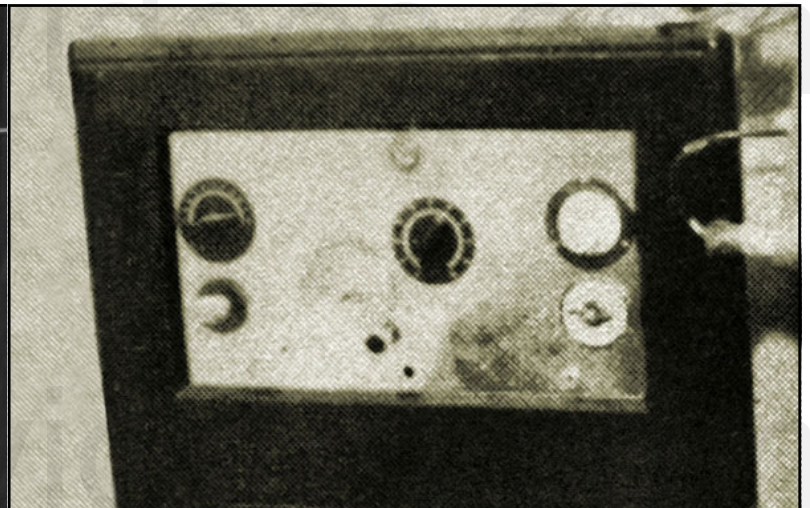

would have photographed the instrument they were selling. The two photos on the bottom of the previous page are close-up photos of these instruments. You will notice the similarities of these two instruments. They are almost exactly alike except for the case. Dr. Couche's instrument was in a case that extended all the way down to the floor. It had handles on the side and wheels on the bottom which would make it very easy to move around. Both instruments have one oscillator dial which is located on the left side of the front panel. Below that dial on Dr. Couche's instrument was a light and on the other instrument is a light also. The second dial, in the center of both instruments, goes to 100 and was the amplitude dial. Above that dial on both instruments is a tuning eye for calibrating the instrument's RF carrier frequency. In the photo on the right is one of these tuning eye tubes. They both have a milliamp power meter located all the way over to the right next to where the ray tube is connected. Dr. Couche's instrument had a timer below the power meter to help him make sure he treated the patient for the correct amount of time. Along the bottom are the filament, sweep and output switches which are not clearly marked on Couche's instrument but we can see what appears to be three different switches, two below the center amplitude dial and one below the timer. The comparison we have just made with Dr. Couche's Beam Rays instrument shows they are both Beam Rays instruments. They just put this Clinical machine into two different cases.

Tuning Eye AM 1, 1936/37

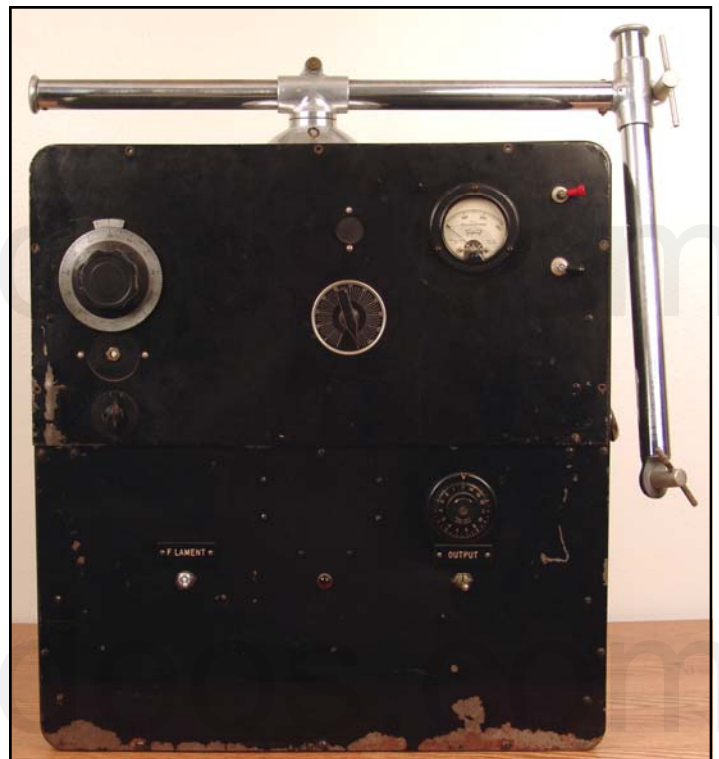
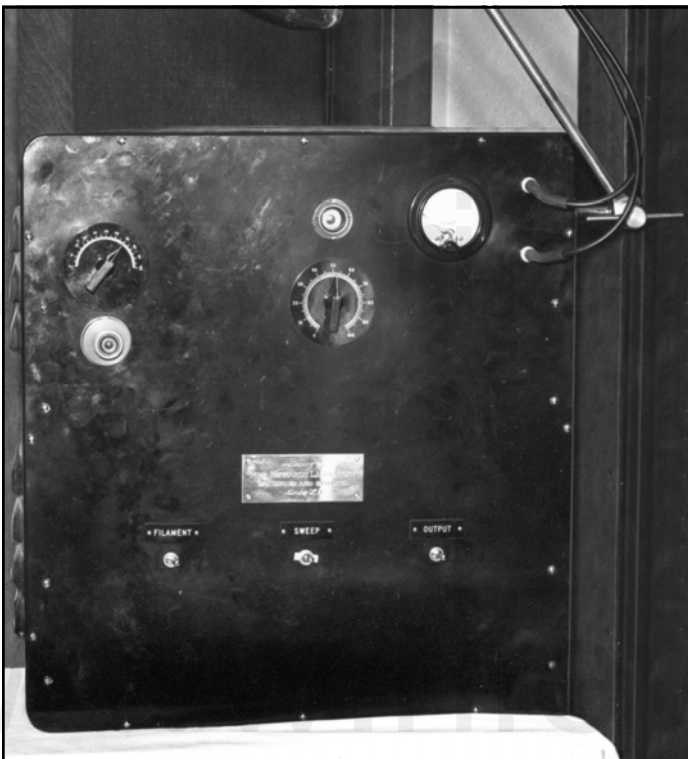

The above photo, on the left, as shown before, is the Beam Rays instrument that Dr. Rife and Philip Hoyland were photographed with for the 1938 newspaper article. On the right is a photo of an original Beam Rays instrument. This instrument was obtained from Dr. Larry Low. He has owned it for over 25 years. It was used by a Medical Doctor who died in the mid 1960s. We would like to thank him for allowing us to get this instrument so we could analyze it. It is a low audio frequency instrument.

This Beam Rays instrument is very important. The significance of this instrument is the fact that it is an original Beam Rays Clinical instrument which proves beyond any doubt that Philip Hoyland was the one who first built the low audio frequency instrument. The next two photos, shown on the top of the next page, are of Beam Rays instruments.

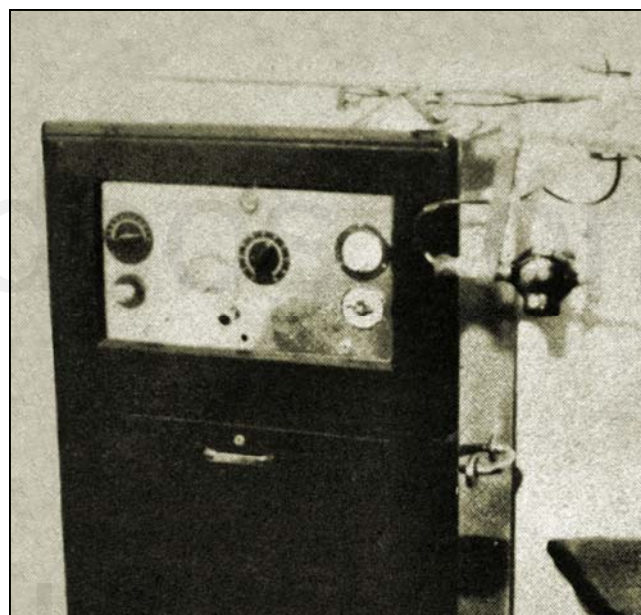
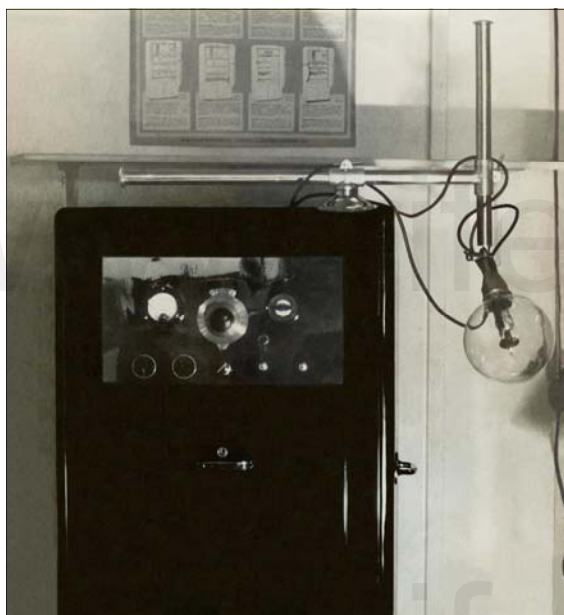

The photo on the left was found inside the case of this original Beam Rays instrument obtained from Dr. Larry Low. The photo, on the right, is Dr. Couche's Beam Rays instrument. Both of these instruments are in the same case. If you look closely you will notice that both instruments have the same metal arm attached to the top of the instrument which holds the ray tube. In every detail the cases are the same. The only difference is the layout of the front panel which is different in the photo on the left. It appears when Beam Rays built their first instrument which was shown in the May 1938 newspaper photo they had no band switches dividing out the audio frequency range. The doctors that used these instruments complained about the accuracy problems. It is apparent from the Beam Rays Trial testimony that a four position band switch was added to help solve this problem. The original Beam Rays instrument that we obtained has a band switch with four settings. Aubrey Scoon's Beam Rays replica also has a four position band switch. We will fully evaluate the Aubrey Scoon instrument later in this paper but we will refer to it from time to time as needed as we look at this original Beam Rays Clinical instrument. The 1950s AZ-58 Beam Rays replica, which we will evaluate later in this paper, had a three position band switch because they used audio frequencies which were ten times lower than the original Beam Rays Clinical instrument. To further analyze these instruments we will now do a comparison of the faceplates of the two original instruments shown on page 34.



The first close up photos are of the variable audio oscillator control. The photo, above on the left, is the May 1938 photo. The photo, on the right, is the original instrument we obtained. Normally the dial should only go 180 degrees from 0 to 100 as shown on the May 1938 dial. Our instrument does not have the original dial because it goes from 0 to 100 in 270 degrees. You will also notice that our dial is bigger than the original dial and partially covers where the old fine adjustment dial was located.

When they added the four position band switch the fine adjustment was no longer needed. Our Beam Rays Clinical instrument, like Aubrey Scoon's instrument, had four bands that cover these frequency ranges. Band 1: 160 Hertz to 820 Hertz: Band 2: 594 Hertz to 3,190 Hertz. Band 3: 2,440 Hertz to 12,930 Hertz. Band 4: 9,430 Hertz to 42,600 Hertz. Aubrey Scoon's frequency range was different. These four bands were discussed by Philip Hoyland and Bertrand Comparet during the trial:

COMPARET: "If you wanted to treat one with typhoid for instance wouldn't you have to set the machine so that it would be on a particular frequency."

HOYLAND: "No, the machines were made so that they varied over a band of frequencies."

COMPARET: "That band used for the treatment of each disease was different from other bands for other diseases wasn't it?"

HOYLAND: "The whole list of bacteria that the machine was treating was divided into four bands."

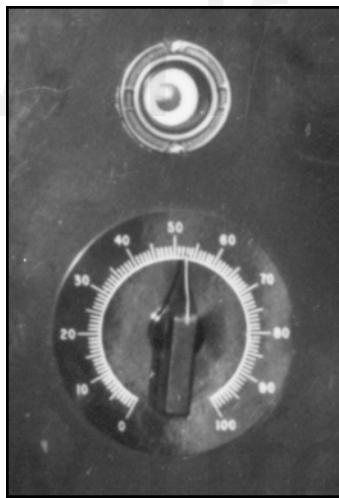

The next photos are of the tuning eye and the amplitude control. The photo, above on the left, is from the May 1938 instrument. The photo, on the right, is our instrument. Above the amplitude dial on the May 1938 instrument is the tuning eye. On our instrument you can see that the tuning eye was removed. Notice that you can still see the outline of the tuning eye. On the May 1938 instrument the amplitude dial went from 0 to 100 and adjusted the audio frequency modulation. On our instrument the amplitude dial also goes from 0 to 100 and adjusts the modulation of all the audio frequencies.

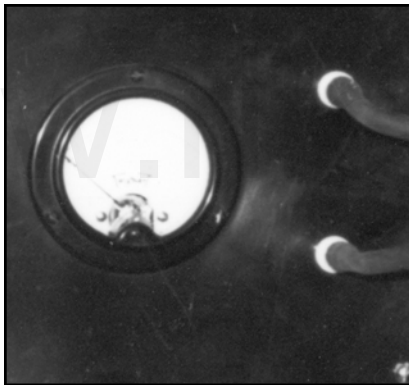

These photos show the 300 milliammeter and the ray tube hookup. The photo, above on the left, is the May 1938 instrument. The photo, on the right, is our instrument. Until the discovery of our Beam Rays instrument we did not know exactly where the fixed RF tank coil was located. We thought it probably was behind the milliammeter but now we know this is exactly where it was located.



The next photos are of the plaque. The photo, above on the left, is the May 1938 instrument. The photo, on the right, is our instrument. These photos show where the original plaque was on the instrument. The plaque read; "Property of the Rife Research Laboratory, Designers and Builders." On our instrument the plaque is missing but you can still see the four mounting screws that held the original plaque. Since this plaque could have caused the doctor problems since it had Dr. Rife's name on it, he may have removed it in order to avoid the machine being called a "Rife Machine."

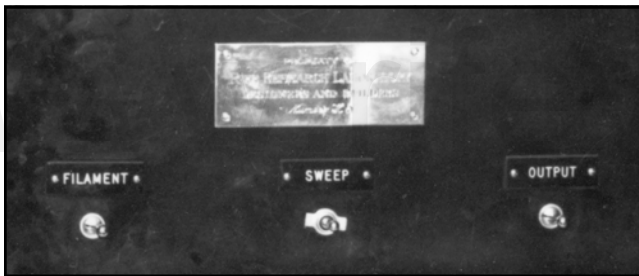

In these next two photos you can see the "Filament", "Sweep" and "Output" switches. The photo, above on the left, is the May 1938 instrument. The photo, on the right, is our instrument. On our instrument the sweep plaque was removed and the switch was replaced with a red light that indicated that the instrument had power. This is where the power indicator light was put on almost all of the instruments built during the 1940s and 1950s. The filament switch turned on the power to the 866 rectifier vacuum tubes and the output switch turned on the power to the 809 main amplifier vacuum tube. Turning on the power to the 809 tube would light the ray tube. Because of the accuracy problems of the Beam Rays audio instruments the sweep switch was probably used to try and solve this problem. The sweep switch appears to have been removed when the band switch was used. Above the output plaque on our instrument we see a 15 minute timer for setting the desired runtime for each frequency that was used. The Original Beam Rays instrument photo does not have a timer but Dr. Couche's Beam Rays instrument shows his instrument had a timer on the front panel. These photos show that a timer was put in many of the original Beam Rays instruments.

The photo, bottom right, is the Beam Rays instrument with the ray tube lit.



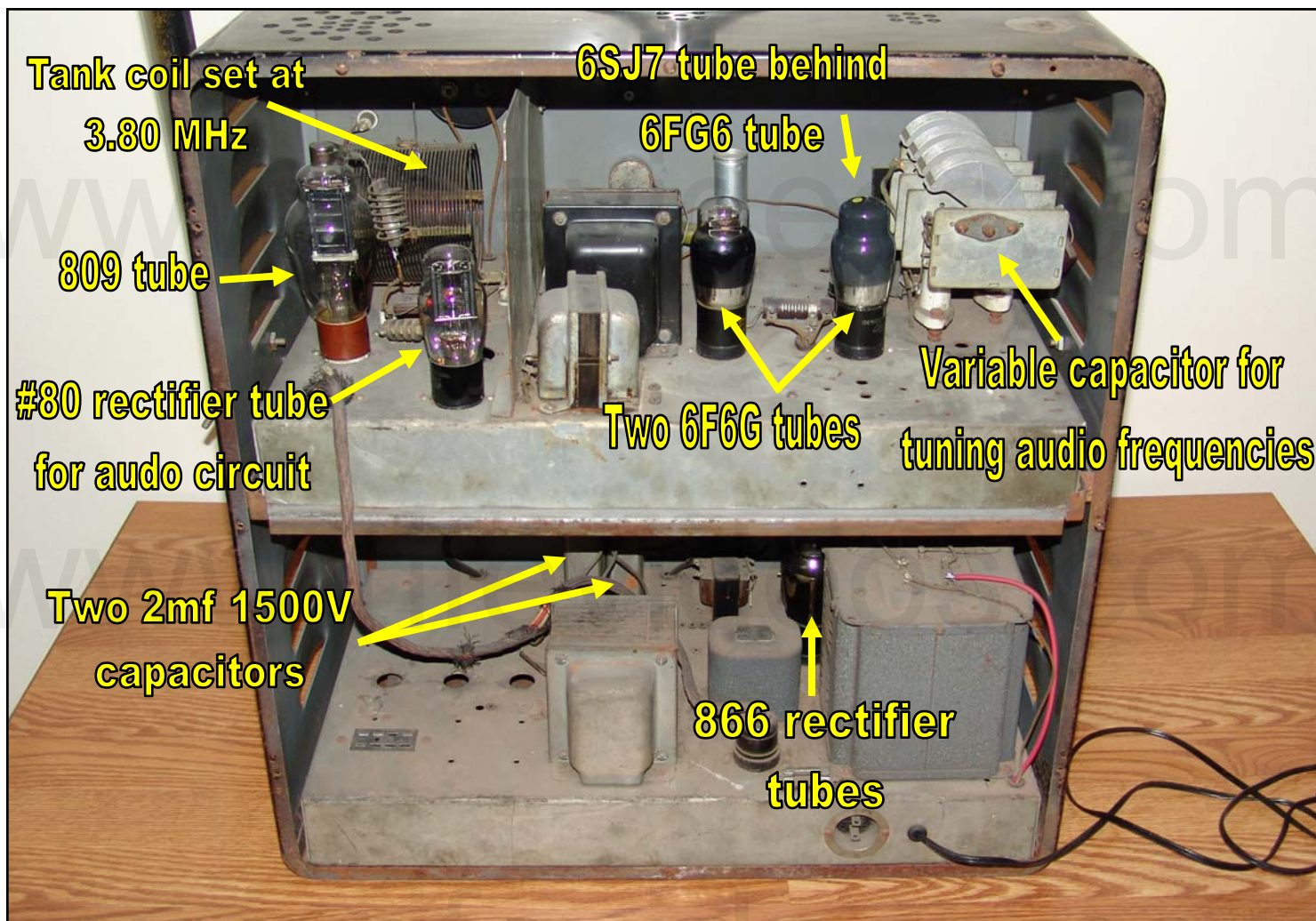

This photo, above, is of the inside of the Beam Rays instrument. The RF tank coil was set at 3.80 MHz. The 809 was the main output power tube. There were two 866 rectifier tubes. The audio section consists of 2 6F6G tubes and one 6SJ7 tube. All of the Philip Hoyland audio instrument designs built from 1936 through the 1950s AZ-58 resemble each other and anyone looking at the different instruments can see that they are all built almost in the same way. Tubes may vary, such as the 812a eventually replaced the 809, but the workings of all the instruments are similar. Both this original Beam Rays Clinical instrument and Aubrey Scoon's instrument have Hewlett Packard sine wave audio oscillators. Jim Peter's and I was able to repair the audio oscillator and read the different frequency band settings (see page 36). The readings for this paper was done with the original Beam Rays instrument along with Aubrey Scoon's and the AZ-58 replicas that we built. They all work identically the same as this original instrument. This Beam Rays instrument did not come with any paperwork with the dial settings for the various audio frequencies it used.

The photo, bottom right, is the under side of the chassis showing both the audio section and part of the RF section.

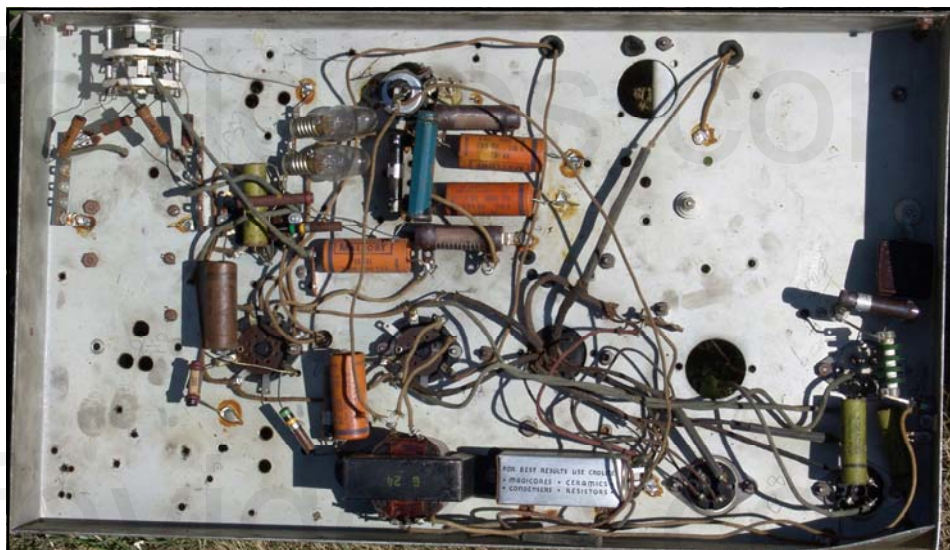

Since we now have an original Beam Rays instrument we know without any doubt that Philip Hoyland's Clinical instrument design used audio frequencies modulated onto a fixed carrier frequency. Dr. Rife and Philip Hoyland had an agreement that they would share evenly on the building of the instruments. Philip Hoyland stated this when he was on the stand during the Beam Ray Trial:

HOYLAND: "Dr. Rife and I had always had the understanding that we shared evenly, as I had done all the development work."

COMPARET: "What do you mean by that."

HOYLAND: "I had done all of the building and designing of the machines other than the one original machine [Kennedy equipment] that he had in his laboratory. I had brought that to a state where it could be carried around [Rife Ray #4]."

From these trial statements we know that all the designs were Philip Hoyland's designs. When Hoyland built the audio instrument he built it on a completely different principle or method. Philip Hoyland had changed the instrument to work on a different method which used harmonics. Dr. Rife believed they were using the Rife Ray #4 RF frequencies along with harmonics. This was pointed out in the 1939 Beam Rays trial:

COMPARET: "Has the Plaintiff [Philip Hoyland] ever informed you that the machines that he designed and built for the Beam Ray were not operating on the same frequencies as your own?"

RIFE: "They were supposed to be operating on the same with harmonics."

COMPARET: "Did he ever tell you that there was a fundamental difference?"

RIFE: "He said on one or two occasions that there was a difference in harmonics."

SAPIRO: "You say that the devices that were being built in the early part of 1938, the one that went to Dr. Couche and two that were in the lab were built on new harmonics?"

RIFE: "They were built on a different principal, we have a given wave length and it can be produced in different ways, but it should be the same no matter how it is produced."

SAPIRO: "You knew that these machines were being built with that machine."

RIFE: "Yes"

Philip Hoyland when he was on the stand was asked:

COMPARET: "I understand you say that the frequencies used in the machines put out by the corporation were not set to the same frequencies as Dr. Rife's machines [Rife Ray #4]."

HOYLAND: "That is correct."

COMPARET: "Did you inform the board of directors of Beam Ray that the machine you built was not the same as Dr. Rife's?"

HOYLAND: "I had spoken to them about it."

COMPARET: *"Then it was during the period between September and November that you told Edwards at his home that the machines you were building were not putting out the same frequencies as Dr. Rife's machines?"*

HOYLAND: *"Yes."*

COMPARET: *"How did you explain that?"*

HOYLAND: *"In the summer of 1936 I designed a new machine, or rather I checked it there at the lab [The Beam Rays Clinical instrument]. I had designed it in Pasadena, and we tested it out then and the frequencies were not the same as on Dr. Rife's machine."*

COMPARET: *"Did you tell him how great the difference it was?"*

HOYLAND: *"I explained that there was quite a fundamental difference." [Harmonic frequencies]*

Comparet when asked a question by Judge Kelly said this:

COMPARET: *"Hoyland has said that the design and the frequencies of the machine itself is not that of a Rife Ray machine, and that the machine is in fact different. The company will have to have these machines junked, must draw up new designs according to Dr. Rife's ideas, must have Dr. Rife ok these designs, etc...Dr. Rife is not going to be a party to a fraud, and if the machines we sell are not the true Rife machines they are a fraud." (Beam Rays Trial Papers, www.rife.org)*

When Edwards was on the stand he said this:

COMPARET: *"Did Mr. Hoyland tell you at any time in the fall of last year that the machines he was manufacturing for Beam Ray corporation operated on a principle fundamentally different from Dr. Rife's machine?"*

EDWARDS: *"Mr. Hoyland told me at one time that Dr. Rife thought that he had the frequencies but he didn't have them [here Edwards is talking about the Beam Rays Corporation instruments not the Rife Ray #4 instrument because Philip Hoyland said, on the stand, that he gave the Rife Ray #4 frequencies to Dr. Johnson and Dr. Rife in 1935]." (Beam Rays Trial Papers, www.rife.org)*

Philip Hoyland also said this on the stand:

HOYLAND: *"Regarding the frequencies of the machine [Beam Rays Corporation Clinical instrument], you will remember me telling you that the frequencies used are not the same ones on the Rife machine [The Rife Ray #4]. They [Meaning the Rife Ray #4 frequencies] were in the upper bands [139,000 to 1,604,000 Hertz]." (Beam Rays Trial Papers, www.rife.org)*

In a letter which he sent to Dr. Gonin in 1939, there are indications that Dr. Rife wanted the so-called harmonics removed:

RIFE: *"I spoke only Friday evening to a Mr. John Chamblin, a radio man now connected with Beam Rays Inc., about the redesign and building of a device according to the old Rife Ray principles; as the present instrument has been so deviated away from that old principle that it is nowhere near the same...those devices which you have are merely working on a harmonic and not a true frequency; and in our research on electronics, we definitely know that there is no possible way of controlling electrical harmonics of a frequency." ([Letter from Dr. Rife to Dr. Gonin, May 14, 1939. Page 1 of 3](#))*

We have just read a lot of trial testimony about how this Beam Rays instrument worked on harmonic frequencies. Also, in the trial testimony it is mentioned that these Beam Rays audio machines were tested in Dr. Rife's lab to see if they would devitalize microorganisms. It was Philip Hoyland who made the tests using Dr. Rife's organisms. From the documents we know that Philip Hoyland put a lot of work into this instrument and didn't finish it until late 1936 or early 1937. Benjamin Cullen said Philip Hoyland spent a lot of time at the lab and stated the following in a taped interview in the 1950s:

CULLEN: *"Philip Hoyland was in there quite a lot...Hoyland developed some few items in the lab...Hoyland seemed to help quite a lot and he got into the bacteriology side with Rife a good deal because Rife had so much to work out...he finally got to the point where he [Dr. Rife] had to delegate some of the work."* ([John Marsh Rife CDs, CD 6 track 1](#))

In the Beam Ray Trial manuscript we also read:

COMPARET: *"Were any experimental activities carried on in the lab?"*

HOYLAND: *"Yes."*

From the trial we learn that Philip Hoyland developed and tested his instrument in the lab. How could Philip Hoyland have tested it unless he put micro-organisms under the microscope? From the trial papers we learn that Philip Hoyland didn't tell Dr. Rife what frequencies he was using in the instruments. Dr. Rife thought the instruments were using his frequencies (the upper band frequencies) but with harmonics because this is what Philip Hoyland told him. The information that we now have obtained from this original Beam Rays Clinical instrument shows that Philip Hoyland's instrument was working on Dr. Rife's principles and on his frequencies but in a different manner than Dr. Rife was used to using. This is the reason that the instrument worked so well. Philip Hoyland was still using Dr. Rife's principle of coordinative resonance but hid the truth from Dr. Rife to protect his ownership interest. Philip Hoyland was a business man and Dr. Rife was not.

The fact that these tests were done along with the fact that these instruments were used by many doctors with incredible results show that this audio instrument did devitalize microorganisms. Though Dr. Rife did not like the method of harmonic frequencies that Philip Hoyland used it was pointed out in the trial that Dr. Rife knew about the changes. Dr. Rife also didn't think that these changes would make much of a difference:

SAPIRO: *"Dr. Rife said that he knew there were changes made in his machine and that they were not changes that would make any difference. Dr. Rife is a genius but he didn't know how to put the machines in a form that could be used in offices of doctors. These machine are perfectly good, they are just the same as the [Dr.] Couche machine and the one that gave Mrs. Henderson such relief."*

It was only with the release of the complete Beam Rays Trial manuscript that we now know why Dr. Rife continued to have this style of instrument built even in the 1950s. He considered it his instrument and knew it worked because of the doctors who used it successfully. This is why Dr. Rife, John Crane and John Marsh built this instrument in the 1950s and called it the AZ-58. The problem with the Beam Rays instrument is it has to be built a certain way in order for it to work on the correct harmonics. It was from the analyzing of this original Beam Rays Clinical instrument that the mystery of how it worked was discovered. We will show how it is supposed to work after we read another important quote. Bertrand Comparet, Rife's attorney who eventually defended Dr. Rife against Philip Hoyland in the 1939 Beam Rays trial said this about Philip Hoyland's instrument during his [1970's interview #28](#).

COMPARET: *"Well, none of us know enough about it. Now, I remember at that time Rife saying that Hoyland had not used a simple straight forward circuit, as Rife had used, but he thought he had a short cut, through use of harmonics and so on, and Rife had no faith in Hoyland's circuit".*

This statement by Bertrand Comparet completely sums up the understanding of this instrument. This confusion of how the instrument worked still remained throughout the building of the 1940s and 1950s Beam Ray replica instruments. It appears that Dr. Rife really didn't know how this instrument worked. The trial testimony shows that Philip Hoyland would not tell anyone in the Beam Rays Corporation the frequencies used with the Clinical instrument or explain how it worked on harmonics. John Crane and John Marsh who worked with Dr. Rife didn't understand how it really worked. If Dr. Rife had really known how it worked then he would not have allowed John Crane and John Marsh to have a variable carrier frequency in the instrument. John Crane and John Marsh put a variable capacitor in the instrument so that they could tune the carrier frequency. By doing this it made it so they could change the carrier frequency from about 4.9 MHz to about 2.2 MHz. This change showed that they did not understand how the instrument worked. They mistakenly believed that the audio frequencies were the M.O.R.s or the frequencies that would devitalize the microorganisms. This belief also shows that they did not understand how the Beam Rays Clinical instrument worked. If they had really understood how it worked they would have never called any of the audio frequencies M.O.R.s.

Philip Hoyland had very good reasons to hide how this instrument worked. He became Dr. Rife's Engineer in 1935 when he built the Rife Ray #4. In 1936 Philip Hoyland also began building the Beam Rays Clinical instrument that would be sold in 1938 by Beam Rays Corporation. Philip Hoyland was worried about keeping the original frequencies a secret because he felt people would try to steal their technology. This concern of Philip Hoyland's was not unfounded because Mr. Parsons of the British Group did try to steal their instrument. From the trial transcript we learn they had no way to patent the instrument because everything they were doing was in public domain in regards to the frequency generating equipment. Philip Hoyland felt that he had to come up with a way to keep anyone from finding out what the true frequencies were. So he built the instrument a different way using harmonics to hit the harmonic frequencies of the Rife Ray #4 and Kennedy equipment. Until a genuine Beam Rays instrument could be found and tested, we would never know for sure how Philip Hoyland generated and used the harmonics in his instrument. Even though Aubrey Scoon's instrument is a Beam Rays replica no one knew for sure that it really was one. This confusion and the lack of having the chronological history of when and what type of instrument was built made it very hard to find the truth.

Not only would Philip Hoyland not tell anyone how his instrument worked he also would not let anyone know the frequencies. Everything he did hid the frequencies. In the trial manuscript we read that he always used a code to give the frequencies. This code would work with the dials. No digital readout was available in those days like we have today. Since no one was ever given the frequencies from Philip Hoyland this has led to many problems. Some of the Beam Rays Clinical instrument replicas have different audio frequencies and this has led to a lot of confusion. Even John Crane was sending people different audio frequencies than the standard set he used with the AZ-58. Because of the different audio frequencies used in these Beam Rays replicas we really do not know what frequencies Philip Hoyland really used. We cannot use any of these frequency sets and come to any reasonable conclusions.

When we obtained this original Beam Rays Clinical instrument we had to put aside all the frequency lists and thinking of the past in order to figure out how the instrument worked. From everything we had read about Philip Hoyland's instrument we had come to the conclusion that the answer would be found in the math. However Hoyland came up with his idea it had to be a mathematical method. Like many others we tried to reconcile the audio frequencies as lower harmonics of Dr. Rife's original high RF frequencies. We tested the frequencies that were used in Aubrey Scoon's instrument and they didn't match. We did the same with the AZ-58 audio frequencies and they didn't match. We took the other audio frequencies that Crane had a list of and they also didn't match. There is an instrument known as the 1947 instrument which we tried to reconcile with no success. With all these audio frequencies only a few were close harmonic matches. If all these audio frequencies were true harmonics of Dr. Rife's original high RF frequencies then they would harmonically match up, but they do not.

Once we put all this aside and began to analyze this instrument we found out how it worked. This Beam Rays Clinical instrument is truly a harmonic instrument. The fact that both the audio frequency and the RF carrier frequency were sine wave did not make it easy to understand. How could it be a harmonic instrument when it used a sine wave waveform for both the audio and the RF frequen-

cies? The 1950s AZ-58 Beam Rays replica worked on square wave audio frequencies and the harmonics came from the square wave. But this is not how the Beam Rays Clinical instrument was suppose to work. The 1950's square wave method has been used ever since that time. But how can an instrument that uses sine wave audio frequencies be a harmonic instrument? With this understanding we knew that the audio frequencies could never be the true M.O.R.s. But how did they work in the instrument? The harmonic square wave method has been an accepted method for many years.

For many years almost everyone understood and generally accepted that you take a square wave audio frequency and the harmonics it creates and hit a higher frequency M.O.R. through those harmonics. These audio frequencies are usually many hundreds of harmonic steps lower that the higher M.O.R. frequency. This harmonic method must be kept in mind as well as the fact that not once, but several times, in the Beam Rays Trial manuscript and other documents everything said about this machine showed that it was using the harmonic method. We must remember that Dr. Rife said that he believed that many of his frequencies were sub-harmonics of a higher frequency. He said if we knew the true higher frequency it may even work better. Because of how this instrument works it is logical to conclude that Philip Hoyland understood this concept and apparently found that all of Dr. Rife's frequencies were sub-harmonics of higher frequencies. With this understanding he built the Beam Rays instrument. Here is what we found when we analyzed the Beam Rays Clinical instrument.

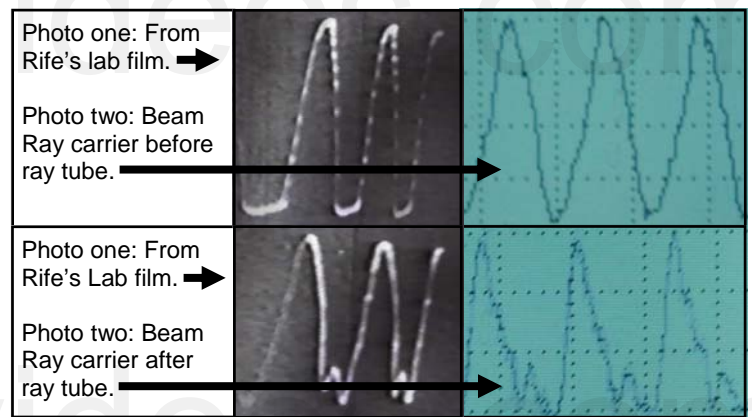
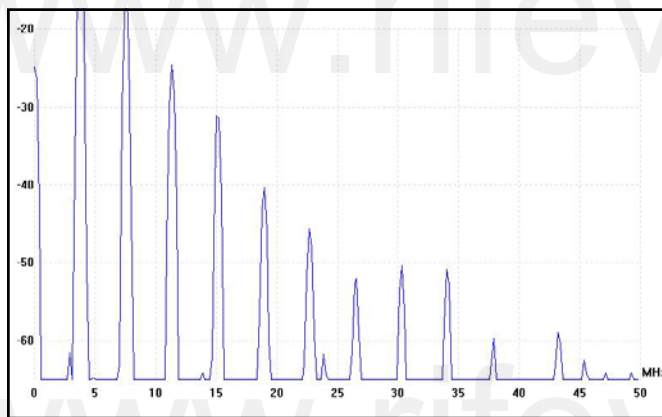

The graph, above on the left, is of the harmonics from the 3.80 MHz carrier frequency coming from the ray tube of our original Beam Rays instrument. It was taken using a PicoScope 3205 spectrum analyzer. The photos, above on the right, come from Dr. Rife's lab film and oscilloscope readings that we took of the waveform of the Beam Rays instrument. You will notice the similarity of the waveforms. All the M.O.P.A. carrier waveforms we have tested look like this. When you put a non harmonic sine wave into a ray tube you will always see a distortion of the sine wave which will produce both odd and even harmonics through the ray tube. This is the reason the sine wave looks distorted.

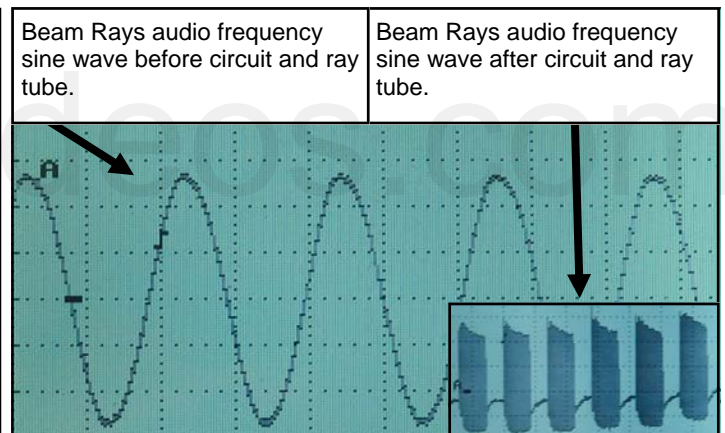
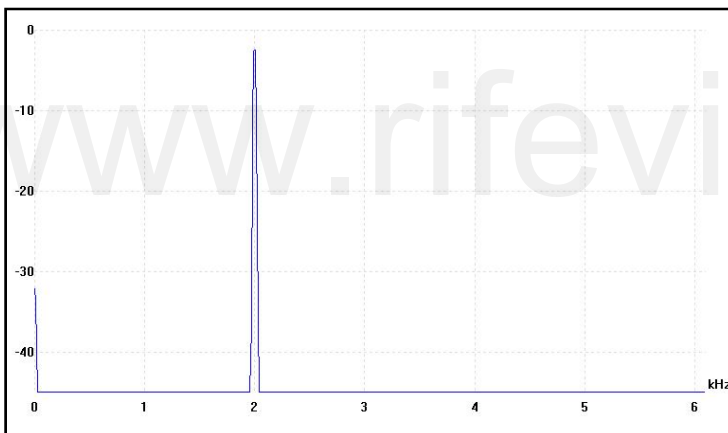

The graph, above on the left, is of a pure 2000 hertz sine wave frequency. The oscilloscope photo, above on the right, shows a 2377 hertz sine wave waveform coming from the audio oscillator of the original Beam Rays instrument. The small photo shows it after it goes through the ray tube and you will notice that it almost looks like a square wave, but it is not. The circuit creates this waveform.

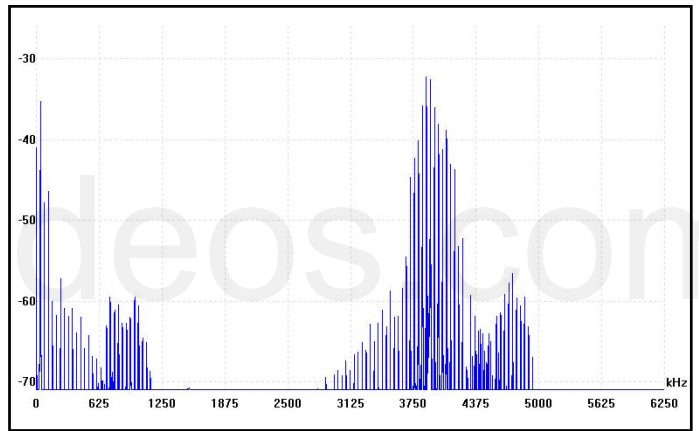
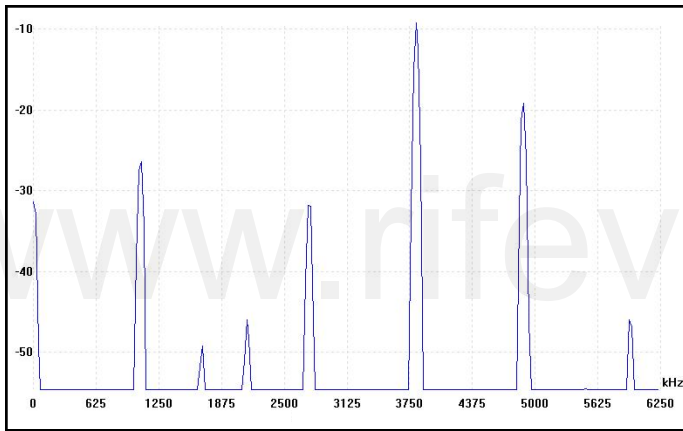

The graph, above on the left, was before modulation. The graph, above on the right, during modulation. When we modulated 40,000 hertz on a harmonic 3.80 MHz sine wave this is what the PicoScope spectrum analysis showed coming out of the ray tube. This was interesting to see. Not only did it create side band frequencies 40 thousand hertz above and below the harmonic 3.80 MHz carrier frequency but it created the same side bands and harmonics every 40,000 hertz apart for each harmonic of the 3.80 MHz. Below are two more graphs showing a closer view of these sidebands.

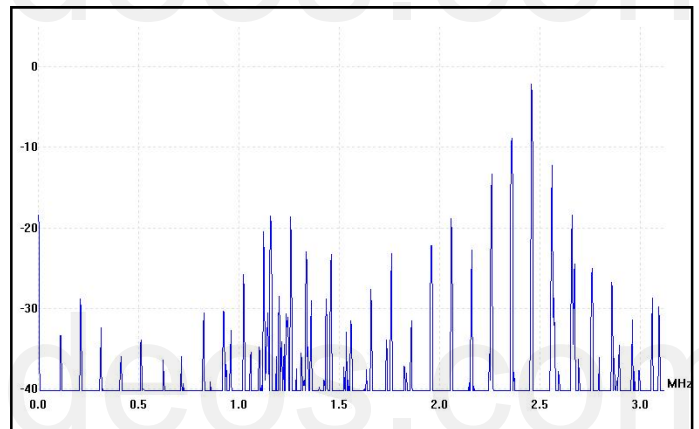
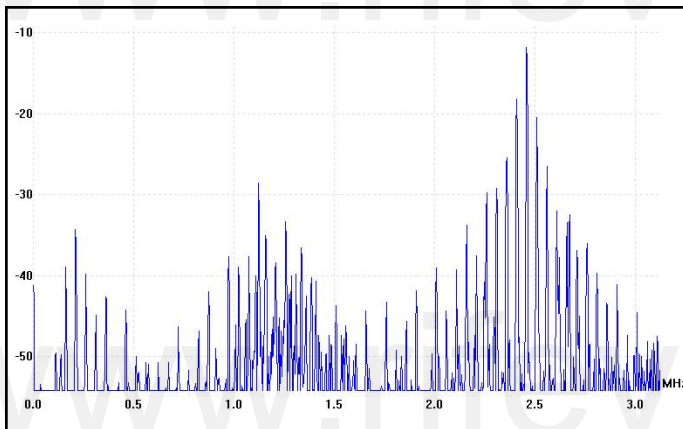

The graph, above on the left, is with a 50,000 hertz sine wave frequency. The graph, above on the right is with a 100,000 hertz sine wave frequency. This was done with a 2.4 MHz harmonic sine wave carrier frequency so you can see a closer view of these side bands. When we saw this we knew there was only one way this Beam Rays instrument could work on Dr. Rife's frequencies and method.

We will explain how Philip Hoyland's instrument worked using a fixed RF carrier frequency of 3.80 MHz and a variable audio frequency. Understanding harmonics and knowing that all Dr. Rife's M.O.R. frequencies were sub-harmonics of much higher frequencies it appears Philip Hoyland went up in harmonics with each organisms frequency until he had the highest harmonic frequency closest to 3.80 MHz. For an example we will take the Rife Ray #4 frequency for Streptothrix which is 192,000 hertz. Philip Hoyland multiplied 192,000 hertz by 20 which would give you the 20th harmonic which is 3,840,000 hertz. Since the RF carrier frequency of the Beam Rays Clinical instrument was fixed at 3,800,000 hertz the difference would only be 40,000 hertz between the two frequencies. Now all Philip Hoyland had to do was use an audio frequency of 40,000 hertz to create a side band frequency that would hit the harmonic M.O.R. frequency of 3,840,000 hertz. Pages 51-57 show all the M.O.R. graphs.

We know that Philip Hoyland was trying to hide the true M.O.R. frequency of the organism from anyone who used the equipment. Twice in the Beam Rays Trial it was mentioned that Dr. Rife had no ability to patent the Rife ray tube instrument. The only secret was the frequencies and Philip Hoyland was trying to protect his and Beam Rays interests. With this in mind Philip Hoyland could have just divided the 40,000 hertz by two and used a 20,000 hertz audio frequency. Then you would have one side band at 3,820,000 and another harmonic side band at 3,840,000 which would hit the 20th harmonic of 192,000 hertz. He could have divided it by three and used a 13,333 hertz frequency. He also could have divided it by 4 and used a 10,000 hertz frequency. If he would have divided it by five we

would get a 8,000 hertz frequency. Divided by six he could have used a 6666 hertz frequency. I could go on but anyone can see the many variable frequencies that could have been used. Also, because of the “one tenth of one meter” factor that Dr. Rife mentioned you could add many hertz to each frequency without changing the frequency enough to make it so it would not work. This means you could change the 6,666 hertz to 6,669 hertz just to make things a little more confusing. Dr. Couche said that he had to sweep the frequency dial in order to get the instrument to work properly. This is understandable since the 3.80 MHz carrier frequency will wander a few thousand hertz. The audio frequency oscillator also varied. Bertrand Comparet in his 1970s interview said this about the Beam Rays Clinical instrument inherent frequency drift:

COMPARET: *“Well, as they warmed up they’d shift frequency...Now, whether this was Hoyland’s inability to do better, or whether it was just inevitable in those days, I don’t know, but Hoyland’s devices did have that frequency shift as they warmed up. So, they had their problems. Now what Couche did, see, he would have cases where he would get an instantaneous cure, like that, and other times when the treatment just didn’t produce any results, because of the frequency shift. So, he would start in, he had from Rife (Hoyland dial settings) a set of the frequencies for several different diseases and he would tune it deliberately to one side of that frequency and then gradually tune it across to the other side making sure that somewhere in the process he crossed the correct frequency, even if the instrument wasn’t exactly in tune anyway. Well, when they hit the exact frequency they got amazing results.”*

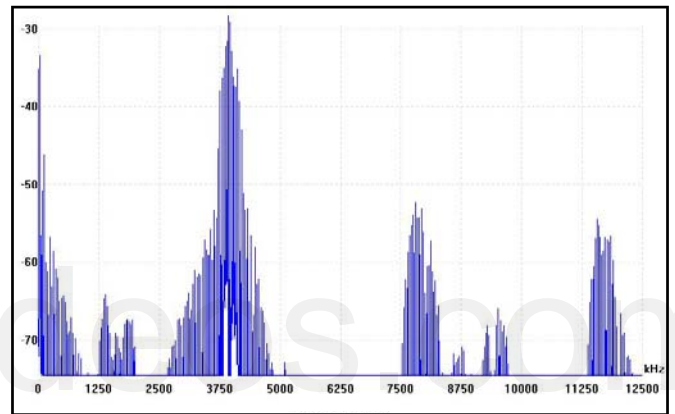
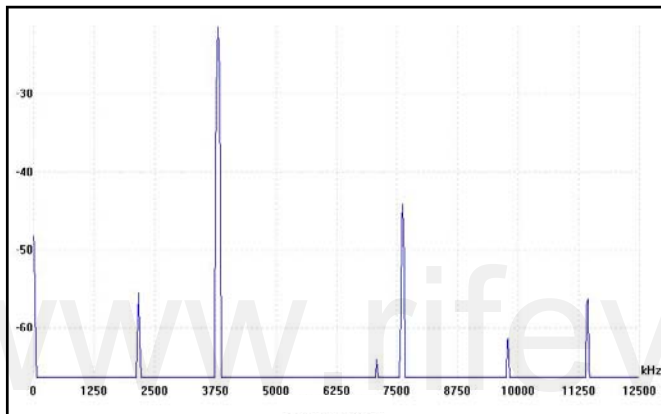

Again if you look at the two graphs above you will also notice that these sideband frequencies are created not only for the 3.80 MHz frequency but all of its harmonics. These harmonics continue all the way up to about 12 MHz with reasonable power. This creates an interesting effect and shows that all the harmonics of 192,000 are being hit over the whole spectrum of about 12 megahertz. This is probably why this harmonic instrument worked as well as it did, when they hit the correct frequency. This instrument was definitely a harmonic instrument as Philip Hoyland had stated.

Now going back to the audio frequency method of creating the side bands that Philip Hoyland used. No one could ever determine the 20th harmonic frequency of 3,840,000 or the original Rife Ray #4 frequency of 192,000 hertz using this method. The secret of the Beam Rays Clinical instrument and the frequencies that would devitalize the microorganisms could never be figured out unless you had the original Rife Ray #4 frequency of 192,000 hertz. Only a spectrum analysis of this instrument made it possible to figure out what Philip Hoyland was doing. Without this modern technology a person would have to be very knowledgeable about how frequencies and their harmonics worked.

The fact that it has taken this long to figure out how this instrument worked is proof enough that the secret was well hidden. Philip Hoyland would never tell anyone how this instrument really worked. If anyone changed the 3.80 MHz carrier frequency the audio frequencies would not work. New audio frequencies would have to be calculated to match the new RF carrier frequency. Also, Philip Hoyland could have changed the audio frequencies any time he wanted for any machine in order to confuse anyone who had the equipment. Since this is an original Beam Rays Clinical instrument then we have to assume that its 3.80 MHz carrier is the carrier frequency that was used with all the Beam Ray Clinical instruments, unless they used a different carrier for each machine. None of the audio frequencies

used in all the replica instruments from the 1940s to the 1950s AZ-58 match up to the 3.80 MHz RF carrier frequency. With this understanding we also have to assume that the audio frequencies used in the this original Beam Rays Clinical instrument were different than the 1940s and 1950s instruments. Aubrey Scoon's instrument had a 3.30 MHz carrier frequency so the audio frequencies would have logically been different.

The 1950s AZ-58 technical data showed that it was supposed to use a 4.68 MHz RF carrier frequency but when the variable capacitor was put into the AZ-58 the carrier frequency became variable. In Dr. Robert P. Stafford's "Electromagnetic Field Therapy" report he said the following about the carrier frequency they used on his patients with the 1950s AZ-58:

DR. STAFFORD: *"Radio Wave transmission is used as a carrier wave. We use between 3100 KC [3.1 MHz] and 3300 KC [3.3 MHz] (This does not appear to be a critical value). The carrier wave is modified with specific cycles per second modulations. We believe that the CPS is a critical value and it actually may prove to be the most important factor which this research may offer."*

The audio frequencies they used with the AZ-58 instrument should have been different because its carrier frequency was different. None of AZ-58 audio frequencies will create the correct sideband spacing that will match up to the harmonic Rife Ray #4 frequencies. This is probably why Dr. Robert P. Stafford could not get the AZ-58 to devitalize any microorganisms. Here are two of his statements:

DR. STAFFORD: *"Please excuse my format in the following letter for I intend to ramble a bit and forget strict grammatical dictum. I am writing you at this time partially because John Marsh informs me in a recent letter that you may be somewhat disheartened or at least worried about your role in the experimentations with the Rife Machine. Believe me, Dr. Edward I know how you feel for I too have been through this same feeling with this matter. I have observed clinical results after treatments with this gadget which I can scarcely believe myself. Yet, despite these good results, I have been confused by some rather simple failures such as a recent experiment which I conducted at Good Samaritan Hospital where we used the machine to treat some cultures of Staph Aureus and Strept. Fecalis. In this work we failed to inhibit growth at all or influence the cultures with the Rife Rx. I sent the results to John Marsh and asked for clarification and to be very frank I am not satisfied with John's excuse of the failure as described by Dr. Rife. I am afraid I'm not a very good apostle for I'm getting some ideas myself on how this thing may work. I really wonder if this ultrasonic kills bacteria and virus at all or does it work like other forms of ultrasonic and merely stimulate the tissue in some unusual manner thereby improving the circulation and secondarily enhancing the body's defenses against infection... To summarize some of this rambling: I feel that the Rife Ultrasonic Therapy has a very definitely beneficial effect on the human (and canine) body...I furthermore feel that we, as doctors of medicine, using this machine must remain constantly alert to the condition of our patient and vary the Rx as indicated."*

DR. STAFFORD: *"As yet, we have failed to "cure" any case of advanced, terminal malignancy. It appears in several instances that we may have impressed the disease favorably, temporarily. It is difficult to rule out the psychological, morale booster effect to the terminal patient when some definitive effort is made again in his behalf. However, several improvements have appeared to be more physical than emotional...All the patients in the series were treated with the same frequencies (e.g., 728 - 784 - 880 - 2008 - 2128). Perhaps these frequencies may be wrong, or only nearly correct." ([John Marsh Collection, Dr. Stafford's Report on using the AZ-58, page 4, www.rife.org](#))*

If the correct audio frequencies were not used with the 3.1 MHz to 3.3 MHz RF carrier frequency what Dr. Stafford M.D. reported is exactly what would have happened. From Dr. Stafford's statement we know that he did not think the RF carrier frequency was critical. If Dr. Rife had fully understood how Philip Hoyland had designed the instrument he would have never allowed John Crane or John Marsh to put a variable capacitor in its circuit and he would have made sure that Dr. Stafford knew that the carrier frequency was critical. They also would have been using the correct audio frequencies that would create the proper side band spacing. If John Crane and John Marsh really understood how this

instrument worked they never would have wanted to change the 4.68 MHz carrier frequency. It is obvious they never really understood how the instrument worked or how the audio frequencies interacted with the carrier frequency to produce the M.O.R.s that would devitalize the organisms. They, like us, were under the false belief that the audio frequencies they were using were the M.O.R.s. They unknowingly promoted this idea because Philip Hoyland would never tell anyone how the instrument worked. We know that Dr. Rife knew that this Beam Rays Clinical machine worked on his frequencies with harmonics but it is apparent that no one but Philip Hoyland really understood the instrument.

With this variable capacitor John Crane and John Marsh could change the RF carrier frequency from about 2.4 MHz to about 4.9 MHz. Dr. Stafford told me personally, when I talked to him, that it did not make any difference which carrier frequency he used they all worked the same. We will probably never know the full story of how these mistakes were made but it is obvious that no one but Philip Hoyland had the proper understanding of how the instrument worked. Since the AZ-58 was used in a different manner than the sideband method then it would have been better if Dr. Rife, John Crane and John Marsh had used the true mathematical lower square wave audio frequency harmonics of the Rife Ray #4 frequencies. Using the correct sub-harmonic audio frequencies derived from the higher RF frequencies with a square wave waveform probably would have worked better than the 1950s audio frequencies they were using in the AZ-58. We should do the same today with our frequencies.

All that we have discovered with the analyzing of this original Beam Rays Clinical instrument shows that the audio frequencies used with this equipment are not true M.O.R.s but just the frequencies needed to produce the proper sideband spacing in order to hit the correct RF harmonic M.O.R. frequency. If the audio frequencies were the frequencies that would devitalize the microorganisms then logically all Dr. Rife's frequencies would have been audio frequencies. Dr. Rife always said that almost all his frequencies were in the upper bands which match the Rife Ray #4 frequencies.

It is interesting to note that this Beam Rays Clinical instrument did not have a gate circuit. This is also the case with the 1950s AZ-58. Aubrey Scoon mentions a sixty hertz feed back into the circuit of his instrument but he could not determine if the instrument was intended to work this way or if it was just a malfunction. When we built his instrument we could not get our instrument to work in the same manner as his did, therefore we believe that it most likely was malfunctioning and was not intended to work this way. Since this Beam Rays Clinical instrument that we obtained didn't work in this manner and none of the other replica instruments work this way we believe that our conclusion is correct.

This gate circuit used a fixed audio frequency which was modulated onto the high frequencies in Dr. Rife's high frequency instruments. It created a pulsed waveform which apparently was needed to devitalize the various microorganisms that he tested. Since the Beam Rays Clinical instrument did not use a gate circuit then the modulated waveform it used must have been sufficient to accomplish the same result. From this we can conclude that all that is needed is a modulated or pulsed waveform with the proper M.O.R. high RF frequency to devitalize microorganisms.

If you want a different audio frequency then divide the carrier frequency difference by a different number. For most numbers we divided by 5 but the BX was divided by 15. The BX higher M.O.R. harmonic is only the second harmonic so it would still work just as well as all the other frequencies. One must remember the modern square wave audio frequency harmonics are projected to hit frequencies hundreds of harmonics up. This Beam Rays instrument has far more power in its harmonics.

This Philip Hoyland method would be far superior to using low audio frequency square waves since the harmonics would all be 40 harmonic steps or less. There is no schematic supplied for this original Beam Rays Clinical instrument since the Aubrey Scoon replica schematic is available and will work. Aubrey Scoon's instrument carrier frequency has been discovered even though his instrument was malfunctioning. He originally gave a 3.33 MHz carrier frequency using an 812a tube. Then he realized it probably used an 809 tube and replaced the 812a with the 809. The problem with the instrument malfunctioning is what made it hard to determine the true carrier frequency. Without having the correct RF carrier frequency it makes it very hard to verify the audio frequencies it used. Having done a lot of work with this style of instrument and knowing how harmonics can shift the carrier frequency I decided to test a 3.30 MHz carrier to see if it was the correct frequency it used. This 3.30 MHz carrier frequency would have been a more logical choice to use especially when it comes to making the cor-

rect sideband frequencies. The results of that decision will be shown later when we take a look at Aubrey Scoon's 1940s Beam Rays Clinical instrument built by Verne Thompson.

Below on this page is a chart showing the "Rife Ray #4 Frequencies" with their "Higher Harmonic Frequencies" along with the "Carrier Difference Frequencies" and the "1/10 tenth Of One Meter" mentioned by Dr. Rife, converted to hertz. Also included in this chart are "Beam Rays Clinical Frequencies" which are audio frequencies that would work with the Beam Rays Clinical instrument. It also includes "Aubrey Scoon's Frequencies" for a comparison even though we have not yet examined Aubrey's Beam Rays replica machine. After you have read about Aubrey Scoon's instrument this information will be even more understandable.

You will notice in the chart below that many of the Beam Rays Clinical instrument audio frequencies, when divided with some numbers are very close to the audio frequencies used by Aubrey Scoon's Beam Rays replica. It is easy to see the correlation between these two machines and the sideband method used by Philip Hoyland to hit the proper high frequency M.O.R. harmonics of the Rife Ray #4 frequencies. There could be many more audio frequency sets depending how you divide the "Carrier Difference Frequencies." The best audio frequency set would be a list with the highest frequencies so that you have the lowest number of sideband harmonics. The reason for this is power loss: the more sidebands the less power in each sideband. The power loss after about 40 sidebands is so great, when looking on a spectrum analyzer, it is doubtful the sideband frequencies would work.

The Beam Rays Clinical Instrument Sideband Sine Wave Audio Frequencies Based On A 3.80 MHz Carrier

Microorganism	Rife Ray #4 Frequencies	Higher Harmonic Frequencies	*Carrier Difference Frequencies	1/10 Of One Meter Freq.	Number of Sideband Harmonics	Aubrey Scoon's Frequencies	Beam Ray Clinical Frequencies
Actinomycosis or Streptothrix	192,000 Hz	3,840,000 or 20th	40,000 Hz	12 Hz	4	7,870 Hz	10,000 Hz
Anthrax	139,200 Hz	3,758,400 or 27th	41,600 Hz	6 Hz	5		8,320 Hz
B or E Coli Rod	417,000 Hz	3,753,000 or 9th	47,000 Hz	58 Hz	6	8,020 Hz	7,833 Hz
B or E Coli Virus	770,000 Hz	3,850,000 or 5th	50,000 Hz	198 Hz	3	17,220 Hz	16,667 Hz
BX Virus Carcinoma	1,604,000 Hz	3,208,000 or 2nd	592,000 Hz	858 Hz	15	21,275 Hz	39,467 Hz
BY Sarcoma	?1,530,000 Hz	3,060,000 or 2nd	740,000 Hz	780 Hz	20	20,080 Hz	37,000 Hz
Gonorrhea	233,000 Hz	3,728,000 or 16th	72,000 Hz	18 Hz	5		14,400 Hz
Pneumonia or Spinal Meningitis	427,000 Hz	3,843,000 or 9th	43,000 Hz	61 Hz	5	7,660 Hz	8,600 Hz
Staphylococcus Pyogenes Aureus	478,000 Hz	3,824,000 or 8th	24,000 Hz	76 Hz	3	7,270 Hz	8,000 Hz
Streptococcus Pyogenes	720,000 Hz	3,600,000 or 5th	200,000 Hz	173 Hz	24	8,450 Hz	8,333 Hz
Syphilis	789,000 Hz	3,945,000 or 5th	145,000 Hz	207 Hz	22	6,600 Hz	6,591 Hz
Tetanus	234,000 Hz	3,744,000 or 16th	56,000 Hz	18 Hz	5	1,200 Hz	11,200 Hz
Tuberculosis Rod	369,000 Hz	3,690,000 or 10th	110,000 Hz	45 Hz	13	8,300 Hz	8,462 Hz
Tuberculosis Virus	?769,000 Hz	3,845,000 or 5th	45,000 Hz	197 Hz	3	16,000 Hz	15,000 Hz
Typhoid Rod	760,000 Hz	3,800,000 or 5th	0 Hz	192 Hz	1	6,900 Hz	100 Hz
Typhoid Virus	1,445,000 Hz	4,335,000 or 3rd	535,000 Hz	694 Hz	14	18,620 Hz	38,214 Hz
Worms						2,400 Hz	

As mentioned on the previous page the higher the audio frequency used the more power there is in the sidebands. For this reason we have put in the chart below a list of the optimum Beam Rays Clinical instrument audio frequencies to be used with a 3.8 MHz RF carrier frequency and a 40,000 hertz audio frequency oscillator. This would give the lowest number of sideband harmonics and the greatest power in each sideband.

Beam Rays Clinical Instrument Sideband Sine Wave Audio Frequencies			
Anthrax	20,800 Hz	Streptococcus	33,333 Hz
B or E Coli Rod	23,500 Hz	Steptothrix	40,000 Hz
B or E Coli Virus	25,000 Hz	Syphilis or Treponema	36,250 Hz
BX Virus Carcinoma	39,467 Hz	Tetanus	28,000 Hz
BY Sarcoma	?37,000 Hz	Tuberculosis Rod	36,667 Hz
Gonorrhea	36,000 Hz	Tuberculosis Virus	?22,500 Hz
Spinal Meningitis	21,500 Hz	Typhoid Rod	100 Hz
Staphylococcus	24,000 Hz	Typhoid Virus	38,214 Hz

On the next page you will find oscilloscope images of the original Beam Rays Clinical instrument. On pages 51 through 57 you will find the spectrum analyzer graphs showing the sideband frequencies for each organism using the Beam Rays Clinical instrument 3.80 MHz carrier frequency. These graphs show which sideband frequency is hitting the Harmonic Rife Ray #4 frequency that is closest to the 3.80 MHz carrier frequency. These graphs show clearly how this instrument worked.

On pages 58 and 59 are two charts that show the Rife Ray #4 frequencies and their M.O.R. harmonics so you can see the progression of harmonic frequencies as they go up in harmonics to the frequencies that were used by Philip Hoyland in this Beam Rays Clinical instrument. With these charts you can do the same math that we did to determine the audio frequencies that will produce the proper sideband spacing. You will notice on the chart, on the previous page, that our list of audio frequencies for the Beam Rays Clinical instrument are in all four bands of frequencies. Philip Hoyland said *"The whole list of bacteria that the machine was treating was divided into four bands."* You will notice that Aubrey Scoon's Beam Rays replica frequencies are only in three bands. This shows that his carrier frequency is different than ours. The first band which covered from 20 hertz to 200 hertz is not used. With a carrier frequency of either 3.8 MHz or 4.68 MHz you will always get at least one audio frequency that has to be in band one because it is so close to the carrier frequency that only a frequency of less than two hundred hertz will work. The Typhoid Rod 5th M.O.R. harmonic frequency is exactly 3.8 MHz and with 4.68 MHz the Tetanus 20th M.O.R. harmonic is exactly at 4.68 MHz. This also shows that Aubrey Scoon's instrument carrier frequency was different.

Oscilloscope Readings Of The Original Beam Rays Clinical Instrument

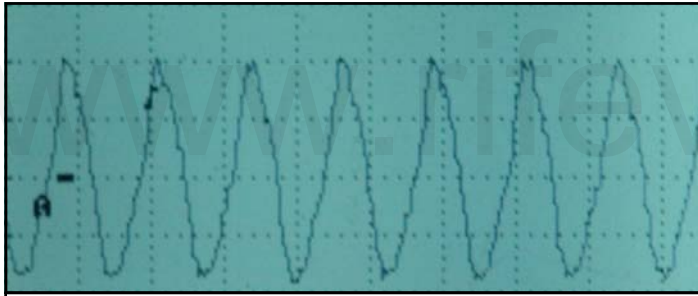

3.8 MHz carrier frequency before ray tube.

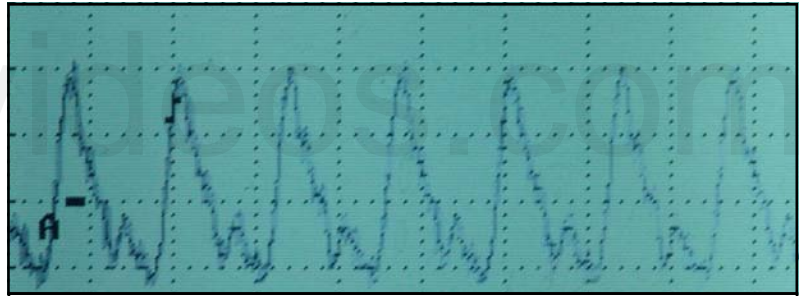

3.8 MHz carrier frequency after ray tube.

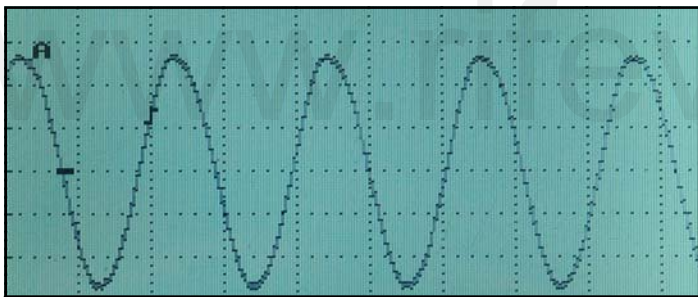

2,377 hertz frequency from audio oscillator.

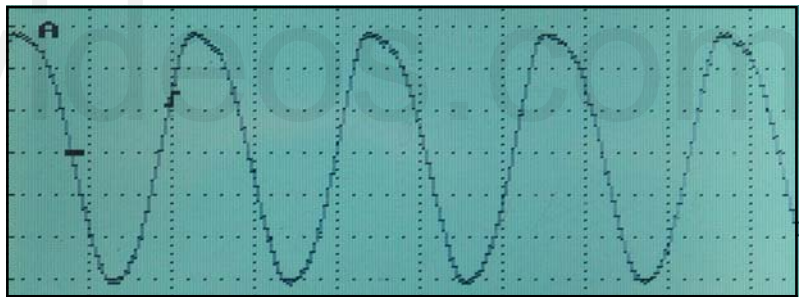

9,360 hertz frequency from audio oscillator.

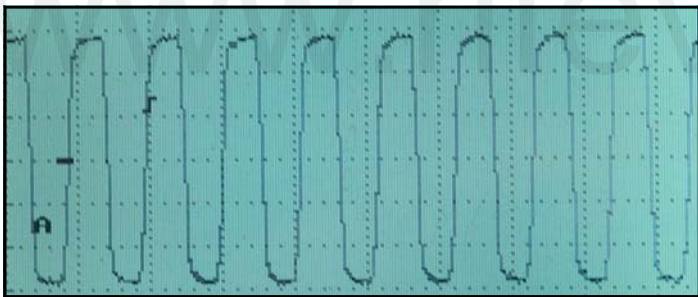

18,630 hertz frequency from audio oscillator.

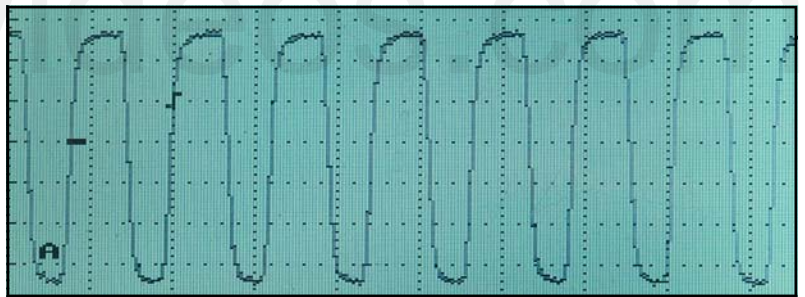

40,980 hertz frequency from audio oscillator.

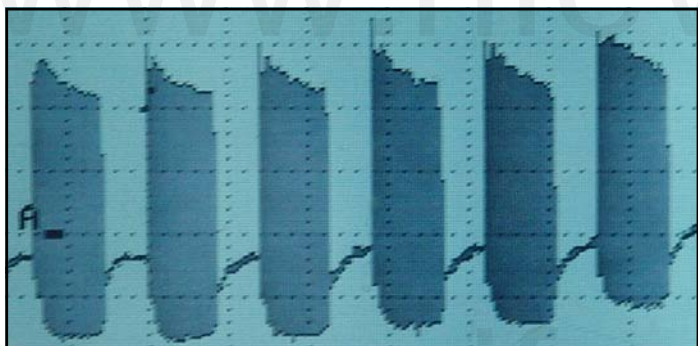

Original Beam Rays modulated waveform.

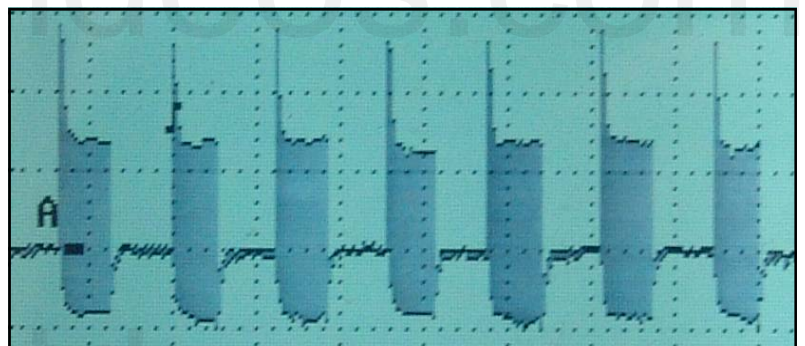

Aubrey Scoon's Beam Rays replica modulated waveform.

Rife Ray #4 192,000 Hertz for Actinomy-
cosis or Streptothrix. The 20th Higher
harmonic frequency is 3,840,000 Hertz.
The audio frequency used for the proper
sideband spacing is 10,000 Hertz. The
4th upper sideband hit the M.O.R.

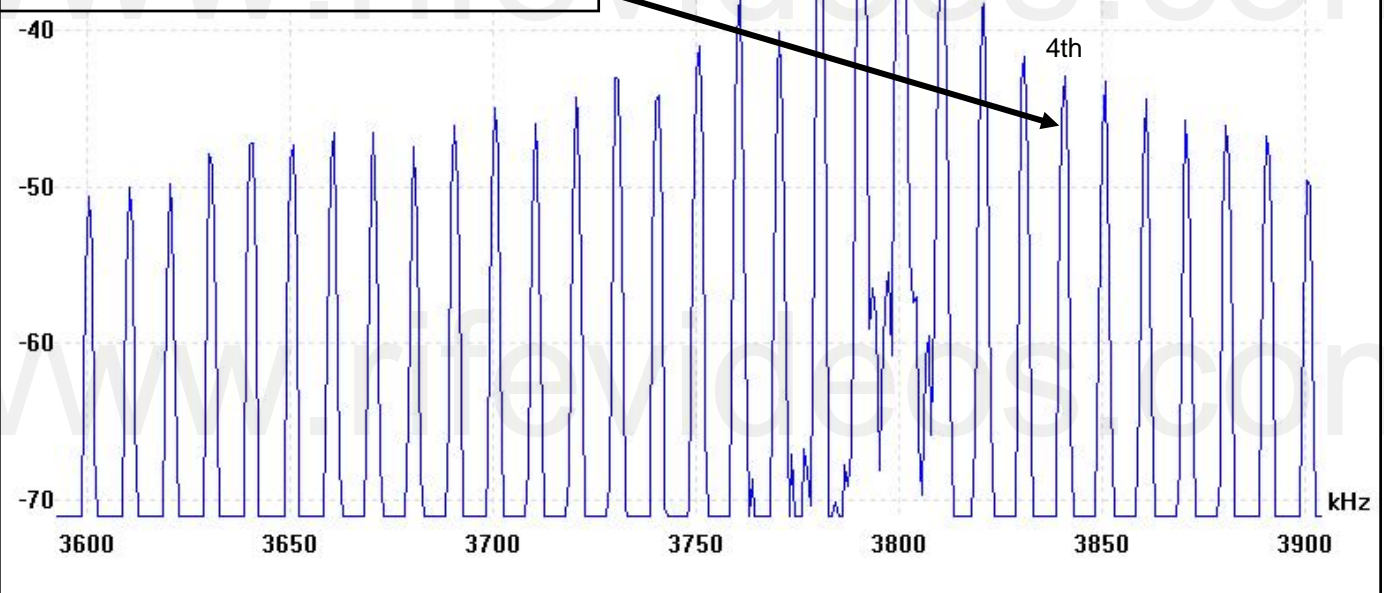

Philip Hoyland's Beam Rays Clinical instrument 3.8 Megahertz spectrum analysis of sideband harmonic frequencies.

Rife Ray #4 139,200 Hertz for Anthrax. The
27th Higher harmonic frequency is 3,758,400
Hertz. The audio frequency used for the
proper sideband spacing is 8,320 Hertz. The
5th lower sideband hit the M.O.R.

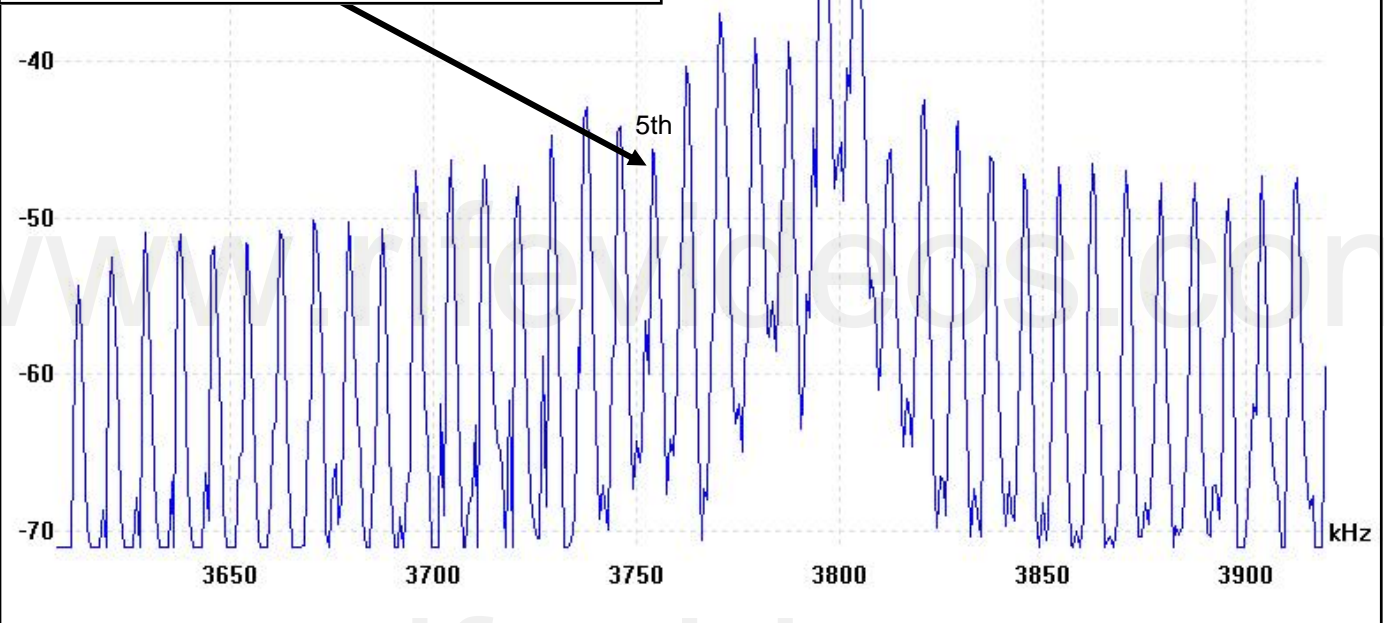

Philip Hoyland's Beam Rays Clinical instrument 3.8 Megahertz spectrum analysis of sideband harmonic frequencies.

Rife Ray #4 417,000 Hertz for B or E Coli Rod. The 9th Higher harmonic frequency is 3,753,000 Hertz. The audio frequency used for the proper sideband spacing is 7,833 Hertz. The 6th lower sideband hit the M.O.R.

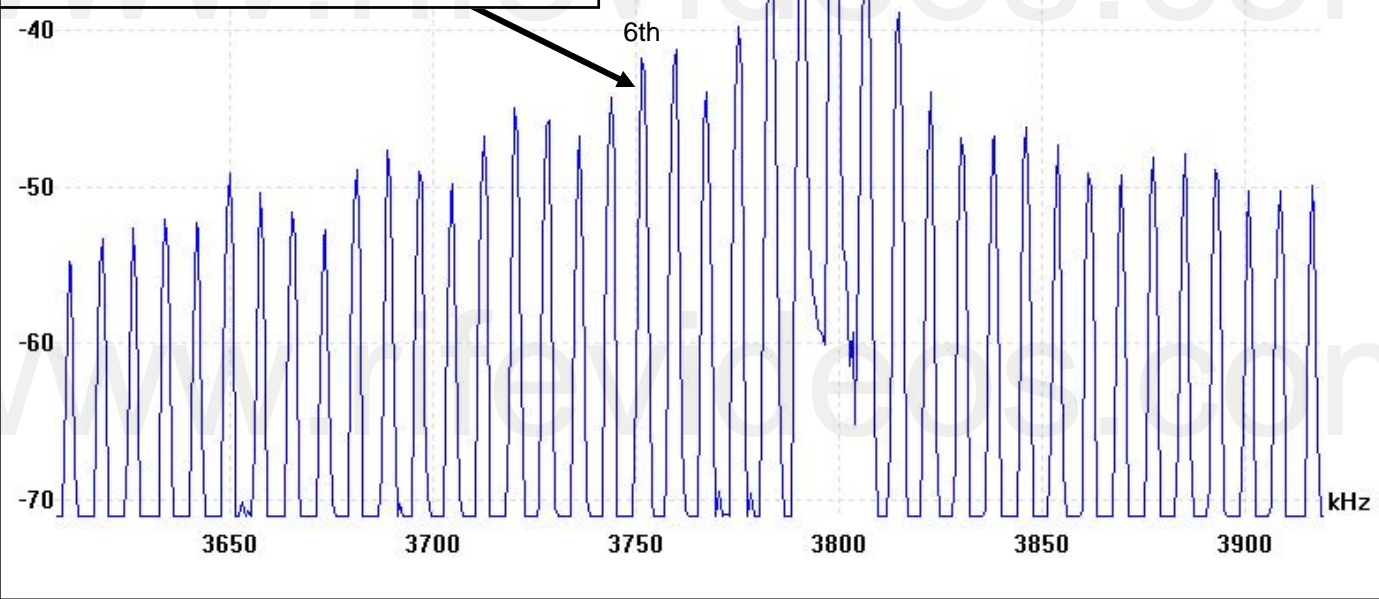

Philip Hoyland's Beam Rays Clinical instrument 3.8 Megahertz spectrum analysis of sideband harmonic frequencies.

Rife Ray #4 770,000 for B or E Coli Virus. The 5th Higher harmonic frequency is 3,850,000 Hertz. The audio frequency used for the proper sideband spacing is 16,667 Hertz. The 3rd upper sideband hit the M.O.R.

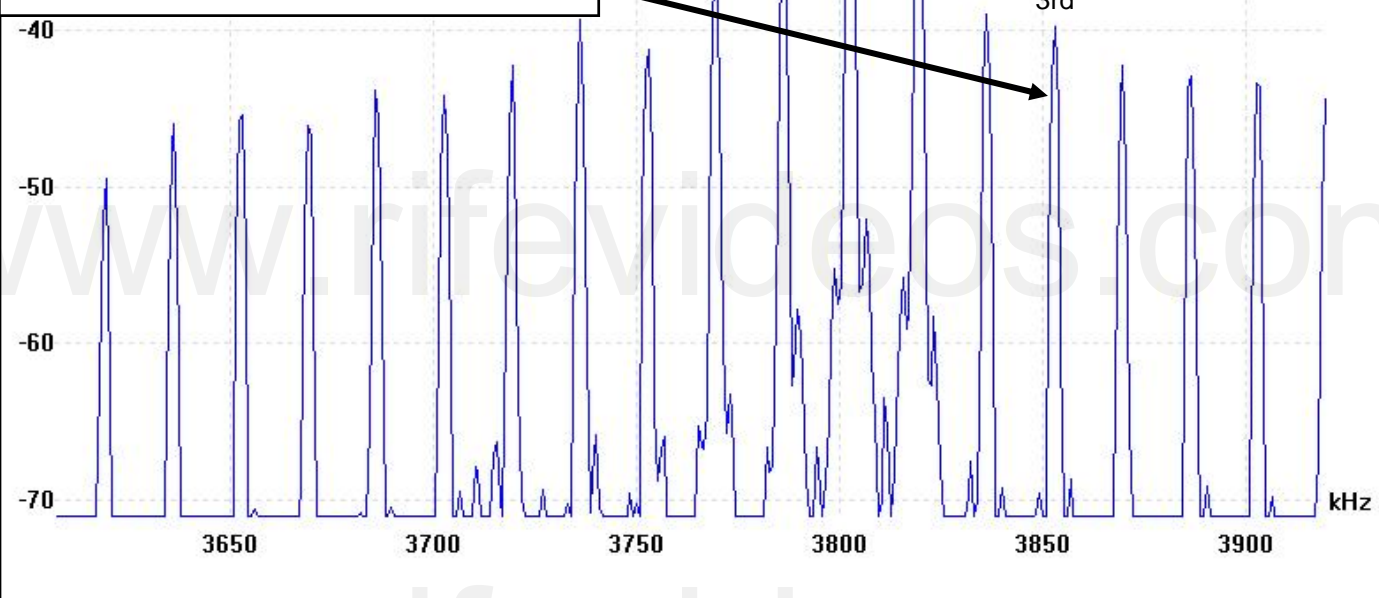

Philip Hoyland's Beam Rays Clinical instrument 3.8 Megahertz spectrum analysis of sideband harmonic frequencies.

Rife Ray #4 1,604,000 Hertz for the BX Cancer Virus. The 2nd Higher harmonic frequency is 3,208,000 Hertz. The audio frequency used for the proper sideband spacing is 39,467 Hertz. The 15th sideband hit the M.O.R. The greater the frequency difference from the carrier frequency to the M.O.R. the weaker the sidebands become. The 15th lower sideband is about all you would want to have over a 592,000 hertz spread.

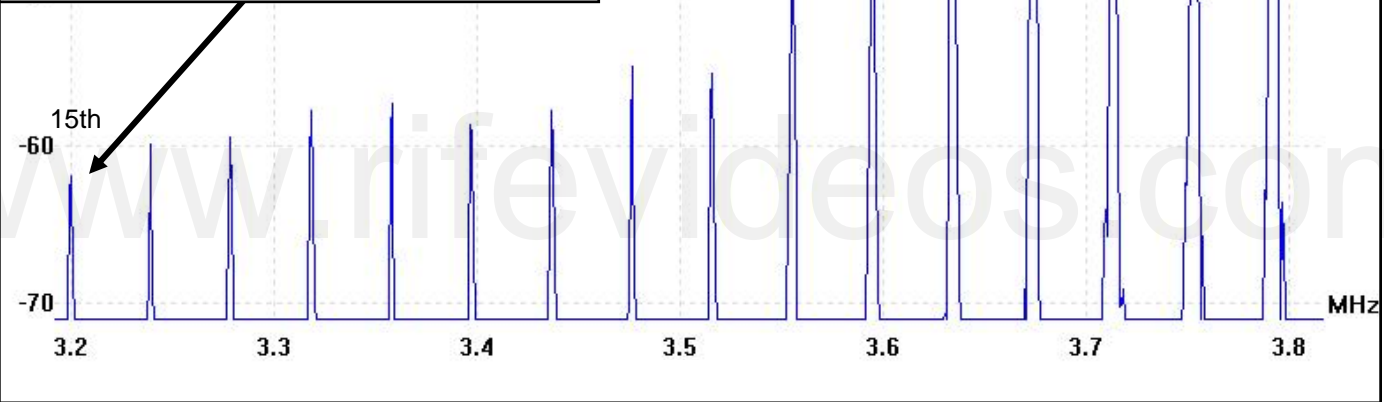

Philip Hoyland's Beam Rays Clinical instrument 3.8 Megahertz spectrum analysis of sideband harmonic frequencies.

Rife Ray #4 233,000 Hertz for Gonorrhea. The 16th Higher harmonic frequency is 3,728,000 Hertz. The audio frequency used for the proper sideband spacing is 14,400 Hertz. The 5th lower sideband hit the M.O.R.

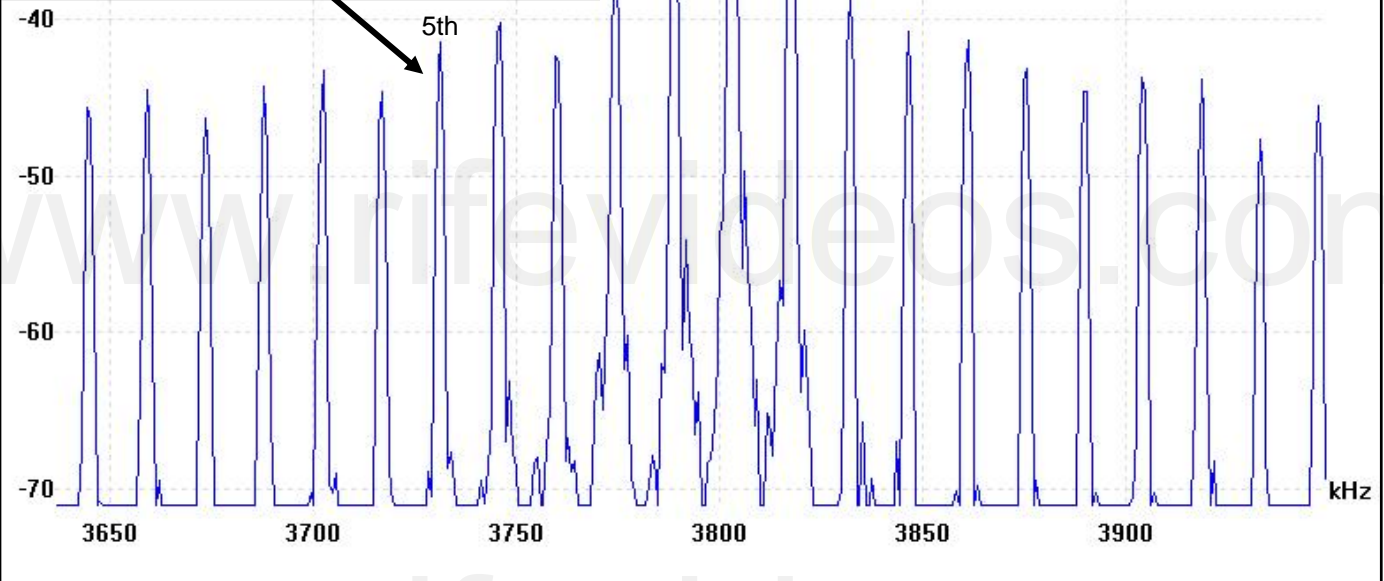

Philip Hoyland's Beam Rays Clinical instrument 3.8 Megahertz spectrum analysis of sideband harmonic frequencies.

Rife Ray #4 427,000 Hertz for Spinal Meningitis. The 9th Higher harmonic frequency is 3,843,000 Hertz. The audio frequency used for the proper sideband spacing is 8,600 Hertz. The 5th upper sideband hit the M.O.R.

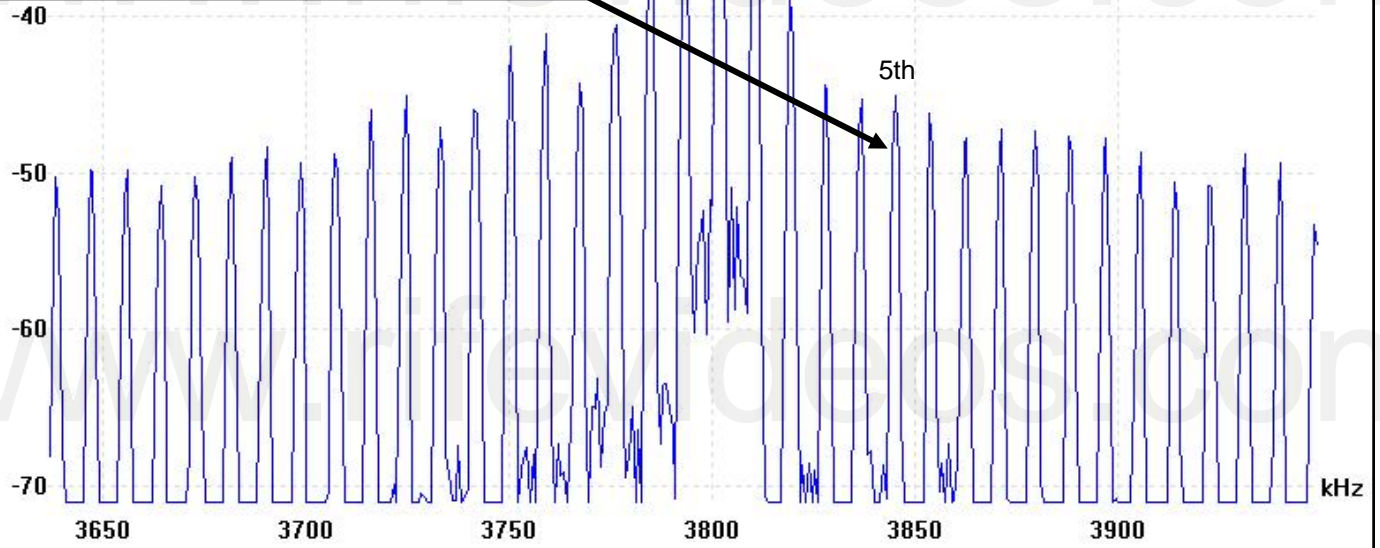

Philip Hoyland's Beam Rays Clinical instrument 3.8 Megahertz spectrum analysis of sideband harmonic frequencies.

Rife Ray #4 478,000 Hertz for Staphylococcus Pyogenes Aureus. The 8th Higher harmonic frequency is 3,824,000 Hertz. The audio frequency used for the proper sideband spacing is 8,000 Hertz. The 3rd upper sideband hit the M.O.R.

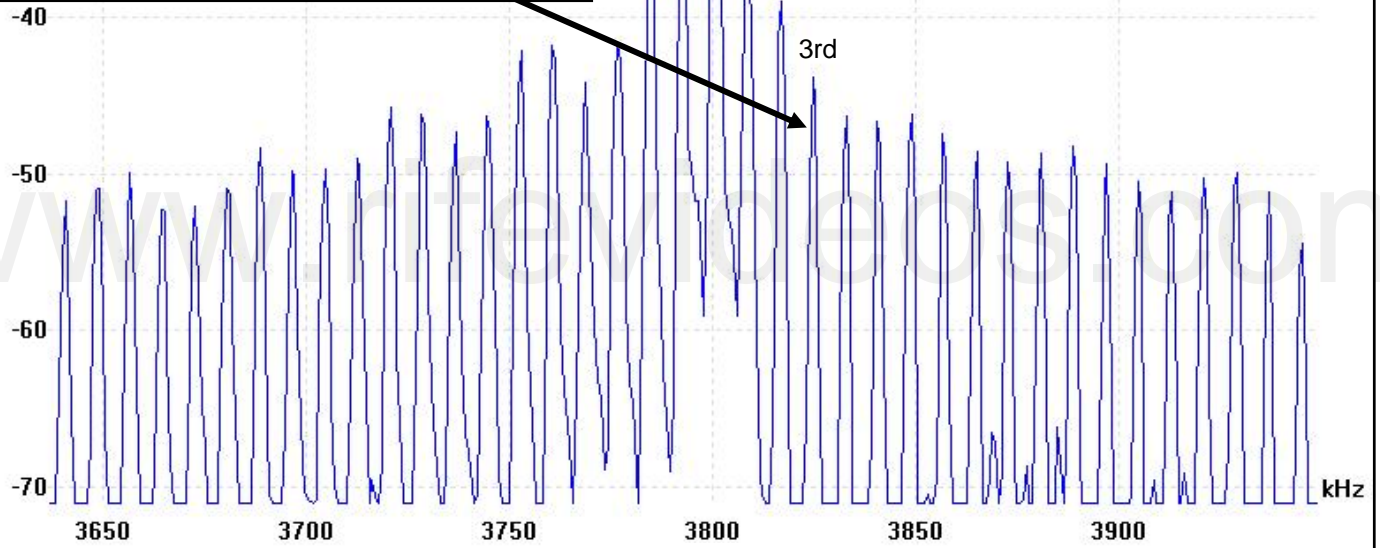

Philip Hoyland's Beam Rays Clinical instrument 3.8 Megahertz spectrum analysis of sideband harmonic frequencies.

Rife Ray #4 720,000 Hertz for Streptococcus Pyogenes. The 5th Higher harmonic frequency is 3,600,000 Hertz. The audio frequency used for the proper sideband spacing is 8,333 Hertz. The 24th lower sideband hit the M.O.R. The smaller the difference between the M.O.R. frequency and the carrier frequency the greater the number of sideband frequencies that can be used with power.

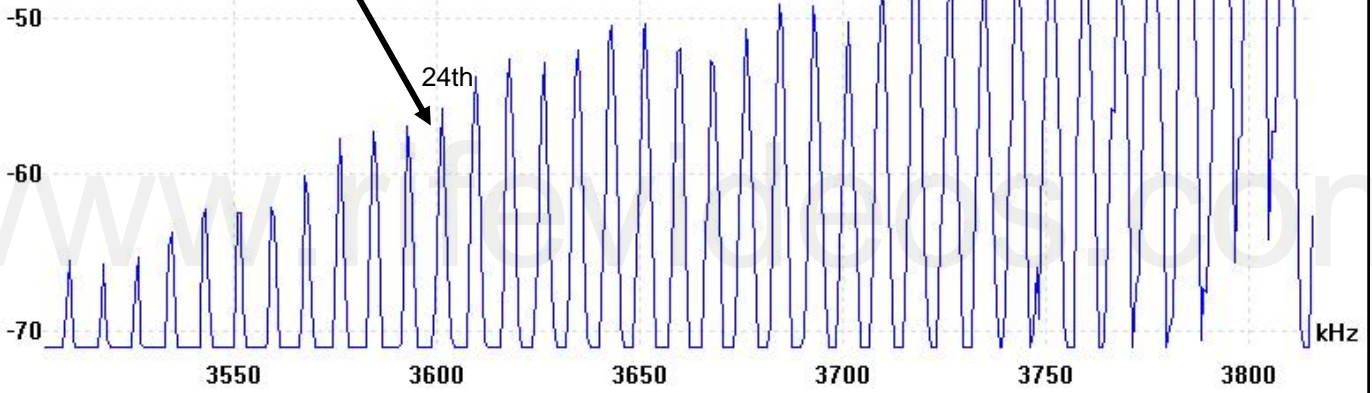

Philip Hoyland's Beam Rays Clinical instrument 3.8 Megahertz spectrum analysis of sideband harmonic frequencies.

Rife Ray #4 789,000 Hertz for Syphilis. The 5th Higher harmonic frequency is 3,945,000 Hertz. The audio frequency used for the proper sideband spacing is 6,591 Hertz. The 22nd upper sideband hit the M.O.R.

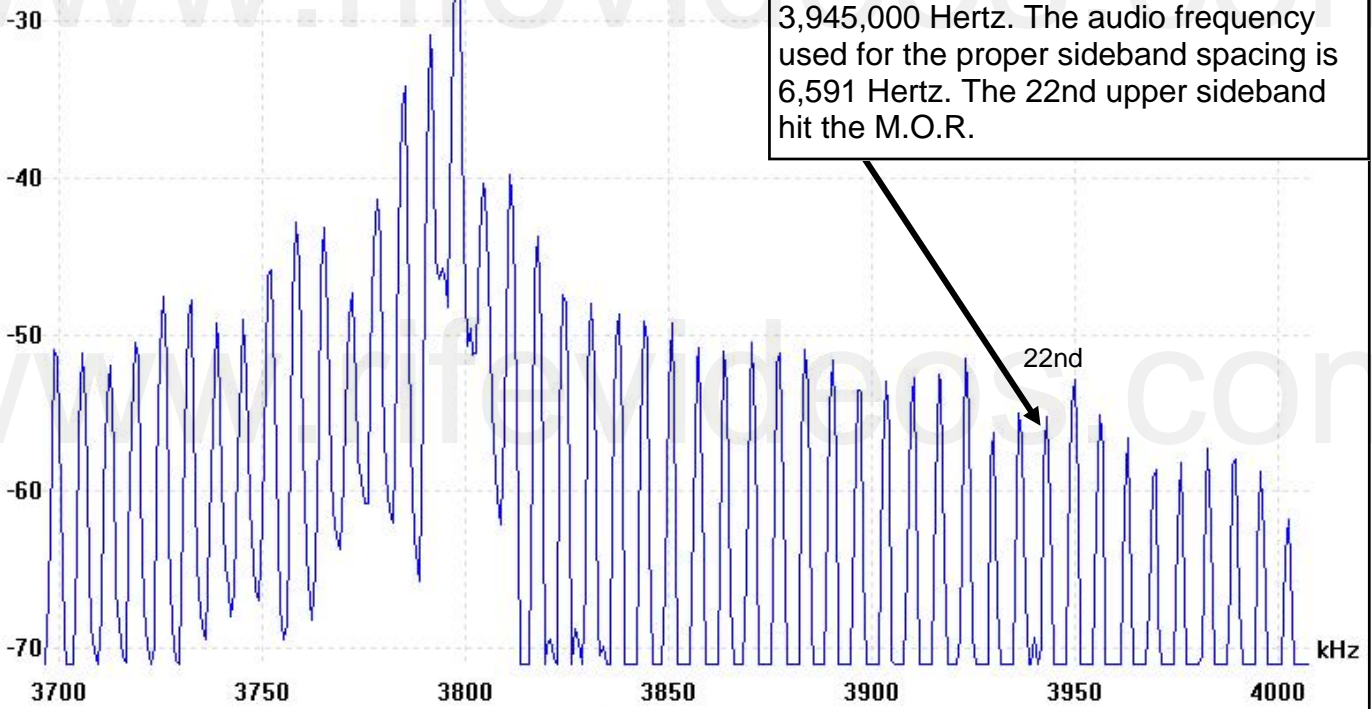

Philip Hoyland's Beam Rays Clinical instrument 3.8 Megahertz spectrum analysis of sideband harmonic frequencies.

Rife Ray #4 234,000 Hertz for Tetanus. The 16th Higher harmonic frequency is 3,744,000 Hertz. The audio frequency used for the proper sideband spacing is 11,200 Hertz. The 5th lower sideband hit the M.O.R.

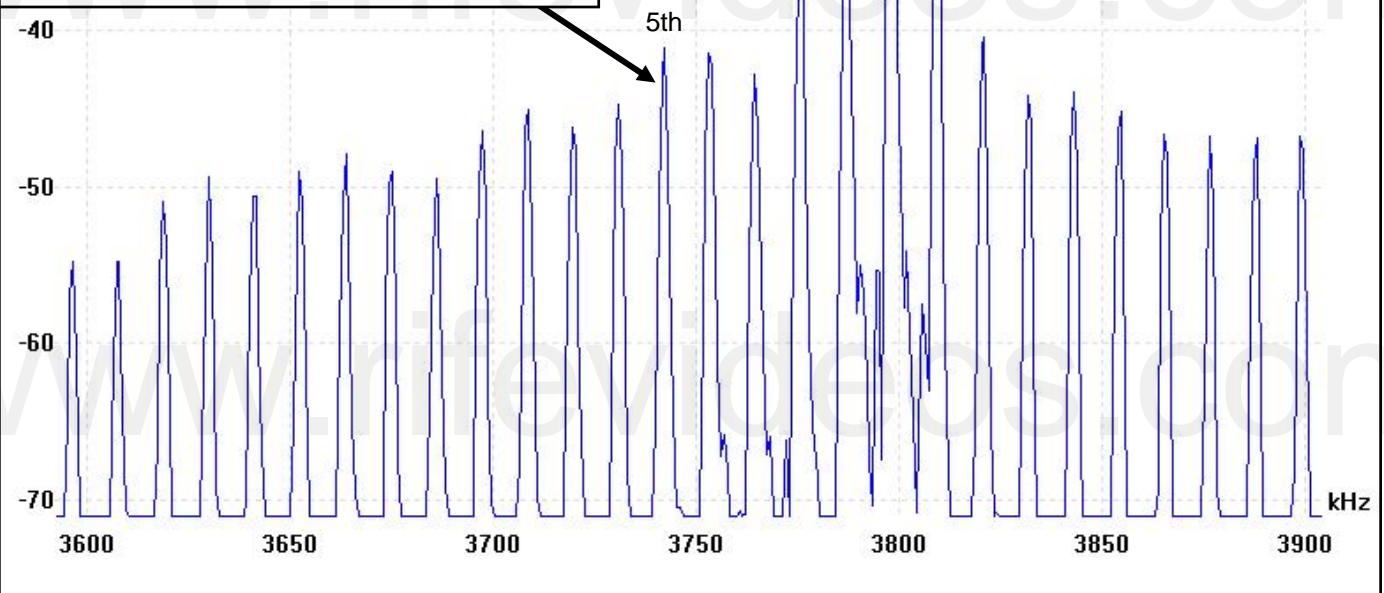

Philip Hoyland's Beam Rays Clinical instrument 3.8 Megahertz spectrum analysis of sideband harmonic frequencies.

Rife Ray #4 369,000 Hertz for Tuberculosis Rod. The 10th Higher harmonic frequency is 3,690,000 Hertz. The audio frequency used for the proper sideband spacing is 8,462 Hertz. The 13th lower sideband hit the M.O.R.

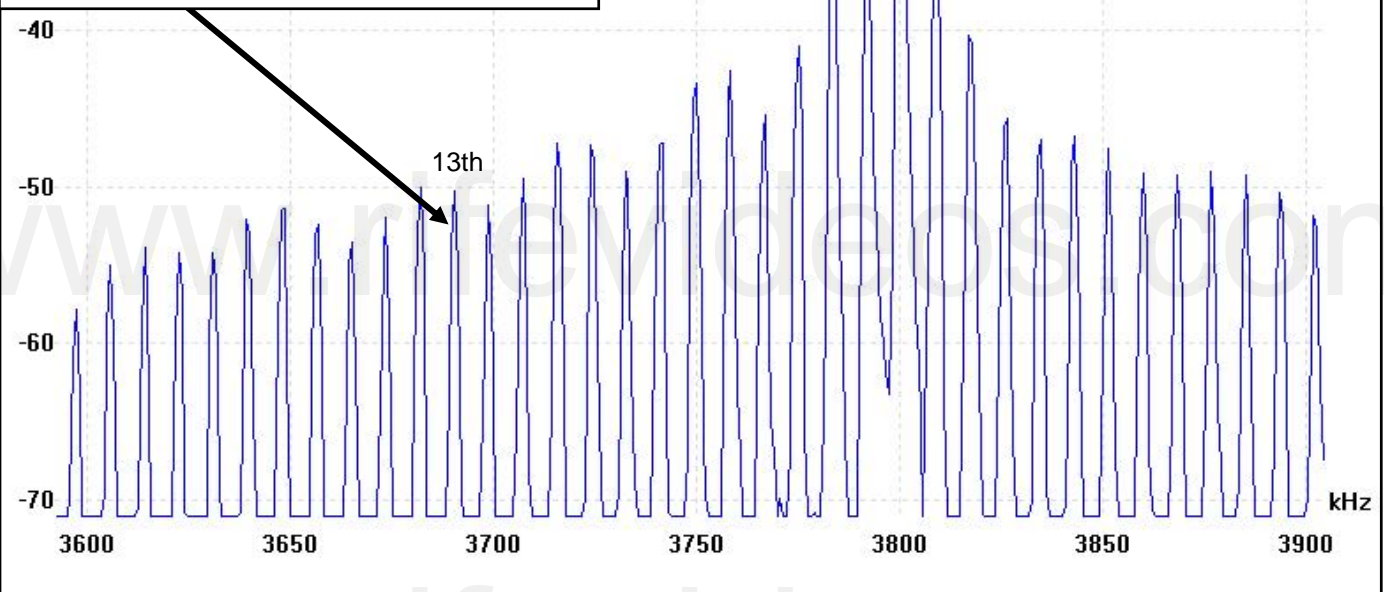

Philip Hoyland's Beam Rays Clinical instrument 3.8 Megahertz spectrum analysis of sideband harmonic frequencies.

Rife Ray #4 760,000 Hertz for Typhoid Rod. The 5th Higher harmonic frequency is 3,800,000 Hertz. The audio frequency used for the proper sideband spacing is 100 Hertz. The sidebands, when only 200 Hertz apart, look like one frequency hit the M.O.R.

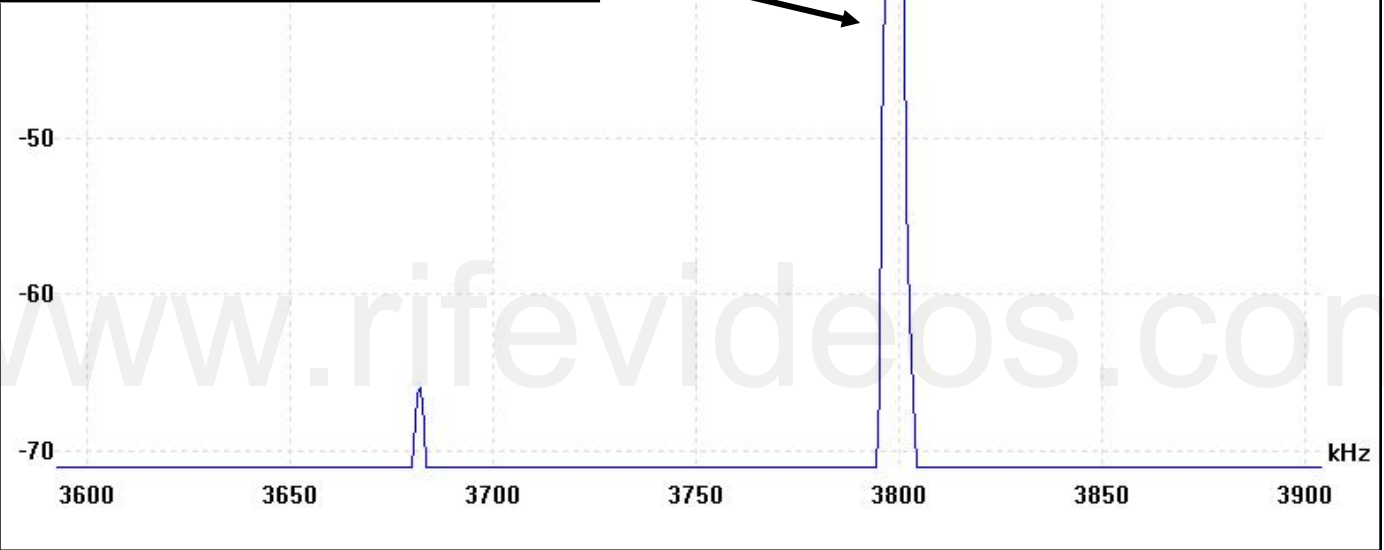

Philip Hoyland's Beam Rays Clinical instrument 3.8 Megahertz spectrum analysis of sideband harmonic frequencies.

Rife Ray #4 1,445,000 Hertz for Typhoid Virus. The 3rd Higher harmonic frequency is 4,335,000 Hertz. The audio frequency used for the proper sideband spacing is 38,214 Hertz. The 14th upper sideband hit the M.O.R.

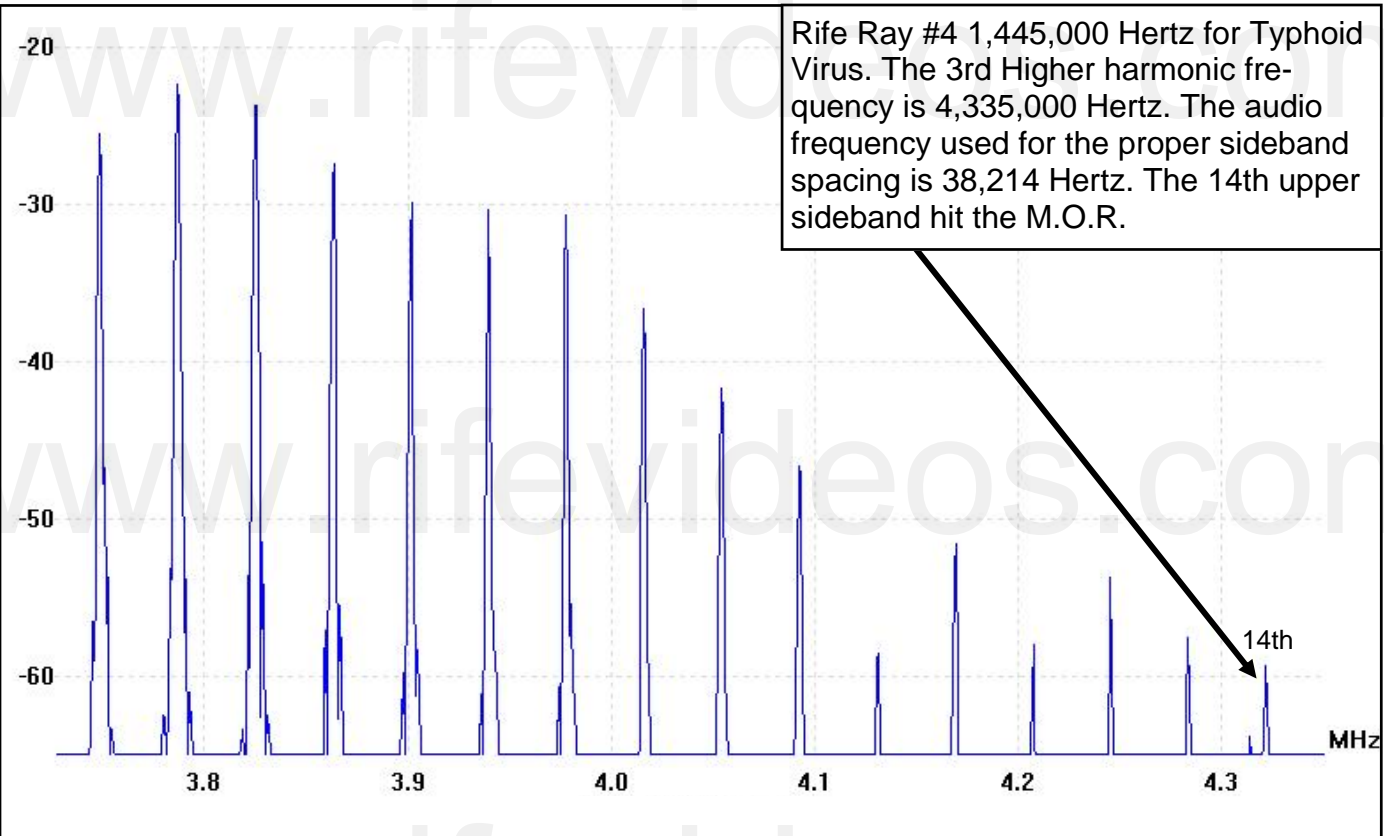

Philip Hoyland's Beam Rays Clinical instrument 3.8 Megahertz spectrum analysis of sideband harmonic frequencies.

Streptothrix		Anthrax		B or E Coil Rod		B or E Coil Viurs		BX Cancer Virus		Gonorrhea		Spinal Meningitis	
1	192000	1	139200	1	417000	1	770000	1	1604000	1	233000	1	427000
2	384000	2	278400	2	834000	2	1540000	2	3208000	2	466000	2	854000
3	576000	3	417600	3	1251000	3	2310000	3	4812000	3	699000	3	1281000
4	768000	4	556800	4	1668000	4	3080000	4	6416000	4	932000	4	1708000
5	960000	5	696000	5	2085000	5	3850000	5	8020000	5	1165000	5	2135000
6	1152000	6	835200	6	2502000	6	4620000	6	9624000	6	1398000	6	2562000
7	1344000	7	974400	7	2919000	7	5390000	7	11228000	7	1631000	7	2989000
8	1536000	8	1113600	8	3336000	8	6160000	8	12832000	8	1864000	8	3416000
9	1728000	9	1252800	9	3753000	9	6930000	9	14436000	9	2097000	9	3843000
10	1920000	10	1392000	10	4170000	10	7700000	10	16040000	10	2330000	10	4270000
11	2112000	11	1531200	11	4587000	11	8470000	11	17644000	11	2563000	11	4697000
12	2304000	12	1670400	12	5004000	12	9240000	12	19248000	12	2796000	12	5124000
13	2496000	13	1809600	13	5421000	13	10010000	13	20852000	13	3029000	13	5551000
14	2688000	14	1948800	14	5838000	14	10780000	14	22456000	14	3262000	14	5978000
15	2880000	15	2088000	15	6255000	15	11550000	15	24060000	15	3495000	15	6405000
16	3072000	16	2227200	16	6672000	16	12320000	16	25664000	16	3728000	16	6832000
17	3264000	17	2366400	17	7089000	17	13090000	17	27268000	17	3961000	17	7259000
18	3456000	18	2505600	18	7506000	18	13860000	18	28872000	18	4194000	18	7686000
19	3648000	19	2644800	19	7923000	19	14630000	19	30476000	19	4427000	19	8113000
20	3840000	20	2784000	20	8340000	20	15400000	20	32080000	20	4660000	20	8540000
21	4032000	21	2923200	21	8757000	21	16170000	21	33684000	21	4893000	21	8967000
22	4224000	22	3062400	22	9174000	22	16940000	22	35288000	22	5126000	22	9394000
23	4416000	23	3201600	23	9591000	23	17710000	23	36892000	23	5359000	23	9821000
24	4608000	24	3340800	24	10008000	24	18480000	24	38496000	24	5592000	24	10248000
25	4800000	25	3480000	25	10425000	25	19250000	25	40100000	25	5825000	25	10675000
26	4992000	26	3619200	26	10842000	26	20020000	26	41704000	26	6058000	26	11102000
27	5184000	27	3758400	27	11259000	27	20790000	27	43308000	27	6291000	27	11529000
28	5376000	28	3897600	28	11676000	28	21560000	28	44912000	28	6524000	28	11956000
29	5568000	29	4036800	29	12093000	29	22330000	29	46516000	29	6757000	29	12383000
30	5760000	30	4176000	30	12510000	30	23100000	30	48120000	30	6990000	30	12810000
31	5952000	31	4315200	31	12927000	31	23870000	31	49724000	31	7223000	31	13237000
32	6144000	32	4454400	32	13344000	32	24640000	32	51328000	32	7456000	32	13664000
33	6336000	33	4593600	33	13761000	33	25410000	33	52932000	33	7689000	33	14091000
34	6528000	34	4732800	34	14178000	34	26180000	34	54536000	34	7922000	34	14518000

Staph Pyo Aureus		Strept Pyogenes		Syphilis		Tetanus		Tuberculosis Rod		Typhoid Rod		Typhoid Virus	
1	478000	1	720000	1	789000	1	234000	1	369000	1	760000	1	1445000
2	956000	2	1440000	2	1578000	2	468000	2	738000	2	1520000	2	2890000
3	1434000	3	2160000	3	2367000	3	702000	3	1107000	3	2280000	3	4335000
4	1912000	4	2880000	4	3156000	4	936000	4	1476000	4	3040000	4	5780000
5	2390000	5	3600000	5	3945000	5	1170000	5	1845000	5	3800000	5	7225000
6	2868000	6	4320000	6	4734000	6	1404000	6	2214000	6	4560000	6	8670000
7	3346000	7	5040000	7	5523000	7	1638000	7	2583000	7	5320000	7	10115000
8	3824000	8	5760000	8	6312000	8	1872000	8	2952000	8	6080000	8	11560000
9	4302000	9	6480000	9	7101000	9	2106000	9	3321000	9	6840000	9	13005000
10	4780000	10	7200000	10	7890000	10	2340000	10	3690000	10	7600000	10	14450000
11	5258000	11	7920000	11	8679000	11	2574000	11	4059000	11	8360000	11	15895000
12	5736000	12	8640000	12	9468000	12	2808000	12	4428000	12	9120000	12	17340000
13	6214000	13	9360000	13	10257000	13	3042000	13	4797000	13	9880000	13	18785000
14	6692000	14	10080000	14	11046000	14	3276000	14	5166000	14	10640000	14	20230000
15	7170000	15	10800000	15	11835000	15	3510000	15	5535000	15	11400000	15	21675000
16	7648000	16	11520000	16	12624000	16	3744000	16	5904000	16	12160000	16	23120000
17	8126000	17	12240000	17	13413000	17	3978000	17	6273000	17	12920000	17	24565000
18	8604000	18	12960000	18	14202000	18	4212000	18	6642000	18	13680000	18	26010000
19	9082000	19	13680000	19	14991000	19	4446000	19	7011000	19	14440000	19	27455000
20	9560000	20	14400000	20	15780000	20	4680000	20	7380000	20	15200000	20	28900000
21	10038000	21	15120000	21	16569000	21	4914000	21	7749000	21	15960000	21	30345000
22	10516000	22	15840000	22	17358000	22	5148000	22	8118000	22	16720000	22	31790000
23	10994000	23	16560000	23	18147000	23	5382000	23	8487000	23	17480000	23	33235000
24	11472000	24	17280000	24	18936000	24	5616000	24	8856000	24	18240000	24	34680000
25	11950000	25	18000000	25	19725000	25	5850000	25	9225000	25	19000000	25	36125000
26	12428000	26	18720000	26	20514000	26	6084000	26	9594000	26	19760000	26	37570000
27	12906000	27	19440000	27	21303000	27	6318000	27	9963000	27	20520000	27	39015000
28	13384000	28	20160000	28	22092000	28	6552000	28	10332000	28	21280000	28	40460000
29	13862000	29	20880000	29	22881000	29	6786000	29	10701000	29	22040000	29	41905000
30	14340000	30	21600000	30	23670000	30	7020000	30	11070000	30	22800000	30	43350000
31	14818000	31	22320000	31	24459000	31	7254000	31	11439000	31	23560000	31	44795000
32	15296000	32	23040000	32	25248000	32	7488000	32	11808000	32	24320000	32	46240000
33	15774000	33	23760000	33	26037000	33	7722000	33	12177000	33	25080000	33	47685000
34	16252000	34	24480000	34	26826000	34	7956000	34	12546000	34	25840000	34	49130000

The Gruner schematic of Philip Hoyland's Beam Rays Laboratory instrument

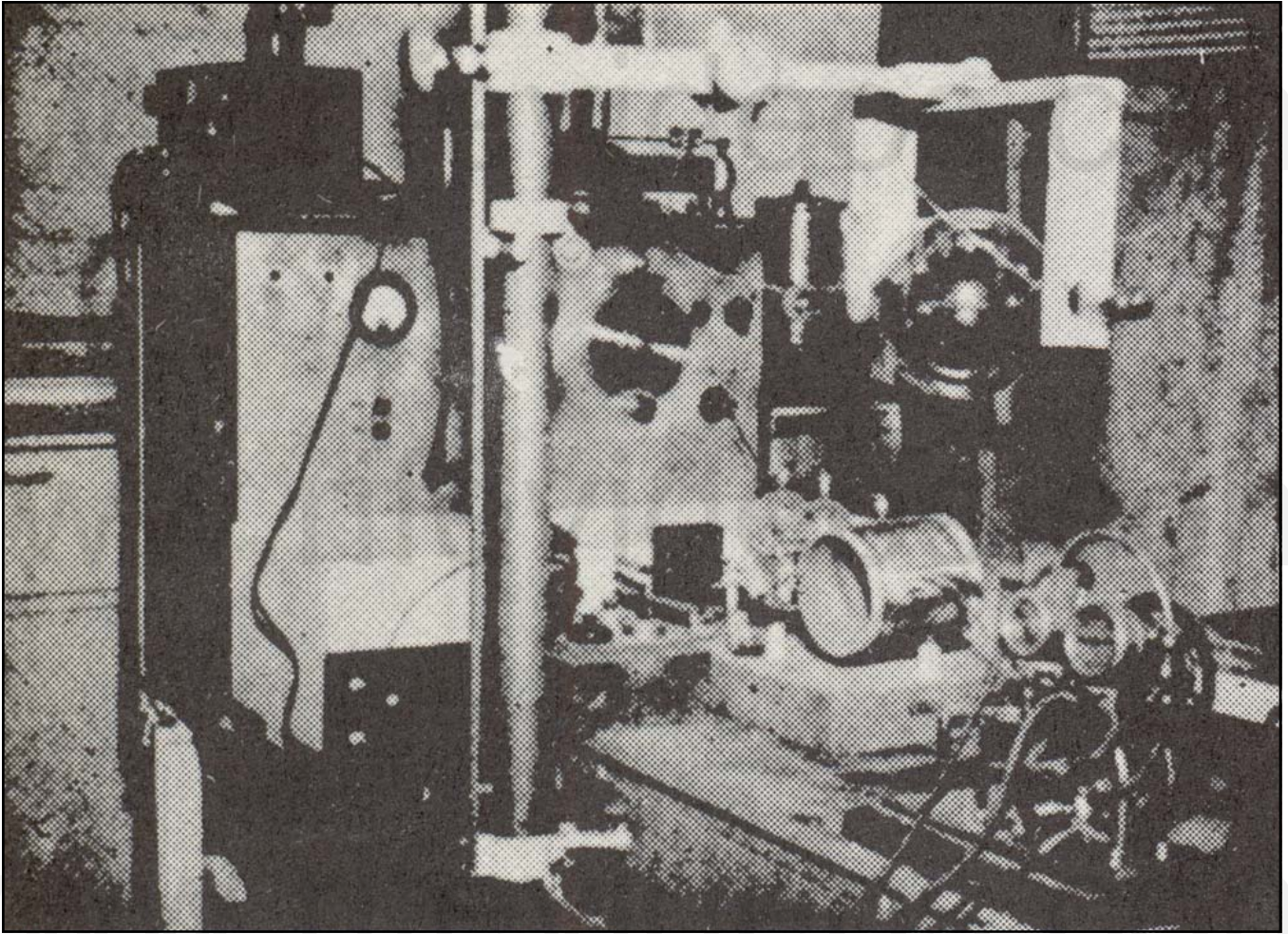

- 1) Used a ray tube.
- 2) Had two separate oscillators so it could output two frequencies at a time.
- 3) Frequency range was at least from about 87,000 Hertz to 2MHz.
- 3) Power usage was about 450 to 600 watts. Output to the ray tube was probably 80 watts.

In the previous version of this paper we dealt with the concept that the Beam Rays Clinical instrument was a heterodyning instrument. Now we know that this method was not used in the original Beam Rays Clinical instrument therefore the heterodyning concept has been removed from this rewriting of this document. Though the Rife Ray #4 could output two frequencies at the same time and they would have heterodyned this was a byproduct of the instrument not the method used to produce the M.O.R. frequencies needed to devitalize the microorganisms. We know what the original Beam Rays Clinical instruments looked like but we now must determine what the Laboratory instrument looked like.

The instrument in the photo above was probably built in 1936 by Philip Hoyland. John Crane dated the instrument in this photo as being built in 1935 but we know that the Rife Ray #4 was built in 1935. The knowledge of the Laboratory instrument came from the Beam Rays Trial manuscript. A complete copy of this transcript was provided when Steven Ross let me scan it. I would like to acknowledge his generous contribution of this information which has given us a great deal of understanding so that we could figure out the history of how and when the instruments were built.

After reading for the first time the complete Beam Rays Trial manuscript I found there was mention of a Laboratory instrument. It appeared that this Laboratory instrument was probably to be used by those who would be working in laboratories with microorganisms for testing. Dr. O. C. Gruner

worked in a laboratory with organisms and worked with Dr. Rife on the organism called [Cryptomyces Pleomorpha fungi](#). The Laboratory instrument was mentioned two or three times but no real information was given about it. Below are statements made by Bertrand Comparet and Philip Hoyland in the Beam Rays Trial that gives us some important information about this instrument:

COMPARET: *“The four machines bought by the British were two so-called laboratory types and two so-called clinical types, what was the difference between the two.”*

HOYLAND: *“The clinical type was similar in all respects to the Rife machine except that it did not have (word missing) of the (word missing) used on Mrs. Henderson.”*

COMPARET: *“How was the price of these machines fixed.”*

HOYLAND: *“The price was decided from the costs of what it cost to manufacture the first machine that was sold to Dr. Hamer.”*

COMPARET: *“How much was that?”*

HOYLAND: *“I think it was four hundred dollars plus the royalty.”*

COMPARET: *“Wasn’t it five hundred dollars plus royalty on the clinical type and six plus royalty on the lab type.”*

HOYLAND: *“I don’t remember.”*

Since this instrument was for Laboratory work it probably worked like the Rife Ray #4 but because the case was smaller it probably had a smaller frequency range. The Rife Ray #4 had nine frequency bands that covered from 87,000 hertz to 22.5MHz (22,500,000 hertz). The first four bands of the #4 covered from 87,000 hertz to 2,140,000 hertz. These four frequency bands would cover the whole list of Dr. Rife’s disease organisms listed on the Rife Ray #4 documents. With this understanding we know that the Laboratory instrument at least covered this frequency range so we will not speculate if it had a higher frequency range because we really do not know.

Deciphering the Beam Rays Laboratory instrument schematic

Even though the heterodyning method was not used in Dr. Rife’s instruments the testing out of this method as mentioned in the previous version of this paper has shed a great deal of light on the building of Dr. Rife’s instruments. For this reason much of the history and work that we did is still included in this paper since it has given us the understanding of how the Rife Ray # 4 worked and how the Beam Rays Laboratory instrument would have worked.

Jim Peters, Jason Ringas, and I had been looking at the Beam Rays instrument in hopes of trying to figure out how it worked. I had built and tested both the 1950’s AZ-58 and 1940’s Aubrey Scoon, Beam Rays replica instruments. To our knowledge none of these instruments ever obtained the same results as the original Beam Rays Clinical instrument. All the documentation we had showed that there were changes made to the original Beam Rays design which compromised the 1950’s AZ-58, and possibly 1940’s Aubrey Scoon, Verne Thompson instruments. John Crane, over the years told many people that the AZ-58 and the frequencies it used were Dr. Rife’s original frequencies. The Rife documents we have show that what John Crane claimed was not correct. Dr. Rife was not using audio frequencies in 1934 as John Crane and John Marsh claimed. Rebuild of the AZ-58 and Aubrey Scoon instrument partially made the rediscovery of the Beam Rays Laboratory instrument possible.

At the 2003 Rife Conference, Ron Rockwell put up the Gruner schematic of an original Beam Rays instrument. From reading the Rife documents I knew that this schematic existed because John

Crane had mentioned it in his papers. John Crane said that the AZ-58 was built from that schematic. When I saw it I knew it was important, so I took still photos of it with my video camera. Because the video camera only had a one mega-pixel capability I took many up close photos knowing I could put it back together at a later date. Back in 2004 I gave this schematic to Aubrey Scoon and his British Rife group in hopes that they could look it over and correct any mistakes that may have been made. They redrew the schematics, without fully correcting them and put them up on their web site. I did this because I wanted everyone to have access to it.

Back on July 27, 2007 Stuart Andrews, who was one of the British Rife group and I got into another conversation about the Gruner schematic. He asked me to send him another copy of the original Gruner schematic so he could look it over again. An email conversation began at that time which included Jason Ringas, Jim Peters, Stewart Andrews, Jim Berger and myself. Jim Peters immediately noticed that the schematic that had been redrawn by the British group had some errors in it. Discussions continued on and off for a few months until one day Jim Peters noticed an oversight when looking over the schematic again. At the time I thought it had to do with the heterodyning method but now this oversight was one of the keys to understanding how the Rife Ray #4 and Beam Rays Laboratory instrument would have worked.

Jim Peters sent Jason Ringas and I an email. He mentioned that a possible test could be made that would determine if this observation of his was the key to understanding how the Beam Rays Laboratory instrument really worked. I called Jim Peters and had a discussion with him and he told me how we could make these tests. I told him that we did not need to do the test with solid state frequency generators because I had conducted a similar test back when John Bedini and I were working on the AZ-58 tests. John Bedini and I knew that the original Beam Rays instrument was a lot more powerful than the AZ-58 because of the Rife documents. After more accurate testing we found the AZ-58 only output about 40 watts from the ray tube. I told him that I still had my 1940s Aubrey Scoon replica and several AZ-58's on the shelf. I told John Bedini that the original Beam Rays instrument, from the documentation that we had, output about 50 to 60 watts from the ray tube. He told me how I could make a test, by putting two AZ-58s together, which would give me at least 60 watts out of the ray tube. I didn't know it at that time but that test was probably the way the Rife Ray #4 and Beam Rays Laboratory instrument worked. I told Jim Peters I would connect the AZ-58 and Aubrey Scoon instruments together again and make the tests that he suggested, but this time I would use my spectrum analyzer and we would fully test it out and find out if this was the method Philip Hoyland used. This test made the two instruments work exactly the same as the Gruner, Beam Rays schematic would have worked. This test was the key to understanding how Philip Hoyland's instrument worked. I had always stated that Philip Hoyland had to have come up with his method using math because they didn't have any spectrum analyzers back in 1936. In looking back that test showed that the Rife Ray #4 was heterodyning in the ray tube. Though we now know the heterodyning method was not used by Dr. Rife the method of connecting the ray tube up to two RF oscillators showed that this was the method used with the Rife Ray #4 and Beam Rays Laboratory instrument.

We will now show how Philip Hoyland's Beam Rays Laboratory instrument worked. We can do this because we have been able to rebuild this instrument from the Gruner schematic. This information should be of great interest to all who have been interested in Dr. Rife's work.

Rebuilding the Philip Hoyland Beam Rays Laboratory instrument

Jim Peters noticed that the British group had overlooked a second Hartley RF oscillator that was in the lower left corner of the Gruner schematic. They just believed this oscillator was the same RF fixed Hartley Oscillator that used the 809 tube. On the next page are four photos of the Gruner, Beam Rays schematic. On the top left, is the complete Gruner schematic. On the top right, is the fixed RF carrier frequency section that used the 809 tube. The middle photo, on the right, is the second oscillator that was overlooked. You will notice that it says Hartley Oscillator. Because the first fixed oscillator that used the 809 tube is a Hartley Oscillator they just assumed that both of these oscillators were the same. This is where the error was made. If you look at the second Harley Oscillator, in the middle

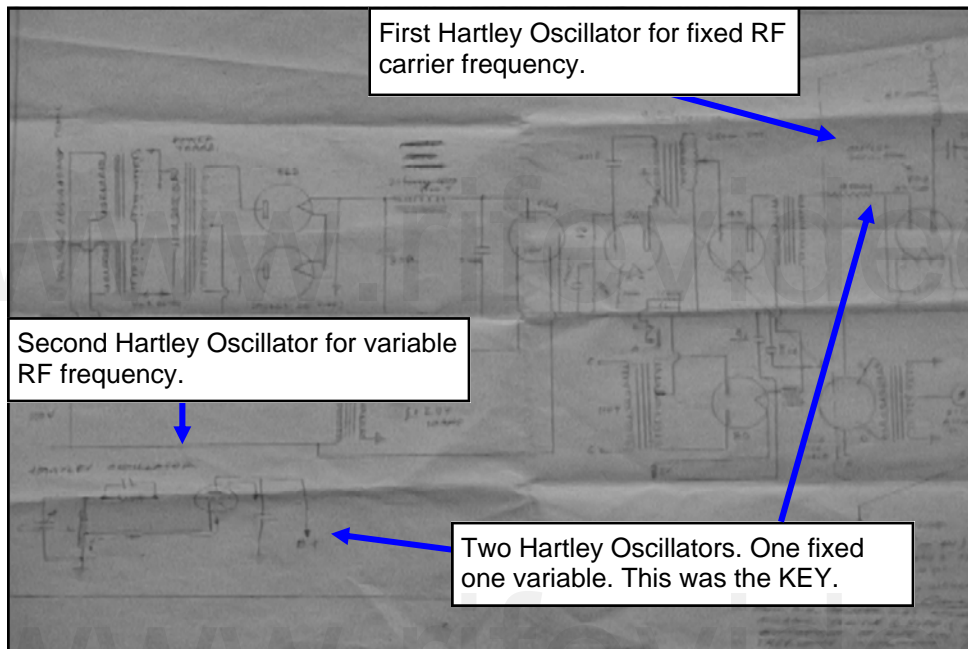

First Hartley Oscillator for fixed RF carrier frequency.

Second Hartley Oscillator for variable RF frequency.

Two Hartley Oscillators. One fixed one variable. This was the KEY.

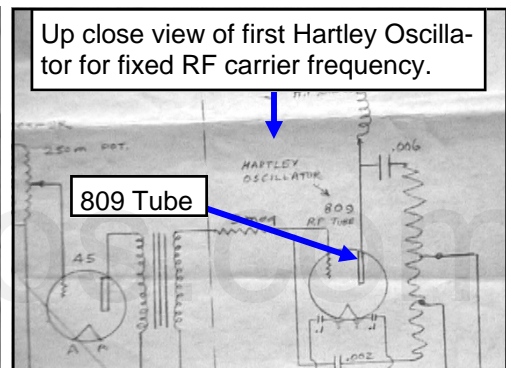

Up close view of first Hartley Oscillator for fixed RF carrier frequency.

809 Tube

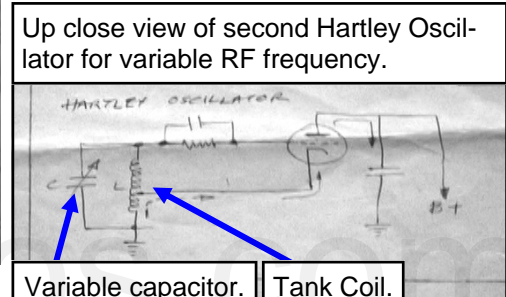

Up close view of second Hartley Oscillator for variable RF frequency.

Variable capacitor. Tank Coil.

photo, that does not use the 809 tube, you will notice that it has a variable capacitor. This variable capacitor shows that there were two Hartley Oscillators. The fourth photo, bottom right, shows that the first fixed Hartley Oscillator was connected from the tank coil to the negative side of the ray tube. If you look closely at the photo you will notice that the positive side of the ray tube was also to be connected to a Hartley Oscillator. If you hooked the positive side of the ray tube back up to the same fixed Hartley Oscillator it wouldn't work. This is why there was confusion on how this instrument worked. The positive side of the ray tube is supposed to be hooked to the second variable Hartley Oscillator. The ray tube is connected between the two Hartley Oscillators.

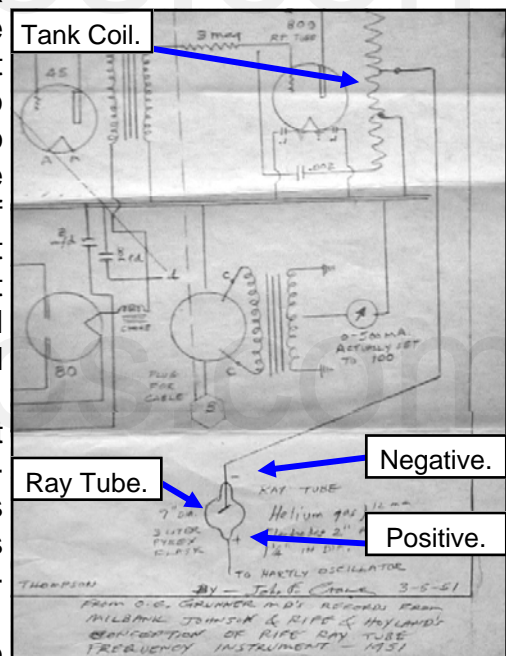

Tank Coil.

Ray Tube.

Negative.

Positive.

The second Hartley Oscillator was also an RF Oscillator. It has a tank coil and a variable capacitor for changing the RF frequencies. Anyone looking at this schematic will notice that it does not have any variable audio oscillator. Philip Hoyland's Beam Rays Laboratory instrument was using RF frequencies not audio frequencies and output the Rife Ray #4 frequencies.

The logical way to build the instrument would have been to have had two Hartley Oscillators using the 809 tubes. This is the way that we rebuilt the instrument. By using the method of connecting the ray tube between the two Hartley Oscillators, both variable, the instrument could output two high RF frequencies at the same time without the bandwidth problems that would have come with trying to modulate frequencies through a tank coil. The tank coils in the Beam Rays instrument can only pass modulated frequencies up to about 250,000 hertz. By putting the ray tube between the two Hartley Oscillators Philip Hoyland was able to build an instrument that could output two frequencies at the same time. This instrument probably had some band switches like the Rife Ray #4. What the frequency range of this Beam Rays Laboratory instrument is was not known but it would have gone up to at least 2 MHz like the Kennedy equipment #3 instrument. Dr. Rife's #3 and #4 instruments put out specific frequencies and this instrument it appears was built to do the same thing. If Dr. Rife wanted 1,604,000 hertz he would set the oscillator to 1,604,000 hertz. This was the type of instrument Dr. Rife used. When you look at the case of the Laboratory instrument it is a large case that could have easily held the necessary components for this instrument. The instrument would have had two large dials on the front of it. The pole that holds the ray tube is blocking part of the panel where we would expect to see the second dial for the second oscillator.

There is another feature that the Beam Rays Laboratory instrument had. This feature was a gating circuit that pulsed the frequencies. We know it was important because it was considered the secret that made the instrument work. If you look at the top photo, on the right, you will see two audio transformers. This is the only indication of any audio frequency used in the Beam Rays Laboratory instrument. It is not a variable audio oscillator but is for a single fixed audio frequency. The 76 and 45 tubes along with the two audio transformers make up this circuit. Jim Peters built this section and found that the frequency was about 1330 hertz and gates the fixed Hartley Oscillator that used the 809 tube. The photo, second down on the right, is this rebuilt circuit. This 1330 hertz frequency would wander a little bit up or down so the gate frequency of about 1200 to 1400 hertz could have easily come from this circuit. This gate frequency is a lot faster than the eye can see so no one would know it was in the instrument. If you look at next photo, third down on the right, you will see the waveform of the gate frequency. It resembles a damped wave, minus the ring oscillations of a true damped wave. This waveform would produce the effect that John Crane mentioned as he narrated Dr. Rife's 1936 Lab video.

Crane: *"Now the spikes that you see on the frequencies are the lethal part that kill and devitalize the virus. They are the resonant peaks of the frequencies which increase the voltage to a very high potential which the cells of the virus wall can not tolerate and they break up into many pieces and are destroyed."* (Dr. Rife's Lab Film Narrated by John Crane in the 1970s)

I doubt that this understanding would have been something that John Crane would have known anything about if Dr. Rife hadn't told him about it. From the statements we have read the resonant frequency of an organism is not enough to devitalize it. It's apparent that an organism's resonant frequency will not harm it unless the resonant frequency is gated or modulated with a waveform that produces a high potential resonant voltage rise. All of Dr. Rife's high RF frequencies were gated with this same low 1330 hertz audio frequency in the Beam Rays Laboratory instrument. It is apparent from the analyzing of the original Beam Rays Clinical instrument that a sine wave audio frequency modulated onto a carrier frequency was sufficient enough to create the necessary pulse to devitalize the various microorganisms. That Clinical instrument used frequencies well above 10,000 hertz so this indicates that the pulse or gate rate of the audio frequency is not that important.

There is another important effect that happens to the plasma of a ray tube when you gate it with a low audio frequency of a damped shaped waveform. Because the duty cycle is very low it allows deionization of the plasma which makes it possible for the very high potential voltage rise to be emitted

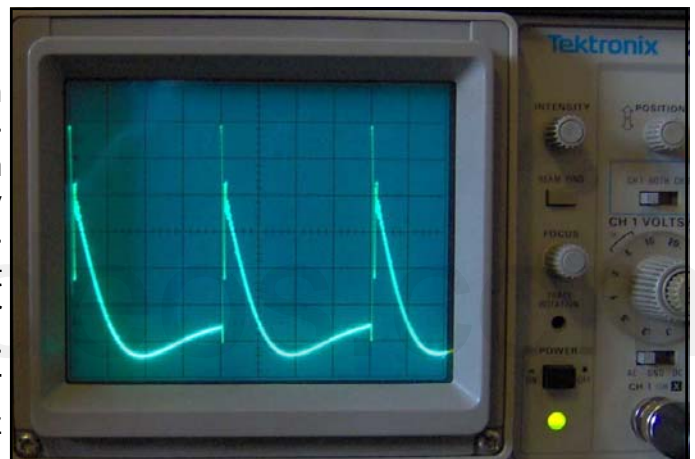
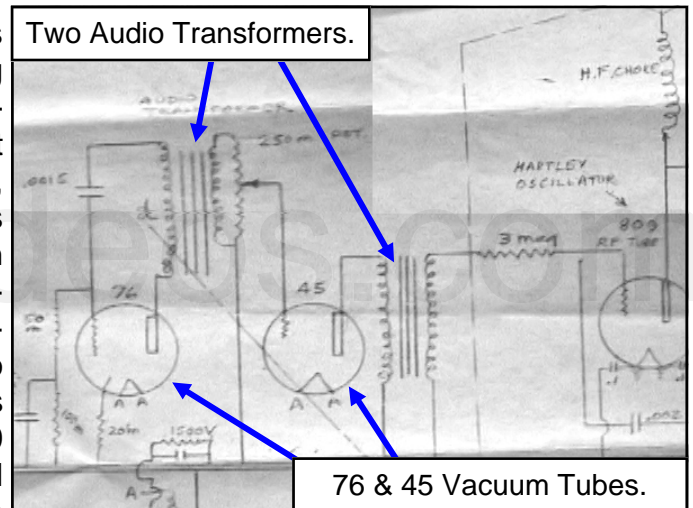

from the ray tube. A square wave audio frequency of about a 20 to 25% duty cycle should be just as effective as a damped waveform. A square wave has the same high potential voltage rise on the leading edge as this damped wave. Philip Hoyland found that even a sine wave frequency was sufficient to achieve the same result. His Beam Rays



Clinical instrument was modulated with a sine wave audio frequency and it would devitalize the organisms. This all indicates that an audio frequency modulation with a high frequency is what make the frequencies work on microorganisms. The waveform of the audio frequency whether it is a damped wave, sine wave or square wave makes no difference in its effectiveness.

The photo, top right, is a picture of Dr. Rife's waveform from his #4 instrument. This came from his 1936 lab film. The lab film shows that he put a metal plate about 3" X 8" under the ray tube and ran his oscilloscope lead to it so he could read the frequencies. This photo shows the type of waveform he was using to devitalize organisms. It also matches the waveform produced by the 76 and 45 vacuum tubes of the original Beam Rays instrument. We know from the rebuilding of this Beam Rays Laboratory instrument and from the analyzing of the Beam Rays Clinical instrument the waveform Dr. Rife used, how he created it, and the method that should be used for doing M.O.R research.

Both Jim Peters and I rebuilt the original Beam Rays Laboratory instrument. But we did not put in the various bands because we first believed it was a heterodyning instrument. Now that we know that Philip Hoyland's Beam Rays Clinical instrument used upper harmonics of the Rife Ray #4 frequencies it doesn't seem necessary that we put the different bands into the instrument. Our instruments will probably be adjusted so we can cover a range from about 1 MHz to about 4 or 5 MHz. Then we will multiply up the Rife Ray #4 frequencies into these ranges like Philip Hoyland did and use them with this instrument. Since the Gruner schematic was not a complete schematic and was redrawn by John Crane there is the possibility that it originally did not have any fixed RF oscillator. Like the Rife Ray # 4 the Laboratory instrument would have had two variable RF oscillators. The problem is we just do not have enough information about this instrument to come to any complete conclusion. The gate circuit was correctly drawn and worked. This indicates that they wanted this section of the schematic drawn correctly. Any good engineer could have easily built the rest of the instrument but the gating circuit was very unique.

Jim Peters built his instrument using 805 tubes and I built my instrument using 812A tubes. The AZ-58 replica RF section was almost exactly the same (809 vacuum tube replaced with the more powerful 812A tube) as the original Beam Rays Laboratory Circuit. The reason I built the original Beam Rays Laboratory instrument using the 812A tubes is because the 809 is no longer being manufactured. We were also able to replace the fixed 1330 hertz audio section consisting of the 45 & 76 tubes with a single high voltage switching transistor driven with a function generator which outputs the 1330 hertz gate frequency or any frequency we wish to use. Using this transistor we believe makes the design better because we can output all the lower audio frequencies including the original audio frequencies used in the AZ-58. My instrument has two Vernier dials which allows me to output two high RF frequencies at the same time like the Rife Ray #4 did. The ray tube is connected to both tank coils instead of having one side of it go to ground.

Please note that the modern Beam Rays instrument, built today, works nothing like this original 1930's Beam Rays Laboratory instrument built by Philip Hoyland. We are not trying to be negative about the modern Beam Rays instrument but some have asked us if these instruments work the same and they do not. We have given this information so people are not confused about these instruments. On pages 66 through 69 are the photos of the rebuilding of the original Beam Rays Laboratory instrument. On page 70 is a schematic for this instrument.

Jim Peters' photos of the rebuilt Beam Rays Laboratory instrument

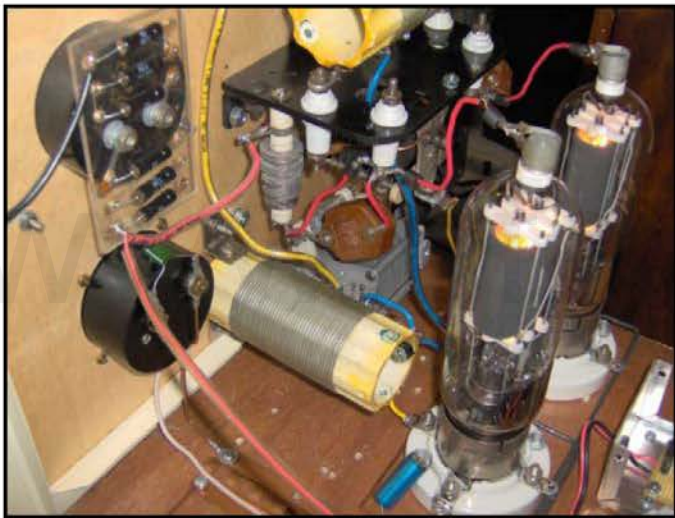
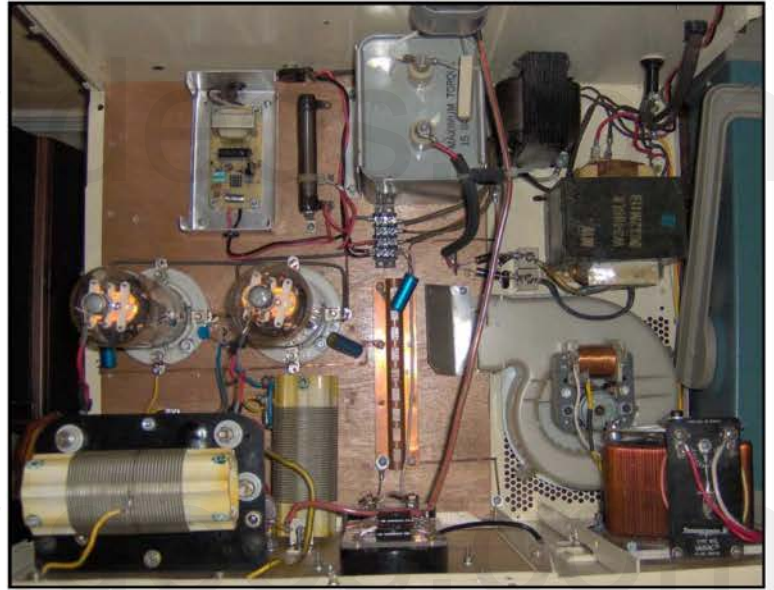

Photos of the rebuilt Beam Rays Laboratory instrument



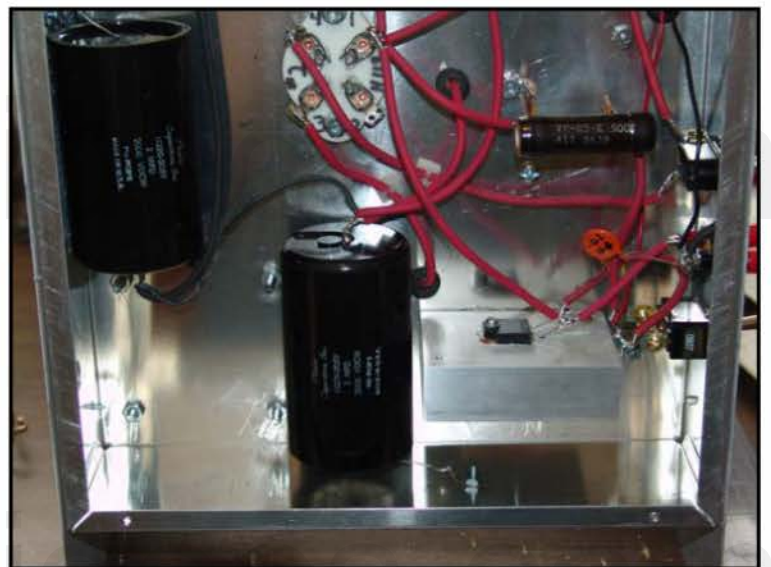
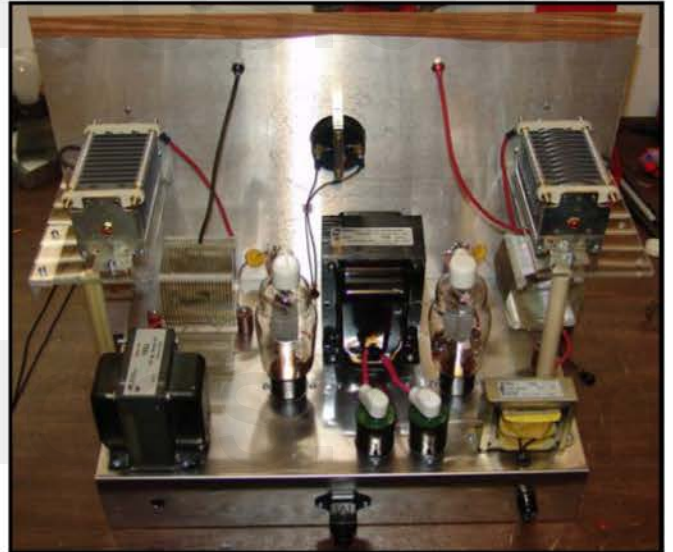
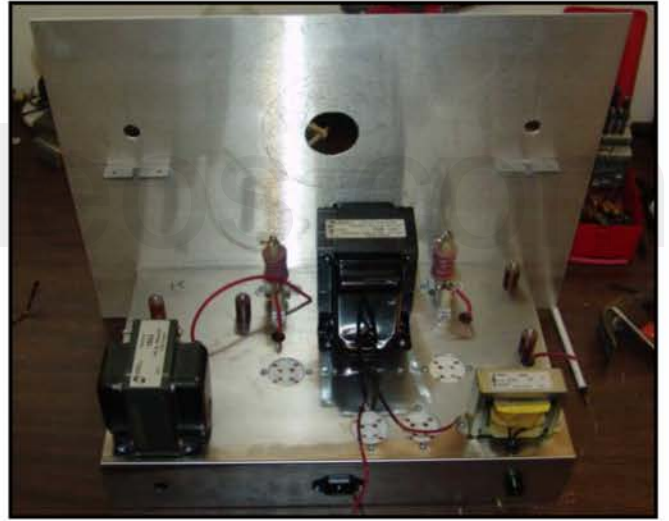

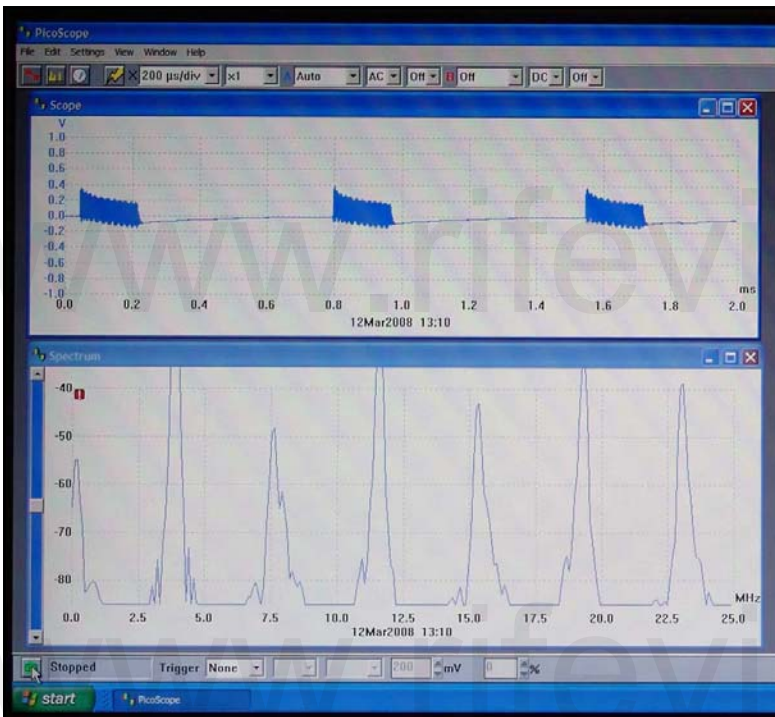
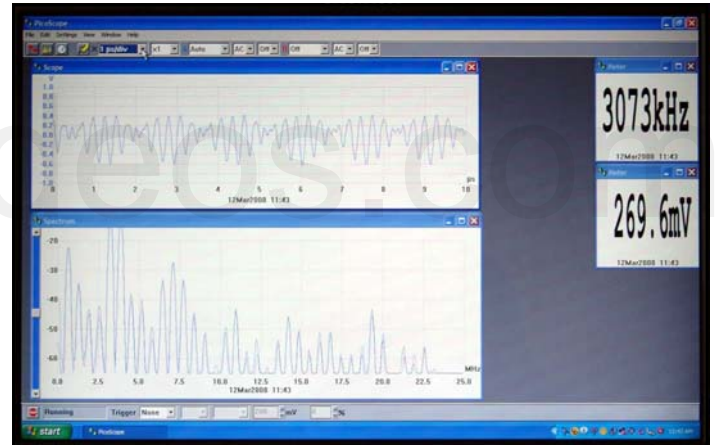
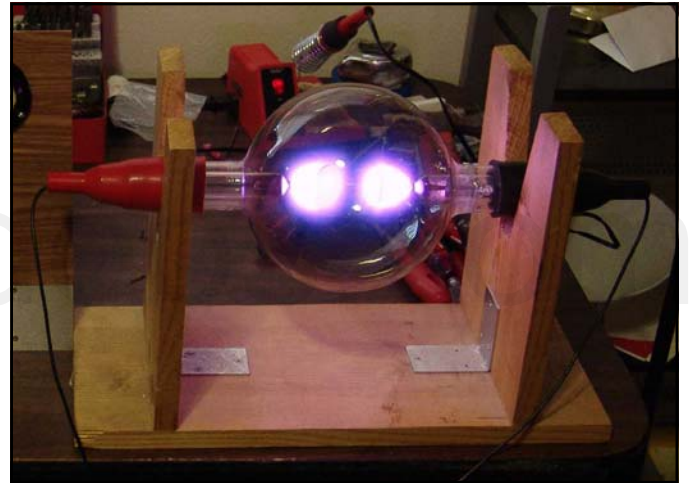
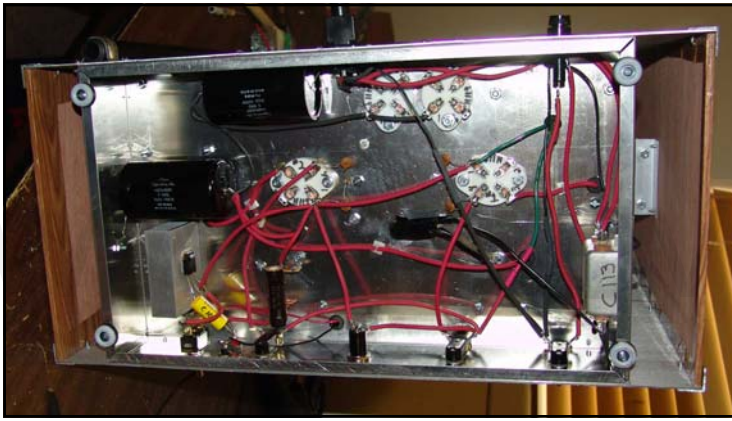

On the next page is a redrawn schematic of the original design. We replaced the smaller vacuum tube of the second Hartley Oscillator with the 809 tube. The layout of the electronic parts of this instrument is very important because of the inherent interference problems that come with RF oscillators. Anyone wishing to build this instrument should have a good understanding of old tube technology. Some parts of this circuit use up to 2000 volts DC with substantial current and can easily kill anyone not experienced in working with this kind of current or voltage. We take no responsibility for anyone who builds this instrument. We recommend that you have professional help.

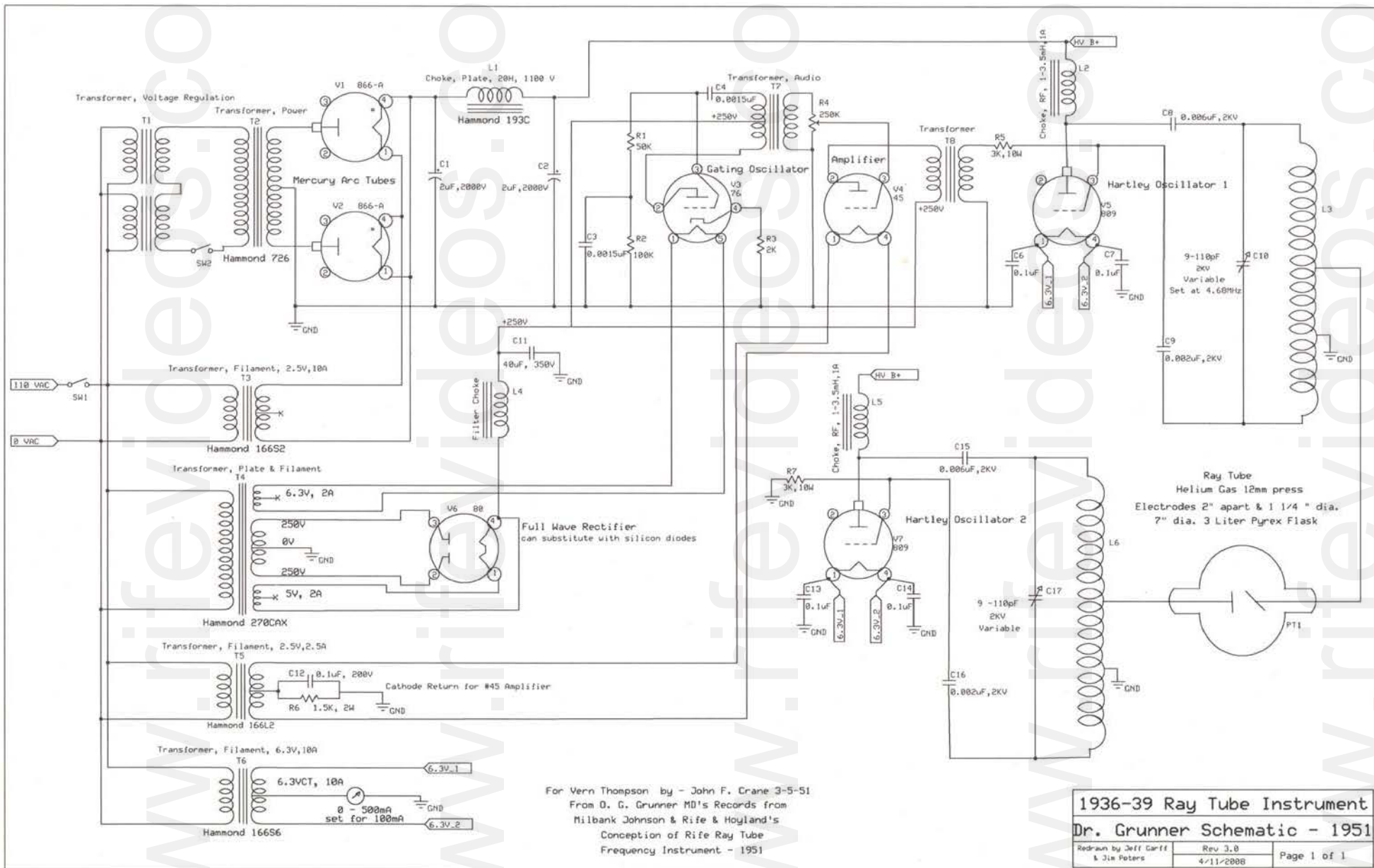

Aubrey Scoon's early 1940's Beam Rays replica instrument

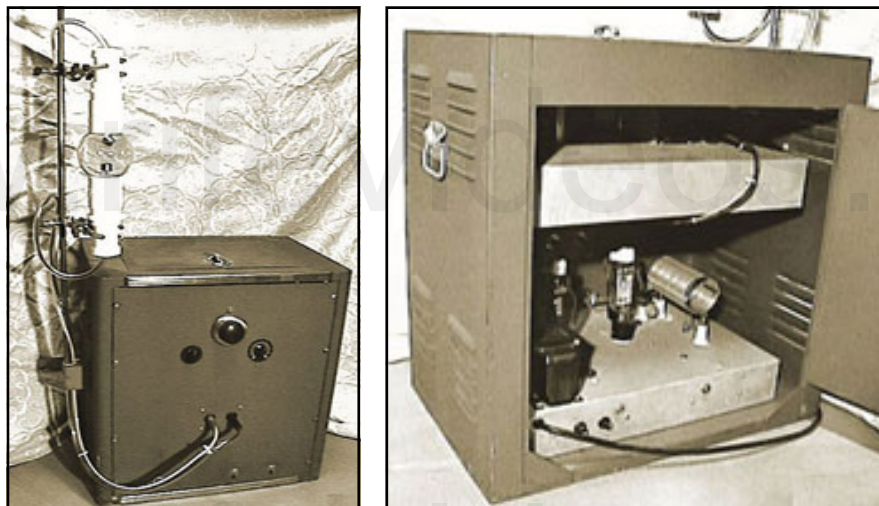

- 1) Used a ray tube.
- 2) Used a fixed 3.30 MHz carrier frequency.
- 3) Modulated sine wave audio frequencies onto a sine wave carrier frequency.
- 4) Power usage was about 460 watts. Output to the ray tube about 50 watts.

[Aubrey Scoon's 1940's Beam Rays Clinical replica instrument](#) was originally mistaken for a genuine 1938-1939 Beam Rays instrument built by Philip Hoyland and the Beam Rays Corporation. We now know that it was not an original Beam Rays instrument but is a replica of it. It was originally for sale on www.rife.org John Bedini and a group of men who had worked with John Crane for a year and a half considered purchasing it. After careful examination they found that this instrument was not a genuine Beam Rays instrument but in fact was built in the early 1940's (about 1942) by Verne Thompson. Verne Thompson eventually replaced Philip Hoyland as Dr. Rife's new engineer.

For a better understanding of this instrument we need to give the history of it. Aubrey Scoon and a group of men from England purchased the above instrument believing it was an original Beam Rays instrument. The original Beam Rays Clinical instrument was known to be working on harmonics. Without really knowing it, they purchased a replica of the Beam Rays Clinical instrument! At that time no original instrument had been located. Because of this and the fact that we had no absolute concrete evidence that Philip Hoyland built this style of audio frequency instrument it was not accepted as a genuine Rife instrument. Not even the 1950s AZ-58 replica was accepted either.

A few years ago I was communicating with Aubrey Scoon about this instrument. In the course of our communications he told me that he had used the wrong main output tube in the instrument when they worked on it. Because they had used the wrong tube the instrument had a lot of harmonics in the carrier frequency. He said that when they discovered this mistake they put the proper tube (809) in and most of harmonics were gone. Aubrey Scoon mentions the change of this tube (809) on his web site. All of the photos of the waveforms on his web site are of an instrument that is malfunctioning. This was a simple mistake, that anyone could make, but it led to a great deal of confusion causing many to believe, including myself, that this instrument was an original Beam Rays instrument.

Both Jim Berger and I separately built Aubrey Scoon's instrument with the correct tubes and found using an oscilloscope that the RF output was clean of the harmonics from the malfunctioning circuit. This confirmed to us what Aubrey had said about using the proper tube. It also showed that it didn't have the reported harmonics which the genuine Beam Rays instrument was supposed to have. Little did we know, at that time, that the harmonic concept we were looking for was there but we didn't really understand how the instrument was supposed to work. This convinced both Jim Berger and myself that Aubrey Scoon's instrument was not a genuine Beam Rays instrument. Nevertheless, this mistake does not change the fact that we now know that this instrument is a Beam Rays Clinical instrument replica. The original Beam Rays Clinical instrument that we obtained did not have any frequency

list that came with it showing what band or dial settings should be used for the various microorganisms. Aubrey Scoon's Beam Rays replica instrument built by Verne Thompson came with a list of frequencies for the various organisms. Verne Thompson may have been the one who would have written down these audio frequencies. Since I updated this paper on 9/20/2010 I decided to test a 3.30 MHz carrier frequency believing that it would have been the correct carrier frequency. When Aubrey Scoon tested the instrument, he listed 3.33 MHz as the RF carrier frequency on his website. Knowing how parasitic oscillations in a carrier frequency could easily have shifted the carrier frequency 30,000 hertz, I thought that a 3.30 MHz carrier frequency would have been a more logical frequency to use.

Our original Beam Rays Clinical instrument, along with Aubrey Scoon's Beam Rays replica instrument, predates John Crane and John Marsh and shows that the audio frequencies came from Philip Hoyland. This Aubrey Scoon instrument also shows a connection to the original Beam Rays instrument and the audio frequencies that were used in the 1950's AZ-58. The 1950's AZ-58 Beam Rays replica instrument used almost the same frequencies as Aubrey Scoon's instrument except Rife, Crane and Marsh divided them by 10 and used these lower audio frequencies. We will discuss this later when we look at the AZ-58. The electronic components are almost identical to our original Beam Rays Clinical instrument. It used the same 866 rectifier tubes along with the same 809 vacuum tube.

On the next page is a chart listing Aubrey Scoon's Beam Rays replica sine wave audio frequencies used in this early 1940's instrument with a 3.30 MHz carrier frequency. Testing the 3.30 MHz carrier frequency shows that this was the correct carrier frequency for this instrument because using it in combination with the audio frequencies produced the correct sideband frequencies that hit the Rife Ray #4 harmonic frequencies. Since we know that Philip Hoyland tested this Clinical instrument in the laboratory he would have calculated the exact audio frequencies to hit the M.O.R.s. The Rife ray #4 frequencies could be one quarter of one percent off because this is the best they could do when reading a frequency back in the mid 1930s. But testing in the laboratory with microorganisms would allow Philip Hoyland to get the most accurate frequency for each organism and the best audio frequencies for the correct sidebands.

In order to determine if the audio frequencies could produce the correct M.O.R. frequencies when used with the 3.30 MHz carrier frequency the math was done in reverse order using the audio frequencies to determine the most accurate M.O.R.s through the sideband frequencies. If these harmonic frequencies when divided down were within one quarter of one percent of the Rife Rays #4 original M.O.R.s then we knew that the 3.30 MHz carrier frequency was the correct carrier frequency. This would also prove that the sideband method was the method of producing the M.O.R.s in the Beam Rays Clinical instrument since we could show that two instruments would work this way. Aubrey Scoon's Beam Rays Clinical instrument with its audio frequencies would firmly prove the method. Aubrey Scoon's instrument would also prove that Philip Hoyland used at least two different fixed RF carrier frequencies in the instruments in order to help keep anyone from figuring out the secrets of the instruments. If there is a different carrier frequency then the audio frequencies will be different. Like our Beam Rays Clinical instrument Aubrey Scoon's replica instrument used sine wave waveform for both the RF carrier frequency and the low audio frequencies but the modulated output looks like a square wave as show on the bottom of page 50.

On pages 74 through 81 you will find the spectrum analyzer graphs showing the sideband frequencies for each organism using Aubrey Scoon's Beam Rays replica instrument 3.3 MHz carrier. On page 82 are photos of the Aubrey Scoon instrument that we built. The amplifier is on the PC board and made it so we can use a modern audio oscillator to input the audio frequencies into the instrument .

On page 83 is a schematic of this 1940s instrument. The 866 vacuum tubes have been replaced with solid state rectifiers. Also the old vacuum tube audio oscillator has been removed. It is easier and more accurate to use Aubrey Scoon's booster amplifier and a modern function generator to produce the audio frequencies that were used in this instrument. The layout of the electronic parts of this instrument is also very important because of the inherent interference problems that come with RF oscillators. Again anyone wishing to build this instrument should have a good understanding of old tube technology. Some parts of this circuit use up to 2000 volts DC with substantial current and can easily kill anyone who is not familiar with this kind of current or voltage. We take no responsibility for anyone who builds this instrument. We recommend that you have professional help.

Below is the chart of Aubrey Scoon's Beam Rays Clinical replica instrument. In the "Rife Ray #4 Frequencies In Hertz" column are the correct M.O.R.s found by Dr. Rife. In the "Aubrey Scoon's Sideband Audio Frequencies In Hertz" column are the audio frequencies used to create the correct sideband frequencies to hit the harmonic Rife Ray #4 frequencies. In the "Rife Ray #4 Frequencies Based on Scoon's Audio Frequencies" column we see the M.O.R. frequencies that these audio frequencies produce. You will notice in the "Rife Ray #4 Frequencies In Hertz" column that the frequency for Actinomyces or Streptothrix is 192,000 hertz and in the "Rife Ray #4 Frequencies Based on Scoon's Audio Frequencies" column is the frequency of 191,803 hertz. There is only a 197 hertz difference between these frequencies. If you compare both of these columns you will notice how closely these frequencies match up. All the frequencies which are in the "Rife Ray #4 Frequencies Based On Scoon's Audio Frequencies" column are less than one quarter of one percent off of the "Rife Ray #4 Frequencies In Hertz."

This comparison shows that Aubrey Scoon's Beam Rays Clinical Replica instrument works on the harmonic sideband method to produce the M.O.R.s. Until now we have not had the M.O.R. frequencies for Sarcoma, Pneumonia, Tuberculosis and Worms because those frequencies were lost. Even though there are many harmonics produced in the Beam Rays Clinical instrument which makes it all but impossible to figure out the true M.O.R.s. We now have the ability to produce those frequencies if we use Aubrey Scoon's audio frequencies for these organisms with a 3.30 MHz carrier frequency. So in reality they are not lost because the ability of producing them through the harmonic sideband method used in the Beam Rays Clinical instrument can still be used.

Aubrey Scoon's Sideband Audio Frequencies Reconciled To Rife's Original High Frequency M.O.R.s.							
Microorganism <small>*These frequencies were not included in Aubrey Scoon's instrument.</small>	Rife Ray #4 Frequencies In Hertz	Higher Rife Ray #4 Harmonic Frequencies In Hertz	Aubrey Scoon's Sideband Audio Frequencies In Hertz	Higher Rife Ray #4 Harmonic Frequencies in Hertz Based On Scoon's Audio Frequency and 3.3 MHz Carrier	*Carrier Difference Frequency	Number of Sideband Harmonics	Rife Ray #4 Frequencies Based On Scoon's Audio Frequencies
Actinomyces or Streptothrix	192,000 Hz	3,264,000 or 17th	7,870 Hz	3,260,650 or 17th	39,350 Hz	5	191,803 Hz
Anthrax	139,200 Hz	3,340,800 or 24th	*10,200 Hz	3,340,800 or 24th	40,800 Hz	4	139,200 Hz
B or E Coli Rod	417,000 Hz	3,336,000 or 8th	8,020 Hz	3,332,080 or 8th	32,080 Hz	4	416,510 Hz
B or E Coli Virus	770,000 Hz	3,080,000 or 4th	17,220 Hz	3,076,140 or 4th	223,860 Hz	13	769,035 Hz
BX Virus Carcinoma	1,604,000 Hz	3,208,000 or 2nd	21,275 Hz	3,214,900 or 2nd	85,100 Hz	4	1,607,450 Hz
BY Sarcoma	?1,530,000 Hz	3,059,040 or 2nd	20,080 Hz	3,059,040 or 2nd	240,960 Hz	12	1,529,520 Hz
Gonorrhea	233,000 Hz	3,262,000 or 14th	*9,500 Hz	3,262,000 or 14th	38,000 Hz	4	233,000 Hz
Pneumonia or Spinal Meningitis	427,000 Hz	3,416,000 or 8th	7,660 Hz	3,414,900 or 8th	114,900 Hz	15	426,862 Hz
Staphylococcus Pyogenes Aureus	478,000 Hz	3,346,000 or 7th	7,270 Hz	3,343,620 or 7th	43,620 Hz	6	477,660 Hz
Streptococcus Pyogenes	720,000 Hz	3,600,000 or 5th	8,450 Hz	3,595,750 or 5th	295,750 Hz	35	719,150 Hz
Syphilis	789,000 Hz	3,156,000 or 4th	6,600 Hz	3,154,800 or 4th	145,200 Hz	22	788,700 Hz
Tetanus	234,000 Hz	3,276,000 or 14th	1,200 Hz	3,276,000 or 14th	24,000 Hz	20	234,000 Hz
Tuberculosis Rod	369,000 Hz	3,321,000 or 9th	8,300 Hz	3,324,900 or 9th	24,900 Hz	3	369,433 Hz
Tuberculosis Virus	?769,000 Hz	3,076,000 or 4th	16,000 Hz	3,076,000 or 4th	224,000 Hz	14	769,000 Hz
Typhoid Rod	760,000 Hz	3,040,000 or 4th	6,900 Hz	3,037,800 or 4th	262,200 Hz	38	759,450 Hz
Typhoid Virus	1,445,000 Hz	2,890,000 or 2nd	18,620 Hz	2,890,360 or 2nd	409,640 Hz	22	1,445,180 Hz
Worms	?		2,400 Hz				

Rife Ray #4 192,000 Hertz for Actinomy-
cosis or Streptothrix. The 17th Higher
harmonic frequency is 3,264,000 Hertz.
Scoon's audio frequency used for the
proper sideband spacing is 7,870 Hertz.
The 5th lower sideband hit the M.O.R
within 1/8 of 1%.

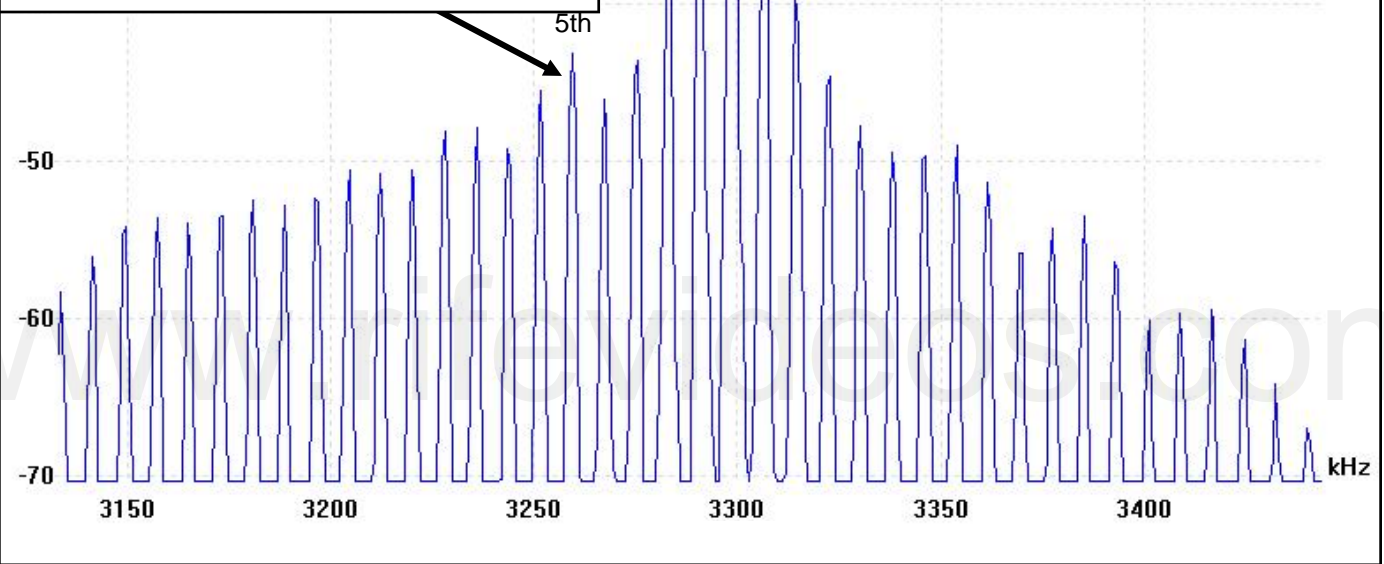

Scoon's Beam Rays Clinical replica instrument 3.3 Megahertz spectrum analysis of sideband harmonic frequencies.

Rife Ray #4 139,200 Hertz for Anthrax.
The 24th Higher harmonic frequency is
3,340,800 Hertz. The audio frequency
which could be used for the proper side-
band spacing is *10,200 Hertz. The 4th
upper sideband would hit the M.O.R.

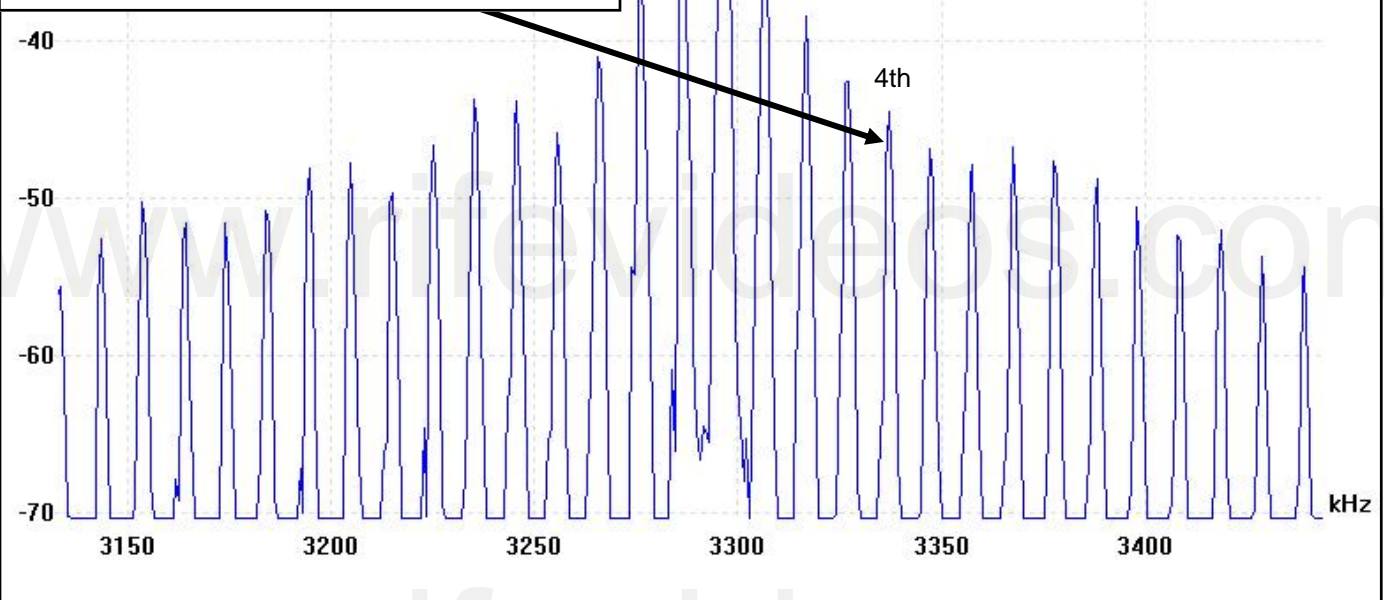

Scoon's Beam Rays Clinical replica instrument 3.3 Megahertz spectrum analysis of sideband harmonic frequencies.

Rife Ray #4 417,000 Hertz for B or E Coli Rod. The 8th Higher harmonic frequency is 3,336,000 Hertz. Scoon's audio frequency used for the proper sideband spacing is 8,020 Hertz. The 4th upper sideband hit the M.O.R within 1/8 of 1%.

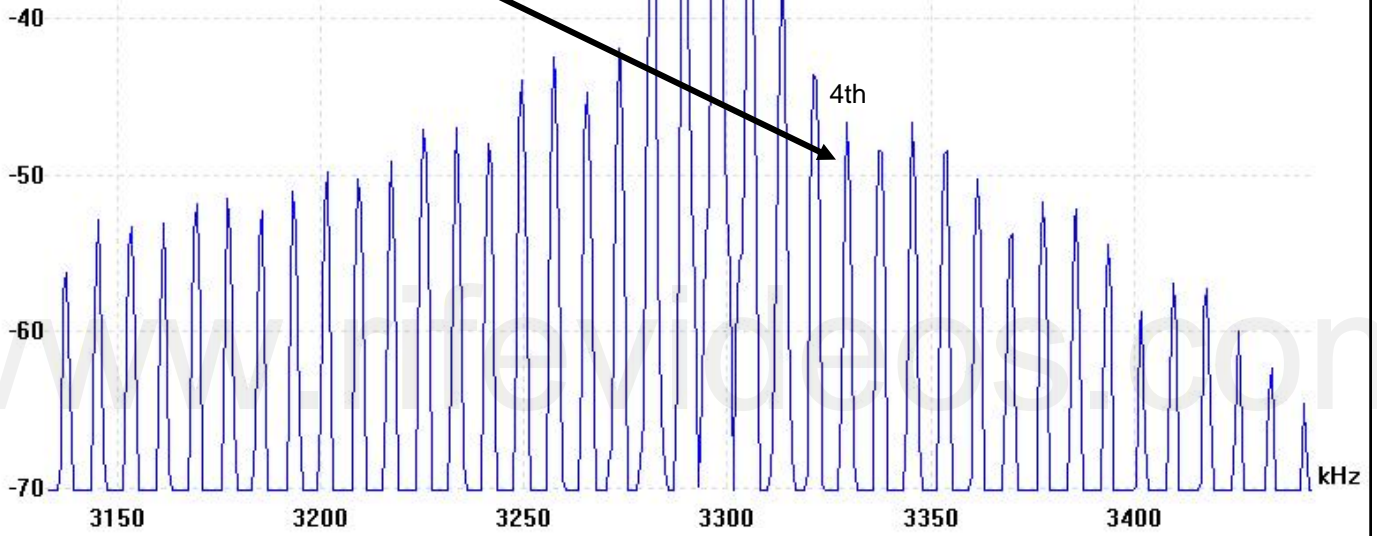

Scoon's Beam Rays Clinical replica instrument 3.3 Megahertz spectrum analysis of sideband harmonic frequencies.

Rife Ray #4 770,000 Hertz for B or E Coli Virus. The 4th Higher harmonic frequency is 3,080,000 Hertz. Scoon's audio frequency used for the proper sideband spacing is 17,220 Hertz. The 13th lower sideband hit the M.O.R Within 1/8 of 1%.

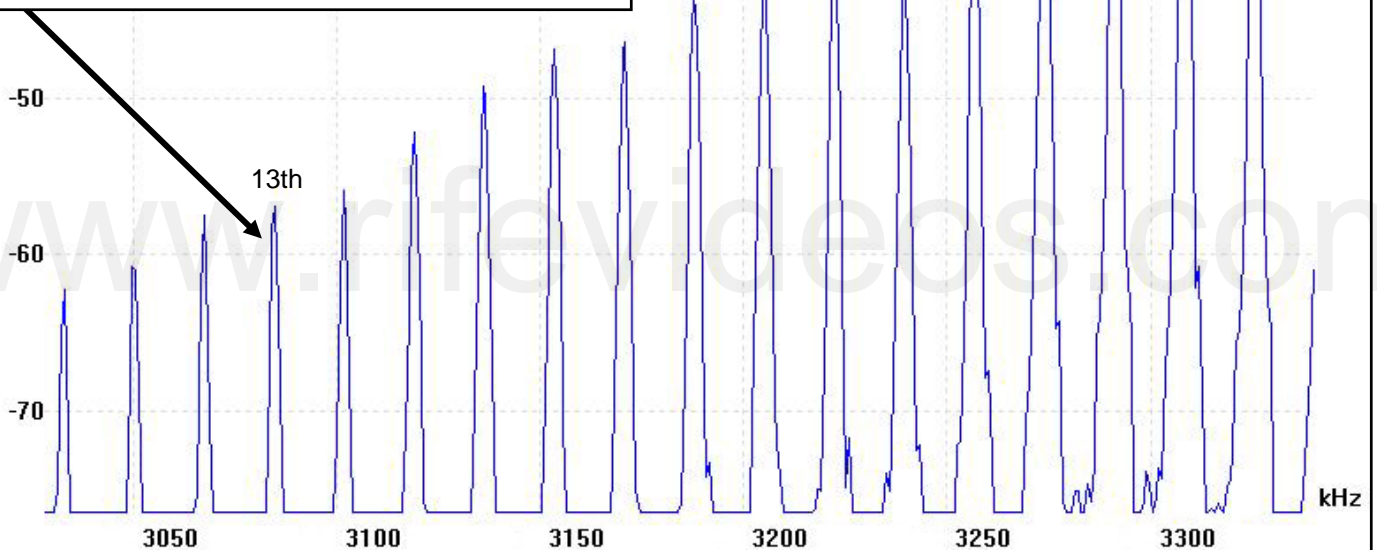

Scoon's Beam Rays Clinical replica instrument 3.3 Megahertz spectrum analysis of sideband harmonic frequencies.

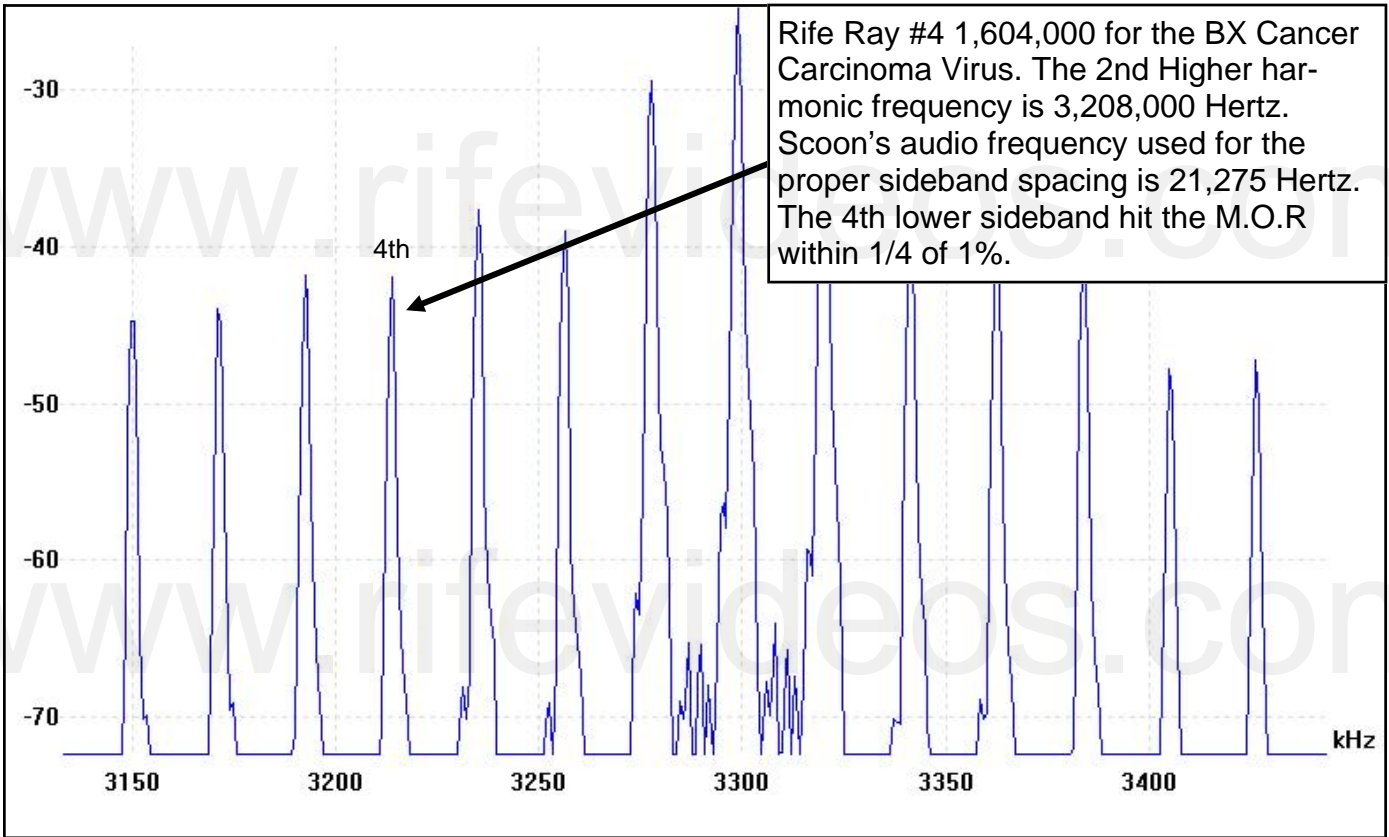

Scoon's Beam Rays Clinical replica instrument 3.3 Megahertz spectrum analysis of sideband harmonic frequencies.

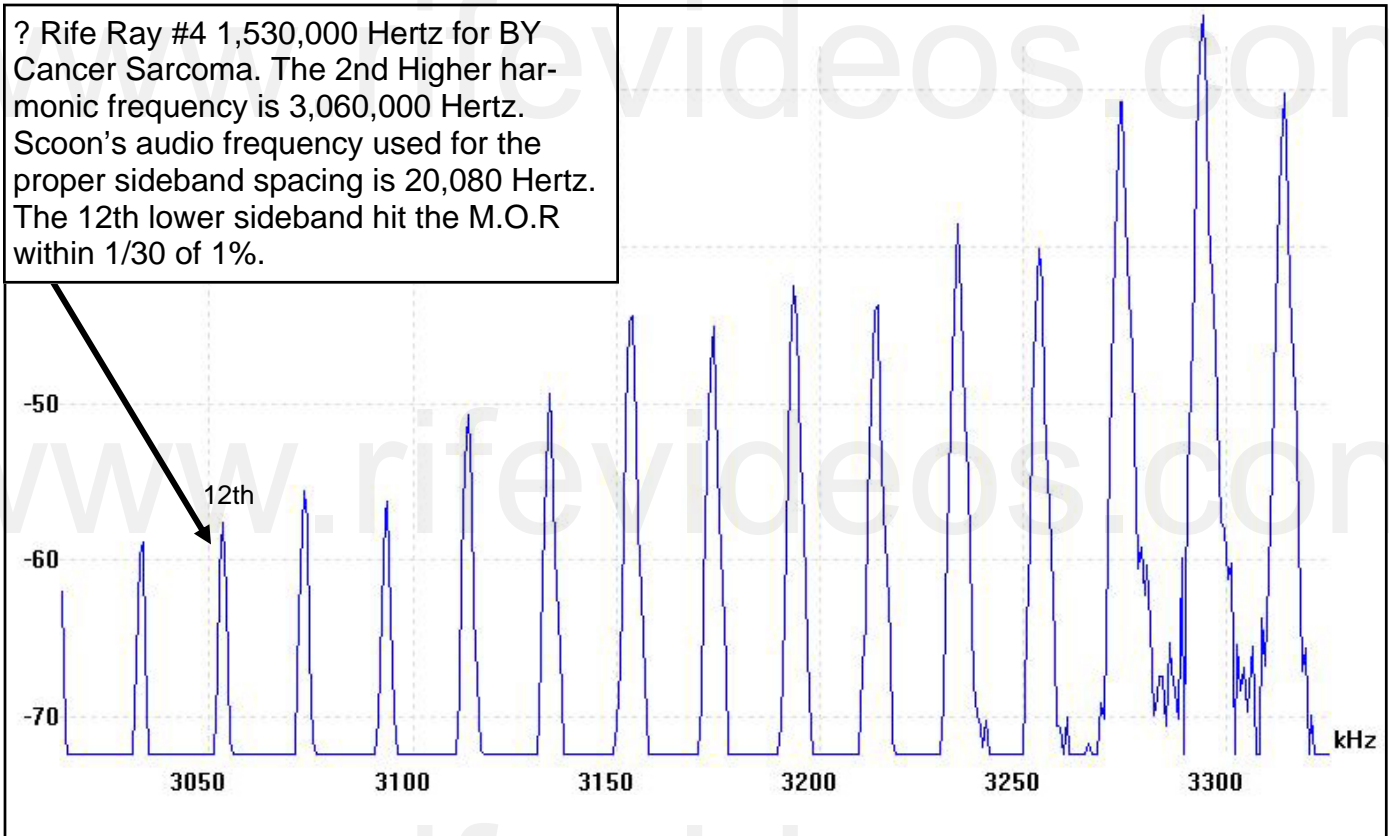

Scoon's Beam Rays Clinical replica instrument 3.3 Megahertz spectrum analysis of sideband harmonic frequencies.

Rife Ray #4 233,000 Hertz for Gonorrhoea. The 14th Higher harmonic frequency is 3,262,000 Hertz. Audio frequency which could be used for the proper sideband spacing is *9,500 Hertz. The 4th lower sideband would hit the M.O.R.

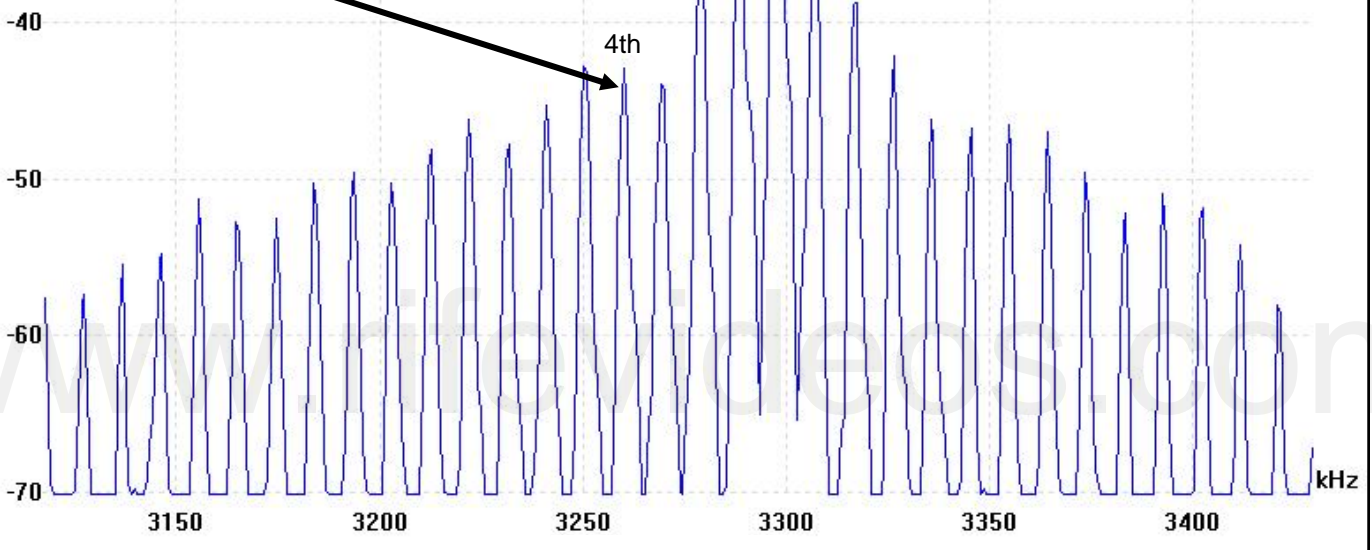

Scoon's Beam Rays Clinical replica instrument 3.3 Megahertz spectrum analysis of sideband harmonic frequencies.

Rife Ray #4 427,000 Hertz for Spinal Meningitis. The 8th Higher harmonic frequency is 3,416,000 Hertz. Scoon's audio frequency used for the proper sideband spacing is 7,660 Hertz. The 15th upper sideband hit the M.O.R within 1/30 of 1%.

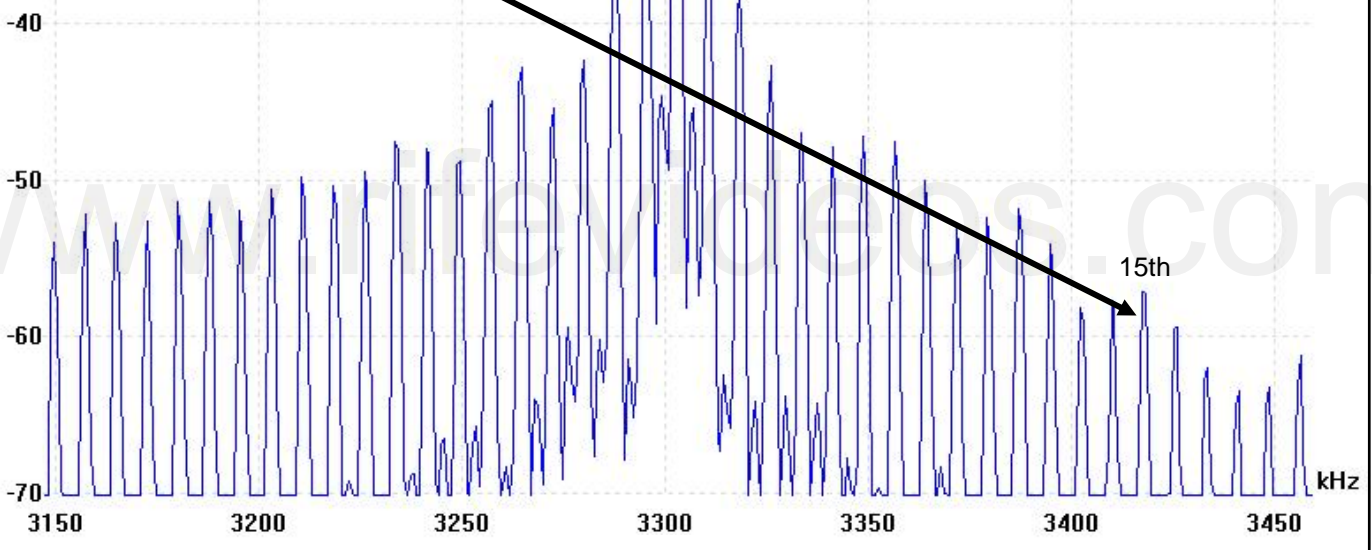

Scoon's Beam Rays Clinical replica instrument 3.3 Megahertz spectrum analysis of sideband harmonic frequencies.

Rife Ray #4 478,000 Hertz for Staphylococcus Pyogenes Aureus. The 7th Higher harmonic frequency is 3,346,000 Hertz. Scoon's audio frequency used for the proper sideband spacing is 7,270 Hertz. The 6th upper sideband hit the M.O.R within 1/14 of 1%.

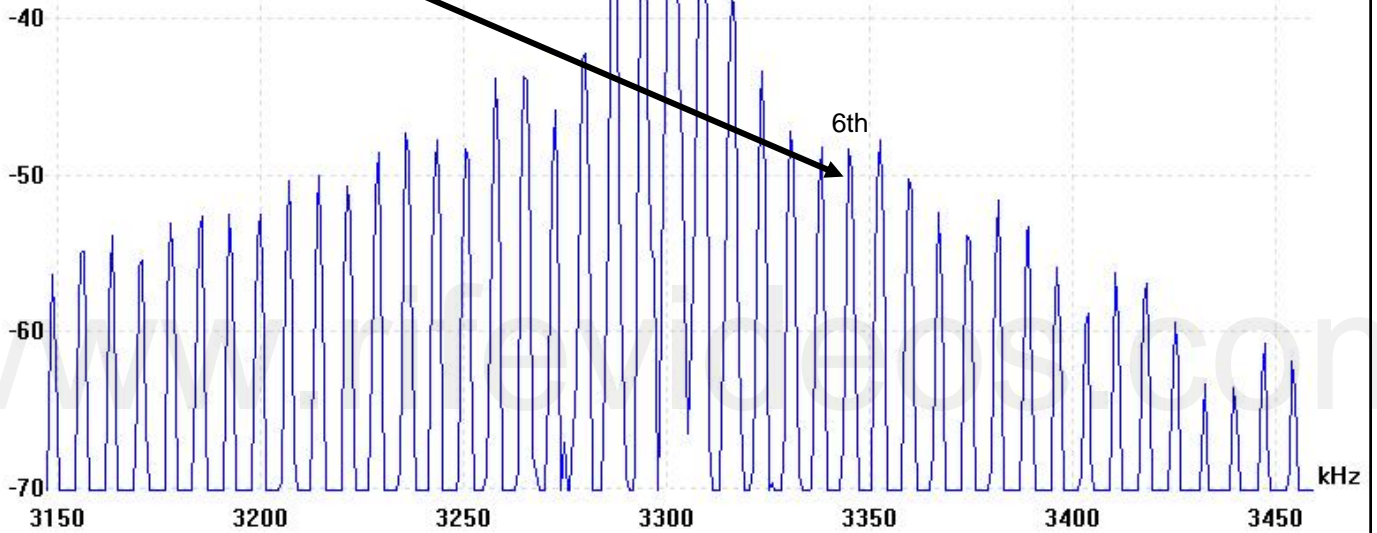

Scoon's Beam Rays Clinical replica instrument 3.3 Megahertz spectrum analysis of sideband harmonic frequencies.

Rife Ray #4 720,000 Hertz for Streptococcus Pyogenes. The 5th Higher harmonic frequency 3,600,000 Hertz. Scoon's audio frequency used for the proper sideband spacing is 8,450 Hertz. The 35th upper sideband hit the M.O.R within 1/8 of 1%.

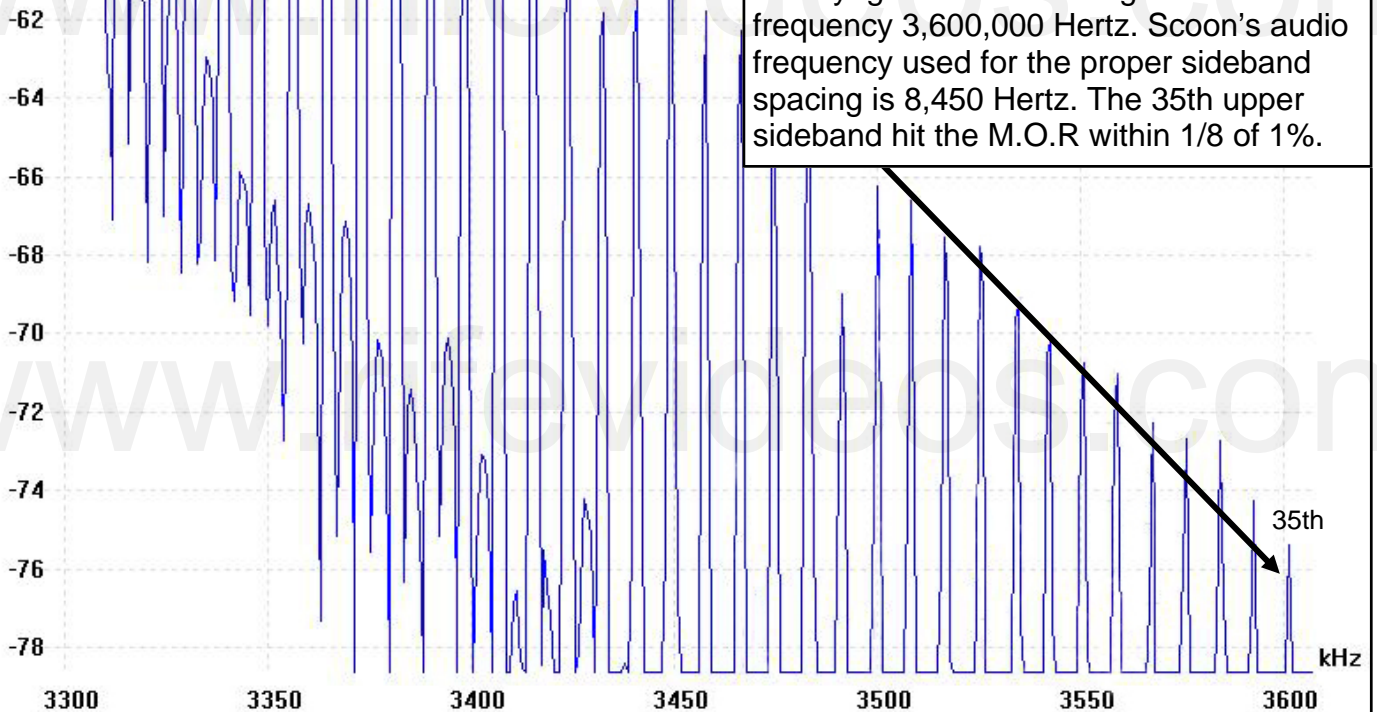

Scoon's Beam Rays Clinical replica instrument 3.3 Megahertz spectrum analysis of sideband harmonic frequencies.

Rife Ray #4 789,000 Hertz for Syphilis.
 The 4th Higher harmonic frequency is
 3,156,000 Hertz. Scoon's audio frequency
 used for the proper sideband spacing is
 6,600 Hertz. The 22nd lower sideband hit
 the M.O.R within 1/26 of 1%.

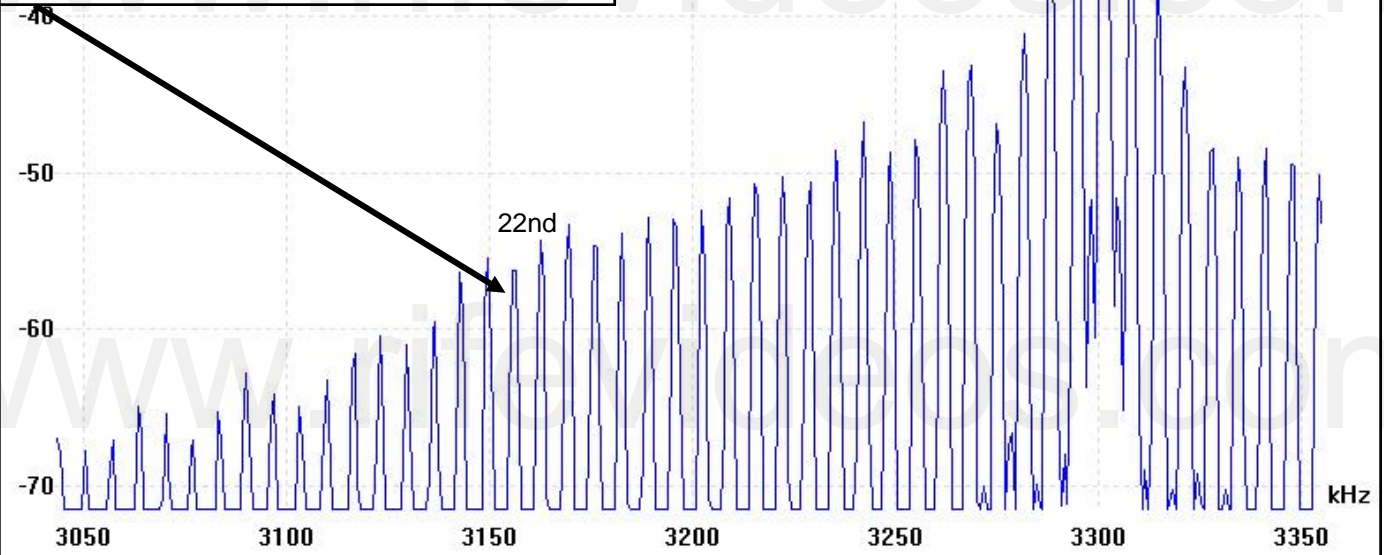

Scoon's Beam Rays Clinical replica instrument 3.3 Megahertz spectrum analysis of sideband harmonic frequencies.

Rife Ray #4 234,000 Hertz for Tetanus.
 The 14th Higher harmonic frequency is
 3,276,000 Hertz. Scoon's audio frequency
 used for the proper sideband spacing is
 1,200 Hertz. The 20th lower sideband hit
 the M.O.R exactly.

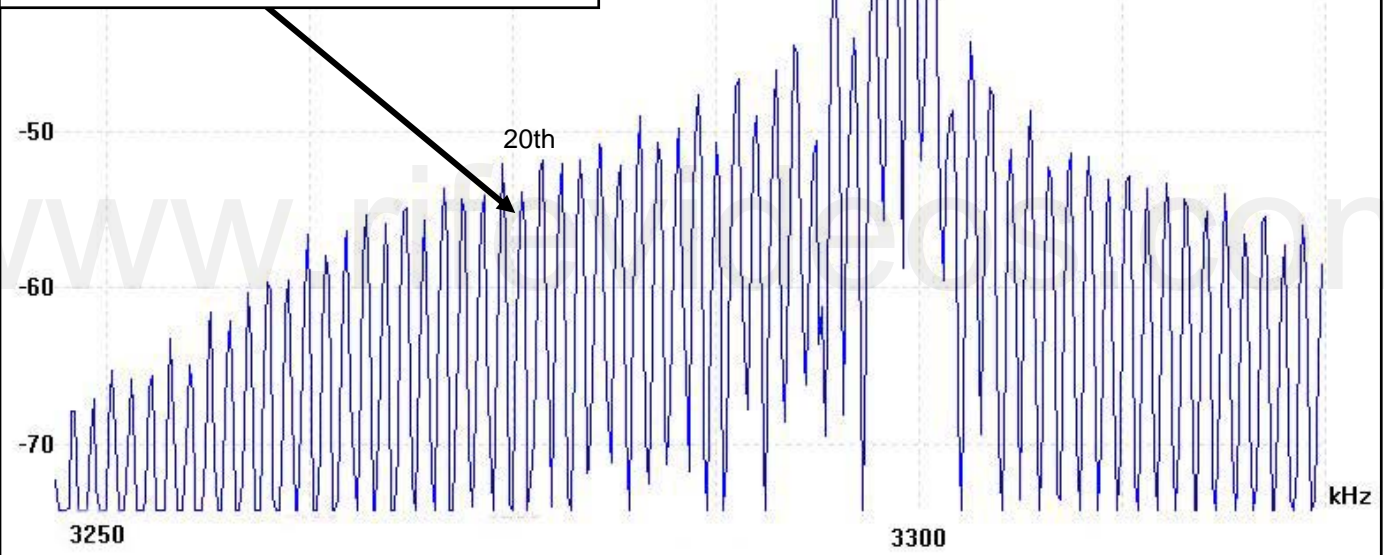

Scoon's Beam Rays Clinical replica instrument 3.3 Megahertz spectrum analysis of sideband harmonic frequencies.

Rife Ray #4 369,000 Hertz for Tuberculosis Rod. The 9th Higher harmonic frequency is 3,321,000 Hertz. Scoon's audio frequency used for the proper sideband spacing is 8,300 Hertz. The 3rd upper sideband hit the M.O.R within 1/8 of 1%.

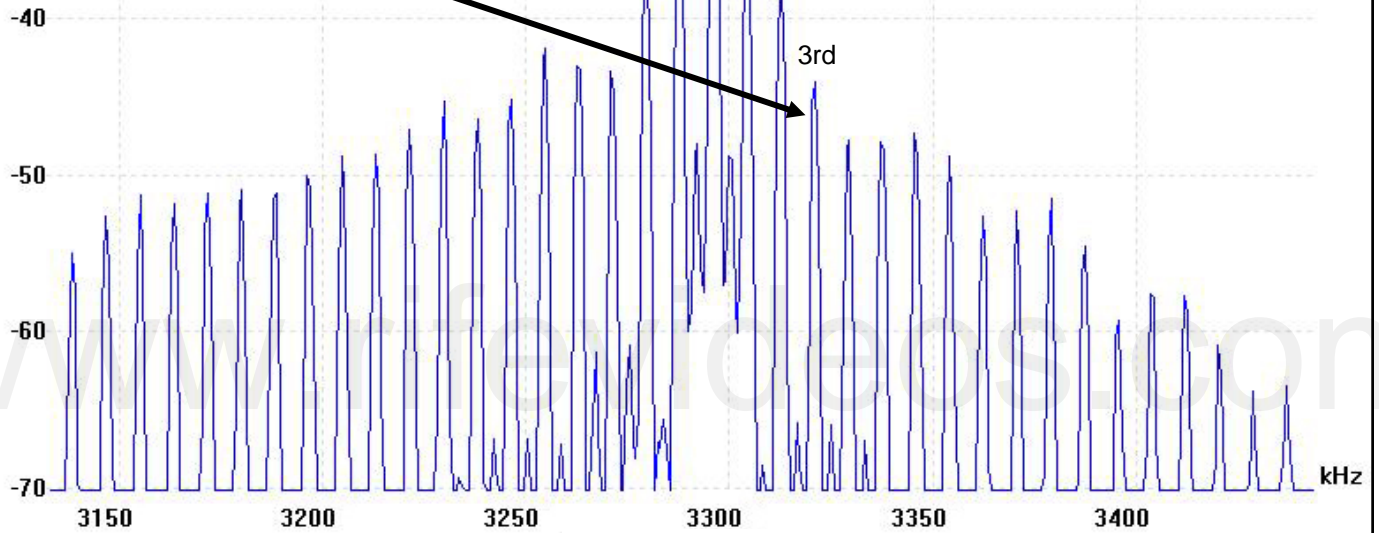

Scoon's Beam Rays Clinical replica instrument 3.3 Megahertz spectrum analysis of sideband harmonic frequencies.

? Rife Ray #4 769,000 Hertz for Tuberculosis Virus. The 4th Higher harmonic frequency is 3,076,000 Hertz. Scoon's audio frequency used for the proper sideband spacing is 16,000 Hertz. The 14th lower sideband hit the M.O.R exactly.

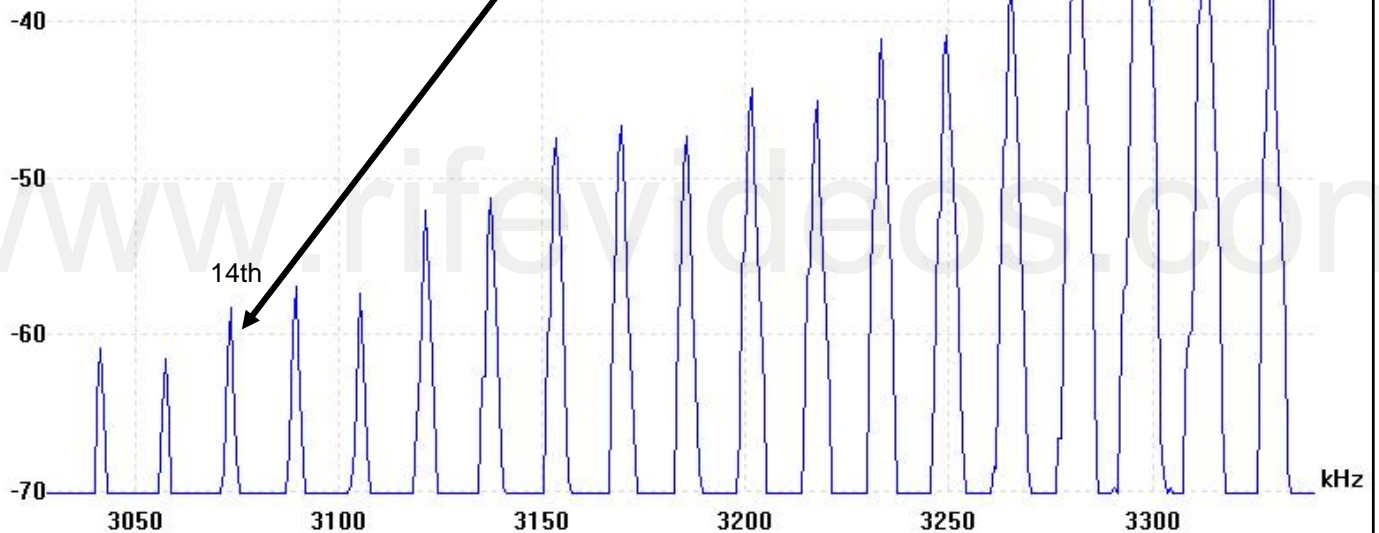

Scoon's Beam Rays Clinical instrument 3.3 Megahertz spectrum analysis of sideband harmonic frequencies.

Rife Ray #4 760,000 Hertz for Typhoid Rod. The 4th Higher harmonic frequency is 3,040,000 Hertz. Scoon's audio frequency used for the proper sideband spacing is 6,900 Hertz. The 38th lower sideband hit the M.O.R within 1/11 of 1%.

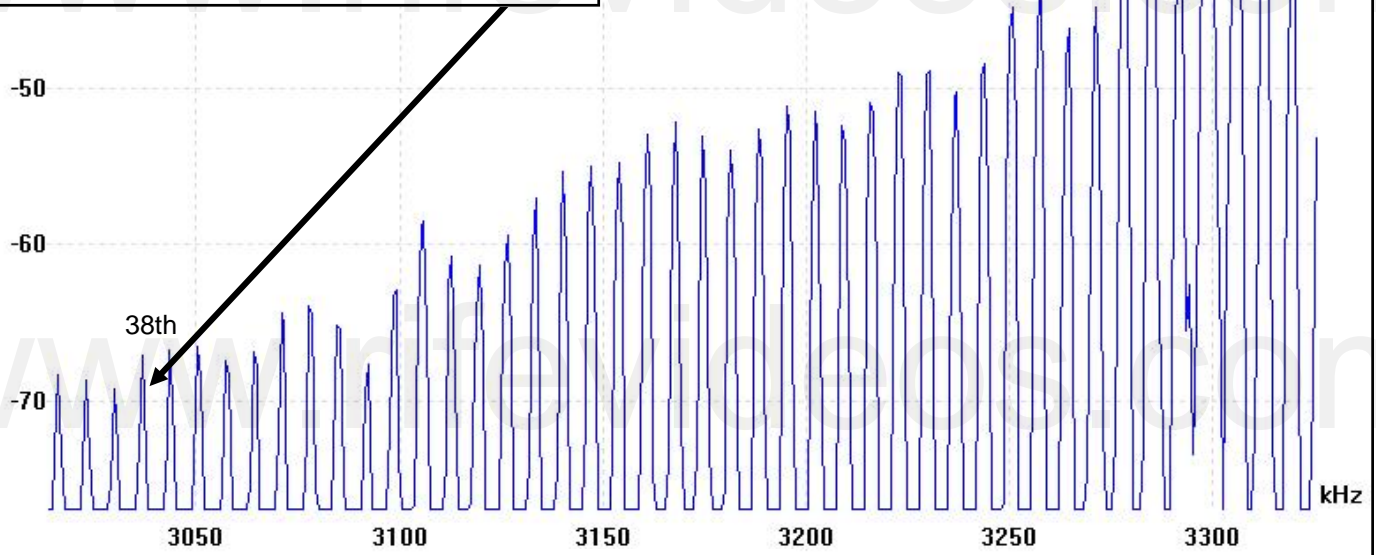

Scoon's Beam Rays Clinical replica instrument 3.3 Megahertz spectrum analysis of sideband harmonic frequencies.

Rife Ray #4 1,445,000 Hertz for Typhoid Virus. The 2nd Higher harmonic frequency is 2,890,000 Hertz. Scoon's audio frequency used for the proper sideband spacing is 16,620 Hertz. The 22nd lower sideband hit the M.O.R within 1/80 of 1%.

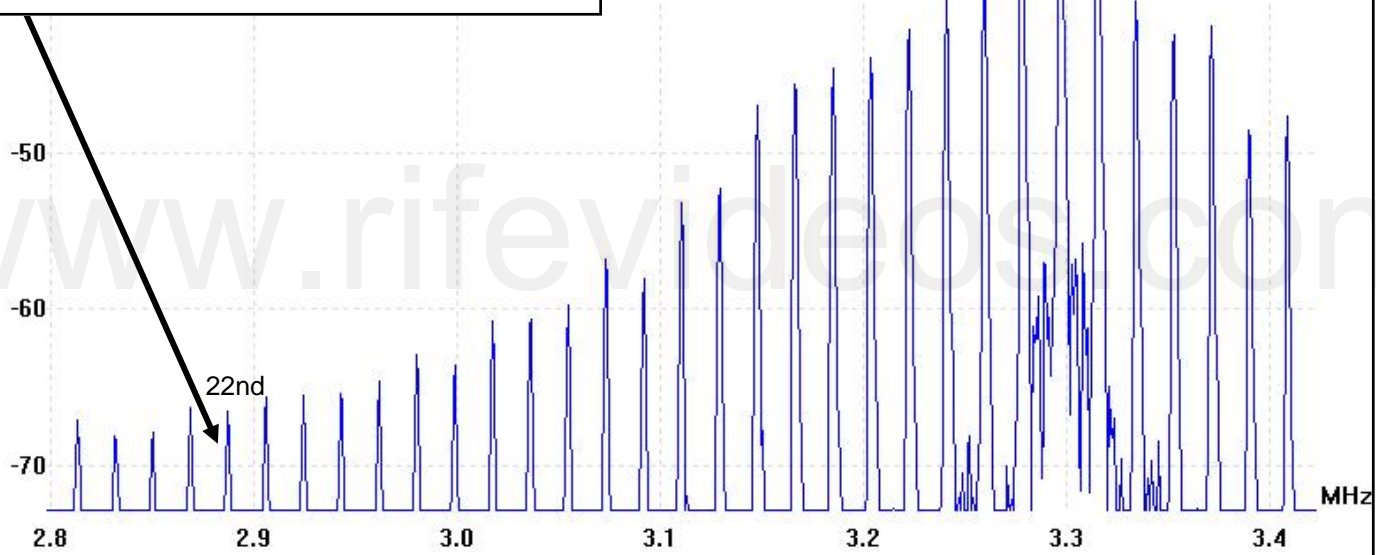

Scoon's Hoyland's Beam Rays Clinical replica instrument 3.3 Megahertz spectrum analysis of sideband harmonic

Photos of the rebuilt Aubrey Scoon Beam Rays Clinical instrument

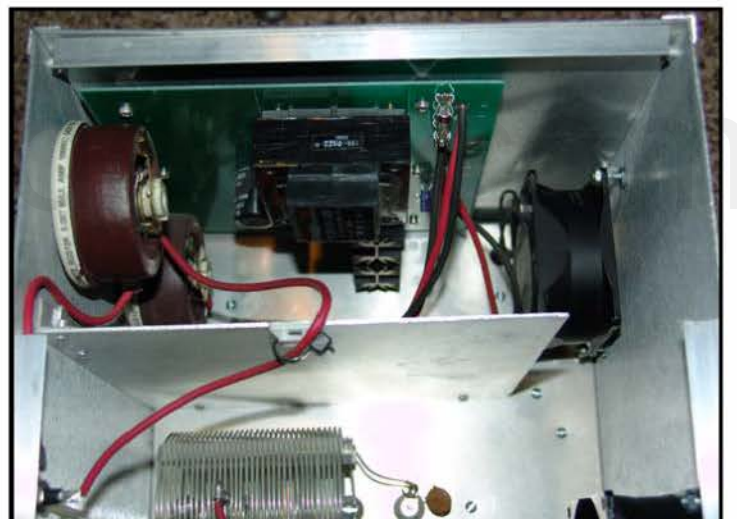
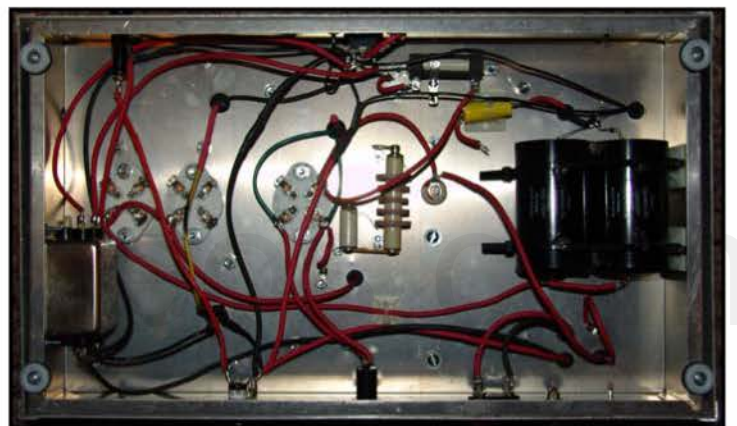

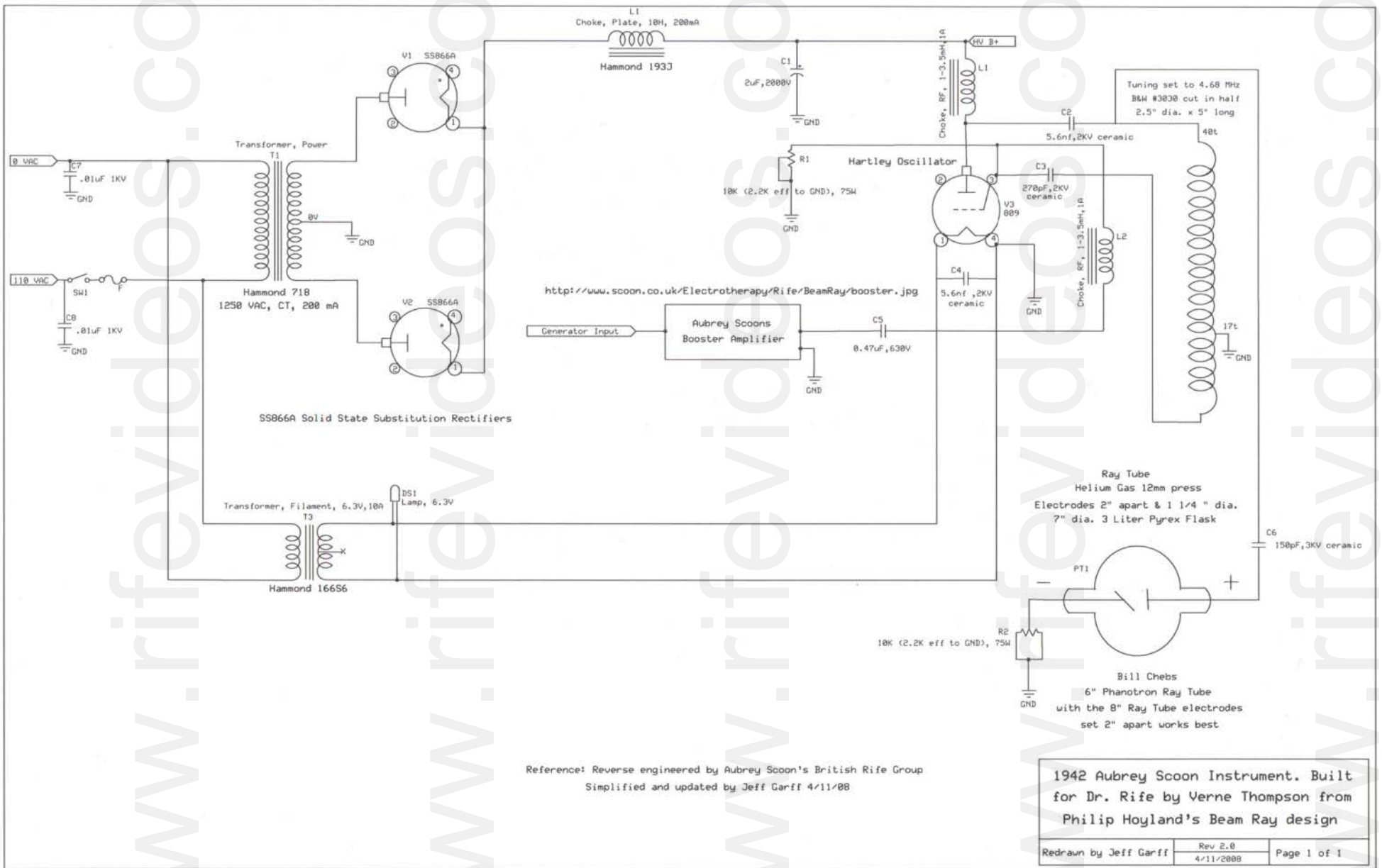

Dr. Rife and Verne Thompson's 1950's AZ-58 Beam Rays Replica instrument

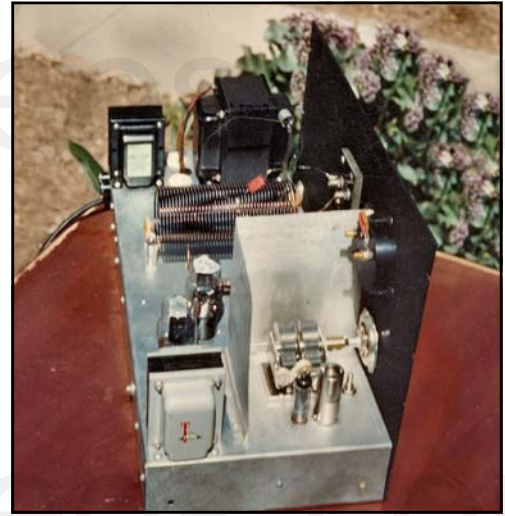
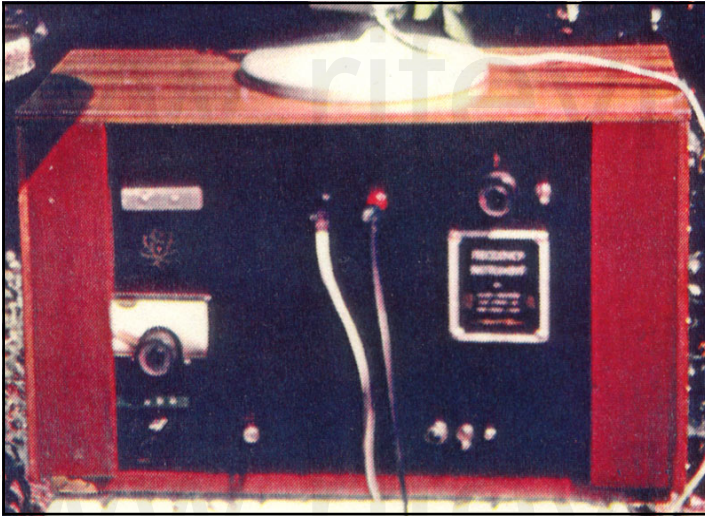

- 1) Used a ray tube.
- 2) Could change between 2.2 and 5 MHz sine wave carrier frequency (First used 4.68 carrier).
- 3) Modulated square wave audio frequencies onto the sine wave carrier frequency.
- 4) Power usage was about 460 watts. Output to the ray tube about 40 or 50 watts.

With the knowledge of the Beam Rays Clinical instrument we know that the 1950's AZ-58 design is just an updated replica with newer component parts. Dr. Rife's engineer, Verne Thompson had been building this type of instrument during the 1940's and 1950s. We will now cover this information in more depth. This style of instrument worked well as long as it was built properly using the sideband method. From the stress of the Beam Rays trial, Dr. Rife became an alcoholic and all that he had worked so hard to accomplish was almost destroyed. Many of the doctors had returned their instruments because of AMA threats. Some of these returned Beam Rays Clinical instruments Dr. Rife parted out and sold to anyone who wanted radio parts. Under these circumstances Beam Rays Corporation eventually closed its doors. Verne Thompson became Dr. Rife's engineer around 1940 and built the Beam Ray style Clinical instruments during the 1940's and 1950's for anyone who wanted an instrument. The documents show that Dr. Rife wanted to go back to the original principles of his instrument rather than use Philip Hoyland's harmonic Beam Ray Clinical design. Below is what Dr. Rife said in a 1939 letter sent to Dr. Gonin:

RIFE: *"I spoke only Friday evening to a Mr. John Chamblin, a radio man now connected with Beam Rays Inc., about the redesign and building of a device according to the old Rife Ray principles; as the present instrument has been so deviated away from that old principle that it is nowhere near the same...those devices which you have are merely working on a harmonic and not a true frequency; and in our research on electronics, we definitely know that there is no possible way of controlling electrical harmonics of a frequency."* ([Letter from Dr. Rife to Dr. Gonin, May 14, 1939. Page 1 of 3](#))

It is apparent that Dr. Rife wanted to go back to the original designs of his instrument. It is also a historical fact that he never did go back to using his original designs like the Rife Ray #4. There is a reasonable explanation for this. Back in the late 1930's and early 1940's the FCC began policing the airwaves and hundreds of new radio stations were being granted licenses. The RF M.O.R. frequencies which were output by the Kennedy equipment, Rife Ray #4 and Beam Rays Laboratory instrument were almost all in the A.M. radio band of frequencies and would interfere with these new broadcasting stations. These events probably brought about the continued use of Philip Hoyland's Beam Rays Clinical instrument.

There is one important fact I think should be said at this point. Dr. Rife at any time could have had an original Beam Rays instrument built. He had a Rife Ray #4 in his lab that could have been copied. I am sure that he also had access to the Beam Rays Laboratory instrument. These facts, I believe show that it was probably because of FCC regulations Dr. Rife either had to use the Beam Rays Clinical design instrument or no longer build one. This instrument with its fixed carrier frequency of 3.8 MHz was well above the A.M. band of radio stations. Since the Beam Rays Clinical instrument used the higher harmonics of the original Rife Ray #4 frequencies this would not cause any problems with the A.M. radio stations. The FCC was, at the least, a contributing factor in why Dr. Rife continued to use the Beam Rays Clinical design.

With the understanding of this information let us continue on with the history of Dr. Rife's instruments. John Crane met Dr. Rife in 1950 when he inquired about purchasing a drafting set that Dr. Rife was selling. John Marsh met John Crane in 1952 when they were both working at Convair. They both went to see Dr. Rife in 1953 to see if Dr. Rife would be willing to help with the cancer of John Marsh's wife. In Dr. Rife's [1961 deposition #123-125](#) he said he gave John Crane his frequencies in 1950:

COMPARET: *"Did you ever explain to John F. Crane, one of the defendants in this case, the principles upon which your electronic frequency-generator is used in the treatment of diseases?"*

RIFE: *"Yes in 1950."*

COMPARET: *"Did you also inform him of the particular frequencies which you had found to be effective in the treatment of various diseases?"*

RIFE: *"Yes. Verne Thompson and I gave the frequencies to John Crane."*

COMPARET: *"When did you furnish him with this information?"*

RIFE: *"In 1950."*

Dr. Rife always said that almost all his frequencies were in the upper bands so we know that he gave these high RF frequencies to John Crane in 1950. These frequencies would have been the frequencies used in the Rife Ray #4. The audio frequencies used in one of the Beam Rays Clinical instrument were probably also given to John Crane at this time. There is an interesting correlation of these audio frequencies that needs to be mentioned at this time. The audio frequencies used in the early 1940's Aubrey Scoon, Verne Thompson instrument, which gave the sideband spacing, were about 10 times higher than those used in the Verne Thompson 1950's AZ-58 Beam Rays replica. It is apparent that these higher audio frequencies were lowered in the 1950's by Dr. Rife, John Crane and John Marsh and were used in the AZ-58 replica instrument. This gives us the knowledge that these audio frequencies came from Verne Thompson's reading of one of these Beam Rays Clinical instruments.

The original Beam Rays Clinical instrument we have has an RF carrier frequency of 3.80 MHz. Aubrey Scoon's Beam Rays Clinical replica instrument's RF carrier frequency is 3.30 MHz. The audio frequencies Aubrey Scoon's instrument used, we showed earlier in this article, will not work with the original Beam Rays Clinical instrument that we have. The AZ-58's RF carrier frequency was set at 4.68 MHz as per the schematic and Aubrey Scoon's instruments audio frequencies will not produce the correct sideband spacing with this 4.68 MHz carrier frequency either. This information showed us that Philip Hoyland was using different carrier frequencies in the Beam Rays instrument. It also indicates that both Rife and Verne Thompson did not understand the importance of using the correct carrier frequency with the correct audio frequencies.

John Crane said in "The Crane Report" *"The instruments were completed by Crane and Thompson in 1953, but the test results were negative."* With the carrier frequency set at 4.68 MHz the audio frequencies they used would not make the correct sideband spacing and the instrument wouldn't have worked like they expected. Logically they would have first tried the higher audio frequencies with a

sine wave waveform like the original Beam Rays Clinical instrument. Apparently when this didn't work they lowered the audio frequencies by a factor of 10 and changed them from sine wave to a square wave waveform. This appears to be the first time square wave was used. This change from sine wave to square wave wasn't really necessary since the circuit design will create a square wave looking wave form out of a sine wave anyway (see pages 43 & 50 for this waveform). John Crane said this is when the instruments started to work better. It is ironic that they had to use a square wave that produces harmonics in order to get the instrument to even begin to give them any results. Had they really understood how the audio frequencies interacted with the carrier frequency they would have recalculated the audio frequencies to work with the new 4.68 MHz carrier frequency and the square wave change would not have been necessary.

This change from sine wave to square wave also created a whole new methodology of using frequencies. Instead of relying on the interaction of the sine wave audio frequency and the sine wave RF carrier frequency to produce the correct sideband harmonic M.O.R. to devitalize the organisms they were now depending only on the harmonics from the square wave waveform to hit the correct M.O.R. frequency. This change also shows that they didn't understand how the Beam Rays Clinical instrument worked. Another thing that shows that they did not understand how the Beam Rays instrument worked is the fact that they didn't recalculate the audio frequencies to properly use the square wave harmonics to hit the high frequency M.O.R.s. This shows that they believed that the audio frequencies were the M.O.R.s of the organisms. In many of the documents we find that both John Crane and John Marsh firmly believed that the audio frequencies were the M.O.R. frequencies that would devitalize the organisms. Even Dr. Rife appears to have believed that the audio frequencies were the M.O.R.s as long as they were used with Philip Hoyland's Beam Rays Clinical design. In Dr. Rife's original equipment like the Rife Ray #4 and the Kennedy equipment he knew that the M.O.R. frequencies were the high RF frequencies. But since Dr. Rife didn't really understand exactly how Philip Hoyland's instrument worked it appears that he accepted the concept that the audio frequencies were the M.O.R.s as long as they were used with that style of instrument. Without understanding these facts it is hard to understand the rest of the history of Dr. Rife's instruments. The fact that they believed that the audio frequencies were the M.O.R.s compromised the effectiveness of the AZ-58 Beam Rays Clinical replica.

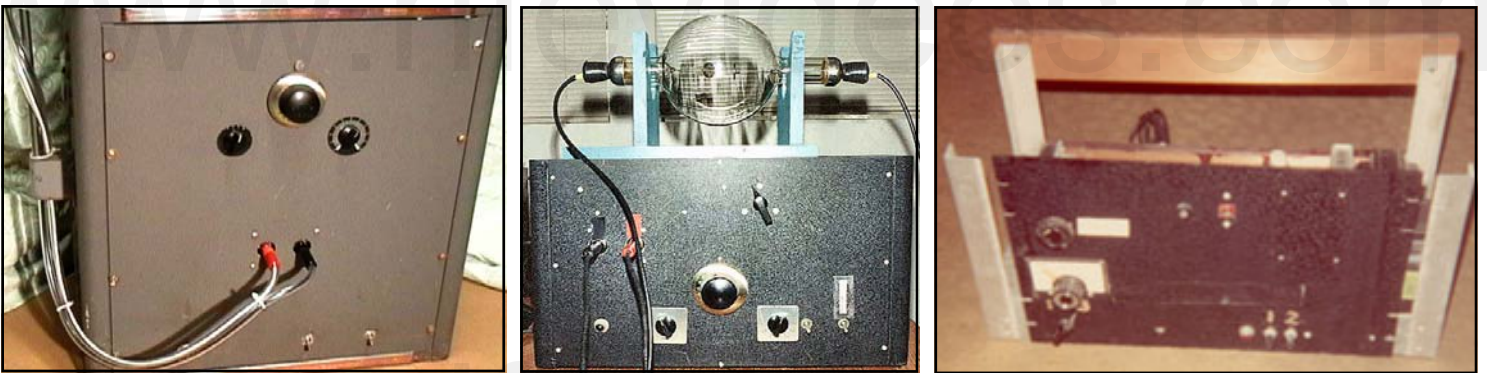

Above are three photos of instruments Verne Thompson built. The first instrument, going from left to right was Aubrey Scoon's early 1940's Beam Rays replica. The second instrument is believed to have been built in the mid to late 1940's but some of the transformers are 1960's vintage which may indicate it was built in the 1950's or 1960's. The audio frequencies used in it were even lower than the 1950's AZ-58. The third instrument is one of the AZ-58 instruments built by Verne Thompson in the 1950's for Dr. Rife, John Crane and John Marsh of Life Labs Co. This instrument called the AZ-58 is the most significant because we have more information about what went on in the 1950's than any period before this. At this time in the 1950's John Crane and John Marsh recorded interviews with Dr. Rife, Dr. Couche, Ben Cullen, Henry Siner and many other individuals who were key players in the early years of Dr. Rife's work.

All three of these instruments, like the Beam Rays Clinical instrument, had the fixed Hartley Oscillator section. Verne Thompson changed the 809 tube to the 812 tube as he updated the instruments from the 1940s to the 1950s. All three also had one main frequency dial for adjusting the audio frequencies. The other two smaller dials were for adjusting the modulation amplitude of the audio fre-

quencies and changing the audio frequency bands. The bands would take you through various audio frequencies. The AZ-58 was limited to about 6000 hertz but the 1940's Scoon instrument could go to about 200,000 hertz. There is very little difference in the way these instruments work. We built two of the three, tested them, and found no significant difference other than the use of sine or square wave audio frequencies. At any time the AZ-58 could have been changed to work on the original Beam Rays Clinical sideband method just by recalculating the audio frequencies to work with the 4.68 carrier frequency. We made some tests with the spectrum analyzer to see if square wave could be used instead of sine wave in creating the proper side band spacing and found that it works just as well as sine wave.

The basic design of Philip Hoyland's Beam Rays Clinical instrument is very apparent when you compare the schematics. Six of the 1950's AZ-58s were originally built by Dr. Rife, John Crane and John Marsh. We decided to test the AZ-58 with the spectrum analyzer. Below you can see the results of these tests.

Testing done with PicoScope 3205 spectrum analyzer at 2,400,000 Hertz using AZ-58

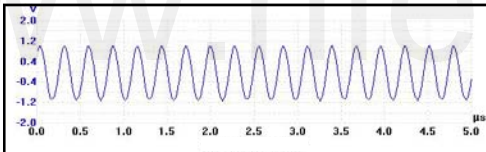

Sine wave out of AZ-58 at 2,400,000 Hertz.

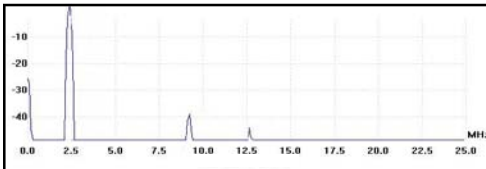

AZ-58 without ray tube at 2,400,000 Hertz measured with spectrum analyzer showing no real harmonics.

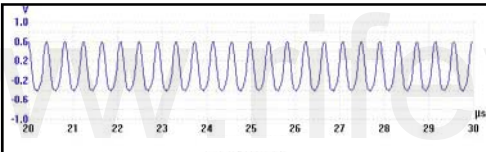

Sine wave carrier out of AZ-58 at 2,400,000 Hertz using ray tube. Sine wave carrier was always distorted when put through a ray tube.

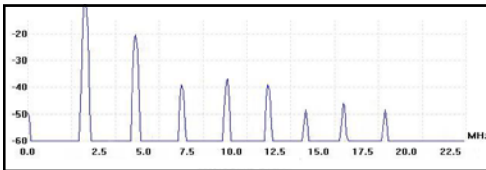

AZ-58 at 2,400,000 Hertz using ray tube. Measured with spectrum analyzer showing harmonics all the way up to 20,000,000 Hertz.

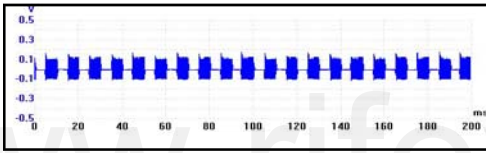

AZ-58 at 2,400,000 Hertz using ray tube. Showing 50% square wave audio frequency modulation. The square wave shows some distortion.

We will now cover in more detail the history of the instruments in the 1950's so you have a little more information. Some of the information comes from the John Marsh Collection of Rife audio CDs. As we said, in 1950 John Crane met Dr. Rife and in 1952-53 he met John Marsh. John Marsh became John Crane's supervisor at Convair Aeronautics when John Marsh moved from Tucson, Arizona to California. John Marsh's wife had cancer and they were not able to help her in Tucson so the doctors recommended that he take her to San Diego for specialized care. John Marsh and John Crane became friends. John Crane told John Marsh about Dr. Rife and they then went to see him. Dr. Rife gave them an old instrument which they had Verne Thompson repair. John Crane and John Marsh then used this instrument on John Marsh's wife and after several treatments John Marsh said she fully recovered. Here are John Marsh's statements which he made in 1976 and 1986:

MARSH: (1976) *"I met this Rife. I said Dr. Rife, I said, my name is John Marsh, I've got a wife that's dying. She's got cancer of the uterus." Dr. Rife said: "I won't touch that thing with a 20 yard pole."* After some discussion Dr. Rife said:

RIFE: *"I have an old instrument down here in the basement."*

MARSH: *"I dug up that old instrument and of course it had tubes in it, antique stuff, and so I rebuilt the darn thing."* ([John Marsh Rife CDs, CD 10 track 1](#))

MARSH: (1986) *"I went to see him [Dr. Rife], and I talked with him and he said he didn't want to have any part of it...I said look, I got a wife that's dying and I need your help! And so I got him out of his cocoon, so to speak, and we took an old instrument and rebuilt it. And I treated my wife and by darn all the pain left her and she got well." In another part of the tape he said: "I discovered that this Dr. Rife was a very great individual...I told John [Crane], I said look if we have any of those old instruments laying around loose, let's rejuvenate one of them and see if we can get my wife well. Well Verne Thompson who was with the San Diego police department radios, uh, radio expert, uh, had built some instruments and they were antiques when I saw them."* ([John Marsh Rife CDs, CD 2 track 3](#))

John Marsh and John Crane then decided they would like to work with Dr. Rife and try to get the frequency instruments built and back into doctors' hands. They wanted to help people who were suffering from many incurable diseases. From earlier quotes we learned that Verne Thompson had worked on Dr. Yale's Beam Rays Corporation instruments. He knew these instruments inside and out and this is why John Marsh and John Crane had him repair the instrument that Dr. Rife gave them. It is apparent that Verne Thompson knew this instrument's circuit designs well but he didn't understand how the Beam Rays Clinical instrument was using sideband harmonics to hit the harmonic M.O.R. of the various organisms. From a patent application that Dr. Rife and Verne Thompson filed we know that Verne Thompson also believed the audio frequencies were the M.O.R.s. This document leads us to only one conclusion, no one understood how Philip Hoyland's sideband spacing design worked.

John Crane in his later years (1980's) was not very truthful and said that they had to build the first instrument without any schematics. Verne had been building this Beam Rays Clinical instrument for many years so John Crane's statement does not ring true. The facts have shown that this instrument design came from Philip Hoyland. Verne Thompson updated the instrument for Dr. Rife, John Crane and John Marsh in the 1950's. Others have felt that John Crane took advantage of Dr. Rife. This may be true in some things that took place later on in the late 1960's, 1970's and 1980's but the evidence does not support this in the 1950's and early 1960's. Here is a quote from the John Marsh Collection (Trip to Ohio Papers) and Gonin Papers that are on [www.rife.org](#) under the John Marsh Paperwork. Dr. Rife, John Marsh and John Crane were talking at great length about John Marsh's trip to Ohio to see Dr. Stafford. In the Gonin papers they talked about the frequencies. I would recommend that everyone read these papers because they show that Dr. Rife, John Crane and John Marsh worked as a team and John Marsh and John Crane considered the frequencies to be Dr. Rife's, and the AZ-58 Beam Rays replica instrument to be Dr. Rife's instrument. The following statements confirm this:

RIFE: *"Well I have lived my life for the benefit of humanity, and it is the end result of the accomplishment."*

MARSH: *"Yes, now here is what I did tell them. They wondered where I fit into the picture. I told them I had lay outs at the base, I designed part of it. You would say that I was possibly not an exactly an inventor, but I think we are all co-inventors of a sort by adding what we think would make the instrument better and if they try to validified (verify) any of the statements that I have said to them please don't let me down, and say no this isn't so, which might upset what might be the truth to them. I mean just by accident. Now what I mean by that is this. I don't think that I have in my own right lied to them. I did [didn't] try to impress them with the idea that I was the one that did it. I did impress that you [Dr. Rife],*

John Crane and myself had worked together on this thing, but that you [Dr. Rife] were inventor and John [John Crane] was the designer and inventor, co-inventor and myself for putting this thing together and making it. They asked if I helped putting this thing together and making it from time to time. I couldn't tell them that I didn't, because if I had built up a feeling in them that I knew nothing about what I was doing; psychologically that could have torn down, or have caused delay the foundation that now is laid. Now I think we have a solid footing there. I under no circumstances would want that torn down, and I will not under any circumstances accept the credit for this instrument as being invented, because it is Rife's instrument as printed on the plate in front and that is one of the reasons in building you up to them, which I don't think is unwarranted; not by a darn sight, and that is why they want you there. They want to hear you talk, and they also want to know your past experiences with the people of La Jolla and also I was very happy to have received the paper concerning the Dr. etc., because I'm sure Stafford will contact every blooming Dr. that you had given him to me and I turned over all the letters to him, because I didn't want anything to stand in the way if he could contact him, now whether he would do that, before he would talk to the group, and I do not know. I suppose he will, but he wants the truth as badly as you do. Now I don't know an easier way it can be done. I don't think there is going to be an easy way to get it on, but I think I've outlined this thing. I studied the moves I was going to make before I ever went there. I studied what I was going to do if I had the opportunity to do so, which I did."

RIFE: *"Well I think that you did a very excellent job."* ([1957 John Marsh trip to Dayton, Ohio #8, 9 and 16](#))

And in the John Marsh Collection, Gonin Papers we read:

CRANE: *"So the frequencies [audio] we have written down. I will give you those or Rife will give them to you. I think you ought to have them. Each one [organism] has a different frequency, you see. I don't remember any of them off-hand. I should memorize them all, but I haven't yet. I've just written them down and they are in the lab."*

GONIN: *"Those frequencies that you have written down, would only apply to your own machine [AZ-58], wouldn't it?"*

CRANE: *"That is because they have been calibrated for each machine. Each machine has its own calibration."*

GONIN: *"And that's constant?"*

CRANE: *"Yes."* ([John Marsh Collection, Gonin and Siner Papers, Page 15, www.rife.org](#))

After reading these documents the facts stand out that all three of these men knew the audio frequencies and they were not John Crane's invention. Both John Marsh and John Crane considered the instrument to be Dr. Rife's. Dr. Rife also had a plaque on the front of the instrument with his name on it. It is also clear from John Marsh's papers that Dr. Rife was not on the sidelines but was a working partner in Life Labs. Dr. Rife by this time had become what some people call a working alcoholic. This type of drinker would have a little to drink during the day to take the edge off but would not be a total drunk. The documents show that Dr. Rife knew the audio frequencies that were used in the AZ-58. But it is clear that he didn't understand how those audio frequencies worked with Philip Hoyland's design. On the Rife CD's all of Dr. Rife's recorded conversations were very positive about the AZ-58 instrument and this does not sound like a man who was ignorant of what was going on, as some have claimed.

Anyone who reads the documents from this period of time can tell that there were a lot of high hopes for this instrument and the lower square wave audio frequencies it was using. Now the real question is how well did this instrument work on only square wave harmonics? There were a lot of

good reports on how well the instrument worked but what really counts is how well it worked in the hands of the doctors who used it on their patients. Dr. Robert P. Stafford M.D., used the AZ-58 for 5 years on his patients. His report is on www.rife.org with the John Marsh documents. His report is very favorable on many conditions that he used it for but when it came to cancer this instrument did not work as well as the Beam Rays Clinical high frequency harmonic sideband method. Dr. Stafford's report showed he treated 16 cancer patients and had a varied response rate using the AZ-58 on cancer. We must point out that the instrument did temporarily help some of his cancer patients while others did not see any benefits. Two of the women that he treated received a great deal of benefit but died from other complications which meant that he could not say they were cured by the instrument. When the first woman was autopsied she only had a small amount of cancer in her breast. When Dr. Stafford started treating her she had cancer in several other places including her neck. Had she not died from a fall she probably would have fully recovered. The second woman had cervical cancer for which other doctors used a great deal of radiation therapy. Dr. Stafford treated her at the hospital and after about four weeks she went home. She died of radiation damage that was done to the tubes that go from the kidneys to the bladder. When she was autopsied they found no cancer cells in her abdomen. In this case the cancer was completely gone. Since neither of these women lived for at least five years they could not be considered cured. So he could never say that he had cured anyone of a terminal malignancy. Dr. Stafford said this about the AZ-58 square wave audio frequency instrument:

DR. STAFFORD: *"As yet, we have failed to "cure" any case of advanced, terminal malignancy. It appears in several instances that we may have impressed the disease favorably, temporarily. It is difficult to rule out the psychological, morale booster effect to the terminal patient when some definitive effort is made again in his behalf. However, several improvements have appeared to be more physical than emotional...All the patients in the series were treated with the same frequencies (e.g., 728 - 784 - 880 - 2008 - 2128). Perhaps these frequencies may be wrong, or only nearly correct."* ([John Marsh Collection, Dr. Stafford's Report on using the AZ-58, page 4, www.rife.org](#))

It is clear that Dr. Stafford was questioning the accuracy of the square wave audio frequencies and felt that something was wrong. Everyone who has been around Rife technology for a long time has seen the very same results as Dr. Stafford. From time to time we see that someone has an amazing experience of recovery from cancer but for the majority this does not happen. Today these frequencies 728, 784, 880, 2008 and 2128 hertz which Dr. Stafford used are used by just about everyone for cancer. Many have wondered why the AZ-58 worked well for a few patients and not for others. The carrier frequency is probably the reason why it worked. The AZ-58 carrier frequency was originally set at 4.68 MHz but was changed using the variable capacitor to operate between 3.1 MHz to 3.3 with these two women and his other patients. If per chance the carrier frequency was at about 3.2 MHz it would have been only about 8,000 hertz off of the second harmonic of the BX. If a side band frequency of 2128 (AZ-58 BX audio frequency) was used it would have only been the 4th sideband harmonic spacing that would have hit the harmonic BX frequency of 3,208,000 hertz. If we take into account the "one tenth of one meter" tolerance frequency of 858 hertz it gives room for the frequency to be off a few hundred hertz and still work.

We also know that Dr. Stafford tried other RF carrier frequencies. Once he changed the carrier frequency the instrument would have been relying completely on the harmonics from the square wave waveform of the audio frequency alone. This would have greatly affected the outcome of his testing. The fact is the square wave harmonics method did not work as well as the Beam Rays Clinical sideband spacing method. The real problem is almost everyone believes the square wave audio frequencies are Dr. Rife's true M.O.R. frequencies. The evidence shows that John Crane and John Marsh believed the audio frequencies were the true M.O.R. frequencies and they had given this understanding to Dr. Stafford. Without the correct understanding of how the instrument worked Dr. Stafford would not have understood how important the fixed carrier frequency is. If he changed it off of the 3.2 MHz carrier frequency many of the 16 cancer patients could have been affected negatively. Dr. Stafford followed these 16 people over many years and in some cases things looked good at first, but the people

eventually died from their cancer anyway. In the 1934 clinic 16 patients who had cancer and tuberculosis were treated and cured. This is quite a contrast; 100% success in 1934 using Dr. Rife's high RF frequency method and a very limited success rate on cancer for the low square wave audio frequency harmonic method. Dr. Stafford used the AZ-58 instrument for a little over five years and sent his report to John Marsh. I am sure John Crane received it also. The big question that needs to be asked is, why did John Crane and John Marsh continue to tell people these audio frequencies were the frequencies which Dr. Rife used in the 1934 clinic when the medical proof showed they didn't work as well as the high RF frequencies? This clearly shows they did not understand the sideband method. Why do people today continue to say these frequencies cure cancer even after they have seen the same results? Could it be because having had a few good results they ignored the evidence and fooled themselves? By the time all the evidence was available, John Marsh and John Crane were in jail on three or four different legal counts, one of which was for treating a woman without a medical license.

Dr. Rife did not want to have anything to do with all the legal trouble they were in. He was able to avoid it because he never made any claims and he would never treat anyone. The legal problems shut down Life Labs. Had this not happened I wonder if Dr. Rife would have ignored this evidence? I do not believe he would have. He would have realized that the changes they made to the instrument depending solely on square wave audio frequency harmonics compromised its effectiveness. I think Dr. Rife would have eventually realized that they didn't fully understand how the Beam Rays Clinical instrument worked and he would have gone back to his original principles of using high RF frequencies. We will never know what he would have done because I do not think Dr. Rife ever read Dr. Stafford's report because John Marsh received it after he and John Crane were released from jail.

The sad thing is this, because so few really understand Dr. Rife's early instruments and how Philip Hoyland's Beam Rays Clinical instrument worked a whole industry has been built on this limited square wave audio frequency harmonic instrument. The people who purchase these square audio frequency instruments believe it is the same type of instrument used in the 1934 clinic. All because we didn't know the truth. Are we today just fooling ourselves also? Are we trying to get these same square wave audio frequency harmonic type instruments and the frequencies they use to do what Dr. Stafford could not get them to do? Cure cancer? We know there have been incredibly good results on many other conditions using audio frequencies which show this type of instrument and method is of great worth but the truth is sometimes hard to accept.

As we have already read, Dr. Stafford came to suspect that the audio frequencies were not true M.O.R.s and he wrote a letter to Dr. Edward Jeppson in Salt Lake City. He did this because Dr. Jeppson was having the same type of results Dr. Stafford was having. Here is his statement from his letter: Page [#1](#) [#2](#)

DR. STAFFORD: *"Please excuse my format in the following letter for I intend to ramble a bit and forget strict grammatical dictum. I am writing you at this time partially because John Marsh informs me in a recent letter that you may be somewhat disheartened or at least worried about your role in the experimentations with the Rife Machine. Believe me, Dr. Edward I know how you feel for I too have been through this same feeling with this matter. I have observed clinical results after treatments with this gadget which I can scarcely believe myself. Yet, despite these good results, I have been confused by some rather simple failures such as a recent experiment which I conducted at Good Samaritan Hospital where we used the machine to treat some cultures of Staph Aureus and Strept. Fecalis. In this work we failed to inhibit growth at all or influence the cultures with the Rife Rx. I sent the results to John Marsh and asked for clarification and to be very frank I am not satisfied with John's excuse of the failure as described by Dr. Rife. I am afraid I'm not a very good apostle for I'm getting some ideas myself on how this thing may work. I really wonder if this ultrasonic kills bacteria and virus at all or does it work like other forms of ultrasonic and merely stimulate the tissue in some unusual manner thereby improving the circulation and secondarily enhancing the body's defenses against infection...To summarize some of this rambling: I feel that the Rife Ultrasonic Therapy has a very definitely beneficial effect on the human (and canine) body...I furthermore feel that we, as doctors of medicine, using this machine must remain constantly alert to the condition of our patient and vary the Rx as indicated."*

Clearly Dr. Stafford didn't believe the audio frequencies were correct. Little did he know they were not the same frequencies used with the Rife Ray #4 and Kennedy Company equipment. The AZ-58 could have output the higher harmonic sideband frequencies that Philip Hoyland used in his Clinical instrument if they had understood how it really worked. Whatever was told to Dr. Stafford by Dr. Rife through John Marsh there was no way they were going to tell Dr. Stafford there was something not quite correct with the instrument. This would ruin everything they had worked for. Besides they really had no choice because the FCC regulations would not allow Dr. Stafford to use a Rife Ray #4 style instrument. We must remember they were testing the AZ-58 Beam Rays Clinical instrument replica to see how well it would work using just harmonic square wave audio frequencies with a fixed RF carrier frequency. At this time it is apparent the AZ-58 was not performing as well as Philip Hoyland's Beam Rays Clinical instrument, Rife Ray #4 and Kennedy Company equipment. We need to remember Philip Hoyland tested his instrument using Dr. Rife's microscope. When Henry Siner was in England testing Philip Hoyland's instrument he reported that it would kill the organisms while they were looking at them under Dr. Rife's microscope. These facts show that Philip Hoyland's Beam Rays instrument was working on Dr. Rife's same principle of coordinative resonance. Dr. Stafford found out the AZ-58 using the square wave audio frequency harmonic method was not capable of doing this when he tested it on microorganisms. In the 1950's Dr. Rife no longer had a lab for testing any microorganisms. There is no evidence they ever tested just the square wave audio frequencies with the microscope. So they did the only thing they could. They let the doctors use the AZ-58 and tell them how well it worked. We must remember the instrument Dr. Rife gave to John Marsh and John Crane was either a Philip Hoyland's Beam Rays Clinical instrument or a Rife Ray #4 style instrument, and it worked. John Marsh said it cured his wife of cancer. Again the fact is the AZ-58 instrument using square wave audio frequency harmonics never worked as well as Philip Hoyland's Beam Rays Clinical or Laboratory instruments. It also didn't work as well as the Rife Ray #4 or Kennedy instruments. The square wave harmonic method used in the AZ-58 produced very good results on many conditions but not the results hoped for on cancer. But still even with the changes the AZ-58 worked very well on just about everything else but cancer. These square wave audio frequencies are what people have been using for the past 50 years believing they were Dr. Rife's true M.O.R.s, all the while not knowing they were not Dr. Rife's original frequencies which he used in his earlier instruments built in the 1920's and 1930's. Not until the papers from the 1939 Beam Rays Trial, John Marsh Papers, Kennedy Company equipment spectrum analysis and Philip Hoyland Beam Rays Clinical instrument spectrum analysis came to light did we have the ability to finally figure out where all these frequencies came from. This information finally reveals which frequencies were the correct M.O.R.s. Notwithstanding the various setbacks Dr. Stafford was still amazed at the wonderful results he achieved with the AZ-58.

To sum things up only a few changes were made to the Beam Rays Clinical instrument which produced the 1950's AZ-58 Beam Rays replica. Dr. Rife and Verne Thompson kept the original Hartley oscillator but changed the fixed carrier frequency from 3.80 MHz to 4.68 Megahertz. The RF carrier frequency section insignificantly changed with the use of the 812 tube instead of the 809 tube. They kept the variable audio oscillator which produced the low audio frequencies but lowered its range of frequencies using only three bands with a top audio frequency range of about 6000 hertz. They then lowered the 1940's audio frequencies by a factor of about 10 times and used these lower audio frequencies in the AZ-58. Then they changed the audio frequency waveform from sine wave to square wave and depended on the harmonics produced by the square wave waveform. It is interesting that Philip Hoyland found that a modulated sine wave waveform when put through his M.O.P.A. circuit was sufficient to devitalize organisms because it creates a square wave waveform. It appears that a damped wave is not really necessary. When you compare the Beam Rays clinical instrument and Aubrey Scoon's 1940's instrument to the 1950's AZ-58 Beam Rays Clinical replica they are almost identical. When we built both of these instruments, Scoon's and the AZ-58, and compared them we found the AZ-58 replica appears to be the better design since it is a newer design which uses the 812a tube.

Below in the chart is a list of the “Original 1950s AZ-58 Frequencies” used by Dr. Stafford. The column to the right of the AZ-58 frequencies is based on a 4.68 MHz carrier and is labeled “4.68 Correct Sideband Frequencies” and would be the correct sideband frequencies to make the AZ-58 instrument work like the original Beam Rays Clinical instrument, but, the problem is the “Number of Sideband Harmonics” for most of the frequencies are far more than 40 sideband spacing steps. The large “Number of Sideband Harmonics” meant that the power level of the correct sideband that hit the higher harmonic M.O.R. would be so weak that it really becomes useless. If the “Number of Sideband Harmonics” goes over about 40 the power level on a spectrum analyzer shows that they are probably too weak to work. You will notice how closely these two sets correspond to each other. The problem is when Dr. Rife, John Crane and John Marsh lowered the audio frequencies they compromised the AZ-58. The BX audio frequency that Dr. Stafford used was 2128 and the RF carrier frequency was about 3.2 MHz. The side band spacing to the “Higher Harmonic Frequency” M.O.R. took only a few sidebands which had enough power to work. This appears to be the reason why the two women and a few others that he treated had such amazing results. But most of the organisms far exceed the 40 sideband harmonics with the use of the low audio frequencies even if you use a 3.2 MHz or 4.68 RF carrier frequency. As mentioned before the higher the audio frequency used the more power there is in the sidebands. For this reason, on the next page, we have put a list of the optimum AZ-58 audio frequencies to be used with a 4.68 MHz RF carrier frequency and a 40,000 hertz audio frequency oscillator. This would make the instrument work like the original Beam Rays Clinical instrument.

Original 1950's AZ-58 Frequencies Used By Dr. Robert P. Stafford M.D.

Microorganism	Rife Ray #4 Frequencies	Higher Harmonic Frequencies	*Carrier Difference Frequency	1/10 Of A Meter Freq.	Number of Sideband Harmonics	Original 1950s AZ-58 Frequencies	4.68 Correct Sideband Frequencies
Actinomycosis or Streptothrix	192,000 Hz	4,608,000 or 24th	72,000 Hz	12 Hz	92	784 Hz	782 Hz
Anthrax	139,200 Hz	4,732,800 or 34th	52,800 Hz	6 Hz	85		621 Hz
B or E Coli Rod	417,000 Hz	4,587,000 or 11th	93,000 Hz	58 Hz	116	800 Hz	802 Hz
B or E Coli Virus	770,000 Hz	4,620,000 or 6th	60,000 Hz	198 Hz	38	1552 Hz	1538 Hz
BX Virus Carcinoma	1,604,000 Hz	4,812,000 or 3rd	132,000 Hz	858 Hz	32	2128 Hz	2129 Hz
BY Sarcoma	?1,530,000 Hz	4,590,000 or 3rd	90,000 Hz	780 Hz	45	2008 Hz	2000 Hz
Gonorrhea	233,000 Hz	4,660,000 or 20th	20,000 Hz	18 Hz	28	712 Hz	714 Hz
Pneumonia or Spinal Meningitis	427,000 Hz	4,697,000 or 11th	17,000 Hz	61 Hz	17	776 Hz	1000 Hz
Staphylococcus Pyogenes Aureus	478,000 Hz	4,780,000 or 10th	100,000 Hz	76 Hz	137	727 Hz	730 Hz
Streptococcus Pyogenes	720,000 Hz	4,320,000 or 6th	360,000 Hz	173 Hz	409	880 Hz	880 Hz
Syphilis	789,000 Hz	4,734,000 or 6th	54,000 Hz	207 Hz	82	660Hz	658 Hz
Tetanus	234,000 Hz	4,680,000 or 20th	0 Hz	18 Hz		120 Hz	20 Hz
Tuberculosis Rod	369,000 Hz	4,797,000 or 13th	117,000 Hz	45 Hz	146	803 Hz	801 Hz
Tuberculosis Virus	? 769,000 Hz	4,614,000 or 6th	66,000 Hz	197 Hz	44	1552 Hz	1500 Hz
Typhoid Rod	760,000 Hz	4,560,000 or 6th	120,000 Hz	192 Hz	168	712 Hz	714 Hz
Typhoid Virus	1,445,000 Hz	4,335,000 or 3rd	345,000 Hz	694 Hz	185	1862 Hz	1865 Hz

**1950's Beam Rays Clinical Instrument Optimum Sideband
Square Wave Audio Frequencies Based On A 4.68 MHz Carrier**

Anthrax	26,400 Hz	Streptococcus	32,727 Hz
B or E Coli Rod	31,000 Hz	Steptothrix	36,000 Hz
B or E Coli Virus	30,000 Hz	Syphilis or Treponema	18,000 Hz
BX Virus Carcinoma	33,000 Hz	Tetanus	20 Hz
BY Sarcoma	?30,000 Hz	Tuberculosis Rod	39,000 Hz
Gonorrhea	20,000 Hz	Tuberculosis Virus	? 33,000 Hz
Pneumonia or Spinal Meningitis	17,000 Hz	Typhoid Rod	40,000 Hz
Staphylococcus	25,000 Hz	Typhoid Virus	38,333 Hz

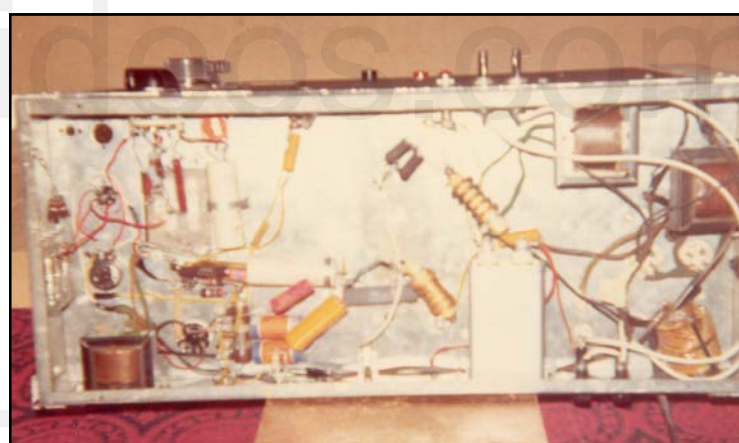
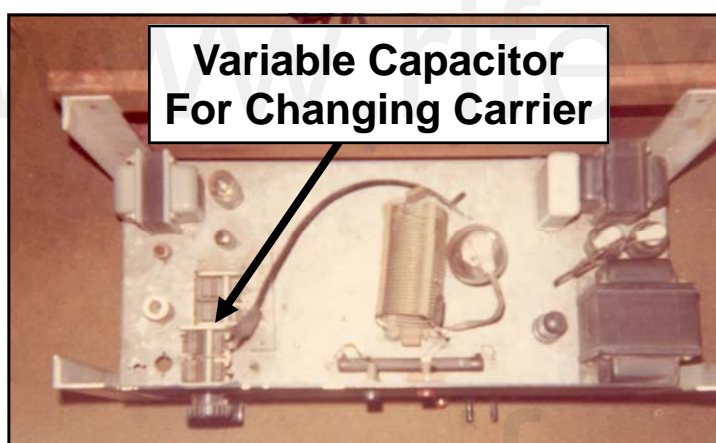

Above are two photos of the original AZ-58. On the left, is the inside of the case. On the right, is a view of the under side of the chassis. On page 95 are photos of the AZ-58 we built back in 2001. It used to have the vacuum tube audio oscillator but it never worked properly. So it was removed and replaced with Aubrey Scoon's audio amplifier.

On page 96 is a schematic of the 1950s AZ-58 instrument. The 866 vacuum tubes have been replaced with solid state rectifiers. Also the old vacuum tube audio oscillator has been removed. It is easier and more accurate to use Aubrey Scoon's booster amplifier and a modern function generator to produce the audio frequencies that were used in this instrument. The layout of the electronic parts of this instrument is also very important because of the inherent interference problems that come with RF oscillators. Again anyone wishing to build this instrument should have a good understanding of old tube technology. Some parts of this circuit use up to 2000 volts DC with substantial current and can easily kill anyone who is not familiar with this kind of current or voltage. We take no responsibility for anyone who builds this instrument. We recommend that you have professional help.

Photos of the rebuilt AZ-58 Beam Rays Clinical instrument

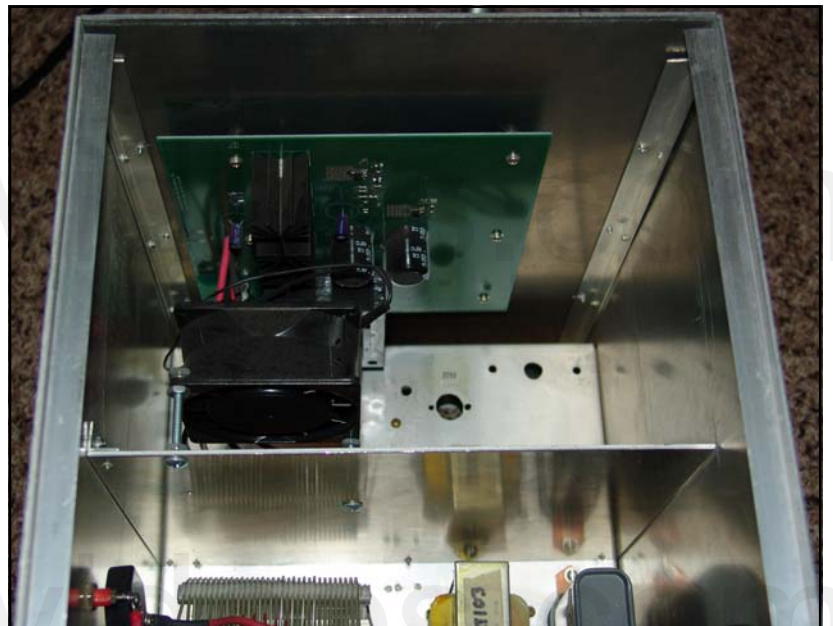
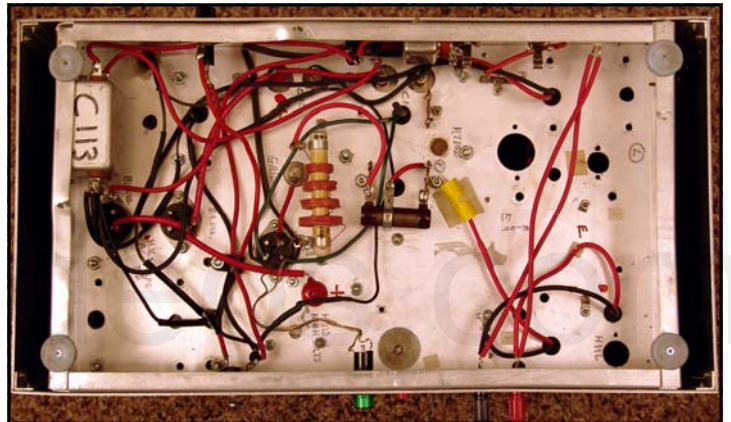
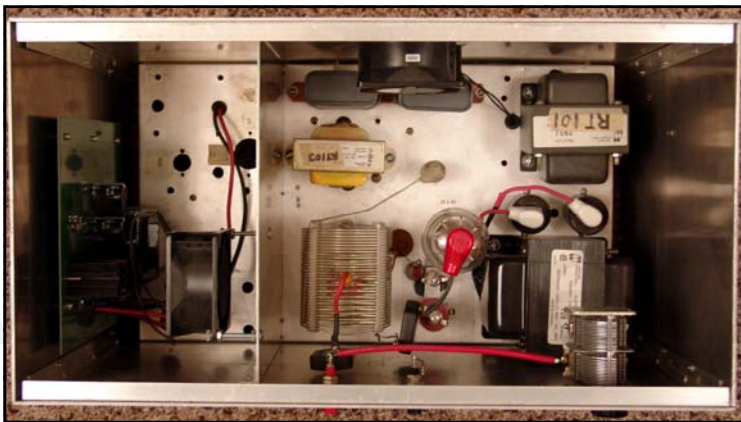
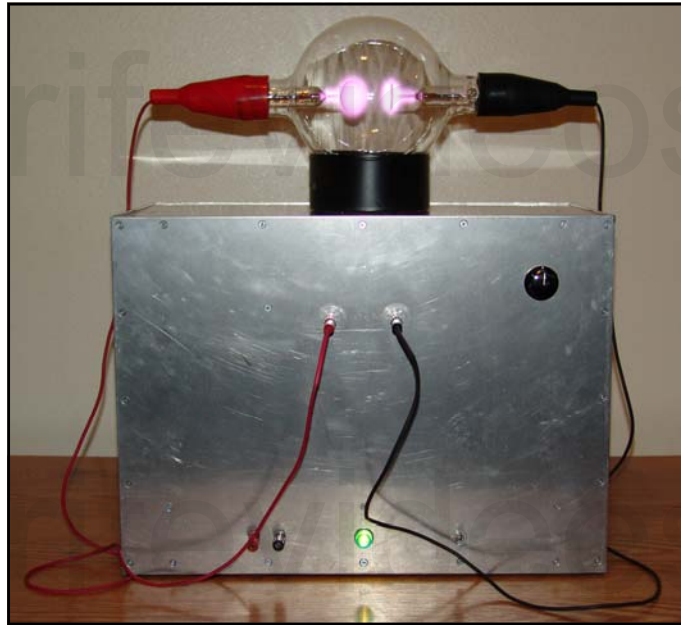

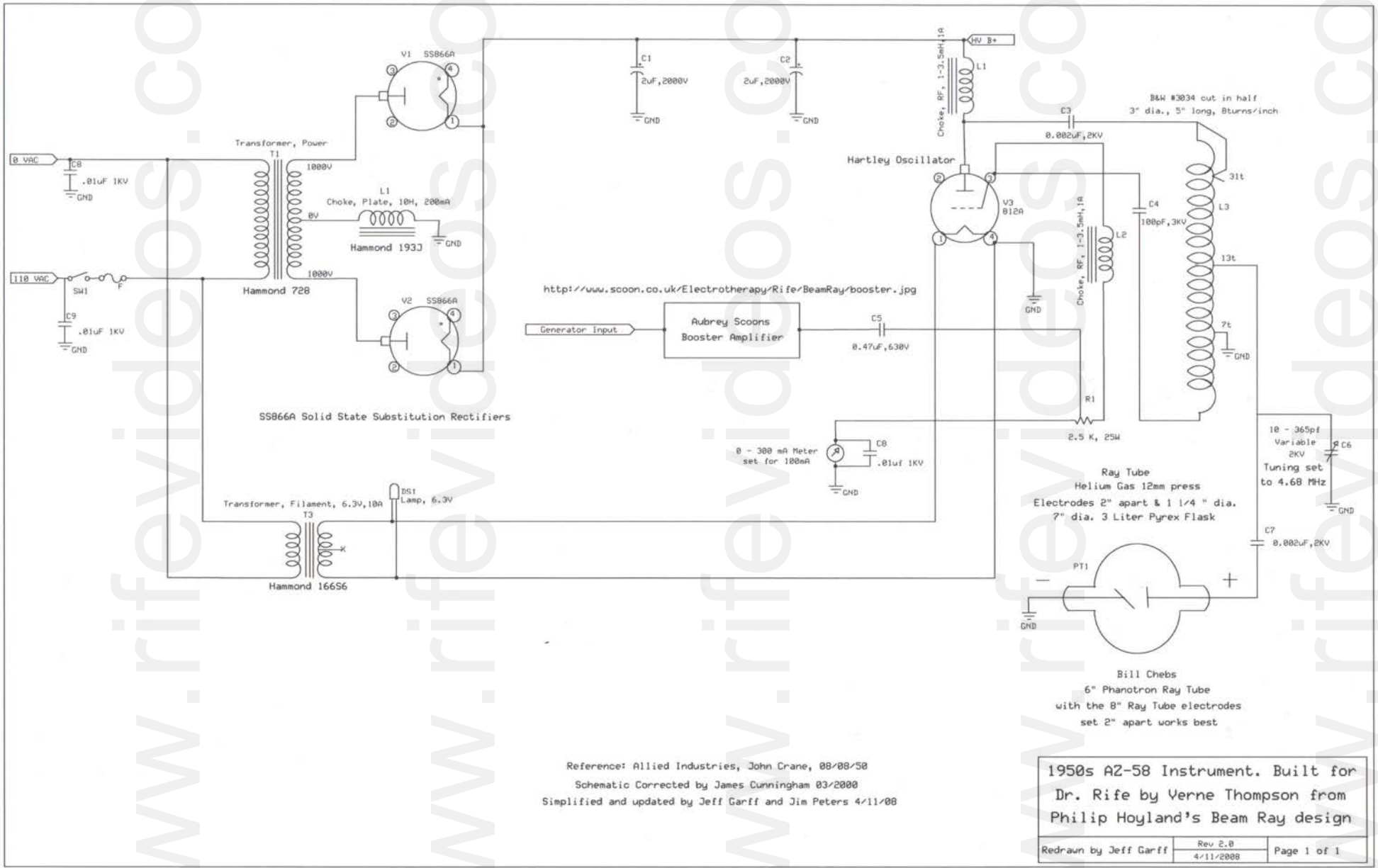

Reference: Allied Industries, John Crane, 08/08/58
 Schematic Corrected by James Cunningham 03/2008
 Simplified and updated by Jeff Garff and Jim Peters 4/11/08

1950s AZ-58 Instrument. Built for
 Dr. Rife by Verne Thompson from
 Philip Hoyland's Beam Ray design

Redrawn by Jeff Garff	Rev 2.0 4/11/2008	Page 1 of 1
-----------------------	----------------------	-------------

Harmonic audio frequency misunderstanding

There is a belief that the audio frequencies that were used in the original Beam Rays Clinical instrument and its 1940's and 1950's AZ-58 replica instruments are harmonic M.O.R. frequencies derived by dividing Dr. Rife's original high RF frequencies down in octave steps until you reach the audio range of frequencies. For this to be true all of the audio frequencies would have to be true harmonics of the higher RF frequencies. This is not the case.

All the documents we have quoted and the understanding we now have prove as a myth the long believed concept that the audio frequencies used in the 1950's were created by John Crane and John Marsh by dividing Dr. Rife's high frequency M.O.R.s down by harmonic steps until they reached the audio range of frequencies. If we take the correct frequency for the BX of 1,604,000 Hertz read by Philip Hoyland and divide it down by harmonics we do not get 2008 or 2128. In fact, we do not get the higher 1940's audio frequencies of 20080 or 21275 Hertz either. This clearly proves John Crane and John Marsh did not create the audio frequencies by just dividing down Dr. Rife's higher RF M.O.R. frequencies. The fact is we know that the origin of these audio frequencies came from the sideband harmonic method used by Philip Hoyland in the original Beam Rays Clinical instrument.

The documented information we have shows that Dr. Rife's true M.O.R.s that would resonate organisms were the higher RF frequencies used in the Kennedy Models 110, 281 and Rife Ray #4 and higher harmonics or those frequencies used in the Beam Rays Clinical instrument. From the spectrum analysis of Philip Hoyland's Beam Rays instrument we know that it used the method of sideband harmonic spacing to hit the higher harmonic frequencies which are also RF M.O.R.s. Henry Siner reported Philip Hoyland's design killed the organisms under microscope observation. Add to this the list of doctors who used the instruments and said they had many diseases cured. This shows that Philip Hoyland' harmonic method works beyond question.

Dr. Stafford was not able to kill any organisms using just the square wave audio frequency harmonics with a fixed RF carrier. He did his tests under microscope observation. Today, like Dr. Stafford many have tried to kill the organisms which these audio frequencies correspond to, with no success. If these audio frequencies, as some have claimed, were really harmonic frequencies derived from the higher RF M.O.R. frequencies then they should be able to kill the microorganism they correspond to. If an audio frequency harmonic of Dr. Rife's RF M.O.R. will not devitalize an organism under microscope observation, can the harmonic association be valid? No rational person would believe this. Yet today this is exactly what most people believe because they do not have all of the facts. The evidence we have read shows that if the RF M.O.R. frequency is lowered by too much it will lose its ability to devitalize an organism even though it is a harmonic frequency. Dr. Stafford and many others found when they treated the organism with the audio frequency that was supposed to devitalize it the organism continued to grow. Then when they transferred it from one culture to another it still grew on the new medium they used. Can there be any greater scientific proof than this? Even Dr. Rife would not have argued with this method of determining true M.O.R.s, because this is the method he used. This is the greatest proof, along with the fact that almost all the audio frequencies are not true harmonics of the original high RF frequencies. We know many other people who have made the same tests on microorganisms as Dr. Stafford and told us they obtained the same results he did. John Marsh said on the Rife CDs that they came up with the frequencies using math. If every audio frequency was a perfect harmonic match to its higher RF M.O.R. then we could say they were all derived from the RF M.O.R.s, but they are not. Even if the audio frequencies were derived from the RF M.O.R.s, and they do not devitalize the organism in the same way, is the principle valid?

What the evidence certainly proves is, without really knowing it, Dr. Rife, John Crane and John Marsh discovered that these lower square wave audio frequencies are beneficial. Since they will not devitalize the organism they correspond to under microscope observation, then how can it be that they seem to help people? From Dr. Stafford's statement we read that he also wondered why they would work on some conditions and not others, like cancer. He felt that these audio frequencies stimulated the adrenal glands and immune system much like ultrasonic frequencies do. And this stimulation is why the frequencies help even though they do not work like a true RF M.O.R. frequency would. The

fact is we really don't know why the audio frequencies are beneficial, but for some unknown reason they are. Though the method of modulating a square wave audio frequency onto a fixed carrier did not work as well as Dr. Rife's original method did, nevertheless it works very well on some conditions. Even though the audio frequencies are beneficial in many ways, this still does not prove the idea that the 1950's audio frequencies are harmonic M.O.R.s.

Below is a chart showing the correct "High Frequency M.O.R.s" which were taken from the Rife Ray #3 and used with the Rife Ray #4. Upper harmonics of these frequencies were used in the Beam Rays Clinical instruments. These frequencies are the true M.O.R.s. The "Harmonic Higher Audio Frequency" column is true harmonic of the "High Frequency M.O.R.s" column and would work very well using the square wave harmonic waveform that was used in the AZ-58 replica instrument. The "Harmonic Higher Audio Steps" column shows how many harmonic steps it takes to hit the fundamental "High Frequency M.O.R.s" using the "Harmonic Higher Audio Frequency" using a square wave waveform. As can be seen the higher the frequency the less harmonic steps it takes to hit the fundamental M.O.R. frequency.

Now if we take a look at the "1950s Low Audio Frequency For AZ-58" column we see the frequencies that were used by the AZ-58 back in the 1950s. These frequencies are still used today. In the "True Harmonic Low Audio Frequency For AZ-58" column we find the true low audio frequency harmonics of the "High Frequency M.O.R.s." As you compare these columns you can see that the 1950s frequency for Actinomyces or Streptothrix was 784 Hertz but the true harmonic frequency is 750 hertz. It is easy to see that the AZ-58 was not working on square wave harmonics of the true M.O.R.s. If you look at the "Harmonic Low Audio Steps For AZ-58" column you can see how many harmonic steps it takes to reach the true "High Frequency M.O.R." These range from 128 to 1024 harmonic steps. Anyone looking at these numbers would wonder if these frequencies could ever work. The higher the frequency the better the chance they will work. Once you go above 35 to 40 steps the chance they will work is greatly diminished. When using the square wave method we need to have the highest frequency possible.

AZ-58 M.O.R. Audio Frequencies Square Wave Harmonics						
Microorganisms	1950s Low Audio Frequency For AZ-58	True Harmonic Low Audio Frequency For AZ-58	Harmonic Low Audio Steps for AZ-58	Harmonic Higher Audio Frequency	Harmonic Higher Audio Steps	High Frequency M.O.R.s
Actinomyces (Streptothrix)	784 Hz	750 Hz	256	48,000 Hz	4	192,000 Hz
Anthrax	None	1087.5 Hz	128	34,800 Hz	4	139,200 Hz
B. Coli (Rod form)	800 Hz	814.4531 Hz	512	52,125 Hz	8	417,000 Hz
B. Coli (Filterable virus)	1552 Hz	1503.9063 Hz	512	48,125 Hz	16	770,000 Hz
Bacillus X or BX (Cancer Carcinoma)	2128 Hz	3132.8125 Hz	512	50,125 Hz	32	1,604,000 Hz
Bacillus Y or BY (Cancer Sarcoma)	2008 Hz	2988.28125 Hz	512	47,812.5 Hz	32	?1,530,000 Hz
Gonorrhea	712 Hz	910.15625 Hz	256	29,125 Hz	8	233,000 Hz
Pneumonia or Spinal Meningitis	776 Hz	1667.96875 Hz	256	53,375 Hz	8	427,000 Hz
Staphylococcus Pyogenes Aureus	727 Hz	933.59375 Hz	512	59,750 Hz	8	478,000 Hz
Streptococcus Pyogenes	880 Hz	703.125 Hz	1024	45,000 Hz	16	720,000 Hz
Syphilis	660 Hz	770.5078 Hz	1024	49,312.5 Hz	16	789,000 Hz
Tetanus	120 Hz	914.0625 Hz	256	29,250 Hz	8	234,000 Hz
Tuberculosis (Rod)	803 Hz	720.7031 Hz	512	46,125 Hz	8	369,000 Hz
Tuberculosis (Virus)	1552 Hz	1501.953125 Hz	512	48,062.5 Hz	16	?769,000 Hz
Typhoid Fever (Rod)	712 Hz	742.1875 Hz	1024	47,500 Hz	16	760,000 Hz
Typhoid Fever (Virus)	1862 Hz	1411.1326 Hz	1024	45,156.25 Hz	32	1,445,000 Hz

Life Labs 1950's pad instrument (without ray tube)



- 1) Used round disks that came in contact with the body. Later changed in the 1960's to hand cylinders or foot pads.
- 2) Had no RF carrier frequency.
- 3) Used the square wave audio frequencies used in the AZ-58.

It was about 1957 when John Crane and John Marsh began building instruments without a ray tube. Earlier in this article Bertrand Comparet was quoted as saying:

COMPARET: *"Now, Crane said "Well now look, Rife himself admits that no matter how much tube and ray, and so on, you have, you can't get any results unless you've got the right frequency. Therefore the real clue to the thing is the frequency and not the means by which you deliver it."* ([1970's Bertrand Comparet Interview #33](#))

John Crane and John Marsh replaced the ray tube with a type of pad that they developed which came in contact with the body. As we pointed out earlier in this article it is interesting to note that Dr. Rife said Abrams' Oscilloclast would devitalize the BX cancer virus and it was a contact type device. John Crane and John Marsh probably used this contact method because of the success of Abrams' instrument. From the documented information we have it was also the high cost of building ray tube instruments that caused them to look at doing things in a different way. In addition to being expensive to build, the ray tube could break very easily. They had many problems with them. I don't believe Dr. Rife, at least in his early years, ever had a reason to look at doing things differently. John Crane and John Marsh did! They didn't have the kind of money to spend that Dr. Rife did. Necessity is the mother of invention!

John Crane and John Marsh used a Heathkit function generator to produce the frequencies. These Heathkit function generators had no built-in carrier frequency on which to modulate the audio frequencies. Therefore, the carrier frequency was no longer used. The fact that they didn't feel the RF carrier frequency was necessary shows that they totally believed that the audio frequencies were the M.O.R. frequencies. This also shows beyond doubt that they never knew the importance of the RF carrier frequency or had any understanding of the harmonic sideband method used in the original Beam Rays Clinical instrument. They could have made a pad instrument work like the Beam Rays Clinical instrument if they would have used a harmonic sine wave RF carrier frequency. It appears that the removal of the ray tube was not as important as the removal of the RF carrier frequency.

Dr. Rife would have never approved of using an instrument without a carrier frequency since he knew that Philip Hoyland's method somehow needed an RF carrier frequency to make it work properly. Though Dr. Rife didn't fully understand Philip Hoyland's instrument he clearly understood the importance of the carrier frequency. The positive part of using a Heathkit function generator in this way is

they were inexpensive (\$200) and a lot more people could afford one. Many people can thank John Crane and John Marsh for this innovative method. John Crane and John Marsh proved that the audio frequencies worked the same whether applied through a ray tube or pads if sufficient power is used. Many people think that John Crane and John Marsh built the pad instrument without Dr. Rife being fully informed about it. But this was not the case. John Crane and John Marsh had talked for some time about building a smaller ray tube instrument but instead of building it they built the pad instrument. In John Marsh's Trip to Ohio Papers we read this:

RIFE: *"That is the only way that it can be handled properly."*

MARSH: *"Maybe we can sell small instruments for the purpose of small diseases like colds, flu and stuff like that, which are minor, which the Dr.s prefer not treating those kind anyway, because they are chronic, and there isn't anything they can do with them. People keep coming in and coming in and they take up his time where he could spend it taking care of a bad case, or something or other. Dr. Stafford said that he would prefer that a small instrument would be made...What do you think John? I've been doing a lot of talking not even giving you a chance to get a word in edgewise."*

CRANE: *"There is no doubt there is going to be an awful lot of development on this design..."* ([1957 John Marsh trip to Dayton, Ohio #36-38](#))

From these statements we learn that Dr. Rife knew that they wanted to build small instruments. Also we learn that it was John Marsh and John Crane's idea to build the pad instruments and not Dr. Rife's. We know that Dr. Rife was upset with John Crane over some of his changes because he expressed it to Bertrand Comparet during his 1961 deposition. Comparet said:

COMPARET: *"And I asked Rife, because I thought Rife would certainly say that the way Crane was working on it then was still using the Rife principle, but he indignantly denied it."* ([1970's Bertrand Comparet interview #32](#))

At this time John Crane and John Marsh were working on both the ray tube instrument and the pad instrument. We know that Dr. Rife considered the ray tube instrument to be his. This ray tube instrument used an RF carrier frequency on which the square wave audio frequencies were modulated. It's clear that the pad instrument without a carrier frequency is what Dr. Rife was upset about. However, John Marsh and John Crane's innovation with a pad instrument proved that the ray tube could be removed. This made it possible for more people to have access to Dr. Rife's technology. Today all the frequencies which Dr. Rife used can be produced by any function generator with the proper frequency range.

It appears the reason why John Crane and John Marsh didn't use a carrier frequency is the Heathkit function generator that they used didn't have the capability of using a Megahertz (MHz) carrier frequency. Audio frequencies will not broadcast, therefore, they are modulated upon the carrier frequency so that they will penetrate the body. In laymen's terms, modulation is piggy-backing one or more low frequencies on another higher frequency. The frequencies travel together but still remain somewhat separate and distinct. Many instruments built today do not use a carrier frequency even though Dr. Rife's did. If Dr. Rife could have removed the carrier frequencies from his instrument and gotten the same results, I believe he would have. As it is, Dr. Rife never removed the carrier frequency from any of his instruments. It was John Crane and John Marsh who did this. If a person wants to try and obtain the results which Dr. Rife did, then a carrier frequency should be considered and used in any audio frequency instrument.

We realize that there are ray tube instruments today that do not use a carrier frequency. These use a high electromagnetic field which will transfer the energy into the body. They appear to work very well with low square wave audio frequencies. We do not doubt that these instruments work. We know people that are using these instruments and say that they are getting very good results. But what we

are talking about in this article is the way that Dr. Rife used RF frequencies and an RF carrier frequency modulated with an audio frequency. Some of these EM ray tube instrument builders like to compare EM devices to RF devices. This is like comparing apples and oranges. There is no comparison. The EM devices work on a high electromagnetic field, the stronger the better. RF devices work on radio frequencies and the power output is measured in watts. Dr. Rife's instruments were all RF instruments and could resonate an organism when the proper RF frequency was used. EM devices use low audio frequencies because they cannot output RF frequencies. RF versus EM or apples and oranges cannot be compared because they are two totally different principles.

Some people believe that audio frequencies when used in a pad instrument without a carrier will only travel along the skin of the body, and won't penetrate it. The skin effect has nothing to do with human tissue. It has to do with the skin of a metal conductor such as a copper wire. If the human body was made of metal then this would apply. In scientific studies on [Bioelectric Impedance Analysis](#) in the body it has been shown that sine wave audio frequencies will enter the body but will only travel in the connective tissues around the cells. Also in these scientific studies it has been shown that the closer you get to 1 Megahertz the greater the penetration into the cell. At 1 Megahertz the frequency will go straight through the cell and fully penetrate the body. This is why it is very important that a carrier frequency be used. A virus can enter a cell. An RF frequency can enter the cell where it can do the most good. These kinds of scientific studies and their importance were not understood by John Crane and John Marsh in the 1950's and 1960's. Dr. Rife's instruments always used a high RF frequency or a carrier frequency.

Below is a schematic of John Crane & John Marsh's pad instrument. It was nothing more than an off-the-shelf audio frequency generator with the faceplate changed. There was nothing special about this frequency generator because any common function generator can do the same thing this one could. There have been people who have copied this instrument and who charge enormous sums of money for a replica. As much as four or five thousand dollars. They claim that this is a real genuine Rife Machine. Do not be fooled. The same audio frequencies that were used in the AZ-58 were used with this instrument.

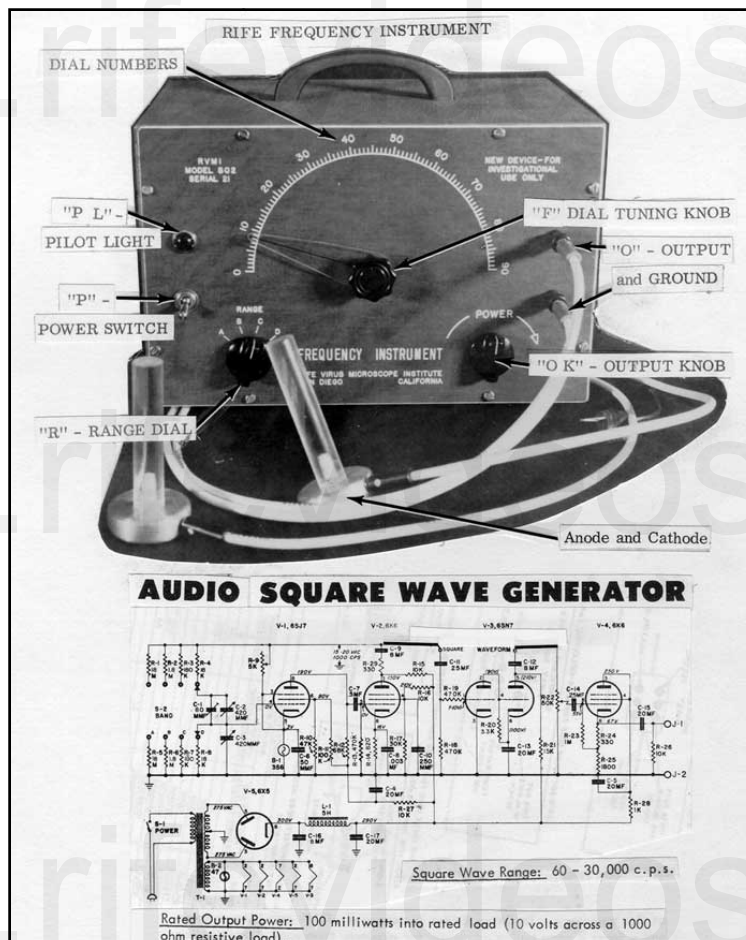

John Marsh's 1970s Beam Rays replica instrument



- 1) Used a ray tube.
- 2) Carrier frequency was 4.122 MHz.
- 3) Modulated sine and square wave audio frequencies onto the sine wave carrier frequency.
- 4) Power usage was about 460 watts. Output to the ray tube about 50 to 60 watts.

John Marsh built this ray tube instrument model # JLMSQ-1A back in the early 1970s. He and John Crane were under court order not to associate with each other. Because of this they went their separate ways but communicated through phone calls and letters often. John Crane stayed in California and John Marsh went to Colorado but eventually settled back in SLC, Utah until his death in 1985. All of his Rife instruments and Rife information were given to his nurse at his death. She allowed us to take photos of this instrument of his. We wish to thank her for allowing us to do this.

The photo below shows the two chassis that were connected by wires. This instrument was a mix of both tube technology and modern solid state components. John Marsh's nurse also allowed us





to examine the boxes that make up the instrument inside and out. In the photo above you can see that the instrument could use both sine and square wave audio frequencies. The frequency range of the audio oscillator went from 20 hertz to 20,000 hertz over three bands. It had coarse and fine adjustments for the audio frequencies. Above those knobs we see the digital readout of the frequencies. John Marsh put in a modern solid state audio oscillator with a digital readout. To the right of the digital readout we see a timer with a range of up to 5 minutes. To the right of that timer we see the power meter which said on it "Standing wave ratio" and "Percent reflected power". The knob below the meter was for adjusting the standing wave ratio. Below the knob is where the ray tube was connected. He used the CB antenna style instead of the banana jack method. In the upper left hand corner of the photo you can still see the masking tape with the 1950's frequencies written on it. In the photo, below on the left, you can see the instrument with a ray tube connected to it. This photo was taken by John Marsh back in the 1970s. The other photo is a close up of the ray tube that was used with the instrument.

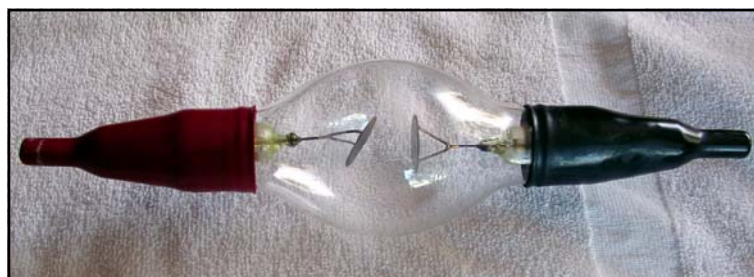

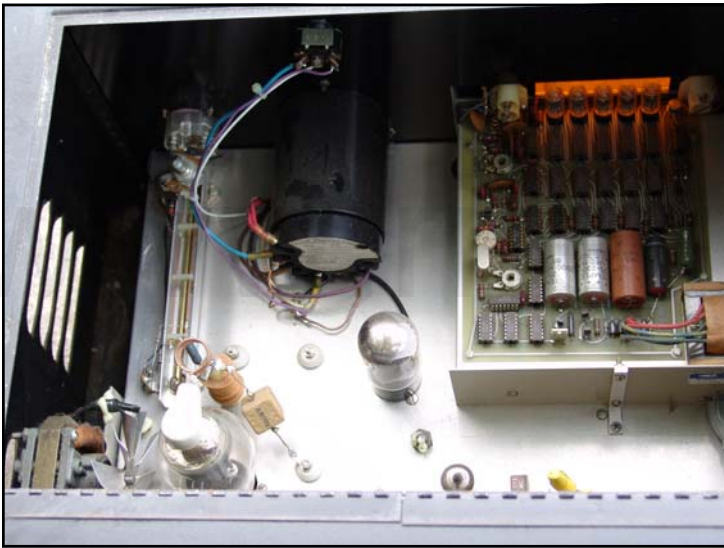

The top photo, above and on the left, is looking at the front of the instrument. The top photo, above right, looking at the back of the instrument. The top photo, above left, shows the solid state audio oscillator. To the left of the audio oscillator is the 5 minute timer. The second photo above, bottom left, shows the underside of the chassis where you can see the RF tank coil that was fixed at 4.122 MHz. The three photos of vacuum tubes, above on the right, shows a clear view of the 811a, 6L6GC and 6GK6 vacuum tubes and their placement into the chassis.

The photo, below on the left, shows a side view of the audio oscillator. The photo, below on the right shows a side view of the 811a tube. You can also see the RF choke right in front of the 811a tube.

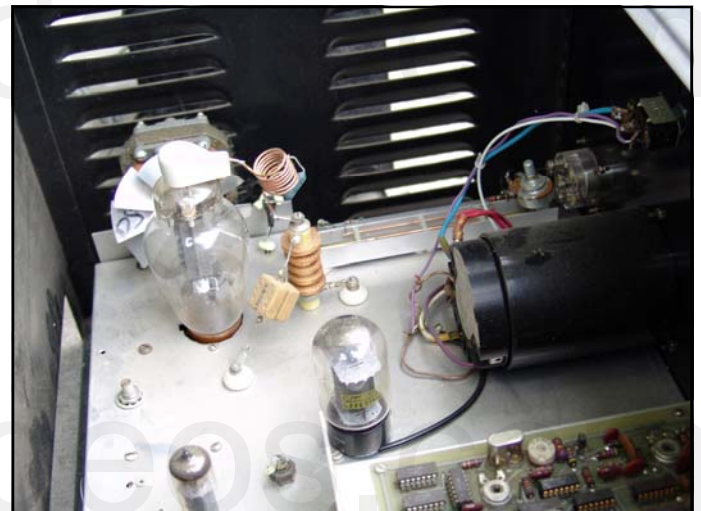
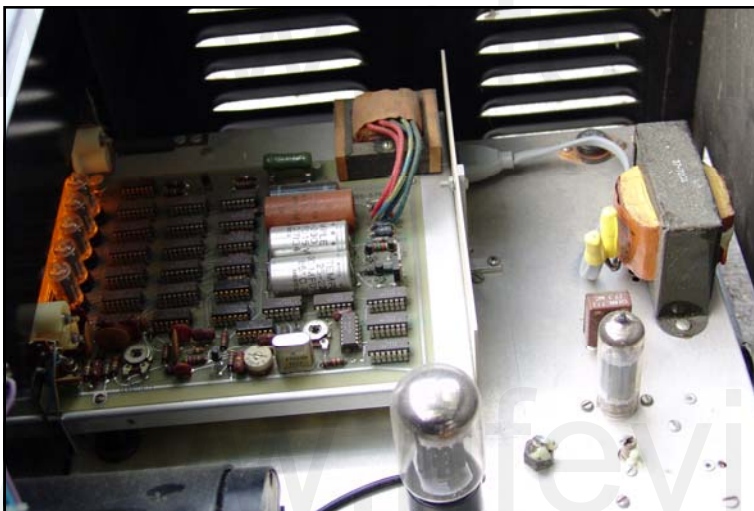



The two photos above are of the inside of the small case. It contained almost all the transformers. The standard Beam Rays instrument had two shelves in one case for components. The AZ-58 combined everything into one case but for some reason John Marsh used two cases to hold the components.

In conclusion this instrument like the AZ-58 was a more modern replica version of the original Beam Rays Clinical instrument. The carrier frequency that John Marsh chose to use with this instrument clearly shows he did not understand the importance of the carrier frequency. He changed it from the AZ-58's 4.68 MHz to 4.122 MHz. The 4.122 MHz carrier frequency is probably one of the worst carrier frequencies he could have chosen using the AZ-58 low audio frequencies for the sideband method. The only reason you would use this carrier frequency is if you did not care what it was. This is without question since both John Marsh and John Crane have said in several documents and on audio tapes that the audio frequencies were the M.O.R. frequencies. The whole concept of using the sideband spacing method is to choose a carrier frequency that would work the best with all of the Rife Ray #4 frequency harmonics. Had John Marsh really understood the significance of the carrier frequency he would have chosen a different one. But just like the AZ-58 they changed it and relied on the square wave audio frequency harmonics rather than the sideband spacing method used in the original Beam Rays Clinical instrument. The Aubrey Scoon's Beam Rays Clinical instrument replica was working on the side band spacing method because the audio frequencies used with it were high enough to make the number of sideband harmonics reasonably low. So far this is the only instrument that we have seen, except for the original Beam Rays Clinical instrument, that worked on the sideband space method. It is clear that the AZ-58 was not working fully on the sideband principle. It appears that just by chance or accident some of the frequencies, like the BX frequency, worked because the carrier frequency was set at about 3.2 MHz by Dr. Stafford. Just the fact that they lowered the audio frequencies by a factor of 10 and then depended solely on square wave audio frequencies showed they didn't understand Philip Hoyland's instrument. Had Philip Hoyland revealed how his Beam Rays Clinical instrument worked a lot of confusion could have been avoided.

In the chart on the next page the frequencies have been calculated for John Marsh's instrument. You will notice that the "Original 1950s AZ-58 Frequencies" are almost a perfect match to the "Correct Sideband Frequencies." But before we place too much significance in this coincidence we need to keep in mind the "Number of Sideband Harmonics." These numbers are so high that almost any low frequency can be divided into the "Carrier Difference Frequency" and come out within a few hertz of the "Correct Sideband Frequency." If you look at the "Number of Sideband Harmonics" it takes to hit the correct Rife Ray #4 "Higher Harmonic Frequencies" you will understand that this instrument could never work on the sideband spacing method using these low audio frequencies. None of the "Number of Sideband Harmonics" are less than 59 sideband steps and the highest is 750. The chance of this working would be almost zero. The best method to use with John Marsh's instrument is the audio frequency square wave harmonic method. This is the primary method he used with his instrument.

**John Marsh's Beam Rays Clinical Instrument Sideband
Square Wave Audio Frequencies Based On A 4.122 MHz Carrier**

Organism	Rife Ray #4 Frequencies	Higher Harmonic Frequencies	*Carrier Difference Frequency	1/10 Of A Meter Freq.	Number of Sideband Harmonics	Original 1950s AZ-58 Frequencies	Correct Sideband Frequencies
Actinomycosis or Streptothrix	192,000 Hz	4,032,000 or 21st	90,000 Hz	12 Hz	115	784 Hz	782 Hz
Anthrax	139,200 Hz	4,176,000 or 30th	54,000 Hz	6 Hz	87		621 Hz
B or E Coli Rod	417,000 Hz	4,170,000 or 10th	48,000 Hz	58 Hz	60	800 Hz	800 Hz
B or E Coli Virus	770,000 Hz	3,850,000 or 5th	272,000 Hz	198 Hz	175	1552 Hz	1554 Hz
BX Virus Carcinoma	1,604,000 Hz	4,812,000 or 3rd	690,000 Hz	858 Hz	324	2128 Hz	2129 Hz
BY Sarcoma	?1,530,000 Hz	4,590,000 or 3rd	480,000 Hz	780 Hz	239	2008 Hz	2008 Hz
Gonorrhea	233,000 Hz	4,194,000 or 18th	72,000 Hz	18 Hz	101	712 Hz	713 Hz
Pneumonia or Spinal Meningitis	427,000 Hz	4,270,000 or 10th	148,000 Hz	61 Hz	148	776 Hz	1000 Hz
Staphylococcus Pyogenes Aureus	478,000 Hz	4,302,000 or 10th	180,000 Hz	76 Hz	247	727 Hz	728 Hz
Streptococcus Pyogenes	720,000 Hz	4,320,000 or 6th	360,000 Hz	173 Hz	409	880 Hz	880 Hz
Syphilis	789,000 Hz	3,945,000 or 5th	177,000 Hz	207 Hz	268	660Hz	660 Hz
Tetanus	234,000 Hz	4,212,000 18th	90,000 Hz	18 Hz	750	120 Hz	120 Hz
Tuberculosis Rod	369,000 Hz	4,059,000 or 11th	63,000 Hz	45 Hz	78	803 Hz	808 Hz
Tuberculosis Virus	?769,000 Hz	3,845,000 or 5th	277,000 Hz	197 Hz	178	1552 Hz	1556 Hz
Typhoid Rod	760,000 Hz	3,800,000 or 5th	322,000 Hz	192 Hz	452	712 Hz	712 Hz
Typhoid Virus	1,445,000 Hz	4,335,000 or 3rd	213,000 Hz	694 Hz	114	1862 Hz	1868 Hz

Below in the chart is a list of the higher audio frequencies, 40,000 hertz or below, that could be used with John Marsh's instrument and make it work using the harmonic sideband method. Many different audio frequencies could be calculated to work.

**John Marsh's Beam Rays Clinical Instrument Higher Sideband
Square Wave Audio Frequencies Based On A 4.122 MHz Carrier**

Anthrax	13,500 Hz	Streptococcus	36,000 Hz
B or E Coli Rod	12,000 Hz	Streptothrix	15,000 Hz
B or E Coli Virus	27,200 Hz	Syphilis or Treponema	22,125 Hz
BX Virus Carcinoma	38,333 Hz	Tetanus	18,000 Hz
BY Sarcoma	?39,000 Hz	Tuberculosis Rod	15,750 Hz
Gonorrhea	14,400 Hz	Tuberculosis Virus	? 27,700 Hz
Pneumonia or Spinal Meningitis	29,600 Hz	Typhoid Rod	32,200 Hz
Staphylococcus	22,500 Hz	Typhoid Virus	35,500 Hz

John Marsh's 1980s Ray tube instrument



- 1) Used a ray tube.
- 2) Carrier frequency was ?.
- 3) Square wave audio frequencies modulated onto a sine wave carrier frequency.
- 4) Power usage was about 125 watts. Output to the ray tube about 25 to 30 watts.

This style of instrument was the last ray tube instrument design that John Marsh built before his death. He built two different models shown below in the photos. His nurse has the instrument shown in the above photo with John Marsh, and it is still working. The instrument that she has uses the same square wave low audio frequencies that were used in the 1950s AZ-58. John Marsh had them built using a vacuum tube for the RF carrier frequency. The audio frequencies in the instrument with the dial were crystal controlled and the dial had 13 different positions for the 13 audio frequencies that he used. The other instrument had a solid state variable audio oscillator with a digital readout for displaying the frequencies.



The ray tube used with the instrument John Marsh's nurse has is of an interesting design. The fact that this instrument is still being used even after about thirty years speaks of its quality construction. Below are some current photos of the front and back of this instrument.



John Marsh also built many pad instruments through the years. Below are three photos of some that he built. He strongly believed in both types of instruments and mostly promoted the pad style instrument because almost anyone could afford to purchase one. Most people who know about John Crane had no idea that John Marsh was still actively promoting Dr. Rife and his work.



Summary

In summary, with all the historical information that has come to light in the past few years we finally know the truth about which frequencies were Dr. Rife's M.O.R.s. We also understand the audio frequency sideband spacing method used in the Beam Rays Clinical instrument to hit the high frequency harmonics of the true M.O.R.s. Because Philip Hoyland hid how his instrument worked these audio frequencies, due to lack of knowledge, were lowered and used square wave and have accomplished a lot of good helping many people. With the use of even more square wave audio frequencies a whole new field of frequencies are now available for our use. Having said this, we still need to remember Dr. Rife still maintained his true M.O.R. frequencies were in the RF band of frequencies. Even though Dr. Rife, John Crane and John Marsh tested these square wave audio instruments in the 1950's and early 1960's to see how well they would work, it wasn't until after John Crane and John Marsh were released from prison that they received Dr. Stafford's report showing the failure of audio frequencies on cancer.

From about 1964 on, John Crane and John Marsh continued to build the audio frequency instruments even though they had the evidence from Dr. Stafford which showed the audio frequencies alone didn't work on cancer like the original high RF frequencies. Even though John Crane and John Marsh said the square wave audio frequencies were Dr. Rife's true M.O.R.s does not change the fact that we now know the true purpose of the audio frequencies. It is apparent that Dr. Rife, John Crane and John Marsh really didn't understand how Philip Hoyland's Beam Rays Clinical instrument worked. This lack of understanding caused them to miss the truth when it was right before their eyes. We would still be in the dark had it not been for the original instruments and written documents that revealed Dr. Rife's high frequencies. Add to this the audio tapes which have Dr. Rife's own voice on them telling us his frequencies ranged from the audio to the broadcast bands. Dr. Rife was a pure scientist and only believed what he could prove. Had he seen Dr. Stafford's final report I am certain he would have considered the cancer tests a failure. Dr. Rife said "he never fooled himself". It is entirely possible that Dr. Rife would have insisted they go back to his original high frequency design used in the Rife Ray #4.

The most important information that has been obtained from the original Beam Rays Clinical instrument and Aubrey Scoon's Beam Rays replica instrument is the fact that the audio frequencies used in these instruments had nothing to do with the treatment of disease. To put it bluntly, all of us have been led down the primrose path because we did not understand how the Beam Rays Clinical instrument worked. The mistakes made have major implications since the audio frequencies used with the AZ-58 (**120, 660,712, 727, 776, 784, 800, 803, 880, 1552, 1862, 2008 and 2128 hertz**) have no ability to eliminate the diseases we thought they would eliminate. In all reality these audio frequencies should be replaced with audio frequencies that are true harmonics of Dr. Rife's original high frequency M.O.R.s instead of clinging to the old dogma. Those who are really trying to do what Dr. Rife did should no longer promote the concept that these AZ-58 audio frequencies are M.O.R.s and by so doing put many people at risk. The best frequencies to use would always be the original high frequency M.O.R.s followed by lower audio frequencies that are exact lower harmonics of the high RF frequencies. For the most accurate list of Dr. Rife's original high RF frequencies go to the chart on page 73 and read the column labeled "Rife Ray #4 Frequencies Based On Scoon's Audio Frequencies." These frequencies were set by Philip Hoyland in Dr. Rife's lab using his microscope.

Hopefully this information will help make a change and in the future we will begin to see what Dr. Rife's original high frequency M.O.R.s will do. Many helpful sources have provided the records and resources so this new information could be brought to light: the release of the John Marsh information from John Marsh's nurse; the Beam Rays Trial Papers from Steven Ross; the many photos from Jason Ringas of the Rife Research Group of Canada; the great benefit from Dr. Larry Low who allowed us to purchase the original Beam Rays Clinical instrument; the British Rife group and their work on the Aubrey Scoon replica instrument; the help of James Cunningham along with the great detective work done by James Peters in figuring out that Dr. Rife was using the Kennedy company Model 110, 220 and 281 receivers. We also want to recognize the great work Jim Peters did on the schematic of Dr. Gruners original Beam Rays Laboratory instrument. His recognition of the second variable Hartley Os-

cillator made it possible to rebuild the original Beam Rays Laboratory instrument. The spectrum analyzing of these machines has finally given us the answers to how all these different instruments really worked. I believe the recognition of the Kennedy equipment and the locating of the 1930's Beam Rays Clinical instrument along with the Beam Rays Laboratory instrument schematic correction and rebuilding are three of the greatest pieces of information we have yet discovered about Dr. Rife. No longer are we guessing in the dark. We have purchased the Kennedy Company equipment Models 110, 220 and 281 along with the original Beam Rays Clinical instrument. We plan on doing more extensive spectrum analysis work on this equipment. We have built, into one case, the Beam Rays Clinical and Laboratory instrument designs. We wish also to give special thanks to Henry Rogers the owner of the Western Historic Radio Museum (www.radioblvd.com). He allowed us the opportunity to come and test the Kennedy receivers that he owns. As more information comes out we will update this article as necessary.

For those who would like a complete list of Dr. Rife's frequencies output by the Kennedy equipment, Rife Ray #4, Philip Hoyland Beam Rays Clinical instrument, Aubrey Scoon's 1940s Beam Rays replica and the AZ-58 Beam Rays replica instruments we have listed them on page 111. The corrected frequencies that Philip Hoyland read off of the Kennedy equipment were all transferred to and used by the Rife Ray #4. None of the sets of the low audio frequencies are true M.O.R.s and were originally used to create the proper sideband spacing frequencies. The square wave audio frequencies used by the AZ-58 were used in a different manor or method relying only upon the harmonics from the square wave waveform. This method has been used with very good results over the past 50 years by many people, but, these audio frequencies have never produced the true M.O.R. effect of devitalizing organisms. The correct high RF M.O.R.s are the frequencies that should be used since we know what these frequencies are. If people are determined to use the lower audio and ultrasonic range of frequencies below 50,000 hertz then they should at least use the highest harmonic frequency of the true M.O.R. that they can use within the limits of the equipment they are using. At the very least we should make sure that all frequencies used are true harmonics of the fundamental M.O.R.s that Dr. Rife found.

www.rifevideos.com
Copyright © 2003 & 2010
All rights reserved.

Rife's M.O.R Frequencies And Audio Sideband Frequencies

Microorganisms From Rife's Lab Notes And Other Documents.	Square Wave Frequencies for Rife, Crane, Marsh 1950s AZ-58 Beam Rays Replica. Built by Verne Thompson.	Sideband Frequencies For Audrey Scoon's 1940s Beam Rays Replica. Built by Verne Thompson. Used with 3.3 MHz	Sideband Frequencies For Original Beam Rays Clinical Instrument. Built By Phillip Hoyland 1938-1939. Recovered in 2008. Used with 3.8 MHz	High RF Frequencies For Dr. Rife's Rife Ray #3 and #4 Instruments. Correctly read in 1935 By Phillip Hoyland*. Rife Ray # 4 built by*.	1/10th Of One Meter Frequency Tolerance.	Rife's Mistread Lab Note Frequencies Before 1935. Frequency #1	Rife's Mistread Lab Note Meter Frequencies Before 1935. Meters	Rife's Mistread Lab Note Meters Converted To Hertz. Frequency #2
Actinomyces or Streptothrix	Square Wave 784 Hz	Sine Wave 7,870 Hz	Sine Wave 10,000 Hz	Sine Wave 192,000 Hz	12 Hz	Sine Wave 678,000 Hz	Sine Wave 1,607 M	Sine Wave 186,554 Hz
Anthrax			8,320 Hz	139,200 Hz	6 Hz	900,000 Hz	1,100 M	272,539 Hz
Anthrax Symptomatic						400,000 Hz	18,000 M	16,655 Hz
B or E Coil Rod	800 Hz	8,020 Hz	7,833 Hz	417,000 Hz	58 Hz	683,000 Hz	943 M	317,914 Hz
B or E Coil Virus	1,552 Hz	17,220 Hz	16,667 Hz	770,000 Hz	198 Hz	8,581,000 Hz	27 M	11,103,424 Hz
BX Virus Carcinoma	2,128 Hz	21,275 Hz	39,467 Hz	1,604,000 Hz	858 Hz	11,780,000 Hz	17.6 M	17,033,662 Hz
BY Sarcoma	2,008 Hz	20,080 Hz	37,000 Hz	? 1,530,000 Hz	780 Hz			
Bubonic Plague						160,000 Hz	585 M	512,466 Hz
Catarrh						1,800,000 Hz	175 M	1,713,100 Hz
Cholera Spirillum						851,000 Hz	312 M	960,873 Hz
Contagious Conjunctivitis						1,206,000 Hz	148 M	2,025,625 Hz
Diphtheria						800,000 Hz	275 M	1,090,154 Hz
Glanders						986,000 Hz	407 M	736,591 Hz
Gonorrhea	712 Hz		14,400 Hz	233,000 Hz	18 Hz	600,000 Hz	1,990 M	150,649 Hz
Influenza						1,674,000 Hz	154 M	1,946,704 Hz
Leprosy						743,000 Hz	1,190 M	251,926 Hz
Pneumonia						1,200,000 Hz	785 M	381,901 Hz
Pneumonia or Spinal Meningitis	776 Hz	7,660 Hz	8,600 Hz	427,000 Hz	61 Hz	927,740 Hz	167 M	1,795,164 Hz
Staphylococcus Pyogenes Aureus	727 Hz	7,270 Hz	8,000 Hz	478,000 Hz	76 Hz	988,740 Hz	540 M	555,171 Hz
Staphylococcus Pyogenes Albus							546 M	549,070 Hz
Streptococcus Pyogenes	880 Hz	8,450 Hz	8,333 Hz	720,000 Hz	173 Hz	1,214,000 Hz	142 M	2,111,214 Hz
Syphilis (Treponema Pallidum)	660 Hz	6,600 Hz	6,591 Hz	789,000 Hz	207 Hz	900,000 Hz	108 M	2,775,856 Hz
Tetanus	120 Hz	1,200 Hz	11,200 Hz	234,000 Hz	18 Hz	700,000 Hz	19,000 M	15,779 Hz
Tuberculosis Rod	803 Hz	8,300 Hz	8,462 Hz	369,000 Hz	45 Hz	583,000 Hz	554 M	541,142 Hz
Tuberculosis Virus	1,552 Hz	16,000 Hz	16,910 Hz	? 769,000 Hz	197 Hz			
Typhoid Rod	712 Hz	6,900 Hz	100 Hz	760,000 Hz	192 Hz	900,000 Hz	345 M	868,964 Hz
Typhoid Virus	1,862 Hz	18,620 Hz	38,214 Hz	1,445,000 Hz	694 Hz	9,680,000 Hz	21.5 M	13,943,835 Hz
Worms		2,400 Hz						