

Department of Justice
Federal Bureau of Investigation

Prosecutive Report

John Warnock Hinckley, Jr.
Attempted Assassination of
Ronald Reagan,
President of the United States
March 30, 1981



Volume 1

Copy to:

United States Attorney, Charles F. C. Ruff

Report of:
Date:SA [REDACTED]
May 1, 1981

Office: Washington Field Office (b)(7)(c)

Field Office File #:

175-311

Bureau File #:

175-601

Narrative of Offense:

At approximately 1:45 p.m., Monday, March 30, 1981, President Ronald W. Reagan departed the White House enroute to the Washington Hilton Hotel, 1919 Connecticut Avenue, N.W., where he was scheduled to deliver a speech to an assembly of AFL-CIO union members. The President arrived at the Hilton at 1:50 p.m., and began his speech to the union members at approximately 2:00 p.m. The President's speech concluded at approximately 2:20 p.m., and the President prepared to exit the hotel. Among others in his official party were Press Secretary James Brady and United States Secret Service Agent Timothy McCarthy, who was part of the Presidential Protective detail. Police Officer Thomas Delahanty was assigned outside of the hotel near the VIP entrance.

John Warnock Hinckley, Jr., date of birth May 29, 1955, at Ardmore, Oklahoma, home address of [REDACTED] Evergreen, Colorado, arrived in Washington via Greyhound Bus at 12:15 p.m., Sunday, March 29, 1981. He had purchased his bus ticket to Washington, D. C. on March 26, 1981, at Hollywood, California, paying \$117.80 in cash. (b)(7)(c)

After arriving in Washington, D. C., Hinckley registered at the Park Central Hotel, Washington, D. C., at 1:00 p.m. He paid \$47.00 in cash for one night. Later, Sunday afternoon, Hinckley was observed near the fence of the South Lawn of the White House. Hinckley was alone and asked several tourists if the President was in the White House that weekend and inquired where somebody could go to see the President. He was told that the front of the White House was possibly a better location to see the President.

On Monday morning, March 30, 1981, Hinckley, at approximately 8:00 a.m., had breakfast alone at a Washington, D. C. sandwich shop. The maid at the Park Central Hotel saw Hinckley in his hotel room at approximately 1:00 p.m.

TABLE OF CONTENTS

	<u>PAGE</u>
Narrative of Offense	B
Crime Scene Map	C
Subject (descriptive data)	D
Photograph of subject	E
Prosecutive action	F
Overview of investigation conducted to date	G
Evidence	H
General Index	I
Section I Crime Scene, Washington Hilton Hotel	1
Section II George Washington University Hospital Washington Hospital Center	475
Section III Park Central Hotel, Washington, D. C.	551
Section IV Interview of Victims	608
Section V FBI Laboratory and Latent Fingerprint Reports	619
Section VI Subject's Travel and Associated Activities	690
Section VII Subject's Associates and Organizations	865
Section VIII Subject's Financial Status	889
Section IX Subject's Family Background	912
Section X Subject's Medical History	932
Section XI Purchase and Possession of Weapons	941
Section XII Subject's Character and Personality	984
Section XIII Arrest and Interview of John Warnock Hinckley, Jr.	1028

APPENDICES

- APPENDIX A. Photographs - Laboratory
- APPENDIX B. Photographs - Witnesses
- APPENDIX C. Photographs - Crime Scene
- APPENDIX D. Photographs - Park Central Hotel
- APPENDIX E. Photographs - Miscellaneous
- APPENDIX F. Writings of Subject

At 1:50 p.m., Hinckley was observed standing in a crowd behind a rope barrier near a retaining wall a short distance from the VIP entrance to the Washington Hilton Hotel.

At 2:25 p.m., the President exited the Washington Hilton Hotel through the VIP entrance and walked to his limousine, which was parked approximately 50 feet from the entrance. Slightly ahead of the President and to his left, were, in addition to others, Secret Service Agent McCarthy, Press Secretary Brady, and Washington, D. C. Police Officer Delahanty. As the President approached the right front fender of his limousine, six shots from a handgun were fired in rapid succession from the area to the front and left of the President behind the rope barrier near the retaining wall. President Reagan was struck in the left chest area by a bullet that ricocheted off of the right rear quarter panel of his limousine. Press Secretary Brady was struck by a bullet that entered his brain above his left eye. Secret Service Agent McCarthy was hit in the abdomen by one round, and one round hit Officer Delahanty in the neck. One round passed over the limousine and through a glass window of a nearby building, and one round struck the right rear glass window of the limousine. The six shots were fired in 1.7 seconds at a distance of approximately 15 feet from the President.

John Hinckley was immediately subdued by Secret Service Agents and officers of the Metropolitan and Park Police Departments. A .22 caliber revolver with six spent casings was dropped to the ground by Hinckley. This weapon had been purchased by Hinckley October 13, 1980, in Dallas, Texas.

Following the shooting, President Reagan was taken by limousine to the George Washington University Hospital. Brady and McCarthy were transported by ambulance to George Washington University Hospital and Delahanty was taken by ambulance to the Washington Hospital Center.

Hinckley was taken in a police cruiser to the Metropolitan Police Department, where he was turned over to the FBI and charged with the attempted assassination of the President (Title 18, U. S. Code, Section 1751 (c)) and assault on a Secret Service Agent (Title 18, U. S. Code, Section 111).

WASHINGTON HILTON HOTEL
 CONNEMOUTH AVE. AND "T" STREET
 WASHINGTON, D.C.

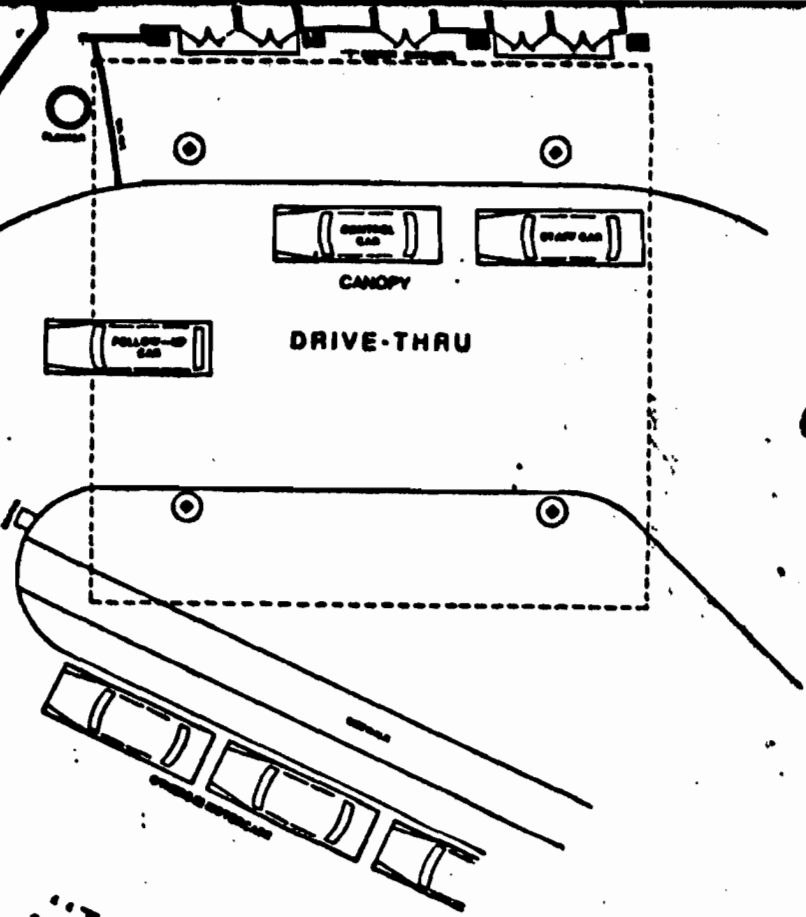
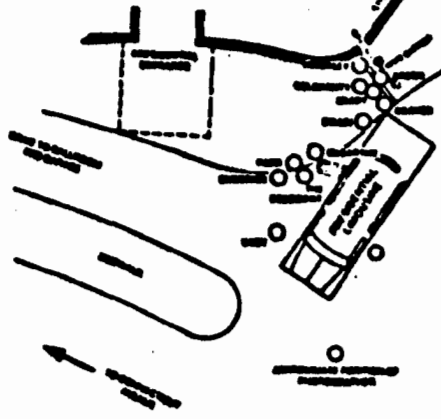

"T" STREET

PLAZA

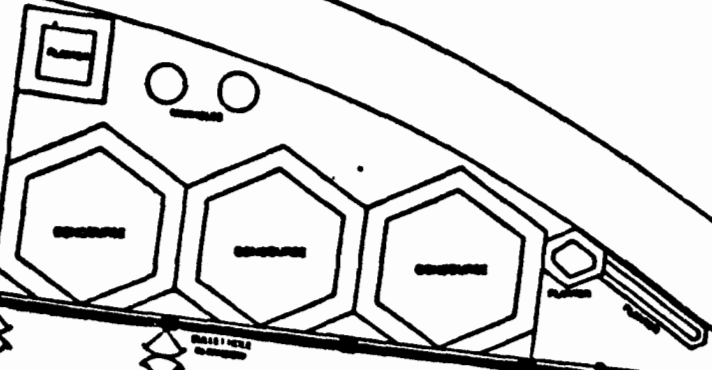

VESTIBULE

UNIVERSAL BUILDING

APPROXIMATE POSITIONS OF
 PERSONS AND VEHICLES
 AT TIME OF SHOOTING
 (AS INDICATED IN PHOTOGRAPH TAKEN
 FROM A POINT IN FRONT OF THE
 PRESIDENTIAL LIMOUSINE)

175-311

(b)(7)(c)

Automobile:

1977 Plymouth Volare,
Current Texas License,
PWN 998, stored at his
parent's residence

Education:

Highland Park High School
(Graduated in 1973, Dallas,
Texas); Completed 3 years
college at Texas Tech
University where major areas
of study were Business and
English, last semester was
Fall, 1979

Previous Arrest:

October, 1980 - Nashville,
Tennessee, for carrying
concealed weapon - fined
\$62.50 and lost custody of
.22 caliber handgun

Employment:

Taylor Publishing Company,
Dallas, Texas (June, 1978
to August, 1978); Ellis
Photography, Los Angeles,
California, Sunset Boulevard,
Hollywood, California (Sales)
(June, 1975 to September 1976);
Taylor Supper Club, Colfax,
Denver, Supervisor [REDACTED]
(Bartender) (October, 1976 to
February, 1977)

Banks:

[REDACTED]

John W. Hinckley, Jr.
Descriptive Data

Name: John Warnock Hinckley, Jr.
Sex: Male
Race: White
Date of Birth: May 29, 1955 (b)(7)(c)
Place of Birth: Ardmore, Oklahoma
Height: 5'10"
Weight: 173 pounds
Hair: Sandy blonde with sideburns
Eyes: Blue
Social Security Number: [REDACTED]
Father: John Warnock Hinckley
[REDACTED]
Father's Employment: Owner - Vanderbilt Energy Corporation, Denver, Colorado
Mother: JoAnne Hinckley
[REDACTED]
Residence: [REDACTED]
Telephone Number: [REDACTED]
Previous Residences: 409 University Avenue,
Lubbock, Texas #765-0908;
2404 10th Street,
Lubbock, Texas;
1612 Avenue "Y",
Lubbock, Texas (Summer, 1980)
Brother: Scott Hinckley
[REDACTED]
Sister: Diane Sims
[REDACTED]
Friends: None
Marital Status: Single
Military Service: None

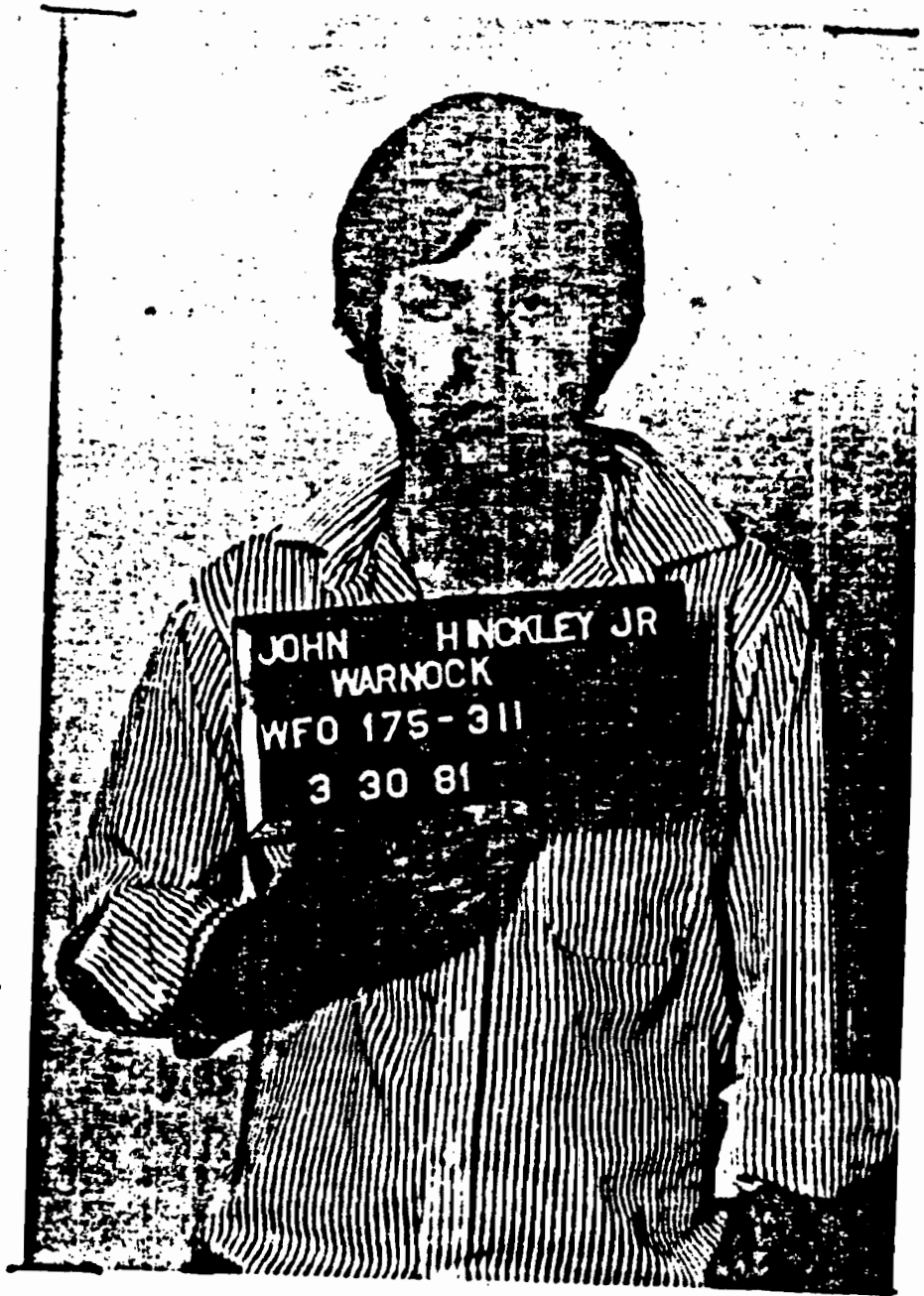

JOHN HINCKLEY JR
WARNOCK
WFO 175-311
3 30 81

PROSECUTIVE ACTION

1. Contact with U.S. Attorney

a. United States Attorney contact regarding the arrest of John W. Hinckley, 3/30/81.

(b)(7)(c):(F)

Immediately following the attempted assassination of President Ronald Reagan at 2:25 p.m., 3/30/81, at the Washington Hilton Hotel, 1919 Connecticut Avenue, N.W., Washington, D.C. (WDC), John Warnock Hinckley, white male, date of birth 5/29/55, was subdued by agents of the U.S. Secret Service and officers of the WDC Metropolitan Police Department (MPD). He was transported in a MPD police cruiser to the MPD Headquarters, Central Cell Block, 300 Indiana Avenue, N.W., WDC. Present in the cruiser during trip to police headquarters were Hinckley, MPD Officer [REDACTED] and Secret Service (SS) Agents [REDACTED], [REDACTED] and [REDACTED]. At Central Cell Block, Hinckley was searched and verbally advised of his Constitutional Rights by Agents [REDACTED] and witnessed by [REDACTED] and [REDACTED]. After processing in Central Cell Block, Hinckley was taken upstairs to MPD Homicide Squad. He was advised of his rights by MPD Officer [REDACTED] and Hinckley signed an MPD Warning and Waiver Form at 3:10 p.m. Hinckley was not interviewed at this time but was placed in a holding cell. SS advised MPD not to talk to or touch subject.

At approximately 2:30 p.m., 3/30/81, Assistant United States Attorney (AUSA) Roger Adelman and Thomas Roberts, U.S. Attorney's Office, WDC, arrived at MPD Headquarters. Adelman had been advised of the assassination attempt through a telephone call at approximately 2:30 p.m., from Detective [REDACTED] MPD. Shortly thereafter, AUSA Donald Campbell arrived at police headquarters. U.S. Attorney Charles F.C. Ruff upon being advised by MPD of the assassination attempt had dispatched these Assistant U.S. Attorneys to MPD Headquarters.

At 4:48 p.m., 3/30/81, Hinckley was turned over to custody of FBI, Washington Field Office (WFO) agents. At this time AUSAs Campbell and Adelman verbally authorized the FBI to formally arrest Hinckley for violation of Title 18, U.S. Code, Section 1751 (c), attempting to kill the President of the U.S. and for violation of Title 18, U.S. Code, Section 111, assault of Timothy McCarthy, Special Agent, USSS. At this time Hinckley was advised of these charges by Special Agents [REDACTED] and [REDACTED] WFO, FBI.

At 5:18 p.m., Hinckley was transported to WFO, FBI, where processing and interview took place. AUSAs Campbell, Adelman and Roberts accompanied Hinckley to FBI, WFO. During the time Hinckley was at WFO, AUSA Adelman arranged for Dr. [REDACTED] to come to WFO and examine Hinckley per Hinckley's request.

They also discussed with FBI agents Hinckley's request for a lawyer and telephonic contact was made with Attorney Joe Bates, Dallas, Texas, who recommended Attorney Vincent Fuller of the WDC law firm of Williams and Connley. AUSA Adelman also advised FBI that two court appointed attorneys, Edward Wilhite and Stewart Johnson had been appointed and would be arriving at WFO to consult with Hinckley. WFO interview with Hinckley terminated at 9:27 p.m. and Hinckley transported to U.S. Marshal, Central Cell Block at 10:28 p.m.

b. US Attorney Contact regarding search of Room 312, Park Central Hotel, Washington, D.C. (WDC), 3/10/81.

The following is a synopsis of the events that led to the request, procurement, service and return of a search warrant obtained from United States (US) Magistrate Arthur L. Burnett for Room 312 of the Park Central Hotel located at 705 18th Street, N.W., Washington, D.C. (WDC).

(b)(7)(c)

At approximately 5:45 p.m. on 3/30/81, SA [REDACTED] FBI, WFO, was advised by SA [REDACTED] that a search warrant would have to be obtained for Room 312 of the Park Central Hotel, the room occupied by Hinckley prior to his assault on the President. SA [REDACTED] advised that the preparation of the affidavit in support of the search warrant for Room 312 of the Park Central Hotel was to be coordinated with Assistant United States Attorney (AUSA) E. Lawrence Barcella and other AUSA's of the US Attorney's Office, US District Court, WDC. SA [REDACTED] directed SA [REDACTED] to assist AUSA Barcella in obtaining information to establish probable cause for a search of the premises of Room 312 of the Park Central Hotel and to be prepared to be the affiant of the above mentioned warrant.

AUSA Barcella directed SA [REDACTED] to obtain eyewitness information regarding the assault on the President. This information was obtained by SA [REDACTED] from Officer [REDACTED] Third District, Metropolitan Police Department (MPD), WDC, in an interview that took place at Washington Field Office (WFO) with Officer [REDACTED]. [REDACTED] advised SA [REDACTED] that at approximately 2:25 p.m. on 3/30/81, while assisting in the President Protection detail at the Washington Hilton Hotel, located at 1919 Connecticut Avenue, N.W., WDC, he observed the subject, John W. Hinckley, Jr., fire shots in the direction of the President. [REDACTED] also provided information to SA [REDACTED] regarding the recovery of the Hotel Key to Room 312 of the Park Central Hotel.

SA [REDACTED] and SA [REDACTED] FBI, WFO, then departed WFO for the Office of AUSA Barcella. While at the AUSA's Office, additional information that was known by SA [REDACTED] or that had been provided to SA [REDACTED] by other law enforcement officers, including SA's of the FBI, SA's of the United States Secret Service (USSS) and Officers of the MPD, was incorporated into the affidavit in support of the search warrant for Room 312 of the Park Central Hotel. The affidavit was prepared by AUSA Barcella and approved by United States Attorney (USA) Charles F.C. Ruff.

At approximately 9:15 p.m., 3/30/81, SA [REDACTED] and AUSA Paul Murphy presented the above mentioned affidavit in support of the search warrant and the search warrant for Room 312 of the Park Central Hotel to US Magistrate Arthur L. Burnett.

It approximately 9:45 p.m., subsequent to a review of the above (b)(7)(c) mentioned documents by Magistrate Burnett, SA [redacted] swore to the facts presented in the affidavit. Magistrate Burnett signed the affidavit in support of the search warrant and the search warrant for Room 312 of the Park Central Hotel. V

AUSA Paul Murphy telephonically advised WFO of the signing of the search warrant by Magistrate Burnett at which time WFO contacted the Agents located at the Park Central Hotel. SA [redacted] and SA [redacted] then proceeded to the Park Central Hotel with the above mentioned documents.

At approximately 4:15 a.m., 3/31/81, at the conclusion of the search of Room 312, a copy of the above mentioned warrant and a copy of the inventory of items seized was left in Room 312. Later on 3/31/81, SA [redacted] returned the original warrant for Room 312 to Magistrate Burnett along with the original inventory of items seized during the search of Room 312 of the Park Central Hotel.

Copy of Search Warrant attached.

United States District Court

FOR THE

DISTRICT OF COLUMBIA

UNITED STATES OF AMERICA

Docket No. 81

Case No. 0255M
01(a)

vs.

ENTIRE PREMISES, ROOM 312
PARK CENTRAL HOTEL
705 18th STREET, N.W.
WASHINGTON, D.C.
INCLUDING CONTENTS, SUCH AS
LUGGAGE AND ANY AND ALL PERSONAL
ITEMS

SEARCH WARRANT

To

Director of the F.B.I. or any Special Agent of the F.B.I.

Affidavit(s) having been made before me by

Special Agent Thomas E. Bush, III

that he has reason to believe that ~~XXXXXXXXXXXXXXXXXXXX~~
on the premises known as

the Entire Premises, Room 312, Park Central Hotel,
705 18th Street, N.W., including all contents such as
luggage and any and all personal items

Washington in the District of Columbia

there is now known to be certain property, namely
~~XXXXXXXXXXXXXXXXXXXX~~, the Special Agent respectfully requests that this Court authorize a
search warrant for the entire premises of the Park Central Hotel, 705 18th Street,
N.W., Washington, D.C., Room 312, for any and all books, receipts, letters, records,
papers, documents, that relate to: the rental of Room 312 or any other room or rooms
within the metropolitan Washington area; all travel to and within the District of
Columbia; the transportation, purchase, or use of any and all ammunition, firearms
or any other weapons; any and all documents, papers, or items that would identify or
lead to the identity of any and all persons who may have aided or assisted John W.
Winckley, Jr., in the purchase, possession and use of the pistol to shoot the Presi-
dent of the United States or other weapons that may have been obtained to shoot the
President of the United States. Any and all fruits, instrumentalities and evidence
that will disclose the existence of any and all plans to assault the President of the
United States or any other person, that are violations of Title 18 United States Code,
Section 371, 924 et. seq. and 1751.

and as I am satisfied that there is probable cause to believe that the property so described is being
concealed on the person or premises above described and that grounds for application for issuance of the
search warrant exist as stated in the supporting affidavit(s).

You are hereby commanded to search within a period of 2 hours
(not to exceed 10 days) the person or place named for the property specified, serving this warrant
and making the search ~~XXXXXXXXXXXXXXXXXXXX~~ and if the property be found
there to seize it, leaving a copy of this warrant and receipt for the property taken, and prepare a written
inventory of the property seized and promptly return this warrant and bring the property before
Thomas E. Bush, III as required by law.

Dated this 13 day of MARCH 1968

[Signature]
THOMAS E. BUSH, III
SPECIAL AGENT IN CHARGE

*The Federal Bureau of Criminal Investigation prescribes: "The warrant shall be served in the daytime, unless otherwise ordered by the court. It shall be returned to the court at once after the search is completed. A copy of the warrant and the return shall be made to the affiant(s) if a search is to be conducted "at any time day or night" pursuant to Rule 41(c)."

RETURN

I received the attached search warrant MARCH 30, 1981, and have executed it as follows:

On MARCH 30, 1981 at 9:53 o'clock P.M., I searched the person or premises described in the warrant and

I left a copy of the warrant with Park Central Hotel, RM. 312, 705 18th St. O.W. W.O.
name of person searched or owner or "of the place of search"
together with a receipt for the items seized.

The following is an inventory of property taken pursuant to the warrant:

"SEE ATTACHED ¹⁷ PAGES."

This inventory was made in the presence of SA DAVID A. HARVILAK
SA JAMES W. SAMOIS and SA JOHN W. MEIECK

I swear that this inventory is a true and detailed account of all the property taken by me on the warrant.

Subscribed and sworn to and returned before me this _____ day of _____, 19 _____

Federal Magistrate

c. Contact with United States Attorney subsequent to 3/30/81

3/31/81

United States Attorney (USA) Charles F.C. Ruff, and Assistant USA's E. Lawrence Barcella and Roger Adelman, met with SA [REDACTED] at the USA's Office, Washington, D.C. (WDC), to discuss status of investigation. Immediate concern was to establish that John Hinckley acted alone in his attempt to assassinate President Reagan. Administrative procedures for issuing subpoenas and protection of evidence were discussed. General thrust of investigative procedure and direction was agreed upon.

(b)(7)(c)XF

4/1/81

USA Ruff and AUSA Robert Ogram, Reggie Walton, and Adelman met in USA's Office with FBI SA's [REDACTED] and [REDACTED] and Secret Service Agent [REDACTED] and reviewed network video tapes of assassination attempt and discussed preliminary hearing to be held 4/2/81.

4/2/81

Prior to preliminary hearing USA Ruff and AUSA's Barcella and Adelman met with WFO ASAC Thomas Baker and SA's [REDACTED] and [REDACTED] to discuss testimony at preliminary hearing.

4/4/81

At US Attorney's Office, USA Ruff and AUSA's Adelman and Barcella met with SA [REDACTED] and discussed investigative priorities and status of case to date. The importance of immediate interviews of Hinckley's family and associates was emphasized. SA [REDACTED] advised that day by day travel of Hinckley was being verified for the months immediately proceeding 3/30/81 and that all family members and associates, as they were developed were being interviewed.

4/7/81

AUSA Adelman and SA [REDACTED] met at FBI, WFO and discussed forthcoming psychiatric examinations of Hinckley and the fact that it would take ninety days to complete these examinations. Specific investigative results from Hilton Hotel, George Washington Hospital, Park Central Hotel was reviewed. Overview of investigation conducted by other FBI Field Officials was discussed.

4/8/81 US Attorney Ruff and AUSA Adelman met at WFO with SAC Theodore Gardner, ASAC Baker, and SA [REDACTED] to discuss status of investigation.

4/10/81 AUSA Adelman and SA [REDACTED] met at US Attorney's Office with witness [REDACTED] to discuss [REDACTED] recollection of his bus trip with Hinckley to WDC. Notes of [REDACTED] obtained.

(b)(7)(c)

4/11/81 AUSA Adelman met with SA's [REDACTED] and [REDACTED] at FBIHQ Laboratory to review evidence obtained from search at Hinckley's parent's residence in Evergreen, Colorado.

4/12/81 AUSA Adelman and SA [REDACTED] met at WFO to discuss additional witnesses that needed to be interviewed.

4/13/81 AUSA Adelman met with SA [REDACTED] at FBIHQ Laboratory and reviewed evidence obtained during search at Park Central Hotel, WDC.

4/14/81 AUSA Adelman met at Latent Fingerprint Section, FBIHQ, with SA [REDACTED] and reviewed fingerprint examination conducted on evidence.

4/17/81 USA Ruff, AUSA Adelman met at US Attorney's Office with SA [REDACTED] and discussed subpoenas that had been issued to date. Upcoming Grand Jury presentation was discussed.

4/20/81 SA [REDACTED] appeared before a Federal Grand Jury, WDC.

4/22/81 AUSA Adelman at WFO reviewed motion picture "Taxi."

4/24/81 AUSA Adelman met at WFO with SA [REDACTED] and discussed status of FBI Laboratory examinations. Need for additional witnesses for Grand Jury testimony was discussed.

2. Court Room Proceedings

On 3/30/81, at 10:55 p.m., before U.S. Magistrate Arthur Burnett, Special Agent (SA) [REDACTED] FBI, Washington Field Office (WFO), swore to facts and complaint charging Hinckley with violation Title 18, U.S. Code, Section 1751 (c), assaulting the President. Complaint attached. At the same time U.S. Secret Service (USSS) Agent [REDACTED] swore to facts and complaint charging Hinckley with violation Title 18, U.S. Code, Section 111, assaulting an officer of USSS. Complaint attached. Assistant U.S. Attorney (AUSA) E. Lawrence Barcella, coordinated filing of charges at U.S. District Court, Washington, D.C. (WDC).

(b)(7)(c)

ψ (F)

At 11:52 p.m., 3/30/81, a hearing commenced before U.S. Magistrate Burnett at U.S. District Court, WDC. United States Attorney Charles F.C. Ruff represented the government and two court appointed attorneys Edward Wilhite and Stewart Johnson represented Hinckley. Hinckley was formerly charged with the attempted assassination of President Reagan and an assault on a Federal employee, SS Agent McCarthy. Magistrate Burnett, at the request of the government ordered Hinckley to undergo a psychiatric examination on 3/31/81, and to return for a preliminary hearing 4/2/81. Hinckley was held without bond. At 12:30 a.m., 3/31/81, this hearing was terminated. Hinckley was then transported by the FBI to the Marine Corp Base, Quantico, Virginia, where he was incarcerated.

Additionally, on 3/30/81, Magistrate Burnett issued a court order requiring that Hinckley submit to having blood, urine and hair samples taken and at a later time to produce handwriting samples and that they be delivered to the FBI. This order is attached.

Hair samples were obtained 8:10 p.m., 3/30/81, by Dr. [REDACTED] at WFO. Blood and urine samples obtained 10:37 p.m., 3/30/81, by Dr. [REDACTED] at U.S. Marshal's Office.

On 4/2/81; at 10:00 a.m., a preliminary hearing was held at U.S. District Court, WDC, before U.S. Magistrate Lawrence Margolis. Representing John W. Hinckley, Jr., was Vincent Fuller of the WDC law firm of Williams and Connely. U.S. Attorney Charles Ruff, Roger Adelman and E. Lawrence Barcella represented the government. SA [REDACTED] FBI, WFO, was prepared to testify for the government to establish probable cause that Hinckley did in fact shoot President Reagan and Secret Service (SS) Agent McCarthy. The government was also prepared to show major TV network videotapes of the attempted assassination.

The preliminary hearing was waived both orally and in written form by Hinckley.

In a report released by the court at this time, court (b)(7)(c) appointed psychiatrist Dr. [REDACTED] who had examined Hinckley, on 4/1/81, stated that Hinckley was mentally competent to stand trial.

Magistrate Margolis ruled favorably on the motion by the government to have Hinckley immediately committed to a Federal facility to undergo comprehensive mental examination. This order was appealed by the defense to U.S. District Court Judge William B. Bryant. Judge Bryant upheld the ruling by Magistrate Margolis allowing for a comprehensive mental examination and assured the defense attorneys that their psychiatric experts would have equal access to Hinckley.

By agreement with both prosecution and defense, due to security reasons, Hinckley was transported to Federal Correctional facilities, Butner, North Carolina.

United States District Court
FOR THE

DISTRICT OF COLUMBIA

UNITED STATES OF AMERICA

JOHN W. HINCKLEY, JR.

Magistrate's Docket No.

Case No.

COMPLAINT for VIOLATION of

U.S.C. Title 18

Section 1751(c)

BEFORE ARTHUR L. BURNETT

Name of Magistrate

U.S. Courthouse, Washington, D.C.

Address of Magistrate

The undersigned complainant being duly sworn states:

That on or about March 30, 1981, at 2:25 p.m., at 1919 Connecticut Avenue, N.W.

in the

Washington District of Columbia

JOHN W. HINCKLEY, JR.

did knowingly and intentionally attempt to kill Ronald W. Reagan, the President of the United States of America, by shooting him with a pistol.

And the complainant states that this complaint is based on the fact that Officer Leon J. Swain a member of the Metropolitan Police Department, Washington, D.C., told Special Agent George Chmiel that he observed John W. Hinckley, Jr., at about 2:25 p.m. at 1919 Connecticut Avenue, N.W., Washington, D.C., The Washington Hilton Hotel, point and fire a handgun at Ronald W. Reagan, the President of the United States of America. As a result of the shots fired by John W. Hinckley, Jr., the President of the United States did receive a bullet wound, in violation of Title 18, U.S. Code, Section 1751(c).

And the complainant further states that he believes that

are material witnesses in relation to this charge.

GEORGE CHMIEL Signature of Complainant
Special Agent
Federal Bureau of Investigation

Sworn to before me, and subscribed in my presence, _____, 19__

(1) Insert name of complainant
(2) Insert statement of the official facts constituting the crime charged

FD-10

United States District Court
FOR THE
DISTRICT OF COLUMBIA

UNITED STATES OF AMERICA

JOHN W. HINCKLEY, JR.

Magistrate's District No.

Case No.

COMPLAINT for VIOLATION of

U.S.C. Title 18

Section 111

BEFORE ARTHUR L. BURNETT

U.S. Courthouse, Washington, D.C.

The undersigned complainant being duly sworn states:

That on or about March 30, 1981, at 2:24 p.m., at 1919 Connecticut Avenue, N.W.

Washington District of Columbia

JOHN W. HINCKLEY, JR.

did knowingly, and intentionally assault Timothy McCarthy, a Special Agent and employee of the United States Secret Service with a pistol.

And the complainant states that this complaint is based on the fact that at the above stated time, date and location, the affiant while on a Presidential Protective detail, as a Special Agent of the Secret Service, observed an individual later identified as John W. Hinckley, Jr., the defendant, point and fire a handgun at Ronald W. Reagan, the President of the United States, who was being protected by Special Agent Timothy McCarthy. As a result of the firing of the handgun by John W. Hinckley, Jr., Special Agent Timothy McCarthy was wounded. The affiant arrested John W. Hinckley, Jr., on the scene and caused him to be placed in custody. In violation of Title 18 U.S. Code, Section 111.

And the complainant further states that he believes that

are material witnesses to the above stated facts.

CARLTON D. SPRIGGS, Affiant
Special Agent
United States Secret Service

Subscribed and sworn to before me, and authorized in my presence,

UNITED STATES DISTRICT COURT
FOR THE DISTRICT OF COLUMBIA

UNITED STATES OF AMERICA

v.

JOHN W. HINCKLEY, JR.

U.S. Mag. No. 81-0256M-01 (C)
81-0257M-01 (C)

ORDER

Upon motion of the Government in the above captioned case, that blood be taken from the defendant by an authorized member of the medical profession and also that urine samples be taken and head hairs pulled, combed, and cut from the defendant, and the Court having given consideration to the opinion in Schuerber v. California, 384 U.S. 757 (1966); upon the Government's further request that the defendant produce handwriting exemplars and the Court having given consideration to the representations made, in the opinion of the Court in Levin v. United States, 127 U.S.App.D.C. 269, 322 F.2d 817 (1967); It is this 30th day of March, 1981;

ORDERED, that blood samples be taken from the defendant by an authorized member of the medical profession and that urine samples be taken and head hairs pulled, cut and combed from the defendant and that the defendant upon request at a reasonable time, at his place of confinement, produce handwriting exemplars and deliver same to the Federal Bureau of Investigation.

Limited to handwriting only, other items already taken

Arthur L. Burnett
ARTHUR L. BURNETT
United States Magistrate

3. Grand Jury Proceedings

On 4/13/81 a special Grand Jury was empaneled at Washington, D.C. to hear evidence collected in the case entitled U.S. Government vs John W. Hinckley, Jr.

On 4/20/81, SA [REDACTED] testified before this Federal Grand Jury at U.S. District Court, Washington, D.C. USA Charles F.C. Ruff and AUSA Roger Adelman handled presentation of Government case.

(b)(7)(c)

[REDACTED]

(b)(5)

USA Ruff advised that trial in this matter would probably not occur until the Fall of 1981.

**OVERVIEW OF INVESTIGATION
CONDUCTED TO DATE**

Investigation conducted to date by the Federal Bureau of Investigation (FBI) has established that beginning in September of 1980, John W. Hinckley, Jr. criss-crossed the United States on several occasions. His travels took him to the New York/New Haven area; Lubbock and Dallas, Texas; Lincoln, Nebraska; Columbus and Dayton, Ohio; Mexico; Los Angeles, California, and Washington, D.C. (WDC). The final phase of his travel which took him to WDC via Los Angeles began in Denver, Colorado, on March 25, 1981. Hinckley arrived in WDC on March 29, 1981.

The attempted assassination of the President of the United States took place on March 30, 1981, at approximately 2:25 p.m., outside the VIP entrance of the Washington Hilton Hotel, Connecticut and T Streets, N.W., WDC. There were approximately 285 people that were present at the scene of the crime, either viewing it from a window across the street or in the immediate area of the Presidential Party. Of these 285 interviewed, there were 29 that actually witnessed an individual fire the weapon at the President or saw the weapon in the hands of that same individual but some would not be able to identify him. There were 18 key witnesses.

The crime scene area was secured and manned by Metropolitan Police Department officers. A thorough search of the area was conducted, and all evidence was photographed, dated and initialed by the agent that recovered it. Of significance, the weapon used, .22 caliber revolver, Long Rifle, model RG 14, serial number L731332, with six spent cartridges intact; a bullet hole with residue on it from the right rear window of the Presidential limousine; the right rear quarter panel of Presidential limousine bearing possible bullet impact damage and a bullet hole in the window of the Universal Building located directly across the street.

President Ronald Reagan, Mr. James Brady, and Special Agent (SA) Timothy McCarthy, United States Secret Service (USSS), were transported from the Washington Hilton Hotel to the George Washington University Hospital, and Officer Thomas Delehanty, Metropolitan Police Department (MPD), to the Washington Hospital Center. All four victims were treated for gunshot wounds, and bullets or bullet fragments were recovered from each victim during surgery.

Obtained during a search, March 30-31, 1981, of Room 312, Park Central Hotel, WDC, rented by Hinckley, March 29, 1981, were numerous items of evidence which were turned over to FBI Laboratory for examination. Among numerous written items seized

was a letter written by Hinckley to Actress Jodie Foster, in which Hinckley expresses his love for Foster and states that he is going to kill President Reagan as an expression of love for Foster.

In the course of this investigation, items of evidentiary value were seized from the person of John Hinckley, the George Washington University Hospital, the Washington Hospital Center, the crime scene at the Washington Hilton, the Park Central Hotel, the Evergreen, Colorado residence, the Presidential limousine, the media, photographs taken by bystanders and other miscellaneous locations.

All items were examined for lead information and many items were then sent to the Federal Bureau of Investigation Laboratory Division and Identification Division, for proper investigative analysis. The results of such examinations are still pending in many instances and the reports of which will be set forth at a later date.

Analysis by the Laboratory Division and Identification Division concern the following areas: Signal Analysis Examinations, Document or Handwriting Examinations, Latent Fingerprint Examinations, and Scientific Analysis Examinations, which include such areas as Firearms Identification, Gunpowder and Primer Residue Examination, Point and Trajectory Examinations, Ammunition Component Examinations, Chemical Examinations, Blood Examinations, and Hair and Fiber Examinations.

Most of the evidence in this case has been stored and inventoried in a secure, safe and proper manner at the Washington Field Office of the Federal Bureau of Investigation, but some items do remain at the Federal Bureau of Investigation Laboratory and Identification Divisions, for further analysis and result.

Parents of Hinckley, his brother, and sister have been interviewed. Former associates and schoolmates of Hinckley, throughout the United States, have been located and interviewed. Jodie Foster, Actress, interviewed at Yale University. Efforts undertaken to establish subject's membership in any organizations.

[REDACTED] Weapons
owned by subject traced.

(b)(7)(D)

WFO 175-311

EVIDENCE

B

26

TABLE OF CONTENTS - EVIDENCE

1. Evidence from the person of John Hinckley
2. Evidence from hospitals
3. Evidence from Washington Hilton
4. Evidence from Park Central Hotel
5. Evidence from Evergreen, Colorado
6. Evidence recovered from Presidential limousine
7. Evidence (miscellaneous)
8. Evidence recovered from media (cassettes)
9. Photographic evidence

WFO 175-311

EVIDENCE FROM THE PERSON
OF JOHN HINCKLEY

H-2

<u>Lab Number</u>	<u>Evidence</u>	<u>Location</u>
	One key (Room 312, Park Central Hotel)	Washington Field Office (WFO)
Q38	Jacket from John Hinckley Dabbings and scrappings from jacket	WFO
Q39	Swabs from back of right hand of John Hinckley (consumed in testing).	
Q40	Swabs from back of left hand of John Hinckley (consumed in testing).	
Q41	Swab from palm of right hand of John Hinckley (consumed in testing).	
Q42	Swab from palm of left hand of John Hinckley (consumed in testing).	
Q43	Trousers from John Hinckley.	WFO
Q44	Shirt from John Hinckley.	WFO
Q45-Q46	Two receipts.	WFO
Q47-Q48	Two pieces of paper bearing handwriting.	WFO
Submitted 3)	Pair of half-boots	WFO
	Pair of socks	WFO
	Control swab (consumed in testing.)	
	Watch	WFO
	John Lennon button	WFO
	Sightseeing brochure	WFO
	Eight cents in U.S. currency	WFO

A/S

Wallet fr John Hinckley and
the following contents thereof:

WFO

- One hundred twenty-nine dollars WFO
- Two brown pieces of paper WFO
- One photograph WFO
- Four magazine photographs WFO
- One newspaper article WFO
- Three business cards WFO
- Eleven enrollment cards WFO
- Two library cards WFO
- One college Identification WFO
- One Texas driver's license WFO
- One novelty card WFO
- One social security card WFO
- One Colorado Identification card WFO
- Two bank cards WFO
- One student data card WFO
- One Travelers Insurance card WFO
- One medical card WFO
- One chess membership card WFO
- One card bearing the Bill of Rights WFO
- One clear plastic folder WFO
- One red plastic folder WFO
- Q74 Blood from Hinckley WFO
- Q75 Urine from Hinckley WFO
- Q76 Head hair sample from John Hinckley WFO

- K3 Pubic hair sample from Hinckley WFO
- K4 Fingernail scrapings from right hand of John Hinckley WFO
- K5 Fingernail scrapings from left hand of John Hinckley WFO
- K7 (Item 26) Three index cards, two handwriting sample Lab forms and twenty-two sheets of paper bearing handwriting and handprinting of John W. Hinckley, Jr.

WFO 175-311

EVIDENCE RECOVERED FROM HOSPITALS

Items associated with Officer Delahanty at the Washington Hospital Centers

LABORATORY NUMBER

EVIDENCE

LOCATION

027	Uniform shirt from Officer Delahanty	Washington Field Office (WFO)
028	Raincoat	WFO
ALSO SUBMITTED (W/C)	Identification badge	WFO
	4 X-rays of Thomas Delahanty from the Washington Hospital Center	WFO
	Copies (not originals) of medical records and X-rays pertaining to Thomas Delahanty (4/24/81)	WFO
	[REDACTED] Washington Hospital Center).	(b)(7)(c)
0138	Bullet removed from Officer Delahanty	LABORATORY (LAB)

Items associated with Timothy McCarthy at the George Washington University Hospital:

021	Bullet from Timothy McCarthy	LAB
022	Shirt from Timothy McCarthy	WFO
023	T-shirt	WFO
024	Trousers with belt	WFO
025	Undershorts	WFO
026	Suit Jacket and necktie	WFO
	Copies (not originals) of medical records and X-rays of Timothy McCarthy (4/24/81)	WFO
	[REDACTED] George Washington University Hospital.	(b)(7)(c)

A/S:

Pair of shoes

Returned to
United States
Secret Service
(USSS)

Eolster

USSS

Cartridge holder with six cartridges

USSS

Handcuffs with case

USSS

Three pieces of paper

USSS

Note removed from shirt

USSS

Tissue paper

USSS

Contact lens case

USSS

Three keys

USSS

Three dollars and sixty cents
U.S. currency

USSS

Pair of socks

USSS

Earpiece

USSS

Handkerchief

USSS

Items associated with James Brady at the
George Washington University Hospital:

Q11	Bullet fragment from James Brady	LAB
Q12	Metal fragment from James Brady	LAB
Q13	Bullet fragment from James Brady	LAB
Q14	Metal fragment from James Brady	LAB
Q15	Suit Jacket from James Brady	WFO
Q16	Shirt	WFO
Q17	Vest	WFO

Q18	Trousers and belt	WFO	
Q19	Undershorts	WFO	
Q20	Tie	WFO	
	Copies (not originals) of medical records and X-rays of James Brady (4/24/61) [REDACTED] George Washington University Hospital).	WFO	(b)(7)(c)
W/S	Two sheets	WFO	
	Hospital gown	WFO	
	Pair of shoes		Returned to White House Office (WFO)
	Two looks of matches	WFO	
	Spiral note pad	WFO	
	Blank checks	WFO	
	Set of keys	WFO	
	Two ticket stubs	WFO	
	Copy of press release	WFO	
	Tissue paper	WFO	
	Pen	WFO	
	Wallet with numerous credit cards and other identifying material	WFO	
	Money folder with sixty-seven dollars U.S. currency and five pieces of paper	WFO	
	Sock	WFO	

Items associated with President Ronald Reagan at the
George Washington University Hospital:

Q7	Bullet removed from President Ronald Reagan	LAB	
Q8	Suit Jacket from President Reagan	WFO	
Q9	Trousers	WFO	(b)(7)(c)
Q10	Underwear	WFO	
ALSO SUBMITTED	Handkerchief (A/S)	WFO	
	Socks	WFO	
	Copies (not originals) of medical records and X-rays of Ronald Reagan (4/24/61) [REDACTED]	WFO	
	[REDACTED] George Washington University Hospital).		
	One bag of items taken from emergency room at George Washington University Hospital emergency room.	WFO	
	Two bags, one plastic, one cloth from George Washington University Hospital emergency room	WFO	
	Seven plastic bags containing miscell- aneous items from George Washington University Hospital emergency room	WFO	
	Four white cloth laundry bags containing dirty linen from George Washington University Hospital emergency room	WFO	
	One light blue dumpster from George Washington University Hospital emergency room	WFO	
	Belt with gold Gucci buckle	All returned to President	
	One pair of black laced shoes		

(H)(7)(C)

Y

[REDACTED]

[REDACTED]

[REDACTED]

Gold Longines wristwatch

[REDACTED]

One California Golden Bear cuff link

WFO 175-311

EVIDENCE RECOVERED FROM WASHINGTON: MILTON

LABORATORY
NUMBEREVIDENCELOCATION

<u>LABORATORY NUMBER</u>	<u>EVIDENCE</u>	<u>LOCATION</u>
01-06	Six cartridge cases removed from K1 revolver in Laboratory	LABORATORY (LAB)
01	.22 Long Rifle caliber RG Industries revolver, Model RG14, Serial Number L731332	LAB
ALSO SUBMITTED (A/S)	One plastic bag containing separate small bags of debris picked up from driveway at Washington Hilton Hotel	Washington Field Office (WFO)
	One plastic bag containing twenty-nine small bags of miscellaneous items collected at Washington Hilton Hotel	WFO
029	Lead fragment found outside of lobby window of Universal Building North	LAB
030	Lead fragment removed from drape inside lobby of Universal Building North	LAB
031	Lead fragment found in lobby floor sweepings from inside Universal Building North	LAB
032	Fragments from outside and below window of Universal Building North	LAB
033	Fragments from outside of lobby window of Universal Building North	LAB
034	Sweepings from floor inside of window of Universal Building North	LAB
035	Sweepings from vestibule of Universal Building North	LAB
036	Swab from outside of lobby window of Universal Building North	LAB
037	Swab from inside of lobby window of Universal Building North	LAB
A/S	Glass from window sill inside lobby of Universal Building North	LAB

Q133 Cartridge case from scene of shootings WFO

Q126-Q123 Three cartridges from scene of shootings LAB

Q129 Roll of film WFO

FO 175-311

EVIDENCE FROM
PARK CENTRAL HOTEL

H-15

41

<u>Lab Number</u>	<u>Evidence</u>	<u>Location</u>
	Items from dumpster in trash area of Park Central Hotel (3rd Floor)	
Q49	Forty-four (44) pieces of torn Washington Field Office (WFO) yellow tablet paper.	
Q50	One Eastern Airlines Boarding Pass	WFO
Q51	One (1) torn piece of paper possibly a portion of a ticket.	WFO
	Item received from reception desk of Park Central Hotel	
Q52		WFO (b)(7)(c):(d)

Items From Tan Suitcase located
In Room 312 (#1 through #28)

1. Rugged long sleeve pull over shirt, red and white horizontal stripes (tag torn out). WFO
2. Dark green long sleeve button up shirt, size Large. WFO
3. Blue long sleeve button up shirt "BIG MAC J.C. PENNEY" WFO
4. Light blue long sleeve button up shirt (J.C. PENNEY 16 1/2-33). WFO
5. Short sleeve pull over shirt dark blue and beige horizontal stripes (tag torn out). WFO
6. Dark blue and gold pull over shirt with short sleeves. OP on left sleeve (tag torn out). WFO

7. Blue, red, beige, black, green and white checkered long sleeve button up shirt (J.C. Penney L size 16-16½). WFO
8. One pair mens jockey shorts (Underwear) J.C. Penney (size 34). WFO
9. One multi-colored rope with purple tassel at one end. WFO
10. Two leather shoe laces. WFO
11. Small lock and key. WFO
12. One baggie (transparent). WFO
13. Black Gun box RG Industries, Inc., for a RG14 swingout Revolver, containing operating instructions, warranty, and liability statement. The box is described on the end, serial #L 731329, Model RG14, caliber 22LR, finish Blued, Barrel length 1 3/4 RG Industries, Inc., Miami, Florida, 33152. WFO
Also contained in the box are two loose roundnose 22 shells (Q76 and Q77) and a box of 22 shells Winchester Expediter containing 35 hollow point shells (Q78 - 112). Lab
14. Western Airlines ticket, serial #9356329, in the amount of \$89.00, from Denver Western Airlines flight 45, 3/25/81, 11:30 a.m.; Lv Salt Lake City, WA flt 257 3/25/81 1:10 p.m., for Los Angeles, California in the name Hinckley/J Mr. WFO

Two ticket envelopes for Western Airlines

- (A) To Salt Lake City flight #45
- (B) From Salt Lake City flight #257 (inside this envelope are):
 - (1) A Western \$50.00 Travel Pass #501539 validated 3/25/81 11:05 in Denver
 - (2) Studio Pass for Merv Griffin Show for March 26, 1981

(3) Two tickets for National Easter Seal Telethon hosted by Pat Boone, one for 3/28/81 and one for 3/29/81

- | | |
|---|------------------------------|
| 15. Pocket Instamatic 20 camera containing film pack (24 exposures), no film exposed. | WFO |
| 16. Esquire magazine, October, 1980 issue, containing 38 sheets of notebook paper containing poetry (handwritten). These items were folded between pages 62 and 63 (Q54 and Q55). | WFO |
| 17. People magazine, May 19, 1980, two photographs on cardboard backing located at page 126 with 3 torn pages bearing pictures of Jodie Foster. | WFO |
| 18. Paperback book "THE CATCHER IN THE RYE" | WFO |
| 19. Paperback book "A TWIST OF LENNON" | WFO |
| 20. TWA luggage tag hand printed "J. HINCKLEY, EVERGREEN, COLORADO, [REDACTED] (Q53) | WFO (b)(7)(c) |
| 21. Atlas switch control Box #56 envelope containing piece blue and yellow double strand wire (42" long and black control with blue switch) | WFO |
| 22. Package of GE Magicubes (unused) | WFO |
| 23. Arrid Extra Dry Anti-Prespirant deodorant spray (unscented) | WFO |
| 24. Bottle of Doan's Pills (14) | WFO |
| 25. Prescription eyeglasses with black case | Returned to subject's father |
| 26. Sunglasses | Returned to subject's father |
| 27. Partial roll of DI-GEL | WFO |
| 28. Package CONTAC (7 capsules) | WFO |

ITEMS FROM SHAVING KIT FOUND
IN BATHROOM LOCATED IN ROOM 312

- | | |
|---|-----|
| 1. Black shaving kit (Zipper) | WFO |
| 2. Baggie with cotton pac | WFO |
| 3. Bottle (prescription) Sodium Sulamyd
eyedrops also contained in bottle are 9
Tylenol capsules (Q122) | WFO |
| 4. Bottle (prescription [REDACTED] 2/24/81
[REDACTED] (Q121) | WFO |
| 5. Bottle prescription [REDACTED] dated 3/9/81,
[REDACTED] (Q120) | WFO |
| 6. Bottle prescription [REDACTED] dated 6/20/80,
[REDACTED] (Q119) | WFO |
| 7. Max Factor make-up tube, white | WFO |
| 8. Red flair-tip pen | WFO |
| 9. Pearl handle knife | WFO |
| 10. Black "BIC" lighter | WFO |
| 11. Pair scissors | WFO |
| 12. Black flair felt-tip pen | WFO |
| 13. Black comb | WFO |
| 14. Black "Papermate" ball-point pen | WFO |
| 15. 3 Chloraseptic throat lozenges | WFO |
| 16. Partial roll DI-Gel mints | WFO |
| 17. Three band-aids, Johnson and Johnson | WFO |
| 18. One small electric shaver brush | WFO |
| 19. Tube of Tridesilon cream | WFO |
| 20. Small key on ring | WFO |
| 21. AMTRAK Schedule, NY to Wash DC/Balto | WFO |

(b)(6)
(b)(7)(C)
↓

ITEMS LOCATED IN
BATHROOM (ROOM 312)

- 1. Box of Cosmetic Squares (COETS) WFO
- 2. Sears electric razor (metal mirror inside is loose) WFO
- 3. Yellow "Pro Perio" toothbrush WFO
- 4. Bottle of "SUPER SKIN" WFO
- 5. Tube "Crest" toothpaste WFO
- 6. Partial roll toilet tissue WFO
- 7. Three torn pieces of "Cashmere Bouquet" soap wrapper (blue) WFO

ITEMS FROM DESK
TOP IN ROOM 312

- 1. Washington Post TV Guide (opened to page 13) WFO
- 2. Empty Pepsi can WFO
- 3. Clear glass ashtray WFO
- 4. DC yellow pages phonebook WFO
- 5. Park Central "Guest Service Directory" WFO
- 6. Tan dial phone 202-393-4700, ext. 7312 WFO

REMOVED FROM TOP
LEFT HAND DRAWER OF DESK

- 1. DC phonebook white pages WFO

ITEMS REMOVED FROM ROUND TABLE

- 1. Clear glass ashtray WFO
- 2. Dark brown Ice bucket and tray with 2 glasses WFO

ITEM REMOVED FROM
INSIDE FRONT DOOR HANDLE

1. "DO NOT DISTURB" sign

WFO

ITEM REMOVED FROM
NIGHT STAND BETWEEN BEDS

1. Digital clock, Quartz LC-301
2. Clear glass ashtray

WFO

WFO

ITEM REMOVED FROM FLOOR AT
FOOT OF BED NEXT TO AIR CONDITIONER

1. Washington Post newspaper, March 30, 1981
Sections A, B, C, D, and insert Washington
Business WFO
2. Sections B, C, D of The Washington Star, dated WFO
March 30, 1981

ITEMS FOUND ON BED
NEXT TO AIR CONDITIONER

1. Section A of The Washington Star, dated WFO
March 30, 1981 (opened to page A-4, schedule
of Congressional Activities for March 30, 1981)
2. 16 Latent lifts developed from Park Central WFO
Hotel Room (Room 312)

ITEMS FROM PLAID SOFTSIDE BLACK/RED
CHECKERED SUITCASE LOCATED IN ROOM 312

1. Light blue pull over sweater (label cut out) WFO
2. Army Olive Drab field jacket-tag inside C48 WFO
3. Black sport coat - J.C. Penny Contemporary WFO
Classic - with laundry tag inside rt. breast
pocket #1-689
4. Red and dark blue plaid button up shirt - long WFO
sleeve J.C. Penny L16-16 1/2

- | | |
|---|-----|
| 5. Red, white, and black plaid flannel button up long sleeve shirt - ELY 16-16 1/2 | WFO |
| 6. Rugger pull over T-shirt, wine, white, beige and pink in color | WFO |
| 7. Light green pull over T-shirt, J.C. Penney, XL 46-48. | WFO |
| 8. Green, dark blue, red, and white striped T-shirt (label cut out) | WFO |
| 9. Green and yellow ski stocking hat | WFO |
| 10. Maroon pull over T-shirt (label cut out) | WFO |
| 11. Blue and white checkered short sleeve, button up shirt (label cut out) | WFO |
| 12. Blue, red, and white striped button up shirt, long sleeve (Sero of New Haven) | WFO |
| 13. Pair light brown Levi corderoy pants with black belt | WFO |
| 14. Pair denim jeans - J.C. Penney | WFO |
| 15. Green plaid flannel shirt - ELY L 16-16 1/2 | WFO |
| 16. Red and white Rugger striped shirt, long sleeve - XL | WFO |
| 17. Yellow towel - Burlington | WFO |
| 18. Black T-shirt, XL - J. C. Penney | WFO |
| 19. Dark Blue T-shirt XL - J.C. Penney | WFO |
| 20. Two jockey shorts - size 36 - J.C. Penney (White) | WFO |
| 21. Two white T-shirts - size 42 - J.C. Penney | WFO |
| 22. Member card-1981 Sustaining Member Republican National Committee #2314266 | WFO |
| 23. Torn Greyhound Lines baggage check (form B-3) with printed numbers "947375" (removed from handle by [REDACTED] (56) | WFO |

(b)(7)(c)

- | | |
|--|---------------|
| 24. United Airlines baggage ID tag containing hand printed name "JOHN HINCKLEY" (cut off of handle by [redacted] (Q57) | WFO (b)(7)(c) |
| 25. Box with bottle of Cystex tablets | WFO |
| 26. Plastic bottle of "SUPER SKIN" | WFO |
| 27. Metal Band-Aid container containing 9 large band-aids and 10 small band-aids (on can red tag Metro-M) Hijack note found in bottom of can (Q58) | WFO |
| 28. Box of Co-Tylenol (18 tablets) | WFO |
| 29. Red toothbrush - Pepsodent | WFO |
| 30. Container of single edge razor blades (8) | WFO |
| 31. Two bars Hilton Hotel soap (1 large, 1 small) | WFO |
| 32. Box of Chloraseptic Lozenges (6) | WFO |
| 33. One wet nap (Famous Recipe) | WFO |
| 34. One piece of cellophane | WFO |
| 35. Small tube Pepsodent toothpaste | WFO |
| 36. Red Scripto lighter | WFO |
| 37. A stitch cutter | WFO |
| 38. Piece of corner of yellow page "212 11:30" | WFO |
| 39. Miscellaneous papers and stamps, 1 piece paper with peel off numbers, 3 cardboard stamp holders, (2) 1¢ stamps, (3) 4¢ stamps, (3) 10¢ stamps, 1 torn piece paper, and 1 15¢ stamp and plastic guitar pick | WFO |
| 40. One bottle Extra-Strength Tylenol | WFO |
| 41. One penny 1980 D | WFO |
| 42. One lint brush with broken handle | WFO |
| 43. One roll Scotch brand tape with cardboard container | WFO |

- | | |
|--|--------------------|
| 44. One white papermate ball-point pen with blue cover | WFO |
| 45. Black leather belt | WFO |
| 46. One bottle of [REDACTED] | WFO (b)(6) |
| 47. Brown prescription bottle containing 14 pennies (Q123) [REDACTED] | WFO (b)(7)(c)
v |
| 48. Empty bottle [REDACTED] (Q124) | WFO |
| 49. Paperback book "ROMEO AND JULIET" | WFO |
| 50. Paperback book "DAYBREAK" (at page 88 folded picture of Napoleon Q72) | WFO |
| 51. Paperback book "TEN BUNDY: THE KILLER NEXT DOOR" | WFO |
| 52. Paperback book "FADE TO BLACK" | WFO |
| 53. Paperback book "THE FOX IS CRAZY TOO" | WFO |
| 54. Paperback book "THE FAN" at page 158 was postcard of Reagans (Q71) | WFO |
| 55. Paperback book "STRAWBERRY FIELDS FOREVER" "John Lennon Remembered" | WFO |
| 56. Paperback book "THE SKYJACKER" | WFO |
| 57. Paperback book "TAXIDRIVER", places underlined | WFO |
| 58. Hardback book 1979 Songwriters Market (at page 278 an article "Needs a Doctor" and two sheets of paper with poems) (Q67 and Q68) | WFO |
| 59. Bulletin of Yale University containing an application, tour card for U.S. Capitol (Q161), Pass for Senate (Edward M. Kennedy) (Q158), Pass for House of Representatives (Ken Kramer) (Q160), Pass for Senate (Q159) (John Tower), and Amtrak schedule and one greeting note captioned "A Special Message from Senator Kennedy" | WFO |
| 60. Hotel receipt for The Sheraton Centre New York, page 01, Room 1540, account #154121, for March 2, 3, 4, 1981 for Mr. John Hinckley, Lubbock, Texas | WFO |

- 61. TWA Env, boarding pass and passenger copy of ticket for TWA flight 212, Denver to New York Kennedy, dated March 1, 1981 WFO
- 62. United Airlines ticket envelope and passenger copy for ticket for flight #173 dated March 7, 1981, New York/Newark to Denver WFO
- 63. Envelope and passenger copy of Greyhound ticket #40536853832 from Hollywood, California to Washington, D.C. dated 3/26/81 with 3 boarding passes numbered 6, 99, and 99 WFO
- 64. Best Western Road Atlas and Travel Guide - 1978 (with small piece paper-advertisement) WFO
- 65. Plain white envelope (same as item 82-2) WFO
- 66. Studio passes for Merv Griffin Show dated March 25, 1981, and Tomorrow Show dated March 2, 1981 WFO
- 67. Partial Mead Legal Pad 59-6222 (Q151) WFO
- 68. Park Central Hotel receipt for \$47.00, dated March 29, 1981, Room 312, 13:04 paid cash WFO
- 69. 5 yellow pages from 1979 New York City pages 925-934 WFO
- 70. Newspaper article Rocky Mountain News, March 13, 1981 "CASTRO PLOTS REAGAN'S SLAYING" WFO
- 71. Newspaper article Rocky Mountain News, March 13, 1981, "REAGAN WAVER'S ON HIJACK POLICY" WFO
- 72. Hotel Sheraton Park Plaza Hotel and Conference center receipt, New Haven, Connecticut, dated 3/1/81, Room 507, #750 397518, for J. Hinckley, Dallas, Texas WFO
- 73. Advanced payment receipt for The Sheraton Centre, New York, #26261, dated 2/3/81, \$71.12 WFO
- 74. Advanced payment card for Sheraton Centre, New York, Room #1540 for Mr. Hinckley WFO
- 75. Plastic toy pistol with black tape on handle WFO

76. Where/New York torn page 37 and 38 magazine article (map of Midtown Manhattan on page 37) WFO
77. Three torn pages from magazine article about author Frankie Fitzgerald WFO
78. Train schedule for New Haven Line effective February 3, 1980 WFO
79. Tomorrow Show pass for March 2, 1981, NBC TV Studios, NY (designated A) WFO
80. Lennon Color Calendar 1981 WFO
81. Two cassette tapes WFO
(1) Side "LEE ANN ITS MORE THAN I CAN TAKE" (Q1)
(2) Side 1 "DO NOT ERASE IMPORTANT JODIE" (Q2)
82. Green cover Composition book containing 7 sheets of paper (Q61) contained inside are: WFO
(1) White envelope bearing name Jodie Foster (Q60)
(2) Blank white envelope
(3) Yellow sheet of lined paper dated 3/30/81 beginning "Dear Jodie," (Q59)
83. Yellow sheet of paper captioned "TAXES" (Q62) WFO
84. Motel 6 Registration Card #AX07053 (Q63) WFO
85. Two yellow sheets of lined paper with notations (Q 64) AND (Q65) WFO
86. Yellow writing pad (Scribbletex) (24 sheets) (Q66) WFO
89. Sheet of white spiral notebook page with handwriting (Q69) WFO
90. Torn page (#1820) from Mountain Bell Yellow Pages (Q70) WFO
91. Checkbook containing: (Q73) WFO
(a) Check registers (17 pages)
(b) Nine blank checks Texas Bank
(c) Deposit ticket in name (handwritten)
John W. Hinckley
92. "Devastator" cartridge box (piece of foam with 12 holes inside) Lab

WFO 175-311

EVIDENCE FROM
EVERGREEN, COLORADO

H-27

53

The following items were removed from a white Plymouth Volare,
Texas license PWN 998:

<u>Laboratory Number</u>	<u>Evidence</u>	<u>Location</u>
Q166 (item 60)	Texaco credit card slip invoice #653107 dated 3/3/80, signed "John Hinckley"	Washington Field Office (WFO)
Q167 (Item 61)	Conoco credit card slip #9031012 dated 2/23/82 signed "John Hinckley"	WFO
Q168 (Item 62)	Conoco credit card slip invoice #9030979 dated 2/24/81, signed "John Hinckley"	WFO
Q169 (Item 63)	Conoco credit card slip invoice #3712909 signed "John Hinckley"	WFO
Also Submitted (A/S)	Receipt from Nieman's Auto Service, 9660 Audelia Road, Dallas, Texas, 3/3/80	WFO
	Checking deposit, [REDACTED] [REDACTED]	WFO (b)(7)(c)
	Texaco charge, 7/9/80, Lubbock, Texas	WFO
	Conoco Service receipt 2/19/80	WFO
	ID tag, plastic, [REDACTED] [REDACTED] Dallas, Texas	WFO (b)(7)(c)
	Old Hickory knife, approxi- mately 4" blade	WFO
	Exxon Texas map	WFO
	Dr. Pepper can	WFO
	Cash receipt, \$31.50	WFO

The following item was obtained from the property section of the Denver Police Department:

<u>Laboratory Number</u>	<u>Evidence</u>	<u>Location</u>
Q170 (Item 64)	Smith-Corona typewriter Serial Number 6MLC486114H with case	Lab

The following items were obtained from the bedroom at [REDACTED] Evergreen, Colorado:

(b)(7)(c)

<u>Laboratory Number</u>	<u>Evidence</u>	<u>Location</u>
Q171 (Item 65)	Sheet of paper bearing hand printed message "Your license # has been listed"	WFO
A/S	Brown vinyl suitcase with initials, "LFB"	WFO
	Book, "Ted and the Kennedy Legend"	WFO
	Brown handled paring knife	WFO
	Box, empty, .22 caliber LR, RG 14, 1 3/4", L784463	WFO
	2 targets, human outline, punctured	WFO
	3 targets, bullseye, punctured	WFO
	1 taped solid iron bar	WFO
	1 set shooting ear protectors	WFO
	4 6.5 x 55 cartridges "norma"	WFO
	1 olive drab color military type cap	WFO
	1 sports type cap, black	WFO
	1 black rain jacket	WFO

Esquire magazine, October, 1980	WFO
Box of Norma ammunition, 6.5 x 55, 156 grain, 20 cartridges	WFO
Box of Norma ammunition, 6.5 x 55, 15 expended rounds	WFO
2 pennies from outside compartment with label "Made in Italy"	WFO
1 plastic pick	WFO
1 emery board	WFO
1 item resembling shark's tooth	WFO

(b)(7)(c)

The following items were obtained from the bookcase located in bedroom at [REDACTED] Evergreen, Colorado:

<u>Laboratory Number</u>	<u>Evidence</u>	<u>Location</u>
Q172 (Item 66)	Map of Washington, D.C., torn from magazine	Lab
Q173 (Item 67)	Safeway photo processing envelope #417479 containing (12) color photographs	WFO
Q174 (Item 68)	Safeway photo processing envelope #018506 containing (9) color photographs	WFO
Q175 (Item 69)	Bank book from [REDACTED]	WFO
Q176 (Item 70)	Bank book from [REDACTED]	WFO
Q177 (Item 71)	Bank book from [REDACTED]	WFO
Q178 (Item 72)	Book entitled "Reagan the Man, the President"	WFO
Q179 (Item 73)	Book entitled "Reagan In Pursuit of the Presidency - 1980"	WFO

180 (Item 74)	Dallas Morning News dated 5/16/72, headlined "Wallace Shot"	WFO
181 (Item 75)	Book entitled "John Lennon One Day At A Time"	WFO
182 (Item 76)	Nine (9) photos and negatives	WFO
183 (Item 77)	"Dallas Morning News" dated 8/17/77, headlining Elvis Presley	WFO
184 (Item 78)	"Dallas Morning News" dated 9/28/64, headlining Kennedy Assassination	WFO
185 (Item 79)	Six (6) [REDACTED] receipts	WFO
186 (Item 80)	Bank book from [REDACTED]	WFO (b)(7)(c)
187 (Item 81)	Bank book from [REDACTED]	WFO
188 (Item 82)	Bank book from [REDACTED]	WFO
189 (Item 83)	Red diary	WFO
190 (Item 84)	Thirty-eight (38) photographs	WFO
A/S	United Air Lines ticke, 2/19/81, Kennedy to Denver	WFO
	Envelope postmarked 10/15/80, containing bank statement and deposit ticket	WFO
	Envelope from Texas Tech University containing envelope, application and labels	WFO
	"Time," 12/22/80, with John Lennon on cover	WFO

"Newsweek" 12/22/80 with John Lennon on cover	WFO
"People Weekly" with Lennon on cover	WFO
"Time," 1/5/81, with President Reagan on cover	WFO
Continental Air Lines Ticket, 9/17/76, Los Angeles to Denver	WFO
10 Taylor Supper Club, Lakewood pay stubs	WFO
Box of miscellaneous checks, [REDACTED] and other	WFO

(b)(7)(c)

↓

The following items were removed from the garage at [REDACTED] Evergreen, Colorado:

<u>Laboratory Number</u>	<u>Evidence</u>	<u>Location</u>
Q191 (Item 85)	Envelope addressed to Mr. John Hinckley containing booklet "The South Forever," five typewritten pages titled "The South Shall Rise Again" three typewritten pages with "A" at top, six pages regarding crime reproduced from "Time" dated 8/12/66, typewritten pages "The Greatest Event In American History" and "The Only Answer"	WFO
Q192 (Item 86)	Book entitled "The Myth of the Six Million"	WFO
Q193 (Item 87)	Envelope and bank statement post-marked 6/13/79, fifteen checks, two deposit slips and sheet of paper bearing hand printing	WFO
Q194 (Item 88)	Deposit receipt for [REDACTED]	WFO
Q195 (Item 89)	Torn sheet of paper captioned "Country Classified" bearing hand printing beginning "Miscellaneous..."	WFO

Q196 (Item 90)	Eight sheets of paper torn from notebook containing handwriting and hand printing	WFO
Q197 (Item 91)	Selective Service Card signed "John Hinckley"	WFO
Q198 (Item 92)	Book entitled "The Boston Strangler" containing eight photographs	WFO
Q199 (Item 93)	Four sheets of paper bearing handwriting beginning "As a high school...."	WFO
Q200 (Item 94)	Bank statement and envelope postmarked 1/9/80, eighteen checks and one deposit slip	WFO
A/S	Book, "An Assassin's Diary"	WFO
	Envelope addressed to [REDACTED] containing booklet captioned "The World's Most Dangerous Man"	WFO (b)(7)(c)
	10 sheets from magazine "Crawdaddy," regarding quaaludes	WFO
	Time essay, "Did America Shoot Wallace?"	WFO
	Life magazine, 5/26/72, featuring, "The Wallace Shooting"	WFO
	Article, "Sources of Finance Of the American Right Wing"	WFO
	Book, "JFK Assassination File"	WFO

EVIDENCE RECOVERED FROM PRESIDENTIAL LIMOUSINE

H-34

60

LABORATORY
NUMBEREVIDENCELOCATION

Q114	Metal fragments from right rear window and door area of Presidential limousine	LABORATORY (LAP)
Q115	Rubber seal from right rear window of Presidential limousine	LAP
Q116	Bloodstain swabs from inside of Presidential limousine	LAP
Q117	Right rear window of Presidential limousine	LAP
X6	Section of right rear quarter panel from Presidential limousine	LAP

WFO 175-311

EVIDENCE
(MISCELLANEOUS)

H-36

62

LABORATORY NUMBER

EVIDENCE

LOCATION

(b)(7)(c)

Q118 Suit Coat from [REDACTED]

Washington Field Office (WFO)

Q12 .32 long caliber Smith & Wesson revolver, serial number 104

United States Secret Service (USSS)

Q155 (Item 49)

[REDACTED]

LABORATORY (LAF)

(b)(7)(c): (d)

Q156 (Item 50) Department of the Treasury Bureau of Alcohol, Tobacco and Firearms, Firearms Transaction Record for revolver with serial number L731329

LAF

Q157 (Item 51) Department of the Treasury Bureau of Alcohol, Tobacco and Firearms, Firearms Transaction Record for revolver with serial number L731332

LAF

Q162 (Item 50)

[REDACTED]

Q163 (Item 57)

[REDACTED]

Q164 (Item 59)

[REDACTED]

Q165 (Item 59)

[REDACTED]

ALSO SUBMITTED (A/E)

[REDACTED]

[REDACTED]

Q205 (Item 99)

[REDACTED]

(H)(7)(D)

Q206
(Item 100) [REDACTED]

✓

Q207
(Item 101) [REDACTED]

Q208
(Item 102) [REDACTED]

Q227
(Item 115) [REDACTED] LAB

Q223
(Item 116) [REDACTED] LAB

EVIDENCE RECOVERED FROM MEDIA (CASSETTES)

The following items pertain to media coverage of the assault on President REAGAN on March 30, 1981:

<u>EVIDENCE</u>	<u>LOCATION</u>
1. Two (2) ABC-TV cassettes	Laboratory
2. One (1) CBS-TV cassette	Laboratory
3. One (1) NBC-TV cassette	Laboratory
4. One (1) NBC-TV recap cassette	Laboratory
5. One (1) Cable News Network cassette	Laboratory
6. Three (3) TV-9 cassettes	Laboratory
7. One (1) TV-7 cassette	Laboratory
8. One (1) TV-4 cassette	Laboratory

EVIDENCE PHOTOGRAPHS

H-41

67

WFO has gathered, and continues to gather, all available photographic evidence concerning the assault on the President. This material consists of television video tapes, motion picture film, and still photographs. FBI agent/photographers and MPD officers made numerous photographs of the crime scene as it existed immediately after the incident; of the crime scene area as the crime was reenacted on 3/30/81; of the crime scene as viewed from nearby rooftops and from a helicopter; and of the contents of Room 312, Park Central Hotel. WFO has subpoenaed witness photographs from all professional photographers identified as being at the scene. Some have been received; others remain outstanding. Some photographs have been received at WFO from witnesses to the incident who have voluntarily submitted their photos.

All photographic evidence is assigned a roll number when it arrives at WFO. This number is used to identify each roll. Within each roll each frame is assigned a unique number. Therefore, each picture has a totally unique number, and this number has been keyed and entered into the computer for purposes of organizing/sorting the photos by category.

One master set of photographs and the original negatives of those prints (if available) are stored in a combination safe at WFO. The master prints and negatives are afforded appropriate evidentiary security.

The photographic evidence listed hereafter is not inclusive. Other photographs are currently in processing at FBIHQ Laboratory Division or are otherwise not yet available to the FBI, WFO.

Motion Picture Film

The Naval Audio Visual Laboratory in DC has provided footage taken by their photographer at the scene. It is of generally poor quality.

Still Pictures

- Roll 1. Crime scene reenactment. FBI photos, 14 prints.
- Roll 2. General crime scene photographs. FBI photos, 13 prints.
- Roll 3. Crime scene reenactment. FBI photos, 11 prints.

- Roll 4. Crime scene photos, WPD photos, 20 prints.
- Roll 5. General crime scene, FBI photos, 4 case prints.
- Roll 6. General crime scene, FBI photos, 11 prints.
- Roll 7. Crime reenactment, FBI photos, 30 prints.
- Roll 8. Crime reenactment, FBI photos, 14 prints.
- Roll 9. Rooftop view of crime scene area, FBI photos, 6 case prints.
- Roll 10. Presidential limousine, FBI photos, 6 case prints.
- Roll 11. Crime reenactment, FBI photos, 29 prints.
- Roll 12. General crime scene, FBI photos, 30 prints.
- Roll 13. Rooftop view of crime scene area, FBI photos, 10 prints.
- Roll 14. Crime reenactment, FBI photos, 30 prints.
- Roll 15. Contents of Rm. 312, Park Central Hotel, FBI photos, 30 prints.
- Roll 16. Presidential limousine, FBI photos, 14 prints.
- Roll 17. Photos of John Hinckley, Jr. taken at FBI office evening of 3/30/81, FBI photos, 11 prints.
- Roll 18. Contents of luggage found in Rm. 312, Park Central Hotel, FBI photos, 26 prints.
- Roll 19. Contents of luggage found in Rm. 312, Park Central Hotel. Includes photos of letter to Jodie Foster written 3/30/81, FBI photos, 29 prints.
- Roll 20. Crime scene, including grate. FBI photos, 13 prints.
- Roll 21. Crime scene, grate and sidewalk. FBI photos, 30 prints.
- Roll 22. Universal Building and Hilton Hotel, 3/31/81. FBI photos, 16 prints.
- Roll 23. Crime scene area, taken on subsequent date. FBI photos, 20 prints.
- Roll 24. Contents of luggage found in Rm. 312, Park Central Hotel. Also rooftop shots taken of Hilton Hotel from Universal Building. FBI photos, 28 prints. (H)(7)(C)
- Roll 25. Rooftop photos of crime scene area from roof of Universal Building (Also some unassociated pictures), FBI photos, 13 prints.
- Roll 26. Witness photographs of actual incident--taken by official White House Photographer [redacted]. These are good shots of the incident, but do not specifically show Hinckley. (No negatives) 12 prints.
- Roll 27. Witness photographs--by [redacted] (ph.) (a minor) These photos are not of good quality. 18 prints.
- Roll 28. Witness photographs--by [redacted] (ph.) (a minor) These photos are of poor quality. 5 prints.

(b)(7)(c)

- Roll 29. Witness photographs--by [redacted] (a minor) These photos are of poor quality. 14 prints.
- Roll 30. FBI Laboratory photographs of Hinckley's weapon, 3 prints.
- Roll 31. Photographs of John Hinckley, Jr. taken with arrest board--front and side views. FBI photos, 2 prints.
- Roll 32. Eight photos of persons taken at WFO and later used as a photo lineup. Photo #5 is John Hinckley, Jr. 7 prints used.
- Roll 33. Aerial pictures of Hilton Hotel area--view from helicopter. MPD black and white photos, 14 prints.
- Roll 34. Witness photographs--supplied by [redacted] photographer for Time Magazine. These are good prints made from the original slides. 30 prints.
- Roll 35. Witness photographs, taken after incident by [redacted] 11 prints from slides.
- Roll 36. Witness photographs, by [redacted] These are fairly good crowd shots. 4 prints from slides.
- Roll 37. One black and white photo of possible Hinckley look-alike.
- Roll 38. General crime scenes, MPD photos, 10 prints, black and white.
- Roll 39. General crime scene, photos of Hinckley weapon taken on scene. MPD photos, 12 prints.
- Roll 40. Witness photographs taken by [redacted] Hilton Hotel employees, both before and after incident. One shot has a good shot of an individual who may be Hinckley standing in the crowd, 9 prints.
- Roll 41. One black and white witness photograph, by [redacted] This shot is blurred, but appears to show a male individual pointing something at the President. (Negatives currently at FBIHQ.)
- Roll 42. (No actual film--roll number assigned to same roll as #39.)
- Roll 43. Witness photographs--by [redacted] (a minor). These photographs are not of good quality. 3 prints.
- Roll 44. Copies of United States Secret Service photographs, supplied for information only.

Y





- Roll 45. Contents of Rm 312, Park Central Hotel. MPD photos, (color out of balance on negatives.) 19 prints.
- Roll 46. Contents of luggage found in Rm 312, Park Central Hotel, MPD photos, 22 prints. (b)(7)(c)
- Roll 47. Witness photographs--only three currently available--remainder at FBIHQ. These do not appear to be of good quality, 3 prints (currently).
- Roll 48. FBI photographs of interior and view from Room 714, Quality Inn, 16th Street, NW, WDC (where Hinckley once roomed). FBI photographs, 4 prints.
- Roll 49. George Washington Hospital. MPD photos, 9 prints.
- Roll 50. George Washington Hospital. MPD photos, 12 prints.
- Roll 51. Witness photographs -- by [REDACTED]. These are good black and white photos of the incident; Hinckley does not appear to be shown. 30 prints.

GENERAL INDEX

The general index contained herein is not all inclusive. This information is being provided as a general guide in locating names of people, places, and organizations contained in Sections I through XIII from form FD-302 interviews and investigative inserts of this report.

NAME

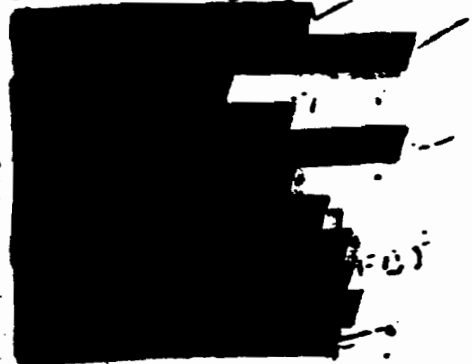
PAGE

	(b)(7)(c)	244, 482, 484,	103 485-489, 507, 509 737, 748
	Y		40 854 523 55
Airport, Nashville, Tennessee		226-229, 234, 512	714-724 469, 508 208
		869, 870, 989-990	570-571, 605 901, 902, 903, 904 58, 59 20-21, 52 504 93 491, 494 916 773 861-862 474 22 1006
American Express Co.			
			
			247 991-992 991-992 557 495 191

NAME

PAGE

(b)(7)(c)



172
 850, 851
 900, 901
 852
 173
 154, 249-251
 253
 36, 92-93, 151
 147-148
 919, 1001
 496, 524
 871, 872
 90
 252, 338
 951, 954
 21
 254
 505
 229
 897
 149-150
 177
 255
 173
 430, 434, 519
 772
 256-257

30, 39, 89, 124, 159, 160, 214,
 226, 227, 245, 289, 296, 306-325,
 337, 353, 372, 379, 427, 452, 481,
 483, 490-494, 505, 509, 522, 525,
 535, 545

170
 102, 103, 106, 125, 127, 138,
 139, 140, 142, 149, 175, 177,
 184, 185, 189, 198, 203, 242,
 243, 365

258-259
 719, 945
 103
 260
 186, 214
 209
 21, 174-176
 835

NAME

PAGE



938, 939, 993-994, 1043

(b)(7)(c)



781
261
991, 992
308
951-953, 954
173
310
573, 574
559, 562, 563
756-757, 761
718
103
509
805
557, 559, 560
262
824



Canterbury Hotel

24-26, 27, 38,

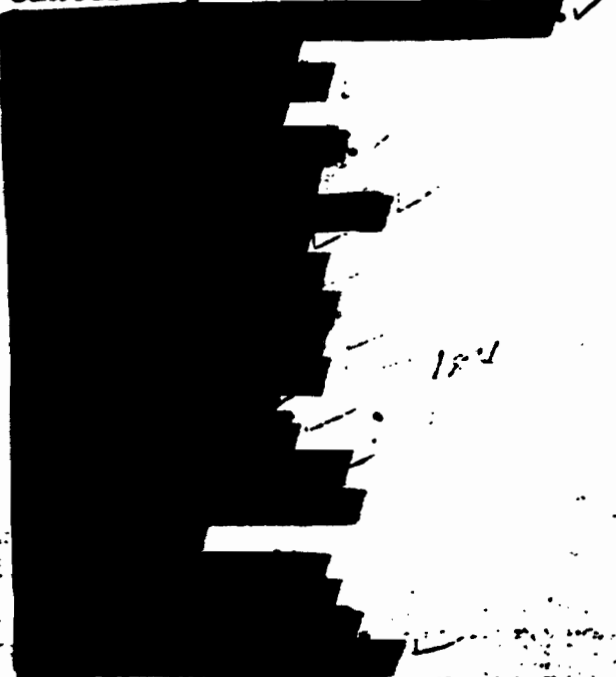

263
461
738-739
178-180
308, 329
737
420
264
817
266, 461
267
118
908-909
499
516
103
450
268
901
515
40
51
937, 938, 1042, 1045
269
963
278
270

Chris's Rx Drug



NAME

PAGE

[REDACTED]

271-272
517
607
274-275
518
869, 989
1030-1039, 1042-1043

Colony Inn

[REDACTED]

730
496, 525
273, 465
473
276-277
474
855, 856, 857, 858-860
84-87
278
870-989
279
164, 165
86
86
282

154, 220, 232, 280-282, 305
280, 281
208
273-274
218-220, 230-232
192

[REDACTED]

831
937, 1044
583
725-728
163
823
283
559, 560, 563, 564
582
226, 232, 234, 235, 240
233
203, 220
709-710, 755
78, 164

85, 86, 149, 166, 170,
296, 306, 415, 416, 452,
499, 500-501, 505, 511

NAME

PAGE

[REDACTED]

(b)(7)(c)

Denver Rescue Mission
Denver Colorado

616-618
796
500-501
772-773
746, 751, 754, 784
702-703, 747
593, 594
595-596
557
804, 806
442
28-31, 32-33
284
811, 812
183
584, 585
88-89

154, 175, 186, 206, 209, 214,
443, 462

[REDACTED]

[REDACTED]

181
226, 308
597
285-287

[REDACTED]

El Paso Texas

199
182
288
34-35
740

[REDACTED]

Empire Pawn Shop

218, 219, 230, 231

[REDACTED]

962
280
599
290
995

36-37, 151, 152, 159, 160
200, 226, 291-292
199, 900
293

[REDACTED]

54, 123, 131, 170
80-91
294
716-717
214

NAME

PAGE

[REDACTED]

(F)(7)(C)

Y

373

804-810
295
159
36, 151-152, 160
292
814
28-40, 41
24, 27, 42, 178
503
516
234-236, 240
898
513, 515
226-227
495
586-587
296
559, 560, 563
600
183
955

752, 871, 872-873, 996-997,
998, 1004, 1005, 1032, 1038

[REDACTED]

297
298-299
531, 536
300-301
855-857, 859
800
191
184-185
302

28, 32, 94, 341, 426, 427
305-306

G. I. Joe's Pawnshop
Galaxy Pawn Shop

[REDACTED]

905, 906, 097, 983, 1015
962, 967, 968
729
43-44
109, 469
183
526
305
226
843

NAME

PAGE

[REDACTED]

(b)(7)(c)

244, 482, 484, 485, 489
 29
 730
 878
 527
 764-769, 1006, 1010
 21
 960, 961
 528
 499, 511
 503, 504, 529
 222
 92-93, 136, 147
 874
 825
 154, 164
 45-46, 77, 616
 79
 54, 90, 105, 135
 36, 37
 303-309
 607
 94-95, 96-98, 118
 92
 307-312, 313
 875-877
 598
 826
 154
 192
 314

Golden Hour Motel

[REDACTED]

[REDACTED]

509, 510, 515
 315
 209
 99
 316
 199
 153
 878
 771
 317
 154-155
 444
 318

(b)(7)(c)



[REDACTED]

[REDACTED]

[REDACTED]
Holiday Inn Columbus, Ohio

[REDACTED]

Hotel Duncan

[REDACTED]

[REDACTED]

IRS

319
61
704
830
530
511, 559, 560, 564
1043
557, 563, 588, 606
186-187
163
320-323
469
560, 562, 564, 577
100
560
324-326
519-520, 521
515
727-728
899
36, 151, 156
829
917
876
918-920
1037
1004-1005, 1030-1047
9, 754, 921-922, 923, 927
940, 999-1001, 1037
876, 916, 924-925, 927, 1002,
1003, 1037
531
804
807
919, 1001
919, 1001
327
532
512
731
606
101-104
817
805
203
559, 560, 563, 573-574
751
43
894-895

NAME

PAGE

(H)(7)(c)



[REDACTED]

879-880
559, 560, 563, 572
852, 853
97, 105-106
490, 533
328-329
898
311
811
490
330
534
782
965-966
1034, 1044
469
804, 813
331
559, 560
564

[REDACTED]

47
462
427
64
428
334
332-333
742-744
845
468, 469
335-336
878
237
746, 751
337
107
1043
157
967

Kaye's Diner

558, 559, 560, 562
770, 771
896-897

[REDACTED]

Kennedy Airport, NYC

[REDACTED]

Kittredge College

[REDACTED]

483, 490-494, 535
509
536, 539
887
218, 219, 220, 223-224, 230

NAME

PAGE

[REDACTED]

(b)(7)(c)

↓

589-591
558, 577
252, 338
203
36, 151, 158-159
339, 340
261, 297, 341, 466
21
236, 237, 238

[REDACTED]

LaGuardia Airport

[REDACTED]

199
828
342-343, 350
345
904
346-347
729
764, 769, 1006
764, 769, 1006
48
49
348
188
901
189-190
103, 503, 507, 508
738
537
349
89, 97, 124
108-109, 468

"Listalot"

[REDACTED]

Look-out Mountain, Golden, Colorado

[REDACTED]

Los Angeles California

[REDACTED]

897
342
350
80
118
110-111
112-113
50, 71
775-777
351
132
114-115
784-786
846, 847, 848
846, 847, 848

NAME

PAGE

(b)(7)(c)

Y

[REDACTED]

352
36, 151, 152, 160-161
293, 353-354
968
892
293, 355
714-715, 1012-1013
863

[REDACTED]

356
560
357
1043
512
358
359, 403
793-794
817
795, 805
804
361
539
360
935
72
239
362
970
839
469

775-777

113
80, 89, 97, 275, 286, 296,
306, 324, 325-326

55, 71

111

50-51

55, 90, 92, 94, 95, 102, 103,
121, 131, 135, 138, 139, 140,
142, 145, 149

97, 120, 124, 156, 159, 415,
416, 434, 452, 495-498, 505,
510, 520, 522, 540

[REDACTED]

McCarthy, Tim

McCarthy, Timothy

NAME

PAGE

McCarthy, Timothy J.

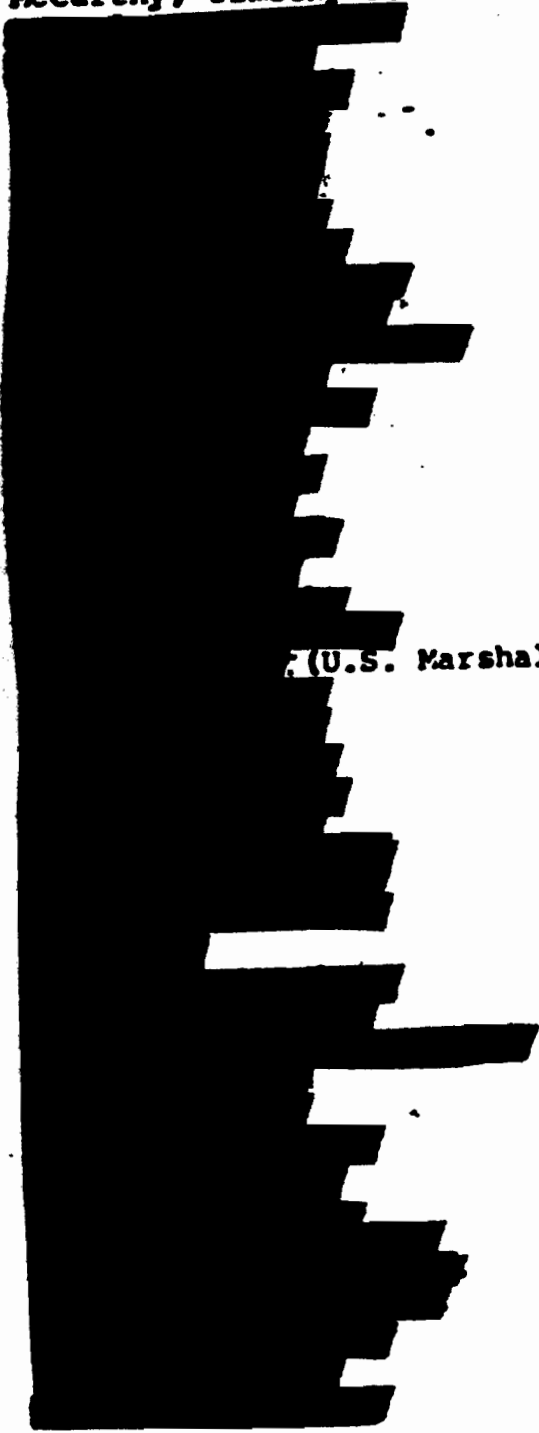

(b)(7)(c)

Y

116-119, 133, 612-615

153

770

763, 778-780

363

804

499

90, 91, 123, 131

118

120-121, 540

364

366

191, 207

52-53

307

822

367

51

833

286

368

1041, 1045

559, 562, 575, 576

887

103, 508

510

91, 122-123, 131

508

726, 1014

369-370

220, 232

109, 468, 470-471

40

371

58

54-55, 90, 115, 134

557, 558, 559, 601

469, 582

899

434, 522

372-373

841, 842

374

787

375

NAME

PAGE

(b)(7)(c)

↑

[REDACTED]

Motel Six Lakewood Col.

[REDACTED]

44
804, 808
376-378
559, 560, 563
115, 124-125
877, 887
811, 816
906, 907, 1015
379-381
382
762, 763, 778-783
383-384
40
462
385-386
226, 234, 235, 240-241
541
562
94
387, 388
412

[REDACTED]
National Federation Party
National Socialist Party of America

[REDACTED]

389
390
963
496
879
989, 990
817, 819, 820
881
849
811, 812
602
162
811
762
21
754
163
909, 910
908, 909, 910
745
391

Northwestern National of Milwaukee
Northwestern National Life Insurance Co.

[REDACTED]

NAME

PAGE

[REDACTED]
Opryland Hotel, Nashville, Tenn.

(b)(7)(c)

472
496
219, 231
495, 542
559, 560, 564
817
711, 712, 713
392
393

[REDACTED]

[REDACTED]
Park Central Hotel

559, 560, 564
79, 80, 81, 557-561, 572, 574,
602, 604, 606, 1004, 1005, 1038
747

Park Plaza Hotel, New Haven, Conn.

778-792, 836, 1016-1020
394

[REDACTED]

93, 94, 103, 110, 117, 118, 120,
122, 123, 130, 135, 136, 138, 427,
502, 610

[REDACTED]

126-127, 503
395
837
473
758-760
396-397
543
708, 746, 754
882-884
924, 927, 1000, 1001, 1002
400
364, 398, 399
797-799
800, 802, 803
495, 496
56-57
558, 560, 562
505
732
58-60, 192
812
729
376
827
21
817, 818
878
514, 546

Pittsburgh, Pennsylvania

[REDACTED]

NAME

PAGE

(b)(7)(c)



[REDACTED]

242
834
401
402, 444
318
815
811
172, 185, 193-194

Quality Inn, WDC

[REDACTED]

732, 736, 749
359, 403
881
404
1042-1045

[REDACTED]

406, 433
405
407
51
578, 1042-1045
97
164-165
77
408
409
511
935-936

Reagan-Bush National Camp. Hdqs.

Reagan, Nancy

Reagan, Ronald

991, 992
127
609-611

[REDACTED]

93
410
504
503
517, 544
527, 533, 532, 533, 547, 547

Rocky's Pawn Shop
Rocky's Police Equipment

844
855, 856
24, 178
885
411-412
600
960-961
72

NAME

PAGE

(b)(7)(c)

↓

[REDACTED]

832
197-198
143
61
192
249
64-65
62-63
185
413, 414
94
226, 243, 245, 481, 482, 483
415-416
505
66
741
204
199

[REDACTED]

Salt Lake City

[REDACTED]

783
200-201
199
784, 785, 786, 788, 789, 790
562, 563, 564, 573, 574, 575
557, 560
67-68
872, 886
603
417-418
128
736
410
419
129
1046-1047
90-91, 105, 120, 123, 126, 139,
544

[REDACTED]

Sheraton Center, NYC

[REDACTED]

130-131
731
420-421
23, 174
849
741
56
422
202
280

NAME

PAGE

(b)(7)(c)

↓

[REDACTED]

Snidley Whiplash's Pawn Shop
Social Security Administration

[REDACTED]

Steak 'N Ale

800, 819
58
433
166
308
423
519
521-522
838
103
925, 926-929, 1003, 1037
926
821
424
335, 341
305, 306
545
518
969
425
604
335
69-70
809, 813
804
426, 427, 817
962, 968
892, 893
513
579, 580
428, 429
430-431
432
558, 559, 564, 1047
55, 80, 101, 102
55, 80, 101, 102
71-72
132
50, 97, 111, 113, 144
433
504
172
713
740
191, 206, 214
191, 206, 214

(H)(7)(C)

Y

[REDACTED]

845
372
434
706-707
435
73-74, 75
76
436
930
203-205, 212
50, 77-79, 80-81, 111, 583
903

[REDACTED]

Taylor Supper Club

749
705
844
437-438
894, 896
439
440-441
167
897, 901
29
811, 812
442-443
82
318, 383, 402
444-445
546
114, 115
132-134

[REDACTED]

Top of the Park, New Haven Park Plaza Hotel,
New Haven, Connecticut

705
151
581, 592
507, 508
510
606
495-498, 547
469
446
191, 206-207, 209, 214
191
447
203, 212
503
36, 37
168-169
154, 423, 449
725, 1021

[REDACTED]

NAME

PAGE

United States Capitol Building, WDC

(b)(7)(c)

745
93, 126, 127, 130
135-136

Vanderbilt Energy Company

448
999, 1002
118, 137-140
89
711, 712
449
412
427
450

451
916
452
811
307

90, 101, 113, 133,
134, 139

118
141-142
887, 888
208
453-455

456
143
93
308

559, 562, 575, 576
522

457
186, 209-211
107

506, 509, 510, 515, 516, 518

931
548
85

840
203, 204, 212-214

469
170
127
503
139

NAME

(b)(7)(c)

PAGE

↓

[REDACTED]

1043-1044
512
133
549
558-559
460
90
133
144-145
191
206, 214-215
174
461
784-786
139
115
216
462-453
559, 560, 563, 572
905, 983, 1015

[REDACTED]

250
465

[REDACTED]

716
550
466
250