

BAZOOKA

How to Build Your Own



ANTHONY LEWIS

PETER A. PIERRINI
TECHNICAL ADVISOR

BAZOOKA

How to Build Your Own

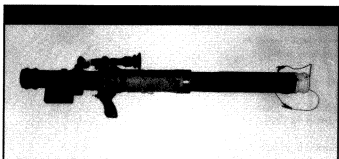

ANTHONY LEWIS

PETER A. PIERRINI
TECHNICAL ADVISOR

PALADIN PRESS
BOULDER, COLORADO

Bazooka:
How to Build Your Own
by Anthony Lewis

Copyright © 1993 by Anthony Lewis

ISBN 0-87364-738-6

Printed in the United States of America

Published by Paladin Press, a division of
Paladin Enterprises, Inc., P.O. Box 1307,
Boulder, Colorado 80306, USA.
(303) 443-7250

Direct inquiries and/or orders to the above address.

All rights reserved. Except for use in a review, no
portion of this book may be reproduced in any form
without the express written permission of the publisher.

Neither the author nor the publisher assumes
any responsibility for the use or misuse of
information contained in this book.

Illustrations by Peter A. Pierrini, technical advisor.
Photographs by Robert Preston.

CONTENTS

1	INTRODUCTION	1
3	CHAPTER 1 PARTS LIST	3
7	CHAPTER 2 BAZOOKA CONSTRUCTION	7
23	CHAPTER 3 PROPELLANT	23
27	CHAPTER 4 IGNITERS	27
37	CHAPTER 5 ASSEMBLING AND LOADING THE CARTRIDGE	37
41	CHAPTER 6 TEST-FIRING AND SIGHTING	41
47	AFTERWORD	47
49	APPENDIX A A FEW POINTERS TO BEAR IN MIND	49
51	APPENDIX B TROUBLESHOOTING	51
53	RESOURCES	53

WARNING

Technical data presented here inevitably reflect the author's individual beliefs about and experience with particular firearms, equipment, and components under specific circumstances which the reader cannot duplicate exactly. The information in this book should therefore be used for guidance only and approached with great caution. Neither the author nor the publisher assumes any responsibility for the use or misuse of information contained herein. *This book is for information purposes only.* All Bureau of Alcohol, Tobacco and Firearms (BATF) rules apply.

INTRODUCTION

I guess that since you're reading this book, like me, you get a certain pleasure from the flash and thud of an explosion—especially one that originates from a device you have constructed with your own hands.

Although I like a good bang, my interest does not lie in the maiming or killing of people and critters, but in the problems and success involved in the construction of soft munitions, propellants, and weapons. My aim is to make weapons and ammunition from readily available items (I am regularly found hanging around hardware stores and junkyards, which have been a great source of inspiration), with an emphasis on flat-trajectory firing, taking the plinking of targets to a new high.

My first construction attempts were pretty sophisticated butane-propelled weapons, which produced a fair amount of plaster damage in my attic, but I have shelved these ideas for now and gone on to a faster and more reliable system that looks more like the real thing.

One main problem I faced was finding areas in which to test-fire and sight the weapons, as their range dictates the need for a large area that is isolated enough not to draw any

unhealthy interest in the variety of explosions and consequent whoops of joyous laughter.

Having resolved the test-firing dilemma by finding a sympathetic farmer who allowed various forms of shooting on his land, I then needed a projectile that would not blast holes through the targets. I opted for an effective, fun, soft munition that would maintain its shape during flight, be reloadable, and be reasonably easy to find. The tennis ball seemed a natural choice. I tried squash balls, baseballs, plastic bottles, and even rocket-propelled devices; all work, with pluses and minuses, but the tennis ball gave me the most pleasure.

Next came the propellant. I tried all manner of charges, ranging from gasoline to butane and propane to reloading powders and homemade mixtures. I finally settled on an easily made two-part mix, which is found in cherry bombs, air bombs, M-80s, and most powerful fireworks. Among the few books that offer information on this, *The Firecracker Cookbook*, by Edwin Lough, is one I found to be very useful (Firepower Publications, Cornville, Arizona 86325).

The bazooka is not difficult to make; after all, it is only a barrel with a few main items fastened in place. So read the manual a couple of times (I usually find the toilet a good place to absorb information—it's one of the few places that offer peace and quiet), follow the procedures step by step, and before you know it you will be blasting away like GI Joe on a good day.

The bazooka is designed for a right-handed shot, but if you are left-handed, the open sights are all that you will need to switch to the opposite side of the barrel.

I have tested the bazooka beyond its normal firing pressure with no ill effects, so read on, construct, be careful, and most of all, enjoy yourself!

PARTS LIST

As you can see, the list that follows contains what appears to be a large number of items. Do not be put off; they are all easily available and cheap. I have tried to think of every item you will need, so as to save you time and effort.

MATERIALS

- one length 7' PVC drainpipe, 2 1/2" inside diameter (ID)
- drainpipe connector (to fit snugly into drainpipe)
- 20' Nichrome .002-inch diameter insulated electrical wire
- coarse fiberglass matting (enough to cover the length of the barrel)
- one tin of resin and hardener
- high-density foam sheet
- batteries and holder
- flashlight and holder
- push-on/release-off electric switch
- two alligator clips
- two 3/16" x 1/2" cap screws and nuts
- six 1" x 8-gauge wood screws

- aluminium plate 2 1/2" x 1 1/2" x 1/4"
- 6" x 1" x 1" angle iron
- one roll 2" gummed postal tape
- tennis balls
- fine wire wool
- aluminium foil
- potassium perchlorate
- aluminum powder
- potassium chlorate
- white sugar
- strike-anywhere matches
- airtight container
- gloves and eye protection
- four 4" hose clips
- one tin contact adhesive (for PVC)
- insulating tape

WOOD (HARDWOOD, SOFTWOOD, PLYWOOD)

- one 4" x 5" x 1 1/8" piece
- one 6" x 3" x 1" piece
- one 2 1/2" x 30" x 1/2" piece marine-grade plywood

TOOLS

- coarse and fine sandpaper
- soldering iron and fine solder/flux
- wire strippers
- hacksaw or tenon saw (fine-tooth blade)
- screwdrivers
- electric jigsaw or coping saw
- electric drill and drill bits
- half-round file
- fine grinding stone (modeling type)

- scissors
- hole cutter
- small scales (to weigh in grams)
- spoon (small)
- pestle and mortar
- tumbler

It is not essential to stick to the parts and tools listed; you may find better and cheaper alternatives.

The essential items are the PVC drainpipe and respective connector. The pipe must have a 2 1/2" inside diameter, and the connector has to be a snug fit to ensure an airtight seal. There are other types of tubing in a wide variety of bores (mainly in ABS and PVC) that can be used and are quite adequate, but the drainpipe is easier and more readily available.

In fact, as I was developing various soft-munition weapons, my main problem was the barrels. I first used the ideas of Jeff Baker and Thomas Tribble, as presented in their *Homemade Mortar Construction Manual* (published by Paladin Press). I found the information to be most stimulating, and I soon took their basic weapon to a more sophisticated level.

The soda-can barrel is an excellent fit for a tennis ball but is easily damaged. Reinforcing the barrel with fiberglass matting and resin seemed to solve the problem, but it was a time-consuming task. I tried cardboard tubes reinforced with fiberglass, but again, it was not exactly what I wanted. Then one day down at the local hardware store stood the barrel of my dreams, all shiny and new, ready-made for the job. It was a humble drainpipe. This discovery was as important to me as the discovery of spinach was to Popeye. Since that day, my armory has flourished to the extent that it would make Saddam Hussein jealous.

BAZOOKA CONSTRUCTION

CARTRIDGE

We will start with the cartridge, as it helps in the construction of the barrel. I needed a cartridge that was tough, cheap, easy to reload and clean, a tight fit for a tennis ball, but most of all, easy to make so it could be mass-produced.

I found it hanging out with the barrel, just begging to be put to a more exciting use than connecting two pieces of drainpipe. Yep, that's right—it's a drainpipe connector, one end of which pushes tightly into one half of the drainpipe, while the other half of the drainpipe fits into its wider neck.

The end of the connector that pushes into the barrel has a smaller inside diameter than the barrel, ensuring a good tight fit for the tennis ball (which, as with a bullet, is essential if the propelling charge is to work properly).

So now you need to fill the wider end of the connector, blocking the back end of the cartridge to prevent any of the explosion from escaping out the back. For this I used two disks of wood that I cut using a jigsaw and then sanded to a very close fit. I then screwed them into place, using some

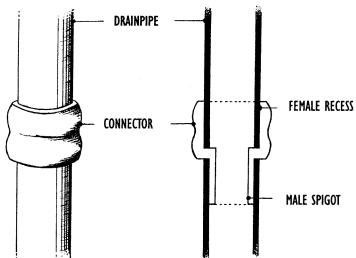

FIGURE 1

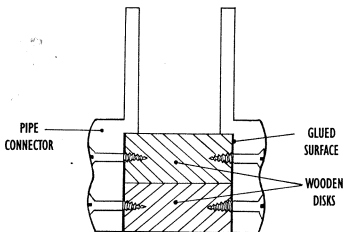

FIGURE 2

glue to ensure a good, airtight fit. (Because of the variety of connectors on the market, I cannot specify the diameter or thickness of the wooden disks.)

Next you must fit the lugs, which will act much like a pinned light bulb (a standard household bulb that has two pins protruding from its metal body as opposed to being threaded) and will lock the cartridge into the back of the barrel. The lugs are made from two cap screws with a 3/16-inch thread size and two nuts to suit. They need to be fitted opposite each other on either side of the connector, 3/8 inch from the top edge.

To help with this, take a strip of paper the same width as the distance from the shoulder of the connector to 3/8 inch from the top edge and wrap it around the connector neck, then mark where the two ends of the paper meet. This gives you the circumference of the connector. Now fold it in half to get an accurate measurement of 180°, and you can mark and drill the connector to fit the lugs.

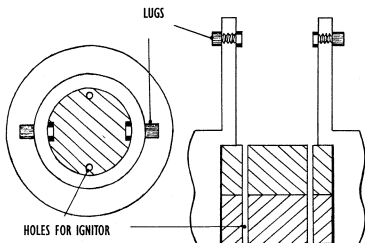

FIGURE 3

Push the cap screws in and, using a thread glue, lock the nuts into place and allow them to dry. Then file the nuts down with a half-round file, enough so that they are secure but the tennis ball can still push past them.

Lastly, drill two holes, 1/8 inch in diameter, into the wooden disks for the igniter wires. To help with reloading, the holes need to be as near to the inside edge of the connector as possible and 90° from the lugs. This makes it easier to thread the wires into the holes and ensures that the lugs will not obstruct the propelling charge when it is being loaded. From here on, the connector will be referred to as the cartridge.

BARREL

The barrel is the basis of the bazooka and is the most time-consuming part of constructing one. Because of the pressure the barrel is expected to take during firing, especially in the breech, it is worth taking your time on.

The bazooka not only needs to work, it should also look good—after all, it is your baby. So if the drainpipe you settle on has any molding at one end, leave it on; this can become the business end. Let's begin.

Take your 7-foot length of drainpipe and cut off a 40-inch length, keeping the cut as neat as possible. Use the fine sandpaper to achieve a smooth finish.

Now, applying the method we used for the lugs on the cartridge, you need to mark the barrel where the lug slots will be cut. So mark the 180° points, the same distance in from the end as the distance from the cartridge shoulder to its lugs, and scribe a line between them. Next, you need to cut the slots out so that the lugs will slide in and fit tightly. You do this by using a drill bit the same diameter as the cap screw heads. Drill out a slot down the length of the scribed line (be sure not to press too hard, as it is possible to crack the PVC), remove the PVC that the drill has left with a

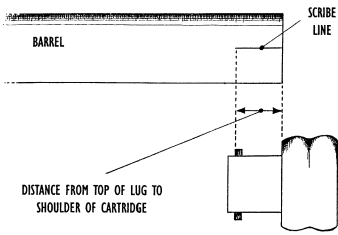

FIGURE 4

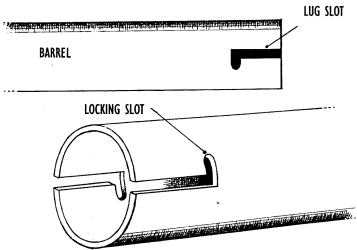

FIGURE 5

fine-blade saw, and then sand it smooth so that the cartridge will slide in and out smoothly.

Next you must cut the locking slots, which keep the cartridge from shooting out the back of the barrel when fired. Both should face the same way, either clockwise or counterclockwise, and be the same width as the slot and long enough to allow the cartridge to lock securely into place (try to imagine a pinned light bulb socket). Having done this, make sure the cartridge does fit snugly and lock into place.

Now rough the whole of the outer surface of the barrel with coarse sand-paper, which will help the fiberglass resin and glue to adhere to the surface when you are reinforcing it.

Now, to make the first reinforcing sleeve, cut a 16-inch length of pipe from the drainpipe, then cut it neatly along its length and remove any rough edges. Smear glue on top of the barrel 16 inches in from the back, paying particular interest around the slots. It is essential that the bonding of the glue in this area is the best you can achieve, as this is the breech and takes the most pressure. Now slide the 16-inch reinforcing

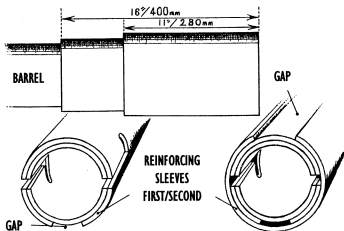

FIGURE 6

sleeve over the barrel until it is flush with the rear, making sure the cut in the sleeve is midway between the two slots. This shall be the underside of the barrel.

Tip: To ensure a good bond between the sleeve and barrel, push an unlugged cartridge into the breech, taking care not to allow any excess glue to bond it into place. Then tighten them using two 4-inch hose clips until no airspace can be seen between the sleeve and barrel. Allow the glue to dry, then cut the slots out of the 16-inch reinforcing sleeve again so the cartridge slides in and fits snugly.

This time cut an 11-inch length of pipe along its length as neatly as possible. Rough the outer surface of the 16-inch sleeve and smear it with glue, then slide the 11-inch sleeve over this until it is flush with the rear of the breech, making sure you get a good bond and that the gap is on top of the barrel this time. There is no need to cut any slots from this sleeve. Now allow the glue to dry. Finally, check that the cartridge is a good, secure fit.

You are already two-thirds of the way there.

PISTOL GRIP

I made my pistol grip from hardwood, but plywood or softwood will do. I just like the tight grain of hardwood, and it has a nicer finish. You will need a block of wood 4 by 5 by 7 1/8 inches. Scribe the measurements detailed in Figure 7 onto the block, cut the grip out with a coping saw (or better yet, an electric jig-saw), and then round it off with a rasp and sandpaper.

Drill a 1/8-inch hole through the middle of the pistol grip to run the trigger wires through.

Next, make a plate for the top of the pistol grip so that it fits securely to the barrel by taking the pressure off the two hose clips when they are tightened. I used 1/4-inch plate aluminium, but steel or brass will do. Drill and recess the plate

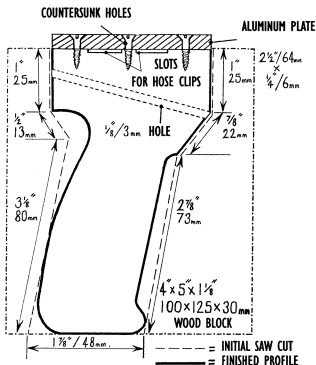

FIGURE 7

to accept three 1-inch-by-8-gauge wood screws, plus cut two slots crossways into the top of the pistol grip wide enough for a hose clip. This is so that when the plate is fastened down, it will fit flush with the top of the pistol grip.

Now place two of the hose clips into the slots cut across the top of the pistol grip and fasten the plate into place.

SIGHTS

I have used single-point sights (as once used by the

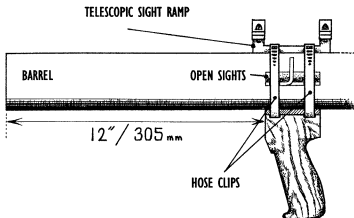

FIGURE 8

Swiss army but now commercially available for civilian use) that put a red dot over the target, allowing the firer to keep both eyes open. They are also good for use with moving targets, but telescopic or open sights will have the same effect on a target.

I am covering sights now so that you can decide whether you want to use telescopic sights, which require fitting the sight ramp on top of the barrel, or open sights, which fit onto the side. This must be done before we fit the pistol grip, as it is the hose clips of the pistol grip that will fasten the sights in place.

The pistol grip and sight ramp/bracket need to be fastened 12 inches back from the front end of the barrel. Do not overtighten the hose clips, as this will distort the barrel. When the barrel is fiberglassed, this will hold everything securely in place.

The open sights are the most versatile for varying ranges. (I will cover the setting of the sights later in the book.) Of course, you could always fit both types of sight and get the best of both worlds.

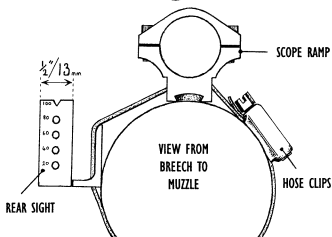

FIGURE 9

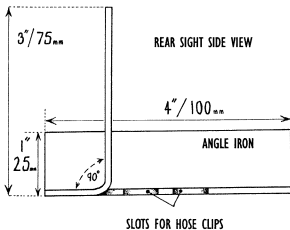

FIGURE 10

How to Make Open Sights

Rear sight: Take a 4-inch length of 1-by-1-inch 90° angle iron, and make a 3-by-1/2-inch cut along the length of one side. Now bend this strip up until it is 90° from its original position. Next, into the sight bracket on the same side as the sight leaf (see diagram), cut two slots wide enough for the hose clips and the same distance apart as those you cut in the pistol grip. Finally, file any sharp edges off the bracket. The rear sight is now ready for fastening into place.

Front sight: The front sight is very similar to the rear sight, but the dimensions are different (fig. 11). Take the remaining 2-inch length of angle iron and again make a 1-by-1/2-inch cut along one side and bend it to 90°. This time cut only one slot for the hose clip into the same side as the foresight leaf. You could file the leaf to create a more interesting shape in order to provide a better sight picture.

The front and rear sights must be positioned along a horizontal line so that when the bazooka is placed on your shoulder you have a clear and comfortable view down the sight

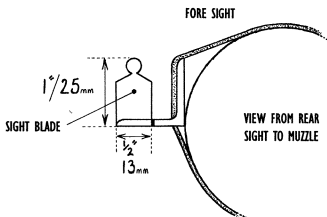
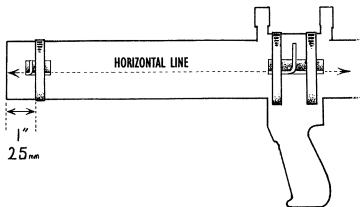

FIGURE 11



Position of open sights.

FIGURE 12

line. The distance between the front and rear sight should be as great as possible for optimal accuracy (fig. 12).

BATTERY HOLDER

For the power source, I modified a square Duracell flashlight, the type that takes two 1.5-volt batteries. I removed the light unit, leaving only the battery case, and then slotted the case to take a hose clip, making sure that once everything was fastened in place I could still change the batteries easily.

You can use any power source, so long as it is not too large or heavy, is easy to replace, and can be fastened onto the barrel. One thing to think about, however, is the bigger the capacity of the battery or batteries, the greater the choice of igniters. For instance, a 6-volt battery will short bridging wires used in one type of simple igniter, whereas the two 1.5s won't.

The battery holder can be used as a rest when placed in front of the pistol grip and so makes for a more stable firing

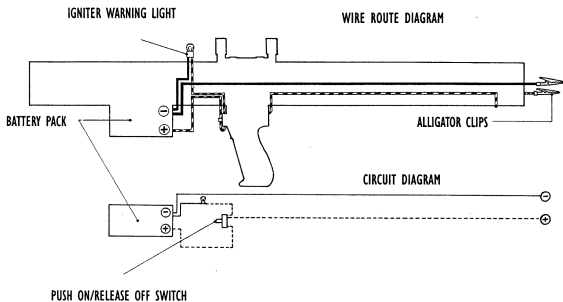

FIGURE 13

position. It is up to you to find the most comfortable position before fastening it into place.

WIRING

The wiring obviously needs to be reliable, but all the more so in this case because it will be fiberglassed in place. Check each length of wire for a circuit using a battery and bulb before soldering it into place. Solder every join, as this is the best way to ensure a good connection.

I suggest building an igniter warning light into the wiring to show if there is a circuit going to the alligator clips, thus preventing any accidental discharges when loading, plus any accidental staining of your pants.

The trigger must be an electrical switch of the type that creates a circuit when you keep the pressure on the button but breaks the circuit on release. This you can either glue or screw onto the pistol grip.

Follow the simple wiring diagram, and use a wire with a low resistance because the length of the wires will sap the batteries of power. Where the wires run across a gap along the barrel, pass them through a small-diameter tube and tape them in place. This protects them from coming in contact with the fiberglass and is therefore helpful should you have to replace any wires.

As you secure the wiring in place, make sure the alligator clips will reach the igniter wires and are level with the lug slots in the breech. Before going any further, be certain there is a good circuit to the alligator clips.

FIBERGLASSING

Before you start any fiberglassing, check to be sure all the fittings on the barrel are secured in their correct places.

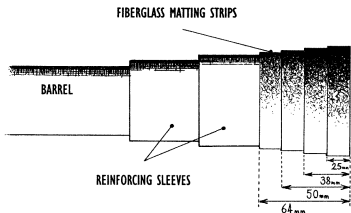

FIGURE 14

Although fiberglassing is a messy process, I find the medium to be tough, easy to work with, and cheap. Provided you take care around the fittings, you will find it bonds and secures extremely well and makes a strong shell to strengthen the barrel.

A few quick tips before you start: Have your fiberglass matting cut to length. Mix the resin/hardener in small amounts, as it dries rather quickly. Use an old paintbrush, as it will no longer be of use when you are finished. Work as quickly and neatly as possible. Here we go.

Following the mixing procedure on the can, make about 1/8 pint (100 ml.) and coat the two reinforcing sleeves with resin. Once these are thoroughly covered, add the matting and work it with the brush until the matting is well soaked and fits closely to the contours of the barrel. You should now have an idea of how quickly the resin dries and be able to work accordingly.

Now do the same for the rest of the barrel, one section at a time, taking extra care when securing the battery holder/pistol grip and sights. The stronger the fit, the better. It pays to

make as neat a finish as possible; it will save a lot of elbow grease later.

Once the resin has dried, you must add extra reinforcing around the breach. To do this, cut four strips of matting. Make the first strip long enough to go around the breach, and then make them progressively longer, as they will be placed one on top of the other.

Make the first and longest strip 2 1/2 inches wide, then cut them 2 inches, 1 1/2 inch, and 1 inch wide, respectively. Starting with the 2 1/2-inch strip, resin it in place, flush with the back of the breach. Follow with each strip getting progressively smaller, keeping each flush with the back of the breach. Make sure no resin gets into the lug slots.

Once everything has dried, check that everything is secure, the alligator clips move freely and still reach the cartridge, and there is still a good circuit. Take your sandpaper and give it a smooth finish to prepare it for the paint job (I did mine in satin black, giving it a mean and purposeful look). Lastly, you could fit a sheet of high-density foam just behind the pistol grip for your shoulder to rest on, making it look that much more professional.

So the hard part is out of the way, and you should have something to be proud of. Now comes the fun part, so let's get on with it.

PROPELLANT

As I have already said, I have tried all types of propellants with a variety of successes and failures, but it wasn't until I purchased Edwin Lough's *The Firecracker Cookbook* (Firepower Publications) that I found what I was looking for. This book is very thorough and contains some fun ideas.

The mix I chose is used in M-80s, cherry bombs, and most other powerful fireworks. It is easy to prepare, as it is comprised of only two ingredients, but, like most mixtures, it does not like moisture, so keep it dry.

MATERIALS REQUIRED

- potassium perchlorate
- aluminium powder
- potassium chlorate
- white sugar
- strike-anywhere matches
- pestle and mortar
- tumbler
- scale that weighs in grams

- small spoon
- airtight container
- gloves and eye protection

MIXING TIPS

Read *The Firecracker Cookbook*. It contains everything you need to know about mixing and safety. Wear gloves and eye protectors when handling and mixing the propellant. Wear sunglasses when testing the potency of the mix, as the bright flash can damage your retinas.

If you're concerned about nosey persons taking an interest in your purchasing of the required chemicals, here are a few precautions I use.

- Never buy the whole batch from one chemical supplier.
- Never buy chemicals around traditional times of the year for firework displays.
- Always have a ready excuse for buying such chemicals. Such excuses can be found in the local library. Look under chemical uses and hazards, then use a bit of imagination. (I must admit I have never been asked, but it doesn't hurt to be prepared.)
- Using your real name and address will build a record of your purchases, so use a pseudonym or send a well-briefed buddy now and again.

I know these precautions seem a bit extreme, but such caution pays when you live in a suspicious society.

A problem I encountered with my first batch of mixes was its reluctance to ignite or even explode. After a great deal of

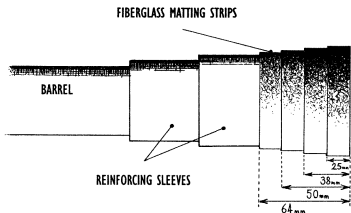

FIGURE 14

Although fiberglassing is a messy process, I find the medium to be tough, easy to work with, and cheap. Provided you take care around the fittings, you will find it bonds and secures extremely well and makes a strong shell to strengthen the barrel.

A few quick tips before you start: Have your fiberglass matting cut to length. Mix the resin/hardener in small amounts, as it dries rather quickly. Use an old paintbrush, as it will no longer be of use when you are finished. Work as quickly and neatly as possible. Here we go.

Following the mixing procedure on the can, make about 1/8 pint (100 ml.) and coat the two reinforcing sleeves with resin. Once these are thoroughly covered, add the matting and work it with the brush until the matting is well soaked and fits closely to the contours of the barrel. You should now have an idea of how quickly the resin dries and be able to work accordingly.

Now do the same for the rest of the barrel, one section at a time, taking extra care when securing the battery holder/pistol grip and sights. The stronger the fit, the better. It pays to

make as neat a finish as possible; it will save a lot of elbow grease later.

Once the resin has dried, you must add extra reinforcing around the breach. To do this, cut four strips of matting. Make the first strip long enough to go around the breach, and then make them progressively longer, as they will be placed one on top of the other.

Make the first and longest strip 2 1/2 inches wide, then cut them 2 inches, 1 1/2 inch, and 1 inch wide, respectively. Starting with the 2 1/2-inch strip, resin it in place, flush with the back of the breach. Follow with each strip getting progressively smaller, keeping each flush with the back of the breach. Make sure no resin gets into the lug slots.

Once everything has dried, check that everything is secure, the alligator clips move freely and still reach the cartridge, and there is still a good circuit. Take your sandpaper and give it a smooth finish to prepare it for the paint job (I did mine in satin black, giving it a mean and purposeful look). Lastly, you could fit a sheet of high-density foam just behind the pistol grip for your shoulder to rest on, making it look that much more professional.

So the hard part is out of the way, and you should have something to be proud of. Now comes the fun part, so let's get on with it.

PROPELLANT

As I have already said, I have tried all types of propellants with a variety of successes and failures, but it wasn't until I purchased Edwin Lough's *The Firecracker Cookbook* (Firepower Publications) that I found what I was looking for. This book is very thorough and contains some fun ideas.

The mix I chose is used in M-80s, cherry bombs, and most other powerful fireworks. It is easy to prepare, as it is comprised of only two ingredients, but, like most mixtures, it does not like moisture, so keep it dry.

MATERIALS REQUIRED

- potassium perchlorate
- aluminium powder
- potassium chlorate
- white sugar
- strike-anywhere matches
- pestle and mortar
- tumbler
- scale that weighs in grams

- small spoon
- airtight container
- gloves and eye protection

MIXING TIPS

Read *The Firecracker Cookbook*. It contains everything you need to know about mixing and safety. Wear gloves and eye protectors when handling and mixing the propellant. Wear sunglasses when testing the potency of the mix, as the bright flash can damage your retinas.

If you're concerned about nosey persons taking an interest in your purchasing of the required chemicals, here are a few precautions I use.

- Never buy the whole batch from one chemical supplier.
- Never buy chemicals around traditional times of the year for firework displays.
- Always have a ready excuse for buying such chemicals. Such excuses can be found in the local library. Look under chemical uses and hazards, then use a bit of imagination. (I must admit I have never been asked, but it doesn't hurt to be prepared.)
- Using your real name and address will build a record of your purchases, so use a pseudonym or send a well-briefed buddy now and again.

I know these precautions seem a bit extreme, but such caution pays when you live in a suspicious society.

A problem I encountered with my first batch of mixes was its reluctance to ignite or even explode. After a great deal of

frustration, I finally stumbled upon the answer: the aluminium powder was not fine enough. It certainly appeared to be, but I discovered it had to be like dust, such that when I opened the lid of the jar it almost floated out. From that day on, I've never had an earwax problem.

Before you begin, a few words of warning. Potassium chlorate is shock-sensitive and if combined with any sulphur will become even more so, so handle with care. I once had a nasty experience with potassium chlorate and a sulphur mix, one which I do not wish to repeat, so stick with the mixture I am going to describe. Potassium perchlorate is more stable and does not need to be mixed with sulphur for good results. Be sure all utensils have been cleaned thoroughly. When purchasing any chemicals make sure they are as pure and as fine as possible. This helps a great deal when mixing. Lastly, keep your aluminium powder sealed when not in use so that it will not oxidize, making it less efficient. The aluminium needs to be as fine as possible, almost like fingerprint powder used by the police, or the results will be poor.

Before we go any further, a quick word about mixing. I used a homemade tumbler, which I put together using a 12-volt electric motor with an airtight plastic tub fastened onto its threaded shaft. It is powered through a model train set transformer with variable voltage, allowing for various tumbling speeds. Inside the tub I use seven glass marbles as crushers and tilt the tumbler so the mix is constantly feeding itself back into the crushers. Alternatively, if you have some spare cash you could always buy a tumbler used for stone polishing or cartridge case cleaning. For crushers, use only balls that will not create sparks and are not so heavy as to set off any shock-sensitive materials. I use an extension cord on my tumbler so I can turn it on and off without getting too close, and I do the tumbling in a room that is not too impor-

tant to the structure of my house. You could also use a pestle and mortar. If you choose this method, *always* wear gloves and eye protectors and only mix small amounts. I only use this method to crush big lumps before mixing in the tumbler.

Use the scale to measure out seven parts potassium perchlorate to three parts aluminium powder. Now mix them as finely and as thoroughly as possible by hand or, better still, leave it in the tumbler and test small samples until you feel it is ready.

TESTING

Place a small amount on a brick and ignite it using a taper or something that keeps your hands away from the flash. It should burn fiercely bright and almost pop. I always wear sunglasses, as the flash will damage the eyes.

Once you are satisfied with the mix, seal it in an airtight tub until ready for use.

Always clean utensils and tumbler after a mix has been completed to prevent any possible contamination. Now you're ready to make the igniter mix.

IGNITERS

IGNITER MIX

For the igniter mix, I use one part potassium chlorate and one part sugar by weight and mix thoroughly. This mixture burns fiercely and is very gaseous. Again, store it in an airtight container.

IGNITER HOUSING

I prefer to use the method I am about to describe for the housing, because once made it can be used many times; in fact, I have not had to replace any as yet.

You'll need a 2 1/2-by-30-inch sheet of 1/2-inch-thick marine-grade ply and a hole cutter (available at any plumbing or hardware store, this is a set of circular blades set in a metal housing with a drill bit down the middle to keep the whole thing centered when in use). Select the 2-inch blade on the hole cutter and cut out as many disks as you think you will need for a plinking session. Next, select the 1 1/2-inch blade and drill the centers out of the disks, taking care not to splinter the surface as the blade exits the wood. Now take a 1/16-

*Igniter housing.*

FIGURE 15

inch bit and drill two holes opposite each other through the center of the wood to run the igniter wires through. That's the igniter housing completed.

IGNITERS

There are three criteria the igniter must meet: it has to be fired electrically, it has to be reliable, and it must be either easily made or easily available. I prefer to make my own, but I shall leave the choice to you. Here are four options for you to choose from.

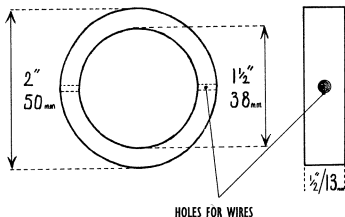
1. If you choose to buy them, try the Estes rocket igniters (and while you're at it, you could use their launch controller instead of a battery pack and trigger). The white

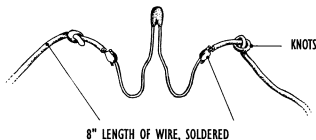

Estes igniter.

FIGURE 16

type used in the D-grade engines is best.

These are proven to be very reliable; just bend them to fit inside the igniter housing and solder two 8-inch lengths of wire to each end of the igniter. Tie knots near the ends of the wires to prevent them from pulling out of the housing and thereby damaging the igniter. You can buy the igniters from any modeling store.

2. For a homemade version of the rocket igniters, take a 16-inch length of insulated wire, fold it in half, and use a sharp knife to cut through the insulation at the fold. Next, pull the insulation on both sides of the cut until about $1/2$ inch of wire is exposed, then tie knots in the wire so it will fit in the housing with a bit of slack.

Having got the knots in the correct place, remove the wire from the housing to facilitate the next step. Next cut through all of the exposed wires but two. These will get hot and glow red when shorted through the alligator clips (if not, the batteries are not powerful enough).

Now make an envelope from gummed packaging tape.

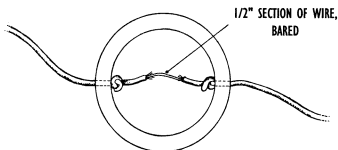
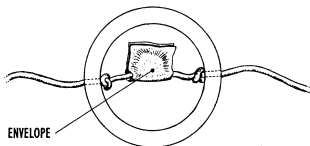

FIGURE 17



Gummed tape envelope containing igniter mix.

FIGURE 18

Make it wide enough to cover the exposed wire and overlap onto the insulation, but don't seal it yet. Pour in the pre-made igniter mix (potassium chlorate/ sugar mix) or, in lieu of that, finely crushed strike-anywhere match heads (be careful when crushing them and do it in small amounts) and then seal the top of the envelope. These igniters burn quite fiercely and are very efficient. Build one and then test it on your bazooka before proceeding any further.

3. This igniter is a bit more technical but requires less battery power. Solder an 8-inch length of wire to the bottom of 1.5-volt flashlight, then solder another 8-inch length onto the side of it, being careful not to short the wires. Next, using a fine grinding wheel (preferably a modeling type), grind a hole into the top of the bulb, making sure you don't damage the filament (once you grind the hole, you cannot check to see if it was damaged because lighting the bulb will destroy the filament). Fill the bulb with igniter mix and block the hole with tape. Test-fire one to see that you have it right and again tie knots in the wires. Finally, fit the igniter into the housing.

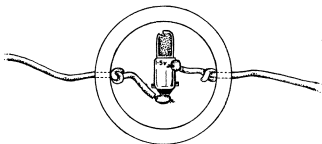

1.5-volt bulb containing igniter mix.

FIGURE 19

4. Originally I only intended to include three types of igniters, but recently I discovered a simple and more reliable method of making the igniter and loading the housing into the cartridge. The only problem with this system is that it takes a large-voltage battery (i.e., a 12-volt dry cell or small, sealed-type 12-volt battery used on motorcycles).

You can still use the original cartridge and igniter housing; they just need some simple modification.

To convert the cartridge to accept the new igniter housing, you need two 12-inch lengths of copper wire (usually found in the wiring used to supply electricity for lighting a home). I use the earth wire.

Now take one length and bend it five times, making

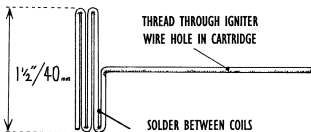

FIGURE 20

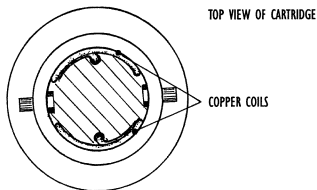

FIGURE 21

1 1/2-inch-long coils, one on top of the other, with the last one being only half as long as the others (Fig. 20).

Next, as neatly as possible, use a blowtorch or soldering iron and solder in between each of the coils to keep them rigid. Now push the copper wire through one of the igniter wire holes in the cartridge until the coils are seated on the cartridge base and bend the coils to fit the shape of the inner walls of the cartridge.

Making sure the coils fit snugly in place, turn the cartridge upside down and hammer a small nail down the igniter wire hole, taking care not to disturb the coil. This should lock everything in position.

Finally, solder a wire to the copper wire sticking out the back of the cartridge. This wire needs to be long enough to reach the alligator clips when the cartridge is in place.

Now repeat the process with the other length of copper wire.

Next, take a standard igniter housing and drill the igniter wire holes out to 1/8 inch in diameter. (I have since added a thin plywood base to my igniter housing

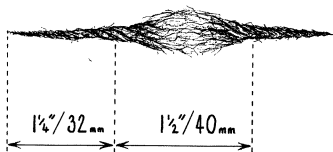

Steel wool mustache.

FIGURE 22

on one side, which saves a bit of time when reloading.)

You'll need some steel wool, fine if possible (you can buy this quite cheaply at any hardware store), and a roll of aluminium foil.

Pull a piece of steel wool about 4 inches long and no thicker than a pencil (not too thick, as it will put a drain on the battery). Twist about 1 1/4 inch on either end, leaving about 1 1/2 inch in the middle. It should now resemble a rather dandy mustache (see diagram).

Cut two 2-by-1 inch pieces of aluminium foil and wrap them around the ends of the mustache as tightly and neatly as possible. You should now be able to push them through the 1/8-inch holes of the igniter housing. The foil ensures that there is a bigger contact area, so when the mustache is shorted out the center will burn fiercely.

Bend the foil tips in half and fold them underneath the housing. These will make contact with the copper coils in the cartridge.

It is now ready for loading with propellant and sealing. Make sure the igniter holes are sealed with tape, but do not

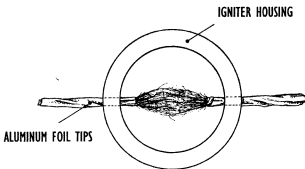
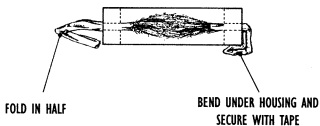
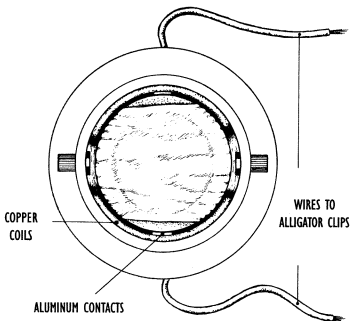

FIGURE 23



Igniter housing, side view.

FIGURE 24



Top view of cartridge with completed igniter in place.

FIGURE 25

cover the aluminum contacts. I usually squeeze the contacts so they protrude from the sides of the housing about 1/8 inch; that way when the igniter housing is placed in the cartridge they crush and make a good contact.

You should find this technique much easier and less fiddley, which will cut down the amount of duds. In fact, up to now I have had a 100-percent success rate with this method.

When you go to reload, simply pull the old housing out and slip a new one in. *Voilà*—what could be easier? You may have to clean the copper coils every now and then, but that's no problem. Also, if you wish, you can solder the ends of the wires that make contact with the alligator clips. This will stop them from getting frayed and provide a good contact area.

Have fun.

ASSEMBLING AND LOADING THE CARTRIDGE

PUTTING THE CARTRIDGE COMPONENTS TOGETHER

By this stage you should be getting excited and dreaming of a suitable range for some serious blasting. First let's get all the cartridge components together:

- tennis ball
- cartridge case
- one igniter housing plus igniter
- two pieces of 2-by-2-inch packaging tape (gummed type)
- propellant mix
- weighing scales
- small spoon

Take the igniter housing with igniter fitted and stick one piece of packaging tape to one side of it, ensuring a good seal.

Weigh out a 2-gram load for the first set of firing tests, then increase the loads to 3 grams. I have tested the bazooka to 4 grams with no ill effects, but the recoil is fierce and the bang deafening. Pour the propellant around the igniter and

seal the housing with the other piece of packaging tape, then allow it to dry.

The following tips should prove helpful:

- When weighing out the propellant, do not allow any distractions. Undercharging will ruin your fun, but overcharging will ruin your underpants.
- Store the housing someplace warm and dry—preferably with silica bags to absorb the moisture—or, even better, waterproof the housing.
- Write the weight of propellant on the housing to avoid confusion when sighting in.

Now you're ready for the final phase of loading.

LOADING THE CARTRIDGE

Once you get the hang of it, the loading process can be done quite quickly. You can either use just one cartridge at a time and keep reloading it or have a whole store of the things available for use.

Thread the two igniter wires through the holes in the wooden disks at the back of the cartridge, and ease the housing gently into place until it lies flat on the wooden disk, taking care not to push your finger through the packaging tape.

Next, using your thumbs, push down on one side of the tennis ball between the ball and the cartridge and push it into the cartridge until it won't push any further, then repeat this on the opposite side until it butts up against the propellant housing. Make sure there is a good seal between ball and cartridge. Finally, bare about 1 inch of the igniter wires, ready for connecting to the alligator clips.

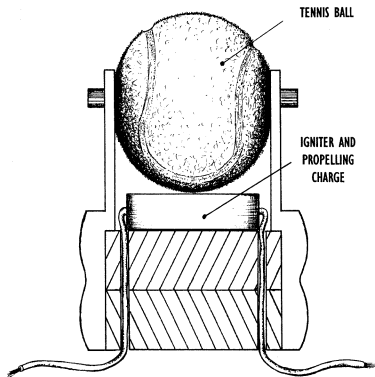

Cross-section of completed cartridge.

FIGURE 26

At this stage, the cartridge should resemble a bullet with two wires hanging out of the back. Now we are ready for action.

Tip: If a tennis ball is left loaded for too long, its shape becomes distorted, which will affect the accuracy of the weapon.

TEST-FIRING AND SIGHTING

The time has finally come . . . let the fun begin! Okay, I shall assume you have found a suitable firing range with at least a couple of hundred feet to spare, because this baby will cover about 1,000 at a firing angle of 45° with a 2-gram load, at least 200 on a horizontal shot.

To achieve a stable firing platform I used a Black & Decker Workmate, which is a portable bench-cum-vice, but anything that will lock the bazooka in place during firing will do.

Choose a target positioned at about the same height as your bench and about the size of a trash can. The range at which you place it is up to you; it all depends on how you want to zero the sights in.

Looking through the barrel of the bazooka, set the bench so that it is aiming at the middle of your target. Now load your cartridge with 2 grams of propellant and then lock the cartridge into the breech and connect the wires to the alligator clips. Make sure that there is no circuit going to the alligator clips (i.e., the warning light isn't on) and that the cartridge is locked into place. Once you're happy that everything is ready, adopt a position forward of the breech but within

reach of the trigger, put your earplugs on, squeeze the trigger, and BOOM!

After you have picked yourself up and adjusted your facial expression back to normal, go and find the tennis ball and note where it landed (assuming it didn't hit the target). Check the bazooka for any stress damage. If you built it right, there won't be any, but if there is, I would rebuild the whole thing. I have fired a couple hundred rounds through mine now with no signs of damage apart from scorching due to the heat of the explosion—even the first cartridge is still going strong. Repeat the above procedure at least five times, noting where the ball lands each time. It should land in roughly the same place each time. If this is not the case, any of the following could be a reason:

1. Each make of tennis ball is slightly different in size and internal pressure, so stick to the one brand that suits your bazooka. After a ball has been fired a few times, it will lose its nap (fur), which will affect its seal in the barrel and thus the power of each shot.
2. Because the tennis ball is a tight fit in the cartridge, leaving the cartridge loaded for too long will distort the shape of the ball and so affect the aerodynamics, making its flight untrue.
3. Uneven loading of the propelling charge will alter the power of each shot, making the ball fly higher or lower.
4. The wind will most definitely affect each shot, so sight your bazooka on a windless day.

If you are happy with the 2-gram load, then stick with

that. I personally find it to be amply powerful, with quite an impressive recoil (so keep a good gap between your eye and the sights).

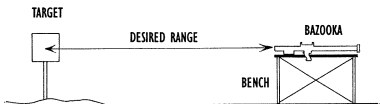
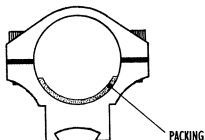

FIGURE 27

My bazooka is sighted in for 200 feet with a 2-gram load, and at 45° it covers at least 800 feet. At 200 feet it hits the target with a fair old smack. If you have decided on 2 grams, what you need to do is alter the position of the bazooka until the tennis ball is hitting the target. If it keeps falling short, prop up the front legs of the bench higher, and if it's passing over the top, pack up the rear legs. To adjust your shot further to the left or right, simply turn the bench in the desired direction.

Once you have achieved a consistent accuracy, it is time to bring the sights on line. If you are using telescopic or single-point sight, look through it by getting into a firing position as best you can without altering the bazooka or bench, and move the crosshairs or dot until on target. If there is not enough adjustment left in the sights, then you shall have to pack them up in their mounts using either pieces of plastic or tape or even paper—anything that will act as a shim. Again, pack the front mounts to raise and the rear mounts to lower, and offset the shims for left or right adjustment.



Front or rear scope mount.

FIGURE 28

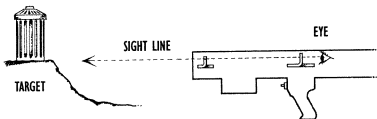

FIGURE 29

If you are using open sights, look down the sight line until there is a straight horizontal line between your eye, the rear sight, the front sight, and the target, which ideally needs to sit on top of the front sight (lollipopping).

Now mark the rear sight where the imaginary sight line intersects, and drill a hole in the center of the rear sight blade. Repeat this for the desired amount of ranges you require. Now you have a very versatile sight and are ready for the hunt.

If, however, you are an adrenaline junkie and need that bigger boom, simply go up to the 3-gram load and follow

the above procedure, but be warned, the recoil will be savage, and I would advise putting high-density foam around the sights. (I must admit, though, the excuse for a black eye will be more interesting than the old "I walked into a door" routine.) Again, I've tried a 4-gram load with no ill effect to the bazooka, but the recoil was fierce, lifting the bench a good 6 inches off the ground, and there was a resounding bang that would have pleased Ragnar Benson. The ball whizzed off into the distance and was never found, although I believe it's hiding out there somewhere nursing a very sore butt.

A word of warning: do not try any projectile that is a heavier or tighter fit than a tennis ball, because if it sticks or the explosion cannot get out quickly enough, well, it's got to go somewhere, and I'm sure you would prefer that it go out the business end.

So that's it—you've done it. Now it's fun, fun, fun. So go forth, plink away, and be merry.

AFTERWORD

As I have already said earlier in the book, I have built and tested a number of weapons and munitions, all of which work with varying degrees of success. The following list features some of my better ones:

- butane-propelled tennis-ball cannon
- RPG 7 (with various warheads)
- M79 40mm squash-ball launcher
- tennis-ball howitzer
- light mortar (tennis balls and anything else that would fit)

These have all been designed for fun, and we've certainly had plenty of that. All you need is a bit of imagination, ingenuity, and the will to build it.

So I hope I have achieved what I set out to do, which was make available to anyone with an interest in this area an easy-to-build weapon that would provide a good amount of entertainment and get the gray matter working, and to show that you're not alone when it comes to getting your kicks from a damn good BANG.

If there is anyone out there who wants to ask a few ques-

tions or share ideas, I would be more than pleased to hear from you. Please write to me in care of Paladin Press, P.O. Box 1307, Boulder, CO 80306.

Cheers, and many happy blasts!

A FEW POINTERS TO BEAR IN MIND

- Although this weapon fires a projectile that is termed a soft munition, I believe being hit by a tennis ball traveling at the velocity this weapon delivers would do some serious damage to a person or critter, so blast targets that can take it.
- When purchasing your barrel, make sure it is not bent or distorted in any way and that the connector is a snug fit.
- Having built your bazooka, check to be sure the barrel is not distorted before firing.
- Experiment with various tennis balls until you find one that suits your bazooka and then stick with it.
- When preparing your cartridge, take your time. After all, there's nothing more frustrating than a dud.
- The chemicals you use for the propellant and igniter need to be as fine and pure as possible. This will make mixing much easier.

- Firing in damp weather will affect the performance of each shot unless you choose to waterproof each propelling charge.
- After firing, you can wash the barrel and cartridge with warm, soapy water. Allow to dry thoroughly before use.
- There's one rule I always stick to: "Start in small amounts and build up." I've still got all my digits, although my hearing's not so good . . .

TROUBLESHOOTING

Okay, there you are, bazooka loaded and aimed at the target. You squeeze the trigger and nothing happens . . . what do you do?

Well, has the circuit warning light come on? If yes, release the trigger, making sure the light goes out, then check the connection between the alligator clips and igniter wires and then try again. If again it does not fire, disconnect the alligator clips and remove the cartridge. Using a bulb with wires attached, check that there is a circuit between the alligator clips. If not, then there is probably a fault in one of two places—the battery holder or trigger. Check the connections and replace if necessary. If, however, there is a circuit, then the igniter must be the problem, so the only answer is to replace the propelling charge and carry on firing. Then when you get the chance, dismantle the propelling charge and inspect the igniter, find the fault, and make sure you don't make the same mistake twice.

Another problem could be that the battery power is not sufficient to heat up the igniter. It may well be that the igniter works when placed across the battery terminals, but when

you add a couple of feet of wire to this, then the power of the batteries is sapped.

Even if the igniter is not actually touching the propellant, it sometimes will not fire, so beware of this when loading the cartridge.

I hope this will answer any problems that may occur. I am sure if you have got this far that you will have a thorough understanding of your weapon and so any problems that do occur will be easily solved.

RESOURCES

Here's a list of books that gave me inspiration. All were excellent and left me in no doubt about what I was doing. Take care and play safe.

Firecracker Cookbook
by Edwin Lough
Firepower Publications
Cornville, Arizona

Homemade Mortar Construction Manual
by Jeff Baker and Thomas W. Tribble
Paladin Press
Boulder, Colorado

*Ragnar's Guide to Home
and Recreational Use of High Explosives*
by Ragnar Benson
Paladin Press
Boulder, Colorado

*Improvised Explosives:
How to Make Your Own*
by Seymour Lecker
Paladin Press
Boulder, Colorado

*Improvised Munitions Black Book,
Volumes 1, 2, and 3*
Desert Publications
El Dorado, Arkansas

The Poorman's James Bond
by Kurt Saxon
Atlas Formularies
Harrison, Arizona



If you get a bang out of the flash and thud of an explosion and are intrigued by the problems and successes involved in the construction of soft munitions, propellants, and weapons, you might wish to build your own bazooka. A bazooka is not difficult to make—after all, it is only a barrel with a few essential items fastened into place—and you can find all the materials you need at your local hardware store.

Here, Anthony Lewis takes you through the process he perfected, from constructing the cartridge, barrel, grip, and sights to mixing the propellant and igniter to assembling and loading the cartridge. Finally, he covers the fun part: test-firing and sighting.

Simply follow this procedure step by step, and before you know it you'll be blasting away like Rambo on a good day. So, happy building and, as Lewis would say, "go forth, plink away, and be merry." But do be careful. *This book is for information and entertainment purposes only.*

A PALADIN PRESS BOOK
ISBN 0-87364-738-6

995