



# SurvivalRing

*Study Yesterday.. Prepare Today.. Live Tomorrow*

This digital document created and presented by Richard Fleetwood. He is the founder, author, producer, and webmaster of the **SurvivalRing** (<http://www.survivalring.org>) and **Civil Defense Now!** (<http://www.survivalring.org/cd-main.htm>) websites.

SurvivalRing has as its goal the ideal of being the leading source of survival, preparedness, and self reliance information on the Internet. Linkage, assistance, and creation of digital content in areas that until now have only been hinted at or impossible to find, is being added to everyday via the Survival-Ring website and email lists.

Thousands of hours of searching, writing, and communications have been spent collecting over 2 gigabytes of digital content, as well as tens of thousands of pages of hard copy original public domain material in the areas of civil defense, survival, training, and preparedness, from all over the globe.

As much as possible is being put online at his website at

**<http://www.survivalring.org>**

## Civil Defense Now!

*Part of The SurvivalRing website*

The content of THIS file, while created from PUBLIC DOMAIN material, produced by the U.S. (or other) Government at taxpayer expense, is presented in THIS digital format, produced from the ORIGINAL hardcopy document, for the benefit of all mankind, in hoping to help spread the idea of PREPAREDNESS for any and all threats that may come from either natural, extraterrestrial (space based), or manmade sources.

There are too many situations and incidents that can come to pass in everyday life, that when time is taken to learn and skills obtained, can mean the difference between life and death. Sept. 11, 2001 proved to the world that no matter how safe a person thinks they may be, death and injury can come from the most UN-LIKELY place, at any time. The documents presented in this series of digitized works, can help the average person with the knowledge within, to know how to save those persons closest to them in REAL disaster. Help spread this idea of sharing SURVIVAL INFORMATION.

If you have documents from any era, on any disaster or civil defense area, PLEASE contact Richard at his email address of [RAFLEET@AOL.COM](mailto:RAFLEET@AOL.COM). Check the website for the LATEST additions to the CIVIL DEFENSE NOW online library archive. All data online, and much more, is also available on CD-ROM. Information is available at the website on how to obtain it. Thanks for your support, and enjoy the information contained on the following pages. Share them with those who will learn from them and teach what they know to others.

*Donations of U.S. or other civil defense documents, articles, books, videos, digitized ephemera, patches, tools, photos, or anything of this nature is appreciated, as well as cash gifts or donations to support the website costs and bills. Address information is available on the homepage of Civil Defense Now! (URL located above)*

**- Richard Fleetwood – January 2002 — ALL RIGHTS RESERVED –**

This document may NOT be reproduced commercially on any media WITHOUT EXPRESSLY WRITTEN permission from the creator of this digital presentation. Educational Institutions MAY use this material in any way needed.

**Permission granted to individuals for PERSONAL USE ONLY.**

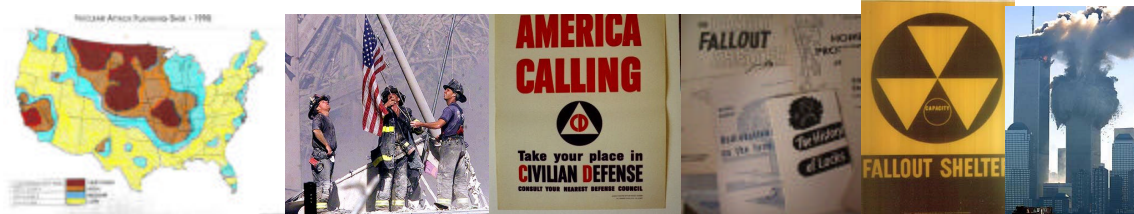



# Preparedness Planning For a Nuclear Crisis



**Text**

363.33  
P919p  
1987  
v. 1

A Citizen's Guide to Civil Defense and Self-Protection

# **Preparedness Planning For a Nuclear Crisis**

A Citizen's Guide to Civil Defense and Self-Protection

Text

## Table of Contents

	Page
Introduction .....	1
Chapter 1 Risk Analysis: The Effects of Nuclear Weapons .....	3
Chapter 2 Civil Defense and Emergency Planning .....	31
Chapter 3 Planning for Evacuation .....	45
Chapter 4 Preparing Fallout Shelters .....	57
Chapter 5 Preparing for Shelter Living .....	87
Appendix	
Expedient Shelter Plans .....	123
Expedient Shelter Equipment .....	130

# INTRODUCTION

This book is about making personal plans for an emergency that most people do not want to think about—nuclear attack. Planning how to respond to this possibility is no less wise than planning how to escape a burning building, survive an earthquake, avoid injury from an accident involving hazardous chemicals or a nuclear power plant or any major emergency. You make plans, not because you believe these emergencies will happen, but because you want to be prepared just in case they ever do. Planning how you will respond to a nuclear attack emergency is the same. You want to know what to do to increase your chance of survival in case this emergency ever happens.

Civil defense is the term often used to identify the actions that this country is prepared to take to protect citizens in a nuclear attack or any lesser national emergency. This book describes current civil defense planning and helps you to incorporate this information into a personal emergency plan. You will make decisions about your own response based on sound principles of emergency management and your own situation. You will need to gather information about your community's plans so that your personal emergency plan benefits from those of your community.

The book is divided into five chapters that follow the steps of emergency planning:

## 1. Risk Analysis: The Effects of Nuclear Weapons

The first step in emergency planning is to analyze the risk to you from a given major emergency. You learn about the immediate and long-term dangers posed by a nuclear attack. You learn about the hazards both close to and far from the blast center. You learn how to assess the vulnerability of your community—is it a potential target area?

## 2. Civil Defense and Emergency Planning

In this chapter, you learn about government plans and policies for civil defense. You learn about all-hazard emergency planning and how it includes population protection in emergencies of many types.

## 3. Planning for Evacuation

One important part of your plan is preparing to evacuate to a safer place. This chapter teaches you how to prepare wisely, how to close your home, what to pack, and what to expect during a major evacuation.

## 4. Preparing Fallout Shelters

You learn the basic requirements of a fallout shelter, how to prepare a permanent home shelter, how to build an expedient or emergency shelter, how to upgrade a building for fallout protection, and how to stock a fallout shelter.

## 5. Preparing for Shelter Living

In the last chapter, you learn how to enter a fallout shelter safely, how to maintain sanitary living conditions, how to protect your supplies and equipment, and the types of problems you can expect living in a shelter.

## How to Use This Book

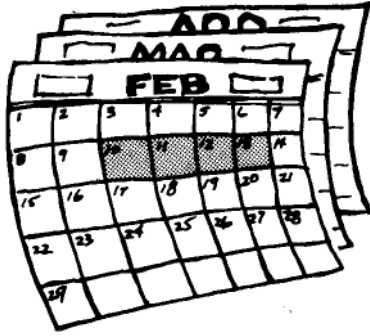

If you are reading this book when there is no developing crisis, you have time to study the book and make careful preparedness plans. You will be able to collect information at your leisure to complete your plans. When you finish, put the book and your plans in an accessible place so that you can find them if you need them. Review your plans from time to time to keep them current.



If a crisis is developing, you may not have much time to make your preparedness plans. Find out as much as you can about the civil defense plans in your community. Then study the chapters that are most critical to you. Use the checklists to help you with your planning.

# CHAPTER 1

## RISK ANALYSIS: THE EFFECTS OF NUCLEAR WEAPONS

In 1945, the first nuclear weapons were used in war on the Japanese cities of Hiroshima and Nagasaki. The power and destructive force of these weapons frightened us then and continue to frighten us now. Fear of nuclear weapons will not protect you from their effects. Knowledge could. The best protection is knowing what to expect and how to respond in a crisis. This chapter introduces you to vulnerability analysis, that is, determining the dangers of a hazard and learning how great the risk is to your particular community. You learn the effects of nuclear weapons in the first chapter. The second chapter helps you determine the risk to your home.

### Nuclear Weapons

Nuclear weapons use nuclear energy to produce their destructive power. As weapons, they are many times more powerful than conventional non-nuclear weapons. Like the conventional type, the destructive action comes mainly from the blast. But, unlike those weapons, nuclear weapons also produce intense thermal or heat radiation which can cause widespread fires and burns. They also release initial and residual nuclear radiation which can affect persons who are located near and far from the blast site.

Nuclear weapons produce three major direct effects: blast, heat flash, and nuclear radiation. How dangerous these effects are depends on time—how long you have to protect yourself, shielding—how much protective covering is between you and the radiation and distance—how far away you are from a detonation.

When a nuclear weapon explodes, tremendous amounts of energy are suddenly released. This energy creates a fireball of hot, compressed gases, an instantaneous release of thermal and nuclear radiation, and a blast or shock wave of tremendous force.

### Fireball: Heat Flash and Thermal Radiation

The first effect of nuclear weapons is the fireball, a combination of heat and light of such brilliance and intensity that the flash can be seen hundreds of miles away. The heat, given off as “thermal radiation”, is so intense that it can ignite flammable objects for several miles around the blast site.

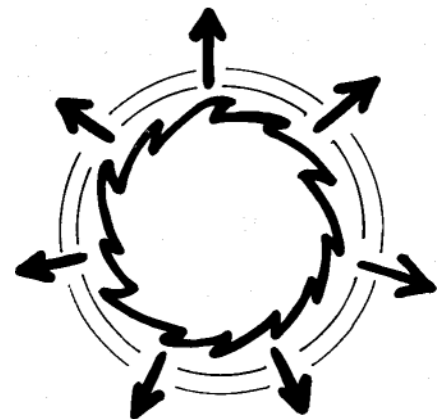
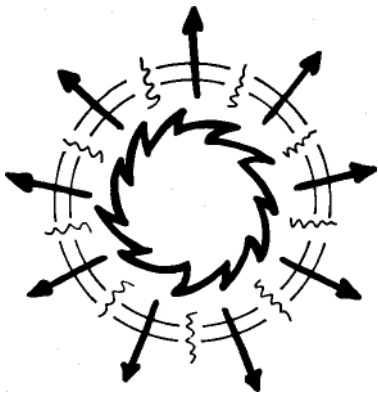

### Nuclear Radiation

Secondly, high levels of very penetrating and harmful invisible rays called "initial nuclear radiation" are instantly released into the immediate blast area. Radioactive fission products are also produced. These products release radiation called "residual nuclear radiation." They will continue to emit harmful rays for several months or years after the explosion, but the most dangerous period will be the first several days after an attack.

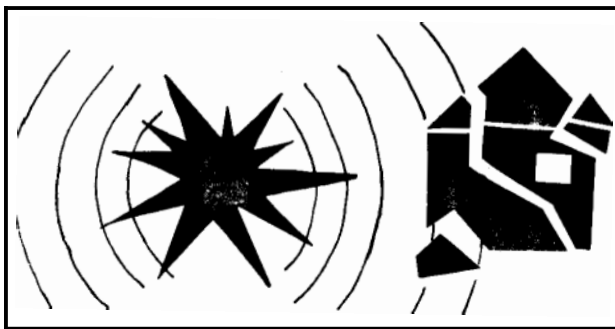
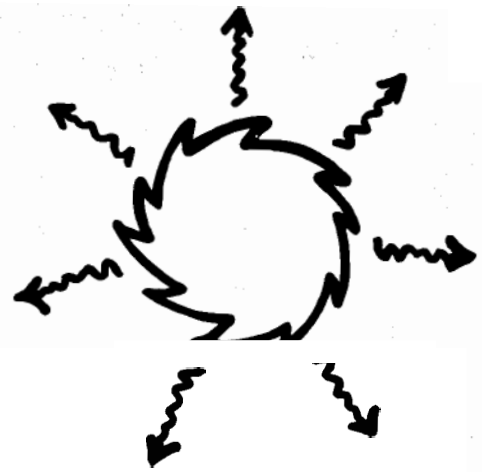

### Blast

The third effect occurs a fraction of a second after the heat flash. It is an extremely powerful blast or shock wave that rocks the area and travels away from the explosion. The blast can be so powerful that it will destroy all but specially reinforced buildings for several miles around the blast site.

### Radioactive Cloud

The fireball expands rapidly, heating the air around it. At the same time it rises to high altitudes like a hot air balloon.

As the fireball rises from an explosion on or near the ground, it sucks the surrounding air, bomb material, earth and debris into its stem to form the characteristic "mushroom cloud". When the fireball reaches the upper atmosphere, the superheated air begins to cool and water in the air condenses to create a huge expanding cloud.

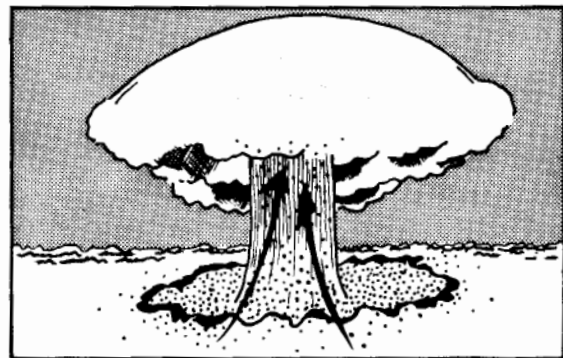
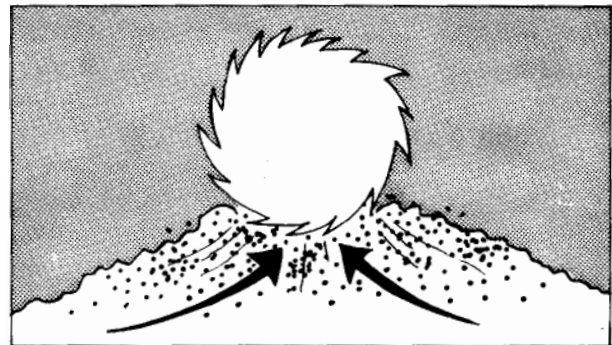



## Radioactive Fallout

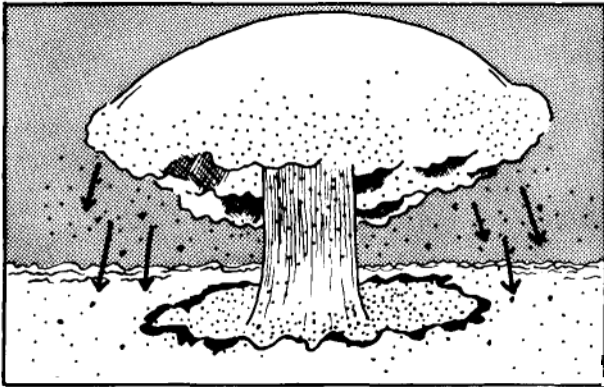

When a nuclear weapon explodes on or near the ground, it makes a huge pit or crater. Tons of earth in the crater are instantly vaporized by the heat and pressure from the explosion. These materials combine with radioactive residues of the explosion which, upon cooling, form a cloud of particles of earth and bomb materials. This particle cloud is carried by the wind for miles and drifts down to earth as radioactive fallout. The heavier, large particles fall to the ground nearer to the explosion than the small particles. These smaller particles can be carried up to several hundred miles by the wind. Most of the fallout with which you should be concerned will come to the ground within

24 hours, but very small particles come down slowly and may be spread over large areas of the earth's surface over a period of days, weeks, or months.

The fallout cloud may take as little as 15 minutes or as much as several hours to arrive and begin to deposit fallout in your area. The time will depend on many factors such as the number of ground explosions, their distance from you, and the speed and direction of the wind. The sky will probably darken as the cloud arrives and the fallout begins to come down. After fallout begins, it may keep falling in your area for an hour or more, depending on how long it takes the fallout cloud to pass over your area.

The majority of the fallout may look like sand or the gritty ash of a volcanic eruption. While most of the fallout will be visible as it forms a layer of dust on trees, cars, window ledges, and the ground, the radiation given off from these particles cannot be seen, heard, felt, smelled, or tasted. Only special instruments and devices will be able to detect the presence of radiation given off by fallout.

## Hypothetical Fallout Distribution After A Large-Scale Attack

In an effort to make preparedness plans, the federal government often looks at what might happen if different types of nuclear strikes are made on this country. The following illustrations represent possible fallout distributions after an hypothetical attack of ground burst weapons on several hundred potential risk areas in the United States. An actual attack would likely include fewer ground bursts, in which case the fallout threat would be much less severe.

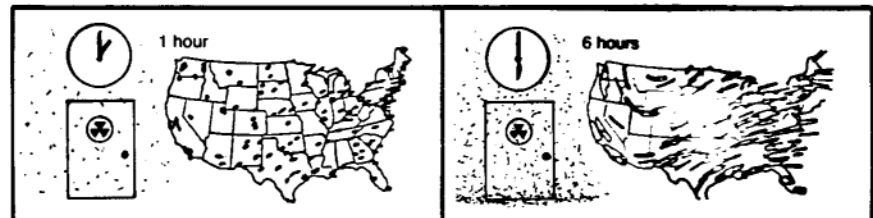

**1 HOUR**

Intense radioactive fallout  
in areas around explosion

**6 HOURS**

Intense radioactive fallout  
over **40%** of the country

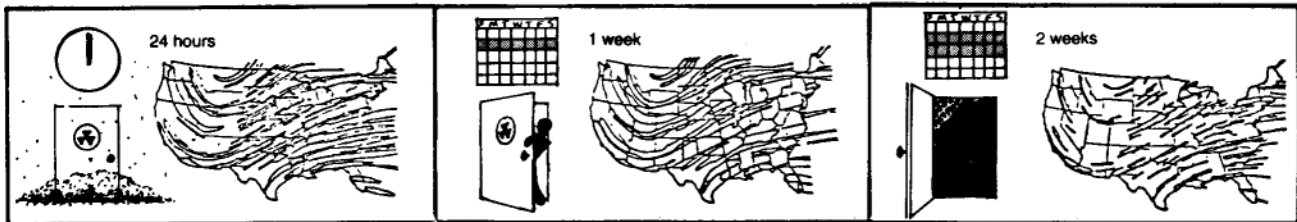

**24 HOURS**

Most fallout deposited. In-  
tense radiation over **70%** of  
the country.

**1 WEEK**

Dangerous radiation levels  
over **34%** of the country;  
short trips out of the shelter  
may be allowed in some  
areas; longer or permanent  
emergence in other areas.

**2 WEEKS**

Radiation levels over most  
of the country would be  
relatively safe; emergence  
from shelters likely in most  
areas.

The distribution of fallout particles following a nuclear weapon explosion will be widespread and depend on many factors such as the size of the weapon, weather conditions, and wind speed and direction. The height of the cloud also will influence where particles fall. Considering the uncertainties related to all these factors, no area can be considered safe from fallout if a nuclear attack takes place. Again, an actual attack would likely result in much less fallout if fewer ground bursts of nuclear weapons occurred.

## Radiation Decay

Radioactive materials produced by a nuclear bomb explosion are unstable. These materials change or decay into a stable condition by shooting out invisible nuclear radiation. Some materials decay faster than others. Those that decay quickly produce intense nuclear radiation in the first few hours and days after a nuclear explosion. Those that decay more slowly may be responsible for measurable nuclear radiation months to years after the explosion.

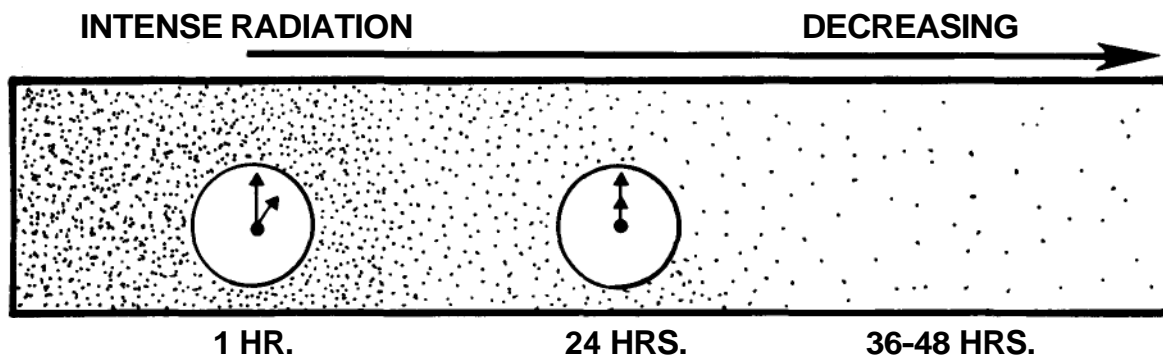

Decay of the radioactivity in fallout particles takes place in the cloud as it is carried by winds toward you. The radiation intensity will also be decreasing because the cloud spreads out as it moves along, and the heavier particles will be dropping out, so the number of fallout particles per cubic inch of air will be decreasing as time goes on. The farther you are away from an explosion, the more time radioactive materials in a fallout cloud has to decay and spread out.

An easy way to estimate the decay of fallout radiation is by the "seven-ten" rule. Simply stated, this means that for every sevenfold increase in time after the detonation, there is a tenfold decrease in the radiation rate. For example, if the radiation level one hour after detonation is 1,000 Roentgens (R) per hour, after seven hours, it will have decreased to one-tenth as much, or 100 R per hour. About two days after the burst, it will have decreased to one-hundredths as much, or 10 R per hour and so on. The table below illustrates how radiation decreases over a two week period from a level of 1,000 per hour.

Hours after Detonation	Fraction Remaining	Level of Radiation
1	—	1000R/hr
7	1/10	100R/hr
49 (2 days)	1/100	10R/hr
346 (2 weeks)	1/1000	1R/hr

## Hazardous Effects and Protection for People

Protection from all three effects—heat, blast, and radiation—is critical to your survival. The heat flash can cause severe burns, either from direct exposure or from burning clothing and buildings. The intense light can cause eye damage, both temporary and permanent, from just looking at the flash. The nuclear radiation can cause death if the body is exposed to high levels. The blast can cause serious injury from fractures and concussion to persons thrown about by the shock wave or struck by flying debris.

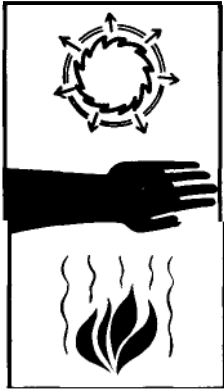

Burns



Radiation Sickness

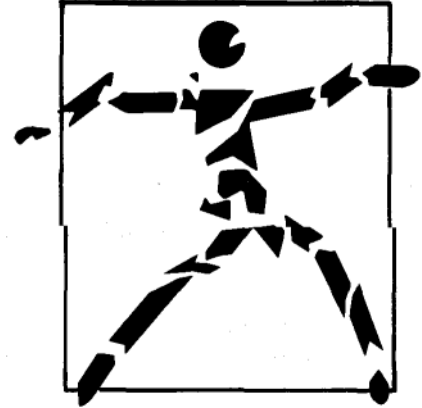

Fractures

How then can you protect yourself? Distance, shielding, and time are your greatest protectors. The farther away you are from the explosion area, the fewer effects from which you must protect yourself. The more protective shielding between you and the blast, the safer you are. The more time that passes after the blast, the lower the danger to you from fallout radiation.



### The Reach of Blast and Fire

The best protection is a combination of distance and shielding. How great a distance and how much shielding depends on several conditions. These conditions include whether the weapon explodes on or above the ground, the size of the weapon, the weather conditions at the time of the explosion, and whether the terrain is flat or hilly.

## Type of Burst

The general reach or size of the area affected by a nuclear weapon depends mostly on where the explosion occurs. A weapon may burst under ground or water, on the ground, in the air, or at a high altitude.

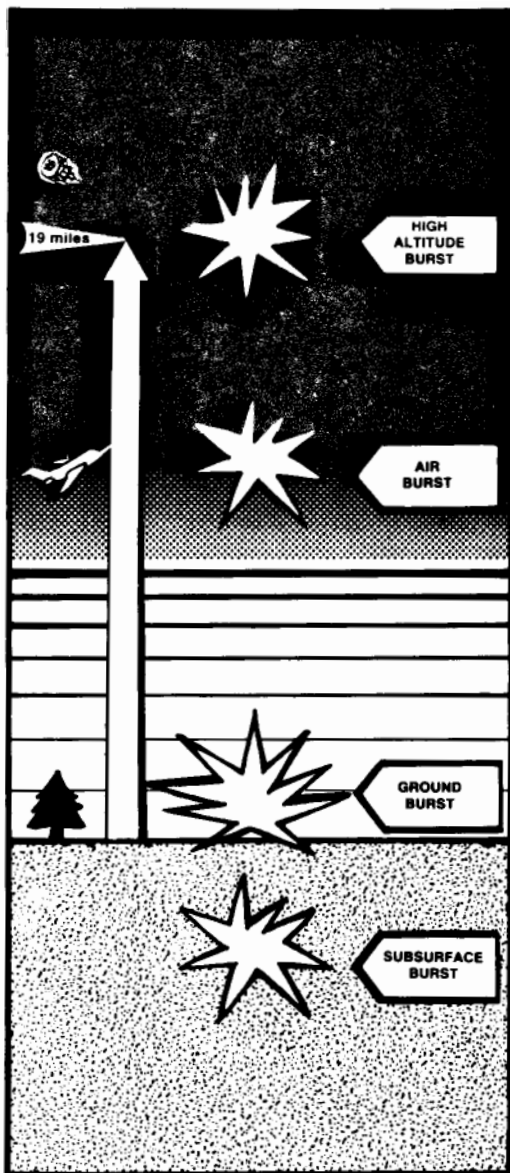

### Subsurface Burst

A subsurface burst is one in which the explosion occurs underground or underwater. This type of burst creates a shock wave which could cause an earthquake or sea surge. Much of the heat is absorbed by the ground or water; however, the ground or water immediately surrounding the blast will be heavily contaminated with radioactive materials.

### Ground Burst

When a nuclear weapon explodes on or near the ground so that the fireball touches the ground, it is called a ground burst. Only ground burst weapons create significant fallout. When the explosion occurs near the ground, the blast creates a crater. Vast amounts of pulverized radioactive debris and dust are sucked up into the rising fireball and become part of the radioactive cloud. The greater the amount of debris in the cloud, the greater the fallout.

### Air Burst

An air burst occurs when the explosion is high enough so that the fireball does not touch the ground. While almost no fallout is created by an air burst, the area affected by the blast and heat is greater.

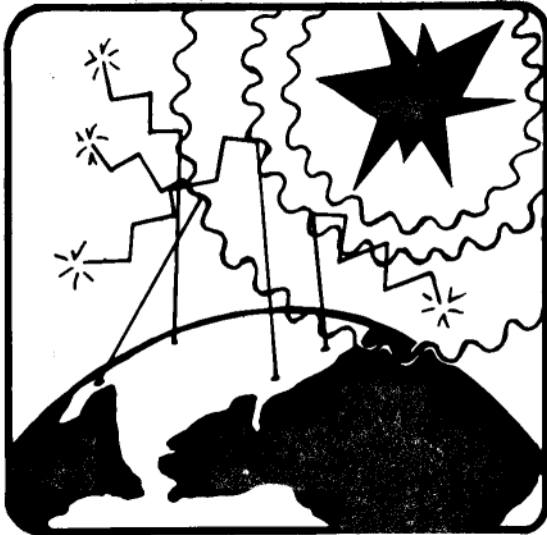

### High Altitude Burst

A nuclear explosion that occurs **19** or more miles above the ground is called a high-altitude burst. This type of burst produces a brilliant fireball, but little, if any, heat, blast, or nuclear radiation will reach the ground. However, a high altitude burst can disrupt communications and electrical systems over a wide area. We will discuss this effect, called electromagnetic pulse (EMP), later in this section.

### Size of the Weapon

The size of the weapon **is also** very important in determining the total area that will be affected. Obviously, the larger the weapon, the greater the reach of its blast. Nuclear weapons are measured in kilotons (KT) or megatons (MT) of energy. One kiloton is equal to one thousand tons of TNT, and one megaton is equal to one thousand kilotons or one million tons of TNT. The most common weapons today are in the kiloton to lower megaton range—100KT to 1MT.

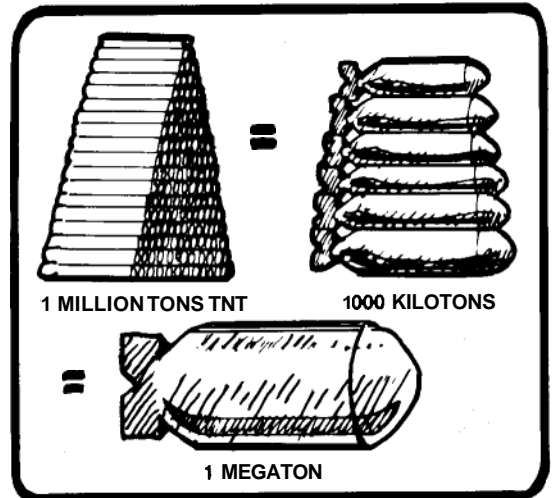

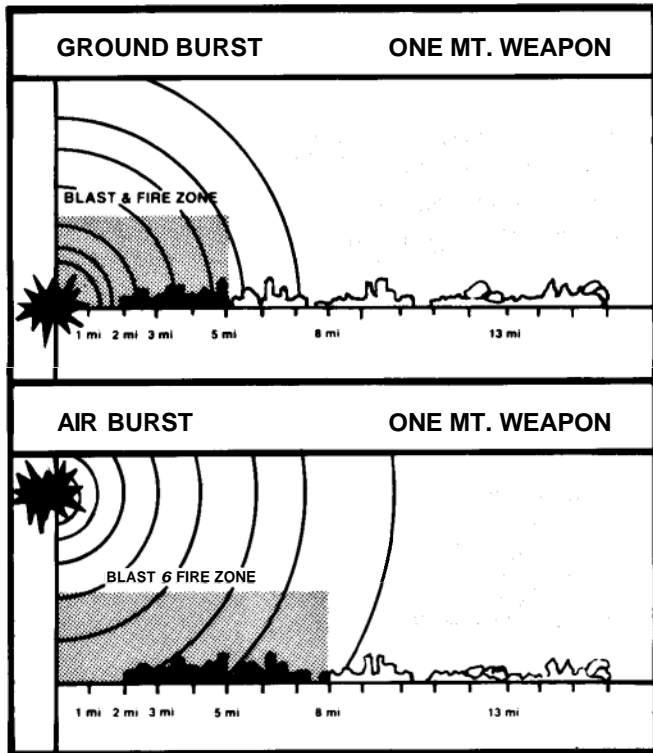

### The Reach of One Megaton Weapons

If a one megaton (1 MT) weapon bursts on the ground, the blast and fire damage is likely to extend five miles from the point of explosion. If the same size weapon bursts in the air, the reach of the blast and fire damage may increase to **8** miles.

Because the area affected by blast and thermal radiation is largely determined by the size of the weapon and the height of the burst, for convenience, all future discussions about damage area will be based on 1 MT ground bursts.

### Weather

Blast and thermal radiation travel in waves through the air. The weather conditions at the time of an explosion will affect the reach of the thermal radiation, but will have little, if any, effect on the blast. On a cloudy day when the air is heavy with moisture, the heat wave will not be able to travel as far as through clear, dry air.

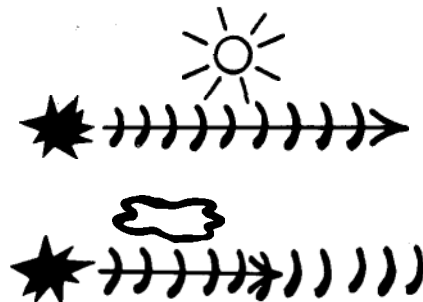

### Terrain



Thermal radiation travels in waves similar to light. Consequently, hills or valleys may shield adjacent areas from the thermal radiation. However, blast is not affected by terrain. The blast wave is so large compared to the size of most terrain features that the force exerted will be about the same on both the near and the far side of a hill or valley.

## Protection From Blast and Fire

While the best protection is distance from the blast, the next best is cover and shielding. If you are within the damage area of the explosion, specially designed "blast-hardened" or below-ground shelters provide the best protection. Ordinary frame houses cannot withstand the force of a one megaton ground burst if they are located within 5 miles of the blast site. In fact, most above-ground shelters in structures within a 5 to 8 mile radius of the explosion cannot be considered safe from blast damage.



The intense heat of the fireball may ignite flammable materials over a five to eight mile radius. Gas lines and fuel lines may break from the blast and be ignited by materials that are smoldering or burning from thermal radiation. Fires can spread through buildings, trash, dry trees, grass, weeds, and anything that burns.

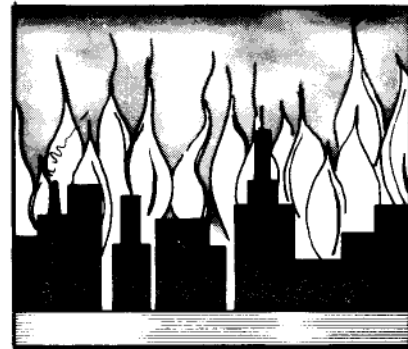

Persons who survive the blast will require protection from the intense heat of the fires. Within one mile of the blast, persons in ordinary shelters would have little chance of surviving the heat. Specially designed and

properly ventilated shelters are necessary for the survival of anyone close to the blast site or in the path of a fire.

Following the nuclear blast at Hiroshima, fires raged through the ruins of the city. However, in spite of the blast and fire, many persons within the city survived. Although the best protection is distance from the blast, you can survive if you are caught close to the blast site and follow other protective actions.



## Protection Near the Blast Site

Because it is likely that any use of nuclear weapons would take place during an intense international crisis, you may well have enough warning to evacuate to a safer place if you live in a probable target area. However, if you do not have enough time or do not choose to evacuate, you should prepare to take two types of protective actions. First, be prepared to go to a shelter if an attack warning is sounded. Second, be prepared to take cover if an attack is made on or near your city.

### Attack Warning

Most cities have some type of outdoor warning system that will be used in an attack emergency. These systems may include sirens, horns, factory whistles, or even church bells.

The **Attack Warning Signal** is a wavering sound on sirens or a series of short blasts on horns or whistles. The Attack Warning Signal will be sounded for 3 to 5 minutes only when an enemy attack has been launched against the United States. When you hear this signal, you may have only 5 to 15 minutes to find shelter.

If you hear the Attack Warning Signal:

- Go immediately to the nearest shelter
- Turn on the radio in the shelter for detailed information.
- If time is available, take fire prevention steps. (These are listed in Chapter 3).
- If the attack is expected in a few minutes, go to an unexposed corner in a basement or to the central area of an above-ground shelter. Stay away from windows or outside doors.
- Get into a take-cover position. Lie on the floor and cover your head and face, or sit in rows back to back.

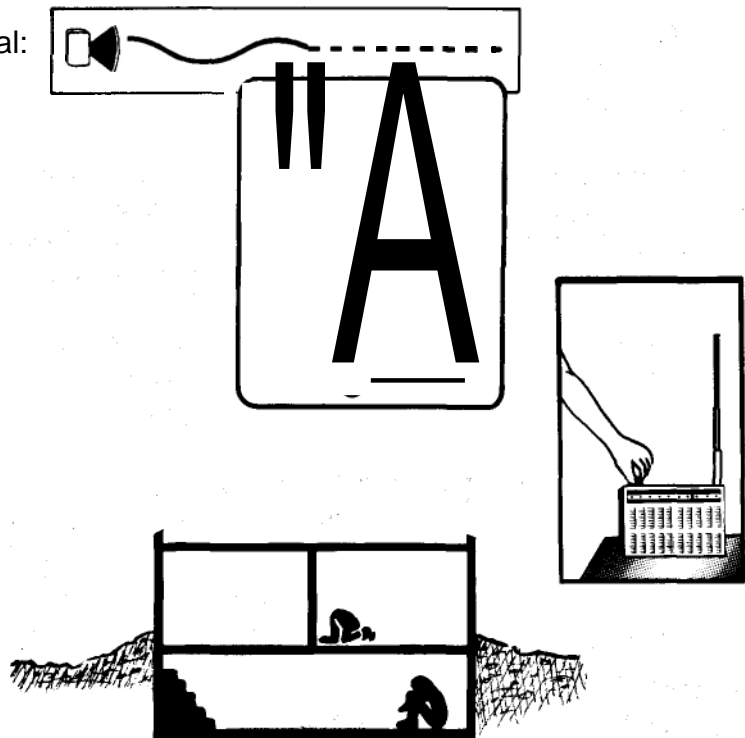

## Surprise Attack

If no warning is given and you see the brilliant flash of a nuclear weapon burst, you must take cover **immediately**. In a fraction of a second the intense heat flash from the weapon will begin to arrive and will last for several seconds as the fireball rises in the sky. Do not look at the flash. The brilliant flash and the wave of thermal radiation can damage your eyes and cause temporary or permanent blindness. The heat flash will be followed by the blast wave within a few seconds. How quickly the blast wave arrives depends on the distance from the detonation, but the difference is only in seconds.

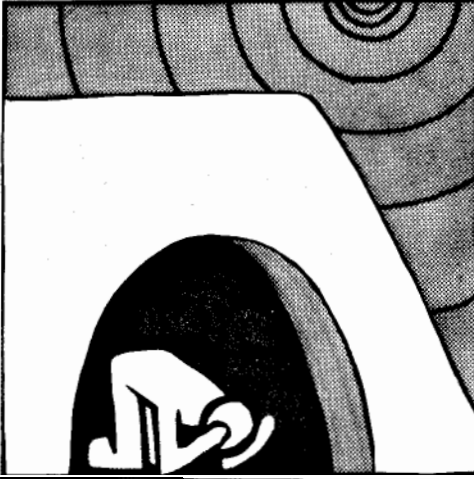

### 1. WHEREVER YOU ARE, DIVE FOR THE NEAREST COVER

- into a windowless hall or room,
- against a wall or solid structure,
- into a culvert,
- into a tunnel,
- into a subway station,
- on the floor of your car,
- under a car, truck, or bus,
- or onto the ground.

### 2. GET INTO THE "TAKE-COVER" POSITION

Lie on your side in a curled up position. Cover your head and face with your arms and hands. Protect yourself as best as possible from being burned or thrown about by the blast.



### 3. DO NOT LOOK AT THE FLASH

The brilliant flash and the **wave** of thermal radiation can cause temporary blindness or permanent eye damage.

**4. MOVE QUICKLY  
TO A SHELTER MINUTES LATER**





When the blast wave has passed, find shelter to protect yourself from the fires and radiation. Look for the basement of a public building, a subway station, or a marked fallout shelter. If nothing better is available, a storm culvert or a fruit or storm cellar will provide some protection.



You will learn more about civil defense plans, preparedness, and safe responses in Chapter 2.

**Nuclear Radiation**

Nuclear radiation is made up of high energy rays. These rays are sent out from the nuclei of atoms that are radioactive. The rays pass through air, liquids, and solids much like streams of tiny bullets, but at speeds many thousands of times faster than the fastest rifle bullet. The rays are invisible, silent, and cannot be felt. There are three kinds of dangerous radiation in fallout from nuclear weapons, called alpha, beta, and gamma radiation. Alpha and beta rays are, in a way, like streams of large, slow bullets compared with the much smaller and more penetrating bullets of gamma rays, which travel at the speed of light. Gamma rays are just like X-rays, except that X-rays are produced without using radioactive materials. **Of** the three dangerous kinds of radiation from fallout, gamma radiation poses the greatest threat to human life and is the most difficult to protect against.

	ALPHA PARTICLES	BETA PARTICLES	GAMMA RAYS
 <b>PHYSICAL PROPERTIES</b>			

## Types of Radiation and Their Effects

When nuclear radiation passes through flesh it damages some cells and destroys others. The different kinds of radiation produce different kinds of damage.

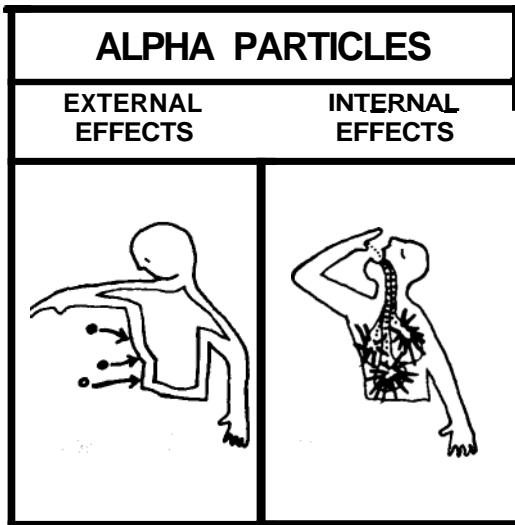

**Alpha radiation** is stopped by the outer skin layers and is not harmful unless you breathe or swallow particles which send out alpha radiation. In this case, the alpha radiation may cause serious damage to the tissues inside your lungs or digestive tract. However, it is unlikely that anyone will breathe or swallow enough fallout particles to become a casualty from alpha radiation during the emergency. The fallout particles are too large to pass through the respiratory tracts without being filtered or trapped. You do not need to be very concerned about alpha radiation from fallout.

**Beta radiation** is much more penetrating than alpha radiation and may cause skin burn if a lot of fresh fallout particles stay on your skin for a few hours. Like alpha radiation, beta radiation can cause serious damage to your internal organs if fallout particles are accidentally eaten or breathed. Again, it is unlikely that anyone will breathe or swallow enough fallout particles to become a casualty from beta radiation during an emergency. The hazard from beta radiation is much reduced within a few days after fallout has arrived because radioactivity in fallout undergoes a rapid initial decay to a less harmful level.

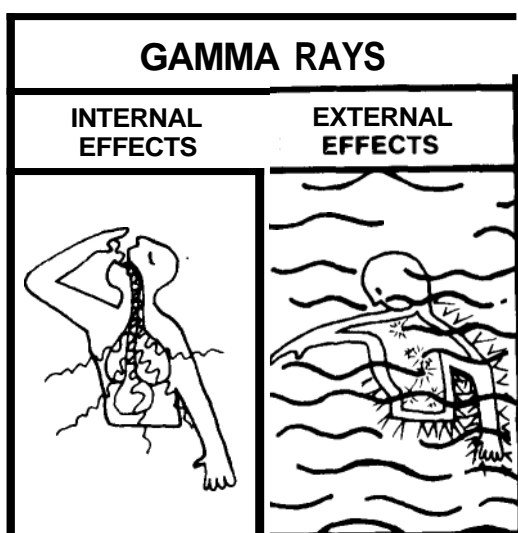
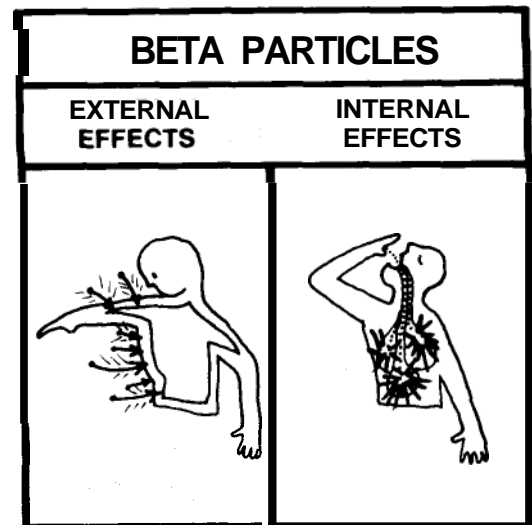

**Gamma radiation** is the most dangerous of the three kinds of fallout radiation because it can penetrate your entire body and cause cell damage throughout your organs, blood, and bones. If enough cells in your body are damaged by gamma radiation, you will feel sick. Higher levels of exposure will cause death. However, even if you are exposed to enough radiation to make you sick or possibly to kill you later on, you may not feel anything while the radiation is being absorbed in your body. The nerve cells of your body are not directly stimulated by nuclear radiation, as they are by pressure and temperature, so the radiation cannot be physically detected.

You should be concerned mostly about radiation from gamma radiation which is produced by fallout particles that fall from the cloud and land on the ground, buildings, trees, and shrubs around you. This radiation is called external radiation because it comes from particles which are outside your body.

### External Radiation Hazards

Both gamma and beta radiation are external hazards, but gamma radiation is by far the more serious. Gamma radiation is highly penetrating. The rays pass right through the body damaging some cells and destroying others. High exposure can impair the production of white blood cells, weaken the body's ability to fight infection, and cause death.

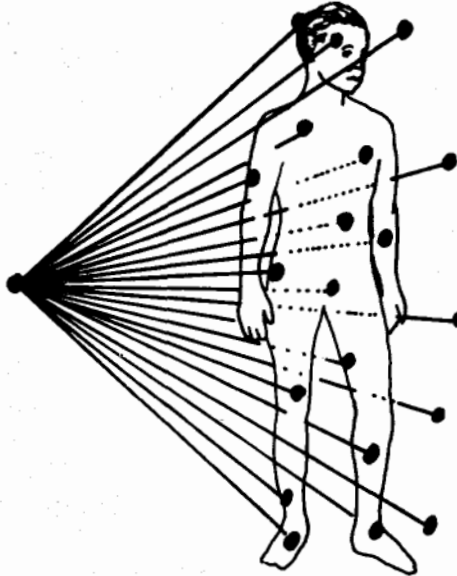

The human body has ways of repairing damage done to it. Small amounts of radiation exposure would probably cause no noticeable effects. If only a small number of cells are damaged, the body can quickly repair most of the damage. Larger doses can cause radiation sickness or death when so many cells are damaged that the body's ability to repair itself is insufficient or overwhelmed. Because of the body's repair mechanisms, a large amount of radiation exposure spread out uniformly over a period of years would not cause radiation illness. But, if this same amount of exposure were received over a period of a week or less, it would probably result in serious illness or death.

## Radiation Sickness

When too many cells are damaged by exposure to gamma radiation, radiation sickness occurs. Some or all of the symptoms may appear within the first three days after exposure. These early symptoms include fatigue, nausea, vomiting, diarrhea, irritability, and lack of energy. But beware: these same symptoms may also be caused by other factors such as fear. If caused by radiation, the symptoms will usually disappear in a day or two. In more serious cases, they will reappear after a period of 1 to 2 weeks. Often new symptoms will also appear then, such as hair loss and small hemorrhages or bleeding under the skin. Since the body's immunity is low, infections may set in, causing fever and disability. In very serious cases, cell damage is so severe that death results. The greater the dose, the earlier the symptoms will appear. They will also be more severe and last longer.

Medical care and antibiotics can reduce the danger from infection while the body repairs itself. But no medication can "treat" damaged cells. You will learn how to help victims of radiation sickness in Chapter 5.

An important point to note is that radiation sickness **is** not contagious. People exposed to radiation do not become radioactive. They are not dangerous to other people.

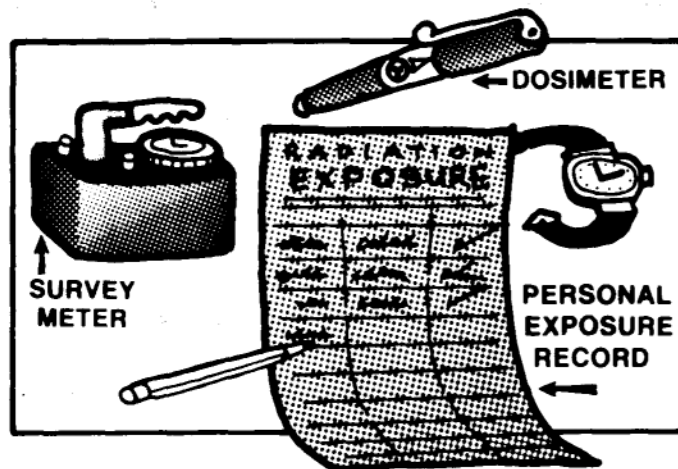

## Measures of Exposure to Gamma Radiation

How much radiation exposure a person can absorb without getting sick varies from person to person. One person may tolerate a given exposure without apparent effect, while the same exposure might make another person extremely sick.

Radiation is measured in units called roentgens (abbreviated "R" and pronounced "rent-gens") by two different kinds of instruments. The dosimeter measures the total "dose" or accumulated exposure to radiation. The survey meter measures the rate of exposure, or how quickly a radiation exposure is accumulated.

The following chart gives estimated effects on the average adult from exposure to gamma radiation. Exposures are given in roentgen units.

Medical care will be needed by:	Accumulated radiation exposures (R) in any period of			A B C
	a	b	c	
	One Week	One Month	Four Months	
A NONE	150	200	300	
B SOME (5 percent may die)	250	350	500	
C MOST (50 percent may die)	450	600	---	
	a	b	c	

Notice that the average adult can tolerate and recover from an exposure to 150R over 1 week or 300R over a 4-month period. However, exposure to 300R in 1 week could cause radiation sickness and some fatalities.

Chances of illness from infections may be greater among those who are exposed to more than about 250R, because the high radiation exposure damages the immune system in our bodies that helps fight diseases.

The point to remember is that the more cell damage that takes place, the more chance of sickness. If fallout is coming down, take shelter and stay there until you are certain it is safe to leave. If you are exposed to radiation before reaching your shelter or if you must leave the shelter for any reason, keep a record of the circumstances (the date, location, length of time). Record the approximate exposure in roentgens if you know what current outside levels are. Better still, if you have a dosimeter that measures radiation exposure, record the exposure indicated on the instrument. Try to keep your radiation exposures as low as possible, but in no case should voluntarily exceed the exposures shown in row A of the above table.



### Radiation Burns

Burns may result from external exposure to beta radiation if a lot of fresh fallout particles (enough to make you feel grimy) stay on the skin for several hours. Early symptoms of such skin contamination may be itching and burning sensations on the skin. These may soon disappear. Darkened or raised skin areas or sores may appear within one or two weeks. After two weeks or more, there may be a temporary loss of hair. The greater the exposure, the earlier the symptoms will appear. Beta burns will not be a problem if fallout particles are brushed or washed off promptly. Within a few days after fallout has arrived, the radioactivity decays so much that beta radiation will not be a hazard

under most circumstances. It may be a problem if you must lie or crawl on the ground, and your skin is covered with dust for many hours.

## Internal Radiation Hazards

When fallout is swallowed or inhaled, radioactive elements from the fallout may concentrate in parts of your body and become an internal hazard. Some radioactive elements may be distributed uniformly through the body while others may be concentrated in specific organs or bones. For instance, if you were to eat, drink, or inhale radioactive iodine, your body would handle the iodine in the same way as it handles stable iodine. This means that the majority of the radioactive iodine would rapidly be absorbed in your thyroid gland where it could cause damage.

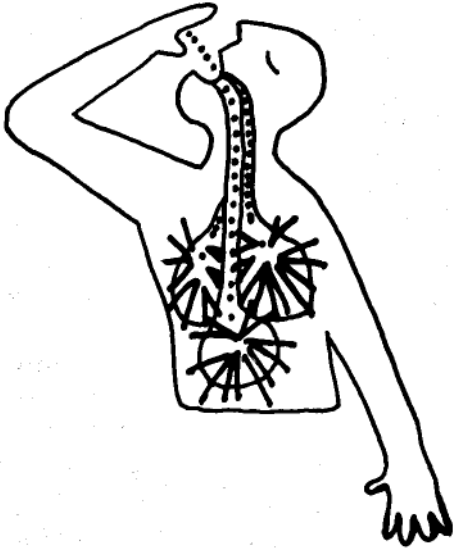

Any radioactive material that enters the body will decrease by radioactive decay and by the body's elimination processes. The best protection is to avoid internal radiation as much as possible.

While internal radiation may cause some harm, the short-term effects are minor compared to external exposure to gamma radiation. You should take precautions to avoid breathing or swallowing fallout particles. But even if you take in some particles, do not be overly concerned. You will not get sick. Remember, if you must choose between contaminated water or no water, **drink the water**. Problems resulting from internal radiation exposure will not appear for several years, if they appear at all.

## Long Term Dangers

In addition to radiation sickness from exposure to excessive whole-body gamma radiation and beta burns from prolonged contact with fallout, exposure to nuclear radiation has some effects which may not appear for many years. In a nuclear war, our first concerns will be with survival from the early effects. If the levels of nuclear radiation are low enough so that radiation sickness is not a serious factor, then we can become concerned with avoiding long-term effects. Years after either external or internal exposure to radiation, there may be an increase in the usual number of cases of leukemia, other forms of cancer, or cataracts. For instance, the number of cancer victims may double from the present number of cases.

In addition to effects on those exposed directly, there may also be effects on babies while in the womb and on the offspring of couples in which one or both members have been exposed to high levels of radiation. Most pregnant women who are exposed to enough radiation to cause symptoms of early radiation sickness will probably have a miscarriage shortly after the exposure. There may be some developmental defects in the few babies born to heavily exposed mothers.



### Contamination of Food and Water

Food and water that have been exposed to nuclear radiation but do not contain fallout particles are safe for human consumption. If food containers, fruits, vegetables, and grains become contaminated by the presence of radioactive fallout particles on them or mixed with them, they need not be thrown away. If the particles can be removed by washing, scrubbing, brushing, or peeling, the food is safe for consumption.

Water in covered containers and underground sources will be safe to drink. Water into which fallout particles have fallen may be filtered or siphoned off the top after fallout particles have been allowed to settle on the bottom. In general, if protected water sources are available, contaminated water should be avoided during the first few weeks after fallout has stopped. During this time, radioactive decay will naturally eliminate most of the danger from drinking the water. You will learn how to filter and protect your water in Chapter 5.



### Summary of Radiation Facts

Exposure to too much radiation is harmful to humans. However, radiation has certain known characteristics that allow you to protect yourself.



1. Radiation can be detected and levels of radiation can be monitored. Although human senses cannot detect radiation through sight, smell, hearing, taste, or touch, special instruments such as survey meters can measure the amount of radiation present in an area. Dosimeters can measure a person's total accumulated exposure to radiation.

2. Radiation rays and particles can be blocked by shielding. A layer of clothing can block the path of alpha and most beta particles. However, gamma rays require thicker, denser materials like concrete or several feet of earth to block their penetration. Although some gamma rays may penetrate even thick shielding, most of the radiation will be blocked by the shielding material.

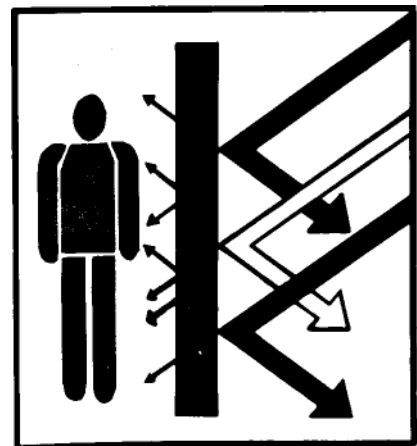

3. The radioactive products from a nuclear blast do not remain harmful forever. Radiation is energy from a source which has a lifespan determined by the type of radioactive material. Radioactive material loses its ability to emit harmful gamma rays, beta particles, and alpha particles through a process called radioactive decay. Some of the nuclear radiation from a nuclear explosion is released instantly into the area immediately around the blast site. The rest is contained in the radioactive materials that are sucked into the radioactive cloud. These materials return to the earth as fallout and give off much of the radiation

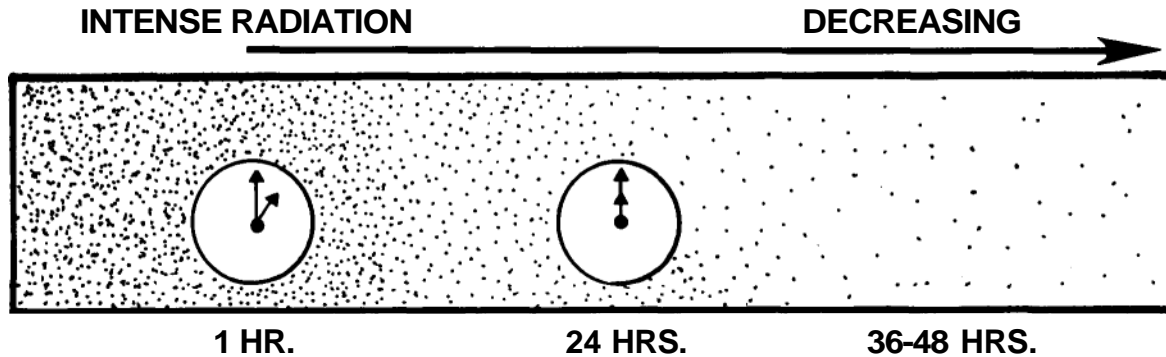

within the first **24-48** hours after the explosion. In most areas, radiation from fallout will reach relatively safe levels within two weeks. But the rate of gamma ray emission near the blast site may take months to decay to “safe” levels.

The decay of radiation is expressed by the “seven-ten” rule. Seven hours after detonation, radiation decreases to one-tenth of the original level. Two days (49 hours) later, the level decreases to one-hundredth as much. In two weeks, the level decreases to one-thousandth, and so on.

4. Radiation will not make food and water radioactive. Gamma rays will pass through most food and water without harming it. Swallowing a few particles would not be immediately dangerous. Swallowing many particles might eventually cause internal harm to organs, but will not cause radiation sickness. Because there may be a long-term danger from eating or drinking contaminated food and water, you should use protected supplies if possible. However, even contaminated food or water should be used if nothing else is available.

Most of the nation’s food and water supply will be usable after an attack. If fallout particles get on food or food containers, the food can be eaten after washing or wiping off the particles. Most fallout particles in open water supplies will eventually settle to the bottom. They may be avoided by filtering the water or siphoning off the top layer.

5. Radiation effects on the human body are cumulative. A small dose of radiation will probably not harm a person. But a large whole body exposure or several small doses can harm you. Radiation passing through parts of the body damages cells. The body can repair the damage from a smaller dose; however, if many cells are damaged after a very high exposure, the body also may not be able to repair itself. The body loses some of its ability to fight infection, so other illnesses can cause more harm. Therefore, you must protect yourself from any unnecessary exposure to radiation.

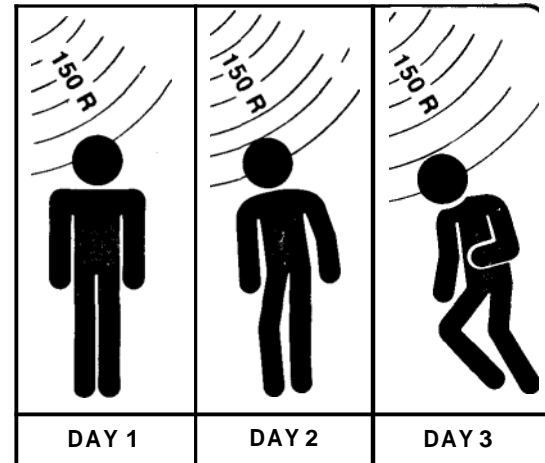

### Steps to Radiation Protection

1. Take cover in the best available shelter you can find as soon as possible. A well-shielded fallout shelter is best, but an underground basement, mine, cave, or tunnel can also provide protection.
2. Brush off any fallout that falls on your head, body, or clothing.
3. Protect food and water sources as much as possible. Wash or brush off any food that may have fallout on it.
4. Filter or siphon the top layer of contaminated water after allowing the fallout particles to settle to the bottom.
5. Cover open wounds.
6. Avoid breathing fallout-contaminated air. Cover your mouth and nose if you must be outside when fallout is still coming down.

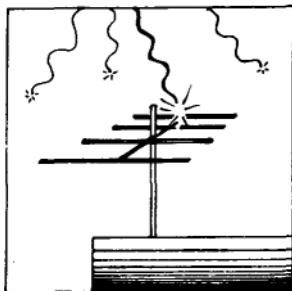

### EMP Effects on Communications and Power

A nuclear detonation affects the electrical charges on molecules in the atmosphere. As a result, a nuclear explosion can affect electrical devices, including communications and communications equipment signals. Radio and radar waves can be interrupted or distorted, but a more serious problem is presented by electromagnetic pulse, known as EMP.

When a nuclear weapon explodes, the gamma rays interact with the air molecules and atoms to produce an electrical field. This field has considerable energy which is released in a pulse that travels away from the blast site at the speed of light. This electromagnetic pulse (EMP) can be attracted by metal collectors just as radio waves are picked up by antennas. These collectors could be cables, antennas, power and telephone lines, electrical wiring, metal reinforcement posts in buildings, metal fences, or the like.

The energy of the pulse can be converted into strong electrical currents and high voltages which can damage electrical and electronic equipment connected to or near the collector.

EMP travels at such high speed that ordinary devices like circuit breakers and lightning rods cannot be relied on to protect equipment. The consequences of EMP can be serious for any system that relies on electrical or electronic equipment. Electrical power generators, telecommunications, radio, radar, television, telephone, and computers can be disrupted or damaged by EMP.

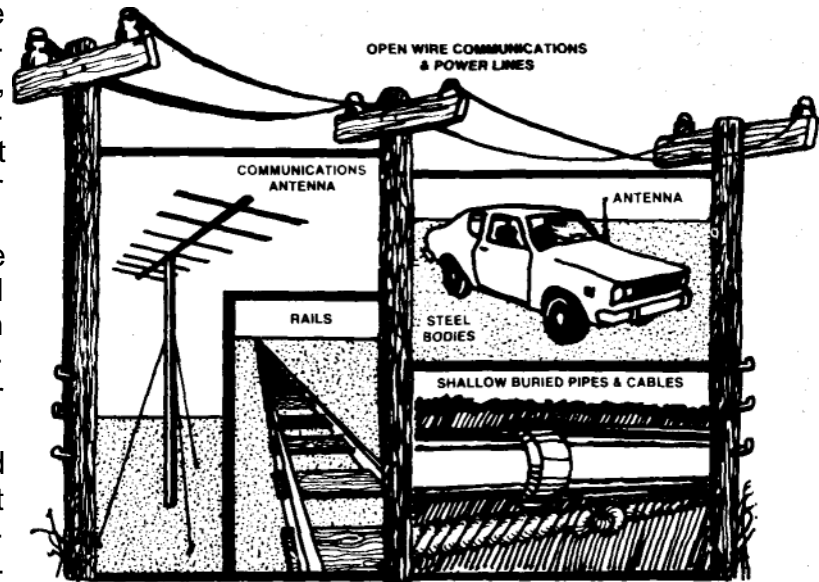

### **EMP Danger to People**

EMP will not pose a danger to people in most instances. If you were touching a collector such as a fence or a long metal rod, you might receive a shock. However, if you are in range of EMP from a ground burst weapon, you should be much more concerned about blast and heat effects.

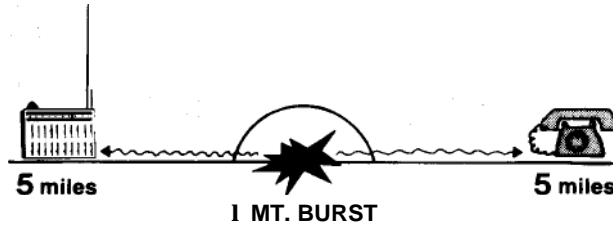

### The Reach of EMP

The size of the area affected by EMP depends mostly on the type of burst. A surface burst will produce a very strong EMP that can affect about the same size area as affected by blast and heat. However, the EMP from a high altitude burst can affect a much wider area. For a nuclear explosion 50 miles above the ground, the affected area on the ground would have a radius of about 600 miles. An explosion 200 miles above the ground could affect the entire continental United States.

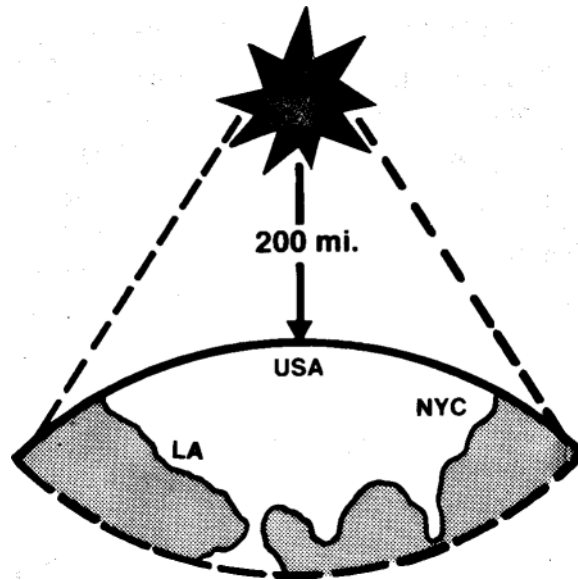

### Protecting Equipment From EMP Damage

Methods exist for "hardening" sensitive equipment to prevent damage from EMP, but these methods are probably not available to most citizens. They are being used by the government to protect some radar and communications systems.

The average citizen can protect many pieces of equipment by unplugging them from wall outlets. Also, radios and televisions should not be attached to any antenna longer than 30 inches. Disconnect any wires leading to outdoor antennas that are longer than 30 inches and push all retractable antennas to the shortest possible length.

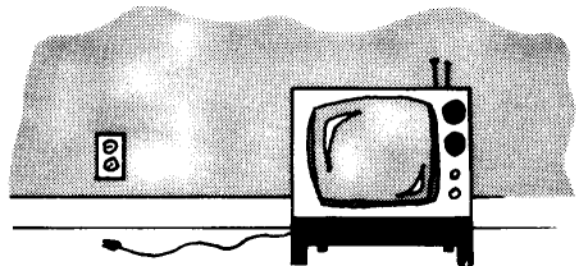

## Attack Warnings and Responses

Remember that time, distance, and shielding are your greatest protectors. To take advantage of these protectors, you should be alert to warning signs and signals. You must also know how to respond safely to each.

**IF** The news media report increasing tension and military build-up between the United States and a nuclear power such as the Soviet Union...

- RESPONSE**
- o Prepare to protect yourself
  - o Prepare to leave the area if you are in a potential target area.
  - Listen for instructions that will be announced through radio and television.
  - o Read newspaper articles for special information for residents of your area.
  - Prepare a home shelter or locate the shelters nearest to your home or place of employment.
  - Review this book.

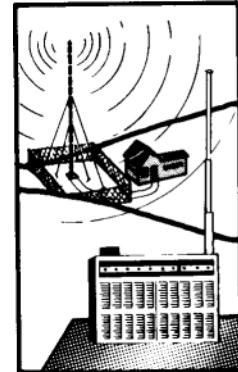

**IF**

The Attack Warning Signal sounds or if you see a brilliant flash high in the sky but feel no heat or blast, and if radio, television, and telephone communications are suddenly disrupted.. .



**RESPONSE**

- Seek the closest, best possible shelter that you can find within 5 to 10 minutes.
- Get into a “safe” position and be prepared to watch for and fight fires.
- Turn the dial on your portable radio to find a station that may still be broadcasting.

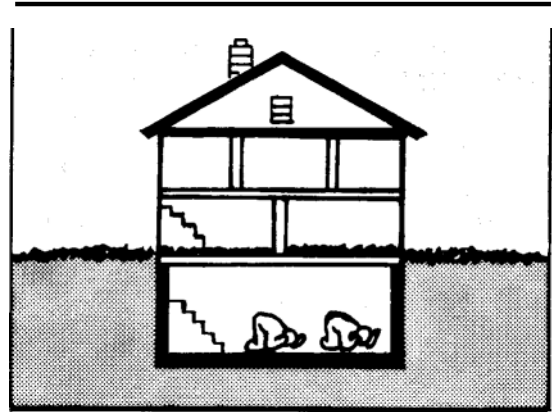

**IF**

**You see a brilliant flash brighter than anything you have ever seen before, and feel intense heat. . .**

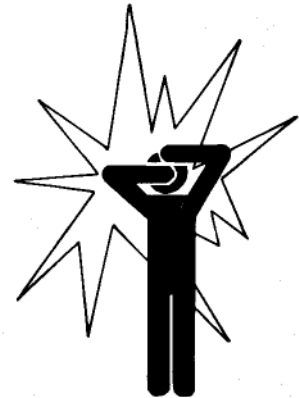

**RESPONSE**

- Look away from the flash.
- Dive for cover immediately—you may have less than a second.
- Get into the take-cover position.
- Stay there until the blast is over.
- Get to the nearest fallout shelter.



The most expected situation is one of gradually developing international crisis. Nations are not likely to engage in a full-scale nuclear war without days or weeks of very serious, increasing tension. Most experts believe that a severe international crisis will precede a nuclear attack. However, even the experts agree that all citizens should be prepared for any situation, including a surprise attack. The more you know about how to respond to any situation, the better protected you are.

### **Nuclear War: Could it Happen?**

The probability of a nuclear attack on the United States is low, even in times of international tension. The leaders of nuclear nations know the destructive force of these weapons. The loss of life and destruction of property would be so devastating that world leaders probably would not be willing to risk the destruction of their own nation by launching an attack on the United States.

Nevertheless, a nuclear war is possible. Hostility and war between nations fills the pages of history books. As more and more nations develop nuclear capability, the possibility of nuclear war increases. There is no guarantee that all nuclear nations will use their capabilities responsibly. Nor is there a guarantee that a nuclear war would not start by accident, miscalculation, or escalation of conventional conflict.

### **Nuclear War: What Would Happen?**

You have learned about the widespread effects of a single nuclear explosion. An attack on the United States would probably mean nuclear weapons would be launched at many targets in this country. Everyone could be affected.

- Many areas would suffer physical damage from blast and fire.
- Large areas of the country could be covered by radioactive fallout.
- Millions of people would be killed and additional millions would be injured. The extent of death and injury would depend in large measure on whether or not the American people take protective actions that could increase their chances for survival.
- The systems that we depend upon for goods and services would be disrupted. We have developed very complex economic, manufacturing, distribution, and communications systems. A large attack would mean scarce food and other supplies and limited communication.
- Rebuilding of cities and systems would take many, many years. Millions of people would be without permanent homes and jobs.

In short, a nuclear war would have far-reaching effects on our country and the world.



## Nuclear War Survival

The effects of nuclear attack would be terrible but people can still improve their odds for survival if they know what to do. Survival will not be easy, especially if you wait until a crisis develops before you begin to protect yourself. Learn the basic steps to survival now, and begin thinking about what you must do in your personal situation.

This chapter has taught you about the dangers. The remaining chapters will teach you what you must do to protect yourself from those dangers. You also will learn more about local government responsibilities to develop plans to protect citizens from the effects of nuclear attack, how you can protect yourself, and how you can increase your chance for survival.

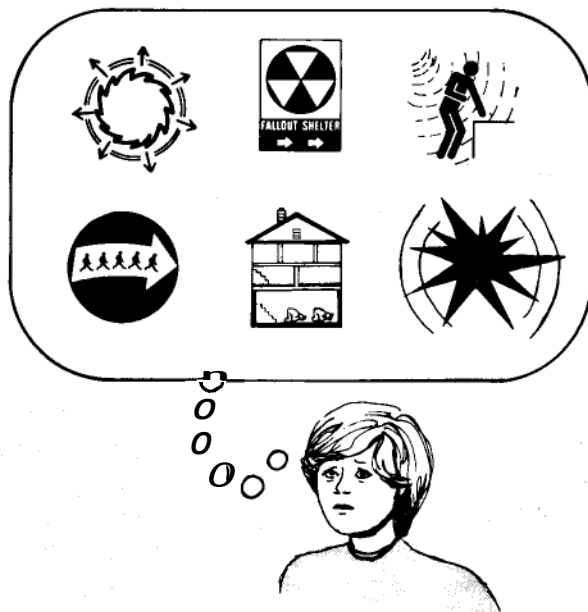

This Page  
Intentionally Left  
Blank in the  
Original  
Document

[Http://www.survivalring.org](http://www.survivalring.org)

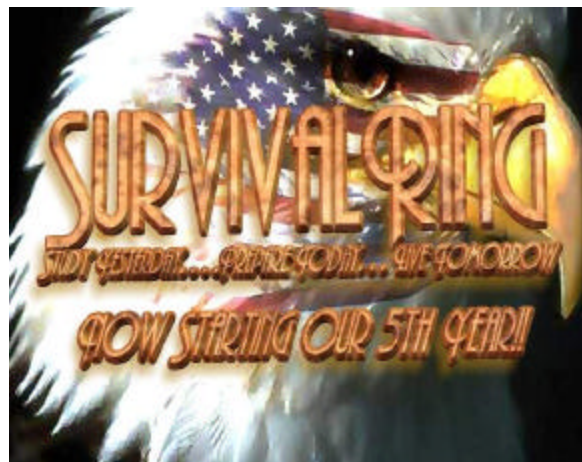

## CHAPTER 2

# CIVIL DEFENSE AND EMERGENCY PLANNING

This chapter is about civil defense and emergency planning concepts. Developing actual plans is a local responsibility which some communities take seriously and others do not. This chapter describes the guidelines provided by the federal government to states and local communities. Other chapters in this book will provide guidelines to help you make personal preparedness plans. You are encouraged to learn about local civil defense plans and tailor your own plans accordingly.

Civil defense, that is, protecting life and property from an attack or from natural and technological disasters, has undergone many changes over the years. These changes result from better understanding of the effects of nuclear weapons, new developments in nuclear weapons, changes in military strategies, and the implementation of all-hazard, integrated emergency planning.

### All-Hazard (Integrated) Emergency Planning

Emergency planning in the United States addresses all hazards that are likely to affect a given community. That is, plans are developed on an "integrated" basis, addressing both peacetime and possible attack hazards. The federal government, through the Federal Emergency Management Agency (FEMA), helps states and communities develop comprehensive preparedness plans and coordinates resources to provide protection from any type of emergency. **All** life-threatening hazards—from natural events like hurricanes, floods, and earthquakes to technological hazards such as radiological accidents and chemical spills, to nuclear attack crises—have certain common elements. Basic to these are the need to alert the population, evacuate people from threatened areas, and provide in-place shelter if the population is not evacuated. States and communities are assisted in developing emergency plans that involve evacuation and sheltering of residents. Some communities already have very well-developed plans; some have plans still under development.

These plans reflect the fact that there are two basic ways to protect people from a hazard that threatens their lives:

1. providing in-place shelter
2. evacuation to a safer place and the provision of shelter there, if necessary.



Sheltering people "in-place" means providing protection at or near their homes, schools, or places of work. In-place sheltering is essential for hazards which arise quite suddenly and do not provide enough warning to give people time to move to a safer place. Such threats include, for example, tornadoes or an attack which might occur either suddenly or after only a brief crisis period. In-place sheltering in a crisis involves providing as much blast, fire, and radiation protection as possible in potential target areas in case there is no time to evacuate.



Evacuation is appropriate for all hazards which give enough advance warning to allow people to move to a safer area. The integrated emergency plans for a community may include evacuation from a variety of possible threats including hurricanes, floods, an accident at a nuclear power plant, or the release of a toxic substance such as chlorine. Evacuation plans may also be developed for the possibility of an acute international crisis. Plans for the single purpose of evacuating certain cities in the event of a crisis were developed during the years from 1976-1983. These plans are currently being broadened to include all-hazards integrated plans.

## Civil Defense

Protecting millions of people against nuclear attack is a complex task. The problem gets more complex as our population grows and more and more people move to cities and large urban areas. Also, the world is experiencing a growing nuclear threat as more nations acquire the ability to develop nuclear weapons.

In its simplest form civil defense involves several elements:

- o **warning systems** to detect an attack and alert the nation,
- o **communication, direction, and control of** emergency personnel in a crisis,
- o **emergency evacuation** of people away from potential risk areas,
- **sheltering** of people to protect them from external hazards,
- **radiological defense** to assess radiation hazards to people, and
- o **training and education** to inform people how to increase the odds for survival.

## Implementation of Civil Defense Plans

No one knows for certain when this country would need to implement civil defense plans and alert the population of a possible attack. Conditions for implementing civil defense measures include:

- o if Soviet cities are evacuated in time of international crisis
- if nuclear weapons are detonated in a war between the Soviet Union and our allies
- o if a threat of nuclear attack against the United States is made by any nation.



### Evacuation of Soviet Cities

The Soviet Union has plans to evacuate cities in time of nuclear crisis. Should these evacuation plans ever be implemented in a time of international crisis, actions to increase civil defense readiness would undoubtedly be taken in the U.S.

### Nuclear War in Other Nations

If a large-scale nuclear war should take place between other countries, our own country could be affected. We could be at some risk from radioactive fallout carried by winds to this country. Protection by staying indoors might be necessary in some areas if fallout was brought down to the ground by rain or snow. While radiation levels in most areas probably would not be high enough to cause radiation sickness or death, it would be prudent to keep radiation exposure as low as possible. **Also**, our country's economy is dependent on international trade and finance. **A** nuclear war anywhere in the world would affect the world economy. The effects of a foreign nuclear war are uncertain, but such a war could cause this nation to implement some civil defense measures to protect the population.



### A Threat of Nuclear Attack

A threat of nuclear attack against this nation would be very serious and civil defense plans would be put into effect. **A** threat of attack would most certainly result in attempts to negotiate a peaceful solution to the crisis. But at the same time, the nation would be alerted to the danger and efforts would be made to protect the people in case negotiations failed.

### Population Protection Planning

In any of these situations, a period of crisis, warning, and preparation is likely to occur. If the crisis escalates, people would be alerted to the need to take protective measures. The two basic ways in which people can be protected are **evacuation** and **fallout sheltering**.

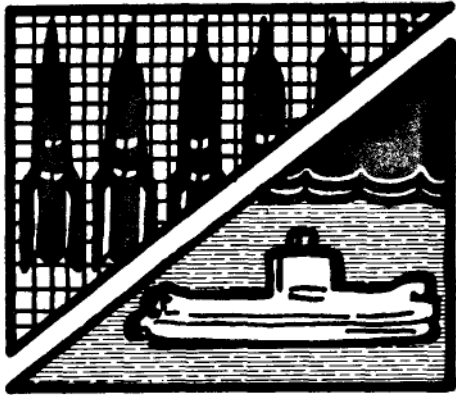

### Risk Areas

Certain areas are considered RISK AREAS because they are more likely to be targets of attack than other area. Any military bases that house our counterattack forces such as Strategic Air Command (SAC) bases and submarine ports are probable primary targets. Large industrial complexes that produce materials needed to support our military forces could be potential targets. Much of our essential industry is located in large cities which are, therefore, also considered risk areas.

Roughly half to two-thirds of the American population live in potential risk areas. The chances of surviving the direct effects of a nuclear weapon without appropriate shelter within several miles of the burst are poor. The heat and blast effects near the explosion would be severe. The fact is, there are no public shelters in risk areas that could protect persons from the effects of blast and intense heat from a nuclear explosion a few miles away.

### Evacuation

Evacuation from a developing threat is more common than many of us realize. Many times each year transportation accidents release harmful substances. Thousands of people may be required to leave their homes and go to a safer area because of these accidents. More frequently than transportation accidents, fires and floods also require people to evacuate. And almost every year people in cities and communities along the Gulf and Atlantic coasts are forced to evacuate from an approaching hurricane.

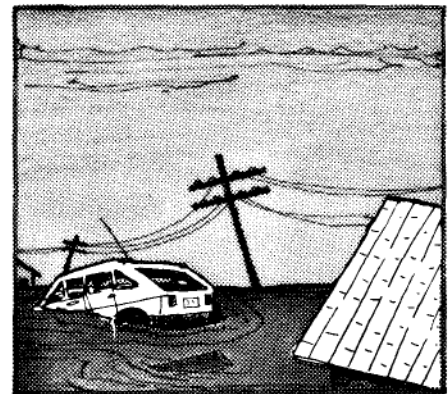

On a number of occasions, hurricanes have forced well over 100,000 people to evacuate coastal areas. In 1985, Hurricanes Elena and Gloria forced about 3.1 million people to evacuate coastal areas along the Gulf of Mexico and Atlantic Ocean. Another 500,000 people were required to evacuate by over 200 incidents such as floods or the release of hazardous materials such as chlorine gas.

Should an acute international crisis ever threaten to result in an attack on the United States, many people living in possible target areas might decide for themselves to move to a safer area. Millions of people in European countries voluntarily left their homes just before the outbreak of World War as well as during the war. People also left their homes during the Korean and Vietnamese conflicts. In the **U.S.**, people were reported to have left Florida cities during the 1962 Cuban missile crisis, although the actual number of evacuees is not known. More recently, during the 1979 Three Mile Island incident, **40** percent of the residents within a 15 mile radius of the power plant left without official advice to do so; a total of 145,000 people evacuated "spontaneously," that is, at their own initiative.

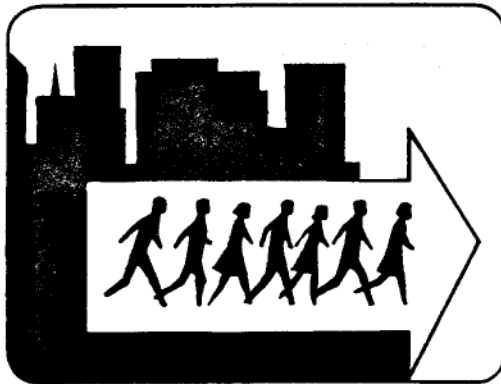

In a severe international crisis, people living in possible target areas might be advised to evacuate. An acute crisis could also result in millions of people leaving U.S. cities as the result of spontaneous evacuation.

If you live in a risk area, you should be prepared to evacuate in time of crisis. If your community has already developed evacuation plans, local authorities will decide when to implement them and advise and instruct residents. Even if local plans for evacuation have not been developed, in a crisis you might be advised to evacuate the area. This book will provide guidelines to follow in preparing your personal evacuation plans. You are encouraged to learn about local civil defense plans and tailor your own plans accordingly.

### **Evacuation Operations**

All types of evacuation have major features in common. People must move from their homes and travel to another area. Evacuees need food, water, and a sheltered place to live temporarily. Some may need medical care and other assistance as well.

In incidents such as a toxic chemical spill, only a few hundred people may need to evacuate. Operations to warn people, help them move, and care for them can be improvised at the time. However, experience in larger evacuations, that involve thousands of people, indicates that careful advance planning is required for successful operations.

Evacuation, both in peacetime and crisis, involves considerable planning and coordination which includes:

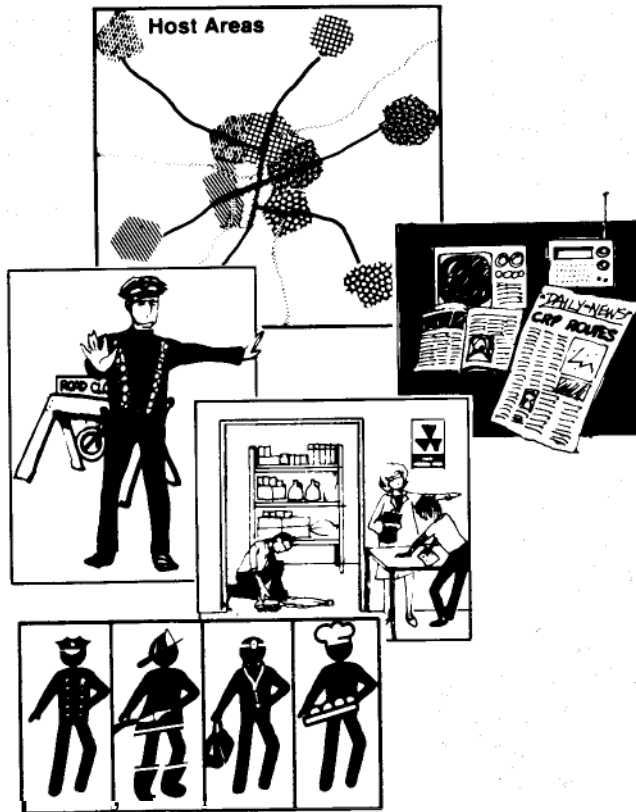

- o determining the reception areas that will receive the evacuees
- o selecting the best, most direct routes out of the risk area to the reception areas
- o providing enough shelter space for all evacuees
- o planning for emergency personnel to direct traffic, provide aid, give medical services, and maintain law and order
- o informing and instructing the public on where to go and what to do
- o providing reception and care for evacuees after they arrive at the reception area
- o maintaining essential activities in the evacuated risk area.

## Sheltering

The second element of population protection is providing fallout sheltering. Evacuation will protect citizens from blast and heat flash, but not from fallout radiation.

Plans for sheltering emphasize providing fallout protection for both evacuees and residents of areas that are not considered potential targets. Fallout is the major long term effect of a nuclear detonation, and its effects can threaten people for weeks. Following a nuclear attack, all survivors may need fallout protection. Residents of risk areas will need to seek shelter away from home in areas not threatened by direct effects of nuclear weapons.





## Reception Area Shelters

Many of the areas of the country that are not considered risk areas will serve as the reception areas for evacuees from risk areas. Unfortunately, these areas are generally small towns and rural communities that may not be well prepared to handle the arrival of thousands of evacuees. Some designated reception areas have already developed plans to receive and find shelter for both residents and evacuees, but many areas are not yet prepared with plans.

Suitable shelters must be available in all areas not designated as risk areas. The National Shelter Survey identifies potential shelters in low risk areas in the nation. Engineering surveys have identified existing buildings which include shelter areas that meet federal standards for fallout shielding. Few, if any, buildings designated as shelters have food or other survival supplies.

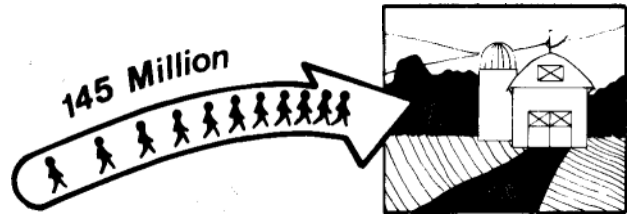

Private home owners in low risk areas can build private shelters or locate suitable areas in their homes that could be used as fallout shelters. Free plans should be available from local civil defense or emergency management offices both for permanent shelters and for upgrading a shelter space in your home. You will find more information about these shelter plans and how to obtain them in Chapter 4.

Many reception areas have few public buildings and may not have enough space in existing buildings to shelter arriving evacuees. In these cases, commercial buildings and churches may be upgraded to provide fallout protection.



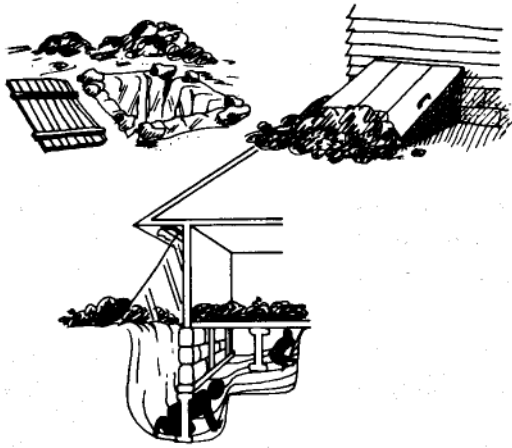

As a last resort, “expedient shelters” can be built within a day or two to provide emergency fallout protection. They can be dug in the ground, next to the foundation of a house or other building, built on top of the ground, or prepared inside a house. They can be built from commonly available materials such as earth, doors, and trees.

Following evacuation, able-bodied residents and evacuees may be asked to help upgrade larger buildings for use as public shelters or to build expedient shelters if these are necessary. Attempts will be made to provide space in public shelters for everyone. If enough shelter space is not available and attack appears likely, expedient shelters will be used to provide emergency protection.

### Risk Area Emergency Protection

Although many risk areas have designated and marked public fallout shelters, these shelters provide little, if any, blast protection. They are available to provide fallout protection for residents if the community is not evacuated. However, in an emergency, they could save your life. You should find out where shelters are located in your community so you can get there quickly in an emergency.



### Warning Systems and Emergency Communications



The ability to detect and warn of an attack on our nation is one of the most important goals of civil defense. Much effort has been placed on the development of warning and communication systems.

Warning systems are designed to alert government officials, defense officials, and the public of an attack. In addition, you should be able to recognize a developing crisis if you read newspapers, listen to radio news broadcasts, or watch national television news reports. The news media have been very good at reporting international situations which could develop into crises.

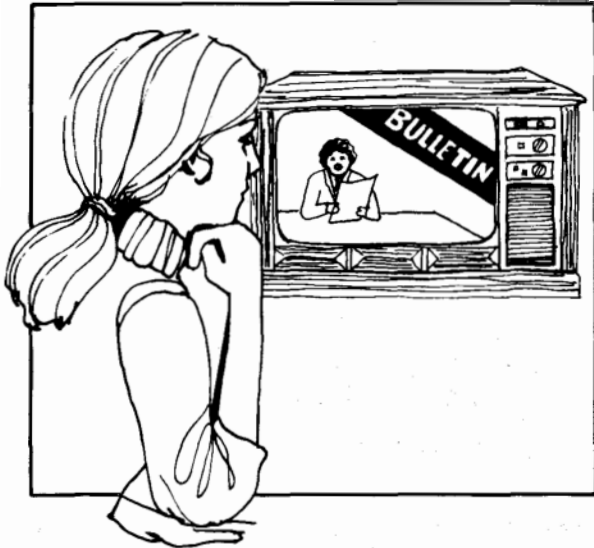

### Warnings of a Developing Crisis

Chances are that you will be aware of an escalating international crisis. Most experts agree that a nuclear attack on this or any other country will probably be preceded by a period of increasing political tension. The period of time could be days, weeks or months. During this time of "crisis expectancy," that is when a crisis is building, civil defense plans will likely be readied. You probably will be alerted first by news reports.

If the crisis grows, your local civil defense office might begin to distribute crisis information. Although local plans for distributing information vary, you may receive information through the news media: television, radio, and newspapers. The local post office also might be used to distribute emergency information.

If the crisis continues to grow, spontaneous evacuation of risk areas is likely to begin and official evacuation might be recommended. In that case, information will be distributed about how to evacuate and where to go, particularly in those areas that have developed evacuation plans. Also, during a crisis-expectant period, officials in areas without plans will likely do their best to develop at least an outline plan to protect people either in-place or by evacuation. They will provide as much information and guidance to the public as possible.

Even an acute crisis does not mean that nuclear attack is certain. Until an attack is actually launched, peaceful resolution of the crisis through negotiation is possible.



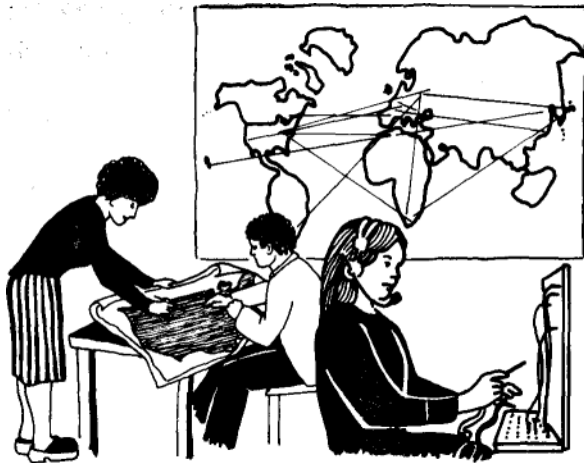

### Emergency Operating Centers

If a crisis becomes serious, Emergency Operating Centers (EOCs) will be activated throughout the country in cities, state capitols, and at the national level. Many of these EOCs will be equipped with protected communications systems so that communications and warnings can be issued if an attack is launched. Local EOCs will be kept informed of crisis developments. The local EOCs will, in turn, keep the public informed through broadcast announcements.

### Emergency Broadcast System

Radio will be a very important source of information for citizens. Radio stations throughout the country are part of the Emergency Broadcast System (EBS). These stations are designated to broadcast important information during a crisis and after an attack. The equipment of some stations has been protected from electromagnetic pulse (EMP) damage so that they may be able to continue broadcasting after an attack. The EBS will receive information from the EOCs to broadcast to the public. Therefore, a radio, preferably a portable battery-operated one, is an important item to have in a crisis.

### Attack Warning Systems

The U.S. has sophisticated attack warning systems that can detect if nuclear missiles are launched against this country. If such an attack is made, the entire nation will be alerted through as many channels of communication as possible.

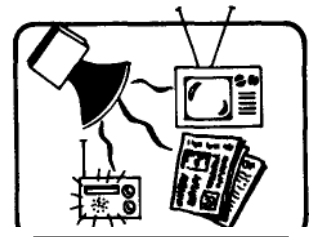

### Outdoor Warning Systems

If an attack is launched, outdoor warning systems will sound a warning to take shelter. Many communities have outdoor warning systems that use sirens, whistles, horns, or bells. There are two standard signals: the Attention or Alert Signal and the Attack Warning Signal.

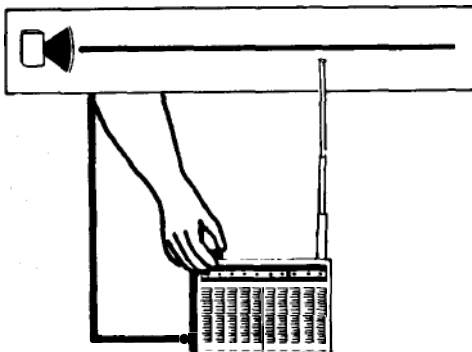

**The Attention or Alert Signal** is a 3-5 minute steady blast on sirens, whistles, horns or other devices. This signal means that the local government wants to broadcast important information. If you hear this signal, turn on your radio or television and listen for important news.

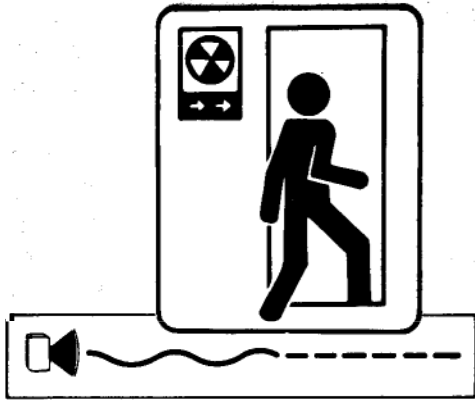

**The Attack Warning Signal** is a 3-5 minute wavering sound on sirens, or a series of short blasts on whistles, horns, or other devices. The attack warning signal will only be used in case of enemy attack. If you hear this signal, go immediately to a public fallout shelter or your home shelter, or follow local instructions for finding shelter. Turn on your radio to an EBS station as soon as you reach shelter.

An attack warning signal could mean that you have as little as 5 to 15 minutes to take cover if you are in a risk area. Residents of other areas may have 30-45 minutes or several hours before fallout threatens.

### **Interrupted Communications**

In the event of an attack, public communications systems will probably be interrupted. Experts believe that the first attack on the nation could be aimed to explode high in the atmosphere. This type of explosion would not be life threatening, but the electromagnetic pulse (EMP) from the weapons could disrupt communications and electrical systems. Although some broadcasting equipment has been protected from the effects of EMP, no one knows for certain if we will have radio communication after a nuclear detonation or how long a possible communications blackout will last.

A communications blackout does not necessarily mean a nuclear attack. Many cities have experienced blackouts in the past when power generators failed. However, if you have had other warnings of a crisis through news reports and local civil defense information has been distributed, you should consider the blackout a serious warning. Follow the instructions given to you earlier by local officials and seek shelter.

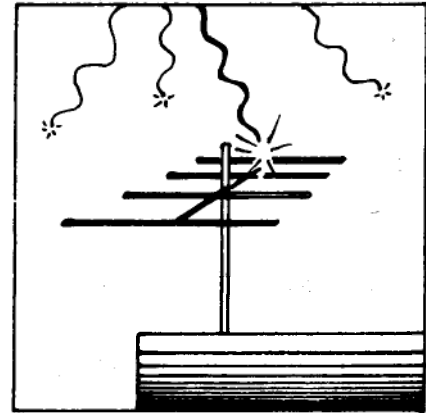

## Your Involvement in Civil Defense

In this chapter, you have learned about civil defense plans to protect the public. You have also learned the conditions under which these plans might be implemented. These plans are for your protection, but it will be critically important for you to do your own part to protect yourself. If you understand the dangers of nuclear weapons and how civil defense plans are designed to protect you from these dangers, you will be better prepared to act wisely in a crisis. Following are some ways in which you can be involved. These steps are outlined in more detail in the remaining chapters.

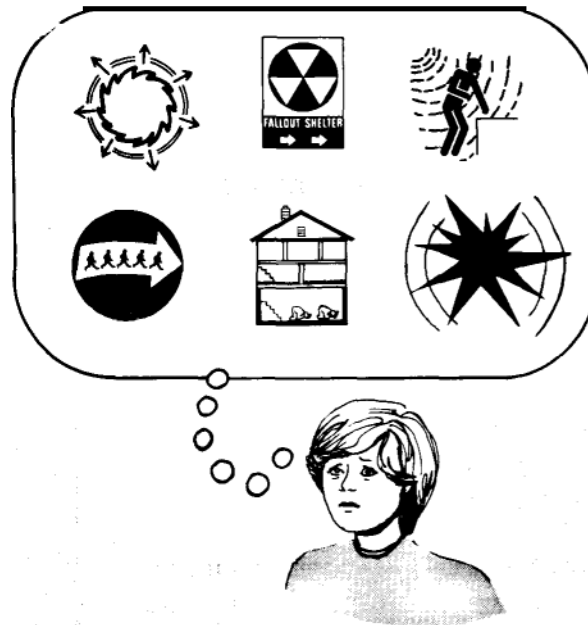

- o *Develop a personal preparedness plan.* Find out the civil defense plans for your community from the local civil defense or emergency management office. If your community might need to evacuate in a crisis, decide now where you will go, how you will travel, and what you will need to take. If you will need to find shelter in your community, decide where that will be—a public shelter or your home. Remember that you will be better able to respond to a crisis if you make sensible plans beforehand.
- *Take a civil defense course on shelter management or radiological monitoring.* **FEMA's** Emergency Management Institute offers both courses, free to the public, as self-study courses. Many state and local civil defense and emergency management offices also offer training classes on these subjects.
- *Follow instructions in a crisis.* If you are advised to evacuate, do **so** quickly. Go to a recommended reception area, and follow recommended routes. If you are advised to go to a fallout shelter in your community, do not hesitate.
- *Carry your own supplies.* Supply your own water, food, bedding, clothing and personal items. Public shelters probably will not be stocked with supplies. Whether you have a home shelter, or go to a public shelter, or build an expedient shelter, you will need supplies for survival.

- Volunteer *your* help. Contribute your time and skills to public protection. In a crisis, cooperation could be the key to your survival. You may be asked to help upgrade buildings for fallout protection, find supplies, work with special service groups, or build expedient shelters. If you have special skills, such as medical skills, you may be asked to contribute these.

The remaining chapters will help you develop preparedness plans both for evacuation and sheltering. Use this information. If possible, get additional information from your local civil defense or emergency management office or the public library.

This Page  
Intentionally Left  
Blank in the  
Original  
Document

[Http://www.survivalring.org](http://www.survivalring.org)

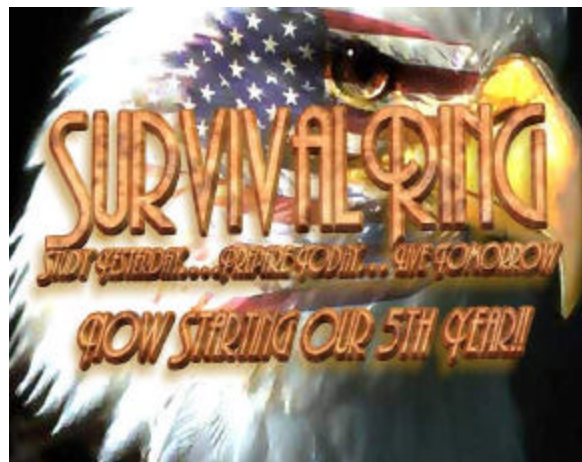



## CHAPTER 3

### PLANNING FOR EVACUATIONS

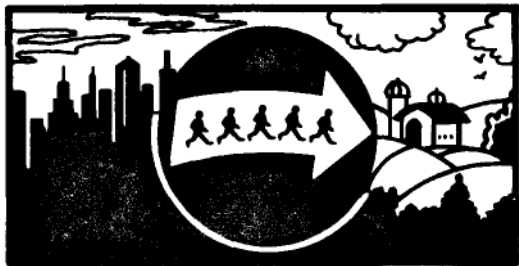

In the first two chapters, you learned the direct effects of nuclear weapons and the hazards close to the point of detonation. You learned that a combination of distance, shielding, and time provide the greatest protection: distance from the blast, shielding from radiation, and time for radiation levels to decay to a safer level. You also

learned about civil defense measures that involve evacuation from probable target areas and sheltering in areas that are not likely targets. In this chapter, you begin to develop your personal emergency plan by analyzing the probable risk to you and by learning how to prepare for evacuation.

#### Analyzing the Risk to Your Community

By now you are aware that you have little chance of surviving if you are within a few miles of a nuclear blast. The most life-threatening effects are the intense heat and the powerful blast. Most buildings within a two mile radius would be crushed or blown away by the blast effects. Decreasing blast damage would extend out to five miles from the blast, and many fires would be ignited by the heat. Survival in this area would be very unlikely. If you live in a risk area, you should plan to evacuate in a crisis.



#### Identifying Risk Areas

You may be in a risk area if you live in a city or community that has a significant military, industrial, or economic importance. Some possible risk areas are:

- communities near a military base with counterattack capabilities such as Strategic Air Command (SAC) or submarine bases,
- large cities that are important government or financial centers,
- port cities or other transportation centers, or
- major industrial complexes.



Check with your local civil defense or emergency management office to find out if your city or community is considered a possible target.



### Sources of Information

Your **best** source of information for developing a sound evacuation plan **before a crisis begins to develop** is your local civil defense or emergency management office. Your local civil defense or emergency management coordinator is the first and primary source of information about civil defense plans in your community.

Civil defense and emergency management offices often have different names. **Look** in your local telephone book and check the listings for your local government for one of the following offices:

- civil defense
- emergency programs
- emergency management
- disaster services
- civil preparedness
- emergency services

If you cannot find a listing, call the main number for your local government. **Ask** how to locate the office that handles civil defense planning for your community.

Once a crisis begins to develop, do not contact your local civil defense or emergency management office. Officials there will be busy preparing for the crisis and implementing local emergency plans. Their phone lines must be kept open for emergency communication.

In a crisis expectant period, the best source of information is the local news media:

- radio
- television
- newspapers.

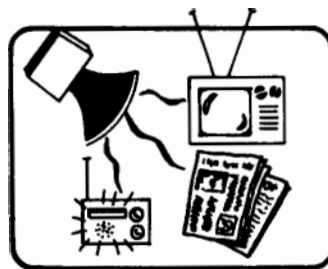

Specific evacuation information will be different for each community. Information will be distributed according to local plans, but you can expect the news media to play an important part in communications. Check news reports to find out the following kinds of information about the crisis:

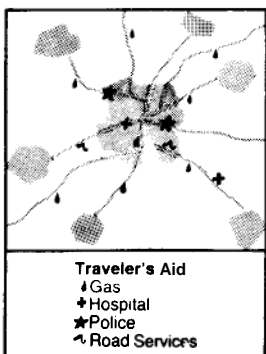
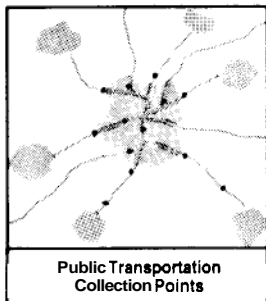
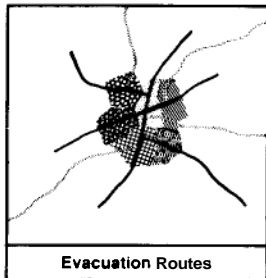

- if and when local residents are advised to evacuate
- what reception areas are recommended. Large cities may direct evacuees to several areas according to the section of the city in which they live. If you have a vacation cottage, friends, or relatives not too far away but outside of a risk area, you will probably choose to go there.
- recommended routes to take. Some communities may publish route maps showing specific routes to take.
- public transportation that may be available for the evacuation. Special arrangements may be made for persons with no means of transportation.
- locations of public shelters
- how you will be alerted to an approaching attack
- what services are available to help ill or disabled persons in an evacuation
- special instructions for evacuees such as where to find gasoline and what to do in case of car failure.

Police and public safety officers will do their best to advise you during the evacuation. In addition, emergency information centers may be established to help answer specific questions by telephone. If these services are available, they will be described in news bulletins.

## Closing Your Home

Many communities in this country have been evacuated in the past because of life-threatening natural or technological hazards. A common experience of evacuees has been anxiety from leaving their homes improperly closed. Although they reached a safe place, they worried about leaving their homes unlocked, leaving appliances on, or failing to secure their valuables.



Remember that an evacuation may not end in an attack. The crisis may well be settled by negotiations, and you may be able to return home. If you carry out the precautions described in this section, you will know that you have left your home as safe as possible from fire and theft.

**Fire prevention** should be your first concern when closing your home. There are two important reasons:

1. After evacuation, there may be no firefighters to handle fires. Although some firemen may stay in or commute to the city during an evacuation, the firefighting force would probably be small. Additionally, there would be very few, if any, persons to report fires that do break out.
2. The heat wave from a nuclear detonation will cause fires for several miles from the blast site. The more you do to reduce the danger of fires starting inside your house, the better its chances of not being destroyed by fire.

Plan to take these important steps to prevent fires in your home:

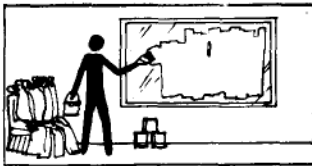

- o Cover windows with whitewash or **foil** and close all heavy-weight blinds or window coverings. Remove any lightweight paper or cloth shades or drapes, or other combustible materials from windows. The purpose of this step is to deflect as much heat as possible and prevent fires from igniting inside your home from the heat flash.

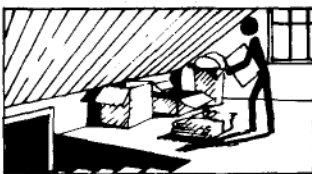

- o Clear away all rubbish and any potential fire hazards from the attic, near windows, or anywhere near your home. Anything combustible may ignite in the intense heat of the heat flash.

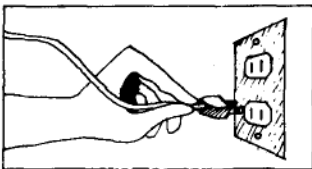

- o Unplug all appliances and turn off all power and fuel sources.



- o Help your neighbors protect their homes from fire.

Take the following steps to prevent break-ins and theft. Remember that a crisis could be resolved peacefully without any exchange of weapons. You could return home after an evacuation.

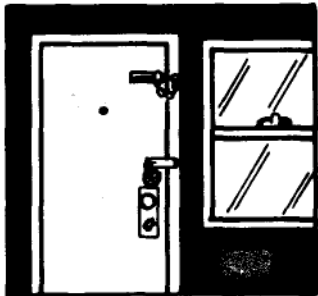

- o Check to be sure that all windows and doors are securely locked.



- Carry all important papers such as personal identification, deeds, automobile titles and registration, and insurance policies with you in an evacuation. For maximum protection, store these papers in a waterproof container.

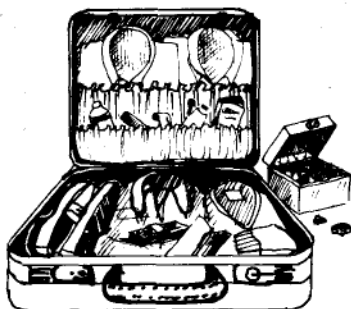

- o Secure other valuables such as jewelry or silver in a safe place. If you regularly keep these items in a bank, leave them there. During the Civil War, people buried their valuables to protect them. You might choose this method if you have no other place, particularly for large items. You can carry small items with you if you can secure them in a safe place, such as the box of important papers.

### Guidelines for Packing

What you take will be mainly determined by how much room you have to carry these items and where you are going. If you are going to a vacation home or private residence, what you take will depend on what supplies are already at your destination. If you are going to a public shelter in a reception area, you will need supplies for traveling, for preparing fallout shelters, and for living in a shelter.

Food, water, and housing should be available in the reception area for evacuees. During the first week, additional supplies may become available for stocking shelters. However, if you have the space, you should carry all the supplies necessary for you to be self-sufficient for at least a two week period.

If you need special supplies such as baby supplies, hearing aids and batteries, glasses, prescription medicines, and special dietary foods, plan to take your own. In Chapter 5 you will find a detailed checklist of supplies needed in a fallout shelter and guidelines to help you judge the quantity of food and water you will need.

As you read the following information about packing, consider what items you already have and what items you will need to obtain. Most of the supplies are common household items that you probably have on hand now. Any items that you plan to get should be obtained before a crisis becomes very serious or acute. If evacuation begins, supplies could be very difficult to find.



### What to Take

Packing for an evacuation should be limited to items necessary first for your health and well-being, next for your comfort. Keep in mind that you could be away from home for several weeks or more. If an attack occurs, many people will be unable to return home if their cities have been destroyed or severely damaged. You may have to make some hard decisions about what to take.

The following items are basic to your needs and listed according to their importance. How much of any item depends on the space you have in your vehicle.

The absolute essentials include the following items:

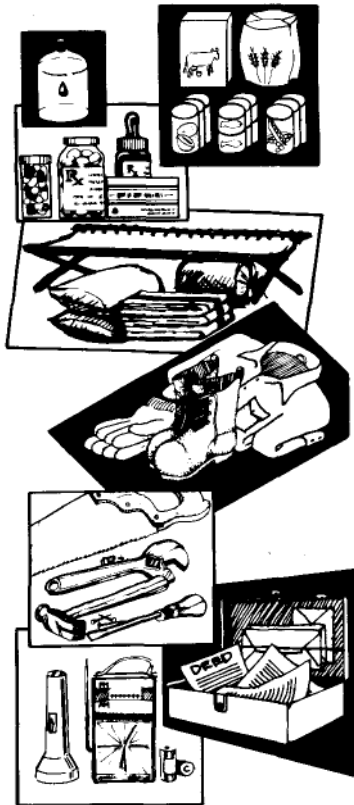

- *Food and water.* You should take as much as you can carry. Water should be carried in non-breakable containers, and food should be canned or packaged. Take any special diet foods that you require since these may be hard to find in the reception area. **Also** take cooking and eating containers and utensils and a can opener.
- *Health and hygiene supplies.* Bring an ample supply of needed prescription medicines. These medicines may be very hard to obtain after evacuating. Take personal hygiene items and household medicines such as aspirin. Take a first aid kit and manual.
- *Useful clothing.* Take practical clothing including outer garments. Clothing should be suitable for the climate and season. Bring sturdy work clothes, work gloves, appropriate footwear, and raingear. Also, take clothes for other seasons in case you cannot return home due to the effects of an attack. You should at least have something warm to protect you from cold weather.
- *Sleeping gear.* Blankets, pillows, sleeping bags, inflatable air mattresses, hammocks, foam rubber sleeping pads should be carried. Sleeping gear should be practical and take up as little space as possible. Be sure to prepare for the special needs of infants, elderly, or infirm persons in your group.

- **Tools.** Include any tools for which you have space, particularly tools for upgrading shelters, such as a shovel, saw, and hammer. An axe and a mattock are also very useful, if you have them. Select only non-electric tools. **Also** include nails, rope, plastic tarp, and sturdy wire of different weights, if available.
- **Important papers.** As noted earlier, always carry personal identification papers with you, either on your person or in a sturdy metal box.
- **Safety supplies.** Include a flashlight, portable radio, and extra batteries. Also take any pertinent civil defense or personal survival books or materials you may have.

### Pets

You must make special provisions for your pets on an individual basis. You have several options. Pets probably will not be allowed inside public transportation vehicles, in public shelters, or in fallout shelters. If you go to a vacation home or private residence, you may be able to take your pets but you will be responsible for their well-being. If you take pets to a public shelter in a reception area without knowing if care is available, you will probably have to confine the pets in your vehicle and be responsible for their care. If you leave your pets behind, keep them confined and provide plenty of food and water for a two or three week period. You **should not turn your pets loose** on their own while you are gone.

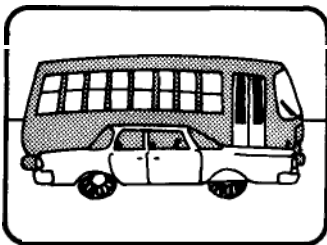

### Traveling

Making travel plans involves determining when to evacuate, where to go, and how to travel. If you require special assistance in traveling, you should plan as far as head as possible. Contact your local civil defense office for advice and information about any special assistance that may be available.

### When to Evacuate

If you live in a risk area, you may have to decide when to evacuate in an escalating international crisis. You may want to wait until an evacuation is officially advised, or you may choose to leave earlier. Only you can make this decision. Many people will leave spontaneously without evacuation being advised. **Also**, local officials may decide, based on their own information, that evacuation is not advisable. You may choose to evacuate anyway or to stay and prepare at home. However, if you are advised to evacuate, you should do so.

### Where to Go

Whether you evacuate spontaneously or on the advice of local officials, you have choices to make about where to go. If you evacuate on your own, you should choose a place outside of a risk area that you can reach by car in one day or less. If you have a vacation home or have friends or relatives living in reception areas, you may wish to find shelter there. If you can afford the expense, you might be able to find a room in a hotel or motel in a reception area.

If local officials advise you to evacuate, they will also advise you where to go. Reception centers may be designated where you can expect to be received and directed to public shelters. Local newspapers may print route maps and directions to reception centers to help find your way. Remember that the plans in each community will vary. If you want to know now if your community has such plans and, if so, where residents will be advised to go in an evacuation, check with your local civil defense office.



### On the Road

If you have a car, van, or truck, you will probably want to use it to travel to your destination. Persons who do not own a private vehicle may be able to use public transportation provided by local officials if they recommend evacuation. However, you may need to find your own transportation. In that case, you should plan your mode of transportation as early as possible.

Your car should be serviced and filled with gas before you depart. If a crisis is building, auto services will be very busy and there may be a high demand for gas, oil, and auto parts. Once on the road, these services may be very difficult to find.

You should carry a state road map in your car. Clearly mark the route that you intend to travel. You may want to consider some alternative routes as well in case the road becomes blocked.

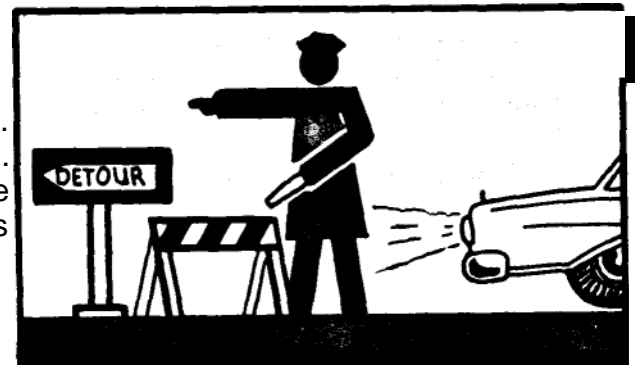





Be prepared to travel slowly. Even if you leave on your own without being officially advised to do so, thousands of others may also be leaving. Roads may be crowded. Once an evacuation is advised, traffic jams are likely. No matter how difficult it seems, try to be patient in slow or stalled traffic.

- o In stalled traffic, turn off the engine to conserve gas and prevent overheating.
- Listen to your radio for news updates and travel advisories. If traffic is stalled, turn the radio on for short periods every fifteen minutes or so to avoid excessive drain on the car battery when the engine is off, or use a portable radio.
- If your car breaks down, pull it off the road to allow other traffic to pass. Signal for help by raising the hood. Police or road service vehicles should be patrolling the evacuation routes and may be able to help you. If you choose to go for help, lock your vehicle or leave someone responsible with the car to protect your belongings.

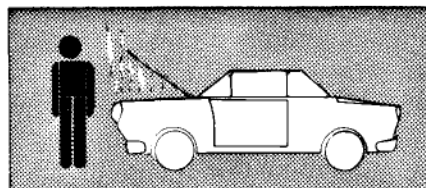

#### At Your Destination

If you evacuate on your own, you should check the local news media for information and news updates on the crisis. If you go to a vacation home, you should unpack immediately and begin to gather materials for preparing a fallout shelter. If you travel to the home of family or friends, be prepared to follow the advice of local officials for preparing and stocking a fallout shelter.

If you evacuate after official advice to do so, there may be a designated reception center at your destination. You may be assigned to temporary lodgings in a public shelter such as a school or church. Motels and private homes may also be volunteered to provide lodgings. If no reception center is designated, public safety officers and emergency volunteers may direct you to a central point where more information is available. Go directly to your temporary lodgings, unpack, and get settled as quickly as possible. These lodgings will be your temporary home until the crisis passes and you can return home or until you are advised to move to a fallout shelter.

In the reception area, you may be asked to register with local officials who will need to know how many persons will need sheltering. Officials will try to find sufficient fallout shelter space for all persons and will attempt to bring in enough water, food, and shelter supplies.

Much of the activity in the reception area will center around preparing and upgrading fallout shelters. At some point you may be assigned to a fallout shelter, or you may be asked to help upgrade your temporary lodgings or other buildings for fallout protection. Local residents could be asked to volunteer their homes to be upgraded and used as fallout shelters. If there is insufficient upgradable shelter space available, emergency officials might coordinate the construction of expedient shelters to protect the remainder of the population.

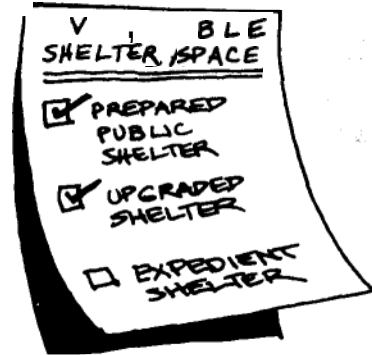

### Cooperation in the Reception Area

From the day that you arrive at the reception area until the crisis is resolved, you will need to work closely with your shelter group and cooperate with local officials. Your help may be needed in a variety of jobs:

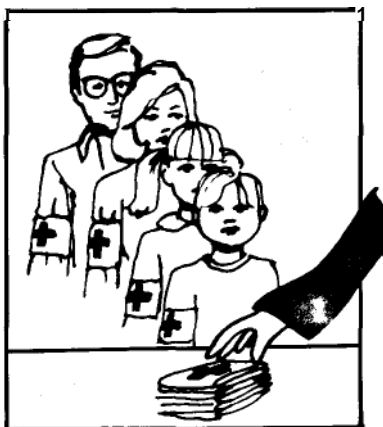

- o *Shelter upgrading teams.* Potential shelters will be designated for upgrading and use if there is not enough space in prepared shelters to house all evacuees and local residents. Upgrading means adding shielding material, such as piling earth around the outside of a building. You may be asked to help in this effort, which will require construction skills and manual labor.
- o *Shelter stocking teams.* Inventory will probably be taken of available supplies in the reception area as well as specific needs in individual shelters. Work teams may be responsible for distributing available supplies to all shelters in the community.
- o *Medical assistance teams.* All evacuees and reception area residents who have training and experience in medicine may be recruited to help with this work team. Doctors, nurses, medical assistants, and emergency medical personnel can all be of service to these groups.
- o *Service groups.* Additional services will need to be organized to provide services such as public safety, emergency welfare operations, child care, and food distribution.

- **Expedient shelter teams.** Able-bodied persons may be called on to help construct expedient fallout shelters if these are needed. These shelters will be dug out of the ground with bulldozers and heavy equipment, if available, and constructed with available materials. They will be needed only in an emergency when there is not enough available shelter space.

### **Waiting**

The first hours or days in a reception area will be difficult. Much activity will take place to organize work groups, public services, and make food and supplies available to persons in the area. Everyone will be concerned about the pending crisis. The crisis could be resolved peacefully by negotiation with no exchange of nuclear weapons, and everyone would hope and pray for this to happen. During the crisis, however, no one could know for certain whether the crisis would end in peace or in war, or where weapons would fall if war resulted. People who have evacuated from a hurricane or other major disaster all experienced the anxiety that results from not knowing what will happen. It is difficult to cope with the deep concern and fear associated with a disaster, but these feelings are natural. Cooperation, understanding, and patience will help make everyone feel less frightened in a difficult situation.

### **EVACUATION CHECKLIST**

The following checklist is a summary of steps that should be taken to prepare for evacuation.

- \_\_\_\_\_ Know where you are going and take a map of your route to your destination.
- \_\_\_\_\_ Service and fill your vehicle with gas.
- \_\_\_\_\_ Collect non-perishable food and water in non-breakable containers.
- \_\_\_\_\_ Coat or cover windows of your house to deflect heat and remove combustible items from the attic, near windows, or immediately outside of the building. Close non-flammable blinds or drapes.
- \_\_\_\_\_ Take medicines and medical supplies.
- \_\_\_\_\_ Take your important papers in a waterproof metal box.
- \_\_\_\_\_ Take preparedness materials such as this book, self-help medical books, and other survival literature.
- \_\_\_\_\_ Pack general purpose clothing and tools such as boots, workgloves, a hammer, saw, shovel, ax, and pick.
- \_\_\_\_\_ Pack sleeping gear, practical clothing, and personal hygiene items.
- \_\_\_\_\_ Pack your vehicle carefully, taking the most essential items.
- \_\_\_\_\_ Take care of pets. Do not turn them loose outside.
- \_\_\_\_\_ Unplug appliances and turn off utilities.
- \_\_\_\_\_ Lock doors and windows. Secure your large valuables and take small valuables with you.

- \_\_\_\_\_ Go over instructions with family or group members before you depart. Everyone should know what to do. Discuss the realities of the situation in a positive way.
- \_\_\_\_\_ Stay on your intended route if possible. Turn off your car's engine in stalled traffic. Listen to the radio for traffic advisories and information.
- \_\_\_\_\_ If your car breaks down, pull it off the roadway. Signal for help by raising the hood. Lock the doors if you must leave the vehicle unattended.

You will learn more about preparing, stocking, and living in fallout shelters in the following chapters. The information in these chapters can be used in any type of shelter—public, private, or expedient.

## CHAPTER 4 PREPARING FALLOUT SHELTERS

If a nuclear attack is made on this country, possibly every person in the U.S. would need protection from radioactive fallout. Whether you live in a risk area and plan to evacuate or you live in a reception area and plan to find shelter in your home or community, you need to know the principles of fallout protection. No area of the country can expect to be safe from radiation because fallout will be carried by the wind and may fall anywhere. Although local officials will try to make public shelter space available to as many people as possible, you cannot assume that you will get into a prepared public shelter. You may have to help upgrade shelters or build an expedient shelter to protect yourself from radiation hazards. This chapter will teach you about fallout protection. You will learn about:

1. types of shelters and how to prepare them
2. basic requirements for a safe fallout shelter
3. stocking a shelter.

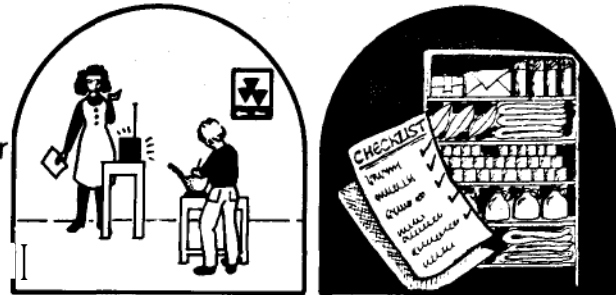

In the appendix at the end of the text you will find designs for expedient shelters that are detailed enough for you to follow in an emergency. You will also find plans for making simple lanterns and emergency stoves.

### Types of Shelters

There are four basic types of shelters:

- public shelters,
- home shelters,
- upgraded shelters, and
- expedient shelters.

Each of these shelter types requires different levels of effort to ensure adequate protection. The following section describes requirements for preparing each of these shelter types.

## Public Shelters

Most public shelters will be located in large existing buildings such as in the basement of a public building, or even an enclosed shopping center. Buildings that have already been identified as suitable fallout shelters currently are used for other purposes. There are no public shelters that are stocked and already prepared to receive evacuees.

In a nuclear attack crisis, previously identified fallout shelter space in existing buildings will be made available. Stocking of these shelters will depend on local preparedness plans, the amount of time local officials have to prepare as the crisis develops, and the availability of supplies. In general, you should **not** expect public shelters to provide you with anything but space.

Because millions of people will probably be evacuating to reception areas, sufficient space in existing shelters may not be available. Preparedness plans in many reception areas include the identification of buildings that can be upgraded to provide fallout protection. Upgrading shelters involves adding heavy shielding material such as earth or logs to exposed walls and ceilings, and providing additional support to prevent collapse from the additional weight. Although earthmoving equipment and trucks will be used as much as possible, evacuees may have to supply much of the manpower needed to prepare shelter space. A nuclear attack crisis is a major emergency of such proportion that everyone should expect to participate in preparedness activities. Time is a critical factor, since shelter space must be prepared before an attack, or, at the very least, before fallout arrives.

If neither existing nor upgraded buildings can provide enough shelter space for everyone, expedient shelters will have to be built to house the remainder until fallout stops and radiation decays to safer levels.

If you are expecting to go to a public shelter in a nuclear attack crisis, you should plan to bring items for your own personal survival and comfort, and as many tools as you can to help prepare your own shelter. Work gloves also will be extremely important. You cannot know before a crisis whether or not space will be available for you in a prepared shelter or if you will have to help upgrade or even prepare an expedient shelter.

Most identified public fallout shelter space contains no shelter supplies, and upgraded and expedient shelters obviously have no supplies. Everyone should bring enough personal supplies to last for a two to three week stay. Experts believe that two or three weeks after a nuclear attack, radiation will decay to levels low enough that full-time occupancy of the shelter would not be necessary. In many areas, radiation levels will decrease sufficiently in this time to allow at least temporary emergence from your shelter to replenish your supplies and perform other tasks. Emergence in two or three days may be possible in some areas. You will learn more about shelter emergence in Chapter 5.

### ***Building and Upgrading Public Shelters***

In most reception areas, existing shelter space will not be sufficient to house evacuees and local residents. Other public buildings that can be upgraded for fallout protection must be identified. Local officials should direct these activities, but citizens will be responsible for preparing shelter spaces. Work teams should be assembled to add shielding materials and prepare spaces for fallout protection.



Buildings used for temporary lodging facilities such as schools and churches can be upgraded, if necessary, to provide fallout protection. Shopping centers, office buildings, and mines, caves, or tunnels can also be converted to fallout shelters.

In any building, the fallout shelter area should be located in the basement or in the central part of the building away from exterior walls, such as on the first floor of a two-story building or on the first, second, and third floors of a four-story building. Additional supports should be built to bear the weight of earth on the ceiling and against the ground-level exterior walls. Twelve inches of soil should be placed on the floor above the fallout shelter and, if possible, on the roof. Windows should be covered with boards to prevent breakage.

The basic principles are: (1) to get as much shielding around the shelter area as possible; and (2) to prevent collapse of ceilings and walls from the weight of the shielding material.

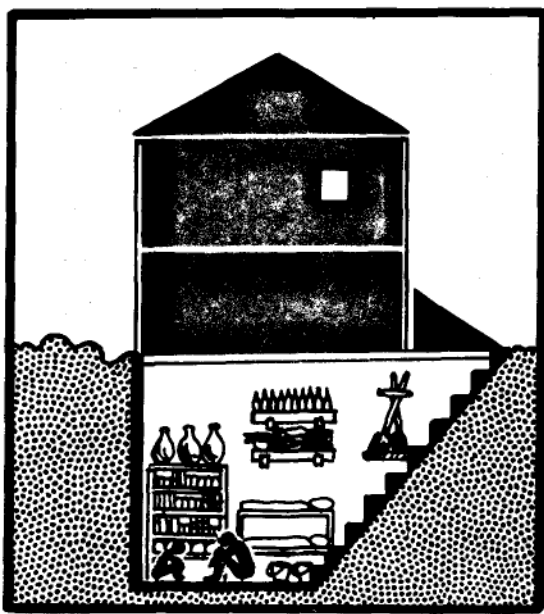
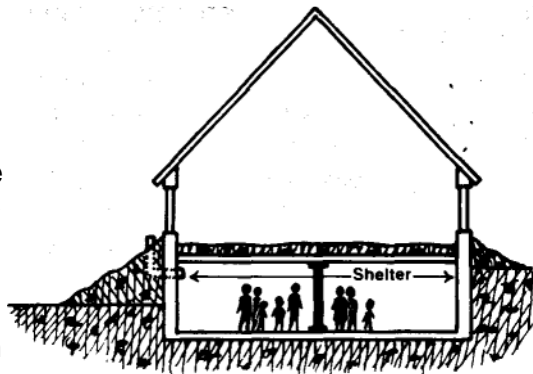

### Preparing a Home Shelter

If you already live in a reception area, you might consider using some part of your home as a fallout shelter. The advantage of a home shelter is that you can stockpile supplies and store them in your shelter in the early stages of a crisis. The problems of organizing a home shelter are not nearly so great as those in a public shelter. However, in building and stocking a home shelter, you must make sure that every detail has been planned carefully. If an attack occurs you will have to rely on yourself and your own resources. Permanent home fallout shelters should be built well in advance of a crisis, but upgraded and expedient home shelters can be prepared in a day or two.

### Analyzing Your Home

The basements of some homes can be used as family fallout shelters without any alterations or changes. Most basements that are situated completely below ground level beneath a house of two or more stories can provide good protection without additional shielding. Other basements will need upgrading, but with some effort and available materials homeowners can create their own shelters.

Consult the following home survey to determine the potential for using your home as a fallout shelter. Answer each question, selecting the answer which applies most closely to your home. Write the number of points selected in the blank space provided and then total the points. Finally, compare your total with the "Shelter Potential Table."



1. How many stories are above the ground level in your house?

- one story 11 points
- one and one-half stories 9 points
- two stories 6 points
- three stories or more 3 points

2. What is the maximum exposure of any basement wall above the ground? (Exclude exterior entrance of 3 feet width or less.)

- no basement (skip question 3) 15 points
- 3 feet or more 8 points
- 2 to 3 feet 3 points
- 1 to 2 feet 1 point
- less than 1 foot 0 points

3. What is the principal material of the basement walls?

- cinder block or concrete block 2 points
- stone, brick, or poured concrete 0 points

4. What are the principal materials of the first story walls?

- solid brick, stone, and concrete 3 points
- other 5 points

5. Is your home attached to or closer than 10 feet from another home or homes of similar size and construction?

- No 2 points
- Yes, 1 side 1 point
- Yes, 2 sides 0 points

SHELTER POTENTIAL TABLE:

- Up to 13 points - Adequate
- 14-19** points - Improvable at Low Cost
- 20 or more points - Low

REMEMBER: The **lowest** number of points means the **highest** degree of fallout shielding.



## Selecting a Space

If you have a basement in your home and your total in the Shelter Potential Table was less than 20, you can prepare to use it as an effective fallout shelter by making simple improvements. In the basement of a one-story house, you will need to increase the amount of overhead shielding in order to provide protection from fallout on the roof. One method of doing this is to install bricks or solid concrete blocks between the joists in the basement ceiling. Be sure to provide extra support before adding this additional weight. If you choose to wait until an actual crisis to improve the shielding, you can add earth to cover exposed window wells and walls. Also, earth can be added to the floor immediately above the basement. Put plastic down on the floor before adding earth to protect the floor, and be sure to add support to the basement ceiling.

## Home Shelter Designs

You can obtain free plans for building and improving home fallout shelters from FEMA. There are several types of plans to suit different kinds of houses. Ask your local civil defense officials to get you copies of the plans or write to FEMA, P.O. Box 8181, Washington, D.C., 20024. Following are some of the plans that you can get.

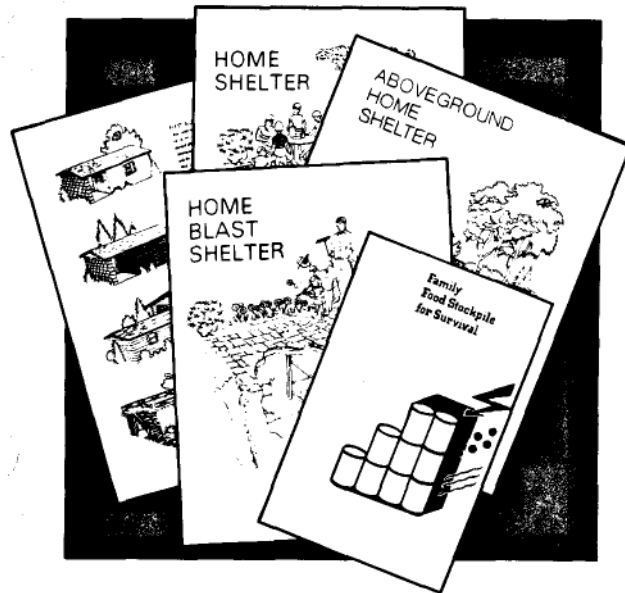

### *Permanent Basement Shelters*

- **Home Fallout Shelter (H-12-A)** is suitable only for basements in which less than 12 inches of the basement wall is above ground level. Overhead protection is obtained by screwing plywood sheets securely to joists, and then filling the spaces between the joists with bricks or concrete blocks.
- **Home Fallout Shelter (H-12-B)** is similar to H-12-A except that new extra joists are fitted into part of the basement ceiling to support the added weight of the shielding. Like H-12-A, this plan should not be used if 12 inches or more of your basement wall is above the ground level unless you add optional walls inside your basement.
- **Home Fallout Shelter (H-12-C)** is made of concrete blocks or bricks and is located in the corner of your basement that is most below ground level.

### *Permanent Outside Shelters*

- **Home Shelter (H-12-1)** is built below ground. The roof slab can be used as a patio. The fallout shelter is reached through a hatch door and wooden stairway. Fresh air is provided by a hand operated blower and two pipes extended above ground level.

- **Aboveground Fallout Shelter (H-12-2)** is built of two rows of concrete blocks filled with sand or grout, or of poured, reinforced concrete. This structure is suitable only for areas where frost does not penetrate the ground more than 20 inches. It can be used to store lawn equipment such as wheelbarrows and lawn mowers.
- **Home Blast Shelter (H-12-3)** is the only outside shelter that provides protection from blast; all other plans listed provide fallout protection only.

### Upgrading Your Home for Fallout Protection

If you do not choose to remodel your home, or if your home has no basement or other permanent structure which could provide basic protection, there are other plans for improvising shelter. Plans for expedient fallout shelters in the appendix offer many different methods of building shelters outside your home during a crisis period. An improvised shelter might not give you as much protection as a permanent one, but poor protection is better than none, and it might save your life.

To improvise a safe shelter you need to put as much shielding as possible between your shelter space and the outside. Consider the following list of household items that can be used as shielding materials or as braces or containers for sand or earth. Other materials are listed later in this chapter.

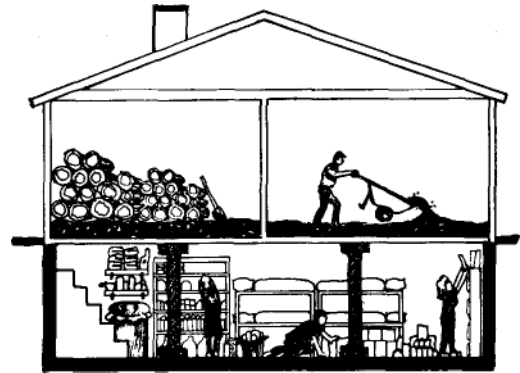

- Household doors that have been removed from their hinges to serve as walls or roofing to be covered with earth or other available shielding materials.
- Dressers and chests with drawers that can be filled with sand or earth after they are placed in position so they won't be too heavy to carry.
- Trunks, boxes, heavy-duty plastic bags, and sturdy cartons which can be filled with sand or earth after they are placed in position.
- Books or magazines in bookcases or stacked in boxes.
- Stacks of firewood or lumber, or flagstones from outside walks and patios.

Remember that you will probably need to provide extra support for the ceiling of your shelter before including the additional weight of shielding materials. **Also** remember that the density or weight of the material is more important than its mass or size. Heavier material provides better protection.

## Expedient Home Shelters

If you do not have a suitable space to prepare or upgrade a shelter, you can use one of the following ideas for preparing an expedient shelter space inside your home, crawl space, or on a boat.

*Inside your home*, you can build a small, expedient shelter by setting up a large, sturdy table or workbench in the corner of your basement that is most below ground level. Place on it *as much shielding as it will hold without collapsing*. Then put as much shielding material around the table as possible, up as high as the table top. You can fill boxes or trunks with earth to serve as shielding around the table.



If you do not have a suitable table or need more space, use large appliances or furniture to form the walls of your shelter. For a ceiling, use heavy outside doors or reinforced hollow-core doors. Pile as much shielding on the doors as they will hold. Add reinforcing supports if necessary. Stack additional shielding material around the walls.

In both of these inside shelters, once everyone is inside, you should block the opening with other shielding materials.

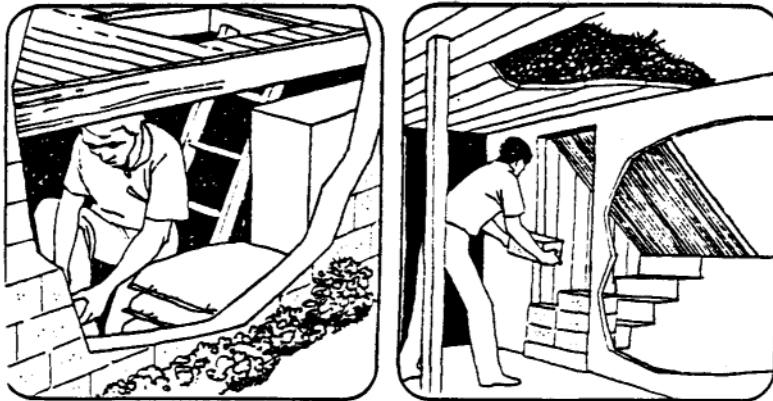

If you have a crawl space under the first floor of your house with brick, cinder block, or concrete foundation walls, you can improvise a shelter there. Find or make an access to the crawl space through the floor or outside wall. Select an area that is under the central part of the house, away from outside walls. Be certain that no heavy furniture or appliance is on the floor directly above you. Put shielding material—preferably bricks, blocks, or containers full of earth or sand—around the shelter area to form walls all the way up to the under side of the floor above you. On the floor above, place additional shielding material to serve as the roof of your shelter. Shore up the shelter roof with extra support, if necessary. If you dig out your shelter area, you will have space in which to stand and you will have plenty of earth for shielding material.

If you live close to the shore and **have a boat with an enclosed cabin**, you can use it for shelter if no better fallout protection is available. In addition to other supplies, you will need a broom and bucket, or a pump-and-hose to remove fallout particles that land on the boat. The boat should be anchored or cruised slowly at least 200 feet offshore, where water is at least five feet deep. The five feet of water should absorb and shield you from radiation that settles to the bottom; however, you must remove fallout from the cabin or deck of the boat and sweep it into the water. Stay inside the boat as much as possible, going out only to remove fallout particles. Healthy persons on the boat should rotate going out to reduce each person's exposure to radiation.

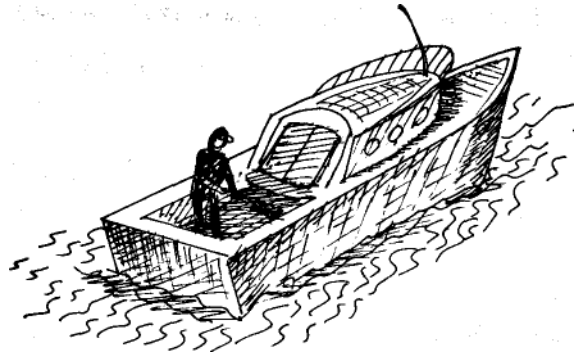

### **Outside Expedient Shelters**

If a home shelter is not feasible, or if sufficient space in public shelters is not available, an outside expedient shelter can provide emergency fallout protection. These shelters require hard work but, with cooperation, a small group of three or four people can build a shelter in about a day. You should not necessarily plan to build an expedient shelter, but you would be wise to know what they are and how to build one.

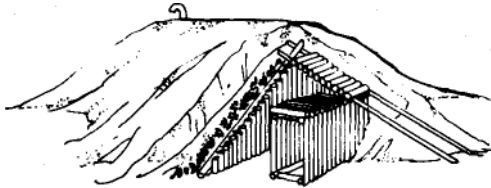

The appendix of this text contains several detailed plans for outdoor expedient shelters that can be built most anywhere. These shelter designs have been field tested by average American families. These families were given only simple instructions and illustrations like the ones in this book. The families were all able to construct these shelters in less than a day. These plans could be useful to you if you ever have to build an expedient shelter.

Expedient shelters may not provide much physical comfort, but they can provide excellent fallout protection and some designs provide a moderate amount of blast protection. Thus, expedient shelters could provide protection in risk areas for persons who do not evacuate.

### **Selecting an Expedient Shelter Design and a Site**

The type of shelter which will be most valuable for your situation will depend on these considerations:

- o Are you or the people in your family able to do concentrated heavy labor for up to a day?
- Are raw materials such as logs, doors, lumber, concrete blocks, sand, plastic or cloth sheets and rope or twine available? (If doors are to be used, they should be brought with you.)
- Do you have sufficient tools such as a chain saw or two-man saw, axes, picks, and shovels?
- o Is the soil clear of tree roots or other obstacles to a depth of 6 feet?

- Is the soil frozen or too wet to dig trenches?
- Is the soil in your area stable enough to dig 6 foot deep trenches?

### **Soil Stability Test**

To test the stability of the soil at your shelter site, follow these steps:

1. Select a level site.
2. Dig a small hole 8" wide and 10" deep.
3. Remove all loose earth from the bottom.
4. Push the point of your thumb into the soil at the bottom of the hole.
5. Results: If you cannot push your thumb deeper than 1", the soil is suitable for a below-ground shelter.  
If your thumb penetrates deeper than 1", select and test another site or build an above-ground shelter.



If you are not physically able or do not have sufficient tools, you should seek help before attempting to construct an expedient shelter. If your soil is frozen or not stable enough to pass the soil stability test, do not attempt to construct any of the underground shelters.

Whenever possible use the natural features of the land to help provide protection. For example, try to build your shelter against a hillside or rock outcropping. Look at the following chart and carefully consider which is the most appropriate for your area and your personal resources.

## **Expedient Shelter Decision Chart**

**Below-Ground Shelters.** Below ground shelters provide good fallout protection in fewer time with less building materials than above-ground types. However, soil must be stable and easy to dig.

### **— Door-Covered Trench Shelter**

**Conditions:**

Shortage of small trees and building materials

**Effort:**

3 persons, 10 hours each

**Materials:**

3 solid doors (32" minimum width) or 6 hollow core doors

Plastic sheeting

Bedsheets or cloth

Sandbags, sacks, or pillowcases

String or cord

Boards or sticks

Earth

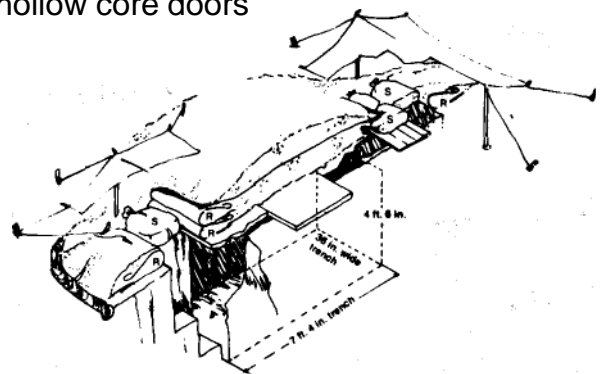

— Log-Covered Trench Shelter

Conditions:

- Large supply of small trees
- Very stable soil

Effort:

- 4 persons, 12 hours each

Materials:

- Plastic sheeting
- Strong cord
- 15 lbs. of newspaper
- Sandbags, sacks or pillowcases
- 55 logs cut to 5 ft. and 7 ft. lengths

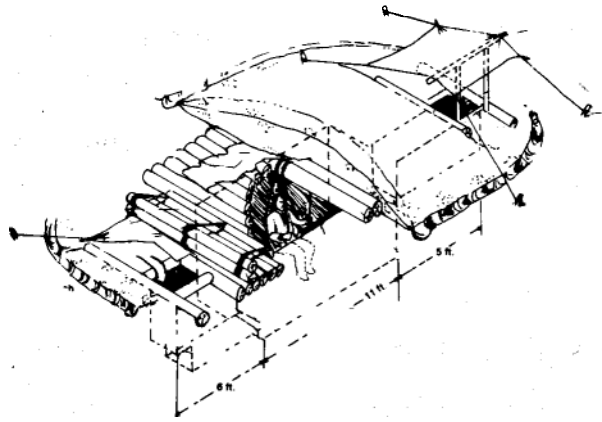

— Tilt Up Doors and Earth Shelter

Conditions:

- Solid masonry wall (outside wall of house or building)
- Level or gently sloping land
- Solid soil

Effort:

- 3 persons, 6 hours each

Materials:

- 7 doors
- Plastic sheeting
- Sandbags, sacks, or pillowcases
- Nails, rope or cord
- Lumber or extra sandbags

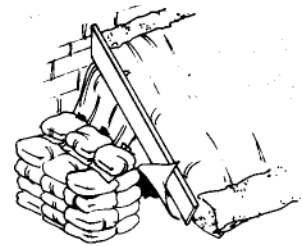

Above-Ground Shelter: Use the following design when soil is wet, rocky, or otherwise unsuitable for below-ground shelters. It requires large amounts of earth to cover the shelter and provide fallout shielding.

— Above-Ground Door-Covered Shelter

Conditions:

- House or building nearby for doors and lumber

Effort:

- 4 persons, 10 hours each

Materials:

- 5 doors (32" or more width)
- 16 bedsheets
- Sandbags, sacks, or pillowcases
- Earth (large amounts)
- Lumber for framing

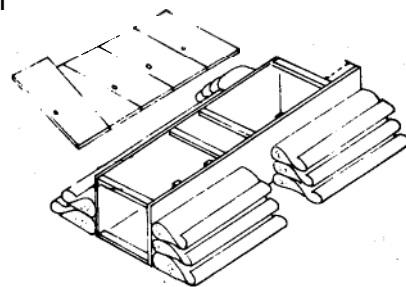

See the appendix for illustrations and instructions for building these shelters.

## Basic Requirements for a Fallout Shelter

Every fallout shelter, regardless of the type, must be able to provide protection from radiation. The shelter must be a self-contained environment that can support life, as well as provide adequate radiation protection, for at least two weeks.

The basic requirements for a fallout shelter are listed below:

1. Shielding
2. Ventilation
3. Water and food supplies
4. Sanitation
5. First aid and medical care
6. Radio monitoring
7. Space allocation
8. Physical comforts

### Shielding and Shielding Materials

All fallout shelters need to have an adequate amount of shielding in order to protect people inside the shelter from harmful radiation produced by fallout. Gamma radiation, which is the most prevalent type of radiation released from a nuclear blast, can be blocked by a thick layer of many different types of dense material. The most common materials which might be used as possible shielding materials are concrete and earth, but many other suitable materials are commonly available. The following list shows some of these materials, and the amount needed to equal the radiation protection of 4 inches of concrete:

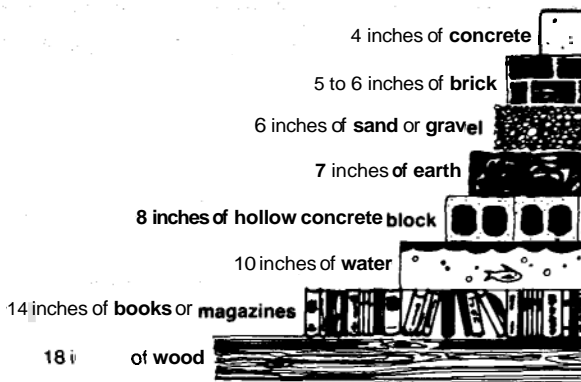
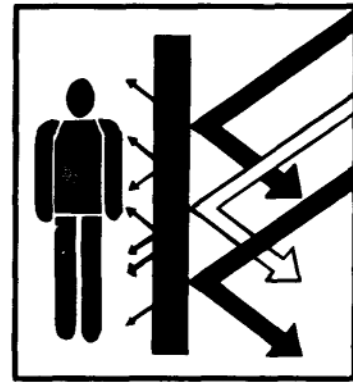

Any of these materials can be used effectively to increase the radiation shielding of a fallout shelter. At a minimum you should have several inches of concrete or 1 to 2 feet of earth as shielding.

Many existing fallout shelters will need their protective ability increased. The simplest method of improving these shelters is to move large quantities of earth around the walls of the shelter as well as on the roof or floor immediately above the shelter space. This method of increasing radiation protection can be used to improve any type of shelter and make it safer from harmful radiation. The more shielding around you, the safer you are from radiation hazards.

It is important to remember that in most cases, adding shielding material to the walls and roof of any type of building will require extra support. Ceiling beams and walls may need to be braced to support the weight of heavy shielding materials. Lumber, logs, or doors removed from their frames can be used for support provided they reach from the floor to the ceiling.

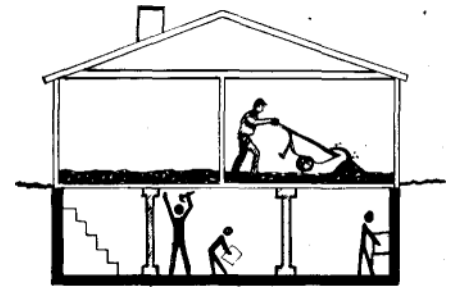

**Radiological monitoring equipment** is desirable in shelters to help you measure radiation exposure. If instruments are available, plan to monitor radiation levels in the shelter periodically, most frequently during periods of heavy fallout. Although you place shielding between yourself and fallout, some radiation will still get into your shelter. Radiation levels should be monitored to find the best protected space in your shelter and to identify radiation leaks where additional shielding is needed.

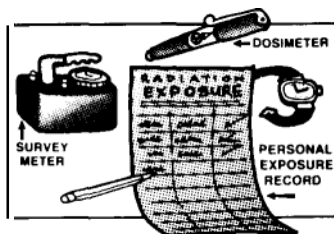

Many public shelters will be equipped with survey meters, dosimeters, or other devices which measure radiation. Persons trained to monitor radiation can locate dangerous areas in the shelter and move the shelter occupants to safer areas. Ideally, a shelter should have one or more survey meters to measure radiation levels and one dosimeter for every 10 persons to measure accumulated doses.

Occupants of expedient, home shelters, and many upgraded public shelters will be responsible for their own radiation monitoring. Unfortunately, inexpensive radiological instruments of the type that would be useful are not readily available to the public. However, persons interested in purchasing instruments should write to FEMA to obtain information on instrument criteria and a current list of potential suppliers (FEMA, SL-EM-SS, 500 C Street, Washington, DC, 20472).

If no radiation detection instruments are available in your shelter, use this manual as guidance to find areas in the shelter that have the best protection from radiation. Listen to your radio for information about outside radiation levels and keep a written log of daily levels for reference.

### Ventilation

Ventilation to circulate fresh air and keep the temperature safe is critical to the well-being of shelter occupants. Without adequate ventilation, the shelter space may become dangerously hot in a few hours, especially during warm weather. After a few days without fresh air exchange, the air could contain a dangerously high proportion of carbon dioxide.

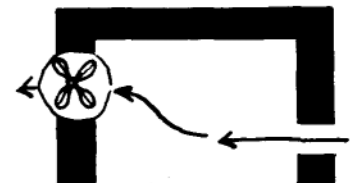



Most buildings have enough natural ventilation to keep fresh air moving and the temperatures from rising. Natural ventilation is the circulation of air through wall cracks, around doors and windows, or in unsealed basements. Natural ventilation occurs because of wind force and also because warm air tends to rise.

If a few windows *outside the shelter area* are opened, natural ventilation should be adequate in above-ground shelters. In basements, ventilation can be improved if cooler fresh air is allowed to flow in through a stairway or window at one end while warm air goes out through an opening at the other end.

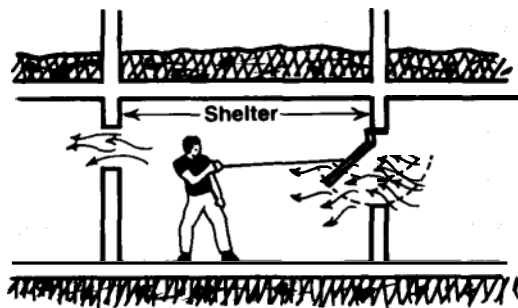

Expedient Air Pump

If you have no mechanical ventilation, take advantage of natural ventilation by creating a *chimney effect*. Open inside doors from the shelter area to create an air passageway to the stairwells. Then open both outside and inside doors on the uppermost floor of the building. You may need to open an outside door or window on the lower floor of the building, but out of the shelter area, to get enough natural ventilation to replace the hot shelter air with fresh air. **Do** not open outside doors or windows in the shelter area itself.

If natural ventilation cannot adequately keep air moving in the shelter and heat is the major problem, a simple device to move the air to supplement natural ventilation may be all that is needed. If you are preparing a home shelter or helping to prepare a public shelter and no ventilation kits are available, you can build an expedient air pump with inexpensive materials by following plans found in the appendix of this text. **Also** included are instructions for building a simple fan to move air.

Other ventilation devices can be rigged from existing air-conditioning and heating ducts. Blowers can be powered by gasoline-powered generators, an improvised bicycle-powered system, or a hand-operated air pump or fan.

In below-ground areas, ventilation is more difficult and therefore more critical. Use mechanical ventilation such as air conditioning or furnace fans if these are operating. You may need to supplement them with portable fans.

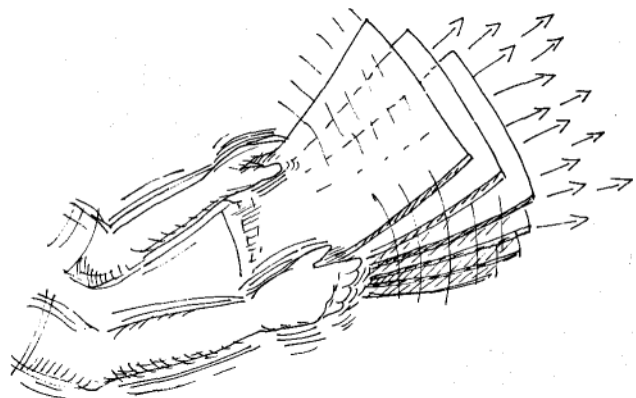
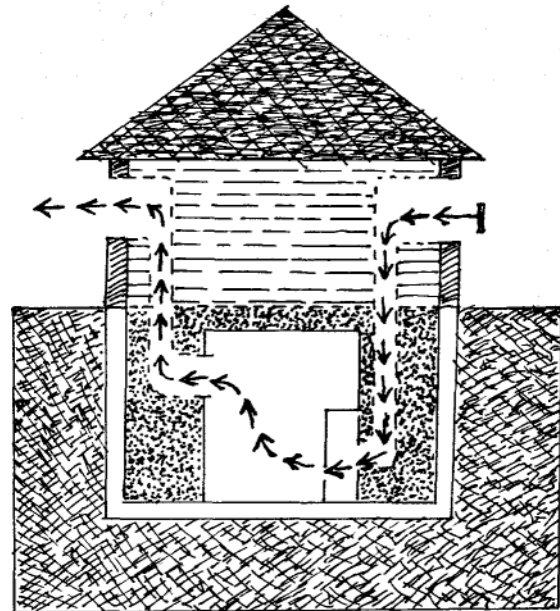

## Water Supplies

The next most critical shelter requirement is an adequate water supply. Shelter occupants should bring their own water, but you still may not have an adequate supply for everyone. You also will need water for non-drinking purposes such as sanitation.

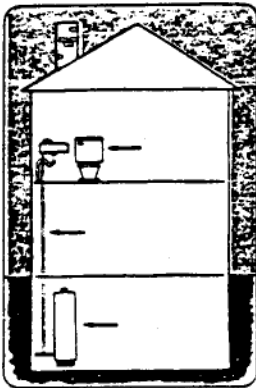

Water can be obtained from the plumbing of most buildings where fallout shelters are located. First, close the main water valves so that water in the pipes will not be lost. Then, turn on the faucet at the highest point in the building to allow air into the pipes. Then draw water from the faucet that is located at the lowest point in the building. Water also can be drawn from the flush tanks of toilets and from water heater tanks.

Standing water may need to be purified before it can be used for drinking. Some types of household chlorine bleach, tincture of iodine, water purification tablets, or boiling will remove bacteria and make water safe for drinking. If you suspect contamination from chemicals, use the water for nondrinking purposes only. More details about protecting and purifying water are listed later in this chapter.

## Sanitation and Health

An important component of any shelter is adequate sanitation. Because standard methods of disposing of garbage and human wastes may not be available in the fallout shelter, careful planning for regular disposal should be made before the shelter is occupied. All shelters should have emergency toilet facilities even if existing toilets work after the attack. You should not waste your water supply to flush existing toilets.

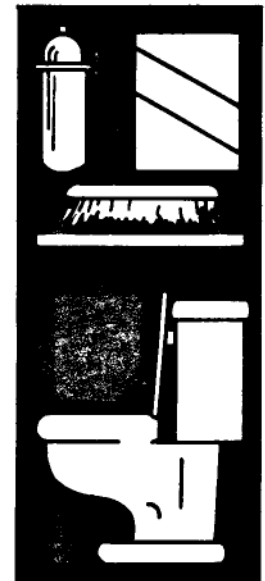

Expedient shelters and many public and home shelters will require emergency toilets. You should provide a private space in the shelter for the toilet. You will also need adequate space for storing human waste and garbage until it is safe to go outside the shelter. If a sanitation kit is not available in your shelter, you can make an emergency toilet by following the steps listed below.

1. Line a large can, pail, or other container with a large heavy-duty plastic bag.
2. Make a seat out of boards, an old toilet seat, or a chair with a hole cut in the seat.
3. Place the container in a remote corner of the shelter. Provide a curtain or makeshift screen for privacy.
4. Stock containers of disinfectant (chlorine bleach, Lysol, etc.) to pour into the container after each use to fight germs and odors.
5. Cover the container tightly when not in use.

### Space Allocation

Most shelters will be crowded, **so** you will need to plan for maximum use of space. Ten square feet of space should be allowed for each person in the shelter. However, additional space will be needed for sanitation, food and water storage, food preparation, and storage of personal belongings and equipment.

A 12 foot x 12 foot space contains **144** square feet. If 100 square feet are needed for living space, **44** square feet remain for sanitation and storage. You can also use other areas within the building but outside the shelter area for storage, especially of waste materials.

Plan an entryway into the shelter area that you can close with a door, panel, or curtain. If possible, you will want an area for decontamination if shelter occupants must leave the shelter on short missions after fallout arrives. A decontamination area is a covered place outside of the main shelter where you can remove and store outer garments and brush off any fallout to prevent bringing it inside the shelter.

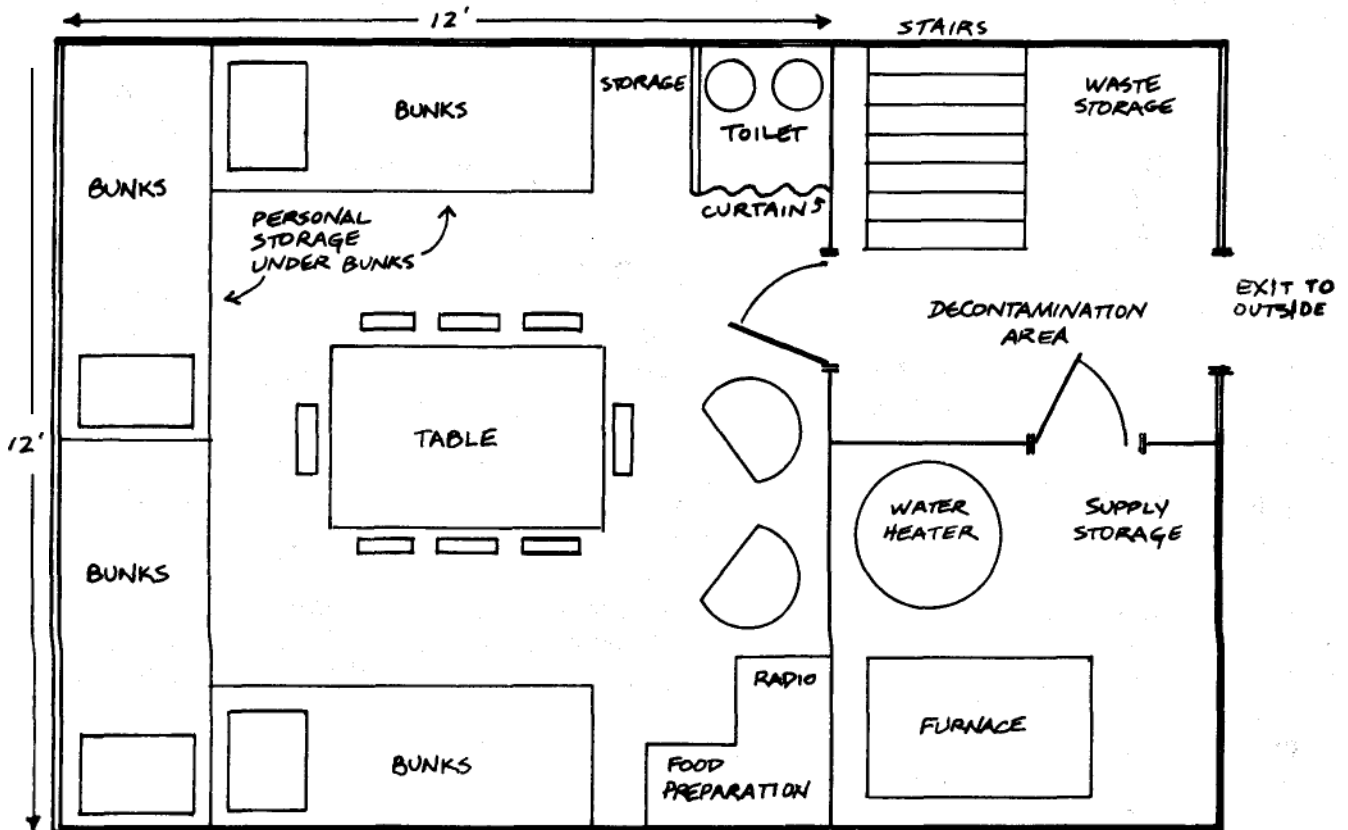

## Physical Comforts

Life in the shelter will be safer, easier, and less **frightening** if you plan and build in some physical comforts. Designate areas for sleeping that are separate from the rest of the living area. Try to arrange the shelter so that you have designated areas for each of your shelter tasks: food preparation, eating, communications, and sanitation. Make certain that you provide enough lighting for all activities.

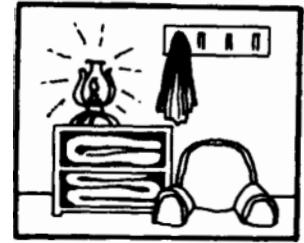

**Furniture.** Shelter occupants will need designated places to sleep, eat, or rest when they are not performing shelter duties. Build sleeping bunks to increase the amount of space for other shelter activities. Use the space under the bunks for storage. Provide or build a table for eating and for group activities. Build or bring folding chairs or provide boxes for people to sit on if space is very limited.

**Lighting.** Lights will be very important for psychological comfort. Since you may be without electricity for some time, you should plan to use emergency lighting. Camping lanterns, kerosene lamps, and battery-operated lamps will be very useful. These lamps can be hung in strategic locations in the shelter to provide light for shelter activities. Hanging the lamps is a safety measure as well to help prevent lamps from being knocked over.

Be sure to provide adequate ventilation when you are using candles, kerosene, or oil lamps. You need to move the air both to disperse any smoke or fumes and to replenish the oxygen used by the flame.



Candles and home-made oil lamps can also provide adequate light. Candle lanterns can be made with a candle, a glass jar, and light wire to hang the lantern. You can make an emergency oil lamp with household cooking oil, a glass jar, cotton string, light-weight wire, and two nails. See the Appendix for instructions.

## Fire Prevention and Protection

Fire will be an ever-present danger in a shelter. Immediately after an attack, wide areas will be in danger of fires created by the heat flash. Within the shelter, candles, kerosene lamps, or cooking stoves also will be a continuous fire hazard. Fire fighting materials should be stocked as the shelter is being built.

When you prepare your shelter, place sand or earth in containers or in a pile somewhere in the shelter or building. Reserve non-drinkable water for putting **out** fires.

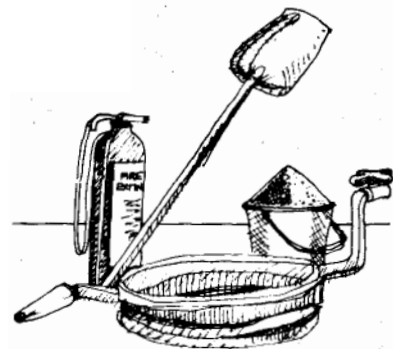

If your shelter is in or near a target area, follow these steps to fire-protect the building in which your fallout shelter is located:



1. Cover windows or upper floors with white-wash, aluminum foil, or blinds to deflect the heat flash.
2. Remove flammable objects such as draperies, carpeting, or materials stored in attic.
3. Remove trash, papers, paints, and paint thinners.
4. Turn off any gas supply at the main shutoff valve.

### Stocking a Fallout Shelter

Life in the shelter, regardless of the type and design, will be difficult for all of the occupants. An adequately stocked shelter will be very important to your well-being. Your shelter should be as self-contained as possible so that no one is forced to go outside and be needlessly exposed to radiation; therefore, shelters should be stocked as much as possible before you are required to enter them.

Aside from the absolute essentials—water, ventilation, and food—there are other items needed to make a shelter habitable. You will need supplies for sleeping, general health and comfort, communications, and recreation. Since your group may be isolated for days because of radiation, the better supplied you are to meet all human needs during that time, the better off you will be.

This section tells you what supplies and equipment to take if you go to a public shelter and what items to keep on hand if you plan to use a home fallout shelter.



### Checklist for Meeting Human Needs in a Shelter

Be prepared to bring a personal supply of water, food, medication, clothing, and bedding to a shelter. You **cannot** expect to have any of these items supplied even in public shelters. In addition, other supplies can make shelter life easier and more tolerable. The following checklist contains general supplies that are recommended for stocking a fallout shelter.

Each of the items on the checklist is discussed in this section. If your space is limited, you will have to decide what is most important for you to take.

## GENERAL CHECKLIST FOR FALLOUT SHELTER

### 1. WATER, FOOD, AND UTENSILS

- Two week supply per person of nonperishable food requiring little or no cooking
- Eating and drinking utensils
- Special dietary foods
- Camping stove and fuel
- Two-week supply per person of drinking water (3.5 gallons)
- Thermos jug or plastic bottles
- Bottle and can openers
- Plastic drop cloths
- Compact camping cook kit

### 2. MEDICINES

- Prescription and nonprescription medicines (insulin, heart tablets, aspirin, etc.)
- Dramamine tablets
- First aid kit and handbook
- Personal aids (eyeglasses, hearing aids, etc.)
- Emergency medical alert tags
- Baking soda

### 3. CLOTHING AND BEDDING

- Sturdy work-clothes and footwear appropriate for weather in host area
- Work gloves
- Extra underclothing
- Extra shoes
- Baby clothes
- Outerwear (coats, jackets, rain-gear, etc.)
- Extra socks or stockings
- Pillows
- Sleeping bags and/or blankets

### 4. PERSONAL HYGIENE AND SANITATION

- Hair care items
- Soap, toothbrush, toothpaste, deodorant, etc.
- Plastic bags (large, medium, small)
- Emergency toilet
- Clean, dry newspapers
- Water purifying tablets and/or tincture of iodine
- Insecticide
- Shaving kit
- Sanitary napkins
- Paper towels, towelettes, toilet paper
- Detergent
- Garbage cans with lids
- Household chlorine bleach with hypochlorite as only active ingredient
- Disinfectant (Lysol, etc.)

## 5. BABY SUPPLIES

- Diapers
- Milk or formula
- Baby powder, creams or ointments
- Bottles and nipples
- Baby food
- Sheets, blankets, rubber pads
- Portable crib

## 6. TOOLS AND EQUIPMENT

- Pick ax
- Shovel
- Saw
- Hammer
- Mattock
- Axe
- Nails and screws
- Screw driver
- Buckets or pails
- Rope
- Wire (heavy, medium, and light weights)
- Fire extinguishers
- Crow bar
- Wrench
- Pliers and wirecutters

## 7. IMPORTANT PAPERS AND VALUABLES

- Social security card
- Birth certificates
- Driver's license
- Money, credit cards
- Wills
- Insurance policies
- Deeds
- Stocks and bonds
- Savings and checking account books
- Small valuables (cameras, watches, jewelry)

## 8. PERSONAL ITEMS

- Playing cards and small games
- Sewing kit
- Writing materials
- Small toys for children
- Reading materials

## 9. SURVIVAL LIBRARY

- Expedient shelter plans
- Self-help medical book
- This book and other civil defense manuals
- Book on general survival skills

## 10. COMMUNICATIONS AND LIGHTING

- \_\_\_\_\_ Battery-operated radio receiver and batteries
- \_\_\_\_\_ Lantern and fuel

- \_\_\_\_\_ Flashlights and batteries
- \_\_\_\_\_ Candles and matches
- \_\_\_\_\_ Citizens band radio and batteries

### Water

Next to good air, water is the most essential requirement to life. A healthy person can survive for a long time with little or no food, but most will die after 4 or 5 days without water.

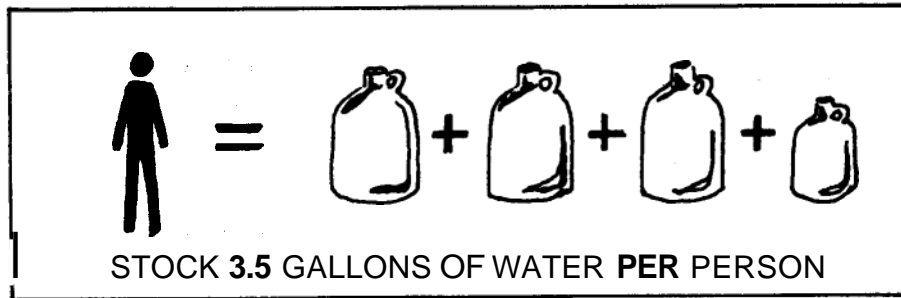

The average person drinks from 1-2 quarts of water per day. For a two week stay in a fallout shelter, you should try to stock at least 3.5 gallons of water per person.

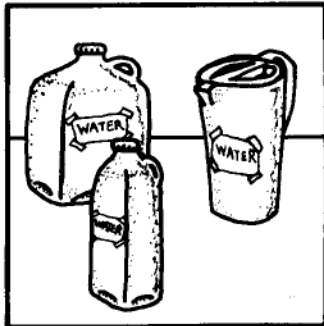

You may or may not be able to carry a sufficient personal water supply to the shelter that you use. For your own health and well-being, you should provide your own water if possible. Not all shelters will have sufficient water supplies.

Your water should be carried in closed containers. Plastic milk or juice bottles that have been cleaned carefully are good water carriers. Heavy plastic bags or clean metal containers are also good to use. Glass containers may be used if necessary, but breakage would mean the loss of your water.



Remember that the 3.5 gallons per person is for drinking water only. You will need additional water for sanitation, cooking, and washing.



- Plan to keep your drinking water as clean and pure as possible.
- Do not use it for nondrinking purposes.
- Even if you have a limited supply, drink according to need. Do not ration your drinking water. Use emergency sources in the pipes of the building for additional water. In a few days radiation levels should go down enough to permit you to get more water.
- To control bacteria growth, use water purification tablets, a few drops of chlorine household bleach, a few drops of tincture of iodine, or boil for at least 3-5 minutes. Methods for purifying and decontaminating water are described in Chapter 5.

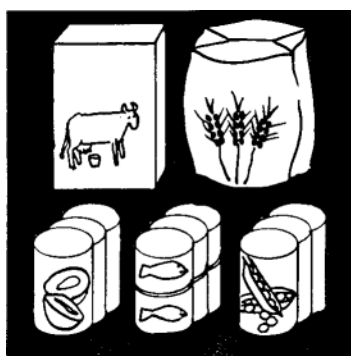

### Shelter Food Supplies





Food may present particular problems in a shelter. You need food for health and morale. You may be severely restricted by the supplies you have on hand and the conditions inside a shelter. Whether you are in a public, home, or expedient shelter, you will probably have to plan your meals and ration your food carefully.

You should take all the nonperishable food that you can carry to the shelter. This supply may be added to the food inventory if you go to a public shelter, but it may be needed as your personal supply in an expedient shelter.

Unless you do a lot of wilderness camping, you may not know what kinds of food are best to stock in a shelter. Local authorities should advise you through your news media on the amount and kinds of food to take with you before you evacuate. In general, you should try to have foods which are:

- Nonperishable (canned or dried)
- Nourishing (from each of the basic food groups)
- Easily prepared and served
- Can be eaten as is, in case no water is available for heating or cooking
- Completely edible in small servings with little or no waste or leftovers

You should take food in each of the following food groups and amounts.

			Per Person	
			(Pack) 2 Week Supply	(Use) Daily Amount
	<b>Milk Group</b>	Evaporated Milk Condensed Milk Dried, Powdered Milk Hard Cheeses	4 cans 2 pkgs.	2 tbsp. 1/3 cup
	<b>Meat or Meat Substitutes</b>	Canned meats, poultry, fish Canned meat with vegetables, rice, or beans Canned beans Condensed soups with meat, poultry, fish, or beans Peanut Butter Dried beans or grains	8 (1 lb. and 1/2 lb.) cans  14 single serving cans 4 jars 1 lb.	1 cup  1 Cup 4 tbsp. 1/2 cup
	<b>Fruit and Vegetable Group</b>	Canned Fruits Canned Vegetables Canned Juices Dried Fruits	5 cans 5 cans 5 cans 2 (1 lb.) pkgs.	1/2 cup 1/2 cup 1/2 cup 2-3 pieces <sup>s</sup>
	<b>Cereal/Bread</b>	Ready-to-eat cereal Crackers Cookies Canned bread, macaroni, spaghetti, noodles, and rice Dried cereal grains	14 single servings 2 pkgs. 2 pkg.  8 cans 1 lb.	1 serving 4 oz.   1 cup 1/2 - 1 cup <sup>μP</sup>
	<b>Miscellaneous</b>	Instant Coffee or Chocolate Tea bags Powdered soft drink mix Margarine Sugar Iodized salt Candy High potency vitamins	2 jars 24 bags 2 pkgs.  1/4 lb. 1/4 lb. 1 lb. box or jar 1 bottle	1 cup 4 oz. 1 cup  2 tsp. 2 tsp. 1 oz. 1 capsule <sup>e</sup>



## Food Requirements

Food requirements will vary by age group and activity level. The amounts listed in the table above are average requirements for an adult. Use the following guidelines to determine the food requirements for your family or group.

- Children need less food.
- The elderly need less food than average adults.
- Teenagers, especially boys, need more food than adults.
- Pregnant or nursing women need more food.

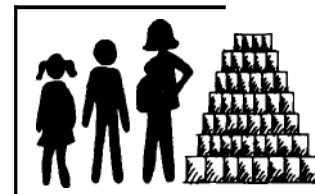

**Babies and Infants.** Babies and infants need specially prepared foods, vitamins, and milk. Mother's milk is best as long as the mother is on an adequate diet. If you have a baby, take a large supply of baby food, vitamins, and all necessary feeding equipment to the shelter.

**Restricted Diets.** If you or anyone in your family is on a restricted diet and requires special foods, you should take at least a 3 week supply with you. People on restricted diets will not be able to share common food supplies. They must be responsible for providing themselves sufficient amounts to survive two or three weeks in the shelter.

## Plan Your Food Requirements

- Make a list of food items in each of the food groups. Select **foods** that you like and usually keep around the house.
- Determine how much food you will need for at least a 2-3 week period.
- If you have a family, you will need to determine how much food the whole family must have.
- Remember to include baby foods and special dietary foods if necessary.

## Utensils and Cooking Equipment

Each person should have a personal set of non-breakable eating and drinking utensils. These should be kept as clean as possible. In your shelter, sanitation and control of disease could be a problem. Since we are each accustomed to our own germs, we can continue to eat and drink safely from our own utensils just as we use a toothbrush over and over. Paper plates and cups, although sanitary, will only add to your waste disposal problem.

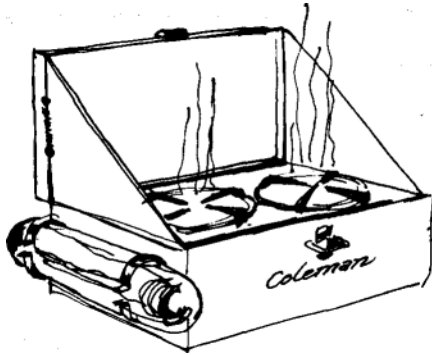
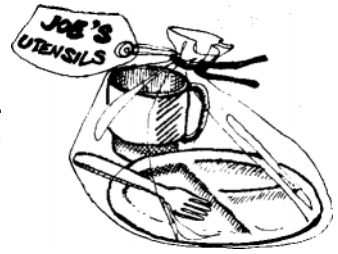

Cooking equipment requires space and should be kept to a minimum. Think small when packing this equipment. Camp stoves and cooking kits are best because they are compact. Remember to take fuel for your stove. If you do not have a camp stove, you can learn to make an expedient one such as the bucket-stove described in the Appendix.

### *Plan Your Cooking Equipment Requirements*

- Collect air-tight containers and plastic bags for food storage.
- Collect a set of nonbreakable dishes (1 plate, 1 bowl, and 1 cup) and eating utensils (fork, knife, and spoon), for the personal use of each person in your group.
- If you have a camping stove, fuel, and compact cooking equipment, plan to take them. If you do not own camping equipment, you do not necessarily need to buy it. In the Appendix, you will find directions for making an expedient cook stove out of a metal bucket.

## First Aid and Emergency Medical Needs

After an attack you may have to treat injuries yourself. A nuclear attack on the United States will cause many injuries and destroy many of our hospitals. Doctors will be scarce and remaining medical facilities will be crowded with injured persons. Makeshift facilities will certainly be developed for treating the injured, but people may not be able to reach these facilities if fallout is heavy.

Some public shelters may have first aid supplies, but most probably will not. In a large shelter, a doctor or nurse may be one of the shelter occupants. Persons in expedient or home shelters will have to rely on their own medical supplies and their own first aid skills.

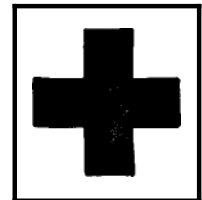

## Contents of a Home First Aid Kit

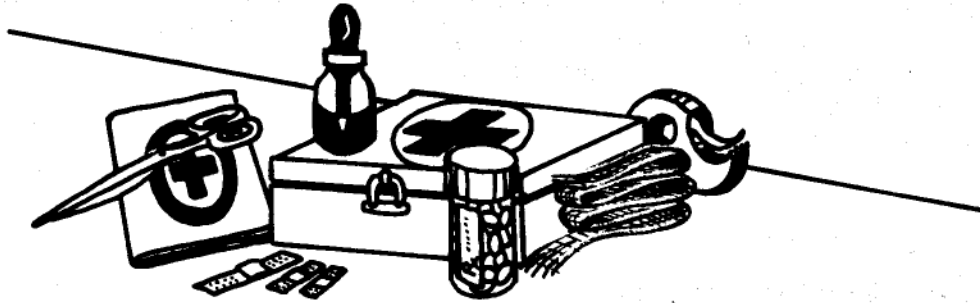

- |  |                                    |
|--|------------------------------------|
| _____ Adhesive tape, roll 2" wide                    | _____ Non-prescription medicines   |
| _____ Applicators, sterile, cotton tips              | _____ Nose drops (water soluble)   |
| _____ Antacid (or baking soda)                       | _____ Petroleum jelly              |
| _____ Antibiotic ointment                            | _____ Plastic bags with fasteners  |
| _____ Antiseptic solution                            | _____ Prescription medicines       |
| _____ Aspirin or aspirin substitute                  | _____ Rubbing alcohol              |
| _____ Bandage, sterile roll, 2" wide                 | _____ Safety pins, assorted sizes  |
| _____ Bandage, sterile roll, 4" wide                 | _____ Sanitary napkins             |
| _____ Bandages, large triangular,<br>37" x 37" x 52" | _____ Scissors                     |
| _____ Bandages, plastic strips,<br>assorted sizes    | _____ Smelling salts               |
| _____ Diarrhea medication                            | _____ Soap                         |
| _____ Ear drops                                      | _____ Splints, wooden, 18" long    |
| _____ First-aid handbook                             | _____ Table salt                   |
| _____ Laxative                                       | _____ Toothache remedy             |
| _____ Motion sickness tablets<br>(for nausea)        | _____ Thermometer                  |
| _____ Needle   | _____ Tweezers                     |
|  | _____ Water purification materials |

### ***Plan Your First Aid Items***

- Assemble a first aid kit in a water-proof metal or plastic box.
- Keep aspirin and other medications tightly capped. Any medications with an expiration date listed on the label should be replaced at that date.

## Tools and Equipment

Bring as many tools as you can to use for building expedient shelters or upgrading public shelters. Tools needed for this work will be scarce. Since you will be working to provide for your own protection and comfort, you will want adequate tools for the job.

Fire may present a serious danger if your shelter is in or near a target area, especially in the first few hours following a nuclear attack. Every shelter should be equipped with fire fighting tools. Since you are largely responsible for your own protection, you will want to bring your own equipment for fire protection.

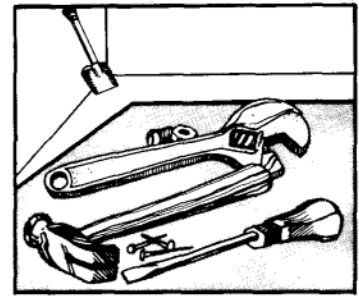

## Important Papers and Valuables

Take all papers that identify who you are and the property that you own. You can bring small valuables such as cameras, watches, or jewelry. These should be placed inside a metal box with a lock. The box should be wrapped in plastic to protect it from moisture. Since you will be responsible for the safety of your own valuables, you will want to limit yourself to small, compact items.



## Survival Books

A library of survival books is an important part of the items that you should have in a crisis. Few Americans know how to live off the land as our ancestors did or have the outdoor survival skills that may be needed in a nuclear attack crisis. With several good reference books, you can find help or the solution to most of the problems that you will face until you can get outside help.

## Recommended Literature to *Pack*

- Expedient shelter designs

Plans for expedient shelters are located in the appendix. Plans for home shelters can be obtained through your local civil defense or emergency management office, or by writing to FEMA, P.O. Box 8181, Washington, DC, 20024.



- First Aid manual

The American Red Cross publishes a widely used manual. **Also**, some civil defense booklets and military manuals give useful first aid instructions.



- **Nuclear War Survival Skills** (Kearny)

This book is a comprehensive guide to nuclear attack survival and contains many useful plans including directions for building the Kearny Air Pump and the Kearny Fallout Meter. The book is available through bookstores or by ordering from the National Technical Information Service (NTIS), 5285 Port Royal Rd., Springfield, Virginia, 22161.



- **The Book of Survival** (Greenbank)

Published by Harper and Row, New York, this book is designed to help the average person survive in different types of situations.



- **Where There is No Doctor** (Werner)

Published in 1977 by the Hesperian Foundation, Palo Alto, California, this self-help medical guide gives advice about what to do for serious injuries and sicknesses if no doctors or effective medicines are available.

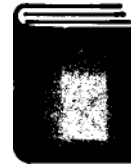

Some of these books and pamphlets may go out of print or be difficult to find. You may be able to find many other useful books and pamphlets to include. The point to remember is that literature is available that can help you survive. Collect as many as you can before a crisis develops. Clip out and save useful survival information that you find in newspapers and magazines. If you wait until a crisis develops, you may not be able to find the books, pamphlets, or other printed information that you need.

### Sanitation

Sanitation must be planned before you go to the shelter. If your shelter does not have a sanitation kit, you will need supplies to build an expedient toilet and to provide waste storage until you can safely go outside. In addition to personal supplies such as toothbrushes, soap, and shaving kits, you will need to bring several other sanitation items. Following is a detailed list of recommended sanitation supplies:

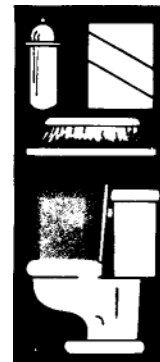

- \_\_\_\_\_ 2 or more large garbage cans with lids
- \_\_\_\_\_ 2 or more small garbage cans with lids
- \_\_\_\_\_ 24 large heavy-weight plastic bags with fasteners
- \_\_\_\_\_ 2 dozen small plastic bags with fasteners
- \_\_\_\_\_ disinfectant
- \_\_\_\_\_ deodorizer
- \_\_\_\_\_ toilet tissue
- \_\_\_\_\_ sanitary napkins
- \_\_\_\_\_ plastic sheeting
- \_\_\_\_\_ waterproof gloves
- \_\_\_\_\_ scrub brush
- \_\_\_\_\_ shovel

- \_\_\_\_\_ paper towels
- \_\_\_\_\_ newspapers
- \_\_\_\_\_ detergent or cleansers
- \_\_\_\_\_ powdered garden limestone
- \_\_\_\_\_ scrub brush

- \_\_\_\_\_ insecticides
- \_\_\_\_\_ clean rags
- \_\_\_\_\_ household sponges
- \_\_\_\_\_ rubber gloves



### Supplies for Physical Comfort

Fallout shelters will probably be crowded and generally uncomfortable. You will want to try to provide as much physical comfort as possible to make the stay a little easier.

When allocating shelter space, each person should be assigned a place for sleeping and storing personal belongings. The remainder of the shelter space should then be divided into areas for sanitation, health care, food preparation and distribution, recreation, and other tasks. You will need to plan for your personal comfort before entering the fallout shelter. Bedding such as sleeping bags, blankets, pillows, camping mattresses, cots, or hammocks must be brought for every member of your family. Other furniture, such as folding stools and lightweight, folding lawn furniture, might also be useful to pack if you have enough room in your car.

Everyone will suffer to some extent from overcrowding, boredom, and anxiety. Plan to bring some reading material, knitting, games, or other hobby items to help pass time and reduce tension. Children especially will need toys and games to occupy them.





**Plan for Your Physical Comfort**

- Inventory your sleeping equipment. Make a list of sleeping bags, blankets, and pillows that you will need for yourself and each member of your family.
- List recreational items that you can take. If you have children, have them select their favorite small toys, games and books.
- List the folding chairs, tables, stools, and cots that you own. Find out how to make expedient furniture from blankets and boxes.
- List the camping lanterns, flash lights, and other emergency lighting that you own. Remember to have fuel for lanterns and fresh batteries for flash lights. Keep matches in a waterproof container.

This chapter has been about preparing fallout shelters. In the next chapter you **will** learn about living in shelters.

1. List the sleeping equipment that you own. Make a list of sleeping bags, blankets, and pillows that you will need for yourself and each member of your family.

2. List recreational items that you can take. If you have children, have them select their favorite small toys, games and books.

3. List the folding chairs, tables, stools, and cots that you own. Find out how to make expedient furniture from blankets and boxes.

4. List the camping lanterns, flash lights, and other emergency lighting that you own. Remember to have fuel for lanterns and fresh batteries for flash lights. Keep matches in a waterproof container.

5. List the camping lanterns, flash lights, and other emergency lighting that you own. Remember to have fuel for lanterns and fresh batteries for flash lights. Keep matches in a waterproof container.

6. List the camping lanterns, flash lights, and other emergency lighting that you own. Remember to have fuel for lanterns and fresh batteries for flash lights. Keep matches in a waterproof container.

This Page  
Intentionally Left  
Blank in the  
Original  
Document

[Http://www.survivalring.org](http://www.survivalring.org)

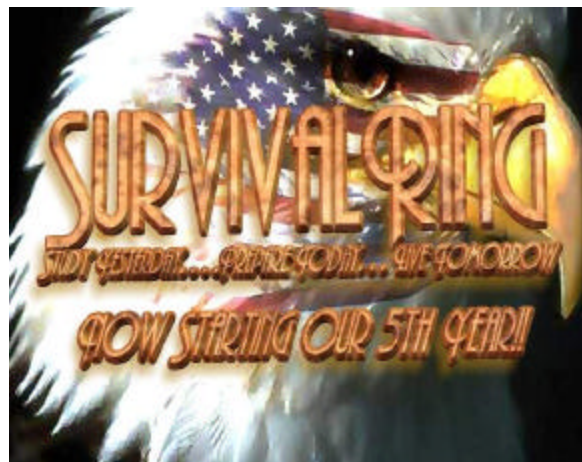

## CHAPTER 5 PREPARING FOR SHELTER LIVING

You already know that to survive a nuclear attack, you must avoid the heat flash and blast and shield yourself from radiation. Getting safely to a fallout shelter is only the first phase of survival. Survival also involves knowing how to live in a shelter for two or more weeks, how to meet basic needs, and how to cope with the problems that are likely to develop.

This chapter covers three important topics for shelter living and shelter survival. They are:

### 1. Entering the Shelter



### 2. Managing Shelter Operations and Activities



### 3. Health Management



The first section describes the activities that should take place when you first enter a fallout shelter, both in a target area and in a fallout area. The second section discusses the routine tasks that need to be performed for the safety and general well-being of all occupants from the time you enter the shelter until you emerge permanently. The third discusses physical and mental health problems that may occur and gives guidelines for treating victims.

### How Long Would You Have to Stay in a Shelter?

No one can accurately predict how long you may need to stay in a fallout shelter after an attack. We recommend that you be prepared for two weeks in a shelter, but your stay could be shorter or longer. Certainly, the first few days are the most critical and will be the most restrictive for you because of dangerous radiation from fallout.

The radiation hazard will decrease over time because of radioactive decay, and your freedom to move about safely inside and outside the shelter will increase. When outside radiation levels are very high, you and other shelter occupants should stay in the most protected area of the shelter. As the outside radiation level decreases, you will be able to move around your shelter freely. As levels drop more, you will be able to take short trips outside to perform critical tasks. Gradually, you will be able to take longer outside trips and, after a week or two, you may be using the shelter only for sleeping.

When radiation levels become low enough to permit extended outside activity, you will be able to leave the shelter permanently. Local officials will monitor radiation levels and announce by radio when you can leave.

During the period when you can leave the shelter temporarily but before you can emerge permanently, you will be seeking food, water, other supplies, and information. You will be able to dispose of waste materials, bury the dead, and begin to plan for the future. You will also be able to learn about the extent of damage to the nation and government plans for returning citizens to their homes and reconstruction. Each of these activities and topics is discussed in this chapter.

## Entering Fallout Shelters

Local officials should advise you when to enter the fallout shelters. A warning signal may sound, a radio announcement will be made, or teams may be sent around to alert people.

Your immediate actions upon entering a shelter will depend on the following factors:

- if an attack warning has been issued
  - if you are in a risk area or a reception area
  - if your shelter is below-ground or above-ground.



### Attack Warning

If an attack warning is issued, go immediately to the shelter. Attack warnings will be sounded by horns, sirens, or bells. If you are too far away from a town or community to hear them, be certain that someone in your group listens to the radio in an intense crisis period. Warnings and advisories from local officials will be broadcast over Emergency Broadcast System (EBS) stations.

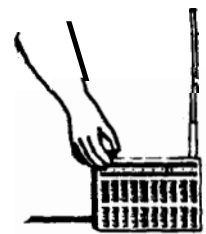

In an attack crisis, you must first protect yourself from blast and fires. This protection applies mainly to risk area shelters, but anyone entering a fallout shelter because of an attack warning should follow these steps.

### ***7. Prepare the shelter for blast and fire.***

If you have not already protected the building from heat flash, someone in your shelter group should be responsible for immediately performing at least the following tasks:

- close blinds and window curtains
- turn off the heat or air conditioning but leave the fan on
- close the main water valve to protect your water sources
- have fire-fighting and ventilation equipment at hand.

**2. Go to the most protected area.**

In a basement or below ground shelter, go to the corners and next to the walls that are most protected by earth on the outside. In above-ground shelters, go to the central core of the shelter, away from outside walls, doors, and windows.

**3. Get into a protective position.**

Lie face down on the floor and cover your head with your hands. If the shelter is crowded, sit back-to-back in rows. Bring your knees up and put your face down into your upper legs. Cover as much of your face and head as possible with your arms and hands.



After the flash, stay in the protective position. The blast wave may arrive several seconds after the flash. Keep your eyes and face covered. Do not look at the flash.

**4. Check for fires immediately.**

As soon as the blast wave has passed, you must check for fires at once. Although you must also check for injuries in your group, fire is your most immediate danger. Extinguish all fires and toss smoldering material outside the building. Continue the fire watch until you are certain that all fires in the building are out.

### Fallout Warning

If you are in a target area and you do not enter a fallout shelter before the attack, you may have only 15 to 20 minutes to reach the safety of a shelter before fallout arrives. In areas more distant from the detonation, you may have several hours to prepare before fallout arrives. Wherever you are, when fallout begins you must get into a shielded area.

*Go to the most protected area.* The best fallout protection is in the sub-basement of a multistory building. Good protection is found in the central part of a high rise building with at least two stories above you in a space away from outside windows and walls.

When locating a protected area, the safest place is as far away from the outside as you can get with the most shielding around you in the walls and the ceiling. Stay away from walls, doors, and windows that are exposed to the outside.

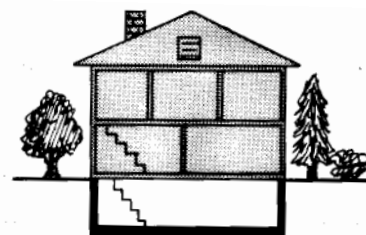
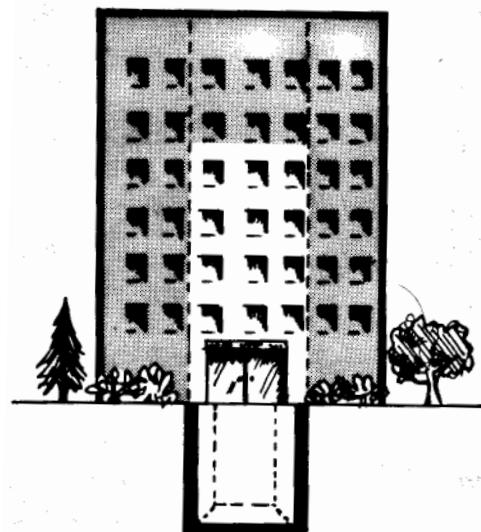

### Emergency Exit from the Shelter

Once you are in the shelter, do not leave unless the building is burning uncontrollably, or the building has collapsed leaving you exposed to radiation, or the shelter area has flooded so extensively that continued occupation is impossible. If you must leave, cover as much exposed skin as possible to protect yourself from beta burns and go as quickly as you can to another shelter. Do not expose yourself to radiation any more than is absolutely necessary.

When you get to another shelter, brush off any fallout particles that may have collected on **your** skin, hair, or clothing. Do this just outside the shelter entrance so you do not bring fallout particles into the shelter area.

## Shelter Operations and Management

Life in a fallout shelter will be difficult and problems will certainly arise. First, the reality of the crisis that brought you to the shelter will cause anxiety and concern about what is going on outside and what will happen in the near future. This fact alone may create physical and



emotional reactions that could become problems. Next, you may have few comforts in the shelter. Your water and food supplies may be limited and you may have to tolerate cold food if you lack cooking facilities. In addition, you may have injured or sick persons to care for in the shelter. Some may even die. None of these conditions will be easy, but you will be better able to cope with them if you take steps now to prepare for shelter living.

The most important point to remember is that co-operation is your key to survival. You and your shelter group should help one another in every way possible. Work, resources, and personal strength can be shared to ease the anxiety and make the shelter experience less difficult for each person.

### Establish Rules for Safety and Comfort

One of the first tasks is to establish some rules for the safety and well-being of the group. Two are of primary importance.

**Smoking should be prohibited** or at least limited to a well-ventilated smoking area. If smoking is permitted, enforce the use of fire-proof containers to extinguish smoking materials. Smoking creates a fire hazard as well as discomfort for non-smokers.

**Maintain a 24-hour watch.** Shelter occupants should take turns so that someone is available at all times to watch for fires, listen for important radio communications, and, if equipment is available, monitor radiation levels in the shelter.

### Activities Immediately After an Attack

While outside radiation levels are high, you must limit the amount of time spent outside the shelter so that you will not accumulate a dangerous dose of radiation. Children especially must be protected from radiation exposure.

- **Stay inside your shelter.**

The first three days following an attack are the most dangerous. Unless you have information to the contrary from local officials, be prudent and stay inside your shelter full time for the first three days. After two days, the radiation hazard will have decreased to less than one percent of what it was one hour after the nuclear explosion, but it could still be very dangerous. After one more day has passed, the radiation hazard will be reduced considerably.

- *Limit* cooking if necessary.

If your shelter is tightly closed, ventilation may be a problem, especially in hot weather. The heat and smoke from cooking will contribute to ventilation problems. During the first few days, when radioactivity is at its highest levels, eat canned foods or foods that do not require cooking.

- Continue to ventilate the shelter.

Ventilation is needed for two reasons: to remove carbon dioxide, and to keep the air in the shelter from getting too hot. Too much carbon dioxide in the air causes dizziness, shortness of breath, and nausea. Temperatures can rise very quickly from body heat, especially in summer. Use hand fans, battery operated fans, or anything available to move the air in the shelter. Use natural ventilation as much as possible if you can do so without exposing the shelter to radiation.

- Monitor radiation levels.

If you have dosimeters or other monitoring instruments, use them. If you do not, listen to the radio for announcements about radiation levels. Watch for early signs of radiation sickness, and keep your group in the most protected part of the shelter during the critical first few days.

- Study civil defense information.

Everyone should know what to do for survival and the survival of others.

### **Organize Members**

When you are safely situated in the shelter, the group should organize as soon as possible to perform necessary operations and tasks. If present, a trained shelter manager will assume responsibility for organizing operations groups, but in many shelters, the group will have to organize itself.

Your shelter group will need to assign responsibilities to its members. There are many tasks that need to be done. First, you need a leader who will direct the group's activities and resolve problems that may occur. Other important tasks include:

- Fire fighting and protection
- Radiation monitoring
- Radio monitoring and communications
- Sanitation management
- Water management
- Food management





Everyone in the shelter should be involved in shelter activities. In the first place, you will all need to help each other to increase your chances of survival. Furthermore, people will be less frightened if they have responsible jobs to perform.

How your shelter members organize will depend on the type of shelter, the number of persons, and the age and skills of individual members. Large public shelters will need more organization than small ones, but large shelters are more likely to have managers or instructional manuals on shelter management.

### **Establish a Shelter Routine**

As soon as possible, begin to establish a regular routine for shelter activities that can be followed for the duration of your stay in the shelter. Assign tasks to all capable shelter members. You may want to post a daily assignment sheet or change assignments every few days or weekly. Make certain that you rotate assignments of undesirable tasks periodically. **Also** rotate assignments of outside activities to avoid overexposing any member to radiation.

### **Outside Activities**

Follow local instructions concerning how much time, if any, you can be outside the shelter. If there are no local instructions, look for evidence of fallout accumulation (grit dust, or ash) outside on such things as automobiles, sidewalks, or window ledges. If fallout is very noticeable, do not go outside except for an emergency, such as replenishing water if none is available in the shelter. Otherwise, remain cautious and leave the shelter area only for short periods of time (20 to 30 minutes) to perform essential tasks such as gathering supplies, or disposing of human waste and garbage.

By the end of the second week, you should be able to gradually increase the amount of time that you can be outside until, in most cases, you can spend a larger fraction of the day outside. You should return to the shelter for sleeping. If you have no local guidelines or radiation monitoring instruments, but you have reason to believe you are in a fallout area, you should remain cautious and continue to limit outside activities.

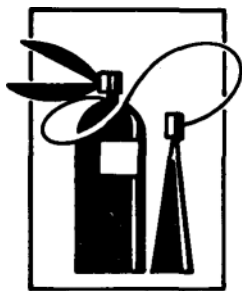

### **Fire Fighting and Fire Protection**

One of the first things to be done upon entering a fallout shelter is to locate fire-fighting aids in the shelter or elsewhere in the building. You may need to collect tools (eg., shovels, buckets, axes) from the shelter occupants if no other supplies can be found. Look for fire extinguishers, sand, or other materials that can be used to put out fires.

Organize teams to search the building immediately after a blast has passed to look for fires or smoldering materials. If you are in a home shelter, send family members through the house. Stamp out any burning materials or throw smoldering items outside.

Teach occupants the basics of fire fighting and fire safety. There are three basic ways to put out a fire:

1. Take away its fuel.
2. Take away its air (smother it).
3. Cool it with water or fire-extinguishing chemicals.

If your shelter is located in or near a target area, all shelter members should be responsible for spotting and putting out fires during the first 24 hours following an attack. After that, the task can be assigned to one or two members. These persons should be alert to fire hazards such as cooking stoves, candles, or any other sources of fire.

Any lamp that uses fuel, gas, kerosene, or candles poses a fire hazard. Be careful that you store your fuel away from fire sources. Place lamps where they will be out of the reach of children and not easily knocked over. Handle oil and kerosene lamps with care to avoid spilling fuel.

### Radiation Monitoring

Radiation levels inside the shelter should be monitored. You will need radiation survey meters and dosimeters. If you have equipment make certain that you also have the instructions. If members of your shelter are not trained to read these devices, you can follow the instructions included with the instrument sets. If your shelter does not have monitoring equipment, try to contact local authorities to acquire these devices.

Radiation instruments will serve to locate the safest areas in you shelter. You can minimize radiation exposure by avoiding the less protected areas.



### Effects of Accumulated Radiation Exposure

Medical care will be needed by:	(R) in any period of		
	One Week	One Month	Four Months
A NONE	150	200	300
B SOME (5 percent may die)	250	350	500
C MOST (50 percent may die)	450	600	

While it is possible to accumulate relatively high radiation exposure without immediate effects, you should keep your exposure as low as possible to avoid potential long-term danger.

Keep a record of radiation exposure for yourself and each member of the shelter. This

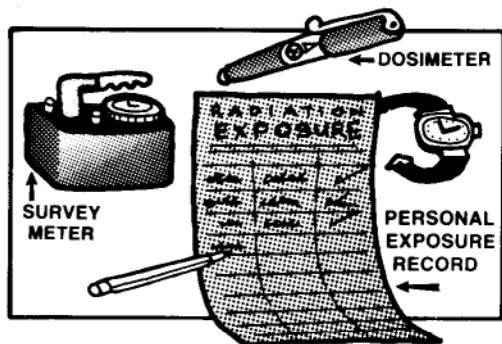

record will serve many purposes. You will know when a person can go outside on missions for the shelter. If a person gets sick you will be able to tell from the record if you should suspect radiation sickness. If you do not have radiation detection instruments, listen to your radio for information about radiation levels and instructions. Keep a written log of announcements. Stay in the most heavily shielded and protected area of the shelter. Remember that fallout radiation is most dangerous during the first few hours and days after weapons explode. For a given region, the level of

radiation found two days after the blast will have decreased (decayed) to about one percent of what it was at one hour after the burst.

### Shelter Upgrading

After you are in the shelter and monitoring radiation levels, you may find that the safety of the shelter should be improved by adding shielding materials. You may need to move earth, add supports, bring shielding materials from other parts of the building, or simply move large pieces of furniture around to use the mass for shielding. Remember that solid objects with the most mass provide the best shielding.

### Decontamination

Decontaminate your shelter area by sweeping out fallout particles that have been carried in. You should have a decontamination area where persons can remove their outerwear before entering the shelter. Outside the shelter area, sweep dirt and fallout into the decontamination area. When outside radiation levels permit, clear off window ledges, doorways, roofs, or any places where fallout has accumulated. Gradually enlarge the cleared area to about 30 or 50 feet around your shelter entry.

Fallout particles will stick to your clothes and shoes when you go outside. Wrap your shoes in a small piece of bedsheet and drape a bedsheet over your clothes when you go outside. Remove them in the decontamination area before re-entering the shelter. Sweep fallout particles out the doorway.

## Radio Monitoring and Communications

During the time you are in the shelter, communications with the outside will be of major importance. Not knowing what is happening can add to the anxiety people will already have.

In a crisis situation, a battery-operated radio will be your link to the outside world. Radio announcements will give you:

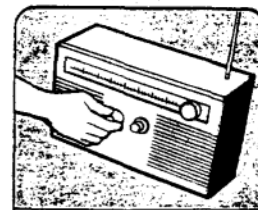

- attack warnings
- state of the nation
- damage reports
- fallout conditions
- special messages
- survival instructions
- shelter emergence instructions



### *Communications Watch*

Set up a communications "watch" by assigning shelter members to listen for important announcements. You can select reliable young persons or older persons who are unable to do the harder, physical jobs. The communications team should keep a written log of **all** announcements rather than rely on memory.

If you are in a public shelter or sharing a shelter with other families, you may want to pool your radios and batteries to extend their usefulness. **Also**, if any shelter members have Citizens' Band (CB) radios or amateur ("ham") radios, it may be possible to have two-way communications with local officials or with other shelters. Owners of these radios should train other members of the communications team to use the radios so they are available at all times and can be operated by several persons.

### *Interrupted Broadcasts*

The nuclear attack may disrupt communications for a period of time. If you cannot find a station that is broadcasting, wait a while and try again. Do not leave your radio on because you will waste batteries. Several hours or days may pass before broadcasts are resumed, so try to remain calm. No matter how frightened you are, do not leave your shelter.

### *Protecting Your Radio*

Radios and batteries will need protection in the shelter. The danger from electromagnetic pulse (EMP) may last for weeks if nuclear attacks are continued. Keep radios away from collectors such as electrical outlets, metal posts or long metal objects. Long antennas should be retracted or disconnected when the radio is not in use.

Conserve batteries by playing your radio at a low volume and using your flashlights as little as possible. Keep extra batteries in plastic bags to prevent damage from moisture.

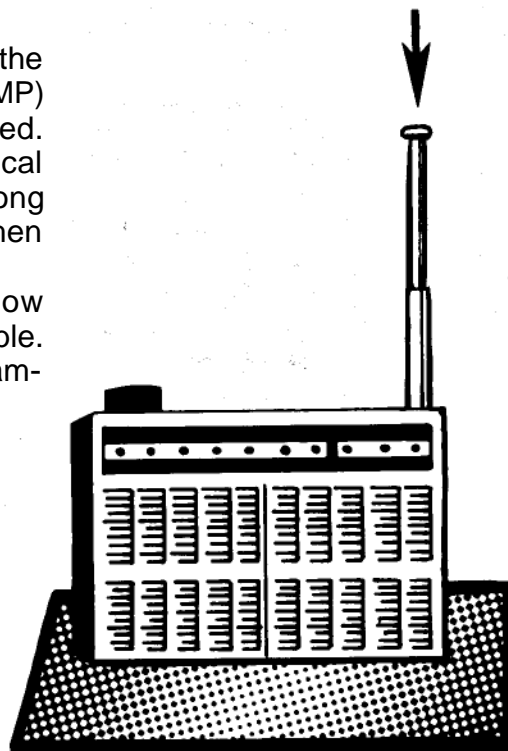

### **Alternate Power Sources for your Radio**

The radio from your car can be removed and powered by the car's battery. You will need to remove the radio, the antenna, and the car battery. Reconnect them in the shelter. You can operate the radio for several weeks if the battery has a strong charge.

You can improvise a power supply for your portable radio by connecting it to your car battery. To do so, the voltage to the radio must be reduced by connecting it to something else to avoid burning out the radio from too much voltage. For example, for a radio that runs on four 1.5 volt batteries (total 6 volts), you could add a 6 volt lamp.

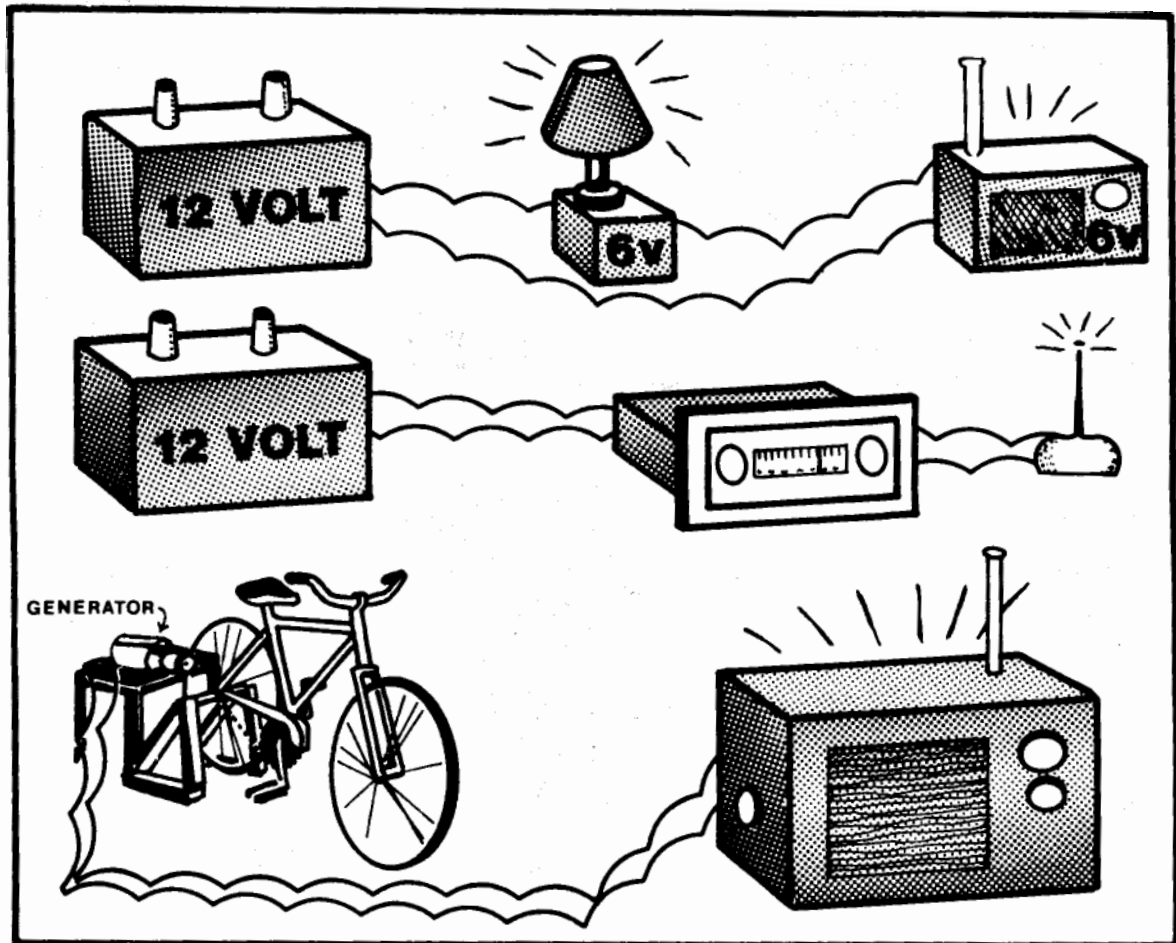

**You** can create a pedal-powered generator for a radio by raising the back wheel of a bicycle in a sturdy frame. The back wheel can be attached to a small generator such as the bicycle light generator or speedometer mechanism. Then connect the radio to the generator by electric cords. When you pedal the bicycle, you will produce enough electricity to power the radio.



## Sanitation Management

Keeping the shelter free from disease, foul odors, and insect or rodent pests will be a problem unless you plan ahead. Usual methods of garbage and human waste disposal may not be available in your shelter. You will have to develop a sanitation system and housekeeping methods that will work in your shelter.

### *Housekeeping*

If you are in a public or multi-family shelter, you will need to decide whether cooking and cleaning is to be communal or individual. That is, should you pool all of your cooking equipment and cleaning supplies and use them for the benefit of all shelter occupants, or should individuals be responsible for their own meals and clean up.

If you pool resources, you may want to inventory supplies, especially in large shelters. A list of cook stoves, pots, pans and fuel will help you manage food preparation and cleanup. By pooling buckets, soap, and sanitation supplies, you will know how to allot your supplies for various tasks such as cleaning dishes, sanitation, or general housekeeping.

Clean dishes, utensils, and cooking pots promptly. Dried food requires more water to remove and could attract pests. For clean up, provide a bucket with soapy water and one with clear water. Individuals can wash and rinse their own dishes and utensils and store them in their personal plastic storage bags. The food preparation team can use the same water to clean the cooking pots and utensils, as well as the food preparation area.

### *Human Waste Disposal*

During the first few days in the shelter, you may not be able to go outside because of high radiation levels. You will have to store human waste in the shelter area or within the building until you can safely dispose of it outside. Keep a large covered container such as a garbage can for storage of human waste.



- Remove filled plastic bags from the toilet can. Seal the bags securely.
- Store the sealed bags in the garbage can. Cover the can tightly. After a few days, place the can outside the shelter.
- Later, when radiation levels are safer, bury the waste under 1 to 2 feet of earth. Dig a waste pit at least 25 feet away from your shelter. When the pit gets full, dig another one nearby.

When outside radiation levels permit, build a privy or a trench latrine to better handle the sanitation needs of your shelter. It should be located in a private area away from the shelter. If lime is available, sprinkle a handful in the pit periodically to control unpleasant odors.

### ***Garbage and Trash Disposal***

Store all garbage and trash in covered cans lined with plastic bags. Drain any liquid from garbage, then place it in a plastic bag or wrap it in newspaper before placing it in the covered container.

Garbage, like human waste, should be buried under 1 to 2 feet of earth as soon as possible. Dispose of both your human waste and trash in the same pit. When the pit becomes full, cover it with at least twelve inches of earth and dig a new pit nearby. Bury dead animals in shallow holes to avoid attracting pests.

### ***Pest Control***

Careful storage of food and wastes should prevent problems from insects, mice, or rats. If pests do become a problem, you will need to control them. Use insecticides and pesticides with great caution. These substances are poisonous to humans, too. Keep insecticides and pesticides away from water and food supplies, cooking or eating utensils, food preparation areas, and out of reach of children.



**USE POISONS WITH  
CAUTION**



### **Personal Hygiene**

You may not be able to stay **as** clean **as** you are accustomed. A limited water supply may prevent you from washing yourself and your clothes as frequently as you like. However, you should be able to establish routines and practices within the shelter that will permit you to maintain your personal hygiene.

Use your own personal toothbrush, comb, brush, towel, cup, utensils, and dishes. You are accustomed to your own germs. Keep your personal items in plastic bags labeled with your name. You should have a place to store your personal items, such as under your bunk.

When washing yourself, wipe off sweat and dead skin with no more than one cup of water. Dampen a cloth with the water and rub your skin. Do not use soap. It requires water to remove, but more importantly, soap removes the oils in your skin that help you resist skin disease.

Do not wash your clothes until there is plenty of water available. You may want to establish a laundry day and provide a soap bucket and rinse bucket for use by all shelter occupants, instead of having occupants wash clothes at will. Or, if space for hanging wet clothing is limited, provide a schedule for washing clothes. Occasionally use boiling water or add disinfectant to the wash water to disinfect clothes.



### **Water Management**

Store your supply of drinking water inside the shelter in plastic, glass, or non-rusting metal containers with tight-fitting lids. Keep the containers covered to protect your water supply from bacteria, insects, or dirt. You will want your drinking water to last as long as possible. Be sure to use trapped water from the water pipes, flush tanks, and water heaters in the building (see Chapter 4).

**As** soon as radiation levels permit you to leave your shelter for short periods of time, you will want to replenish your water supply. Your first choice should be water sources that have not been exposed to fallout, such as water contained in the pipes of other buildings or covered wells. After an attack, open water supplies might become contaminated by radioactive fallout or other debris. Covered water may taste stale if it has been contained for a long time. You can improve the taste by simply exposing it to air in your shelter for a while.

Water exposed to fallout radiation does not become radioactive. Most of the radioactivity in fallout particles is insoluble in water. Gamma rays can come only from the fallout particles themselves, not from the water they are in. If the only water available has fallout particles in it, do not hesitate to use this water for drinking. The consequences of not drinking any water are much greater than swallowing some fallout with the drinking water. However, you should attempt to remove as many fallout particles as you can.

If the water is cloudy or you suspect that it may have harmful bacteria, use one of the purifying methods listed below before drinking it. If your only water source has been exposed to fallout, use one of the methods listed below for decontaminating water. All suspect water should be both purified and filtered. If you still do not trust the water, use it only for non-drinking purposes.

### *Decontaminating and Purifying Water*

Listed below are methods of purifying and decontaminating water. Be prepared in your shelter to use any or all of these methods.

*For water that is not pure*, use any of these methods to remove harmful bacteria:

- Add **12** drops tincture of iodine per gallon of clear water; **24** drops if water is cloudy
- Add **8** drops of liquid chlorine bleach per gallon; **16** drops if the water is cloudy, provided the label says that it contains hypochlorite as its only active ingredient
- Boil for **3 to 5** minutes
- Add purification tablets according to the manufacturer's directions.

### TO PURIFY WATER

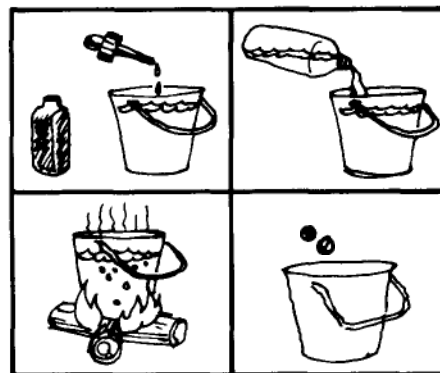

*For water containing fallout particles* use these methods:

- Filter the water through paper towels or several thicknesses of clean cloth to remove the majority of the fallout particles.
- Allow water to stand for several hours to let fallout particles settle to the bottom of the container. Be sure to take the water off the top.

### TO FILTER OUT FALLOUT

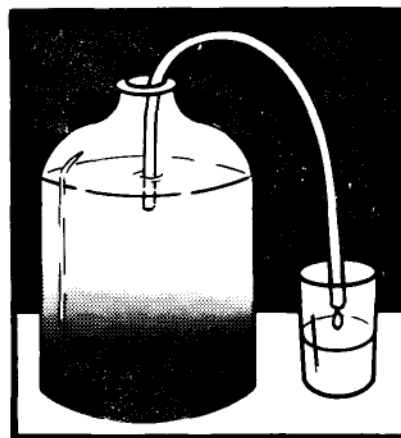

*To filter heavily contaminated water*, use one of the filtering methods listed above, then filter the water further with one of the following methods:

- Add clean soil to the water and allow it to settle until the water is clear. Remove the clear water from the top, being careful not to stir up the soil.
- Use a flower pot or can with small drain holes punched in the bottom. Fill the container with clean, uncontaminated soil. Pour the water through the soil and collect it in a clean container. Let any soil that passes through with the water settle before using the water.



## Food Management

During the first few days, or even weeks after an attack, you may have to live on the food you brought with you. Adequate radiation protection and water are much more important than food for survival during this period. Healthy adults can generally live for up to several weeks with little or no food, provided they have plenty of water and are not physically active. This section discusses how to manage food preparation under difficult conditions, how to maintain a reasonably balanced diet, and how to prepare emergency baby food. You will also learn how to make an expedient grain mill and an expedient cook stove that uses very little fuel.

### *Food Preparation and Meal Planning*

During the first days, when you cannot safely leave the shelter, keep food preparation to a minimum. Cooking adds heat to the shelter. If your shelter does not have adequate ventilation, you may need to avoid cooking as much as possible, especially in warm weather.

Use any perishable foods brought to the shelter first. If anyone brought coolers with ice, you can keep milk, butter, juice, and meat for several days. Check all meats and dairy products for spoilage before serving them, especially in warm weather. Drink fruit juices instead of water. Boiled eggs will last longer than raw eggs. If mold grows on hard cheeses such as cheddar or Swiss, you can remove the mold and safely eat the cheese. However, if mold grows on bread, do not eat any of the bread.



If the weather is cool, root vegetables such as potatoes and carrots and hard fruits such as apples will last for several weeks if they are kept cool and dry. If you suspect that any of these foods have been exposed to fallout, simply wash them off to remove fallout particles. The food itself will not become radioactive.

Prepare small amounts of food to avoid waste and leftovers. You will have a problem with waste storage and disposal and will want to keep garbage to a minimum. Waste can create unpleasant odors, attract rodents and insects, and cause disease.

If water is in short supply, you will need to adjust your meal plans. Limit the number of foods that need water to prepare. Also reduce the amount of high-protein food such as meat or peanut butter. A person who eats high-protein food requires more water than does a person who takes in an equal number of calories from other kinds of food.

The sample meal plans in the following charts show examples of meals that require either no cooking or very little cooking. The charts are presented here to give you ideas for preparing nutritious meals from limited ingredients.

*All the foods listed are dried, canned, or instant.*

## FIRST DAY

### BREAKFAST

Citrus fruit juice  
Ready -to -eat cereal  
Milk  
Cocoa or hot beverage

OR

Citrus fruit juice  
Ready -to -eat cereal  
Milk  
Crackers  
Peanut butter

---

### LUNCH

Vegetable soup  
Potato salad  
Crackers  
Ham spread

OR

Chile con carne with beans  
Crackers  
Fruit  
Cookies  
Milk, cold beverage

---

### SNACK

Fruit flavored drink  
or fruit drink

---

### DINNER

Beef and gravy  
Noodles  
Peas and carrots  
Instant pudding  
Cocoa or hot

OR

Lunch meat  
sweet potatoes  
Applesauce  
Milk, cold beverage  
Candy

## SECOND DAY

### BREAKFAST

Citrus fruit juice  
Hot cereal (quick - cooking)  
Milk  
Cocoa or hot beverage

OR

Fruit juice  
Corned beef hash  
Crackers  
Spread  
Milk, cold beverage

---

### LUNCH

Beef-and-vegetable stew  
Green beans  
Crackers  
Peanut butter

OR

Baked beans  
Brown bread  
Fruit  
Milk, cold beverage

---

### SNACK

Tomato juice or milk

---

### DINNER

Tuna fish, cream of celery soup,  
mixed sweet pickles--  
combined in one dish  
Fruit  
Cookies  
Cocoa or hot beverage

OR

Pork and gravy  
Corn  
Potatoes  
Instant pudding  
Fruit juice

## THIRD DAY

### BREAKFAST

Dried fruit  
Ready-to-eat cereal  
Milk  
Crackers  
Cheese  
Cocoa or hot beverage

OR

Grapefruit segments  
Ready-to-eat cereal  
Vienna sausage  
Milk, cold beverage

---

### LUNCH

Chile con carne with beans  
Crackers  
Tomatoes  
Cocoa or hot beverage

OR

Spaghetti with meat  
Green beans  
Crackers  
Spread  
Milk, cold beverage

---

### SNACK

Fruit flavored drink or  
fruit drink

OR

Tomato juice

---

### DINNER

Lunch Meat  
Hominy grits, or instant hot grain cereal  
Applesauce  
Cookies  
Cocoa or hot beverage

OR

Sliced beef  
Macaroni and cheese  
Peas and carrots  
Crackers  
Milk, cold beverage

*For more meal suggestions, see **Disaster Diet**. You can get a copy through your local emergency management or civil defense office.*

## **Replenishing Food Supplies**

After an attack, meat and milk will probably be scarce because fallout radiation may have killed and injured many animals. However, grain should be plentiful. This nation produces more food than it consumes. There is usually enough grain (primarily whole grain wheat, corn, and soybeans) stored in rural farm areas to feed the nation for about one year. Stored grains may be the nation's main food source after a large-scale nuclear attack.

### ***Availability of Grains***

The yield of crops in the field will vary a great deal depending upon their resistance to radiation and the time of year the attack occurred. Normal harvesting operations and rain will remove most of the fallout that initially contaminated the crops. Furthermore, the radioactivity of the remaining fallout will be greatly reduced by the time the grain is consumed.

Most likely, your diet after an attack will consist mainly of grains plus whatever uncontaminated meat and milk you can find. A hard-working person can survive quite well on a diet of about two pounds of ground grain per day, such as ground wheat **and** corn **supplemented** by soybeans for protein and some vitamins.

### ***Availability of Meat and Milk***

In many areas of the country, many farm animals may be dead within a few weeks because of fallout radiation. Radiation will also prevent farmers from safely watering and feeding their animals. Grazing animals in the pasture can fend for themselves, but many may die because of their exposure to radiation.

In areas where stored grain is in short supply, there will be an immediate short term need for meat as a human food until grain is distributed to those areas. The meat of animals that do not show signs of radiation sickness will be safe to eat if it is cooked thoroughly. When grain is made available, healthy animals should be raised as breeding stock rather than as food sources.

If local authorities permit you to risk eating the animals in your area, you must take the following precautions:

- Do not eat an animal that appears to be sick.
- Do not eat the internal organs (heart, liver, kidneys) from any animal.
- Cook all meat until it is extremely well done.

Milk from cows that ate contaminated grass or feed may not be safe after an attack. Cows that were pastured outside in fallout areas may consume fallout particles with the grass they eat. Their milk will be contaminated. Unless otherwise advised by local authorities, the only safe milk is from cows that were protected in a shelter and fed uncontaminated food.

### **Maintaining a Balanced Grain Diet**

A diet of two pounds of cooked grain per day and some vitamins will provide a healthy, hard-working person with an adequate diet. A balanced diet requires that four parts of ground wheat or corn grain be mixed with one part of ground soybeans. Soybeans are used to add protein to the diet. The grain must be ground because whole grains are not easily digested. Cooking also aids digestion by softening the ground grain. You need about  $\frac{3}{4}$  teaspoon of salt per day which can be added to the grain to improve the taste.

Soybeans have a strong flavor that many people find unpleasant. Mixing corn or wheat meal with soy beans improves the taste of the meal, as does salt and fat.

Rice, grain sorghum and barley are good substitutes for corn and wheat. Soybeans can be replaced by other dry legumes such as red beans or peanuts, which also provide needed protein. Of course, you can add meat or eggs as the protein source if these are available. Since meat and eggs are much higher in protein, you need only one part of this conventional protein to 20 parts of dry grain.

### **Meeting Your Vitamin and Fat Requirements**

A mixed grain and soybean diet supplies adequate calories and protein, and most of the vitamins and minerals that you need to maintain a healthy body. However, it does lack a few essential vitamins, especially Vitamin C. Children are most sensitive to vitamin deficiencies. Vitamin deficiencies are avoided if children take half a multi-vitamin tablet each day. Adults should take a full tablet. If you do not have or have run out of vitamin tablets, you can add vitamins to your diet through the expedient methods described in this section.

**Vitamin C** is needed to prevent scurvy, a disease that results in softened, bleeding gums and loose teeth. You need 10 milligrams of vitamin C daily to prevent scurvy. If no tablets are available, you can supply the necessary amount by eating one fifth of a cup of sprouted wheat or bean grain per day.

**Vitamin D** is needed by children to prevent rickets, a disease that causes deformed bones. Adults do not get rickets. Although you can add it to your diet in a multivitamin pill or food supplement, Vitamin **D** is supplied naturally by exposure to sunlight. You will have to use caution even when radiation levels are safe for adults. Young children and infants cannot tolerate as much gamma radiation. Place them in the sunlight for only a few minutes a day to replenish their Vitamin D without being overexposed.

**Vitamin A** is required by children more than adults for healthy skin and eyes. Vitamin A is stored by your liver, and adults usually have enough to last for several months. If vitamin supplements are not available, yellow corn grain and leafy vegetables (including dandelion greens) supply enough vitamin **A**. Shake out greens and wash them carefully to remove any fallout. Cook them briefly. Cooking causes them to lose their vitamins. Cover the pot to retain any lost vitamins, and drink the liquid.

**Fat** is needed in small quantities. Soybeans supply sufficient fat, and cooking oil or animal fat added to grain meal mush adds fat and improves the flavor of the food.

## Grinding Grains and Beans

You may have to find your own method for grinding grain if grinding machines are not readily available. You can pound or grind grain between stones, but this method is very slow. You can also make a simple *expedient grain mill* out of a large juice can, some string, and pieces of pipe. Instructions for making this grain mill are found in the Appendix.

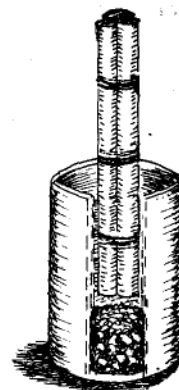

You can pound a cup of whole grain or soybeans into a fine or coarse meal in about five minutes. To use the mill, follow these steps:

1. Place a one inch layer of grain in the bottom of the can.
2. Wear gloves to prevent blisters, and place the can on a hard smooth surface such as a concrete floor or a large, flat rock.
3. Pound the grain by rapidly moving the pipe up and down to a height of about three inches. Continue pounding for about 5 minutes until the grain is reduced to meal.
4. Sieve the ground meal to separate it into fine meal for children and coarse meal for adults by passing it through a window screen. Return the grain meal that does not pass through the screen to the grain mill for more pounding.
5. Take the fine meal that passed through the screen and place it into a nylon stocking. Shake the stocking. The finest meal that passes through the stocking is suitable for small children. The meal left in the stocking is suitable for older children and adults.
6. For babies, take the finest meal that passed through the stocking and place it back in the mill for more pounding. Sieve the meal through fine mesh material such as a bedsheet.

If you use barley, oats, or grain sorghum, you must remove the hulls. To do this, shake the dry grain in a window screen or flat box to loosen the hulls. Dampen the grain before placing it in the mill. Place the ground grain in a container and cover it with water. The grain meal will settle to the bottom and the hulls will float to the top where you can remove them.

## Steps to Preparing Grains

1. Assemble the grains in the appropriate proportions: one part soybeans, four parts corn and/or wheat. Grind or pound the beans into a fine meal. Then do the same thing with the corn or wheat.
2. Cover the soy bean meal with water and let it soak for several hours. **You** may need to add more water as the meal swells.
3. Put the soaked bean meal into a pot with three times the amount of water. That is, for every cup of meal, add three cups of water. Gently boil for 15 minutes. Stir the mixture frequently.
4. Remove the pot from the heat. Add the grain meal slowly while stirring constantly.
5. Return the pot to the heat and bring it to a boil. Stir the mixture often to prevent sticking and scorching. Boil until the meal swells and all the water is absorbed.
6. Add salt to taste and heat for another 15 minutes before serving. If available, add a small amount of cooking oil or fat to improve the flavor and add some fat to your diet.



### Steps to Growing Wheat and Bean Sprouts

Grain sprouts are easily grown in a few days with very little water. They supply the most vitamin C when the sprouts are about twice the length of the seeds. Both the sprouts and the seed should be eaten.

1. You will need a plastic bag, two rolls of paper, and unbroken grain that is free of hulls.
2. Cover the grain with water and let it swell for 12 hours. Drain the liquid and save it. The liquid itself contains vitamins, so you can drink it or use it for cooking.
3. Make two rolls of paper and dampen them with water. Place them inside the plastic bag along its edges to provide air space for the grain.
4. Place a one inch layer of soaked grain in the bag between the rolls of paper. The rolls of paper should be higher than the layer of grain to lift the plastic above it.
5. Make a small loose roll of paper with about a one-inch diameter opening in the center. Insert it in the opening of the bag and close the bag around it. Clip or tie the bag around the paper roll. The result is an air vent for the sprouting bag.
6. Keep the paper vent moist and open. It will keep the grains damp and prevent mold.

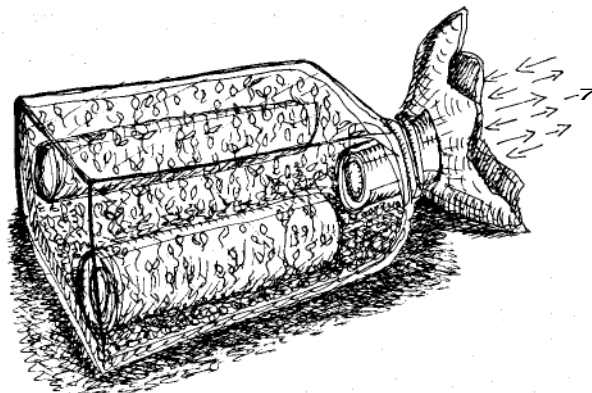

In two or three days, the sprouts should be ready to harvest. You can eat them raw, but to improve their digestibility, you can cook them in a small amount of water for not more than 2 minutes. Prolonged cooking causes them to lose their vitamin C.



### Emergency Food for Babies

Infants and very small children are more susceptible to starvation, and to vitamin and mineral deficiencies. Their bodies grow and develop rapidly, and they need proper nutrition. Special care must be taken to provide them with adequate diets, a difficult task when food is scarce.

**Breast milk** is the most complete food for infants and babies. Mothers should continue to nurse their babies for as long as possible. In some countries, mothers nurse for as long as two years with little or no supplements to their children. A nursing mother must eat an adequate diet in order to supply enough milk for her child. The grain diet with vitamin A, C, and D supplements is sufficient for a nursing mother. In addition, you do not need to worry about sterilizing of bottles and formula, carrying sterilizing and feeding utensils, or mixing formulas.

If babies are not nursed, they need special food. Babies over six months can eat grain, but infants require special formulas. If the mother runs out of foods and formula brought from home and cannot obtain more, three sources of emergency baby food are available: dry milk solids, safe cow's milk, and finely ground grain meal mush. These foods must be freshly prepared and the utensils sterilized for each serving.

a. Dry milk solids

The best infant food under emergency circumstances is powdered milk with vitamins, sugar, and oil added. The formula for each feeding is listed in the following chart.

Ingredients	Per day	
Instant non-fat dry milk powder	1 cup + 2 tbsp (2 1/4 oz.)	8 grams
Vegetable cooking oil	3 tbsp. (1 oz.)	30 grams
Sugar	2 tbsp. (.7oz.)	20 grams
Daily multi-vitamin pills	1/3 pill	

b. Safe whole cow's milk

Whole milk from safe cows will be scarce and should be allocated to infants under six months old. Safe milk is produced by healthy cows that are kept in a fallout-protected shelter and fed uncontaminated feed and water.

c. Mixed grain puree

Finely pureed grains can be fed to infants under six months old if milk is not available. Use a mixture of 3 parts yellow corn or rice plus one part soybeans. Do not feed wheat to infants. Follow these steps to make the meal puree:

1. Finely grind and sieve the grain mixture.
2. Boil the mixture for **15** minutes in water, one part grain to three parts water until the water is absorbed.
3. Press the cooked meal through a fine sieve (cheesecloth or bedsheet) with a spoon.
4. Boil the sieved puree in a small amount of water until it reaches a consistency of pablum. It should be spoonable but thin. Store the puree in a sterilized covered container.
5. At each serving, add **sugar** and oil and boil again. Let the mixture cool before adding vitamins and feeding the infant.

*Sterilized food and utensils* are required for feeding infants under **6** months old. Boil the food before each serving. Clean the feeding utensils after each feeding and sterilize them by boiling for 5 minutes. If fuel is scarce, you can sterilize cleaned utensils by storing them in covered container with a solution of cold water and household bleach that lists hypochlorite as its only active ingredient. Use 1 teaspoon of bleach to one quart of water. Use the utensils without rinsing, and prepare a fresh solution daily.

### **Cooking in the Shelter**

Begin cooking only when you can provide adequate ventilation to exhaust smoke and fumes from the shelter. Use small camp stoves if available, since these use little fuel and produce little smoke.

Cooked food is essential for health, digestion, and morale. If you brought a camping stove or charcoal grill, you must have fuel and adequate ventilation to operate it. If you cannot cook outdoors because of fallout or bad weather, do not operate your charcoal grill. Charcoal releases carbon monoxide when it burns, and inadequate ventilation could be deadly. A camping stove can be used safely indoors if you keep the air moving with a ventilation fan. Do not build a wood fire indoors unless you build it in an existing fireplace or have some means of exhausting the smoke.

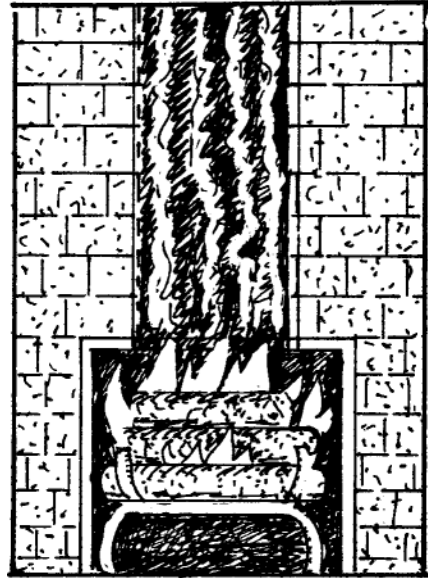

You may run out of fuel or find that firewood is very scarce. You can share cooking with others to conserve fuel, and you can make an efficient expedient wood-burning stove. The stove can be made from a metal bucket, waste basket, or large juice can, and 10 wire clothes hangers. You will also need pliers and a metal cutting tool. Instructions for building the stove are in the Appendix.

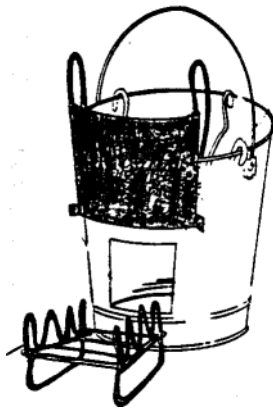

#### ***Operating the Expedient Stove***

The expedient bucket stove burns only one half pound of dry wood or paper to bring 3 quarts of water to a boil. It is efficient because the flame can be kept close to the pot, and hot exhaust gases pass close to the pot. You can adjust the flame by adjusting the air supply damper and the depth of the wood piled on the grate.

**For safety**, keep the stove near the ventilation opening in your shelter and keep the shelter vents open when the stove is operating. The vents should be fully open when you start the stove, but they can be closed partially (never closed completely), while cooking. Never use fire starter liquid, gasoline, or kerosene to start the stove.

**Fuel for cooking** can be either wood or paper. Wood should be cut into small pieces about  $\frac{1}{2}$  inch by 5 inches. Newspaper should be rolled and twisted into a 5 inch long "stick". Paper fires are easily started, but wood fires need kindling (twisted paper, wood shavings or splinters) and attention. Place the kindling under the grate and light it. Keep the damper open fully as you slowly add wood. Adjust the damper when the wood itself starts to burn.

**Adjust the flame during cooking by opening** and closing the damper. Keep the flame just below the pot; do not let it go up the sides of the pot.

Use the stove to heat the shelter in cold weather by keeping the stove vents wide open for a maximum flame. Make certain that the shelter ventilation vents are open, and use hand fans to circulate air and remove smoke.

When you can be outside for a few hours at a time, move your cookstove outside or build a campfire to do your cooking outside of the shelter. Collect rocks to serve as a base and to contain the fire. The rocks will also hold heat, an important factor if firewood or other fuel is scarce. The fire should be watched carefully and completely extinguished before you leave it.

### Fireless **Cooking**

When cooking grains, you normally need to boil the grain in water for about thirty minutes. When fuel is scarce or ventilation inadequate, you can boil the mixture for only five minutes, then move the pot to a fireless cooker where it can cook slowly for several hours or overnight.

You can make a fireless cooker by several methods depending on the materials available to you. You can heat rocks or bricks in an open fire, then move them to a bucket or metal container. Place the pot on the rocks and cover the bucket with several inches of insulation, such as blankets, towels, or coats. You can also embed the bucket in a container of sand or earth to hold the heat. Then you only need to cover the bucket and pot. If rocks are used, they should not be heated to red hot or they could cause a fire.

If you do not have rocks, bricks, or sand, you can achieve a suitable cooker by simply surrounding the cooking **pot** with at least six inches of insulating material. The pot should be covered completely and left undisturbed for at least 5 hours.

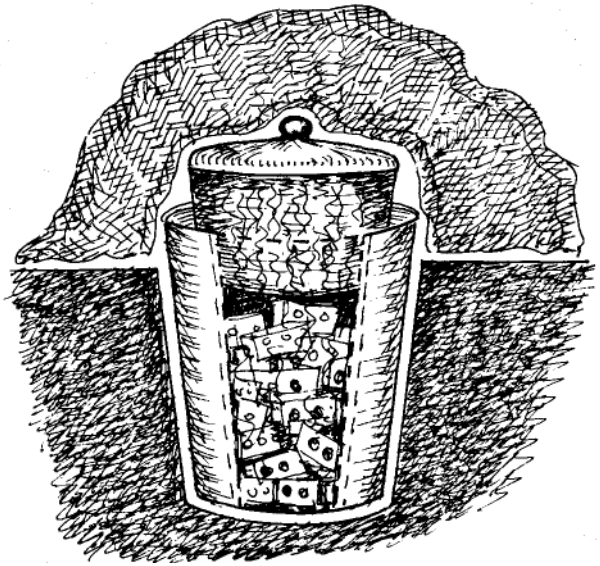

### Health Management

Much of your time will **be** spent keeping the shelter safe and sanitary. In addition, you should be prepared to face some of the serious health and psychological problems that may occur.

This section discusses some of the more critical problems that will be faced by shelter members.

- o Emergency first aid for injuries
- Radiation sickness
- Contagious diseases
- o Mental health and psychological problems
- Death

## Managing First Aid and Medical Care

The medical conditions that you are likely to encounter and should learn to treat are:

- bleeding
- burns
- shock
- heat prostration
- broken bones
- glass or objects imbedded in the skin
- wounds
- infected wounds
- radiation sickness
- heart attack
- respiratory diseases (colds, flu)
- simple childbirth
- toothache



A good first aid handbook, such as the American Red Cross manual, will teach you how to treat most injuries. You should also add a medical self-help book to your first aid supplies. This kind of book will help you recognize and treat serious injuries and illnesses if no doctors or effective medicines are available.

Contagious diseases may be avoided if you follow good sanitation methods. However, if someone develops a contagious disease, the patient should be isolated as much as possible to prevent spreading the disease. If you have little space, a blanket or sheet hung as a curtain around the patient's bed may help control the spread of the disease.

### *Treating Injuries*

Most of us have little first-hand experience treating life-threatening medical emergencies. Americans enjoy excellent medical services that respond quickly to save lives. In a nuclear attack emergency, you may be on your own during the first critical minutes when an injured person must have first aid. While this chapter cannot give you all the information that you need to treat medical emergencies, we can give you some important guidelines. Whenever possible, seek assistance from trained medical personnel in addition to the treatments described here.

1. Always treat life-threatening conditions first.

- When a person stops breathing, death may occur in 4 to 6 minutes. Give mouth to mouth rescue breathing.



- When a person is bleeding badly, unless the bleeding is stopped, only about **15** minutes of life may remain. Apply direct pressure over the site of the wound.



2. Be alert for signs of shock in injured persons:

- fast, weak pulses
- shallow breathing
- pale and clammy skin
- nausea and dizziness

3. Treat all serious injuries for shock:

- Keep person warm, comfortable and lying down
- Unless there is a head or chest injury, elevate the victim's feet and legs.

4. Handle victims of broken bones with care:

- Check first for breathing, bleeding, and shock
- Do not move the victim unless there is danger of additional injury.
- Splint fractured limbs to prevent painful motion, especially if you must move the victim.

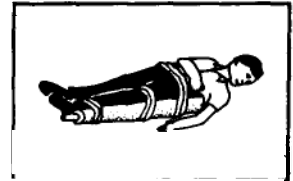

5. Treat burn victims for shock, to relieve pain, and prevent infection:

- Cool and clean with cold water; do not touch the burn.
- Cover the burn with dry sterile or clean cloth to relieve pain and keep clean.
- Give the victim fluids.

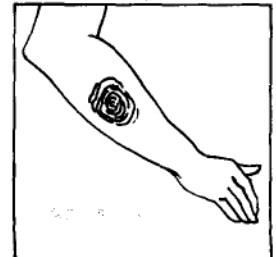

6. Get medical help as soon as possible, especially for seriously injured persons. In the meantime, keep the victim warm and as comfortable as possible.

***Heart Attack***

Heart attack is the number one peacetime killer of adults over the age of **38**. The stress and anxiety of a nuclear crisis may increase the number of heart attack victims.

Warning signs of heart attack include the following:

- Severe squeezing pain in the chest
- Pain that radiates from the chest into either the arm, neck, or jaw
- Sweating and weakness, nausea or vomiting
- Pain that extends across the shoulders to the back.

Two critical life threatening things happen to the victim of a heart attack.

1. Breathing slows down or stops.

Give rescue breathing immediately and have someone else go for medical help immediately.

2. The heart slows down or stops pumping blood.

Take the victim's pulse by the Carotid Artery located on either side of the neck, slightly below and forward of the base of the jaw. If no pulse is detected, begin CPR along with rescue breathing. Get medical help as soon as possible.

CPR (cardiopulmonary resuscitation) is a way of forcing the heart to continue pumping blood through the lungs and out to the rest of the body. Only trained persons should perform CPR because it can hurt the victim if it is not done properly. CPR is too complicated to give instruction here, but many people are already trained to perform CPR.



### **Radiation Sickness**

Recognizing the symptoms of radiation sickness will be difficult. The early symptoms are similar to the early stages of many contagious diseases. They are also similar to signs of fear and stress.

### **Early Symptoms**

Radiation sickness begins with headache, nausea, vomiting, diarrhea, and a general feeling of tiredness. So do many other illnesses.

### **Treating Early Symptom**

Whether the symptoms are from radiation sickness or another condition, the patient should be kept warm and as comfortable as possible.

<b>SYMPTOM</b>	<b>TREATMENT</b>
Headache	Give aspirin or aspirin substitute. Follow the recommended dosage given on the container.
Nausea	Dramamine or motion sickness tablets should be given according to directions on the container.
Sore mouth or bleeding gums	Give mouthwash made by adding one half-teaspoon of salt to one quart of water.

Vomiting or diarrhea

Have the person drink slowly several glasses each day a salt-and-soda solution (one teaspoonful of salt and one-half teaspoonful of baking soda to one quart of cool water), plus boullion or fruit juices. If available, give a mixture of kaolin and pectin (Kaopectate) for diarrhea.

### **Later Symptoms of Radiation Sickness**

The early symptoms of radiation sickness will usually disappear in a day or two. In more serious cases, they will return within 2 weeks and be accompanied by symptoms such as:

- hair loss
- small hemorrhages under the skin
- bloody diarrhea

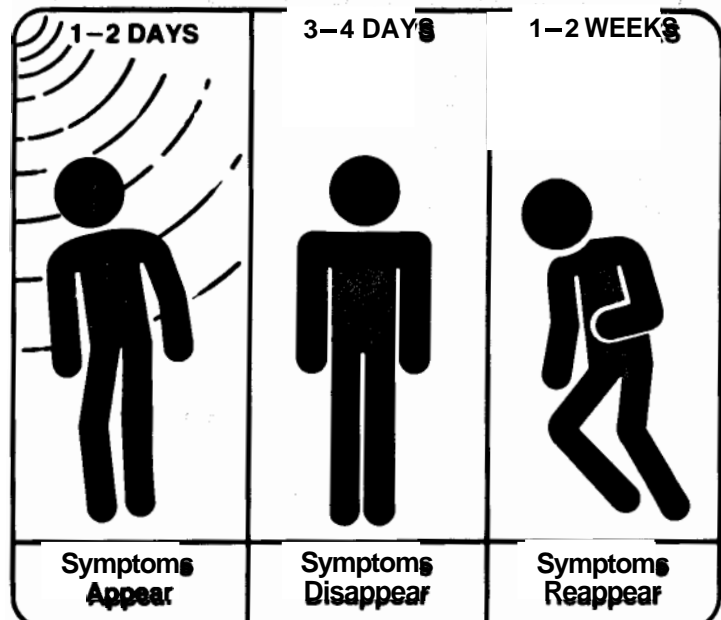

Keep the patient warm and resting. In addition to the treatments prescribed for early symptoms, give antibiotics, if available, to reduce the chance of infections.



### **Radiation Sickness is not Contagious**

Radiation sickness is caused by radiation damage to cells of the body. A victim is not contagious. Other people cannot "catch it." In fact, it is much like sickness from poisoning. You can safely help a person with radiation sickness just as you can safely help a victim of poisoning.



### **Psychological First Aid**

A nuclear attack crisis will produce emotional reactions in almost everyone. The events, the difficult living conditions, the uncertainty about the future, and the lack of communication with friends and relatives will test the strength and courage of the entire population.

Some people will cope better than others. Most everyone will show signs of fear, and some may panic. Some will overreact, and some will show signs of depression.

Treat serious emotional reactions with patience and reassurance. The following guidelines will help you recognize problems and handle the situation appropriately.

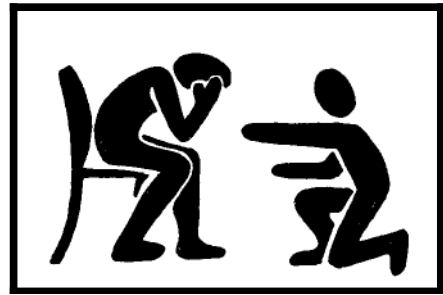

### ***Helping Victims***

Be aware of your own feelings and reactions. You, too, may be reacting to the strain of the situation. You may be tempted to use drastic measures. Restrain yourself. Remember that persons with severe emotional reactions are victims. Here are some of the actions to avoid:

- o Do not show resentment.
- Do not over-sympathize.
- o Never use brutal restraint. If you must restrain a victim, be gentle but firm.
- o Do not strike or throw water in the face of the victim.
- o Avoid giving sedatives unless they are prescribed by a medical doctor trained to handle psychological problems.
- o Do not argue, suggest the victim is acting, or tell the victim to “snap out of it.”
- o Do not blame, ridicule, or ignore the victim.

In all your actions, use common sense and treat the person as you would want to be treated. Show kindness and understanding during this difficult time.

### **Death**

Persons may enter the shelter with serious injuries or exposure to high levels of radiation. Death may occur. While death is difficult to think about, shelter members must realize that war will mean many deaths, and some of these may occur in your shelter. You and your shelter group will have to plan what to do if death occurs.

For reasons of health and morale, the dead must be removed from the shelter area. Members of the shelter may want to conduct a simple service. Wrap the body in a sheet, blanket, or other suitable materials, and, when possible, quickly remove it from the area, out of sight of the shelter occupants. Provide emotional support to the family of the deceased as well as to other shelter members.

The death should be recorded and some form of identification should be attached to the body. Consult local officials at the Emergency Operations Center (EOC) for guidance on burying the body, especially if the death occurs when outside radiation levels are high. If no guidance is available, carry the body outside. Bury the body in a marked grave as soon as radiation levels permit.

**If you notice  
these symptoms**

**The diagnosis may be:**

**To treat:**

---

Trembling  
Muscular tension  
Perspiration  
Nausea  
Mild diarrhea  
Frequent urination  
Pounding heart  
Rapid breathing

***Normal fear***

Give reassurance  
Provide group identification  
Motivate  
Talk with the person  
Observe to see that individual  
is regaining composure

---

Unreasoning attempt to  
flee  
Loss of judgment  
Uncontrolled weeping  
Wild running about

***Panic***

Be empathetic  
Give something warm  
to eat or drink  
Get help to isolate, if  
necessary  
Encourage talk  
Be aware of your own  
limitations

---

Argumentative  
Talks rapidly  
Jokes inappropriately  
Makes endless  
suggestions  
Jumps from one  
activity to another

***Overactive Reaction***

Let the person talk about it  
Find the person jobs which  
require physical effort  
Give warm food, drink  
Supervision necessary  
Be aware of own feelings

---

Stands or sits without  
moving or talking  
Vacant expression  
Lack of emotional  
display

***Depression***

Make contact gently  
Secure rapport  
Get the person to tell you  
what happened  
Be empathetic  
Recognize feelings of  
resentment in the person  
and yourself  
Find simple routine jobs  
Give warm food, drink

---

Severe nausea and  
vomiting  
Can't use some part  
of the body

***Physical Reaction***

Show interest in the person  
Find small jobs for the  
person to do  
Make comfortable  
Get medical help if possible  
Be aware of own feelings

---

## Reorganization and Recovery

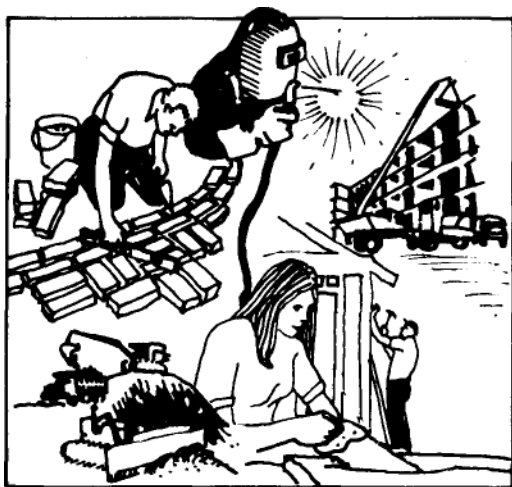

No one knows exactly what life in the United States would be like after a nuclear attack. Researchers who have studied the problem believe that both the United States as a country and much, even most, of the population would survive, especially if civil defense actions were followed. Although millions of people would be killed or injured, and many of our large cities might be destroyed or severely damaged, the **U.S.** would go on to reorganize and reconstruct itself.

The process of rebuilding the cities and economic systems would be long and difficult. The first priorities would be to get people out of

shelters and into more comfortable housing, to treat the ill and injured, and to restore water and food supplies. Electricity and communications would also need to be restored as soon as possible.

As soon as radiation levels permitted extended hours outside the shelters, work teams would be assembled to remove fallout, clean up debris, restore power and water systems, and begin industrial and agricultural production. Cleaning up and rebuilding would take a long time. In this kind of a nationwide disaster, rebuilding would take a much longer time than after even a catastrophic peacetime disaster, such as a major hurricane or earthquake. All able persons would need to participate in the rebuilding process. Your help would be needed until most systems and services were working and jobs were available again.

### The Country After a Nuclear Attack

Opinions differ among persons who study what the **U.S.** would be like after a major nuclear attack. Some speculate that climate and weather would be affected temporarily. Radiation from fallout would steadily decrease as time passed so that by the end of one year, only areas around blast craters would continue to give off dangerous levels of radiation. There could be other noticeable effects, such as:

- a cooler growing season,
- a temporary increase in rainfall,
- an increase of forest fires and erosion because of trees and ground cover killed by radiation,
- spotty outbreaks of insect and rodent pests.

One or more of these events could affect agriculture and forestry for several years. In time, forests would grow back and wildlife would return to control pests.

Many experts who have studied potential problems resulting from nuclear attack believe that Americans would not be helpless and could overcome the challenges resulting from an attack. Living conditions would be crude and uncomfortable for a long time until the technologies that we now depend upon could be restored. Cars probably would not be used because gasoline may not be widely available for a long time. Heat and lighting on a large scale may not be available for some time, so persons would have to use fireplaces, wood stoves, and candles or lanterns. In short, Americans could be forced back to pioneer living standards until modern services and technologies could gradually be restored.

A nuclear attack would test the courage, strength, and inner resources of every citizen. Life after war would certainly be difficult, but Americans are known for their optimism, strength, and ingenuity. Although technologies might be destroyed, the knowledge to build them would not be lost. Government and law and order would not be lost, but the system of implementing them would change until communication systems were restored. The face of the nation might look different, but the nation and the people would survive.

### Epilogue

This book has been about what *you* must do to protect yourself and increase your chances of survival in a nuclear attack crisis. If you have developed preparedness plans, you have taken a big step toward survival. But you must do more than just make plans. You must face the realities of nuclear attack and what it would mean to you and to the nation. You must believe that nuclear war could happen in spite of government and citizen group efforts to prevent it. And you must believe that the survival of yourself and the nation is possible. If you have these beliefs, then you will be prepared to act wisely and cooperatively for your own survival and that of others.

