



SurvivalRing

Study Yesterday.. Prepare Today.. Live Tomorrow

This digital document created and presented by Richard Fleetwood. He is the founder, author, producer, and webmaster of the **SurvivalRing** (<http://www.survivalring.org>) and **Civil Defense Now!** (<http://www.survivalring.org/cd-main.htm>) websites.

SurvivalRing has as its goal the ideal of being the leading source of survival, preparedness, and self reliance information on the Internet. Linkage, assistance, and creation of digital content in areas that until now have only been hinted at or impossible to find, is being added to everyday via the SurvivalRing website and email lists.

Thousands of hours of searching, writing, and communications have been spent collecting over 2 gigabytes of digital content, as well as tens of thousands of pages of hard copy original public domain material in the areas of civil defense, survival, training, and preparedness, from all over the globe.

As much as possible is being put online at his website at

<http://www.survivalring.org>

Civil Defense Now!

Part of The SurvivalRing website

The content of THIS file, while created from PUBLIC DOMAIN material, produced by the U.S. (or other) Government at taxpayer expense, is presented in THIS digital format, produced from the ORIGINAL hardcopy document, for the benefit of all mankind, in hoping to help spread the idea of PREPAREDNESS for any and all threats that may come from either natural, extraterrestrial (space based), or manmade sources.

There are too many situations and incidents that can come to pass in everyday life, that when time is taken to learn and skills obtained, can mean the difference between life and death. Sept. 11, 2001 proved to the world that no matter how safe a person thinks they may be, death and injury can come from the most UN-LIKELY place, at any time. The documents presented in this series of digitized works, can help the average person with the knowledge within, to know how to save those persons closest to them in REAL disaster. Help spread this idea of sharing SURVIVAL INFORMATION.

If you have documents from any era, on any disaster or civil defense area, PLEASE contact Richard at his email address of RAFLEET@AOL.COM. Check the website for the LATEST additions to the CIVIL DEFENSE NOW online library archive. All data online, and much more, is also available on CD-ROM. Information is available at the website on how to obtain it. Thanks for your support, and enjoy the information contained on the following pages. Share them with those who will learn from them and teach what they know to others.

Donations of U.S. or other civil defense documents, articles, books, videos, digitized ephemera, patches, tools, photos, or anything of this nature is appreciated, as well as cash gifts or donations to support the website costs and bills. Address information is available on the homepage of Civil Defense Now! (URL located above)

- Richard Fleetwood – January 2002 — ALL RIGHTS RESERVED –

This document may NOT be reproduced commercially on any media WITHOUT EXPRESSLY WRITTEN permission from the creator of this digital presentation. Educational Institutions MAY use this material in any way needed.

Permission granted to individuals for PERSONAL USE ONLY.



MILWAUKEE CITY CIVIL DEFENSE ADMINISTRATION
 ESTIMATE OF GENERAL COST OF MATERIALS FOR THE BASEMENT, CONCRETE BLOCK,
 6 PERSON, FAMILY FALLOUT SHELTER
 by
 Robt. E. Weigend, P.E.

Milwaukee's Premium FALLOUT SHELTER

MATERIALS

	OCDM Shelter Dwg. No. SC-1 Booklet MP-15	Milwaukee Premium Fallout Shelter
4" x 8" x 16" Solid Conc. Blk. @ 23¢ each	\$ 116.15	
8" x 8" x 16" Hollow Core Conc. Blk. @ 23¢ each		\$ 3.68
12" x 8" x 16" Hollow Core Conc. Blk. @ 30¢ each		42.60
Mortar Mix @ \$1.95/bag	15.60	
Cement @ \$1.50/sack		18.00
3/4" Crushed Bank Run Gravel @ \$2.00/cu. yd.		12.00
4" x 4" Posts and Beam @ 24¢/lin. ft.	9.36	7.20
2" x 6" Joists @ 17¢/lin. ft.	13.60	21.42
5/8" Plyscore @ \$7.14/4' x 8' sheet	21.42	
3/4" Plywood @ \$10.35/4' x 8" sheet		31.05
1/2" x 7" Bolts with Expansion Sleeves @ 34¢ each	3.40	3.40
16 penny nails @ 22¢/lb.	.66	.66
6 penny nails @ 25¢/lb.	.75	.75
Total General Cost of Materials	\$ 180.94	\$140.76

CONSTRUCTION INFORMATION

THE MILWAUKEE PREMIUM FALLOUT SHELTER is similar to the OCDM model described in Booklet MP-15, but it is easier to build and it offers double the protection at a lower cost than the OCDM standard basement family fallout shelter.

The shelter is first located and the basement floor and walls must then be scored or chipped to provide a bond for the cement. The bottom course of 12" Hollow Core Concrete Block is then layed in place dry.

"Soil Cement" is then mixed as follows: 1 sack of Portland Cement is torn open at its end and the cement is dumped onto a working space on the basement floor; the empty sack is then filled 6 times with 3/4" Crushed Bank Run Gravel and these 6 sacks of gravel are added to the pile of cement; the dry contents of the pile must be mixed thoroughly with a shovel and shaped into a "doughnut-ring" on the floor; NOT MORE THAN 6 gallons of Water is then poured, a little at a time, into the center of the "doughnut-hole;" the dry mixture of cement and gravel is then pulled, a little at a time, into the water where it is mixed to a working consistency, not so stiff that it will stand by itself, yet not so wet that it will flow like soup. (Not all the 6 gallons of water may be used in one batch of Soil Cement, because the gravel may already contain moisture which might then make the mix too "soupy.")

The Soil Cement is shoveled into the cores of the concrete block where it is tamped and rodded (a steel rod about 3/4" in diameter and 18" long is plunged approximately 20 times into the filled cores of each block to get rid of air spaces or voids formed when the Soil Cement is shoveled into them). The filled blocks should be rocked lightly to make the Soil Cement ooze out of the joints in order to insure a good bond between the blocks. The level of the Soil Cement should be kept an inch or so below the top of the blocks so as to afford a bonding space for the Soil Cement in the next course of blocks.

The walls of the Premium Fallout Shelter should be built up level and plumb until 9 courses are in place before starting construction of the interior timber frame and roof. The posts, beams, and joists are built and cemented into place with the 10th course of block according to the instructions in the OCDM Booklet MP-15. The entire plywood roof should be nailed into place before the last course of block is layed on wall number 1.

The plywood and top courses of block should be covered with plastic sheets (tablecloths) to form a moisture barrier before 16" of dry 3/4" Crushed Bank Run Gravel is shoveled on top of the shelter and rammed into place. The final blocks can then be layed, draped with plastic sheeting and backfilled to finish off your Milwaukee Premium Fallout Shelter.

The size of the Milwaukee Premium Fallout Shelter can easily be increased (with no decrease in strength or protection) by lengthening wall number 1 in the ratio of 3 blocks for every 2 additional persons and adding joists and a post to stretch the roof. This shelter can also be reinforced by inserting rods, pipes, bars, or angle iron in the cores after the Soil Cement has been tamped and rodded.

YOUR ONE DEFENSE AGAINST FALLOUT IS AN ADEQUATE FALLOUT SHELTER.

Radiation Decays And Dies -- Don't Die With It

DEADLY RADIOACTIVE FALLOUT IS A THREAT TO SURVIVORS OF A NUCLEAR ATTACK ANYWHERE IN OUR COUNTRY. UNTIL THIS DEADLY RADIATION LEVEL DECAYS, YOUR LIFE AND THE LIVES OF YOUR FAMILY ARE THREATENED. RADIATION INTENSITY IS LOWERED BY MASS--AND THE HEAVIER THE MATERIAL BETWEEN YOU AND THE RADIOACTIVE FALLOUT, THE MORE PROTECTION YOU HAVE.

How Much Radiation Is Fatal?

RADIATION IS MEASURED IN ROENTGENS. DURING THE TWO CRITICAL WEEKS FOLLOWING A NUCLEAR ATTACK, A PERSON IN AN AREA COVERED BY RADIOACTIVE FALLOUT COULD HAVE HIS BODY EXPOSED TO A TOTAL OF 10,000 ROENTGENS OF RADIOACTIVITY (AND 700 ROENTGENS IS CONSIDERED A FATAL EXPOSURE!).

Where Will You Find Shelter?

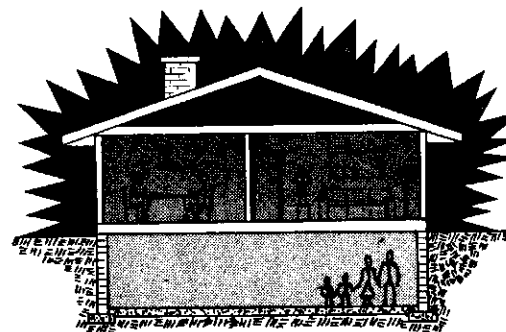

THE FIRST FLOOR OF AN AVERAGE HOME WILL CUT DOWN THE AMOUNT OF RADIATION SOMEWHAT. IN TWO WEEKS TIME; HOWEVER, YOU WOULD STILL BE EXPOSED TO A FATAL DOSE OF THE HARMFUL RAYS. THE BASEMENT OF THE HOME IS BETTER, BUT THE TOTAL EXPOSURE TO THE HARMFUL RAYS IS STILL SUFFICIENT DURING THE TWO WEEKS TO PROVIDE A FATAL DOSE. THE HOME DOES NOT OF ITSELF PROVIDE ENOUGH BARRIER TO THE PENETRATING RAYS.

The Answer -- Prepared Shelter

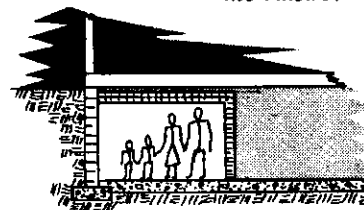

THE ONE DEFENSE AGAINST RADIOACTIVE FALLOUT IS AN ADEQUATE FALLOUT SHELTER. THE MILWAUKEE PREMIUM FALLOUT SHELTER USES A COMBINATION OF CONCRETE AND BANK RUN GRAVEL TO PROVIDE A MASS NECESSARY TO STOP THE HARMFUL RAYS. IT IS EASY TO BUILD AT A REASONABLE COST. A PERSON IN THIS SHELTER WOULD RECEIVE LESS THAN 1% OF THE OUTSIDE DOSE OF RADIATION. THUS, EVEN IF THE OUTSIDE RADIATION AMOUNTED TO AS MUCH AS 10,000 ROENTGENS DURING THE TWO CRITICAL WEEKS FOLLOWING AN ATTACK, THESE HARMFUL RAYS WOULD NOT SERIOUSLY AFFECT PERSONS INSIDE THE PREPARED SHELTER.

Milwaukee City Civil Defense Administration
 105 North Water Street Milwaukee 2, Wisconsin

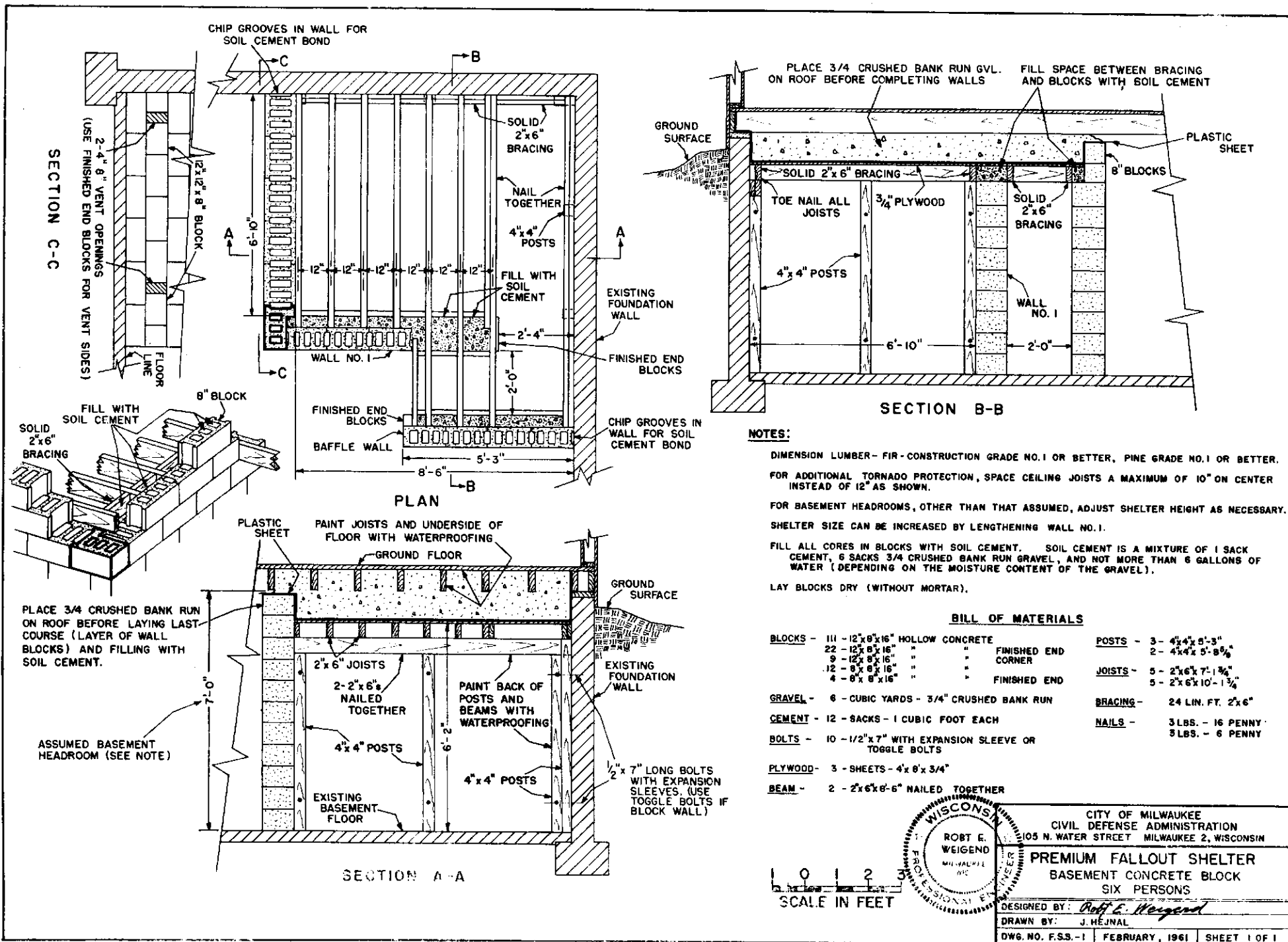

SECTION C-C

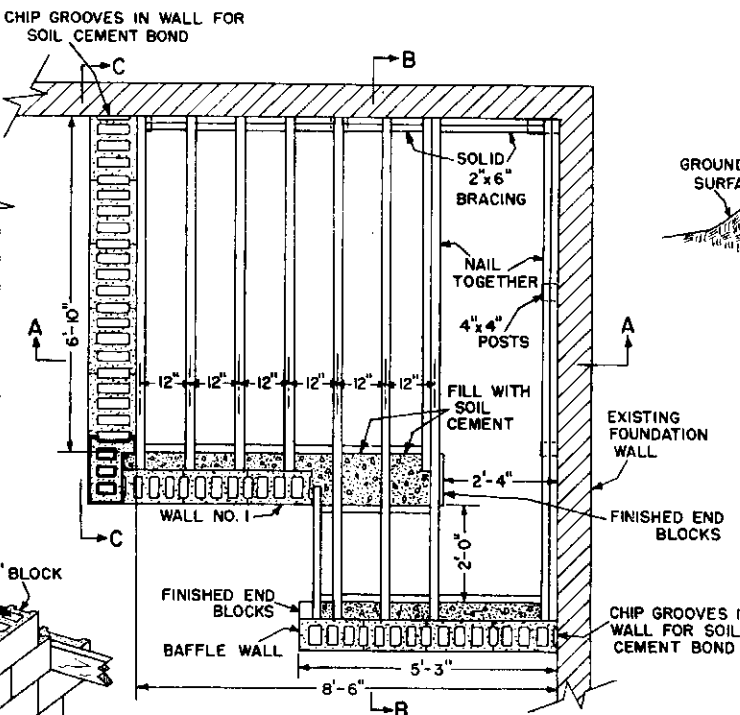

PLAN

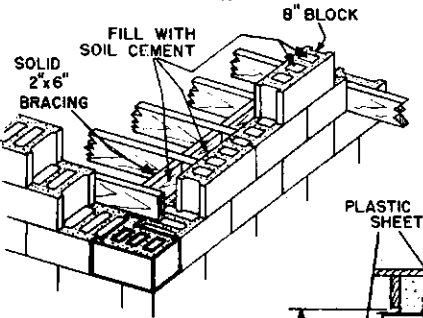

PLACE 3/4 CRUSHED BANK RUN ON ROOF BEFORE LAYING LAST COURSE (LAYER OF WALL BLOCKS) AND FILLING WITH SOIL CEMENT.

ASSUMED BASEMENT HEADROOM (SEE NOTE)

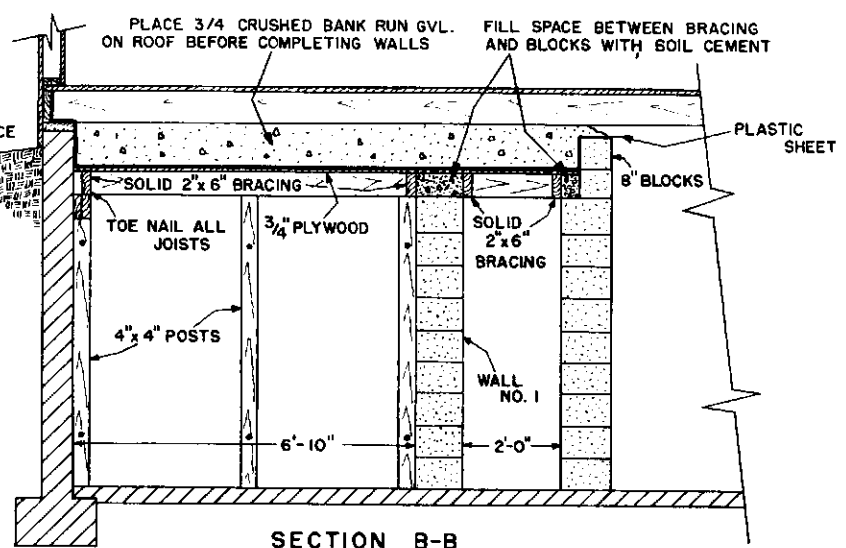
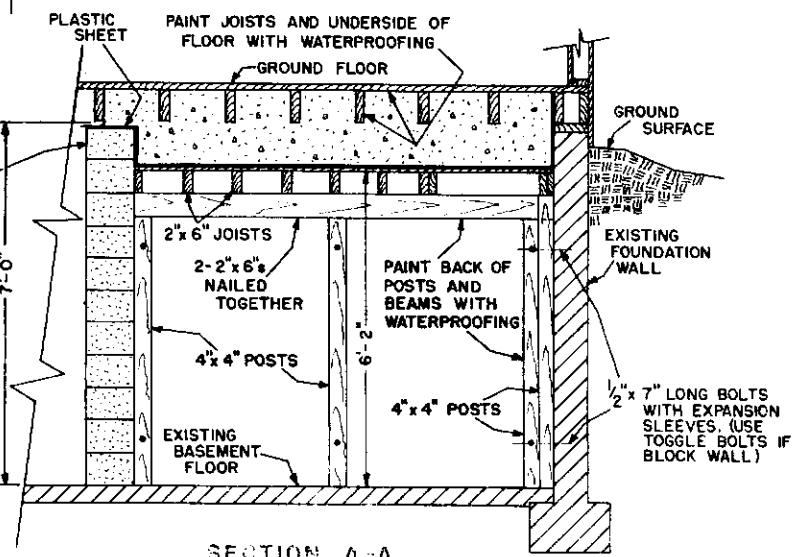

NOTES:

- DIMENSION LUMBER - FIR - CONSTRUCTION GRADE NO.1 OR BETTER, PINE GRADE NO.1 OR BETTER.
- FOR ADDITIONAL TORNADO PROTECTION, SPACE CEILING JOISTS A MAXIMUM OF 10" ON CENTER INSTEAD OF 12" AS SHOWN.
- FOR BASEMENT HEADROOMS, OTHER THAN THAT ASSUMED, ADJUST SHELTER HEIGHT AS NECESSARY. SHELTER SIZE CAN BE INCREASED BY LENGTHENING WALL NO.1.
- FILL ALL CORES IN BLOCKS WITH SOIL CEMENT. SOIL CEMENT IS A MIXTURE OF 1 SACK CEMENT, 5 SACKS 3/4 CRUSHED BANK RUN GRAVEL, AND NOT MORE THAN 6 GALLONS OF WATER (DEPENDING ON THE MOISTURE CONTENT OF THE GRAVEL).
- LAY BLOCKS DRY (WITHOUT MORTAR).

BILL OF MATERIALS

BLOCKS - 11 - 12"x8"x16" HOLLOW CONCRETE	POSTS - 3 - 4"x4"x5'-3"
22 - 12"x8"x16" " " FINISHED END	2 - 4"x4"x5'-8 1/2"
9 - 12"x8"x16" " " CORNER	
12 - 8"x8"x16" " " FINISHED END	JOISTS - 5 - 2"x6"x7'-1 1/4"
4 - 8"x8"x16" " " FINISHED END	5 - 2"x6"x10'-1 3/4"
GRAVEL - 6 - CUBIC YARDS - 3/4" CRUSHED BANK RUN	BRACING - 24 LIN. FT. 2"x6"
CEMENT - 12 - SACKS - 1 CUBIC FOOT EACH	NAILS - 3 LBS. - 16 PENNY
BOLTS - 10 - 1/2"x7" WITH EXPANSION SLEEVE OR TOGGLE BOLTS	3 LBS. - 6 PENNY
PLYWOOD - 3 - SHEETS - 4'x8'x3/4"	
BEAM - 2 - 2"x6"x6'-6" NAILED TOGETHER	

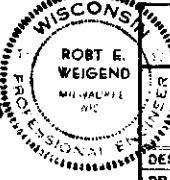

CITY OF MILWAUKEE
CIVIL DEFENSE ADMINISTRATION
105 N. WATER STREET MILWAUKEE 2, WISCONSIN

PREMIUM FALLOUT SHELTER
BASEMENT CONCRETE BLOCK
SIX PERSONS



DESIGNED BY: *Robert E. Weigend*
DRAWN BY: J. HEJNAL
DWG. NO. F.S.S.-1 FEBRUARY, 1961 SHEET 1 OF 1