

# Japan - U.S. Collaborative Smart Grid Demonstration Project

## in Maui Island of Hawaii State: A case study

Hiroshi Irie (Mitsubishi Research Institute, Inc.)

### 1. Introduction

During the period between 2011 and 2016, there had been a smart community project called JUMPSmartMaui (JSM) held in the island of Maui, Hawaii, U.S. With the objective of effective utilization of renewable energy that had been penetrating on a larger scale and widespread deployment of electric vehicles (EVs), a smart community was constructed by Hawaiian and Japanese stakeholders, headed by the New Energy and Industrial Technology Development Organization (NEDO) of Japan.

Smart community is a social system that integrates advanced environmental and energy technologies and provides citizens belonging to the community with sustainable, safe and secure society. In this context, it is important to have a perspective of what value had been provided to citizens by the smart community. Based on this viewpoint, this report summarizes suggestions for future smart community development derived from the activities and results of JUMPSmartMaui, especially from the engagement of citizens (i.e. volunteers participated in JUMPSmartMaui) on EV-related programs.

### 2. Overview of JUMPSmartMaui project

#### 2.1 Energy situation in Hawaii

The island of Maui, which provided the stage for JUMPSmartMaui, is the second largest island in Hawaii with an area of

approximately 1,884 km<sup>2</sup>, a population of approximately 145,000 and tourism as its major industry. The island's electricity is supplied by Maui Electric Company Inc. (MECO) which has the peak demand of about 205 MW.

The islands of Hawaii including Maui have a conspicuous feature in terms of energy, which is extremely high energy cost. Figure 2 shows retail electricity prices by state. It is indicated that the price in Hawaii is significantly high compared with other states in the mainland. This is due to the situation that Hawaii largely depends on imported fossil fuel (especially oil) because of the geographical factor of being consisted of remote islands.

Under such energy scene and with the rise in environmental awareness, the Hawaii Clean Energy Initiative (HCEI) was launched in the State of Hawaii in 2008 and the Renewable Portfolio Standard (RPS) was formalized in 2009. The RPS target was set to 15% by 2015, 25% by 2020 and 40% by 2030. Later, the bill, House Bill 623 (HB 623) set more ambitious goal of 30% RPS by 2020, 70% by 2040 and 100% by 2045.

The State Hawaii has been accelerating introduction of renewable energy. At the same time, it is placing importance on the promotion of EV (electric vehicle) as a solution to move away from the dependence on fossil fuels, particularly oil, and established EV promoting acts including the following:

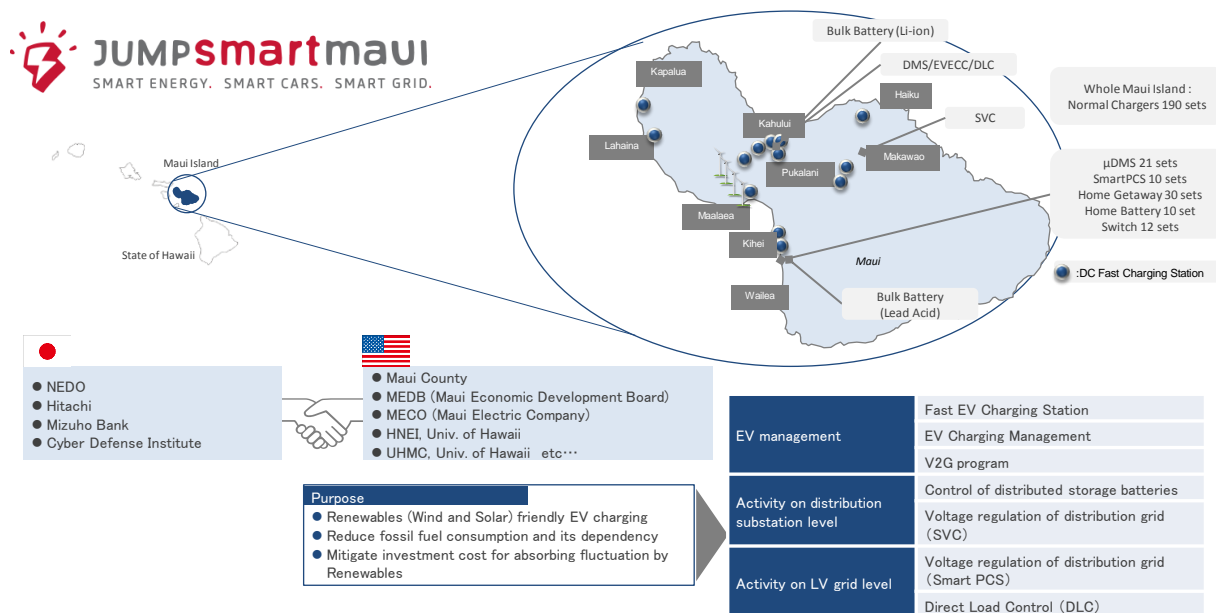

Figure 1 Whole picture of Japan – U.S. Collaborative Smart Grid Demonstration in Maui, Hawaii (JUMPSmartMaui)

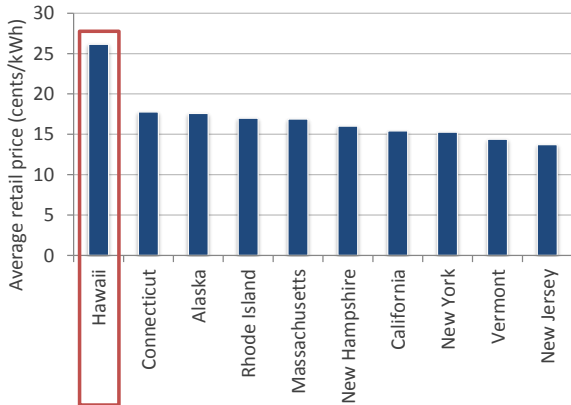

Figure 2 Retail electricity price in US states (Average in 2015. Top 10 states were extracted.)

<Act 168, Session Laws of Hawaii 2012 as an EV law>

- Free parking is provided in State and County Government lots, facilities, and at parking meters.
- Vehicles with Electric Vehicle license plates are allowed access to High Occupancy

2.2 Smart Community System developed in the project

As mentioned above, the State of Hawaii has been placing a priority on the promotion of renewable energy and EV in its energy policy. In order to build a smart community in consistent with Hawaii’s energy policy goals, the objective of JUMPSmartMaui has been specified as below to create a mechanism to sustainably popularize

renewables and EV.

< Objectives of JUMPSmartMaui >

- Renewables (Wind and Solar) friendly EV charging
- Reduce fossil fuel consumption and its dependency
- Mitigate investment cost for absorbing fluctuation by Renewables

An overall structure of JUMPSmartMaui smart community system is shown in Figure 3. In JUMPSmartMaui, management of EVs in Maui and enhancement of power system solutions at distribution substation for Kihei district of the island and at low voltage level are carried out toward the goals. The system that integrates and manages these functions is called Integrated DMS (Distribution Management System). The Integrated DMS develops an operation plan for the entire system in collaboration with other management systems (EVECC, DLC, EMS-Plus and GCS in the Figure 3). The low voltage management system  $\mu$ -DMS is responsible for the management of systems on pole-mounted transformers, controlling components below pole-mounted transformers in conjunction with the plan developed by the Integrated DMS.

There were fast EV charging stations and general resident volunteers participated in the demonstration, and the energy equipment including fast and normal chargers, household electric water heaters, PV-PCS (photovoltaic power conditioning systems), etc. were included in the components below pole-mounted transformers level. The

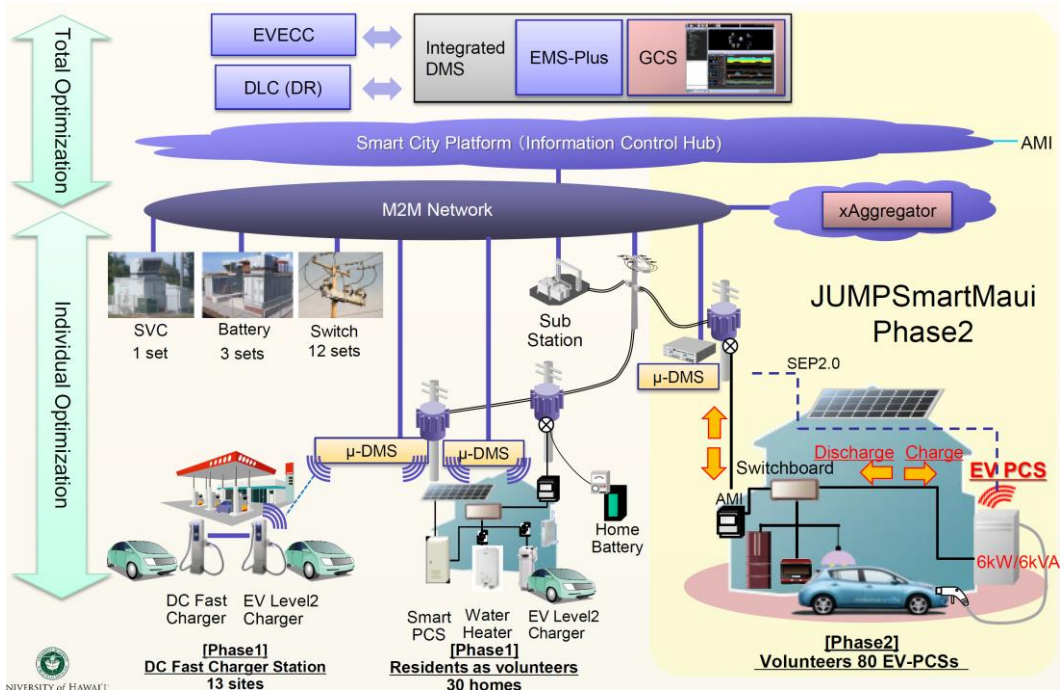

Figure 3 Overall structure of JUMPSmartMaui Smart Community System

Integrated DMS and  $\mu$ -DMS interact with each other to control these equipment. The Integrated DMS also manages controllers in electric power system such as batteries and SVC (Static Var Compensator).

In JUMPSmartMaui, demonstrative experiments for various energy services in smart community were carried out using the system where different functions are interlinked. Figure 4 shows the contents and schedule of this project. The project period was broadly divided in two phases: Phase 1 for the period between October, 2011 and March, 2015; and Phase 2 between April, 2015 and February, 2017, with each phase implementing different type of demonstration. Placing an importance on the interaction between the citizens and smart community, this case study features in three EV related programs where volunteer participants played central roles in the demonstrations. These programs will be described in the following section.

**< Three programs focused on in this case study >**

- Fast EV charging station program
- EV charging management program
- V2G program

The main contents of JUMPSmartMaui other than these programs are described here briefly. For the details of these activities, please refer to the reference materials [1] and [4].

**Direct Load Control (DLC)**

Direct Load Control (DLC), the program to control electric supply to load from outside, was implemented in Phase 1. The load in this context includes EV (to be described later) as well as electric water heaters installed in households. Figure 5 shows the DLC scheme of electric water heaters of 30 volunteers in Kihei district. The daily operation schedule of the electric water heater to be controlled was

planned taking into consideration the effective use of electricity generated by renewable energy and the reduction of peak demand of the electric power system. This is called planned adjustment operation. Also, when sudden power supply shortage is occurred, such as sudden drop in wind generation output, electric water heaters receive the signal and interrupt the power consumption. This is called emergency adjustment operation.

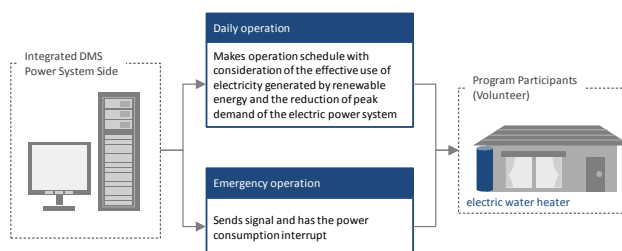

Figure 5 Structure of Direct Load Control program

**Control of distributed storage batteries**

Two large storage batteries were used in JUMPSmartMaui to demonstrate control from Integrated DMS. Two batteries were (1) lithium ion battery installed in University of Hawaii Maui College and (2) lead acid battery located at a sewage treatment facility in Maui County.

Two applications are used for the control of batteries. One is Scheduling Mode to utilize surplus power from renewables. With this scheduling, charging time is determined based on a surplus power forecast developed in EMS-PLUS, and the discharge time is set as 18 to 21 hours. Integrated DMS schedules these charging and discharge time of each battery.

The other application is Emergency Operation Mode to be dispatched by the Integrated DMS to mitigate frequency fluctuations caused by imbalance of supply and demand.

		FY2011	FY2012	FY2013	FY2014	FY2015	FY2016
EV management	Fast EV Charging Station		Design & manufacture	Install	Operation		
	EV Charging Management		Design & manufacture	Install	Operation		
	V2G program				Design & manufacture	Install	Operation
Activity on distribution substation level	Control of distributed storage batteries		Design & manufacture	Install	Operation		
	Voltage regulation of distribution grid (SVC)		Design & manufacture	Install	Operation		
Activity on LV grid level	Voltage regulation of distribution grid (Smart PCS)		Design & manufacture	Install	Operation		
	Direct Load Control (DLC)		Design & manufacture	Install	Operation		

Figure 4 Activities and schedule of JUMPSmartMaui

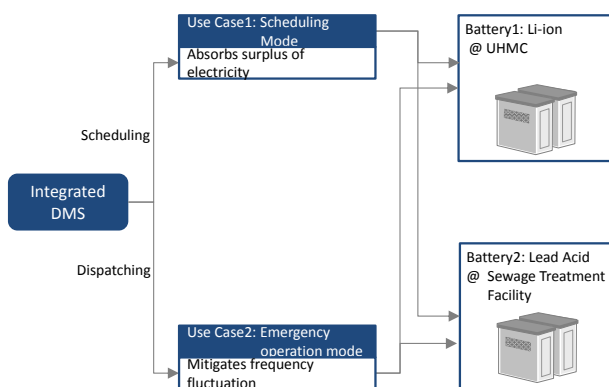

Figure 6 Controlling distributed bulk battery energy storage

**Voltage control of distribution system**

JUMPSmartMaui provides a solution for local grid issues like voltage fluctuation, reverse flow and overload in distribution system. One of them is “SmartPCS,” which enables the active and reactive power to be controlled by PCS (Power Conditioning System) of PV installed in a residential house in accordance with the voltage fluctuation. In addition, voltage control device, SVC (Static Var Compensator), was installed at the point where the voltage tends to be particularly unstable to control such voltage.

**2.3 Recruiting demonstration volunteers**

The demonstration started off with the recruitment of volunteers to involve the public to be part of the project which focused on EV and Direct Load Control. Maui Economic Development Board (MEDB), an NGO of Maui, and Hitachi’s local subsidiary in Hawaii took care of the recruiting activities.

Building trust in the community for Hitachi, the stakeholders and the project was a priority. MEDB and Hitachi conducted numerous interviews with Maui residents to understand their current perceptions, priorities and concerns about energy. Using that information, the stakeholders created a volunteer recruitment plan for the project and carried out specific activities described below.

**Branding of the project**

In general, energy is difficult for the non-expert to understand because of the technical jargons and complicated theories. Also, the understanding for new technologies like renewable energy and EV has not spread enough in Maui at that time, therefore some people were still skeptical about them.

With such background, an effort to create a brand that residents can become familiar with was implemented with the objective of raising Maui people’s interest in the project. After discussions, the project was named “JUMPSmartMaui,” because it is easy to remember, has an

impact and represents the characteristics of the project. (“JUMP” stands for Japan-US Maui Project.) At the same time, the citizens-friendly project logo was designed (See page 1), which was used consistently until the end of the project, strongly impressing the volunteers together with the project name.

In addition, the presentation materials and web pages were uniquely prepared to help volunteers better understand a series of highly sophisticated demonstrations of the project. As shown in Figure 7 and 8, which show a flyer and a webpage used for recruiting volunteers respectively, they were designed to reach the public directly without using abstruse jargon.

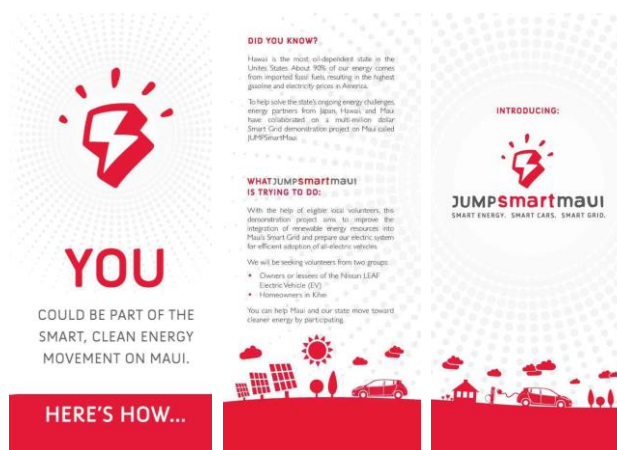

Figure 7 flyer for volunteer recruitment

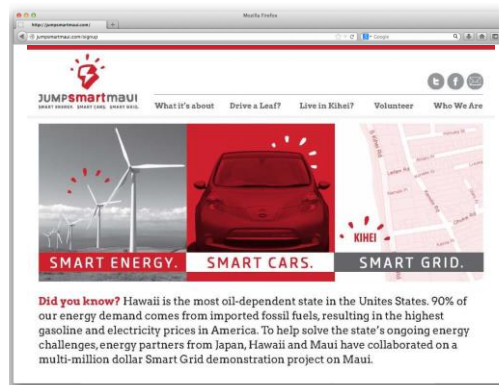

Figure 8 JUMPSmartMaui Website

**Volunteer Recruiting Event**

For the purpose of spreading the name of JUMPSmartMaui to all over the island, various promotion activities had been held using TV, radio, newspaper and SNS (Facebook and Twitter). However, the most effective approach to recruit volunteers was the events specially organized to directly promote the project’s appealing points.

The first was the Launch Event held at the Queen Kaahumanu Center, the largest shopping mall on Maui, on June 15, 2013. In addition to the speeches given by the County Mayor Mr. Alan. M. Arakawa and other project-related representatives, there were programs including live

music by Maui native artist “Willie K”, art design contest featuring clean energy, demonstration of fast EV charger installed in the shopping center organized. The event saw a great turnout with more than 400 visitors of residents.



Figure 9 Snapshots from the Launch Event

The Membership Kickoff Event for Fast Charger was held on September 21, 2013, and on October 6, 2013 the project members participated in the parade of Maui Fair, the largest event in Maui, in EVs carrying the project logo.



Figure 10 At the parade in Maui Fair

A ceremony to commemorate the commencement of the project was held on December 17, 2013, the day when the whole system commenced the operation as a project. This day was officially designated by the State of Hawaii as JUMPSmartMaui Day.

All these events were designed to make JUMPSmartMaui fit well in with Maui. Project organizers were able to attract attention of many residents by holding these activities as Maui local events instead of having one-sided communication with people from the organizer side.

#### **Finely-tuned responses to those who expressed interest**

People who wished to become volunteers were asked to fill out the Interest Sheet, and a briefing session was held for those who showed interests at a later date. MEDB took excellent care of the candidate volunteers to have them fully understand the project.

For those who could not attend the briefing, MEDB and Hitachi members made individual visits to each candidate. MEDB provided personal attention to each prospect and volunteer throughout the

demonstration project, responding promptly to every inquiry during the demonstration. By taking good care of each individual volunteer, MEDB won and maintained their confidence and trust.



Figure 11 Potential volunteers filling out of Interest Sheet and at the Briefing session

#### **Active involvement of Maui County Mayor**

Another factor that largely contributed to volunteer recruitment was an active cooperation by Mr. Alan M. Arakawa, the Maui County Mayor. Believing that accelerated introduction of renewable energy and EV is the priority for Maui, Mayor have recognized the significance of JUMPSmartMaui from the earlier stage and participated in the event mentioned above.



Figure 12 Mayor Arakawa participating in the demonstration

In addition, his wife rented an EV and participated in this project as a volunteer. The enthusiastic commitment of the County’s Mayor to the project and his efforts to promote the significance of the project had a tremendous impact on the community. Looking back at the time, Mayor commented as follows:

#### **Comment by Mr. Arakawa, Maui County Mayor**

*For me, the community’s benefit is most important. I have been convinced that JUMPSmartMaui is the most effective recent economic development program because it has huge potential of reducing each individual person’s energy cost. It is also a very significant project to maintain the beauty of Maui Island.*

*At first, there were many people who didn’t believe that renewable*

energy and EVs would spread, but I felt compelled to promote how they were important for Maui's future. I am really happy that our efforts produced fruit, the project's success.

Through previously mentioned activities, quite a lot of volunteers participated in the project as shown in Table 1. Each of the programs in Table 1 will be described in the following sections.

Table 1 Number of volunteers participated in demonstration programs (As of the end of the project)

Program	No. of volunteers
Fast EV Charger Program	387
Charging Management Program	197
V2G Program	80

Note: No. of volunteers shows a total number and a person may participate in two or more programs.

### 3. Fast EV Charging Station Program

#### 3.1 Program overview

As mentioned in Section 2.1, the State of Hawaii has a policy to promote EVs. What is important in promoting spread of EV is the development of EV-related infrastructure. With such a sense of purpose, a program to have volunteers use fast EV chargers installed at the Fast Charging Station located in places where people gather such as shopping malls and public facilities was developed for JUMPSmartMaui.

#### Features

- Quickly charges based on CHAdeMO standard.
- Hitachi charger has multiple stands.(Maximum 4 stands.)
- Stand type user terminals save installation space.
- Total max power output of stands is less than 60kW.
- Output power setting of each stand is programmable.



Figure 13 Fast charged installed during the project

Items	Power Distribution Type
Input	3 phases, AC480V (50/60Hz)
Input Capacity	Low-voltage contract :49kW High-voltage contract :68kW
Output Voltage	DC 50V~500V
Output Current	DC 0A ~ 125A (1 stand max)
Output Capacity	15kW/50kW (Max.1 Stand) 15kW (Max.4 Stand) 30kW (Max.2 Stand) 45kW+15kW (Max.2 Stand)
Vehicle I/F	Based on CHAdeMO protocol
Host I/F	Communication capability to the host system (Optional functions : recharging management, billing control)

Figure 14 shows locations of fast charging stations. The number of locations was five as of September 21, 2014, when operation of fast charging station started, and eventually increased to total 13. These locations were selected based on the request of volunteers and on JUMPSmartMaui project team's simulation of EV driving range and actual field investigation.

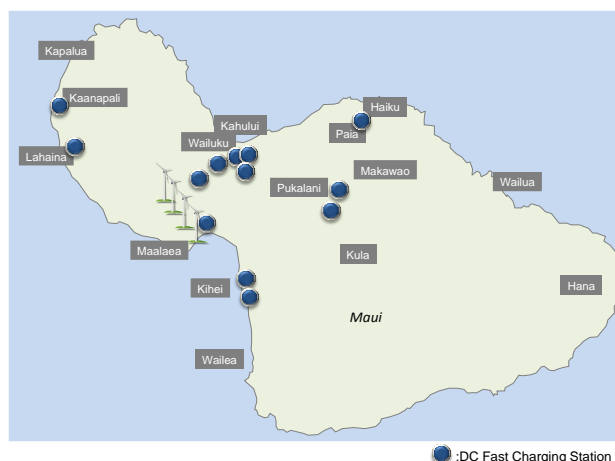

Figure 14 Installation sites of fast chargers



Figure 15 Fast charging station

A person who has EV with fast charging port for CHAdeMO<sup>1</sup> was able to participate in this program. The program participants were able to use charging stations any time during the project period.

#### 3.2 Findings and facts of the Program

Program participants seem to use fast charging stations quite frequently. Figure 16 shows the number of charging times per day at the fast charging stations for the period of three years starting September 21, 2013. Since the program launch, the frequency of use increased over time, observing an average of 120 to 140 times per day after March 2015.

Also, Figure 17 shows change in frequency of use of charging stations by program participants, presenting about 20% of all participants used the charging station at least once a day and about 80% used at least once a month.

For the purpose of preparing this case study, interview was conducted with Ms. Deborah C. Rybak and Mr. Damon Glastetter Michael Santiago, who actually participated in the project as volunteer. As shown below, they both mentioned that infrastructure such as fast charger is indispensable for using EV. In that sense, the demonstration seemed to have met their needs very well.

<sup>1</sup> ChadDeMo is a fast charging protocol and recognized as an international standard of IEC. The shape of charging connector, and charging and communications methods are employed as a standard.

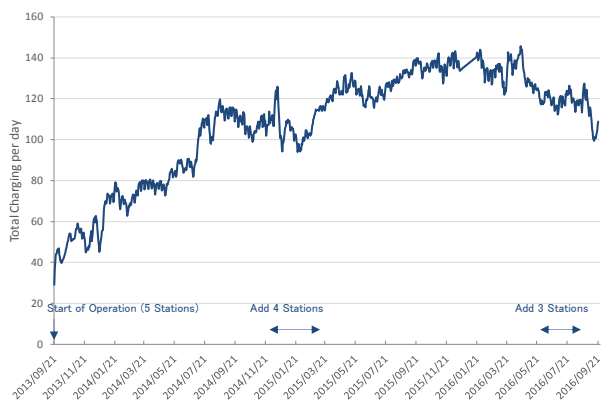

Figure 16 Change in the number of charging times per day (for all charging stations)

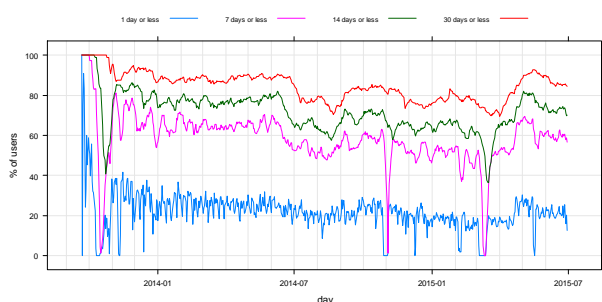

Figure 17 Frequency of use of fast charging station by participants

**Comment by Mr. Damon Glastetter Michael Santiago**

My wife also has a LEAF and uses the Level 3 fast charger when she is running errands in town or when she travels Upcountry or to Lahaina. It is very convenient with several chargers in locations on the way. Many times it would only be necessary to charge for about 10 minutes to get enough charge to complete the journey.

**Comment by Ms. Deborah C. Rybak**

I use the quick charger once a week. It's good and easy because I can connect my car to the quick charger while I'm shopping. With an EV, I can't drive long distance when I use air conditioning in the car. If I can find a quick charger at a destination I don't have to worry about running out of battery. In this way, the fast charger is very convenient and indispensable for EV users. Information about the status of the chargers is shared immediately by MEDB and there are two or more fast chargers at each site. I have no complaints about the demonstration. But it would be better to have more fast charger stations.

In the last part of her comment, Ms. Rybak's mentioned about the request for more fast charging stations, for which Ms. Lory Basa of MEDB, who was in charge of relationship management with volunteers, commented as follows:

**Comment by Ms. Lory Basa**

It was very good to see the participants using the fast charger and having it become a part of their everyday life. There is a limit to the number of fast chargers that can be installed in JUMPSmartMaui, so it is not possible to respond to every request, but it would be a goal to meet these needs in the future.

**4. EV Charging Management Program**

**4.1 Program overview**

It can be said that EV charging can contribute to operation of power system when EV charging is induced during the hours when renewable energy is generating much power but the load is limited. In order to verify the potential of managing EV charging like above, the Charging Management Program was implemented in JUMPSmartMaui in its first phase.

There was a requirement for the program participants that he/she owned or leased a Nissan LEAF (particularly, SV or SL model)<sup>2</sup>, and normal charging stand (Level 2) was installed in participant's house or office.

To charge an EV at home or office, it would be enough to have the charging complete by the time it will be used next time. Charging management in this program was implemented with the concept of "entrusting the start time of charging" to the system side in consideration of the charging end time desired by the program participant.

The charging management system in the program is shown in Figure 18. The integrated DMS that performs charging management creates a charging schedule so as to fill up the gap between the estimated power generated by renewable energy and load of the next day. It then takes account of each EV's connection status to the normal charger and the desired charge end time to instruct the charge start time to each EV.

Normally, EV starts charging as soon as it is connected to the charging stand. With the charging management described above, EV is charged so as to fill in gaps of the supply and demand on the power system. This EV's contribution to electric power system is less burdensome for program participants. Incentive for contribution to charging management has not been set, and program participants were supposed to participate in the form of volunteering.

<sup>2</sup> It necessary to be Nissan Leaf that is equipped with communication module.

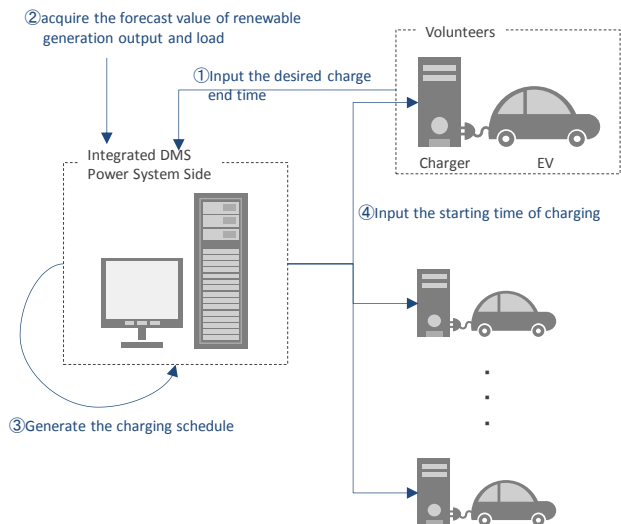

Figure 18 Structure of Charging Management Program

Volunteers can check the actual charging conditions, etc. on the web portal. Figure 19 shows the screen of the web portal.

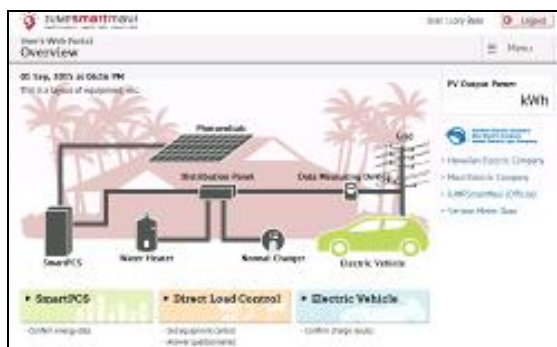

Figure 19 Screen of the charging management web portal

**4.2 Findings and facts of the Program**

Figure 20 shows the state of charge of all EVs before charging management is implemented. The time zone when the EVs are most charged is 7pm-8pm, which is the household’s demand peak.

On the other hand, the time zone the EVs is most charged has shifted to 10pm-11pm as shown in Figure 21 representing the charging status of EVs after the charging management is applied. Therefore, it indicates that the charging management can alleviate power system’s peak.

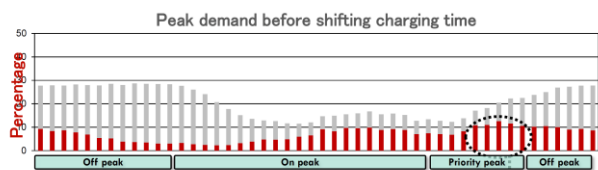

Figure 20 State of charging of all EVs before implementing charging management

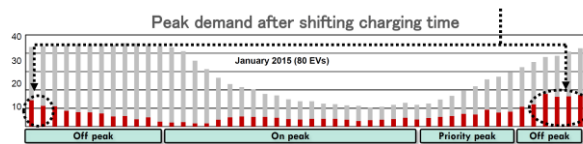

Figure 21 State of charging of all EVs after implementing charging management

The quantitative analysis of the load shift by this program is described in section 6.1. Another important perspective is how the persons who are required to respond to the demand response, i.e. volunteers, think about such load shifting. Mr. Damon Glastetter Michael Santiago thought back of his experience and commented as follows:

*Comment by Damon Glastetter Michael Santiago*  
 The demonstration allowed me to specify the time that I wanted my vehicle to be fully charged. In my case I chose 7 am. That way my car would always be fully charged in the morning so there was no inconvenience in using the battery to discharge.  
 Whenever I arrive home, I simply connect the EV to the charger and the rest was automatic. I didn't have to worry how it was managed as long as it was fully charged the next morning. I have been following experiments like this from all over the world and I understand how it can help stabilize the grid. I believe this type of program should be promoted and expanded.

In other words, this program is considered to be a framework that can provide flexibility to the electric power system without imposing a burden on participants.

**5. V2G (EV discharge) Program**

**5.1 Program overview**

In Phase 2, which began in April 2015, the "V2G Program" has been implemented to further develop the above program to have EVs serve in discharges mode to support the grid.

The participants of this program are required to install a device called EV-PCS that enables EV discharge at home or office.

Basic idea of EV charge and discharge is described in Figure 23. The assumed charge and discharge cycle is the one where EV charges during midnight and during the daytime hours when PV generates much electricity and discharges during the peak hours of early evening. Besides, the program is structured to have EV discharge in emergency situations (e.g. when wind turbine stopped suddenly) to meet the demand and contribute to stabilizing the power system. Such charge and discharge timing is scheduled by the Integrated DMS as in the Charging Management Program described in the previous chapter.

In addition, the EV-PCS installed in this program has a backup



mode; even when power is not supplied from the power system due to a power outage, it is still possible to supply power stored in EV by connecting necessary electric appliance to EV-PCS.

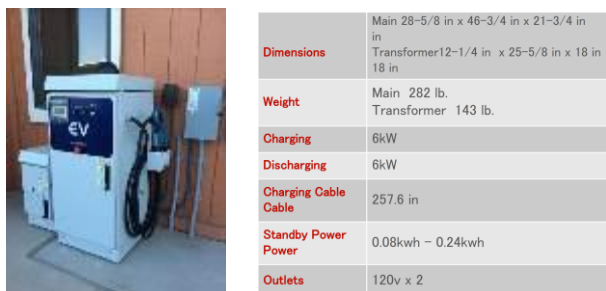

Figure 22 Specifications of EV-PCS

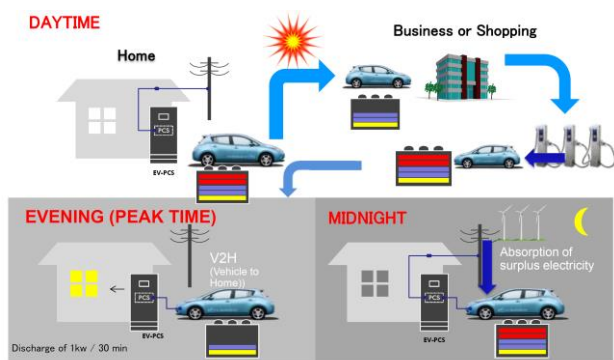

Figure 23 Assumed EV charge and discharge in V2G Program

**5.2 Findings and facts of the Program**

Figure 24 shows the implementation results of V2G program. The red solid line represents the actual result (average over a certain period) of charging of EV performed by each volunteer prior to the program start. On the other hand, the bar graphs of discharge and charge directions represent charging and discharging status of EV during the program period. The charge results show EV charging time is shifting from peak demand hours (18:00 – 21:00) to midnight as in the case of Charging Management Program described in Section 4.2. Moreover, the orange bar graphs in Figure 24 indicates some EVs discharge during peak demand hours to supply electricity<sup>3</sup>. In other words, the results show the V2G Program was operated as intended. How much impact does the results of this V2G and the Charging Management Programs have on electric power system will be discussed in Section 6.1.

The V2G concept of “returning” electricity from electric vehicle to the power system has been studied worldwide together with technical verifications, etc., but there have not been many cases of large-scale deployment where ordinary citizens actually used the V2G function. Mr. Damon Glastetter Michael Santiago who participated in the program as a volunteer mentioned about this program which is regarded as an

<sup>3</sup> Despite EV-PCS can discharge up to 6kW per unit, actual discharge is limited to 1kW or less by the electric company’s current rule on grid connection. In the same way, the time for discharge is also limited to within 30 minutes per discharge during 18:00-21:00.

advanced initiative as follows:

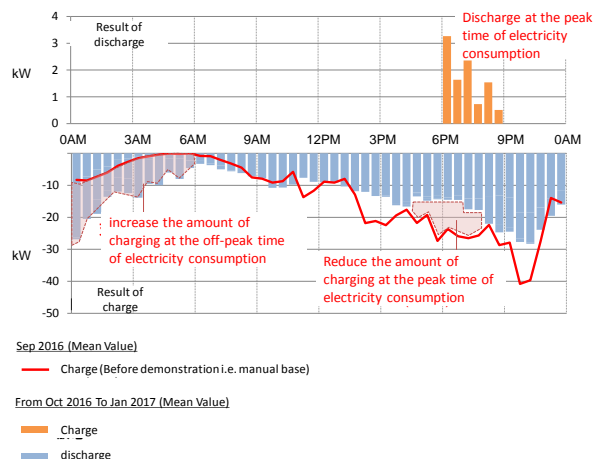

Figure 24 Charging and discharging of EV in V2G Program

**Comment by Damon Glastetter Michael Santiago**  
 I wanted to be involved in this program to get practical experience and to contribute to the solution. I have read about similar programs around the world and I wanted to see it work here in Hawaii. I know that there is a concern that it could accelerate the aging of the battery but I was reassured that this would not adversely affect the life of the battery so I was happy to participate.

Also, another participant Ms. Deborah C. Rybak made a comment as follows:

**Comment by Ms. Deborah C. Rybak**  
 I was interested in taking part in an exciting demonstration. Having heard that it was brand new technology, I was delighted to have been able contribute to such a great project. I believe we should address environmental issues and our participation in the program was our “kuleana” (meaning “responsibility” or “mission” in the Hawaiian language). I did not feel any inconvenience because the program met my preference for the discharging time. I did not think financial incentives were needed because we were doing a good for the whole community without inconvenience.

Although the volunteers who participated in JUMPSmartMaui were very conscious of environmental issues and contribution to community, it is noteworthy that those who were interviewed mentioned that no incentives were needed as long as they felt neither inconvenience nor technical resistance in the project. This point is described in Section 6.2 again.

## 6. Suggestions to future development of smart communities

Focusing on EV-related initiatives, the program content and findings as well as the experience of volunteers participated in the project, which deserve special mention in JUMPSmartMaui, have been covered in this Case Study. Finally, suggestion to future development of smart communities based on the six years' experience is provided below.

### 6.1 Value of EV as distributed energy resource

The Charging Management and V2G Programs described in Section 4 and 5 respectively are the initiatives to utilize EV for the management of the whole electric power system. It has been clarified by the interview with the volunteers that the management method designed in this project was structured to enable customers owning an EV (volunteers) to easily participate in the project without causing inconvenience. As previously mentioned, the overall trend is that EV charging hours are shifted so as to avoid the peak hours and that EV is now able to discharge during peak hours thanks to V2G. Mr. Marc M. Matsuura of the Hawaii Natural Energy Institute, University of Hawaii commented on the demonstration as follows:

**Comment by Mr. Marc M. Matsuura**

*It's been clarified by the demonstration that, with the system constructed this time, EV can provide "flexibility" for the power system. In this respect, I am convinced that the demonstration project is of extreme value.*

However, from the perspective of power system side, uncertainty unique to EV should be fully considered to regard EV as an always available energy resource. EV is a mobile object and is not always connected to the electric power system. When it is fully charged, it cannot charge any more, and when it is out of charge, it cannot discharge. Furthermore, in case of any event where you like to use EV

as an energy resource, the contribution to that event will be cancelled if you drive that EV.

Taking such uncertainty into consideration, the results of estimation on how much effectiveness an EV has as an energy resource are shown in Table 2. Column (E) shows the ratio of the capacity as an effective energy resource to the capacity of EV-PCS. Regarding discharge during peak hours, the table indicates that 14% to 31% of an entire EV can be regarded as an effective energy resource. These values, however, change largely depending on the target time zone. There are few EVs connected to the charger during daytime, and most of the EVs standing by at home are nearly fully charged, therefore it is only 2% to 4% of total capacity that can be regarded as the effective energy resource. However, these values are obtained in the demonstration, and there seems to be room for improvement with a bit of ingenuity. Mr. Shinichi Kasai of Hitachi, mentioned as follows:

**Comment by Mr. Shinichi Kasai:**

*If the number of EVs continues to grow at a rate of recent years, EVs will exceed 30% of total passenger cars in the island by 2045. With this quantity of EVs, MECO will be able to cover about 1/3 of energy resources which they intend to procure from residential customers to stabilize grid for the purpose of achieving 100% penetration of renewable energy sources into local grids. The contribution by EV is therefore quite significant in this context.*

*In this demonstration project, we asked customers to entrust the charging and discharging time to us without incentives and within the scope which does not impose burden on them. In that sense, the data obtained from the results can be regarded as "baseline".*

*It is important to further consider the program design and enhance the value of EV as energy resource. Also, by increasing the number of charging stations at work place etc., the amount of energy resources effective during daytime will increase. Based on the lessons learned this time, we would like to further evolve our solution.*

Table 2 Results of estimation of effectiveness of EV as an energy resource

	(A)	(B)	(C)	(D)	(E)
	Output per EV-PCS	Actual connection condition (%) in the demonstration	Remaining SoC in the demonstration	Capacity with which an EV can be considered effective to be as an energy resource (for 80 EVs) (A)×(B)×(C)×80	Ratio of (D) to the total capacity of 80 EVs
Discharge (peak hours)	6.0 kW	27 - 41%	50 - 75%	67 - 149 kW	14.0 - 31.0%
Charge (nighttime)	5.4 kW	28 - 43%	30 - 70%	36 - 130 kW	8.3 - 30.1%
Charge (daytime)	5.4 kW	8 - 11%	20 - 35%	9 - 17 kW	2.1 - 3.9%
Discharge (early afternoon)	6.0 kW	9 - 20%	70 - 80%	30 - 77 kW	6.3 - 16.0%

Notes) "Remaining SoC" means the percentage of EVs that can charge and discharge during the intended time zone to serve as SoC.

The results are on the assumption that an EV-PCS is able to output 6kW as per the output specifications.

As mentioned above, the demonstration was successful in terms that it verified the concept, and at the same time it gave us hints for further improvement of the service. Mr. David Tester of Maui Electric Company commented on the data obtained from the demonstration as follows:

**Comment by David Tester**

*EVs are in a very important position as a resource of energy management. In this demonstration project, we learned that the concept was effective for our goal and suggested a possibility for new service. There are still many things, such as incentives, that we must consider in the future for the actual deployment, but we could obtain real data from JUMPSmartMaui. There is a big difference between having such data or not. I am truly grateful to NEDO and Hitachi, Ltd. For offering us such opportunities.*

**6.2 Beyond the scope of technical demonstration**

In JUMPSmartMaui, which functioned as technical demonstration, various technologies were developed and verified. According to Mr. Alan M. Arakawa, the Maui County Mayor, this series of activities not only opened up the possibilities of smart community technology but also had a huge impact on Maui.

**Comment by Mr. Arakawa, Maui County Mayor**

*With JUMPSmartMaui, we realized that there is a new technology that is feasible, a smart grid. The efforts made in Maui have led to the common goal of Hawaii to cover 100% of energy demand with renewable energy. As for EVs, some people seemed to have been skeptical about the driving range and performance but having watched people driving EV without a problem they seemed to have wiped out their anxiety for EV. The project gave much larger impact on Maui than expected and contributed to changing the citizens' mind. At first, nobody believed the spread of renewable energy or EVs but now, I am confident that we can share a vision of shifting to these new technologies.*

In fact, the number of EVs on Maui has been increasing since the launch of JUMPSmartMaui. Figure 25 shows the change in the number of registered EVs on Maui Island since 2011. In January 2011, there were only 68 units but reached 800 in March 2017, on which Mr. David Tester of Maui Electric Company commented as follows:

**Comment by Mr. David Tester**

*Though having enormous significance in the technical verification, the greatest success of JUMPSmartMaui was that it increased the actual number of EVs on Maui. Everyone feels that developing EV infrastructure and communicating*

*demonstration experiences have made a big contribution to the promotion of EVs on Maui.*

*As an electric utility, we are interested in utilizing EVs as an energy resources, but this concept would not be realized unless EVs are popularized. The primary significance of this demonstration is that it not only provided technical verification but also created an opportunity to popularize EVs, which serve as the basis for the initiative.*

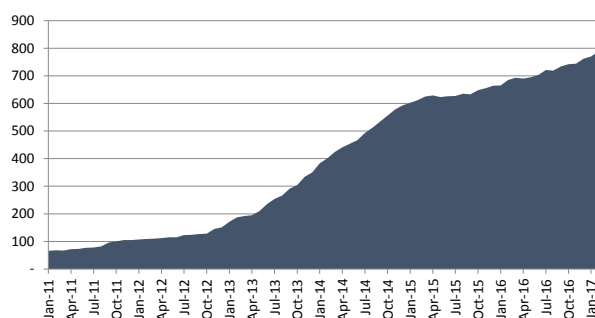

Figure 25 Change in the number of EVs in Maui

In other words, JUMPSmartMaui has played a role as an instigator of the movement of EV spread in Maui, beyond the scope of technical demonstration. As shown in Table 1, JUMPSmartMaui's fast charger program had 387 members, which accounted for about half of the island's EV holders. Ms. Lory Basa from MEDB mentioned as below on expanding the project from volunteers to general residents:

**Comment by Ms. Lory Basa**

*I heard from the volunteers who participated in JUMPSmartMaui that they were sharing their good experiences in the demonstration with other people. I am sure this helped popularize the EV on Maui.*

As mentioned earlier, those who volunteered in JUMPSmartMaui were quite green-minded, but from where did the "good experience in the demonstration" come from? A comment by volunteer Ms. Deborah C. Rybak is quoted below:

**Comment by Ms. Deborah C. Rybak**

*The biggest reason for JUMPSmartMaui being a very good experience for us was the presence of MEDB. Because we had a trustful relationship with MEDB, we could remain positive for this project. They were always friendly when we participated in the demonstration, and we were able consult with them easily whenever we had any troubles during the period. Because they treated us like family, we could feel that we were working toward common goal.*

It can be said that how MEDB treated people from volunteer

recruitment to follow-up during the demonstration won the confidence of the volunteers, allowing them to make the JUMPSmartMaui project a good experience. The head of MEDB Ms. Jeanne U. Skog and Mr. Koichi Hiraoka from Hitachi looked back these days and mentioned as follows:

**Comment by Ms. Jeanne U. Skog**

*The JUMPSmartMaui project has had a lasting impact on us. We worked hard to establish a good relationship between the volunteers and the project. We knew that a positive outcome of the project would be significant for Maui. If the project failed and volunteers did not have a good experience, it would be Maui's residents who would lose from it. It was a priority to carefully orient residents about the project and the partners and to establish trust with them in the project's goals. Giving primary consideration to this, we carefully planned and implemented our activities. I am very happy that our efforts have borne fruit and that we have receive appreciative words from the volunteers. Everyone who volunteered feels like part of our "family" now.*

*Another contributing factor for the project's success is the receptivity and respect of NEDO and Hitachi for our opinions and suggestions. I would like to express my deep appreciation to them for their collaborative spirit as we worked together on the project.*

**Comment by Mr. Koichi Hiraoka**

*In order for Japanese companies like us to be accepted on Maui, it was very important to earn the trust of Maui people.*

*We were advised by MEDB that we needed to work with the residents sharing the same perspective to make the project successful. We therefore tried not only to provide the solution but exhibit our creativity and ingenuity to please local people of Maui and maintain close communication with them.*

*As a result, we received great support from the residents which was far more than we could imagine in the beginning, and I was convinced that our efforts were heading towards success. This initiative is truly a valuable asset for us.*

How the thoughts and activities of MEDB and Hitachi have been linked with the movement of promoting spread of EV on Maui is once again organized in Figure 26. For the field of smart communities and smart grid, the technical aspects are likely to be highlighted. However, the most important is to enrich the life of each and every citizen who constitutes the community. It can be said that JUMPSmartMaui brought about success in providing technical solutions and at the same time had a significant impact, which is more than that of a technical demonstration, for the point that it allowed new technologies of EV and renewable energy to take root in the island and serve as the basis for full-scale popularization.

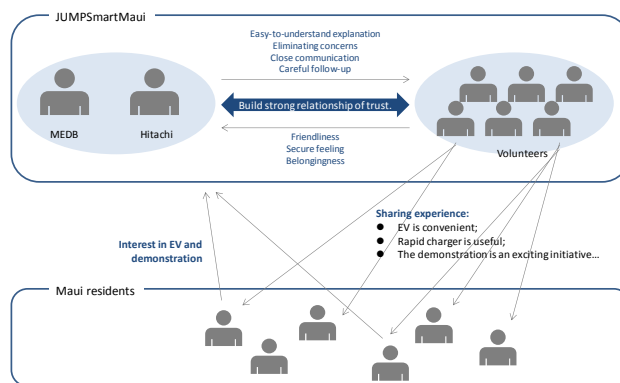

Figure 26 JUMPSmartMaui and the spread of EV

**6.3 Toward further development of smart communities**

The relationship between MEDB and Hitachi was described in the previous section, but such strong relationship of trust has also been built between demonstration stakeholders in U.S. and Japan, on which Mr. Leon R. Roose of HNEI, University of Hawaii and Mr. Fumitoshi Emura of Hitachi commented as follows:

**Comment by Mr. Leon R. Roose**

*I had an impression that the solution provided by Hitachi was in technically high level. In addition, NEDO and Hitachi responded very well despite there were lots of issues in the demonstration, and were quite respectful of our opinion.*

*International demonstration projects tend to be very difficult in terms of differences in language, way of thinking, etc. but in this project, we could overcome the difficulty to build a great system that both Hawaii and Japan are satisfied with,*

*Based on this success, I would like to explore the possibility of further cooperation in the future.*

**Comment by Mr. Fumitoshi Emura**

*I believe that the success of this project is a result of a very positive collaboration with local people. There were difficulties in unfamiliar land, but we couldn't have come this far without kind support of local people.*

In this way, JUMPSmartMaui could achieve success in a limited period of time. The equipment including fast chargers is still located on Maui even after the completion of the demonstration in February 2017, and scheduled to be operated by MEDB and Hitachi. Here is a comment by the head of MEDB, Ms. Jeanne U. Skog:

**Comment by Ms. Jeanne U. Skog**

*Thanks to the initiative of NEDO, a movement of EV spread has been created in Maui. We should further expand this movement.*

*Quite a lot of volunteer have been asking for continuous participation*

*in the demonstration even after the demonstration is finished. We are going to respond to their requests but we must look for a sustainable service model.*

*In order to expand the service that pleases people, we have to further install fast chargers and respond to a wider variety of vehicle types.*

JUMPSmartMaui, which has completed the demonstration, is entering new phase. As pointed out by Ms. Jeanne, the service model will have to be expanded to include flexibility in handling different types of vehicles. In the same way, the technology established in the demonstration this time will need more flexible systems and applications to respond to this trend. Thus, the construction of smart community will continue on Maui Island, triggered by JUMPSmartMaui. At the same time, NEDO will also expand their activities with considering the output and lessons learned from JumpSmartMaui. Finally, the words of Maui County Mayor Mr. Alan M. Arakawa, and Mr. Kazuyuki Takada of NEDO, who is the project manager of JUMPSmartMaui are quoted below:

**Comment by Mr. Arakawa, Maui County Mayor**

*JUMPSmartMaui must be one of the most successful project in the world. It really brought change in people's mind and life.*

*The new concept presented by NEDO and Hitachi has become a trigger for us to consider what we should do further in Maui. I am truly thankful, and it was really nice to cooperate with Japanese stakeholders.*

*We should expand this effort so that the community can enjoy further benefits, and we already have a lot of clues to it. We will continue to strive to improve the energy situation in Maui.*

**Comment by Mr. Kazuyuki Takada**

*It was proved that the raising awareness and gaining residents' cooperation at the community level would be extremely important to realize this model.*

*As PV, batteries and EV being integrated, it would be necessary to broaden the scope of customers' options, for example by enabling customers to choose their own equipment with few restrictions and even allow them to select DR and VPP operators, for further development.*

*It is becoming more and more important to develop the platform for that purpose and I would like to work on this to incorporate the achievements of Maui in the next stage.*

## 7. Acknowledgments

The author gratefully acknowledges the contributions of the following people to this work: Mr. Alan M. Arakawa (Maui County Mayor), Ms. Tokie Ogawa (Maui County), Ms. Jeanne U. Skog and Ms. Lory Basa (Maui Economic Development Board), Ms. Deborah C. Rybak and Mr. Damon Glastetter Michael Santiago (JUMPSmartMaui volunteers), Mr. David Tester (Maui Electric Company), Mr. Leon R. Roose and Mr. Marc M. Matsuura (Hawaii Natural Energy Institute, University of Hawaii), Mr. Fumitoshi Emura (Hitachi Advanced Clean Energy Corporation), and Mr Shinichi Kasai, Mr. Koichi Hiraoka and Mr. Tomoaki Goto (Hitachi, Ltd.).

This Case Study was commissioned by the New Energy and Industrial Technology Development Organization (NEDO).

## 8. Reference

- [1] NEDO, "International Projects for Increasing the Efficient Use of Energy / Japan US Island Grid Demonstration Project in Hawaii", (FY2011 - FY2016) Final Report, 2017 (in Japanese)
- [2] EIA, "State Electricity Profiles" <http://www.eia.gov/electricity/state/>
- [3] "Monthly Energy Data," Department of Business, Economic Development & Tourism, State of Hawaii Website <http://dbedt.hawaii.gov/economic/energy-trends-2/>
- [4] EPRI, "JUMPSmartMaui Demonstration Project Phase 1 Assessment: EPRI Smart Grid Demonstration Initiative"
- [5] Fumitoshi Emura, et al. "Automotive Technologies for Smart Cities and their Global Deployment", Hitachi Review, Vol.95 No.11, 786-790 (2013) (in Japanese)
- [6] Koichi Hiraoka, et al. "Island Smart Grid Model Utilizing EV in Hawaii", Hitachi Review, Vol.96 No.06, 394-397 (2014) (in Japanese)
- [7] Hirotaka Takahashi, et al. "Proposal of Emergency Direct Load Control Algorithm for Maui Smart Grid Demonstration Project," Journal B (Electricity and Energy Sector) of Institute of Electrical Engineers of Japan (IEEJ) 135.5: 310-315. (2015) (in Japanese)
- [8] Interviews with stakeholders by author