

The background of the cover is a dark, textured field of red and orange, suggesting a night sky or a field of fire. A bright, golden-yellow beam of light descends from a star-like object at the top center, passing through a series of faint, overlapping circular patterns and ending at the apex of a large, golden-yellow pyramid. The pyramid is the central focus, with its base resting on a dark, textured ground. The overall composition is symmetrical and dramatic.

The Giza Death Star Deployed

Joseph P. Farrell

DID A HIGH-POWER MASER
UNLEASHED FROM
THE GREAT PYRAMID
ALMOST DESTROY
THE SOLAR SYSTEM?

Here is physicist Joseph Farrell's fantastic follow-up to The Giza Death Star, in which he established that the Great Pyramid was part of a gigantic military experiment to create a Death Star beam weapon. Here he puts forward the theory that the giant chemical maser was eventually deployed - with disastrous results to the solar system!

Farrell takes us from the Giza Plateau to the so-called Pyramids of Mars, and finds evidence of a similar Death Star pyramid there. His theory of galactic destruction also explains the mystery of the asteroid belt.

In this book Farrell explores:

- Exploding Planets
- The Stargate Conspiracy
- Exoteric and Esoteric Investigations of the Great Pyramid
- Dating of the Giza Compound and the Catastrophe
- Evidence of the Use of Weapons of Mass Destruction in Ancient Times

Farrell also provides a Tesla analysis of the putative physics and engineering of the Giza Death Star, and a synopsis of scalar physics and paleophysics. Includes a discussion of quantum numerology, feedback loops and tetrahedral physics, as well.

The Giza Death Star Deployed

The Physics and Engineering Of the
Great Pyramid

Joseph P. Farrell

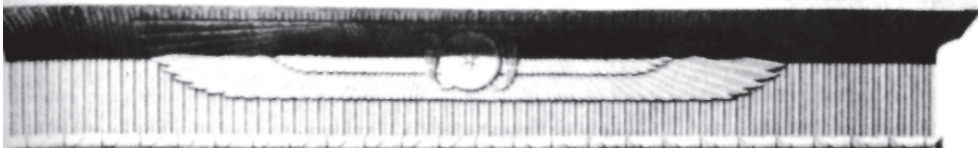



The Giza Pyramid Complex from 4,000 Feet. This unique air photograph of the complex was taken before sunset at an elevation of 4,000 feet. The west slope of each pyramid is shown reflecting the light from the setting sun, and the south slope of each pyramid is in shadow. The south stepped "slope" of the Great Pyramid reveals a V-shaped depression in this photograph. The V-shaped depression, or hollowing-in, occurs in all four slopes of the Great Pyramid—a structural feature that does not appear on any other pyramid in the world.

Contents

Contents	i
Introduction	v
Part One: Scenarios of Deployment	
1. Exploding Planets: The Movie, the Mirror, and the Model	1
A. Some Peculiar Parallels	2
B. Astronomy, Planetary Physics, and Exploded Planets	12
(1) Comets, the Oort Cloud, and the Asteroid Belt	13
(2) Bode's Law	14
(3) Meteorites	14
(4) A Problem with the Exploded Planet Hypothesis	15
(a) The Absence of a Physical Model of Natural Causes of Planetary Explosions	18
2. Dating the Catastrophe and the Compound	24
A. Dating the Giza Compound's Structures	25
(1) The Sphinx, The Great Pyramid, and the Second Pyramid Of Kahfre	25
(2) The Temples and Causeways	31
(3) The Third Pyramid of Menkaure	33
B. The Flood and the Great Pyramid	36
C. Dating the Martian Catastrophe	38
D. Dating the Martian Monuments	38
(1) The Contextual Problem: Reconciling the Dates of the Martian Catastrophe and Martian Monuments	41
E. Dating the Planetary Explosion	43
F. The Weirdly Anomalous Moon	44
(1) Its Age	44
(2) Its Origin	45
(3) Its High Radioactivity	46
(4) Hoagland's "Double Craters"	47
G. Distant Origins of Man and Civilization	48
H. Conclusions	51
(1) Contraindications	52
(2) Supporting Factors	53
Part Two: A Brief History of the Exoteric and Esoteric Investigations of the Great Pyramid	
3. Newton's Gravity and Pyramid Measures: A Brief History of the Exoteric Scientific Investigation of the Great Pyramid	60
A. Howard Vyse's Forgery and Military Connection	62
B. Greaves	65

C. Newton, Taylor, and the Pyramid Units of Measure	67
D. Smythe, Petrie, and Davison	69
E. The Strange Anomaly of Dr. Luis Alvarez	73
(1) First Observation of the Great Pyramid's Acoustic Amplification Properties	75
F. Conclusions and Corroborations	75
4. Secret Societies, Psychics, Spies, Soviets and Scalars: A Brief History of the Covert and Esoteric Investigation of the Great Pyramid	11
A. No Machines Please!	77
(1) Criticism of Sitchin' s Handling of Texts	78
(2) The Mystifying Silence and a Personal Aside	79
B. The Stargate Conspiracy	79
(1) Primitive Dogon Quantum Mechanics?	81
(2) The Lost Hall of Records	83
(3)Enter "the Psychic": Edgar Cayce: His "Terrible Mighty Crystal" and "Fire Stone"	92
(4) Enter Dr. James J. Hurtak	95
(5) Enter Richard Hoagland	96
C. The Scalar Weapons "Triad Nations": The Berlin-Tokyo Scalar Axis	99
(1) The Soviet Union' s Scavenger Hunt	104
(2) France (Infra)Sounds Off	112
(3) World War Two: the Ideological Problem for Science in Germany	112
D. A Brief Mention of a Weapon Function for the Great Pyramid	131
E. Conclusions	134

Part Three: A Tesla Analysis of the Putative Physics and Engineering of the Giza Death Star

5. Message? Or Machine? A Precis of the Weapon Hypothesis	141
A. Five Hypotheses, Two Models, and a Method	141
(1) Weaknesses of the Message Model	142
(2) The Machine Hypothesis	145
(a) The Weakness of the Observatory Hypothesis	145
(b) The Weakness of the Power Plant Hypothesis	145
(c) The Weapon Hypothesis	147
(d) A Method	147
B. The Outline of Part Three	148
C. Assumptions	149
D. Models of Weaponization	150
E. The Hypothesized Functions of the Great Pyramid's Component Materials, Geometric and Harmonic Features and Dimensions, Chambers, and Feedback Loops	151
(1) The Selection of Materials Used in Its Construction	151
(2)Its Geometric and Harmonic Features such as Parabolic	

Faces, Squared Circles and Cubed Sphere Geometries	152
(3) The Functions of Its Internal Chambers	153
6. A Tesla Analysis: The Basic Argument for a Weapon Function	155
A. Eric Dollard's Experiments: The Basics of Telsa's High Energy Direct Current Impulse Magnifying transformers and the Wireless Transmission of Power	155
B. The Analogs of the Atomic Weights of the Elements in the Great Pyramid	159
(1) Possible Implications	163
(2) Beyond the Threshold of Stability	164
C. Bearden on the Problem of Isotropy and Anisotropy	165
7. Cohering the Zero Point, Vacuum Energy, Flux: A Synopsis of Scalar Physics and Paleophysics	170
A. Conceptual Foundations of Scalar Electrogravitational Physics:	170
(1) Maxwell's Quaternion Electromagnetic Theory	171
(2) Deliberate Editing by Heaviside?	176
(3) Characteristics of the Scalar Wave	178
(4) Zero-Summed Vector Fields, Interferometry, and Scalar Weaponry	179
(5) Scalar Lasers	184
B. Principles of Zero Point, or Vacuum energy, Coherence	184
C. Scalar Physics and Paleophysics: A Comparison of Principles	190
D. A Comparison of Scalar-Plasma Physics and Known Properties of The Great Pyramid	192
8. Configuring the Scalar Impulse Wave: More Tesla Analysis of the Integrated Engineering of the Giza Death Star	194
Part One: Foundational Concepts	
A. The Tesla Direct Current Magnifying Impulse Transformer	197
(1) Virtual Grounds	203
(2) And the Base Planetary, Stellar, and Galactic Systems	204
(3) Coupling of the Three Types of Standing Waves	204
B. Thomas Townsend Brown and the Stages of Dielectric Displacement	205
(1) As Quantized States?	209
(2) The Space Warp, Quantized Macrosystems States, and The Philadelphia Experiment	212
C. Radioactivity in the Open Systems Paradigm: LeBon's "Photo- Aetheric Effect"	214
(1) Element-Ray Interaction	214
(2) Crystals as Wave-Guides	216
D. Infrasound Again	217
E. Farnsworth's Virtual Electrodes and Hot Fusion Plasma Containment	219
F. Inferred Physical Postulates	220
Part Two: Inferred Applications In the Great Pyramid	
A. The Queen's Chamber: Hydrogen Generation	222
B. The Grand Gallery:	222

(1) Gravito-Acoustic Infrasound "Organ Pipe"	222
(2) The Missing Gravito-Acoustic Resonator Arrays	226
C. The Antechamber: Infrasonic Baffle	227
D. The King's Chamber	228
(1) Tertiary Tesla Coil, and Possible Plasma Pinching: Harmonic Piezoelectric Stressing and Amplification	228
(2) The Coffin: Cohered Optical Cavity	229
E. The Stone Courses of the Pyramid	230
(1) Secondary Coil Windings: Crystal Lattice Structure	230
(2) Periodic Atomic Weight Resonance	231
F. The Parabolic Faces: Focus and Collection of Base Stellar and Galactic Systems' Waves	231
G. The Apothem: "Virtuals Leads"?	232
H. The Missing Apex Crystal: Dielectric Antenna	232
I. The Selection of Calcium Carbonate (Limestone) Casing Stones	233
9. Quantum Numerology. Feedback Loops, and Tetrahedral Physics	234
A. Nested Harmonic Feedback Loops as "Virtual Coil Windings" and "Lattice Structure": Geometric Amplification	234
(1) The Feedback Loops, or "Virtual coil Windings" or "Virtual Lattice Structure" of the Total System of Inner Chambers Based on Harmonics of Planck's constant (Engineered Theoretical Value of 6626) and the Sumerian Ratio of 6:8::9:12	235
(2) Dimensional Measures of the Outer Structure and Planck Unit Harmonics	237
(3) The Odd Recurrence of the Number 26	240
(4) Harmonics of the Planck Units in the Pyramid's Analog of The Earth's Polar Radius	241
B. "Tetrahedral" Physics	243
(1) The Zero Summed Vector Matrix of the Initial State of The Medium and its Cosmological Implications	243
(2) The First Platonic Solid: Spherically Embedded Tetrahedra	244
C. Conclusions	262
10. The Power of Shapes and the Fire Within	265
11. The Other Pyramids	273
A. Dashur: the Standard Egyptological Explanation	274
(1) The Red and Bent Pyramids	274
12. Conclusions	281

INTRODUCTION

After my initial, and to me horrifying, discovery of harmonics of Planck's constant in the Egyptian initiate Plato, and in the Great Pyramid itself, I fully intended to write a rather simple sequel to my previous book, *The Giza Death Star*, extrapolating on some of the implications and principles of my hypothesis that it was a weapon of mass destruction. Accordingly, I proceeded on the basis of the hypothesis that its physics was unified and engineerable. On the basis that it was engineerable, I then made certain suppositions about what components had to have been present in the structure in order for it to function as a weapon. In turn, this allowed me to make certain suppositions of what must be looked for and where to look for it. In this sequel I did not originally intend to seek nor look for any more "sensational" discoveries on the order of the Planck discoveries.

But that was not to be. This sequel has since grown to a considerable "revision and extension of remarks" to the *Giza Death Star*. Like all researchers have discovered, the Great Pyramid seems to reveal more and more surprises, the more one looks. An astonishing catalogue of geometric, mathematical, and celestial relationships can be compiled for the Great Pyramid. At a minimum, this compilation has suggested to other researchers that the Pyramid functioned as:

1. An Observatory, or better put, as a physical Observer;
2. An encoded Library of fundamental physical and geometric relationships;
3. A Time Capsule (or in some variants, a Prophecy in Stone) designed to embed and encode knowledge for secure transmission through millennia to succeeding generations.

However, if one accepts the hypothesis that the Great Pyramid was more than these things, i.e., if one accepts that it was a machine of some sort, then the close tolerances and mathematical relationships between the known components and dimensions of the structure probably mean something entirely different. In that case, they may indicate something about the function that the machine performed; they are a clue as to how these diverse components were integrated and for what purpose the structure was designed and built. The consequence of this view, in Christopher Dunn's analysis, was to understand the Great Pyramid as a coupled harmonic oscillator.

Introduction

But oscillating what?

Taking his analysis a step further, in *The Giza Death Star* I posited that the interior structures and dimensions of the Great Pyramid coupled to dimensions on its exterior, and to systems not even found on this planet. This implies that whatever processes that were engineered to occur inside the Pyramid were designed to be transmitted outside it, and vice versa. In simple terms, the function of the Pyramid as a harmonic oscillator seemed to posit a physics beyond what Mr. Dunn was suggesting. In that book I suggested that the Great Pyramid was a special kind of oscillator, being both a phase conjugate mirror - gathering and amplifying the "harmonic signature" of its various targets - and also a phase conjugate howitzer - a "scalar laser", not only amplifying but cohering that harmonic signature and reflecting it back upon its selected targets for their total obliteration.

Accordingly, as I read further and further into the areas of little known contemporary physics research, more and more intriguing correlations became evident. Mathematical relationships uncovered by Tesla in his electrostatic impulse experiments, by Hoagland in the Cydonia ruins on Mars, and similar relationships in the Great Pyramid seemed to confirm my hypothesis - advanced in *The Giza Death Star* - that the Great Pyramid's underlying unified physics was achieved by engineering approximations of fundamental physical and geometric relationships.

The correlations seemed to grow even more as I investigated the parallels between Eric Dollard's exposition of Tesla's electrostatic impulse magnifying transformers, their underlying theory, and the Pyramid itself. Discovering that Tesla speculated that atomic weights or other properties of the elements of the periodic table seemed to be related to his oscillating impulse phenomenon drove me to look for some analog of that in the structure, and it was not long before I discovered it exactly where one would have suspected, in the "windings" of the "secondary coil," the stone courses of the Pyramid themselves.

Careful analysis of the structure and the nested harmonics of the Planck units led to confirmation of my hypothesis that not only was it a coupled harmonic oscillator, but that it was constructed of several smaller such oscillators, all nested within a precisely engineered set of feedback loops driving its "gravito-acoustic" energy to the King's Chamber.

Deciding to leave no stone unturned (not to coin a pun), I decided to investigate the movie *Star Wars* itself, including the vast amount of books and peripheral spin-offs. Here, much to my surprise, I discovered a rather

The Giza Death Star Deployed

upsetting series of parallels, the most unsettling of which was that exploding planets seemed to be not only part of the mythology of that science fiction movie classic, but of the lore both of contemporary solar system astronomy as well as of ancient Sumerian and Egyptian religions. I had to conclude that either the movie classic and its sequels were brilliant exercises in Jungian archetypes, or that they were carefully contrived and executed studies in propaganda, a "controlled release" of information the central theme of which was a struggle against a tyrannical regime and the superweapon on which its power and hegemony rested.

Further investigation of the Pyramid's researchers and their theories convinced me of yet another peculiar thing: that besides Dunn's *The Giza Power Plant* and my previous book, *The Giza Death Star*, few people seemed to be viewing or writing about the Pyramid as a machine. A concerted effort seemed to be underway to misdirect attention away from any possible consideration of the Pyramid from the point of view of that hypothesis. It was not long before I uncovered a whole nest of esoteric and covert interests investigating the structure. As outlandish as I initially considered my own weapon hypothesis to be, it seemed to pale by comparison to some of the hypotheses being advanced in certain circles. It was almost as if an effort were being made to prevent anyone from investigating its machine-like properties any further.

The simple scheme I had envisioned for the sequel thus grew from a mere exposition of its engineering to a study of its physics, its engineering, its possible date of construction, the possible scenarios of deployment, and the strange goings on in contemporary research of the structure itself. Hence the current work is divided into three parts.

Part one investigates the Exploding Planet Hypothesis in contemporary astronomy, and explores the many issues surrounding the dating of the Giza structures, all with a view to reconstruction of possible scenarios of the actual military use of the weapon. The Giza Death Star might once indeed have been used to explode a planet and wreak untold amounts of destruction on others, including our own

Part Two surveys the strange history of modern investigation into the structure, a history almost as strange as the Great Pyramid itself. Why, for example, did no less a personage than Napoleon Bonaparte lead an expedition of thousands of French soldiers, accompanied by scores of France's finest scientists, archaeologists, linguists, and scholars, to Egypt, seemingly for the express purpose of wresting control of the plateau from

Introduction

the Ottoman Turks and studying the compound? That the expedition seems Masonically inspired appears to be obvious. But what were Napoleon's "hidden masters" after? More recently, allegations have been made that a mercenary team of "U.S. government retrieval specialists" forced their way into hitherto unknown underground chambers where they not only discovered explosive "booby traps" of "great antiquity" but also some sort of machine. As we shall discover, strange associations abound between practitioners of what can only be called "occult science", Pyramid research, and the various intelligence, military, and space agencies of certain governments.

Part Three explores the physics and engineering of the Giza Death Star in the detail suggested by, but not explored in, my previous book *The Giza Death Star*. Those readers familiar with that book will recall that its primary interest was on the paleophysics that might have been behind the structure. In this book, the emphasis is rather on the engineering of the structure, explored in terms of contemporary experimental and, where applicable, theoretical physics. An attempt is made to reconstruct the theoretical outlines of that physics based on the implications of the structure and its engineering itself. An attempt is made to model some of the mathematics of the more basic concepts.

Because there will inevitably be a certain type of excitable readership of these two books who will conclude that a definitive case has been made, it must be reiterated in the strongest possible terms that the case presented here and in *The Giza Death Star* remains only an hypothesis. The case has not been advanced to the level of theory, much less corroborated by any experiment, though I do offer limited suggestions - to the reader careful enough to notice them - as to how experimental verification of certain features of the hypothesis might be obtained. But as it stands - notwithstanding what I believe to be compelling corroborative evidence in some particulars - the case remains only on the level of hypothesis. And it remains an outlandish hypothesis, no more so, certainly, than all those of "stargate," "prophecy in stone," "resurrection machine," "communications device," "observatory," "power plant," or -the most outlandish of them all - "pharaonic tomb built by Egyptians," but by the same token, certainly no less so.

That caveat lector on the record, I remain curiously ambivalent about my "discoveries." Like all investigators, journalists, historians and explorers of the anomalous, I have experienced that ticklish thrill that

The Giza Death Star Deployed

anyone experiences when their hypothesis seems to be increasingly confirmed by data. But in this case, the hypothesis in view is that this structure was a weapon of mass destruction of extraordinary power and sophistication. That the Great Pyramid was built at all is incredible; that it was a machine, perplexing; that it was a weapon, monstrous; that it was used; horrifying. So my ticklish thrill of excitement over discoveries speculated upon and subsequently found and confirmed is considerably moderated by the sickly, bittersweet feeling that this structure represents the ultimate evil use of the primal forces of nature, of forces far more powerful than the terrible thermonuclear energies of our own hydrogen bombs, the very force of the configuration of space and time itself.

Joseph P. Farrell Tulsa, Oklahoma
2002

A digitally restored and contrast enhanced subscene of NASA Viking Frame 35A72 of the planet Mars showing the pyramids on the left. Courtesy of Mark Carlotto.

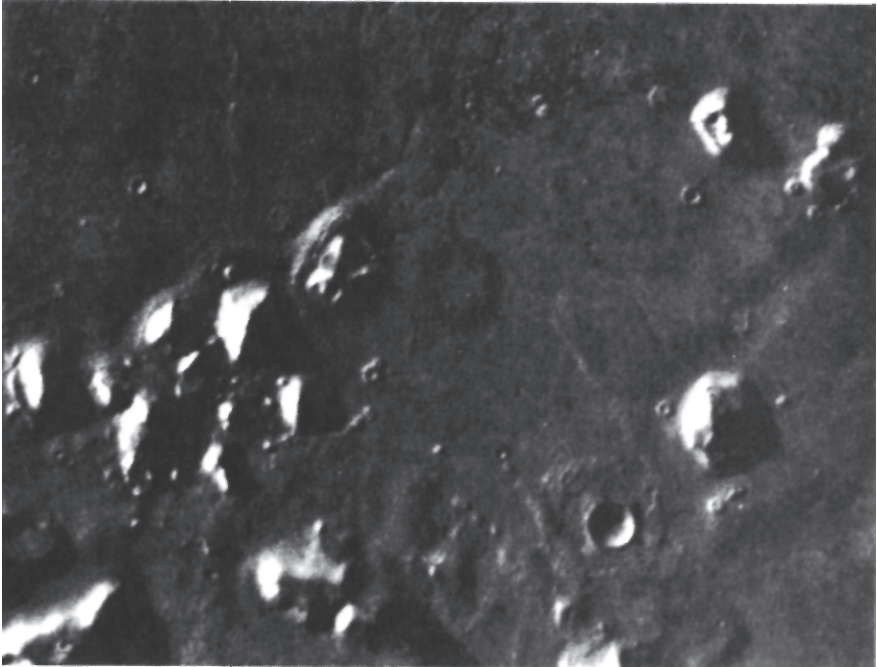

THE GIZA DEATH STAR DEPLOYED:
PART ONE:
SCENARIOS OF DEPLOYMENT



The Sphinx and Pyramid.

1.

EXPLODING PLANETS: THE MOVIE, THE MIRROR, AND THE MODEL

"His eyes glowing beneath the black brows, he said that he had already conceived of a plan for transmitting energy in large amounts from one planet to another - absolutely regardless of distance. "

Margaret Cheney, *Tesla: Man out of Time*¹

Millions of movie-goers around the world well remember the scene. Perhaps they, like I, felt their stomachs knot up into that queasy sense of anxiety as the background music grew somber, knowing something terrible was about to happen. The artificial moon parked itself nearby the planet Alderon. Jack-booted Grand Moff Tarkin clasped his hands behind his back and gave the order, and immense complex machinery swung into motion. Gigantic lasers converged at a point in front of the moon's huge parabolic indentation, merged into one beam, flashed through the blackness of space, and literally blew the entire planet apart in a matter of seconds.

This scene from George Lucas' science fiction classic, *Star Wars*, was, for me, an unforgettable experience. Home safely from the movie that night, those millions, like I, perhaps slept peacefully, having been lavishly entertained with the final defeat of the villainous Darth Vader and the destruction of the terrible "Death Star." After all, building such huge lasers - large enough to blow up planets - while theoretically possible perhaps, was well beyond the technological and economic capability of the world. The likelihood of such weapons ever being built was as unlikely as...well, as a gigantic asteroid hitting the earth and obliterating it. If planets explode, it is far more likely that they do so by some such accident or act of God than it is for someone to possess the technology to press a button and blow one up. And even if someone possessed such technology, who would be so morally bankrupt as to deploy and then actually use it? The whole scenario is improbable, the stuff of Hollywood, not of history, and certainly not of physics.

¹ Margaret Cheney, *Tesla: Man Out of Time* (New York: Laurel-Dell, 1981), p. 240.

Exploding Planets

A. Some Peculiar Parallels

However there are some intriguing parallels between the physics of scalar interferometry, and the fictional "Death Star" of Star Wars and the schematics of that weapon contained in one of the movie's spin-off books, *Star Wars Incredible Cross Sections: The Ultimate Guide to Star Wars Vehicles and Spacecraft*, by David West Reynolds and illustrated by Hans Jenssen and Richard Chasemore.² This book boasts that it was compiled with the assistance of the Lucasfilm Archives. That implies a measure of "sanction" to their artistic renditions of details not captured in the film itself. Taken together, these peculiar parallels suggest that perhaps there might have been more going on in the movie than merely good entertainment.

The parallels between the fictional "Death Star" of the movies and the putative physics of the actual Giza Death Star suggest that someone, somewhere in the production staff of Star Wars was giving out more than just fanciful artistic renditions of what blowing up a planet with directed energy beams might require:

- (1) The fictional Death Star directs several beams to converge into one beam, which obliterates the target planet. The Giza Death Star, it was posited in my previous book, relied upon harmonic interferometry to direct its impulses to target. Interferometry uses several beams, or a split beam, merging in one area, as in the Michelson-Morley experiment. The Giza Death Star utilized a superluminal "pilot" or "scalar wave" as a carrier wave to carry several other types of waves - electromagnetic, acoustic, gravitational - to target. In the simplified artistic graphics of the film, this is what one sees.
- (2) The film's fictional Death Star had a large parabolic dish, which suggests that the fictional weapon somehow collected and then amplified the harmonic "signature" of the target, directing it back upon itself. This too is a hallmark of "scalar" waves. And of course, one of the unusual features of the Great Pyramid is

² Cf. chapter 7, "Cohering the Zero Point Energy Flux".

The Giza Death Star Deployed

precisely its "parabolic" faces with their slight inward curvature along the apothem.

- (3) The film's "Jedi Knights" carry "light sabers," exotic, if not somewhat Quixotic, weapons. In actual fact, a "scalar wave" folded in upon itself would produce a similar standing column of electromagnetic energy that would slice through anything it came into contact with.

But the Incredible Cross Sections book contains even more suggestive material that never made its way into the film. A list of the explanatory notes on the cut-away schematic and perspective drawing of the weapon contains numerous parallels with the basic physics I believe was actually operative in The Giza Death Star:

- (4) The "Hypermatter Reactor" of the fictional weapon suggests a process of hyperdimensional reactions is used to power the device. A similar interface of nuclear and other forms of normal energy with hyperspatial energies was posited for the Giza Death Star.
- (5) The "Primary Power Amplifier" of the fictional schematic appears to be nothing but collections of long hollow tubes or pipes, like an extremely large pipe organ. This suggests that there is an acoustic component of the fictional weapon that is one of the primary means of loading enormous amounts of deadly cavitating energy into its target. Both Dunn and I hypothesize that the amplification of acoustic energy was the primary function of the Grand Gallery in the Great Pyramid.
- (6) The "Induction Hyperphase Generator" of the fictional machine implies that a hyperdimensional wave-form such as a "scalar wave" is being accessed to direct the other, more conventional, energies to its target. A similar wave-form was posited as the carrier wave for the Giza Death Star.
- (7) The "Tributary Superlaser Beam Shaft" implies that several wave forms are combined and directed by a carrier wave to the target for the purpose of oscillating all forms of energy resonant to the target. The "Carrier Beam Crystal" - which incidentally is red, suggesting corundum or ruby, and therefore a gravitational component - confirms this analysis. Precisely such

Exploding Planets

crystals were posited on the basis of the engineering present in the Grand Gallery and numerous esoteric texts confirming the presence of crystals at a remote time within the Great Pyramid, itself a crystalline structure. (8) Finally, the obvious is not to be overlooked. The fictional weapon used a cohered electromagnetic energy output in the form of gigantic lasers. In Dunn's analysis of the Coffin inside the King's Chamber of the actual Giza Death Star, he concluded that it had all the properties of an optical cavity for a maser.

So it would appear in the final analysis that the only real difference between the Star Wars Death Star and the real one at Giza lies in the movie's rather fanciful notion that the main "punch" of the weapon was in its cohered electromagnetic output, namely, the laser itself. But it is easy to see why. A "scalar" wave is superluminal, and would therefore be invisible and a rather unexciting thing to watch, so it is easy to see why the movie version used lasers; they have "production value" whereas an invisible wave would not. The phenomenon, at least from a production point of view, is similar to the reason that the sound of explosions in deep space is often added in movies, even though most people are aware that no sound would be heard in the vacuum of deep space.

Strangely enough, the idea of using crystals to split beams and parabolic mirrors to focus them onto a target to destroy it is not a new one. The concept of using split beams and focusing them on a target has a long pedigree, and is not merely the fantasy of a famous science fiction movie. As Robert Temple notes in his important study of advanced ancient optical technology, *The Crystal Sun*, both Plutarch and Livy recorded the use of a superweapon in ancient times, Archimedes's mirror with which he destroyed the Roman fleet besieging Syracuse. In my previous book, *The Giza Death Star*, I pointed out the Mitchell-Hedges Crystal Skull as an example of an advanced optics and crystal-growing technology. Apparently, Archimedes, if not his Renaissance interpreters, were aware of some elements of this science:

From our point of view...the chief importance of Archimedes is that he invented and constructed a very large and deadly weapon to defend his city against an attack by the Roman fleet. The weapon was a multiple-mirror

The Giza Death Star Deployed

capable of reflecting the rays of the Sun in concentrated form and creating the first 'death-ray' in history. For Archimedes' Burning-Mirror succeeded in setting fire to many Roman ships as they were attacking Syracuse. It was therefore a direct ancestor of the laser-beam weapons of today.³

The record of Archimedes' feat engaged the imaginations of Byzantine Roman, and later, Renaissance scholars and scientists, impelling them to re-create the weapon.

Anthemius of Tralles, the great Byzantine architectural and scientific genius, was the first who not only apparently succeeded in recreating Archimedes' weapon, but also to expound on the rather complicated geometric arrangement of metal mirrors needed to accomplish it. "For among the few fragments of his writings to survive are portions of his important work, *On Mechanical Paradoxes*, containing a full description of the construction of a burning-mirror according to the principles of Archimedes, but greatly improved. In fact, we could describe the burning-mirror of Anthemius as a 'second generation weapon.'"⁴ Anthemius' treatise reads like a modern scientific abstract, leaving little doubt that he knew what he was talking about:

Let there be a plane hexagonal reflector ABTDEZ and other similar reflectors adjacent and connected to the first along the straight lines AB, BT, TD, DE, EZ, each having a slightly smaller diameter and capable of being hinged about those straight lines, the connection being made by strips of leather or by ball and socket joints. If, then, we place the surrounding mirrors in the same plane as the central one, reflection will obviously be in the same direction from each conjoining mirror. Whereas, if the central mirror is left unmoved, and we incline all the surrounding mirrors inwards towards the one at the centre, by a little discovery easily put to use, it is clear that the rays reflected from the surrounding mirrors will be directed to the middle of the original mirror. Then if proceeding in the same way, we arrange other mirrors around those that we have just mentioned, so that they can be inclined towards the central mirror, and then collect the rays in the same spot in the manner described, combustion will occur at the given position.

Combustion will be caused more effectively if fire is produced by means of four or five mirrors, or even as many as seven, if they are distant from each other in proportion as their distance from the point of combustion, in

³Robert Temple, *The Crystal Sun: Rediscovering a Lost Technology of the Ancient World* (London: Century books, 1999), p. 280.

⁴*Ibid.*, p. 291.

Exploding Planets

such a manner that the rays cut each other and produce the desired heating more intensely.⁵

One wonders, could the reference to the sun's rays "cutting" each other be Anthemius' way of expressing harmonic interferometry? However one may answer that question, the quotation also refers to "collecting" the sun's rays, and "intensifying" them by "cutting," almost as if Anthemius were thinking, centuries ahead of time, of the amplification and "stimulated emission" of photons of light, the same basic principle as operates in lasers.

Archimedes' feat lived on past Anthemius. In 1572, a woodcut of his accomplishment appeared as the frontispiece of a Latin translation of a 10th century Arabic work on optics.⁶



⁵ Anthemius of Tralles, *On Mechanical Paradoxes*, in G. L. Huxley, *Anthemius of Tralles: A Study in Later Greek Geometry*, Cambridge, Massachusetts, 1959, p. 6, No. 1 of *Greek, Roman, and Byzantine Monographs*, John J. Bilitz, ed., cited in Temple, *op. cit.*, p. 298.

⁶ Temple, *op. cit.*, p. 306, citing Alhazen, *Opticae Thesaurus*, with Vitellionis *Thurinopoloni Opticae librie decern*, ed. Federico Risner, Basle, 1572.

The Giza Death Star Deployed

The famous Renaissance Jesuit, Fr. Athanasius Kircher, published a similar set of engravings in 1646 to show how multiple mirrors could be focused to burn through targets. As Temple notes, "In fact, Kircher really carried out such experiments by using many separate mirrors simultaneously reflecting solar rays onto a single point. He set fire to wood by these means at a distance of more than 100 feet (figure 2)."⁷

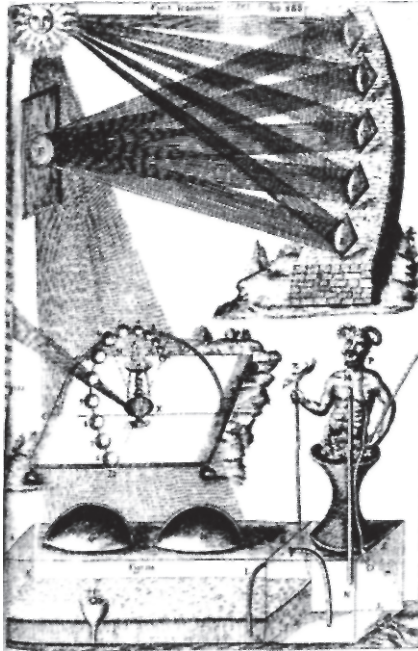

Figure 2: Athanasius Kircher's 1646 Engraving of Archimedes' Mirrors

⁷Temple, op. cit., p. 314.

Exploding Planets

An even more intriguing engraving was produced by Kircher in the same year, this time anticipating George Lucas' Star Wars by almost three centuries. In the upper left of the engraving, a large parabolic reflector is used to collect and focus the rays of the sun on a target. Immediately below this, are three geometric drawings. The first illustrates the use of parabolic dishes to collect and focus rays. The center illustration is perhaps the most interesting. There, an oval shape apparently demonstrates the geometry of focusing rays onto a target no matter what the position of the sun is. Perhaps Fr. Kircher was dreaming of aerial mirrors, or even satellites. But the main interest is the use of both mirrors and a lens to reflect and refract the sun's rays onto the flagship of the Roman admiral in the harbor (figure 3).



Figure 3
Athanasius' Kircher's 1646 Engraving of Parabolic Reflectors and
Mirrors: a "Third Generation" Archimedean Weapon

Mention must be made of the French Count Buffon, whose actual mirrors, used to ignite wooden blocks at over 150 feet, still survive in French museums. Finally, as late as the nineteenth century, inventors

⁸ Temple, op. cit., p. 315, citing Athanasius Kircher, *Ars Magna Lucis et Umbrae*, Rome, 1646.

The Giza Death Star Deployed

and scientists were still attempting to reproduce Archimedes' feat, sometimes with dramatic results. The British inventor Samuel Parker constructed a burning-glass with two lenses, a three foot lens, and a smaller focusing lens. The heat was such that "iron plates were melted in a few seconds" and "tiles and slates became red hot in a moment, and were vitrified, or changed into glass." Notwithstanding these prodigious temperatures, "the finger might without the smallest injury be placed in the cone of the rays within an inch of the focus (figure 4)."⁹

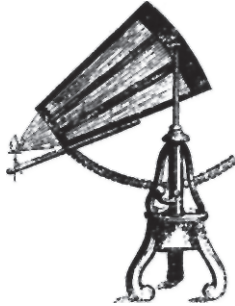

Figure 4: Samuel Parker's Burning-Glass Apparatus, ca. 1844.

The weird parallels between the movies and the actual Giza Death Star become even more intriguing when one considers the similar properties of the giant electrostatic plasma-belching cannons used in *Independence Day*. There too, carrier waves are directed to a target and, after large capacitors appear to be charged by several converging waves of electrostatic energy, a massive and suggestively "electro-acoustic impulse" is directed through that carrier wave, initiating a fiery nuclear reaction in ordinary matter that rolls along and consumes everything in its path over an area several counties large.¹⁰

⁹ Temple, *op. cit.*, p. 320.

¹⁰ Col. Philip J. Corso, (Ret.), with William J. Birnes, *The Day After Roswell* (New York: Pocket Books, 1997), p. 273. The thesis of Col. Corso's book, as is well

Exploding Planets

But the parallels do not end simply with a comparison of these science fiction movie weapons, ancient, mediaeval and Renaissance mirrors, and the actual Giza Death Star. Consider these rather unusual facts about the mythological history outlined in the Star Wars trilogy of movies and the history of the "Second Pyramid War" reconstructed by Zechariah Sitchin from ancient Sumerian texts, and extensively cited in *The Giza Death Star*:

- (1) The Star Wars trilogy is about a war to destroy a superweapon, a "death star" on which the power of an evil emperor and his empire rests. Sitchin's texts recount a similar war to destroy a similar weapon, a weapon Sitchin suggests is the Great Pyramid based on his analysis of ancient Sumerian texts. Further corroboration of a general nature comes from other ancient traditions that refer to an advanced warlike society of great technological sophistication and utter moral depravity that was likewise destroyed.
- (2) The movie Star Wars itself is about an exploded planet and events that took place "a long time ago in a galaxy far, far away."

So what does all this amount to? We have:

known, was that there was an extraterrestrial craft that crashed and was subsequently recovered at Roswell, New Mexico in 1947. Corso alleges that "alien technology" was recovered from this crash, back-engineered, and then slowly and carefully leaked to American industry and integrated into American technology and society. This hypothesis raises as many questions as it answers, since one of Corso's most persuasive arguments stems from the relative lack of preliminary technology leading up to the invention of the transistor, which, he maintains, was actually one of the recovered and back-engineered items. However, those familiar with the vast cache of technological gadgets retrieved from Germany at the end of the Second World War will be familiar with the very small ceramic klystron tubes the Nazis had perfected, tubes several times smaller than those of their Allied counterparts, and strongly resembling transistors. This fact implies one of two things: either (1) a similar craft crashed in Germany and was back engineered prior to the war; or (2) the craft that crashed in Roswell was not extraterrestrial.

My purpose in mentioning Corso's book, however, comes from a cryptic comment made at the very end of the work: "In fact, the U.S. military has better, more accurate, and more powerful weapons for killing UFOs than were deployed in the movie *Independence Day*."

The Giza Death Star Deployed

- (1) Apparent ruins and artificial pyramidal structures on Mars;
- (2) Craters and, as we shall see, evidence of life and a catastrophic, sudden devastation of that now dead planet;
- (3) A pockmarked satellite orbiting our own planet, with evidences of its own anomalies, including possible artificial structures;
- (4) Sheets of green glass and other evidences of long-since fought nuclear wars on our own planet predating the most ancient civilizations of the classic period;
- (5) Odd, anomalous indications of a very sophisticated paleoancient technology long since vanished; and,
- (6) Mythologies and traditions around the globe of superweapons, of "Yin-Yang" mirrors and "death stars."

But most importantly - right in the middle of this Mars-Terra-Luna planetary neighborhood, amid all the rubble and trace evidences of an ancient devastation, right here on the surface of the earth - we have a paleoancient machine, engineered with tolerances not achievable by today's most advanced engineering and construction technology, harmonically oscillating almost every known physical force and system, containing harmonics of the Planck constant of the minimum quantum of action in an edifice built thousands of years before its (re)discovery in the early twentieth century. We have in the Great Pyramid at Giza perhaps the original Death Star itself.

So could that "galaxy far, far away and a long time ago" simply be our own galaxy, far away, not in space, but in time? And could the events alluded to in the movie be occurring not in some distant star system, but in our very own stellar neighborhood? Perhaps.

But after all, if one wishes to pursue the parallels between the "Death Star" hypothesis of the Great Pyramid and the science fiction classic Star Wars, then one central parallel is thus far missing, one crucial question has gone unanswered, and it threatens the whole hypothesis of a possible deliberate parallel: Is there any evidence for an exploded planet?

Indeed there is, says professional astronomer Dr. Tom Van Flandern of the US Naval observatory.

More importantly, it would appear that the ancient Egyptians and Sumerians agree with him.

Exploding Planets

B. Astronomy, Planetary Physics, and Exploded Planets

Most readers who are familiar with the literature on ancient technologies and the legacies of Sumer and Egypt will be familiar with the names of Alan Alford (The Phoenix Solution) and Dr. Zechariah Sitchin (Genesis Revisited; The Wars of Gods and Men) and their arguments that both societies preserved, in their mythologies, the idea that there was once a planet orbiting where our asteroid belt now orbits, and that it exploded. Both authors make very convincing and compelling cases that the names of some ancient "gods" and accounts of their "wars in heaven" are actually names of planets, and their "wars" are but metaphors for the effect of massive collisions and explosions.

Indeed, it was the possible physics of such an interpretation that first prompted Alford to contact Van Flandern to query him about Sitchin's hypothesis that the Earth itself was shunted from a prior orbit in the asteroid belt to its current orbit around the sun.

Unfortunately, Van Flandern's response was not very encouraging. In response to Sitchin's proposal that the Earth had physically changed its orbit as a result of a collision with another planet in the vicinity of the asteroid belt, Van Flandern pointed out to me that:

"A major collision must change the orbit because it changes the momentum of the planet. The new and old orbits must share a common point at the site of the encounter. So a collision cannot take a planet from one circular orbit to another because such orbits have no points in common."¹¹

In other words, the earth's orbit simply is not eccentric or elliptical enough to cross any other orbit; Sitchin's reconstruction of cosmological history from the texts is at this point simply physically impossible.

But what of the exploded planet hypothesis itself, to which both Alford and Sitchin adhere? It was Van Flandern who himself was the astronomer who had first proposed such a radical idea. Why had he

¹¹Alan Alford, *The Phoenix Solution: Secrets of a Lost Civilisation* (London: Hodder and Stoughton New English Library, 1998), p. 239.

The Giza Death Star Deployed

proposed it? Because the elliptical orbits of comets were precisely the type of orbit that such a planetary catastrophe would have resulted in.

(1) Comets, the Oort Cloud, and the Asteroid Belt

In order to account for the existence of comets, some astronomers posited the existence of the Oort cloud, a vast reservoir of cosmic "garbage" existing far beyond the orbit of Pluto. Comets, so this theory runs, are flung into their long erratic elliptical orbits around the sun by the gravitational disturbances of "passing stars." The reason this notion was advanced was in part due to the "non-catastrophic" paradigm of conventional astronomy; the only things observed to explode were stars, and that too was a rare event.

However, with the advances in telescopes and space probes, data began to amass that slowly changed this stable view. Blackened, pockmarked asteroids, for example, were discovered that showed the distinctive signs of having undergone some catastrophe in their past. Comets, too, showed similar traits.¹² All this prompted Dr. Van Flandern to revise his views.

During the 1970s, the astronomer Tom Van Flandern began to sense that everything he had been taught about the Oort cloud was unacceptably contrived and implausible, and began to search for an alternative origin of comets. In 1978, Van Flandern wrote a paper for the scientific journal *Icarus*, claiming that the Oort cloud - a purely theoretical and unobserved construct - did not exist. Instead, he put forward the only other dynamically viable explanation, namely that the comets had originated in a massive explosion of a planet formerly in the asteroid belt.¹³

For Alford, this constitutes evidence for his reading of the Egyptian religion, for it complements the metaphor of Seth chopping Osiris to pieces.¹⁴

¹² Cf. Alford, *op. cit.*, p. 240.

¹³ *Ibid.*, p. 241, emphasis Alford's.

¹⁴ *Ibid.*

Exploding Planets

(2) Bode's Law

As Alford notes, Van Flandern's proposal was met with "a predictable wave of criticism from the Oort cloud theory."¹⁵ Nevertheless the astronomer maintained his position, quietly gathering supporting evidence, which he finally published in 1993 in a book called *Dark Matter, Missing Planets and New Comets*. Van Flandern first observed that the velocities of comets approach the escape velocity of the solar system, and notes that an explosion is really the only viable mechanism to explain this. More importantly, using computers he "traced the orbits of many comets backwards in time. The result of this mathematical modelling (sic.) was a statistical tendency towards a common point of origin, between Mars and Jupiter, around three million years ago."¹⁶ Finally, astronomers have long known on the basis of their mathematical training that a planet should exist where the asteroid belt now lies. The basis of this prediction is the harmonic nature of planetary orbits known as Bode's Law, which notes that each of the inner planets' orbits are approximately twice the distance of the previous one from the sun. The law was used, for example, to predict the approximate position of Uranus before its eventual discovery.

(3) Meteorites

And finally, the evidence of meteorites themselves is mute stony testimony to a once-existing, exploded planet. Many meteorites contain diamonds, which can only be formed under the high pressures of a large mass. Others show signs of melting and stress, and most show distinct differences between predominantly lighter elements and meteorites composed of heavier elements, precisely the sort of differentiation that indicates that perhaps they came from a former planetary body.¹⁷

¹⁵ Ibid., p. 243.

¹⁶ Alford, *op. cit.*, p. 244.

¹⁷ Ibid., pp. 244-245.

The Giza Death Star Deployed

(4) Problem with the Exploded Planet Hypothesis

Bode's Law was revised by physicist Michael Ovenden in 1972 to make more accurate predictions not only of the planetary positions but also of their expected masses. On the basis of this revision, he predicted that the missing planet in the asteroid belt should have been a large giant close to the mass of Saturn. However, this made opposition to Van Flandern's hypothesis more trenchant, since the mass of the asteroid belt is nowhere near the mass of a Saturn-sized planet.¹⁸

But Van Flandern's response was unequivocal:

As for getting rid of the excess mass, this is a solved problem. If the Earth exploded today, only one per cent or less or near-surface rock would survive in asteroids, because most of Earth's interior would vaporise (sic.) as soon as the enormous pressure of higher layers was released.¹⁹

And this of course means that there should be evidence of a blast wave. Developing his theory "from first principles," Van Flandern predicted that "the blast wave from the explosion would have left telltale signs on the surfaces of planets and moons in the solar system."²⁰ And the evidence for such a blast wave was quite strong.

Wherever photographic data was available for a planet or moon with no atmosphere, its surface was covered in black carbonaceous material. Van Flandern named this his "black axiom", on account of the remarkably consistent appearances of the surfaces of Pluto, Neptune's moons Triton and Nereid, and Saturn's moon Iapetus. Iapetus offered particularly strong evidence of the blast wave, for it was blackened on only one side.²¹

And this one-sidedness strongly resembles a similar feature one encounters on Mars. At this juncture, it is necessary to pause and examine these Martian geological anomalies rather carefully, for Mars constitutes what may be the strongest remaining planetary evidence for Van Flandern's exploded planet hypothesis.

Beyond the fact that Mars appears to have artificial structures dotted all over its surface - from the famous "Face" and its nearby

¹⁸ Ibid., p. 245.

¹⁹ Alford, op. cit., p. 245. Of course, this principle itself can be weaponized.

²⁰ Ibid., p. 247.

²¹ Ibid., emphasis Alford's.

Exploding Planets

pyramidal structures, to "forts" and other oddly symmetrical objects -the planet itself may be the strangest anomaly of all.²² For one thing, it is now approaching the status of a scientific consensus that "much of the planet shows unmistakable evidence of former oceans, lakes, and rivers, of plentiful rainfall, and of catastrophic floods on a gigantic scale that once scoured its surface."²³ While this certainly raises interesting questions and speculations on religion and ancient mythologies in and of itself, the anomalies only grow. Mars, like Earth, has two polar ice caps. But unlike Earth's, Mar's southern ice cap appears not only to be composed almost completely of dry ice, but is also older than its northern ice cap, which is composed both of dry ice and a large reservoir of water ice approximately 1000 kilometers in diameter.²⁴

But the most intriguing features about Mars are its extremes:

Where Earth is mellow and adorned with gentle curves, Mars is a planet of jagged extremes. Its valleys are the lowest in the solar system, its canyons the deepest, its volcanoes the highest. In the absence of an existing sea level, scientists refer to altitudes and depths on Mars in terms of an arbitrary "datum" level. The summit of the giant volcano Olympus Mons, at 27 kilometers above datum, is the highest point on the planet, and the floor of the canyon system known as the Valles Marineris, at seven kilometers below datum, is the lowest point.²⁵

South of this enormous volcano is an area known as the Elyseum Bulge, and at a distance of approximately 1000 miles southeast of Olympus Mons there is a strange "upwelling of land" called the Tharsis Bulge. Rising 10 kilometers above datum, it covers an area "the size of Africa south of the Congo River."²⁶ Three shield volcanoes squat on this bulge and tower to heights of over twenty kilometers.

²²I wish to make it clear that I do subscribe to the hypothesis that these ruins are artificial and the creations of intelligent, human-like beings (or equally possibly, humans themselves). I do so not because they "look" artificial, but because, as Hoagland, Torron, McDaniels and others have pointed out, the mathematics of the structures is precise, and redundant.

²³Graham Hancock, *The Mars Mystery: The Secret Connection Between Earth and the Red Planet* (New York: Three Rivers Press, 1998), p. 26.

²⁴Ibid., pp. 26-27.

²⁵Ibid., p. 27.

²⁶Ibid., p. 28.

The Giza Death Star Deployed

Beginning at the eastern edge of the Tharsis Bulge runs a "tremendous meandering furrow" of "interconnecting box canyons and depressions known as the Noctis Labyrinthis," eventuating in a wide and deep channel continuing eastward roughly parallel with the Martian equator but "between 5 and 20 degrees south of it," for almost 4,500 kilometers and known as the Valles Marineris.²⁷ On its eastern end it splatters into "a morass of so-called chaotic terrain - a tortured and overturned landscape of blocky remnants, valleys, and fractures that seems like one of the lower circles of Dante's Inferno."²⁸ Along its northern edge there is a vast system of channels.

What is striking about the channels, geologists unanimously agree, is that they could only have been caused by floods involving prodigious quantities of water. These floods flowed from the southern hemisphere of Mars into the northern hemisphere at a very rapid rate because they were draining downhill.²⁹

The fact that these floodwaters were draining downhill highlights the most curious feature of Martian geology of them all, the "Martian Hemispherical Dichotomy." As Hancock puts it,

One of the great mysteries of Mars is that it has two quite distinct and clearly defined areas of relief - the relatively cratered southern uplands, most of which stand at two kilometers or more above datum, and the relatively smooth and uncratered northern lowlands, most of which lie at least one kilometer below datum.³⁰

These hemispheres are inclined approximately 35 degrees from the Martian equator. The Elyseum and Tharsis Bulges and two large craters in the northern hemisphere are the only significant exceptions to this generalization.

What does all this add up to? Again, citing Hancock, "All that is certain is that at some point in its history the planet was affected by a cataclysm of almost unimaginable proportions."³¹ The geological

²⁷ Ibid.

²⁸ Ibid., p. 28.

²⁹ Ibid., emphasis Hancock's

³⁰ Ibid., p. 29.

³¹ Ibid.

Exploding Planets

anomalies of Mars, however unimaginable in their proportions, are nevertheless consistent with Van Flandern's exploded planet hypothesis.

(a) The Absence of a Physical Model of Natural Causes of Planetary Explosions

But there's just one difficulty with all this: there is no good physical model for why planets should suddenly and spontaneously explode of natural causes. Alford notes the following about this dilemma, and Van Flandern's less-than-convincing response to his inquiries about it:

What causes a planet to explode? This was one of my first questions of Van Flandern, and happened to be the only reasonable objection which (sic.) had previously been raised against his theory. His answer was forthright:

"Ultimately, it doesn't matter if we have no knowledge of possible mechanisms. For example, no theory for supernova explosions has yet been completed. The existing models all have one or more major gaps that cannot yet be made to work, even in computer models. We must first decide if such events are an observed fact... the research on mechanisms will follow."

Some of the mechanisms currently being investigated include nuclear reactions and matter-anti-matter explosions. Something extremely potent must be surmised to account for the enormous energy which (sic.) was generated and the level of cosmic radiation which has been observed. Ultimately, we must recognize that this is an entirely new field of planetary physics, and more information is required before firm conclusions can be drawn.³²

Extremely potent indeed. Of course, one can, as Alford indicates, come up with any number of admittedly flawed though plausible models for the spontaneous explosion of planets. One can conceive, for example, of an object large enough to pass the Roche limit without being ripped apart, and slamming into a planet with sufficient kinetic energy to rip it apart in a gigantic explosion. Plausible, yes, and while such events do

³² Alan Alford, *The Phoenix Solution: Secrets of a Lost Civilisation* (London: Hodder and Stoughton New English Library, 1998)1, p. 252, emphasis added. Alford is citing Tom Van Flandern, *Dark Matter, Missing Planets, and New Comets*, (1993) p. 163. Cf. Graham Hancock, *The Mars Mystery: The Secret Connection Between Earth and the Red Planet* (New York: Three Rivers Press, 1998), p. 40.

The Giza Death Star Deployed

occur - witness the recent impact of the Schumacher-Levy comet on Jupiter - they are rare. The odds increase dramatically when the missing exploded planet must be in the precise location to be struck by an object that is large enough to get safely through the Roche limit with sufficient mass and velocity to explode it, and then in turn to do the type of surreal damage to Mars and yet leave the northern hemisphere relatively "unscathed."

As Hancock notes, planetary physicists and geologists are at something of a loss to explain why the Martian surface should exhibit such a strange dichotomy between the relatively smooth northern hemisphere and the twisted, scarred, gouged terrain of the southern, with its huge mountains and cavernous valleys far deeper and more rugged than the Grand Canyon:

(It) is supposed that a freak additional bombardment by asteroids (or by one mega asteroid) occurred, for some reason falling only on the north, breaking through its crust, lowering its altitude, and obliterating its preexisting craters.

Nor is it clear why the damage should have been focused on one hemisphere - the north - with such ferocity that its crust could have been stripped away to a depth of three kilometers. As critics have pointed out: "Any attempt to explain the dichotomy via impact depends on a statistical clustering of impacts in the northern lowland.... Unless impacts are significantly more numerous within the lowland than elsewhere, there simply is no reason to expect that the lowland will differ in any way from the rest of the planet."³³

A possible scenario would be for the missing planet, in orbit where the asteroid belt now is, to explode at such a time and position that Mars was literally showered with the debris of that cataclysm. Alternatively, that missing exploded planet might have had a large moon. Thus the explosion, if it occurred at the right time and place vis-a-vis Mars, would have released that satellite from its orbit around the now missing center of gravity of the exploded planet, and sent it on a wild careening impact course into Mars.

All this, of course, is possible. But there is a problem with these models, and it is one already well known to physicists, and, for that matter, to Hancock.³⁴ It is the "Roche Limit." In effect, the Roche

³³ Hancock, op. cit., pp. 37-38.

³⁴ Hancock, op. cit., p. 39.

Exploding Planets

Limit constitutes a natural "planetary defense shield" around planets, protecting them from just such accidental collisions with other large objects in space. It is a zone around a large mass wherein an object with a smaller mass and gravitational field that manages to enter it will either be expelled from the region by the electromagnetic repulsion of the larger mass, or alternatively, simply ripped apart in the massive tidal stresses of its larger neighbor.

But the fact remains, Roche Limit notwithstanding, that the scenarios outlined are possible. However, given the high odds of improbability and the absence of a plausible model as to why planets should suddenly and spontaneously explode, another hypothesis is equally possible. There is a model by which planets can explode if one does not discount the possibility of deliberate action of an intelligence or civilization with sufficient technology and physics to do so, and with a commensurate lack of moral inhibition from constructing and deploying such technology destructively. In short, planets can be made to explode by loading sufficient amounts of gravitational-acoustic energy into them via the type of scalar physics posited for the Giza Death Star. Such powerful weaponry is entirely consistent with scalar physics.

The effect of such loading would simply be to destabilize the planetary core, causing it to explode. It is important to cite Alford here: "I then wondered whether a close encounter with Planet X might have destabilised (sic.) the interior of the former planet(s), causing them to subsequently explode (sic). To my astonishment, Van Flandern agreed that this scenario was entirely plausible."³⁵ That is, two planets would approach so close that one violated the other's Roche Limit, subjecting it to tidal stress and destabilizing the planetary core. The effect is due to gravity. Similarly, scalar induction of acoustic cavitation within the planet, resonant to its Schumann resonance, could load more energy into it than the planet can damp, destabilizing its core, and causing it to explode. Alternately, as will be shown in chapter 10, sudden direct current electrical discharge can also produce a space warping effect which, if large enough, could create a sudden mass displacement nearby a target, subjecting it to similar tidal stresses and instabilities, causing violent cavitation and explosion. Finally, as we have seen, a

³⁵ Alford, op. cit., p. 254.

The Giza Death Star Deployed

third method could be pursued: breaking or fracturing the planetary crust and mantle and allowing the highly pressurized interior to release in a violent explosion. Such an explosion would, of course, release massive amounts of radiation into our local solar system. Such "background" radiation is usually interpreted - in part correctly - as the "signature" of a massive explosion, the "Big Bang." However, such radiation seems too small to serve as confirmation of that cosmological model, and might be the radiation left over from a different type of explosion altogether.

So, lacking an adequate physical model of the spontaneous explosion of planets by natural causes, the evidence of such a planetary catastrophe having occurred at some time in the distant past of our solar system constitutes corroborative evidence of the weapon hypothesis of the Great Pyramid advanced here and in my previous book, *The Giza Death Star*.

Following this very speculative line of reasoning to its full conclusion, the following outlines of a scenario emerge:

- The paleoancient Very High Civilization was an interplanetary civilization based on the planetary system formed by the missing, exploded planet (and any of its moons), on Mars and its moons, and on Earth and its moon;
- The "planetary wars" recorded in ancient Egyptian and Sumerian religions - detailed by Alford and Sitchin - are the mythological retelling on the part of the legacy civilizations of an actual interplanetary war. Thus the names of the "gods" may not represent planets, so much as the planetary base of operations of real flesh and bone persons, exactly as the ancient texts describe them. In other words, the ancient myths are not allegories of interplanetary catastrophism nor are its "gods" merely symbols of those planets, but records of an actual interplanetary war fought between real people who come to symbolize the entire planet in the rhetorical *pars pro toto* device, much like we often refer to "the war against Hitler" to mean the war against Germany;

³⁶It should be noted that Mars' orbit is eccentric, thus indicating the possibility that it may have been the satellite of the missing exploded planet. It should also be noted that Van Flandern also argues persuasively that the missing planet was a water bearing planet. Cf. Alford, p. 270.

Exploding Planets

- This paleoancient interplanetary war was the "occasion of use" of the Giza Death Star, which was deployed at the precise moment that the exploded and now missing planet would also do the most collateral damage and destruction to Mars, effectively destroying it, a scenario remarkably similar to Van Flandern's own hypothesis;
- This in turn would seem to indicate that the missing planet and Mars formed either one societal component in the paleoancient Very High Civilization, or an alliance between planets;
- Conversely, the ancient texts also indicate that these societies had allies on earth, and that only one society on earth was waging war against them;
- It would thus appear - corroborating one of Sitchin's scenarios - that one segment of that Very High Civilization was either in revolt against all the others in some sort of paleoancient "War of Independence," or that it intended simply to conquer the others in order to secure its dominance or preserve its hegemony.

Curiously, whenever Hancock does refer to Van Flandern's "Exploded Planet Hypothesis" in his book *The Mars Mystery*, he does so in rhetorical terms strongly suggesting deliberate, intelligent, and military action:

It is the scientific consensus that Mars was killed - executed would not be too strong a word - by a stupendous bombardment of asteroids or comets. Thousands of huge craters pockmarking its tortured surface are the silent witnesses to this. And it is thought likely that the same bombardment also caused the cataclysmic floods...and then stripped away the planet's formerly dense atmosphere so that liquid water could no longer survive anywhere upon it.

What kind of event could this have been? And what does it say about the nature of the universe in which we live - perhaps even about the predicament of Earth itself- that Mars was so completely rubbed out when it was in its prime?

We are looking at a murder victim. All we have are photographs and measurements of the corpse and the results of certain scientific tests that have been done on it.

³⁷ Graham Hancock, *The Mars Mystery: The Secret Connection Between Earth and the Red Planet* (New York: Three Rivers Press, 1998), p. 35, emphasis Hancock's.

The Giza Death Star Deployed

Troubling, evocative words indeed, especially in the context of a hypothetical deliberate induction of a planetary explosion in Mars' ancient, now obliterated, neighbor.

So maybe, just maybe, it wasn't "just a movie" after all...

DATING THE CATASTROPHE AND THE COMPOUND

Any redating of the Sphinx implicitly threatens to redate the two giant pyramids at Giza, with which it is intimately linked, and this raises the stakes considerably.

Alan Alford, *The Phoenix Solution*¹

" 'Then everything got smashed up... the ole moon broke... the sea rushed in.' With such thoughts in mind we move on to the use of the curious phrase 'the ole moon broke.' What could this mean? It is a quite specific statement, and one that we must assume has an importance relative to the story being told "

Andrew Collins, *Gateway to Atlantis*²

...but there are problems with that scenario.

When did it all happen? When did the missing planet explode? When were the Martian ruins built? When did Mars suffer its ruinous cataclysm? And when was the Great Pyramid, the Giza Death Star built? The answers to these questions are important, because - as will be discovered - there are four lines of investigation and dating, each one returning very different results:

- The dating of the catastrophe of the exploding planet, returning plausible dates of 3,000,000 and 65,000,000 years ago;
- The dating of the building of the Martian monuments, yielding a date of between 650,000 and 250,000 years ago;
- The dating of the Martian catastrophe, from 3,000,000 to 650,000 years ago;
- The dating of the Great Pyramid from 3,000 to 20,000 (or more?) B.C.

These results are juxtaposed in this fashion to highlight a significant problem for the scenario of deliberate destruction of a planet by a weapon outlined in the previous chapter, for if the catastrophe occurred 3,000,000 or even only 650,000 years ago, by most accounts it is still much too old for even the most early dating of the Great Pyramid.

¹ Alan Alford, *The Phoenix Solution: Secrets of a Lost Civilization* (London: New English Library [Hodder and Stoughton], 1998), p. 39.

² Andrew Collins, *Gateway to Atlantis: The Search for the Source of a Lost Civilization* (New York: Carroll and Graf Publisher, 2000), p. 260.

The Giza Death Star Deployed

However, as we shall see, there are considerable difficulties in assigning any "earliest possible" date for the Pyramid.

A much more significant problem looms, however. For any reconciliation of these dates to take place, it must be assumed that mankind was not only in existence, but that he had been in existence long enough to develop a highly advanced civilization. This would push the date of human origins far back, millions of years prior to mankind's emergence in the current standard theory.

Is there any way to reconcile these widely diverging dates, and thereby to form a speculative basis on which the previous chapter's scenario might have occurred? The question is a fascinating one, requiring an interdisciplinary approach, since so many different and disparate kinds of knowledge are required to answer it. But answer it we must if we are to confirm or deny the scenario of a deliberately destroyed planet and an ancient interplanetary war. I should stress that the deliberately exploded planet hypothesis is only corroborating evidence to the hypothesis that the Great Pyramid was a weapon of mass destruction employing scalar physics on a planetary scale. The Weapon Hypothesis does not stand or fall on the truthfulness or falsehood of the exploding planet scenario. However, the scenario would constitute corroboration of the type of physics posited for the Giza Death Star, and hence thoroughness requires that it be investigated. That being clearly on the record, let us begin answering the question by looking at how each set of dates are arrived at in each of the four lines of inquiry, starting close to home, here on earth, at Giza itself, and working backward from there.

A. Dating the Giza Compound's Structures

In this section, I shall rely heavily on Alan Alford's presentation of the issues of dating the Giza compound in his book, *The Phoenix Solution*. Alford's work, besides being a thorough compendium of research on all issues effecting the dating of the compound's structures, is also a very balanced treatment and lends itself well to summarization.

(1) The Sphinx, the Great Pyramid, and the Second Pyramid of Kahfre

Dating the Catastrophe and the Compound

At the epicenter of the controversy and seismic revolution that has challenged the conventional dating of standard Egyptology and academic historiography is the second most mysterious object at Giza, the Sphinx. The "Sphinx dating controversy" really highlights a state of crisis within the academic study of Giza between the standard views of Egyptology and historiography on the one hand, and the discoveries of geologists, astronomers, engineers and other scientists investigating the compound on the other.

The controversy "began" with a 1993 television documentary. Discarding the notion that the Sphinx was constructed by the Egyptian king Khafre (or Cephren to the Greeks), the same king as is alleged to have built the second large Pyramid at Giza. Since Khafre is the son of Khufu (or Cheops), who is alleged by standard Egyptology to have built the Great Pyramid, any redating of the Sphinx thus implicitly threatens the whole paradigm of standard academic dating. As Alford puts it,

The new theory was based on the science of geology, applied to the highly weathered limestone rock of both (sic.) the Sphinx and the enclosure in which it sits. This weathering had led Robert Schoch, a geologist from Boston University, to date the monument to a minimum 7000-5000 BC -thousands of years before the Egyptian king Kahfre, and, more importantly, thousands of years before any known civilisation (sic.) had begun.³

This rather odd geological fact would place the Sphinx's construction to sometime prior to the so-called Neolithic Subpluvial, a rainy climatic period believed to have lasted from ca 7000 to 2500 BC. Note that the terminus ad quem of the period is supposedly when the Sphinx was built according to standard Egyptology.⁴

Of course, one might advance the notion that the apparent water weathering on the Sphinx was caused by the flooding of the Nile itself and thus maintain that the Sphinx was the product of Fourth Dynasty Egypt. The problem with this view is that the Sphinx should therefore show greater water weathering at its base than at its top, when exactly the reverse is the case. The weathering is greater at its top than at its base. Moreover, no other Fourth Dynasty structure shows evidence of

³ Alford, op. cit., p. 5.

⁴ Ibid.

The Giza Death Star Deployed

this type of flooding weathering effect.⁵ Moreover, as we shall see in a moment, if any monument at Giza is linked to flooding, it is probably the Great Pyramid itself.

Never at a loss for arguments to date the compound to the Fourth Dynasty kings, Egyptology maintains that the strong resemblance of the face on the Sphinx to other stylized and indisputable likenesses of Khafre demonstrate its pedigree. And never at a loss for responses, revisionists maintain that the head of the Sphinx is disproportionately much smaller than the rest of the body, supporting the notion that the head was possibly recarved by Khafre from some earlier antecedent.

But in any case, the weathering, and hence the redating of the Sphinx, still stands. And this raises the issue of dating the compound as a whole. As any examination of an aerial view of Giza will demonstrate, the compound and its structures are all geometrically linked. The Great Pyramid was not excluded from whatever ground plan that

encompassed the Sphinx, its temples, the causeway and Khafre's pyramid, for it would seem that the position of the two Sphinx temples was determined by two intersection lines drawn from both of the two giant pyramids. Indeed, when we add to these relationships the common use of megalithic-style masonry in the temples of both (sic.) Sphinx and pyramids. It is easy to see why Egyptologists view all the structures of Giza as intimately linked, and thus roughly contemporary. The important implication of this is that one reliable dating has the potential to date all structures on the Giza plateau, hence the redating of the Sphinx is not an isolated issue, but has fundamental implications for our understanding of Egyptian history, and particularly the so-called 'Pyramid Age.'⁶

Thus, one has an approximate date for the terminus ad quern for the Sphinx, the two giant pyramids, and the temples. On the basis of the geological weathering of the Sphinx, the main structures of the compound could have been built as long ago as 7000 BC.

But the redating issue takes yet another strange twist with the radiocarbon dating of the Pyramids themselves. As carbon-dating cannot be performed on inorganic materials, samples of the mortar of the Great Pyramid, containing organic elements, were taken and carbon-dating

⁵ Ibid., p. 6.

⁶ Alford, *op. cit.*, p. 12.

Dating the Catastrophe and the Compound

tests performed in 1986 by Mark Lehner, then associated with the Edgar Cayce A.R.E. Foundation. The results returned the highly anomalous dates of 3401-2853 BC, with an average date of 2977 BC. This is highly anomalous for several reasons:

- Since the Great Pyramid was supposedly built by king Khufu (Cheops), the radiocarbon dating of the structure returns an average age at least 400 years older than would be possible had he done so.
- The radiocarbon dating of the Great Pyramid thus returns an age older than the famous "Step Pyramid", and thus the poor construction of the latter cannot be evidence of "first attempts" in the progressive evolution of the technology of pyramid-building, but the declined technology of the Egyptians trying to emulate what was already there and built by someone else.
- Radiocarbon dating of the mortar from the Sphinx returns average dates ca 2085 BC, which places it well beyond the Fourth Dynasty (in terms of carbon dating) and conflicts with the best geological evidence of a date for the Sphinx that is much older!
- As was pointed out in my previous book *The Giza Death Star*, the exposure curve for mortar at the top of the Pyramid and mortar at the bottom returns the ridiculous result that the mortar at the top is much older - by about 1000 years in some cases - than the mortar at the bottom. Since the chemical composition of the mortar is the same, it would appear that king Khufu laid the foundation of his pyramid in thin air and built it down to the ground, an absurd notion. These weirdly anomalous results do make sense, however, if one supposes a strong source of radioactivity was once found in the interior of the Great Pyramid, exactly as one would expect if it were machine power plant (on Dunn's view) or a weapon (on my view). The presence of the Planck unit harmonics, however, would seem to mitigate against any notion of the Great Pyramid being a simple power plant.

The problem assumes even more perplexing difficulty.

Almost everyone - from Egyptologist to scientific revisionist to New Age flight-of-fancy speculator - agrees that the Giza Compound's

The Giza Death Star Deployed

major structures are the oldest in Egypt. And as was noted in my previous book, this seems to imply that Egypt itself is not a glorious beginning to human culture and civilization, but a declined legacy from a culture and civilization that preexisted it.

How does a complex civilisation (sic, et passim) spring full-blown into being? Look at a 1905 automobile and compare it to a modern one. There is no mistaking the process of 'development.' But in Egypt there are no parallels. Everything is right there at the beginning. The answer to the mystery is of course obvious, but because it is repellent to the prevailing cast of modern thinking, it is seldom seriously considered. Egyptian civilisation was not a 'development,' it was a legacy.⁷

Unlike West or others, including this author, Alford attributes the lack of evolutionary progress in such technology not to a lost civilization but to a poorly preserved archaeological record.⁸ But as I and others have pointed out, part of that record has been preserved, and it is highly suggestive of a very advanced technology.⁹ And part of that record consists of texts and traditions of a now lost, but very sophisticated civilization.

Alford's solution to the dating anomalies is ingenious. The Sphinx, the temples, and the two giant pyramids at Giza were already present at the beginning of the Fourth Dynasty, and Khuru and Khafre simply adopted and refurbished them, accounting for the radiocarbon dating anomalies.¹⁰ The society that designed and built the structures disappeared long before the Egyptians occupied them, with an intervening period where the site was maintained by a small and elite priesthood. Thus, in Alford's scenario, there are three distinct levels of the cultural occupation of Giza:

- The first level, responsible for the original construction of the major structures, what I referred to as the "paleoancient Very High Civilization" in The Giza Death Star;

⁷John Anthony West, cited in Alford, pp. 26-27.

⁸Alford, *ibid.*, p. 27.

⁹Cf. David Hatcher Childress, *Technology of the Gods: The Incredible Sciences of the Ancients; Vimana Aircraft of Ancient India and Atlantis*; Joseph P. Farrell, *The Giza Death Star: The Paleophysics of the Great Pyramid and the Military Complex at Giza*. All books published by Adventures Unlimited Press, Kempton, Illinois.

¹⁰Alford, *op. cit.*, p. 29.

Dating the Catastrophe and the Compound

- The second level, a "remnant" or elite priesthood left behind at, or that came to occupy, the site, or perhaps a "Less Paleoancient High Civilization"; and,
- The third level, the Egyptian civilization itself.

This three-level scenario will assume greater importance as we proceed. In order to see how, we must detour to Dashur, and to its famous Red and Bent Pyramids ascribed to king Sneferu.

Beginning with an observation of Sir William Flinders Petrie that the limestone casing of the Bent Pyramid of Dashur is the same yellowish limestone as was used on the Second Pyramid at Giza, and that the fine white limestone casing on the Bent Pyramid was exactly the same limestone as was used on the Great Pyramid, Alford then points out that this correspondence "begs the question of whether Khufu and Khafre emulated Sneferu, or whether Sneferu," the father and grandfather of Khufu and Khafre, "emulated two already-existing pyramids at Giza."¹¹ Alford's answer is worth citing in full, since it spells the death-knell for the view that the great pyramids of Giza were built by Egyptians of any dynasty whatsoever:

No doubt some diehard Egyptologists will wish to stick to the orthodox chronology, but evidence is not on their side at all, since the Giza pyramids were built close together on a neat diagonal, whilst the Dashur pyramids were strangely staggered apart...

It does not therefore take a genius to see which pair of pyramids has been oriented to the other, and it is thus evident that Sneferu built his pyramids after and not before the Great Pyramids of Giza. Such a conclusion is entirely consistent with the archaeological evidence which (sic.) reveals Giza to have been an important site in the 1st Dynasty, in contrast to Dashur which had little importance prior to the reign of Sneferu. Such a scenario raises a number of inetersting questions. For example, why did Sneferu not copy the megalithic temples and causeways at Giza...? Firstly, the apparent failure to emulate the huge causeways at Giza supports the idea that those causeways were not built until later, when Khufu and Khafre added them to the pyramids they had adopted.¹²

Thus, the following observation may now be added to the three-level scenario: at least two different levels of civilizations or cultures built

¹¹ Alford, op. cit., p. 80.

¹² Alford, op. cit., pp. 80-81, emphasis in the original.

The Giza Death Star Deployed

different structures at Giza. This raises yet another question: if that is so, were such structures built on previously existing sites or foundations, or built according to pre-existing plans that were, for whatever reason, not brought to completion by the original builders? This question assumes great importance if one assumes that the three-level scenario also involves three different stages of construction, rather than just two as the quotation from Alford implies. There is strong reason to believe that the other Giza structures were built on preexisting sites.¹³ In any case, we shall have occasion later in this work to consider the meaning and function of the other pyramids at Dashur and Sakkara, and the equally Egyptian preoccupation with obelisks.

(2) The Temples and Causeways

Alford himself makes mention of the possibility of three "levels" of civilizations that came to occupy the Giza plateau.

There are two different adoption scenarios which (sic, et passim) need to be considered. Under the first scenario, the great pyramid was a stand-alone structure, independent from everything else on the Giza plateau. Under the second scenario, both giant pyramids were adopted from an earlier culture. Under this second scenario, we must recall... that the Second Pyramid of Giza is inextricably linked via its temple and causeway to the Sphinx and the two temples which stand in front of it; all of these structure are therefore regarded as contemporary, and all are liable to be redated by the adoption hypothesis, with the possible exception of the causeways.¹⁴

That is, taking the Great Pyramid as the product of the first level, of the paleoancient Very High Civilization, and the Sphinx, temples, and Second Pyramid as products of the second level, and the remaining structures as components of the third or Egyptian era, one has this scenario and dates of construction:

- The Great Pyramid, older than 10,000 BC, by contextual dating vis-a-vis the Sphinx, constitutes the first level built by the "paleoancient Very High Civilization". Note that the dating of the Great Pyramid is left open;

¹³ Cf. chapter 9.

¹⁴ Ibid., pp. 85f.

Dating the Catastrophe and the Compound

- The Sphinx, Second Pyramid, and temples constitute the second level either initiated or completed according to a prior plan ca. 7000-3000BC by a "remnant" or elite priesthood left behind at, or that came to occupy, the site in order to maintain it. The other possibility is that the Second Pyramid and the Sphinx and other "level two" structures at Giza represent the remains of an ancient "Khmetiam" civilization, descended from the Very High Civilization. This Khmetian civilization, while still very advanced, was already in a state of decline.
- The Third Pyramid of Menkaure and other structures, including the causeways and the six minor pyramids constitute third level built by the Egyptian civilization itself.

The problem with this scenario is also obvious.

The Second Pyramid so strongly resembles its neighbor that the layman unlearned in pyramidology easily mistakes it for the Great Pyramid itself, due to its deceptive visual appearance of being higher than the Great Pyramid. Indeed, according to Stephen Mehler, in the indigenous Khmetian tradition of Egypt, the Second Pyramid is known as the Great Pyramid, and was believed to have been built prior to it.¹⁵ Moreover, the Second Pyramid, the causeways, the various temples and the Sphinx very obviously were constructed to be in deliberate geometric relationship to the Great Pyramid. But most importantly, the Second Pyramid was built with one extremely unusual feature: at its base there is one course not of limestone, but of red granite, casing stones. In accordance with his primarily religious interpretation of the second level of occupation of Giza, Alford interprets this feature in a metaphysical sense. However, as was observed by Christopher Dunn and by me in my previous book, granite has strongly piezoelectric properties. In terms of the weapon hypothesis, one course of red granite casing stones would constitute one winding of a primary coil in a Tesla magnifying transformer, as will be explored in chapter eight of the present work.

Thus, the single course of red granite casing stones at the base of the Second Pyramid and the overall geometric alignments exhibited by

¹⁵ Stephen S. Mehler, *The Land of Osiris: An Introduction to Khemitology* (Kempston, Illinois: Adventures Unlimited Press, 2001), pp. 118-119.

The Giza Death Star Deployed

the structures of the second level of the compound,¹⁶ plus the fact that the textual and archaeological evidence adduced by Sitchin - the victory seal clearly depicting two giant pyramids¹⁷ - suggest that at least the Great Pyramid and the Second Pyramid were conceived, if not necessarily built, as a unit in a vast machine.

(3) The Third Pyramid of Menkaure

The smallest of the three largest pyramids at Giza never really captured the imagination of researchers until it was pointed out by Robert Bauvall that its alignment vis-a-vis the other two giant pyramids corresponded with the stars in the belt of the constellation Orion. And indeed, the astronomical correlation does seem to be solid.

The difficulty, however, is the fact that the construction quality of the third pyramid is remarkably poorer than its two larger neighbors.¹⁸ Perhaps significantly, the third pyramid of Menkaure has sixteen courses of red granite at its base, left "in the rough", a fact that suggests to Egyptologists "that the Pyramid was finished in a hurry."¹⁹ What all this adds up to is an inevitable conclusion "that the two (giant) pyramids bear the fingerprints of two separate pre-dynastic cultures at Giza" the Very High Civilization that built the Great Pyramid, and the somewhat declined High Civilization that followed it and built the Second Pyramid, Sphinx, and temples.²⁰

Alford's three-level scenario thus takes on the following outlines:

Using such an approach, we can conclude that the Great Pyramid was built first, followed by a delay, whereupon a different culture built the Second Pyramid, the megalithic temples and Sphinx. Then, after another delay, the Egyptian state arose and carried out an extensive refurbishment of the two pyramids. The overall time chart would thus broadly be as follows:

¹⁶ Discussed in chapter 3.

¹⁷ Cf. my *Giza Death Star*, p. 55. It should be pointed out that the two Giza Pyramids are the only candidates for the structures depicted on the seal, since other dual pyramidal complexes around the world are of the ziggurat or step pyramid variety.

¹⁸ Alford, *op. cit.*, p. 128.

¹⁹ *Ibid.*, p. 129.

²⁰ *Ibid.*, p. 156, emphasis in the original.

Dating the Catastrophe and the Compound

Time Scale	Activity at Giza
1. Pre-dynastic	Great Pyramid built by advanced non-sedentary race who depart but appoint local chiefs to protect the site.
2. Later pre-dynastic	Local priesthood organise (sic) the building of the Second Pyramid, Sphinx and megalithic temples.
3. Circa 3000BC	New Egyptian state institutionalises the old religion and embarks on huge renovation project. ²¹

If we now compare this scenario with Sitchin's Second Pyramid War, and our own hypothesis developed in the last chapter of *The Giza Death Star*, the following scenario outlines emerge. Note the chronology at the earliest level is open-ended, since carbon dating is unreliable if a strong source of radiation was once present in the structure, as hypothesized in *The Giza Death Star*.

Time Frame	Construction	Cultural Focus and Events
10,000 - 65,000 BC?	Great Pyramid and possible other structures(the 2 nd Pyramid)	Scientific focus; the Flood. Sitchin's Second Pyramid War: destruction of scientific and technological infrastructure. After the war, components of the vanquished society's science, and some of the components of the Weapon itself, are stored in secret places by the defeated society. The victors, ala Sitchin, inventory the remaining internal components of the Weapon, destroy some, and dismantle others for use in other Devices.

7000-10000 BC	The society that built the Giza Death Star establishes a "priesthood" to preserve its knowledge base. Priesthood "encodes" the science in metaphysics, religion, and
---------------	--

²¹ Ibid., p. 158.

The Giza Death Star Deployed

structures. Civilization enters decline, but priesthood at Giza exercises "damage control."

7000-3000BC	Sphinx, causeways and so on	Religious-metaphysical. Priesthood "encodes" the science in metaphysics, religion, and certain structures at Giza. Civilization enters decline, but priesthood at Giza exercises "damage control" through these techniques
-------------	-----------------------------	--

3000BC on	Third Pyramid, etc	Religious. Egyptian state rises, possibly with help from Giza priesthood, and perpetuates the purely religious aspect of the legacy.
-----------	--------------------	--

The second level of this scenario, as will be seen in chapter four, also might explain how and why the Giza compound was constructed on such a closely-knit geometric pattern, and why it was so constructed. The priesthood, still preserving some of the technology and science that made the Giza Death Star possible, yet being unable to reconstruct them, encodes the science in the geometry of the compound itself, possibly relying on previously existing sites for the placement of such structures. Alternatively, since one of the strong evidences adduced by Sitchin in favor his Second Pyramid War is the victory seal depicting the two large pyramids at Giza, it is possible that both structures were completed and then the weapon deployed, resulting in the war, its destruction, and the establishment by the vanquished weapon-builders of the priesthood that built the other level two structures, namely, the Sphinx and the "Temples." As we shall see later in this work, the Second Pyramid may have played an extremely important role in the overall function of the weapon.

In any case, it is crucial to observe that the dating of the Great Pyramid itself lies at the extreme remote edge of antiquity, older than the Sphinx and other level two structures, but whose age itself cannot be determined with any accuracy. It is my strong belief that the Second Pyramid dates from a similar period, and that the overall layout of the other structures at Giza, if not their current form, is based on a plan laid out by the builders of the two massive pyramids. In its declined state,

Dating the Catastrophe and the Compound

the level two society very possibly built the other famous pyramidal monuments of Egypt, and possibly restored at least a "power production" function to the two great pyramids of Giza.

B. The Flood and the Great Pyramid

There is one important piece of evidence that must be considered in connection with the scenario of an exploding water-bearing planet. These are the ancient classical traditions that indicate the Great Pyramid was built before the great Deluge. One method, albeit a week one, of verifying the hypothesis was advanced in *The Giza Death Star*: if the Great Pyramid was a weapon, and the Giza compound was laid out in a vast complex architecture, then there would have to be subterranean chambers and tunnels consonant with a military architecture and contributing to its machine function. Both Dunn and Mehler have made similar predictions.

Classical tradition abounds with reports of these subterranean features. For example, "the famed Greek historian Herodotus, in 443B.C, recorded after his visit to Egypt that extending beneath and in all directions far beyond the 'pyramid whereon great figures are graven is a vast labyrinth,' and a 'way into it underground.'"²² A tenth century Coptic historian, Al Masudi, mentioning earlier accounts, noted that underground passages and chambers honeycombed the rock deep beneath the Giza compound.²³

But the most important testimony in this respect is the Roman historian Marcellinus, who, writing in the 4th century, stated:

There are certain subterranean galleries and passages full of windings beneath the pyramids which, it is said, the adepts in the ancient rites (knowing that the flood was coming, and fearing that the memory of sacred ceremonies would be obliterated), constructed vaults in various places, mining them out of the granite with great labor.²⁴

²² Dr. Joseph Jochmans, Litt.D., "Hall of Records: Opening Soon?", *The Search for Lost Origins* (Atlantis Rising, 1996), 68-77, p. 72.

²³ *Ibid.*, p. 73.

²⁴ *Ibid.*, pp. 72-73.

The Giza Death Star Deployed

In other words, the Great Pyramid and other pyramidal structures are said to ante-date the Flood, which again tends to confirm a date older than 10,000 B.C. Note also the connection of the flood to the preparation of sites to preserve knowledge that was considered to be important. We shall return to this matter in chapter four.

But can this ancient testimony be corroborated?

As with the Sphinx dating controversy, the answer comes from geology, and it is a resounding yes. A fourteen feet thick layer of silt sediment surrounds the base of the Great Pyramid. This layer contains seashells and at one time even the fossil of a seacow. These have been carbon dated to approximately 11,600 years before the present time.²⁵ And there is further corroboration from other ancient sources:

Legends and records likewise speak of the fact that, before the Arabs removed the pyramid's outer casing stones, one could see water marks on the stones halfway up the pyramid's height, in about the 240-foot level, which would be 400 feet above the present Nile level. The medieval Arab historian Al Biruni, writing in his treatise *The Chronology of Ancient Nations*, noted: "The Persians and the great mass of Magians relate that the inhabitants of the west, when they were warned by their sages, constructed buildings of the King and the Giza Pyramids. The traces of the water of the Deluge and the effects of the waves are still visible on these pyramids halfway up, above which the water did not rise."²⁶

The implication is obvious. If the last era of great flooding in Egypt occurred ca. 10,000 B.C. and the Great Pyramid showed evidence of this by water marks on its casing stones halfway up its enormous height, then it had to have been built before that period. Such references also confirm Alford's hypothesis that the Sphinx was built by a different culture than that which built the Great pyramid, since the Sphinx was built on lower ground. If such flooding had occurred prior to the Sphinx having been built, it would bear the evidence of flood damage.

As I mentioned in *The Giza Death Star*, carbon dating of the Great Pyramid's mortar returned the very peculiar result that the mortar at the top was a thousand years older than that used at the bottom.²⁷ Even

²⁵ Dr. Joseph Jochmans, Litt.D., "How Old is the Great Pyramid, Really?" *The Search for lost Origins* (Atlantis Rising, 1996), 78-90, p. 83.

²⁶ Jochmans, "How Old?" p. 83.

²⁷ *Ibid.*, p. 84.

Dating the Catastrophe and the Compound

then, carbon fourteen dating placed the Pyramid as having been built around 3100 B.C. to 2850 B.C.²⁸ The discrepancy can only be explained on the basis of Dunn's machine hypothesis and my weapon hypothesis: if strong radiation was once present inside the structure, this would massively distort the results of carbon dating, and also explain the peculiar top-bottom discrepancy.

The Great Pyramid does indeed, then, appear to be the oldest structure on earth, pre-dating 10,000 B.C., and is perhaps far older than anyone imagines.

C. Dating the Martian Catastrophe

The next chronological problem is presented by the constellation of Martian anomalies, both natural and artificial, separately and in conjunction. As seen in the previous section, an open-ended date should be assigned for the Great Pyramid, making it older than 10,000 BC. Nevertheless, it would seem difficult to assign a date of 250,000, much less 650,000 BC to the structure.

These dates are important, since they are the standard dates assigned to the Martian monuments (250,000BC) and to the earliest possible date for the Martian catastrophe (650,000BC). Not only do these two dates pose problems of reconciliation vis-a-vis each other, but they also pose a significant problem if one wishes to factor in consideration of the weapon hypothesis for the Great Pyramid. Moreover, the dating of the catastrophe also has implications for the dating of the Martian Monuments.

D. Dating the Martian Monuments

Richard C. Hoagland is well-known for having popularized others' research as well as pioneered certain research of his own into the Martian ruins at Cydonia. For these and other reasons that will become apparent in chapter three, his statement of the dating and origins problem of the Martian monuments is followed closely here. Hoagland poses the questions surrounding the "central enigma" of the Martian ruins in the following way: "From whence - if they really did exist -

²⁸ Ibid.

The Giza Death Star Deployed

came 'the Martians?' For of one thing (and one thing only) regarding this unfolding odyssey I am almost certain: Whoever they were... they did not come from Mars."²⁹ In answer to these questions, Hoagland first disposes of the Martian equivalent of the Pyramid-as-time-capsule hypothesis, a speculation he calls the "message theory." We cite his remarks on the "message theory" at length, since they bear directly on all versions of the Great Pyramid as a message, i.e., the "time capsule" and "prophecy in stone" hypotheses.

(The) central problem with the "message theory" is those pyramids (on Mars) - and their intricate connection with the Face. The sheer scale of engineering behind the construction of this massive "complex" argues compellingly against the message model. It's one thing to inscribe a set of geometric lines on a 20-centimeter panel of aluminum; it's quite another to array quite precisely and geometrically a set of discrete objects, some measuring kilometers across, tens of kilometers around an alien landscape -all ostensibly for the simple purpose of communicating with a remote audience... who might never come!

No, the Face by itself might be a message, but the rest of the associated features - and their inextricable geometric linkage with the face - argued strongly for an indigenous reason for their presence - and all that implies. Which brings us back to where, for me, all mis had truly started: the (Martian) pyramids themselves... and a Terran genius named Soleri.³⁰

Soleri invented, or rather, speculated upon a system of architectural ecologies, or "arcologies" as he called them: massive structures of whole cities housed within one huge building, miles across and extending for hundreds of stories. In other words, Hoagland is implying that the vast architecture and its geometrical layout serves a functional purpose, not a communicative one.³¹

Soleri's reasons for this somewhat exotic idea sprang from an essentially environmental concern: the expanding human population expanded primarily on the earth's surface, consuming more and more of it and damaging the natural ecology of the planet. Hoagland's interest in Soleri's arcologies is thus evident. "What better solution for

²⁹Richard C. Hoagland, *The Monuments of Mars: A City on the Edge of Forever* (Berkeley, California: North Atlantic Books, 1992), p. 235.

³⁰*Ibid.*, p. 237, emphasis in the original.

³¹It should be noted, however, that Hoagland most often resorts to some version of the message hypothesis in his public talks on the Martian Cydonia anomalies.

Dating the Catastrophe and the Compound

maintaining several hundred thousand inhabitants against the currently inhospitable Martian environment...then to house them in a series of vast, artificially constructed enclosed environments...arcologies."³² In other words, an inhospitable Mars, according to Hoagland, was either colonized by an intelligent race from somewhere else, or - if one has been following the exploded planet hypothesis and my argument in *The Giza Death Star* closely - a previously inhabited Mars was subjected to a catastrophe, and the response of the nearly-wiped out civilization based there was to "go inside" the huge arcologies.

Hoagland's answer as to why such a civilization as would colonize Mars would have stopped there and not gone on to the far more hospitable earth is ingenious. A space-faring set of colonists, after a long journey in presumably reduced gravity, would possibly have suffered severe health effects if suddenly subjected to the earth's strong gravity as opposed to Mars' relatively weaker one. The argument, of course, falls if this society possessed the technology to generate artificial gravity.

This leads Hoagland to the construction of a more astonishing scenario. Assuming Mars to have been populated by a space-faring race at the time of the "Martian catastrophe," why then was contact with Earth initiated? According to Hoagland there can be only one conclusion: it was initiated as a desperate measure to preserve their own civilization. After the cataclysm of a nearby planet exploding and inundating Mars with water, the "flood" of the Bible that covered the world and the "whole land" may not have been on earth at all, nor "Noah's ark" a large boat. And as Hoagland and others have pointed out, the Arabic for Cairo, El-Kahira, derives from El-Kahir, meaning Mars.

Of course, the reverse could be equally true, that civilization began on earth, and that humans at one time went to the nearby planets. Let us continue to speculate a bit further. The biblical account of the flood and the destruction of the previously existing civilization makes two things clear: (1) the civilization was a civilization of great leisure and moral corruption, implying technological advancement; and (2) it was destroyed for its wickedness. The peculiar thing that most people

³² Ibid., p. 238.

³³ Hoagland, *op. cit.*, pp. 252-258.

The Giza Death Star Deployed

ignore is that the biblical God usually seems to work "sacramentally," i.e., through physical things or processes, often in concert with and through the actions of men. It is possible then that this paleoancient Very High Civilization was destroyed not only for its own wickedness but by it, i.e., by building and using the Giza Death Star against the ancient, now exploded, planet currently occupied by the asteroid belt. In doing so, it dealt a death blow to Mars, and by use against targets on earth, set off a chain of events that, in combination with the shock from the planetary explosion, altered the environment catastrophically on earth.

A global and interplanetary war, fought between societies of the same civilization in the local planetary neighborhood, and by its representatives on earth, would have decimated the existing technological infrastructure. And as Sitchin's ancient texts reveal, the weapon responsible for this chain of events was permanently incapacitated by the removal of its key working components from its interior once the civilization that built it had been defeated. And it is important to note that the victors, according to Sitchin, used nuclear weapons in order to achieve victory. With the nuclear bombs flying, one gains a horrifying idea of the power attributed to the Weapon in its functional state.

Possible? Maybe.

But there are more problems.

(1)The Contextual Problem: Reconciling the Dates of the Martian Catastrophe and Martian Monuments

As was seen previously, by all accounts, the latest possible date for the Martian catastrophe - the tremendous scouring of the southern hemispheric planetary surface and the massive impact craters from "passing meteors" from the exploded planetary fallout - would be ca. 650,000 BC. The Martian monuments appear, as was also noted, at the "edge" of the damage effects of this catastrophe, making it unlikely that they were structures that "survived" the event, but most likely were constructed by survivors subsequently to it.

But there are considerations that weigh against this view, and militate for the contemporaneousness of the structures and the event.

Dating the Catastrophe and the Compound

First, it seems highly unlikely that such an advanced civilization would construct both the Cydonia compound and undertake the hazardous journey to earth for the purposes of reestablishing their civilization, much less building the Giza Death Star once they had arrived. That is, if one accepts the weapon hypothesis as an explanation of the function of the Great Pyramid, then it is unlikely that the survivors would have made their first priority on earth the building of a massive weapons complex! By the same token, Sitchin's and Dunn's other hypothesis - that the Great Pyramid was a communications device seems, on the basis of similar reasoning, equally implausible.³⁴ Only Dunn's basic hypothesis, that the Pyramid was a "power plant" of some sort, remains plausible on the scenario that it was built by survivors of the Martian catastrophe.

Second, the dating of the Great Pyramid is "open-ended." While carbon dating and other factors point toward a much more recent date, contextual data indicate its construction prior to the appearance of any of the other current structures at Giza. The Martian Cydonia ruins are, conversely, of great antiquity, but the geometries encoded in the D and M Pyramid and other structures on Mars is essentially the same as those found in the Great Pyramid and the positioning of other structures at Giza. This leads to the conclusion that at the very least the two sites share a common cultural origin, and may be a factor arguing for their relative proximity in time. The similarities also suggest that the purpose of Cydonia may not have been the benign "arcology" scenario Hoagland suggests.

Finally, there really is no ultimately compelling reason to assume that the Martian ruins were not contemporaneous with the catastrophe. Artificial, "non-fractal" geometric oddities appear all over the surface of Mars, not just at Cydonia. It is therefore the survival of Cydonia as a complex that intrigues, for it suggests a series of structures designed to survive such events, for we have seen already that ancient testimony regarding the Great Pyramid was that it was designed in part to survive such a catastrophe. In short, it suggests an architecture equally as

³⁴ It should be noted, however, that if there were a source of radiation inside the Pyramid, mat, plus the high reflectivity of its limestone cased faces, would hardly have made it the latest in stealth technology, since it would have painted a very large and strong radar signature, easily visible from space.

The Giza Death Star Deployed

formidable as Soleri's arcologies, but an architecture with a very different purpose. The survival of Cydonia suggests just as easily a possible military function.

Much stronger evidence is presented by Hoagland who uses the geometric relationships of the compound to calculate solstitial alignments. These alignments placed dated the structures to approximately 500,000 B.C., "within the neighborhood" of the latest possible date for the planetary catastrophe. However, it should be noted that Mars researcher Mark Carlotto has significantly revised this date downward, to approximately 120,000 B.C and possibly as late as 33,000B.C. Carlotto's dates would place the Martian anomalies more within the same rough time period as the early dating of the Great Pyramid.³⁶ In either case, dating by alignments is weak, since structures can be built after the fact to align with certain celestial markers at some prior time. In themselves and without corroborative contextual data, alignments are not compelling evidence for the dating of structures.

E. Dating the Planetary Explosion

In the previous chapter it was noted that the exploded planet hypothesis gave a profound explanation of the origins of the orbits of comets, accounted for the presence of the asteroid belt, and gave a credible explanation for the planetary catastrophe evident on Mars and, to a lesser extent, on Earth. Dates of 65 million, 3 million, and 650,000 years ago were all mentioned as being possible windows for the event. With these thoughts in mind, it is now possible to reconstruct a complete scenario.

Circa 650,000 BC, the large water-bearing planet that previously orbited in the asteroid belt exploded, causing enormous collateral damage to its nearest neighbor, Mars, and to a lesser extent, the Earth. The space-faring civilization that was centered upon these three planets disappeared. In a modified version of Hoagland's model, the Martian

³⁵ It goes without saying that much, if not all, of NASA's secretiveness regarding the Martian ruins is explainable not only on the basis that the discovery of ancient "artifacts" may endanger our own cultural assumptions, but also on the basis of the weapon hypothesis.

³⁶ Mark J. Carlotto, *The Martian Enigmas: A Closer Look* (Berkley: North Atlantic Books, 1997), pp. 166, 170.

Dating the Catastrophe and the Compound

contingent "went underground," constructing the enormous arcologies of Cydonia. In my version of this scenario, Cydonia already existed. In the latter version, the "Martian contingent" may have both gone underground as well as launched a (retaliatory?) expedition to the Earth. In yet another version, the death blow to Mars as a civilization was dealt in "the Martian Catastrophe," and the space-faring capabilities of that earth-based civilization were wiped out as a result of the military use of the Giza Death Star and the resulting environmental catastrophes on Mars and Earth.

But we must reckon with one more important oddity in our celestial neighborhood. And a very odd oddity it is.

F. The Weirdly Anomalous Moon

Sir Isaac Newton once quipped that the only thing that gave him a headache was the Moon. And well he might, for as we shall discover, the Moon presented rather dramatic contrary evidence to his theory of gravity. It was, so to speak, the exception that proved the rule. But since his time, the "headache" has graduated from being a mere sinus irritation to a full-fledged migraine.

For perhaps the strongest, or rather, strangest evidence in support of the deliberately exploded planet hypothesis is right next door in our celestial neighborhood: the Moon. Its anomalous properties are unique among celestial bodies, and may be conveniently understood under three headings: (1) its age, (2) its origin, and (3) its high radioactivity.

1. Its Age

When Apollo astronauts brought rocks back from the Moon, and these were tested and dated, the results that were returned challenged some cherished paradigms of the then existing celestial and planetary mechanics. One rock was allegedly dated to be approximately 5.3

The Giza Death Star Deployed

billion years old. If that were so, some researchers concluded that the Moon would have to have had a layer of dust several feet thick. However, when Neil Armstrong made his "giant leap", he did so into "merely an inch or two of dust - the sort of amount that would accumulate in thousands, rather than billions, of years."³⁸ The 5.3 billion year old moon rock, if indigenous to the Moon, would have made it older than the earth. But lack of dust and an uncooperative rock are not the only problems...

2. Its Origin

These results challenged two of the three favored models of the Moon's origin. In one model, the Moon and the Earth were formed from the same cloud of cosmic gas and dust approximately 4.6 billion years ago. In yet another model, the Moon was literally ripped out of the Earth, in the region of the Pacific basin, making it younger than the 3.7 billion years of Earth.³⁹

The results of the Apollo expeditions, in other words, left only one model as a possible model: the "capture model." According to this idea, the Moon was literally a "planet" in the truest sense, a celestial wanderer captured by the earth's gravitational field and locked in orbit aeons ago. But the moon's nearly perfect orbit - an orbit that keeps about 40 percent of its surface permanently from view on Earth - and its rather large size vis-a-vis the Earth compared with the satellites of other planets, make the celestial mechanics of such a capture extremely difficult, if not downright improbable. "NASA scientist Dr. Robin Brett sums it up best: 'It seems much easier to explain the nonexistence of the moon than its existence.'"⁴⁰ But as was noted, Sir Isaac Newton said it even better: "The moon is the only thing that has ever given me a headache."⁴¹

³⁷David Hatcher Childress, *Extraterrestrial Archaeology*, Revised Second Edition (Kempton, Illinois: Adventures Unlimited Press, 1995), p. 11.

³⁸Ibid., p. 16.

³⁹Ibid.

⁴⁰Childress, *op. cit.*, p. 11.

⁴¹Mary Bennet, David S. Percy, *Dark Moon: Apollo and the Whistleblowers* (Kempton, Illinois: Adventures Unlimited Press, 2001), p. 426.

Dating the Catastrophe and the Compound

And lest we forget ancient traditions, rounding off the picture of high lunar weirdness are those "troublesome texts", in this case, texts of Ovid and Aristotle, both of whom mention that the inhabitants of Arcadia in Greece referred to themselves as "Proselenes," a word meaning literally, "people before the moon." According to their myths, they remember a time when there was no moon in the sky!

3. Its High Radioactivity

When Apollo astronauts landed in the various maria of the moon they were to conduct drilling experiments into the surface. The maria are those dark areas of the Moon's surface that are not only mysteriously covered with a glaze like the desert glass of Egypt (a fact suggestive in and of itself) but these areas occur largely on the side of the Moon facing the Earth. They found that it was very difficult to do so since, as subsequent testing demonstrated, they were full of heavy and rare elements such as "titanium, zirconium, yttrium, and beryllium. This dumfounded scientists because these elements require tremendous heat, approximately 4,500 degrees Fahrenheit, to melt and fuse with surrounding rock, as it had."⁴² In addition to this, there are abnormally high concentrations of highly radioactive elements such as uranium, thorium, and potassium.⁴³ Tremendous heat can of course be produced by any number of things, solar flares, being one.

The glassy nature of the Moon's maria plus the evident lack of large scale meteor impacts causing enough heat to create such areas prompted scientists to propose a model to explain their existence. In this model, a massive solar flare scorched the surface of the Moon "some 30,000 years or so ago."⁴⁴ The minor sinus headache now becomes a migraine, for there is, as might be guessed, a "little problem" with this view: why did this solar flare not burn off the Earth's atmosphere or cause other severe environmental catastrophe? There is yet another problem. It is known that these maria are found largely on that side of the Moon's surface facing the Earth. Consequently, if they are the result of a solar flare, then the Moon

⁴² Childress, *op. cit.*, p. 12.

⁴³ *Ibid.*, p. 13.

⁴⁴ *Ibid.*, p. 14.

The Giza Death Star Deployed

would have had to have been in a unique position relative to the Sun and Earth to receive such damage, a position that would appear to be next to impossible.

Other scientists "have remarked that the glassy glaze is not unlike that created by atomic weapons (the high radiation of the moon should also be considered in light of this theory.)"⁴⁵ But again, there is a problem: the maria are much larger than the blast damage of even our largest thermonuclear hydrogen bombs. If they are the result of some deliberate deployment of weaponry, then it would seem unlikely that they are the result of such bombs. If they are the result of deliberate action, whence could such massive damage have been inflicted? If the maria are the result of the intentional use of a weapon, some other type of weapon seems to be suggested, and it is perhaps germane to the case that the maria all face toward earth.

4. Hoagland's "Double Craters"

In a fascinating videotaped lecture at Ohio State University, Richard Hoagland offered evidence to support his theory of ancient, and now battered, artificial structures on the Moon. One of the more compelling pieces of evidence he discusses comes approximately 19 and a half minutes - an odd synchronicity in itself. - into the second tape of Hoagland's Mars: the Mars-Moon Connection. Referring to frame 85M of the Lunar Orbiter photos, Hoagland points out a very curious feature of the Lunar topography in a region near the crater Ukert: double craters, all aligned to the same direction.

One would, Hoagland notes, expect to see double craters occurring in several directions, but not all aligned as if on a grid work, especially if the meteoric bombardment theory of lunar topography formation were the sole mechanism operating. Digging further and zooming in for higher resolution, Hoagland claims to detect oddly geometric structures, like ruins. At this juncture, he asks a simple question. "What causes double craters?" He never answers this, but it is perhaps

⁴⁵Cf. Childress, op. cit., p. 14.

Dating the Catastrophe and the Compound

significant that he shows slides of the ruins of Dresden after the Allied firebombing that left that city shattered.

Hoagland's remarks, and curious choice of slides, almost compel speculation. Perhaps these photographs and the evidence they provide suggesting tall structures on the Moon - some of them miles high - provide a clue why the Apollo manned missions were called off so suddenly and curiously: sending manned missions was simply too dangerous. It would be like trying to land the lunar module in a sea of television towers. It is not insignificant that most recent Lunar probes sent to map the surface are military. Hoagland's "double craters" suggest the deliberate targeting of structures; they might themselves even indicate that the earth was the source of this lunar devastation. Like Hoagland's slide of Dresden prompted him to his own observations, I well remember that as a child I used to stare at the moon and think to myself that it resembled nothing so much as the cratered "moonscape" of the German city of Aachen after the immense Allied artillery and aerial bombardment had all but wiped it off the map.

G. The Distant Origins of Man and Civilization

This scenario is as radical as it is frightening, for it presupposes one of two things.

First, it presupposes that humans are of far greater antiquity than any standard accepted theory maintains; such a scenario requires that modern, intelligent humans have been here on earth for millions of years. Immediately one is confronted by a further problem. Michael Cremo and Richard Thompson, authors of the explosive book *Forbidden Archeology*, put the question succinctly: "If humans had a long time to perfect their skills, then why do we not find ancient artifacts indicative of an advancing civilization?"⁴⁶ In 1863 Charles Lyell was even more to the point: if such an advanced civilization were

⁴⁶ Michael Cremo and Richard L. Thompson, *Forbidden Archeology: The Hidden History of the Human Race* (Los Angeles: Bhaktivedanta Book Publishing Inc., 1996), p. 795.

The Giza Death Star Deployed

once on earth, where are the railroads, electric telegraph lines, astronomical instruments and microscopes?⁴⁷

However, Lyell's comments illuminate another problem: would he have recognized our own superhighways, airplanes, fiber optic cables, radio telescopes and electron microscopes given the much more limited state of technological and scientific advancement of his day? That is, if we posit the existence of a paleoancient Very High Civilization we must also assume not only the existence of intelligent human life, but also the possibility that its science and technology were in advance of our own to the extent that we may not recognize it as such. This poses some very difficult problems and constitutes one of the major weaknesses of the Weapon - or any other revisionist - Hypothesis, as we shall see in chapter five.

On the other hand, we have also seen that in one rare instance, human mythology preserves the memory that there were people on earth "before there was a moon", a notion implying the great antiquity of humanity. Cremo and Thompson, while not providing an extensive survey of the anomalous evidence that would confirm that idea, do provide a small catalog of some of that data at the end of their monumental work. Among these, a nail embedded in Devonian sandstone, which in turn dates from 360 to 408 million years old,⁴⁸ a gold thread embedded in carboniferous stone, stone which is between 320 and 360 million years old,⁴⁹ a copper "coin", hexagonally shaped, discovered in a well boring at a depth of between 114 and 145 feet, with stratigraphy dating to the "Yarmouthian Interglacial period", which would place it between 200,000 and 400,000 years ago!⁵⁰ What makes this coin even more anomalous is that the writing inscribed on it comes from no known language, and cannot be deciphered as no other sample of it exists! Moreover, the "coin" shows all the evidence of having been machined by being passed through a rolling-mill, since it is of uniform shaped and thickness!⁵¹ In Nampa, Idaho, a clay human figurine was discovered from a boring at the 300 feet depth level, contextually placing it in the Plio-Pleistocene age, about 2 million years

⁴⁷ Ibid.

⁴⁸ Ibid., p. 797.

⁴⁹ Ibid., 798.

⁵⁰ Ibid., 802.

⁵¹ Ibid., p. 802.

old. The figurine is a finely sculpted, unmistakably human female figure.⁵² Notably, W.H. Holmes noted that this figurine was strong evidence against the evolutionary hypothesis and the standard dating of human origins, since its antiquity would place it in the same time period as the Java man discovery. Cremo and Thompson then quip: "Here we find the Java man discovery, itself questionable, once more being used to dismiss evidence for humans of modern abilities in the Quaternary or Tertiary. The evolutionary hypothesis was apparently so privileged that any evidence contradicting it could be almost automatically rejected."⁵³

And finally, there is the riddle of "the South African spheres," polished metal spheres, one with three parallel groves running around its equator, that were found in a Precambrian mineral deposit that itself dates to about 2.8 billion years old!⁵⁴ Scientists were quick to dismiss the find as the odd occurrence of "limonite concretions." This is a process that creates rounded rock masses around a nucleus in a kind of "localized cementation."

The problem with this rather artless dodge of the scientists is threefold. First, limonite concretions usually have a Mohs hardness of about 4 to 5.5, meaning that objects occurring naturally by this process are not that hard. The South African spheres, on the other hand, cannot be scratched by stainless steel. Secondly, limonite concretions usually occur in clusters, with globes "glued" to one another like clusters of rocky grapes. The South African spheres, on the other hand, were discovered in isolated circumstances, and are perfectly round. Finally, no explanation yet forthcoming from the "limonite concretion" corner can explain why one of these spheres has three parallel groves around its equator.

The preponderance of Cremo's and Thompson's work suggests that humanity is of very great antiquity indeed. And enough evidence exists to suggest that the hypothesis of a paleoancient Very High Civilization is worthy of at least more investigation. There may be yet to come, in this emerging area of study, further confirmations of a time when people existed "before there was a moon in the sky".

⁵² Ibid., pp. 802-803.

⁵³ Ibid., p. 804.

⁵⁴ Ibid., p. 813.

The Giza Death Star Deployed

And then there is that second problem.... If these artifacts are not evidence of intelligent human presence on earth millions of years ago, then the alternative - the presence of intelligent quasi-human life - can be none too comfortable for contemporary standard theories either. It may well be that the evangelists of both stripes, for evolution or for creationism, may both have to go back to their drawing boards, as their theories look as increasingly questionable as their dismissal of evidence that runs counter to their most prized dogmas.

H. Conclusions

I have posited a scenario in which, its many difficulties notwithstanding, there was a paleoancient Very High Civilization possessed of a highly unified physics, a corresponding "unified technology," and a capability for mass destruction greatly exceeding our own. In this scenario, the Great Pyramid was a weapon of mass destruction, and the focal point of a war fought with nuclear weapons, a war fought at least in part either to destroy it or render it permanently non-operational. By necessity, that war would have to obliterate the knowledge that created it, or leave that knowledge badly damaged and scattered. Such appears to be the case. I believe that the vanquished -the people that actually built the Giza Death Star - as well as the victors, took steps to store some of that knowledge and perhaps even some of the components of their technology in a secret and secure place or places.⁵⁵

Beyond that, it is possible that this scenario may have been even more gruesome, that the Very High Civilization may have been interplanetary in nature, and that "the Great Weapon" may have been used to create system-wide planetary destruction on Mars and the Moon, and perhaps elsewhere. It may be that the world's various "Deluge" accounts, and the ancient myths of planetary battles and destruction, describe essentially the same event. It may even be that the Deluge accounts and their variations of the theme of the Ark describe the catastrophe of another planet.

In any case, the previous scenario has evidence that contraindicates it, and that supports it, and it is best to enumerate these, lest again a

⁵⁵Cf. chapter 4.

wild-eyed "New Age" readership take the previous two chapters in any sense more than pure speculation.

(1) Contraindications

There are several strong factors weighing against the above scenarios, all of which involve the problems of dating:

- By all revisionist accounts, the Great Pyramid, while of greater antiquity than any other monolithic structure found on earth, cannot be dated to any period with any accuracy. Carbon-dating is of no assistance one way or the other, since radiation occurring within the structure at any time would massively distort any obtained results. However, it seems an affront to common sense and reason that the structure is as old as the latest date for the Martian Catastrophe and the explosion of a planet previously found in the asteroid belt. This is because such antiquity for the Great Pyramid, and the resulting sophistication of the society that built it, simply fly in the face of standard scientific assumptions about the biological and cultural origins and evolution of modern man.
- Similarly, a "latest possible" date for the explosion of the now-missing planet of 650,000 years ago would seem an equal affront to reasonable sense.
- Most importantly, the best established dates for the four factors - the exploding planet, the Martian catastrophe, the Cydonia complex, and finally the Great Pyramid itself - are simply irreconcilable in the extreme, spanning a "window" of tens of millions of years, from circa 10,000 BC or older for the Great Pyramid, to 65 million years ago for the planetary explosion.
- Thus, the scenario contains a potentially huge fallacy, namely, that of viewing all four factors as related would be a gigantic case of "begging the question," i.e., the scenario assumes what is to be proven, that the Great Pyramid was a weapon with the power to destroy a planet, and that it was used in that capacity.
- On the last point, it is to be carefully noted that the Pyramid would, on the basis of an analysis in terms of standard

The Giza Death Star Deployed

contemporary physics, and barring unknown fields and forces, be capable of only a few milliamps of power output, hardly enough to light a small lightbulb, much less blow up a planet.

(2) Supporting Factors

There would, however, seem to be three primary factors in support of the scenario:

- There is considerable architectural similarity between the Martian monuments, particularly the "Face" and the "pyramids", and the Egyptian Giza monuments. This architectural similarity exists in three ways:
 - On the criterion of scale: both the Cydonia complex and the Giza compound evidence structures of a gigantic and colossal nature, though the Martian monuments are considerably larger. However, if one assumes that they had some functional purpose similar to Dunn's power plant hypothesis or my weapon hypothesis, this may perhaps be explained by the fact that, in Mars' lower gravity, structures of more immensity had to be built in order to achieve the necessary amplification of the planet's local fields. The explanation may, however, be more mundane, in that the lower gravity would have allowed for structures of larger size to be built.
 - On the criterion of form: both the Martian and the Giza compounds exhibit similarities of design features not shared with similar structures on Earth, namely, the Martian Pyramids are smooth-sided, as are the Giza Pyramids and the pyramids of Dashur. There is thus more similarity of form between the Martian and Egyptian pyramids than there is between the Egyptian pyramids and any other pyramidal structures of Sumeria, Babylon, or the Maya and Aztecs.⁵⁶ Only the step pyramid of Sakkara exists to

⁵⁶ The author is well aware of the smooth-sided pyramids of China and North America. But no investigation of these structures has, to my knowledge, yielded the redundant mathematical properties of the D and M Pyramid on Mars, nor the Great

Dating the Catastrophe and the Compound

contradict this rule, and the contradiction is only apparent, since I am attributing the building of the Great Pyramid to a society other than dynastic Egypt. • On the criterion of survivability: the Great Pyramid and the Martian structures have both survived numerous natural disasters, giving a strong indication that both were, to use the military term, "hardened" sites and structures. Since there is an apparent connection between Giza and Cydonia, and since the Great Pyramid is self-evidently not an arcology, it is reasonable to assume, contra Hoagland, that the Martian structures, and particularly the D and M Pyramid, may not have been arcologies at all, but served some other function. If either version of the machine hypothesis proves correct, the weapon hypothesis or the power plant hypothesis of the Great Pyramid, this would be an indicator of the possible function of the similar Martian structures.

- The second major factor in support of the scenario is - on certain readings of ancient Egyptian (Alford) and Sumerian (Sitchin) texts and corroborated by other ancient traditions, namely the Hindu (Childress) - that human records preserve, albeit in garbled form, the apparently "eye-witness" character recording interplanetary "conflict", planetary explosion, and resulting environmental catastrophe and subsequent human efforts to survive and to ensure the survival of the basic scientific concepts that made the original technologies possible.
- Thirdly, there is no widely accepted model for the sudden and spontaneous explosion of an entire planet except through the scenario of collision with another body of sufficiently large mass to overcome the Roche limit, an event that does happen (as was observed in the collision of the comet Schumacher-Levy with Jupiter). Given a sufficiently large body, a planet could explode. However, such an event has not been observed in modern memory. The argument of Schumacher-Levy and Jupiter really does not address the issue of an acceptable model

Pyramid on Earth. This is only to say, however, that studies of these structures is very inadequate.

The Giza Death Star Deployed

for exploding planets, since the original exploding planet hypothesis was advanced to explain the origin of such comets! There is another frightful possibility - and in the absence of an agreed-upon mechanism for the spontaneous explosion of planets, it is one that must be considered - is the non-natural, deliberate and artificial induction of such an event by a weapon. To put it succinctly, along "artificial" lines, numerous theoretical possibilities exist; all are as equally unlikely, and therefore are as equally plausible, as accidental collisions with randomly roving space debris.

The last consideration may in fact be the most compelling argument for the scenario of the deliberate destruction of a planet "a long time ago, in a galaxy far, far away," in an interplanetary war of horrifying destruction and cataclysmic consequences for earth's environment, for in this instance, one must opt for a long string of chance improbabilities culminating in the collision of two large planetary masses, or for an equally long string of improbabilities leading to the construction and deployment of a weapons system capable of doing so.

It would seem that the ancient records would tip the scale in favor of the weapon hypothesis, since such records would constitute observation, howsoever garbled, as distinct from merely theoretical reconstruction of a remote cosmological past. However it must be emphasized that such records can only be understood as observational testimony by a process of exegetical reconstruction no less complicated than anything a physicist would do in maintaining the "accidental collision" scenario.

The deciding question, then, is whether or not there are indications that there was a physics and engineering sophisticated enough that may once have existed to construct such a weapon. And that in turn requires that one answer the question of whether or not there are indications within contemporary physics whether such a device might be theoretically possible.

Unfortunately, I believe the answer to both of these questions is a tentative "yes." Again, Richard Hoagland points out a remarkable set of observations concerning the state of the ruins on Mars, and the unusual characteristics of some of the craters observed on that planet, in the

Dating the Catastrophe and the Compound

most recent edition of his *The Monuments of Mars: A City on the Edge of Forever*:

... John Brandenburg - a member of the staff of the Sandia Laboratories, in Albuquerque, New Mexico... was heavily involved in the nuclear weapons program. Subsequent to the President's 1983 call for a defense against ballistic missiles, (Sandia) was also at the forefront of the President's Space Defense Initiative - "Star Wars".

Heavily affected by the image of the Face, Brandenburg felt impelled to seek further information. Eventually, by following one lead after another, he found (the Mars Investigation) - and became a member.

A plasma physicist, working with the world's most advanced technology, Brandenburg had access to information of direct relevance to one of the most disturbing observations I had made... that the objects at Cydonia exhibited considerably more than 'natural degradation' - for any reasonable age.

It all went back to those anomalous 'crater counts'...

Was it possible (I'd dared to ask myself, after the numbers consistently came out too high), that the evidence of significant erosion on the Face and pyramids - and the abnormally high number of 1-kilometer craters in the area - were a result of some powerful artificial agent...?

In other words, had life on Mars - the Roman 'God of War' - been exterminated in an all-out nuclear holocaust?

The thought was too fantastic... yet, it could explain a lot of things...the craters...and the other evidence I'd seen; in examining the City under the magnifying glass, I'd viewed direct evidence of melting and flow on the Main Pyramid within the City. In addition, there was the apparent massive destruction of much of the southeast sides of both (sic.) that structure, and the equally puzzling "Fort" - and of forces which (sic, et passim) had, somehow, apparently completely vaporized (or blown off) the "roof which must have originally covered up "the honeycomb!"

Then, there was the strategically placed "impact crater" in the southeastern flank of the D&M pyramid, and the equally suspicious "domed uplift" distorting its geometry. Was this the work of some kind of "rocket-borne explosive" - which had penetrated the interior of the pyramid, and then detonated, leaving an exit "blow-hole" type crater, and severe internal structural deformation?

Very cautiously, during our second phone call, I explored with John the kinds of craters a nuclear exchange would leave behind, and the "statistical anomalies" of so many craters on the objects of most interest - like the Face and the D&M pyramid.

It was his suggestion that, if the craters on this part of Mars were "artificial," there would be a way to tell - because nuclear explosions (as opposed to meteor craters) would be shallower... On the other hand, he said

The Giza Death Star Deployed

(undercutting in his next breath, my brief hope that here was a definitive test!), the craters produced in targets in the lab, as parts of the new Space Defense Initiative tests, were deep, not unlike meteor craters themselves - a direct result of the way they were produced: by the exotic particle beams "burying" their energy deep within the targets.⁵⁷

If Hoagland's and Brandenburg's scenario is correct, and the Cydonia damage is "artificially induced" by "deep impact" focussed exotic particle beams, then this is loose corroboration of the scenario I have outlined: the Great Pyramid, if it was a weapon, was a weapon using in part such directed energy.⁵⁸ Moreover, it is also loose corroboration of another scenario, that of Zecharia Sitchin, whose texts not only posit that the Great Pyramid was some sort of weapon, but that the society eventually victorious over that of its possessors had to utilize nuclear weaponry in order to force a victory.

These speculations shed not a little light on why, behind the scenes, an effort may be underway to divert popular attention from the recovery of that physics into other hypotheses, into "messages", time-capsules, stargates and resurrection machines, planetary defense grid mechanisms, hermetic devices and other non-Egyptological hypotheses, since an extraordinary technology with huge weaponization potential seems to exist at Cydonia, and, of course, at Giza.

Something like a "cosmic Giza cover-up" may be underway...

...an astonishing idea, especially since the resemblance between the movie Star Wars, ancient accounts of planetary wars and Sitchin's "Second Pyramid War" have so many points in common, and especially in view of the fact that the best explanation for our own Moon's extraordinary size - and almost perfect binary planet system orbit vis-a-vis the earth - is the most radical one: that it was precisely placed in position...

⁵⁷Richard C. Hoagland, *The Monuments of Mars: A City on the Edge of Forever*, 5th Edition (Berkeley, California: North Atlantic Books, 2001), pp. 148-149.

⁵⁸Though it should be recalled that I do not believe this was its main component or energy "kick", the main punch being supplied and directed to target by non-linear energy.

THE GIZA DEATH STAR DEPLOYED:
PART TWO:
A BRIEF HISTORY OF THE EXOTERIC AND ESOTERIC
INVESTIGATIONS OF THE GREAT PYRAMID

NEWTON'S GRAVITY AND PYRAMID MEASURES: A BRIEF HISTORY OF EXOTERIC SCIENTIFIC INVESTIGATION OF THE GREAT PYRAMID

"One cannot help but wonder whether Howard Vyse was being utilised by the British secret services and, if so, what interest such authorities might have had in seeing the Great Pyramid firmly attributed to the Egyptian king Khufu. "
Alan Alford, *The Phoenix Solution*¹

High strangeness always seems to surround the Great Pyramid. Its wondrous mathematical and physical properties are well known. Its builder(s) are not. There is no equivalent plaque saying "Body by Fisher", no "Made in the Fourth Dynasty" or "Product of Mars" label attached to the structure anywhere. No carving on a cornerstone proclaims it to be "In Loving Memory of Thoth."

In the absence of any direct testimony as to who its builders were, claimants of every type have been argued for, from Egyptian kings to an endless succession of proponents of prophecies in stone, of stargates or other exotic machines. And I include myself in the latter category. In short, no one knows who built it, nor when, nor why. All we have are inferences, conjecture, and some horrifying suggestions from the ancient texts.

The terrible clarity of some of the ancient texts highlights a puzzling fact, and shines a spotlight on an entirely different cast of characters and set of anomalous questions regarding the Pyramid. And writ large over the playbill and plot synopsis is one, looming question: Why, after the publication of Zechariah Sitchin's *The Wars of Gods and Men*, has no one except this author stepped forward to investigate the weapon hypothesis?² Surely such a hypothesis, suggested by the ancient texts, is so radical and so pregnant with huge implications for human science, military technology, geopolitics and history, that someone else would have noticed and undertaken an investigation. It is therefore the deafening silence that puzzles, especially when considered

¹ Alan Alford, *op. cit.*, p. 117.

² Two other authors allude to the weapon hypothesis, as will be seen later in this chapter. However, they do not attempt to investigate the hypothesis, they merely mention it.

The Giza Death Star Deployed

against the backdrop of the rather noisy effort being made to assert that the Pyramid and the Giza compound contain some "ancient wisdom" of benefit to humanity. Such musings suggest that some sort of deliberate manipulation of opinion might be occurring with the recent Pyramid research.³

And this means that an investigation of the investigators may itself uncover some interesting things, perhaps even things that would directly or indirectly corroborate the weapon hypothesis. After all, if anyone ever previously considered the Great Pyramid to be of any military significance, then one would expect to find recurring military and intelligence interest in the structure.

Almost as soon as this thought is entertained, one recalls the huge military expedition of Napoleon Bonaparte. A large French fleet of frigates and ships-of-the-line transports thousands of French soldiers and the little corporal himself, along with scores of France's finest scientists, archaeologists and linguists, to Egypt. Why, in a time of lingering instability in revolutionary France and the attendant international tensions in Europe, is this militarily outlandish scheme undertaken by the nineteenth century's otherwise undisputed master of cold calculation in geopolitical and military affairs? In view of the British mastery of the seas, when the ultimate French retreat from Egypt was a foregone conclusion, why was the expedition undertaken at great expense and great military risk in the first place?

The history of the overt modern scientific investigation of the Great Pyramid is therefore connected, at almost every step, with more hidden religious, military, or even esoteric "occult" agendas. And to appreciate this fact, one has only to glance at the one "solid" and "conclusive" piece of evidence tying the Pyramid to the Egyptian king Khufu, the discovery by Howard Vyse of hieroglyphic inscriptions in the chambers above the King's Chamber in the nineteenth century. In this case, the middle is the best place to begin the story.

³Of course there is a beneficial aspect to the physics that would have made the Giza Death Star possible, not the least being the ability to draw energy from the quantum vacuum. But the ancient texts do not speak of the Great Pyramid in anything but military terms.

Newton's Gravity and Pyramid Measures

A. Howard Vyse 's Forgery and Military Connection

The remarkable thing, known to most "revisionist Egyptologists," is the almost total lack of mention of the Giza structures, and particularly of the Great Pyramid, in Egyptian texts. As was seen in my previous book *The Giza Death Star*, such texts as do mention the structure do so only with ambiguous phrases. And like all ambiguous phrases, such "mentions" are subject to interpretation; they might not be referring to the Great Pyramid and the surrounding structures at all.

How does one explain this curious lack of mention on the part of a society that was meticulous in its record keeping? The lack of records is almost as much of a mystery as the two great Pyramids themselves; indeed, if they were not currently visible, it is questionable if anyone would believe they had ever existed. The ancient Egyptians simply assumed everyone would know about them and thus there was no need to talk about them, or maybe even they, or the people alive at the time of their building, were not completely "in the loop" as to the reason they were being constructed. Finally, if the weapon hypothesis is true, one must also consider the possibility that they were simply "classified" and that public discussion of them may have been forbidden.

Howsoever one interprets this mystifying relative "silence" concerning the Great Pyramid and its large sister Pyramid, the fact remains that the only unequivocal mention of Khufu in connection with the Great Pyramid is the discovery of hieroglyphs in the so-called "relieving chambers" above the main room of the King's Chamber. These glyphs clearly mention Khufu, and their occurrence in the structure itself constitutes strong contextual evidence that the structure was built by that Egyptian king. At least, that is the case as far as the standard line of Egyptology goes.

But there is a problem, and the problem is who discovered these glyphs, and how they were discovered. Once again, Alford states the case and its implications very succinctly.

Let us now return to the inscription of Khufu's name inside the Great Pyramid which (sic. et passim), as I mentioned earlier, potentially offers the key to dating the entire Giza complex. Since this inscription was found inside a part of the Pyramid which had previously been sealed, it is by far the strongest evidence that Khufu actually built it. Is this inscription genuine, or

The Giza Death Star Deployed

is it a fraud? If it is genuine, we will need to ask how Khufu could have produced such a revolutionary structure. If it is a fraud, we will need to seriously consider (sic.) a pre-dynastic origin for the Great pyramid, as indicated by the evidence from radiocarbon dating.

The discoverer of the controversial inscription was an Englishman named Richard William Howard Vyse (1784-1853), who came from a well-to-do military family from Buckinghamshire. Howard Vyse had retired from the British Army as a Colonel at the surprisingly young age of forty-one, with twenty years or so of military service behind him. It is believed that his family financed his expedition to Egypt between 1835 and 1837, but a hidden agenda behind this benevolence is revealed by the comments of one of Howard Vyse's descendants that the Colonel was rather better at archaeology than soldiering, and, furthermore, was 'rather a trial to his family.'⁴

Vyse arrived in Egypt when he was fifty-one, and during a time when Egypt seemed abuzz with a discovery-a-day, Vyse was "desperate to make a name for himself."⁵

In February 1837, Vyse made his discovery. The first of the "relieving chambers" above the main room of the King's Chamber was named Davidson's chamber, after its discoverer Nathaniel Davidson who made found it in 1765. Vyse, discovering a crack in the granite ceiling, was able to determine (according to one story by poking a reed through the crack) that yet another chamber existed above Davidson's chamber. Using gunpowder to help tunnel his way through the relatively softer limestone, Vyse soon found the four remaining small chambers, similar in all respects to Davidson's chamber, with one exception: writing, the only writing in all the Great Pyramid, in chambers even more inaccessible than the others. Within the second, fourth, and fifth chambers, Vyse claimed to have found three inscriptions of King Khufu.

Unfortunately, the whole "discovery" occurred in a context casting a long shadow of suspicion over the whole affair. For one thing, Vyse had almost total control over the compound during his expedition. Thus there were none of the scientific controls normally used in archaeology. As Alford puts it, "There was absolutely nothing to prevent Howard

⁴ Ibid., p. 113.

⁵ Ibid.

Newton's Gravity and Pyramid Measures

Vyse from committing a fraud."⁶ The argument that he did commit a fraud is rather strong:

- All the chambers opened by Vyse contained inscriptions, whereas Davidson's chamber did not.
- All the inscriptions were found on walls except the eastern walls which he had "blasted through," a fact which struck Alford, and this author, as just too convenient to be true.
- Vyse's expeditionary logs appear to manipulate dates of the discovery of a stone outside the Pyramid bearing Khufu's name to a point after, rather than before, he made his chamber inscription discoveries.
- The original diaries have conveniently disappeared, making it difficult to check for possible manipulation of dates.⁷

And finally, one important fact must not be overlooked. The Egyptian authorities have steadily refused to have the ink of the inscriptions carbon-dated. Such testing would conclusively demonstrate whether the Vyse inscriptions were forged.

With all this evidence in hand, and taking into consideration the data presented in *The Giza Death Star* and by numerous other authors, I cannot help but conclude that the Vyse inscriptions were forgeries. But why would Vyse have endeavored to perpetrate such a monstrous fraud on archaeological science and historiography? A clue not only to why, but to who might have ultimately desired such a fraud, lies in Vyse's subsequent career success:

Finally, we must question whether Howard Vyse was really acting as an independent researcher, or whether he was working for the British Government. It is suspicious that, having retired from active service (on half pay) in 1825, Howard Vyse should have received a promotion to full Colonel in the British Army on 10th January 1837, during his three month absence from Giza. It is equally suspicious that he was subsequently promoted to the rank of Major General on 9th November 1846, despite his official 'retirement' during the preceding 21 years. One cannot help but wonder whether Howard Vyse was being utilised by the British secret

⁶ Ibid., p. 116.

⁷ Ibid.

The Giza Death Star Deployed

services and, if so, what interest such authorities might have had in seeing the Great Pyramid firmly attributed to the Egyptian king Khufu.⁸

Why indeed, unless, of course, one recalls that, especially during that time, the British secret service was the almost exclusive preserve of the Masonic and other esoteric fraternities, and that it had indeed been the preserve of such fraternities since its earliest modern associations with Sir Francis Wallingham and Sir John Dee, from the reigns of Elizabeth I to James I and beyond.

But why would Masons want to attribute such a structure to Khufu? There seem to me to be two possible answers to this question. Either they wished to establish yet another link between ancient Egypt and their own "quasi-Egyptian" Masonic doctrines and traditions, or they wished to misdirect attention from something else they did not wish the general public to know, such as ancient science or technology that they may have had in their possession.

In any case, the possible association of Vyse with more hidden agendas of secret societies and government agencies is not a new story. Vyse is one of many, going back to Newton - himself a member of the Royal Society - and Vyse's own contemporary, Napoleon Bonaparte, and looking forward to the more dubious associations and agendas of researchers continuing down to our own day, which will be explored in the next chapter. Vyse's "discoveries" hover on the fuzzy borderline between the legitimate exoteric research, and the more occulted esoteric investigations of the Great Pyramid.

B. Greaves

The history of scientific curiosity concerning the Great Pyramid began after the Renaissance, with the well-known interest of Sir Isaac Newton in the structure being the most obvious example. Others, however, have also contributed significantly to the enormous pile of odd mathematical and physical "coincidences" that the structure holds. John Greaves, a young mathematician and astronomer educated at Oxford University, set off in 1638 searching for data that might establish the exact dimensions of the earth. This was no idle or impractical scientific pursuit. In the aftermath of the discovery of the

⁸ Ibid, p. 117.

Newton's Gravity and Pyramid Measures

New World and the flurry of imperialism on the part of the European powers, navigation - and exact and precise charts - became essential. It was, literally, and for the English especially, a matter of national security.

A clue to a possible solution had been postulated by Girolamo Cardano, an astonishing Milanese physician and mathematician of the early sixteenth century and a close friend of Leonardo da Vinci's, who maintained that a body of exact science must have preexisted the Greeks. Cardano suspected that a degree of meridian (far more exact than that of Eratosthenes, Ptolemy, or Al Mamun) must have been in existence hundreds if not thousands of years before the Alexandrians and that to find it one must search in Egypt. Pythagoras was said to have claimed that the measures of antiquity were derived from Egyptian standards, themselves copied from an invariable prototype taken from nature. It followed that the pyramids might have been built to record the dimensions of the earth and furnish an imperishable standard of linear measure.⁹

Note carefully what the Renaissance scholars and scientists were saying here: the pyramids, and in particular the Great Pyramid, were constructed as analogs or "scaled down" versions of the earth itself. They were constructed in a ratio or harmonic relationship to the earth. Had these scientists been familiar with the term, they might even have gone on to say that the Great Pyramid was constructed as an analog computer. The importance of this possible "computer" function to the weapon hypothesis will be discussed in Part Three.

Though almost everything Greaves came across in his study "was a puzzle to him" he nevertheless, as a good scientist, carefully collected data and published the results. And he also made one of the first discoveries that would later be corroborated by others who entered the structure, a discovery that strongly suggests a machine function was the original purpose of the structure, though Greaves did not, apparently, pursue it.

Entering the Pyramid and beginning his descent down the Descending Passage, he was assailed by a blizzard of bats "so ugly and so large, exceeding a foot in length" that he decided to scare the bats away by firing his pistol. To his surprise, "the explosions reverberated like cannon shots in the restricted passage of the Pyramid."¹⁰

⁹ Peter Tompkins, *Secrets of the Great Pyramid* (New York: Harper and Row, 1971), p. 22.

¹⁰ *Ibid.*, p. 25.



Close-up of the pyramids from the Mars Viking Frame 35A72.
Did this installation mirror the one at Giza?

Newton's Gravity and Pyramid Measures

of the Greatest Pyramid, as taken by Mr. John Greaves, the ancient Cubit of Memphis is determined.

But why should a scientist of Newton's stature have spent so much time searching for an ancient unit of measure in the dimensions of the Great Pyramid? The answer is simple, but breathtaking:

Newton's preoccupation with establishing the cubit of the ancient Egyptians was no idle curiosity, nor just a desire to find a universal standard of measure; his general theory of gravitation, which he had not yet announced, was dependent on an accurate knowledge of the circumference of the earth. All he had to go on were the old figures of Eratosthenes and his followers, and on their figures his theory did not work out accurately.

By establishing the cubit of the ancient Egyptians, Newton hoped to find the exact length of their stadium, reputed by classical authors to bear a relation to a geographical degree, and this he believed to be somehow enshrined in the proportions of the Great Pyramid.¹³

Though Greaves' measurements were ultimately incorrect, Newton's extrapolations from them were not. His figure for the Egyptian "sacred cubit" was very nearly perfect...and consequently, so was his theory of gravity.

Let us pause to consider what Newton's - as well as other early modern scientists' - preoccupations with the structure really mean. First, they indicate that these scientists knew about, and took seriously, the notion that there was an ancient scientific tradition that could possibly be reconstructed by careful attention to texts and ancient structures. Secondly, and much more importantly, it means that Newton's theory of gravitation itself not only emerges in the context of such "paleoscientific pursuits", but more specifically is directly and immediately associated with the Great Pyramid. It is the first known and documentable example of a connection between the structure at Giza and the force of gravity.

The discovery of the measure of n in the structure had to wait until the nineteenth century, and the careful calculations of an amateur mathematician and astronomer named John Taylor. Wondering why the Pyramid would have been constructed along the peculiar - and very steep - angle of $51^\circ, 51'$, Taylor concluded that the surface area of each

¹² Ibid.

¹³ Ibid., p. 31.

The Giza Death Star Deployed

face of the structure equaled the square of its height. Thus, if he divided the perimeter of its base by twice the height, the quotient was 3.144, which was remarkably close to π .¹⁴ The height of the Pyramid in relation to its base perimeter appeared to be that of a radius of a circle to its circumference! The Pyramid was, in effect, a squared circle and a cubed sphere.

Reviving a notion first proposed by one of Napoleon's scientists, Taylor then suggested that its ancient designers had measured the length of a degree, multiplied it by 360, and divided it by n and had thus deduced the polar radius of the earth. Summing all this up, Taylor concluded that "It was to make a record of the measure of the Earth that it was built."¹⁵ In other words, the Pyramid was a kind of imperishable "Bureau of Standards."¹⁶ He also noted that the base of the structure was a very close approximation of the length of the solar year. Taylor was, of course, not incorrect in this statement nor in his general observations, for if the weapon hypothesis is true, the Pyramid had to be constructed as a scale analog of the very systems it would oscillate, and thus it had to have been constructed according to exacting - and physically based - units of measure.

D. Smythe, Petrie, and Davison

Confirmation of these early exoteric scientific investigations of the Pyramid began with the strange career of Piazza-Smyth. Smyth was the first in modern times to undertake a really thorough and comprehensive survey of the compound and the Great Pyramid. It was Smyth who discovered the embodiment of the mean distance between the earth and the sun in the structure,¹⁷ among many other amazing correlations made by him.

These correlations dogged him throughout his career, for they were immediately seized upon by the nineteenth century's equivalents of

¹⁴Ibid., p. 70.

¹⁵Ibid., p. 72.

¹⁶ Ibid., p. 75: "From all his studies, Taylor concluded that the proportions of the Pyramid had definitely been intended to incorporate geometric and astronomical laws simply and easily expressed, and that its purpose had been to preserve and pass on this knowledge to future generations."

¹⁷ Ibid., p. 94.

Newton's Gravity and Pyramid Measures

"New Agers". Smyth's measurements, for example, provided the fuel for some people to argue that the Pyramid's inner passageways and chambers were "prophecies in stone". This association of Smyth's surveys, the Pyramid itself, with wild-eyed "dispensationalist 'theology'" and "Bible prophecy", not to mention Smyth's own apparent religiosity, spurred a new investigative effort, the effort associated with the "Father of Pyramidology" without whose work no Pyramid researcher's library is complete: Sir William Flinders Petrie.

Fascinated with ancient systems of measure since his youth, and an avid reader of Smyth's *Our Inheritance in the Great Pyramid*, he was "determined to prove whether or not Taylor and Smyth had been correct in their theories regarding the Pyramid."¹⁸ While Petrie was considerably more objective in his descriptions of the workmanship of the structure than many others, taking care to note sloppiness as well as craftsmanship, nonetheless the overall quality of workmanship could not be gainsaid.

Eventually he did manage to uncover more casing stones, as well as the base of the Pyramid. Petrie found the workmanship on the original casing stones, some of which weighed over 15 tons, quite as remarkable as Howard-Vyse had described it. The faces were so straight and so truly square that when the stones had been placed together the film of mortar left between them was on the average no thicker than a man's nail, or 1/50 inch over an area of 35 square feet.

Petrie found that the mean variation of the casings from a straight line and a true square was but 1/100 inch on a length of 75 inches. This staggering accuracy was equivalent to the most modern optician's straight edges.

As Petrie remarked, "Merely to place such stones in exact contact would be careful work, but to do so with cement in the joint seems almost impossible; it is to be compared to the finest opticians' work on a scale of acres."

So fine was the texture of the cement that after millenia of exposure to the elements, the stones shattered before the cement would yield.¹⁹

Petrie's careful measurements and analysis, evident in his minute examination of the casing stones and mortar, almost spelled the death knell for Taylor and Smyth's theories.

¹⁸ Ibid., p. 98.

¹⁹ Ibid., p. 105.

The Giza Death Star Deployed

Taking the true base length of the structure to be defined "not by the limit of the sockets as measured by Smyth" but by the actual edge of the corner casing stones themselves located some 20 inches higher, this gave a base measurement of 9069 inches, instead of Smyth's 9140 inches. Petrie also discarded Smyth's (and Newton's) notion that the cubit used was approximately 25.025 inches, and took the only cubit used to be the much smaller "profane" or "royal" cubit of 20.63 inches. This produced a base of 440 cubits and a height of 280 cubits. "This confirmed Taylor's theory to the extent that the Pyramid was intended to symbolize the globe by giving a very effective n value of $22/7$, or 3.14289, but apparently nullified Smyth's theories about the perimeter giving the exact number of days in the year. The new product gave only 362.76 days."²⁰ Academicians leapt to bury Smyth's theories. Smyth's equally careful measurements and drawings were relegated to the academic dustbin. As Tompkins notes, "Had it not been for the careful work of some conscientious scholars, Smyth and Taylor would have suffered the fate of Paracelsus and Mesmer, being relegated in the history books to the role of mountebanks."²¹

David Davidson began his "pyramidological" career with the avowed intention of destroying the "Pyramid-as-Bible prophecy" hypothesis. What he ended up doing was reconciling Taylor, Petrie, and Smyth. Noting that Petrie himself had carefully observed the slight indentation of the faces of the Pyramid, he "noted that Petrie had failed to extend this hollowing of the core material to his measurements of the outside casing. If this were done, a base length was obtained which fitted Smyth's theoretical length to account for the solar year, to four points of decimal."²² This hollowing had stunning visual confirmation with a photograph shot by British Brigadier P.R.C. Groves (cf. Figure One).

²⁰Ibid., p. 106. Note again the role of approximation in the Pyramid's engineering.

²¹Ibid., p. 107.

²²Ibid., p. 108.

Newton's Gravity and Pyramid Measures

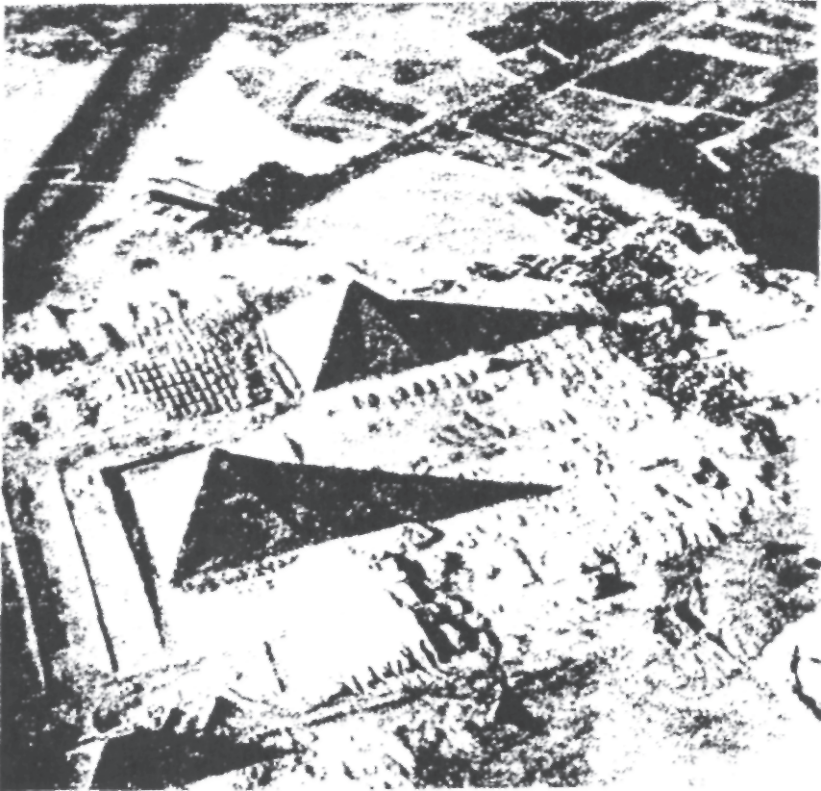

Ironically, in a little known etching made by Napoleon's scientists, the Pyramid was showing with its casing stones intact but with the apex still missing, with the apothem clearly visible. Factoring out the Sphinx in the foreground and the smaller pyramids in the background, the structure looks eerily modern and military (Figure Two).

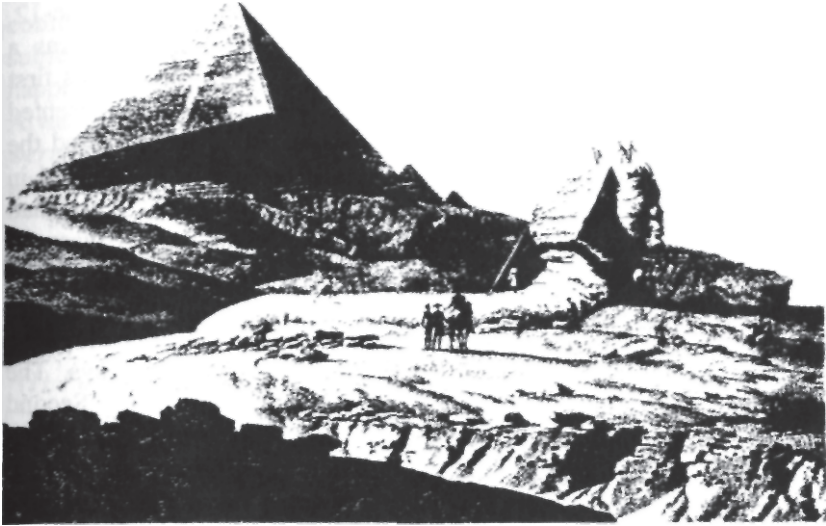

Figure Two:
The Napoleonic French Etching Showing the Apothem of the Great
Pyramid's Faces.

In any case, Davidson's work opened the floodgates and esoteric interests (cf. the next chapter) and serious exoteric science joined forces against the common enemy: the "tomb of Khufu" hypothesis. After Davidson's work, every conceivable mathematical and physical correlation would be tested, and, more often than not, corroborated.

E. The Strange Anomaly of Dr. Luis Alvarez

On the borderline of this dangerous territory between the open and exoteric investigation on the one hand, and the esoteric scientific research of the Great Pyramid on the other, lies the work of Dr. Luis Alvarez, a man well known both to "mainstream science" as a Nobel prize winner and former Manhattan Project scientist, and to researchers in the more esoteric field of UFOlogy as one of the first scientists to arrive at the alleged UFO crash site in Roswell, New Mexico in 1947.

Newton '\$ Gravity and Pyramid Measures

He is a known member of an early 1950s CIA study of UFOs, and is alleged to have been a consultant to the super-secretive UFO government study group, Majic-12, also known as Majestic-12. According to UFO investigator Richard Dolan, Dr. Alvarez was a member of the CIA's UFO Robertson Panel and was present at its first meeting.²⁴ Dolan notes that "the panel concluded that UFOs presented no evidence of a direct threat to national security. Toward this end the report indicated that both Robertson and Alvarez had been involved in investigating foo fighters during the Second World War [!] and had found them unexplained but harmless."²⁵ As we shall see, Alvarez is not the only physicist to have some strange areas of research on his curriculum vitae.

Alvarez led an expedition to Giza in 1968 to look for hidden chambers in the Second Pyramid of Khafre using cosmic rays. The reasoning was simple: if there was a hidden chamber in the Second Pyramid, more rays would penetrate through that empty space than through the rock of the structure and these could be precisely measured with equipment. Curiously, Alvarez' team was comprised of people with some interesting connections including the US Atomic Energy Commission. One Egyptian team member, Dr. Amr Goneid, was heard to have stated that the results of the study "defied all known laws of physics."²⁶ According to the report of a London Times reporter, each time that Dr. Goneid ran the taped results through the computer, a different pattern resulted, a scientific impossibility. Asked by the reporter to comment on this, Dr. Goneid replied, "Either the geometry of the pyramid is in substantial error, which would affect our readings, or there is a mystery which is beyond explanation - call it what you will, occultism, the curse of the pharaohs, sorcery, or magic; there is some force that defies the laws of science at work in the pyramid."²⁷ Suffice it to say that this author does not believe any occult forces or sorcery was involved at all. Only our understanding of the harmonics of space and time are inadequate.

²³ Picknett and Prince, *The Stargate Conspiracy*, p. 83.

²⁴ Richard Dolan, *UFOs and the National Security State: An Unclassified History, Volume One: 1941-1973* (Keyhole Publishing Company, 2000), p. 195.

²⁵ *Ibid.*, p. 196.

²⁶ Picknett and Prince, *op. cit.*, p. 83.

²⁷ Tompkins, *op. cit.*, p. 275.

The Giza Death Star Deployed

Dr. Alvarez's response to his Egyptian colleague's musings are illuminating. As Picknett and Prince observe, "Once again the confusion machine seems to have gone into overdrive: Alvarez subsequently announced from America that nothing untoward had happened, and that no new chambers had been detected."²⁸ What Alvarez had not done, of course, was to explain the anomaly itself: why were the magnetic tapes and x-ray data hopelessly "scrambled"? And why had this occurred in the Second Pyramid?

Perhaps Alvarez's team had indeed stumbled upon some machine function or properties of the second structure, for subsequently a NASA team investigated acoustic properties of the Great Pyramid, properties well-known since Greaves' time.

(1) First Observations of the Great Pyramid's Acoustic Amplification Properties

The first indication of a machine-like function of the Great Pyramid occurred during the Napoleonic expedition. Reaching the top of the Grand Gallery and noticing the echo of their voices in the chamber, Bonaparte's soldiers fired off a pistol. To their amazement, the report rolled off down the Gallery like roaring thunder, amplified many times over.²⁹ And the acoustic properties of the coffer were first observed by Petrie who noticed it produced a rich, deep and eerily beautiful bell-like sound when struck.³⁰ And Davison himself made the significant discovery of the first chamber above the King's Chamber by noticing that his voice was "answered by echoes which appeared to resonate from somewhere above him."³¹ One conclusion seems safely warranted from this testimony: at least one function of the Great Pyramid was to resonate and amplify acoustic energy.

F. Conclusions and Corroborations

We are now in a position to highlight some of the conclusions of this brief review of exoteric scientific investigation.

²⁸ Picknett and Prince, *op. cit.* ²⁹ *Ibid.*, p.41.

³⁰ *Ibid.*, p. 108.

³¹ *Ibid.*, p. 35.

Newton's Gravity and Pyramid Measures

- The first known association of the Great Pyramid with physical forces was in fact through Newton's theory of universal gravitation. This association was made by Sir Isaac himself as part of the dimensional analysis he needed to make the mathematical model of his theory accurate. This would appear to corroborate the gravitational effects mentioned by Sitchin's ancient texts as occurring around the structure, and would corroborate the hypothesized functions of the structure mentioned in The Giza Death Star.
- The Great Pyramid does appear to be constructed as an analog of known physical and mathematical constants, and may have been constructed in part to fulfill the function of an analog computer. Such analog computer functions would be entirely necessary to the structure if it was designed to oscillate targets in nearby space. Such a function would require great precision in its measurements, a feature repeatedly observed in the Great Pyramid.
- There does appear to be a covert, esoteric, and/or military interest in the structure, evident in the expedition of Napoleon, of Col. Howard Vyse, and more recently, with the expeditions of Alvarez and others with known scientific and military connections.

Indeed, with the presence of Dr. Alvarez and the various agencies with which he and others are associated, one has perhaps the strongest indicator that someone, somewhere, knows that there is a great deal of very sophisticated - and potentially very destructive and weaponizable - physics present in the structure. It seems reasonable to conclude, then, that every effort would be made by such people and agencies to deflect the attention of the general public away from any investigation of that physics and of the "machine" and/or weapon hypotheses. Every effort would seem to be warranted to channel curiosity in the direction of "ancient observatories", "prophecies in stone," "stargates," "imperishable Bureaus of Standards," or, for the most recalcitrant, elaborate tombs for Egyptian kings.

SECRET SOCIETIES, PSYCHICS, SPIES, SS, SOVIETS AND SCALARS: A BRIEF HISTORY OF THE COVERT AND ESOTERIC INVESTIGATION OF THE GREAT PYRAMID

"...a much wider conspiracy is revealed. This extends well beyond the confines of Egyptology - Old or New - and involves several intelligence agencies, including the CIA and Britain's MI5, occult groups, and even some of the world's top scientists."

Lynn Picknett and Clive Prince, *The Stargate Conspiracy*

A. No Machines Please!

In my opinion, one of the most perplexing things about Pyramid research is the almost total absence of stupefied, frenzied discussion, followed by expeditions and experimentation that normally accompanies such a book as Christopher Dunn's *The Giza Power Plant*. His hypothesis is gripping, the argumentation solid and overwhelming. And most importantly, Dunn alone of all the "revisionist" researchers into the Great Pyramid does not allow himself to get too carried away by extraneous hypotheses of aliens, pyramids-as-stargates or resurrection machines, "messages of a lost civilization", or extraterrestrials. He seeks almost exclusively to explain the structure and its purpose on the basis of known engineering principles. That is the great merit of his work.

But after an initial frenzy, an appearance or two on overnight radio talk shows, a few articles here and there, the rest of the revisionist Egyptological¹ world hardly mentions his work at all. After all, if it was "just a machine," then all the fanciful notions of ancient aliens-as-gods, stargates, prophecies in stone, resurrection machines, and Halls of Records filled with ancient secreted caches of information "beneficial to humanity in its hour of crisis" come tumbling down. Dunn's work, like Petrie's,

¹By "revisionist Egyptology" I mean the thesis that the Egyptians did not build the Great Pyramid (and many other major monuments at Giza), and that the structure antedates them by several thousand years. Thus, the phrase is also a term of convenience to denote any hypothesis of the Great Pyramid's purpose and function other than as a tomb. One telltale marker of a revisionist Egyptology is the redating of the Pyramid or Sphinx to much earlier dates.

appears somewhere between the warring camps of Egyptologists defending the outlandish tomb hypothesis, and the Revisionists defending their own agendas.

It is as if Dunn's work was being met by intentional silence and neglect, and another agenda being advanced altogether.

1. Criticism's of Sitchin's Handling of Texts

Much of the ancient evidence regarding the Great Pyramid being a weapon of mass destruction comes from Zechariah Sitchin's treatment of the ancient Sumerian epic poem, the Lugal-e. Richard Hoagland himself maintains that Sitchin reads the cuneiform "like some kind of ancient New York Times."² John Anthony West complains that textual subtleties totally elude Sitchin, complaining that "his views are essentially simplistic and materialistic. He is a mechanistic reductionist and a throwback to 19th century positivism."³ But it is not so easy to dismiss Sitchin as all that.

For example, Barton's own translation of the Lugal-e contains significant phrases suggestive not only of weaponry of mass destruction, but phrases that could suggest the Pyramid. There are references to the "destructive axe,"⁴ the "mountain of fate,"⁵ the "great mountain,"⁶ the "inaccessible mountain,"⁷ the obliteration of Ur,⁸ and the "bright weapon of royalty."⁹ Most importantly, even in Barton's rendition of the epic, the use of a weapon of mass destruction occurs in a context where it pre-dates the Flood and is somehow connected with it.¹⁰

So it would appear rather that Sitchin touched an exposed nerve, perhaps getting too close to something that someone did not want talked about. This implies a certain degree of "misdirection" in research that does not toe the standard Egyptological party line.

²J. Douglas Kenyon, "Visitors from Beyond," *The Search for Lost Origins (Atlantis Rising)*, 126-132, pp. 128, 129.

³Ibid., p. 129.

⁴George A Barton, *Miscellaneous Babylonian Texts (Yale)*, p. 21.

⁵Ibid., p. 28. It should be noted that this could equally be translated "mountain of destiny."

⁶Ibid., p. 37.

⁷Ibid., p. 6.

⁸Ibid., p. 47.

⁹Ibid., p. 51.

¹⁰Ibid., pp. 31-32.

The Giza Death Star Deployed

2. The Mystifying Silence and a Personal Aside

In his *Wars of Gods and Men*, Zechariah Sitchin reproduced a rather astonishing series of translations and analyses of the ancient Sumerian epic poem, the *Lugal-e*. In my previous book, *The Giza Death Star*, I reproduced most of those translations and Sitchin's accompanying commentary. As I recounted there, I had long had the sense of dread when contemplating the Great Pyramid, a haunting sense that the structure was once used, if not intended, for massively evil and destructive purposes. Structural comparisons between the massive Pyramids of Giza and more contemporary military phased radar arrays had always lurked in the corners of my mind since youth. When I read Sitchin's texts and his interpretation, I was, to put it mildly, astounded.

I remain so, not only because Sitchin himself seems to emphasize more of a communications function for the structure in his overall hypothesis, than a weapons function, but also because no one else seems to acknowledge the significance of what they suggest, at least, not publicly. Scientists point out the impossibility of some of Sitchin's hypotheses, such as a shunting of the earth's orbit by another planet. Others, as has been seen, criticize his translations and the materialistic worldview they allegedly represent. Yet his interpretation of the Great Pyramid as "the Great Affliction" - an outlandish claim, surely - goes unnoticed. It was in this disturbing silence that a host of new books and articles appeared on the Giza monuments and the Great Pyramid. Stargates, resurrection machines, powerplants, and most recently, a "hermetic device" and a "primer" designed to convey a "message" all clamored for attention, yet the idea of a weapon and a sophisticated paleophysics was more or less ignored. The closest one comes are rather benign modifications of Dunn's machine hypothesis, or the odd mentions of the Pyramid's probable "large radar signature" here and there.

B. The Stargate Conspiracy

The idea of intentional misdirection of research, and a deliberate propagandized use of the Great Pyramid and other Giza monuments in the creation of a powerful new mythology, are the subjects of an important work, *The Stargate Conspiracy* by Lynn Picknett and Clive Prince.

Secret Societies, Psychics, Spies, SS, Soviets, and Scalars

Noting that Bauvall, Hancock, Gilbert, Hoagland and other researchers on the "revisionist" side of the equation are promoting "what is essentially a belief system that is not only just as rigidly dogmatic as the academics'," they make the observation that there is a detectable and worrisome agenda in all their works."

The promotion of certain ideas and the fact that the same ideas occur in several of the most high-profile books about 'alternative Egypt' led us to believe that there was a pre-arranged, orchestrated move to create a new belief system.

As this investigation proceeds and we carefully strip away the layers of false extrapolation and strange affiliations, a much wider conspiracy is revealed. This extends well beyond the confines of Egyptology - Old or New - and involves several intelligence agencies, including the CIA and Britain's MI5, occult groups and even some of the world's top scientists. This extraordinary conspiracy centres (sic.) upon the creation of the expectation of imminent, quasireligious (sic.) revelations connected with ancient Egypt, cynically exploiting the spiritual hunger and craving for miracles of the Western world. This is not some minor social experiment, but in effect a large-scale campaign that takes many forms and uses many different religious, spiritual, New Age -and even political - masks. Honed by decades of intensive, and often less than ethical, intelligence experience, this conspiracy is, in our view, the most insidious yet dangerous assault on the collective free will of the West. Those at the heart of this plot care little for either the Egyptian mysteries or the spiritually bereft: all they care about is power and control.¹²

According to them, the central tenet of this newly emerging belief is the notion that the "hidden wisdom" of ancient Egyptians, or whoever built the Great Pyramid, is somehow directly relevant and beneficial to us today.¹³ It does indeed seem as if it has become almost a mantra among revisionist researchers that the technological sophistication of the paleoancient Very High Civilization was mirrored by the allegedly benign, beneficent and essentially pacifistic nature of its morality and culture.

Picknett and Prince believe the lineaments of this conspiracy began to emerge with the publication of Robert Temple's book on the African Dogon tribe and their apparently detailed knowledge of astronomy and physics, *The Sirius Mystery*. After its initial publication in the 1970s, the

¹¹Lynn Picknett and Clive Prince, *The Stargate Conspiracy: Revealing the truth behind Extraterrestrial Contact, Military Intelligence, and the Mysteries of Ancient Egypt* (London: Warner Books, 1999), p. 14.

¹²Ibid.

¹³Ibid., p. 26.

The Giza Death Star Deployed

book allegedly attracted the attentions of Freemasons as well as of the British MI5 and the American CIA. MI5 allegedly commissioned a report on the book and carried out security checks on Temple, and the CIA stole a translation of a valuable French manuscript Temple was using to guide his own research.¹⁴ Finally, Temple was contacted by an old family friend and prominent 33rd degree Freemason, Charles F. Webber. Webber specifically asked Temple to become a Mason "so that they could discuss his book as equals and without the risk of his revealing Masonic secrets to an outsider."¹⁵ According to Temple, Weber stated that

We are very interested in your book *The Sinus Mystery*. We realise (sic.) you have written this without any knowledge of the traditions of Masonry, and you may not be aware of this, but you have made some discoveries which relate to the most central traditions at a high level, including some things that none of us ever knew.¹⁶

Picknett and Prince then observe that these organizations, together with some more overtly occult secret societies, seem to emerge at every step in connection with the more well-known authors of the Revisionist school of pyramidology.

(1) Primitive Dogon Quantum Mechanics?

But why all the interest in an obscure African tribe, even if it does seem to preserve an accurate astronomical knowledge of the star Sirius? Part of the reason must surely lie in the glyphs that constitute the tribe's

¹⁴ *Ibid.*, p. 34.

¹⁵ *Ibid.*, p. 35. Cf. Robert Temple, *The Sirius Mystery: New scientific Evidence of Alien Contact 5,000 Years Ago* (Rochester, Vermont: Destiny Books, 1998), pp. 400-401. Temple also alleges serious Soviet KGB and American CIA and NASA interest in his book on pp. 8-9. An odd mention, perhaps significant in the light of our later discussion of possible German involvement in scalar physics research during World War Two and after, is Temple's allegation that Baron Jesco von Puttkamer wrote him a denunciatory letter on NASA stationery, only later to retract that, stating that it did not represent an official NASA position. Temple believes that Puttkamer was one of the Germans brought to the USA during the notorious Operation Paper Clip in the days immediately following the Nazi surrender (pp. 9-10). Karl Jesco von Puttkamer was no ordinary German, beginning the war as Kapitan zur See and Adolf Hitler's naval adjutant to staff, and continued in that capacity throughout the war, ending with the rank of Admiral.

writing system. Like many other ancient cultures, the Dogon seem to have a cosmology based on the idea of an initial "cosmic egg" containing the "seeds" of the rest of creation. But for the Dogon, these "seeds" are also the "signs" or "symbols" of matter.¹⁷ During certain special tribal rituals, these symbols - of which there are 266 - are drawn on the ground. These symbols consist of circles with various numbers of "spines" sticking out of them. And once a year a special ritual is performed during which a small circle is drawn within a larger. Between these two circles, several zig-zag lines are traced. Once completed, the 266 seed-signs are said to have been drawn. One hundred years ago, perhaps, scientists would have been inclined to scoff at anything so "primitive" as a tribe believing circles with spines represented the fundamental building blocks of matter.

The remarkable thing is that the Dogon mythology may reflect yet another lingering trace of a vanished paleophysics, for modern quantum mechanics posits a little more than 200 fundamental particles. As we shall discover in chapter six, there may be a relationship between the stone courses of the Pyramid, and modern atomic and quantum mechanical theory. In any case, as many have observed, the resemblance between some of the Dogon signs and conceptualized quantum particles is amazing.¹⁸

The tribe also appears to have accurate descriptions of the four "forces" of modern theoretical physics with four seeds "whose names in the Dogon language mean 'to draw together' (gravitational force), 'bumpy' (electromagnetic force), 'stocky' (strong nuclear force), and 'that bows its head' (weak nuclear force)."¹⁹ In any case, perhaps the interest of the intelligence community and Masonic fraternity in Temple's *The Sirius Mystery* indicates their real interest: the possibility of a sophisticated paleophysics lying buried in ancient traditions, myths, and esoteric texts. It does suggest that these communities may indeed be aware of far more than they are telling.

¹⁷ Laird Scranton, "The Dogon as Physicists," *Atlantis Rising*, Number 29, September/October 2001, (26-28, 61), p. 26.

¹⁸ *Ibid.*, p. 28.

¹⁹ *Ibid.*, p. 61.

The Giza Death Star Deployed

(2) The Lost Hall of Records

According to Picknett and Prince, yet another crucial aspect of the conspiracy is its persistent myth, for example, that a secret chamber, a lost "Hall of Records" lies buried somewhere beneath the Giza plateau. The American psychic Edgar Cayce and his A.R.E. foundation did much to advance this notion, the latter even funding expeditions to Giza for scientific research. And the seer Randall-Stevens went much further, providing detailed drawings and diagrams of what is under the plateau. Picknett and Prince postulate an interesting source for Cayce's and Randall-Stevens' revelations concerning these underground chambers: the Ancient and Mystic Order of the Rosae Crucis, "the prominent American Rosicrucian society commonly known as AMORC."²⁰

Founded in the early 1920s by Harvey Spencer Lewis, himself initiated into the Rosicrucian order in Toulouse, France, the AMORC "claimed a pedigree that went directly back to the Mystery Schools of ancient Egypt."²¹ Lewis "claimed to have inside knowledge" of the Giza compound. Indeed, this tenet is a central belief of the AMORC. Lewis provided diagrams based on those in the "Rosicrucian archives", diagrams quite similar to those provided by Randall-Stevens.²²

But the legend is a persistent one, and should not be too readily dismissed, since it stems ultimately from two ancient Egyptian texts:

An important early Egyptian source that tells us much about the Hall of Records is called the Building Texts, found among the hieroglyph inscriptions on the inner enclosure wall of the temple of Horus at Edfu, in the heart of southern Egypt. The Building texts refer to a number of now lost documents, grouped together into what was called "the Sacred Book of Temples," which have a history and description of the major shrines along the Nile from a very remote period. These were first established by a group of creator-entities called the Shebtiw, who were associated with the god "Divine Heart" or Thoth, the Egyptian deity of Wisdom.

According to the Building Texts, the sacred books and power objects were eventually placed back inside the bw-hmm or Hall, and the Shebtiw sealed the entrance, constructed a new 'enclosure' about it, and erected power staffs and pillars outside to protect its secrets, hidden away again from all but its guardians. The site thereafter became known as bw-hmr, "the Place of the Throne

²⁰Picknett and Prince, *op. cit.*, p. 70.

²¹*Ibid.*

²²*Ibid.*, p. 71.

Secret Societies, Psychics, Spies, SS, Soviets, and Scalars

of the Soul," regarded as the location where only the highest Initiations were performed.

In another Egyptian text, known today as the Westcar papyrus, which bears evidence of dating to the Fourth Dynasty, is the story of an enigmatic sage named Djeda who could not only perform miraculous feats of magic, but who also possessed certain information concerning what he called "the secret chambers of the books of Thoth." In the narrative, Djeda told Pharaoh Khufu the location of specific keys that will one day open the hidden place...²³

There are a number of points here that must be highlighted, for they corroborate the Pyramid war outlined by Zechariah Sitchin in his Wars of Gods and Men, as well as suggest a number of modifications to it:

1. The occupants of Giza secreted their "wisdom," i.e., their science in anticipation of a cataclysm;
2. This wisdom was connected to the Egyptian wisdom god, Thoth, who in turn is always associated with the "wisdom" of the Great Pyramid as its primary architect;
3. The secreted items also contained some talismans or objects of power;
4. These books and "power objects" were made secure by other objects.

If we now place these observations against the broad scenario outlined by Sitchin, and within the interpretive context of the weapon hypothesis, we can reconstruct what possibly happened as the Second Pyramid War was drawing to its bloody conclusion and the surrender of the weapon:

1. The vanquished society, still in possession of the Great Weapon, anticipating that the victors would demand its surrender and the removal or destruction of its interior components, removed some of the more crucial items and secreted them in various places, setting booby traps as an added measure of security;
2. Similarly, the defeated party also stored its "wisdom", i.e., crucial information about the science and technology that made the weapon possible.

In some versions of this tradition, Thoth is said to have secreted emerald tablets on which were "inscribed" all his magic. Granted the hypothesis of

²³ Dr. Joseph Jochmans, "Hall of Records: Opening Soon?" pp. 70-71.

The Giza Death Star Deployed

a paleoancient Very High Civilization, these might very well have been digitalized holograms composed of actual emerald or some other, even harder substance, impervious to the ravages of time.

The weird associations of the New Egyptologists and occult and secret society activity becomes even weirder with Bauvall's 1998 announcement of "Project Equinox 2000." This was a group comprised of twelve authors,²⁴ a group Bauvall called "Magic 12," a strange name indeed, and perhaps deliberately chosen, since "Majic 12" was the name for the alleged ultra top secret organization established in the USA after the Roswell incident to study the UFO phenomenon and manipulate public opinion about it! The choice of the name is perhaps itself a deliberate attempt to associate the Pyramid with "aliens".

The idea is that the Magic 12 are to hold a series of conferences in different locations around the world on the key astronomical days of the year 1999 - the equinoxes and solstices. The locations have been selected as the major Hermetic sites of the world, including Giza, Alexandria, Stonehenge, and San Jose (headquarters of AMORC).²⁵

Freemasons, MI5, CIA, Rosicrucians, and "Magic 12": a strange mix to be investigating a structure that was, according to the standard theory, nothing more than a tomb for a dead Egyptian king!

Robert Bauvall himself published an important book - *The Secret Chamber: The Quest for the Hall of Records* - after the appearance of *The Stargate Conspiracy*, in which he replies to the allegations of Picknett and Prince. But in my opinion, Bauvall does little to alleviate Picknett and Prince's concerns. Consider these evocative passages from *The Secret Chamber*:

(The Great Sphinx), too, may be guarding a treasure-trove under its belly: a 'Hall of Records' of a civilisation (sic, et passim) long lost in the mist of time. There, too, with amazing synchronicity, an entrance to such a vault has been known since 1993.

Why have these chambers not been opened?

What could be within them?

Could the Egyptian authorities know more than they are letting on?

²⁴ Others were allegedly Graham Hancock, John Anthony West, Andrew Collins, Colin Wilson, Michael Baigent, Christopher Knight, and Robert Temple.

²⁵ *Ibid.*, pp. 72-73.

Secret Societies, Psychics, Spies, SS, Soviets, and Scalars

Is there a 'conspiracy' here, one that might involve not just Egyptology but other, more sinister, institutions? Or is there 'something else'?²⁶

For on this dusty plateau of Giza is being played history's most exciting and most meaningful game: the quest, no less, for the spiritual and cultural origins of civilisation, and its true destiny.²⁷

The quest for the Hall of Records is unlike any other. By its very nature, it is a path charged with powerful archetypal and mythical forces. One constantly gets the feeling that some ancient plan has been reactivated and is rushing head-first toward an apotheosis at Giza. There is a peculiar sense of urgency, as well as a sense of enchantment and magic that engulfs the players, as if at any moment something momentous will be revealed. In order to make proper sense of all this, and more importantly, in order to understand what could be in the hatching mere for the new millenium, one must, by necessity, undergo a type of intellectual initiation. Only then will the greater picture emerge. Secret Chamber, therefore, has been designed for precisely this purpose.²⁸

This allusion to high magic and initiation, plus Bauvall's oft-repeated statements throughout his book about his feelings that a momentous message and initiation awaits mankind, contains a confirmation, perhaps, that Picknett and Prince's concerns are not unjustified.

At the conclusion of his opening preface, he elaborates on the meaning of initiation and the role of "devices" in the magical tradition of Hermeticism:

In the ancient Egyptian tradition the neophyte who successfully underwent the process of acquiring such knowledge was said to be 'equipped.' In this way, we will appreciate that the Great Pyramid and the Giza necropolis as a whole are not 'tombs' or 'temples' in the conventional sense of the words, but rather are instruments that were designed to service powerful rituals of initiation. Although these monuments and structures are much damaged, weatherworn and somewhat incomplete today, they can still produce the potent subliminal effect on the human psyche which (sic.) they were primarily intended to do. In Hermetic and Alchemical tradition such an instrument is known as a 'device', and the Great Pyramid of Giza is perhaps the most powerful of such Hermetic devices....

I am convinced that the Giza necropolis has been designed for precisely such a purpose. I am convinced, too, that the time has come for that purpose to reactivate itself. I am also convinced that some sort of bizarre plan is being

²⁶ Robert Bauvall, *The Secret Chamber: the Quest for the Hall of Records* (London: Arrow Books, 2000), p. xxxiii.

²⁷ *Ibid.*, p. xxxiv.

²⁸ *Ibid.*, p. xxxv.

The Giza Death Star Deployed

implemented at Giza to 'hijack' this all-powerful device in order to promote something else, something that the monuments of Giza were never intended to do.²⁹

Bauvall himself seems throughout his book to press this image of a hermetic device, and a hidden message, though without ever telling the reader exactly what the glorious revelation is supposed to be. We have only his feelings and intuitions that it will be momentous.

That much would seem to be self-evident, for on any hypothesis, even that of standard Egyptology that the Great Pyramid was a royal tomb, the discovery of lost records would indeed be momentous. But if the weapon hypothesis is true, then such a discovery is likely to go unannounced. To his credit, Bauvall is aware of the strange goings on at Giza and the disinformation that accompanied them.

There are, as we shall see, some disturbing common denominators at play here. First, of course, there is the systematic halting of the explorations each time they seem to be on the verge of finding a way to a possible secret chamber. All the explorations, too, were conducted either in secrecy or were allocated official explanations as to their purpose that had nothing or little to do with the main objective of the explorations. For example, the investigation of the shafts in the Great Pyramid by the Germans was registered as a 'cleaning job...' It was common knowledge that the shafts (from the Queen's chamber) did not pierce through to the outside of the Pyramid and, quite obviously, could not be of any use for 'ventilation', unlike the shafts of the King's Chamber. What were the Germans really up to? Why the misinformation?³⁰

Why indeed the misinformation?

Even more to his credit, Bauvall - amid all his feelings and intuitions about messages and hermetic devices - senses that something else may be at stake in the frenetic digging by so many expeditions around Giza:

The 'books' of Thoth-Hermes, the manuals of the ultimate Hermetic system of knowledge, are, if we accept the ancient prophecies, concealed somewhere in Egypt, somewhere in a place called Monte Libyco, somewhere near, or even within, the Great Pyramid of Giza.

Finding them, therefore, could be the ultimate prize - or weapon.³¹

²⁹Ibid., pp. 1-11, emphasis added.

³⁰ Ibid., pp. 7-8.

³¹ Ibid., p. 64.

Secret Societies, Psychics, Spies, SS, Soviets, and Scalars

And thus, after this one brief mention by an adherent of the Message Hypothesis, the Weapon Hypothesis disappears entirely from the rest of the book.

But this mention of a "Hermetic Weapon" does deserve some further commentary. In my previous book *The Giza Death Star* I cited William Henry's *One Foot in Atlantis*, an excellent survey of the occult influences operating in the circles of Roosevelt, Churchill, and Hitler. There, I pointed out Henry's list of parallels between standard occult (or ceremonial magick talismans of power), the Tarot deck, and a modern pack of playing cards:

Occult Symbol:	Cauldron	Sword Spear	Stone/Crystal
Tarot:	Cups	Swords Wands	Pentacles
Modern Cards:	Hearts	Spades Clubs	Diamonds

A further parallel exists in the accoutrements of the practitioner of ceremonial magick:

Occult Symbol:	Cauldron	Sword Spear	Stone/Crystal
Tarot:	Cups	Swords Wands	Pentacles
Modern Cards:	Hearts	Spades Clubs	Diamonds
Magick:	Chalice	Dagger Wand	Crystal

Ralph Ellis, in his *Toth: Architect of the Universe*, points out a possible "paleophysical meaning" behind the minor trumps of the Tarot and the modern pack of playing cards, stripping away one layer of a possible physics origin for something as simple as a deck of cards:

Item:	Number:	Physics Analogy:
Number of cards	52	Number of weeks in the Terrestrial solar year
Number of cards per suit	13	Number of Lunar Months
Number of picture cards	12	Number of terrestrial Months
Number of suits	4	Number of seasons
Number of spots (pips)	364	Approximate number of Days in the earth's Solar orbit

The Giza Death Star Deployed

Interestingly enough, the only survivor of the Major Trumps from the Tarot deck in the modern playing cards deck is The Fool, or as is more commonly known, the "Joker". Giving it an arbitrary value of 1.234 would increase the number of "pips" or spots in the playing card deck to 365.234, a number reflecting the current calendrical system of counting the number of days in a year.³²

But one may go further, much further, in uncovering possibly encoded deep layers of physical meanings latent in the now garbled traditions of esoteric practice. For example, in the typical "Tarot reading" the reader is supposed to clear his mind, concentrate on the question being asked of the cards, and then begin the "shuffle." What basis in physics might these seemingly simple acts have? Since quantum mechanics and more recent scientific investigations into the relationship of consciousness and physical reality have posited some sort of connection between Observer and observed effect, the following relationships suggest themselves:

Tarot Reading: Clearing the mind and focus on the Question	Possible Underlying Physics: Posited links between the mind the structured potential of the Zero Point Energy ³³
The Deck itself	"Infinite" information potential of the field
The Shuffle	Analog random number Generator
The Spread	Union of the previous steps, i.e., Of form (εἶδος) and matter (ὕλη); the structured potential of information in the field.

³²Ralph Ellis, Thoth: Architect of the Universe (Kempton, Illinois: Adventures Unlimited Press, 2001), p. 89.

³³Cf. the paper by the eminent physicist Harold (Hal) E. Puthoff and Russell Targ, A Perceptual Channel for Information Transfer over Kilometer Distances: Historical Perspective and Recent Research. Puthoff is the author of numerous peer-reviewed papers in theoretical physics related to ZPE research. For other related books and articles on the physics of consciousness, cf. Frank J. Tipler, The Physics of Immortality and his earlier work, The Anthropic Cosmological Principle; also Evan Harris Walker, The Physics of Consciousness: The Quantum Mind and the Meaning of Life, Roger Penrose, Shadows of the Mind: A Search for the Missing Science of Consciousness (especially pp. 213-391); David Bohm, Wholeness and the Implicate Order (especially chapters 4-6).

Secret Societies, Psychics, Spies, SS, Soviets, and Scalars

Extending this analogical analysis even further, recontextualizing the four standard talismans of power reveals more tantalizing possibilities when viewed in the contexts of electromagnetics and topology:

Occult Symbol:	Cauldron	Sword	Spear	Stone/Crystal
Tarot:	Cups	Swords	Wands	Pentacles
Modern Cards:	Hearts	Spades	Clubs	Diamonds
Magick:	Chalice	Dagger	Wand	Crystal
Electromagnetism:	Capacitor	Waveguide	Antenna	Crystal/Lattice
Topology:	Basins of Attraction	Bifurcation	Maps	Matrix/metric

Notice also how this chart, ascending from the images of the occult, Tarot and modern playing cards symbolism to physics and topology roughly corresponds with Fr. Francis Copleston's diagram of the Platonic turn (*περιαγωγή*) from the material to the intelligible world, given in my previous book on page 59. Combining the above table with Copleston's chart of the Platonic turn is very revealing (cf. next page).

In any case, the high weirdness of people and associations investigating the Giza Death Star takes an even stranger turn during the twentieth century's scientific investigations of the structure, for almost all of them, without exception, were led by people with close ties to military or space research agencies. In 1996, for example, an Egyptian team headed by Dr. Farouk El Baz was supposed to open Gantenbrink's door on live television. The event failed to materialize after much media hype. Even stranger is the fact that Dr. Farouk El Baz is a planetary geophysicist who worked with NASA on the Apollo moon landings.³⁴ A planetary geophysicist studying the Great Pyramid?

Stranger than this is Dr. Zahi Hawass himself, the Egyptian government's "tsar of Giza." Hugh Lynn Cayce, son of the American psychic Edgar Cayce and director of Cayce's ARE foundation, claimed to have mentored and funded Hawass's doctoral studies in Egyptology in the United States, a claim that Hawass denies vehemently.³⁵

Weirder still was the rumor that a tunnel was being dug from Davidson's Chamber to Gantenbrink's Door. Unlike many rumors, its source was none other than "Thomas Danley, an acoustics engineer and NASA consultant for two space shuttle missions, who specialises (sic.) in

³⁴ Ibid., p. 78.

³⁵ Ibid., pp. xxxviii-xl.

A COMPARISON OF THE PLATONIC TURN TO PHYSICS AND ESOTERIC SYMBOLS

COPLESTON'S SCHEMA OF THE PLATONIC TURN

ESOTERIC / PHYSICS CORRESPONDENCES

MENTAL STATE

OBJECTS KNOWN

	Scientific understanding (η επιστημη)	Intellection (η νοησις)	Sources/Principles (αι αρχαι)	Invisibles (τα αορατα)	Topology: Basins of Attraction, Mappings, Matrix/ metric, Bifurcation
Knowledge (η γνωσις)	Discernment (η διανοια)	Mathematicals (τα μαθηματικα)	Intelligibles (τα νοητα)		
Opinion-glory (η δοξα)	Belief, Faith (η πιστις)	Living Things (ζωα, κ.τ.λ.)	Visibles (τα ορατα)	Physics: Capacitors, Antennae, Crystals/lattices Waveguide	
	Shadows, Images (η εικασια)	Icons (εικονες)	Perceivables (δοξατα)	Modern Deck: Hearts, Clubs, Diamonds, Spades Tarot Deck: Cups, Wands, Pentacles, Swords Magick: Chalices, Wands, Crystals, Daggers	

'acoustic levitation' (raising objects through the use of sound and vibration)."³⁶ Danley discovered that Caviglia's tunnel, made in the 19th century during Vyse's infamous expedition, had recently been extended thirty feet beyond its original end. Informing a disconcerted Egyptian inspector, the Egyptian and his boss, Dr. Zawi Hawass, claimed to know nothing about it.³⁷ Either the Egyptian authorities were telling the truth and someone else was doing secret tunneling of the Pyramid, or the Egyptian authorities were lying and a cover-up was under way. Two years later the Egyptian authorities admitted that more tunneling was under way.³⁸ And according to Picknett and Prince, reliable sources confirmed that three new chambers had been discovered around the King's Chamber.

In the previous chapter, the questionable military and intelligence associations of scientist and pyramid investigator Dr. Luis Alvarez were mentioned. After dismissing his own research project, nothing further seems to have happened until 1973, when SRI International funded an expedition under the leadership of Dr. Lambert Dolphin Jr. to look for hidden chambers under the Sphinx. Dolphin himself maintained that the expedition was but a continuation of Alvarez's research five years previously.³⁹ Like the Alvarez expedition, SRI's is no less questionable, for SRI International was but the renamed Stanford Research Institute, a famous think tank with close ties to the US Department of Defense and the various American intelligence agencies.

Dolphin himself, a physicist, has his own peculiar associations. Not only is he tied to the American military and intelligence communities via SRI International, but he is also a typically "evangelical Christian fundamentalist" who apparently at the same time he was leading the Giza expedition was also helping Jewish fundamentalists find the original foundations of the temple, for the purpose of rebuilding it!⁴¹ In 1977 Dolphin and SRI returned to Giza, gaining the financial support of Cayce's A.R.E. foundation in 1978.

(3) Enter "The Psychic ", Edgar Cayce:

³⁶ Picknett and Prince, *op. cit.*, p. 79.

³⁷ *Ibid.*, p. 80.

³⁸ *Ibid.*, p. 81.

³⁹ *Ibid.*, p. 85.

⁴⁰ *Ibid.*, p. 84.

⁴¹ *Ibid.*, p. 85.

The Giza Death Star Deployed

His "Terrible Mighty Crystal" and "Fire Stone "

But what does the famous American psychic Edgar Cayce have to do with the Great Pyramid and its possible function as Sitchin's "Great Affliction"? Beyond his many "readings" concerning the Hall of Records, Cayce also gave readings concerning the "Atlantean Crystal:"

...(In) Atlantean land at time of development of electrical forces that dealt with transportation of craft from place to place, photographing at a distance, overcoming gravity itself, preparation of the crystal, the terrible mighty crystal; much of this brought destruction.⁴²

"As for description of the manner of construction of the stone: we find it was a large cylindrical glass (as would be termed today); cut with facets in such a manner that the capstone on top of it made for centralizing the power or force that concentrated between the end of the cylinder and capstone itself. As indicated, the records as to ways of constructing same are in three places in the earth, as it stands today: in the sunken portion of Atlantis, or Poseidia, where a portion of the temples may yet be discovered under the slime of ages of sea water - near what is known as Bimini, off the coast of Florida. And (Secondly) in the temple records that were in Egypt, where the entity that acted later in cooperation with others towards preserving the records that came for the land where these had been kept. Also (thirdly) in records that were carried to what is now Yucatan in America, where these stones (which they know so little about) are now - during the last few months - being uncovered.⁴³

Given that Cayce himself indicates that these "stones" and "crystals", whatever they may be, are able to concentrate power, perhaps the involvement of his A.R.E. foundation in funding expeditions to Giza is not all that peculiar. It may even be that A.R.E.'s involvement masks the interest of other agencies and parties.

In other "readings" Cayce gave rather astonishing descriptions of similar crystals and Atlantean "fire stones", readings in which phrases such as "amplified the light", "condensed the light," and "concentration of

⁴² Edgar Cayce, reading 519-1, Feb. 20, 1934, cited in David Hatcher Childress, *Technology of the Gods: Incredible Sciences of the Ancients* (Kempton, Illinois: Adventures Unlimited Press, 2000), p. 296.

⁴³ *Ibid*, 440-5, Dec. 20, 1933, cited in Childress, pp. 297-298.

the rays" abound, and this almost three decades before the cohering action of masers and lasers was discovered.⁴⁴

How did the "firestone" operate? Cayce speaks of "rays from the sun amplified by crystals" and "the raising of the powers from the sun itself to a ray that makes for the disintegration of the atom." ...The tuaoi crystal⁴⁵ (it is repeatedly called a crystal, quartz being the first definition of the dictionary under it) was said to get its power from "the concentration of energies that emanate from bodies that are on fire themselves, along with elements that are found and not found in the earth's atmosphere." ...So what does this all have in common? A thermally excited gas laser with a quartz housing. Quartz allows for the transmission not only of visible wavelengths but also ultraviolet and infrared radiations....Cayce states the force which (sic.) came from the tuaoi "arose in the form of rays invisible to the eye," suggesting ultraviolet or infrared as the operating range. An ultraviolet laser...ionizes the air directly in front of the beam creating an electrically conducting pathway - literally sending electricity directly through the air without the use of wires, cables, or other instrumentalities.⁴⁶

These remarks are important, for it contains the outlines of a potentially very powerful weapon:

- Plasma is heated to ion-acoustic mode.
- Ultraviolet or other high frequency laser acts as a conductive channel for a high voltage electrical impulse firing through that channel.
- That electrical impulse in turn could act as a carrier for the plasma via the electrical pinching effect on plasma, a phenomenon known to all in neon lights.

So the presence of a physicist of Dolphin's caliber in Cayce's A.R.E. foundation's funding roster is no surprise, for the implications of Cayce's readings cannot have escaped Dolphin's attention.

Nor should it ours, for the reader who has read my previous book, *The Giza Death Star* will immediately recognize the implications: amplified cohered light in the microwave range (rather than ultraviolet range), drawing on the sun itself to disintegrate atoms, and plasmas contained

⁴⁴ William Donato, "Cayce's Masers," *Atlantis Rising*, Number 32, March/April 2002, 24-25, 61-62, p. 24.

⁴⁵ Tuaoi, i.e., the Atlantean fire stone or fire crystal.

⁴⁶ Donato, op. cit, pp. 25, 61.

The Giza Death Star Deployed

inside quartz to induce an amazingly powerful masing action. And let us not forget the other vague reference Cayce made: gravity, and the ultimate destruction wrought by this "terrible, mighty crystal."

Dolphin's involvement with Cayce and Giza stems from his own unusual entries on his academic resume:

As a final word on remote viewing, would it surprise you to learn that the aptly named Lambert Dolphin, a physicist at SRI, who worked with Hoagland on the Cydonia material, was involved with remote viewing projects that concerned not only Mars but the artefacts (sic.) on the Giza Plateau?⁴⁷

Surprising? With SRI's known connections to the American military and intelligence communities, it is not surprising at all.

(4) Enter Dr. James J. Hurtak

At this juncture enters one of the most amazing and interesting characters in the whole conspiracy scenario of Picknett and Prince. Dr. James J. Hurtak is an American polymath with "degrees in Oriental Studies and History, Social Sciences, Linguistics, Patristics and Greek texts."⁴⁸ Never formally a member of SRI International, Hurtak nevertheless maintains a close relationship with its luminaries and department chiefs at any given moment. Interestingly, he is a close friend with Lambert Dolphin.⁴⁹

Almost 20 years before Bauval and Gilbert's book *The Orion Mystery* argued persuasively that certain aspects of the Giza compound and the Great Pyramid were deliberately meant to align to Orion, Hurtak "was exploring a possible correlation between the Giza pyramids and Orion's belt in 1973. We found that this was not the only time he has been ahead of the game."⁵⁰ Indeed, long before the Viking I orbiter took that now famous picture of the Face on Mars on July 25, 1976, Hurtak had "predicted the existence of a Sphinx image on Mars in 1975."⁵¹

⁴⁷Mary Bennet, David S. Percy, *Dark Moon: Apollo and the Whistleblowers* (Kempton, Illinois: Adventures Unlimited Press, 2001), p. 481.

⁴⁸Ibid., p. 86.

⁴⁹Ibid.

⁵⁰Ibid., p. 87.

⁵¹Ibid., p. 119.

Moreover, accordingly to Hancock and Bauval, Hurtak also predicted that various other structures would be discovered on Mars and that they "would be linked to the Giza monuments in a great cosmic blueprint."⁵² Was Hurtak's prediction the result of remote viewing experiments in which he and others, like Lambert Dolphin, were involved?

(5) Enter Richard Hoagland

Richard Hoagland is, of course, well known for his research on and popularization of the Cydonia images on Mars. Many associate his name with the Art Bell overnight radio talk show program originating in Nevada where he is a frequent guest, updating the public on the latest news on Mars, indications of extraterrestrial life, and other subjects, among them the subject most associated with Hoagland's name: "tetrahedral physics," about which we shall have a great deal to say in chapter nine.

Beginning in December of 1983, he and Lambert Dolphin received a grant of fifty thousand dollars from SRI and began "the Mars Mission."⁵³ One of the early recruits "to the cause was a designer and illustrator named John Channon, a former lieutenant colonel with the U.S. Army, who had been stationed at the Pentagon.... Prior to this, Channon had been a member of an Army War College project called Task Force Delta, whose purpose was, in Jim Schnabel's words, to 'investigate alternative philosophic realms for anything militarily useful.'"⁵⁴ In other words, the American military was interested in possible avenues of alternative science indicated by "philosophy", presumably including ancient philosophical texts.

As Picknett and Prince see it, there are two distinct phases to Hoagland's Martian research. The first phase, the phase of "The Mars Mission," emphasized merely the argumentation that the Cydonia Viking photographs gave evidence of structures and intelligent design. The second phase began with the founding of "The Enterprise Mission" in 1988, and "which was more concerned with promoting the alleged meaning of the structures at Cydonia, and their connection with the ancient civilizations of Earth, particularly Egypt. Underlying all of phase Two is one over-riding message, which is that the builders of Cydonia are

⁵² Ibid., p. 120.

⁵³ Ibid., p. 123.

⁵⁴ Ibid., p. 124.

The Giza Death Star Deployed

back..."⁵⁵ Picknett and Prince also allege, without much substantiation, that "there was a notably close connection between the new Mars Mission and the US intelligence community."⁵⁶ Adding fuel to the fire is the fact that Hoagland often maintains that there is a vast conspiracy within NASA to deny the artificiality of the Martian structures, and that he often comes close to maintaining the existence of a "NASA within NASA", a second, secret space program with a vast and complex Masonic-astrological agenda.

As I observed in *The Giza Death Star*, the idea is not new, and has been around since the celebrated Torbitt document on the assassination of President Kennedy. This document alleges that a secret space program was being run by the US military in conjunction with the Nazi scientists brought over from Germany after World War Two, and that Dr. von Braun was highly placed in the second project. The notion that some UFOs are of human origin is not a new one. And until recently, the notion that the first prototypes of such devices might have been constructed as extremely secret weapons projects by Nazi Germany during the war was quickly dismissed as a laughable notion, even by the more extreme parts of the UFOlogy community. Earlier this year, however, Dr. Steven Greer's *Disclosure: Military and Government Witnesses Reveal the Greatest Secrets in Modern History* was published.

This important work, essentially nothing more than a compilation of affidavits and interviews of UFO witnesses or of people associated with UFO "black projects", revives the "German" part of the story in no uncertain terms. One of these witnesses, Dr. Carol Rosin, became an executive of Fairchild Industries and a close associate of Von Braun toward the end of his life.

What was most interesting to me was a repetitive sentence that (Von Braun) said to me over and over again during the approximately four years I had the opportunity to work with him. He said the strategy that was being used to educate the public and decision makers was to use scare tactics....That was how to identify an enemy.

The strategy that Werner Von Braun taught me was that first the Russians are going to be considered to be the enemy....

⁵⁵ Ibid., p. 125.

⁵⁶ Ibid.

Secret Societies, Psychics, Spies, SS, Soviets, and Scalars

Then terrorists would be identified, and that was soon to follow.... (He) said that would be the third enemy against whom we would build space-based weapons.

The next enemy was asteroids. Now, at mis point he kind of chuckled the first time he said it. Asteroids - against asteroids we are going to build space-based weapons.

And the funniest one of all was what he called aliens, extraterrestrials. That would be the final scare. And over and over and over during the four years that I knew him and was giving speeches for him, he would bring up that last card. "And remember Carol, the last card is the alien card.... We are going to have to build space-based weapons against aliens and all of it is a lie."

.... The last card that was being held was the extraterrestrial enemy card. The intensity with which he said that, made me realize that he knew something that he was too afraid to mention. He was too afraid to talk about it. He would not tell me the details. I am not sure that I would have absorbed them if he had told me the details or even believed him in 1974.⁵⁷

These dark prognostications from the man who headed Hitler's rocket program and later our own Moon missions suggest that a great deal of manipulation is taking place in the space program. Indeed, some have gone so far as to suggest that the whole scenario of "near misses" of large wandering asteroids and earth is a ploy designed to weaponize space with planet-busting directed energy weapons.⁵⁸ It is also to be noted that this book was published months before the terrorist bombings of the World Trade Center towers in New York City, and that the Bush Administration wasted no time in appointed the military's space agency chief to head the American Joint Chiefs of Staff, and to promote a national space-based missile defense system.

In The Giza Death Star I pointed out that the actual neutral point of gravity between the earth and the Moon was discovered to be much closer to the earth than had originally been calculated. When this was first

⁵⁷ Steven Greer, M.D., *Disclosure: Military and Government Witnesses Reveal the Greatest Secrets in Modern History* (Crozer, VA: Crossing Point, In., 2001), pp. 255-256.

⁵⁸ Mary Bennet, David S. Percy, *Dark Moon: Apollo and the Whistleblowers* (Kempton, Illinois: Adventures Unlimited Press, 2001), p. 464. This book is a rather speculative analysis of the theory that the Apollo Moon missions were hoaxed. This book does manage to raise some interesting questions and to provide some entertaining speculations and intriguing theories regarding the "space race" between Russia and America. However, I do not subscribe to the theory that Apollo was hoaxed or that American astronauts did not go to the Moon and return safely. That being said, NASA's record with the Martian and Lunar anomalous photographs does invite an equal skepticism.

The Giza Death Star Deployed

announced by Time magazine in 1969 at the time of the Apollo 11 mission, few noted the discrepancy between its published figure of 43,495 miles and previously estimated neutral points that placed it much closer to the Moon. The figure came from one who ought to have known the truth, after all, American astronauts were riding his rocket to the Moon and relying on his calculations to get them there safely, none other than Wernher von Braun. Could it be that the Time magazine disclosure had something to do with the famous rocket scientist's sudden and hasty departure from NASA?⁵⁹

And so with von Braun enters the last, and weirdest, player on the stage of Pyramid paleophysics: Germany.

C. The Scalar Weapons "Triad Nations": The Berlin-Tokyo Scalar Axis

In *The Giza Death Star* I briefly outlined a less well-known aspect of contemporary theoretical physics that some call "scalar" physics, and others "Zero Point Energy" physics.⁶⁰ In this and subsequent chapters, I shall review in more detail the basis of this physics as expounded by one of its foremost experts, Lt. Col. (Ret.) Thomas E. Bearden. This physics postulates the existence of a "time-reversed," superluminal form of energy of great power that can actually be engineered through harmonic interferometry.

Bearden's work is not limited merely to an exposition of the theoretical and experimental foundations of this new physics. Much of his writing is done out of the desire to inform the public not only of the threat of such weapons, but of their actual existence and deployment by the former Soviet Union and three other nations. Bearden's analysis oftentimes is frustrating, because in some cases he does not make clear the sources for his allegations that the Soviet Union actually used such weapons on a very limited basis against select American targets, at levels of power output and resulting destruction far below their potential for one or two shot regional devastation.

⁵⁹Ibid., p. 394.

⁶⁰The two terms, while not exactly synonymous, both connote an incompleteness to current physical mechanics, and are explored in chapter seven.

Secret Societies, Psychics, Spies, SS, Soviets, and Scalars

Notwithstanding this lack of details, Bearden's larger picture does make a convincing case for the existence and deployment of these types of weapons by certain nations in certain situations:

Finally, three nations other than the Soviet Union now have scalar electromagnetic weapons. These three nations - I call them the "Triad" nations - are not hostile to the U.S. In later 1988 and early 1989, the Triad nations very firmly and positively demonstrated to Gorbachev that the Soviet Union would also be devastated if it continued on its path to utilize large scalar EM weapons against the West and against the U.S. in particular.⁶¹

The "signature" of this type of weaponry, at such low power usage, is acoustic cavitation - as was seen in The Giza Death Star - manifest in this case as earthquakes:

An exchange of earthquakes between several nations now possessing scalar EM weapons seems to have occurred in 1988-89. The various sides seem to have demonstrated to each other their ability to unleash this sort of weapon - in other words, each has proven to the other that its deterrent is credible.⁶²

These quotations afford some clues as to the type of nations that might develop such weaponry:

- They must have sufficient industrial base to undertake the expense;
- They must have sufficient scientific and technological know-how to engineer and construct the weapon, and also to deploy a technology to detect the use of such weapons;
- They must have pressing geo-political and military reasons for developing such weaponry;
- They must have pressing geopolitical reasons for demonstrating to the Soviet Union that they will use such weaponry;
- The date of 1988-1989 is perhaps also a significant indicator of the identity of at least one and possibly more of those nations.

These criteria are increasingly limiting as one goes down the list, and allow a fairly reasonable guess as to which nations - never mentioned explicitly by Bearden - might have been involved.

⁶¹T.E. Bearden, "Introduction and Progress Report," Analysis of Scalar/Electromagnetic Technology, (Tesla Book Company, 1990, pp. 1-5), p. 4.

⁶²Ibid., p. 5, n. 6.

The Giza Death Star Deployed

The first criterion - industrial and economic capacity - severely limit the potential triad nations to but a handful: The United States, Japan, Germany, France, The United Kingdom, Italy, Canada, South Africa, Taiwan, India, Pakistan, and perhaps a few others. Even some of these in this list would have to strain their economies severely in order to construct and deploy such weaponry. Nations such as Pakistan and India, already burdened by the expense of their own nuclear weapons programs, might possibly be tempted to develop such weaponry, but they would do so at an enormous cost since it would make their own nuclear weapons obsolescent. So one may reasonably exclude such nations from the list, leaving open the remote possibility that they might indeed be members of the even more exclusive "Scalar Club".

The second criterion limits the potential list even more. India and China both, for example, have some of the world's best theoretical physicists and engineers. There is little doubt that they could design such weapons and "scalar detectors," but they simply lack sufficient industrial base to do so. Taking these two criteria together, one must reasonably exclude other nations such as South Africa, Taiwan, Canada and so on from the list. Not lacking in any science, they lack the industrial base. This factor is crucial because, as will be seen in the next chapter, one sure sign of a technological capability for offensive strategic scalar weaponry is the construction of large phased radar arrays. Scalar weapons do not have to be mobile, but if they are to be capable of strategic offensive use capable of regional destruction, they do have to be large. These nations to my knowledge have not constructed such massive antenna arrays.⁶³

The third criterion is the give-away, for it limits the list of remaining nations to but the European powers and Japan. Of these, there are two groups: the nuclear powers - France, and the United Kingdom - and the non-nuclear powers, Japan, Germany, and Italy. These two groups would develop scalar weaponry for a very different set of reasons.

For the "nuclear" group, France and Great Britain, the pursuit of scalar weaponry would be a natural outgrowth of their pursuit of independent nuclear and thermonuclear arsenals. After the Second World War, and more importantly, after the Soviet acquisition of nuclear bombs, each nation was squeezed between two enormous industrial powers each developing massive quantities of nuclear weaponry. In that situation,

⁶³High energy pulsed scalar lasers might conceivably be portable enough to deploy in space.

France and Britain had national and global geopolitical interests not always congruent to America's. In short, it would have been foolhardy for either nation to rely solely on the American nuclear deterrent for their protection. They therefore had to develop independent nuclear arsenals strong enough to cause significant damage to either of the superpowers should such a contingency ever arise. Their arsenals had to be strong enough to induce high enough risk into any military or economic pressure either the USSR or USA could bring to make them think twice about doing so. It was almost a replay - this time with nuclear weapons rather than dreadnoughts - of Grand Admiral Tirpitz's "risk theory" that led to Imperial Germany's naval buildup against Great Britain prior to World War One.

For France and Britain, then, the pursuit of strategic offensive scalar weaponry would be a much more cost-effective way to achieve the same results. Scalar weaponry of that nature would essentially render atomic weapons obsolescent - if not obsolete - as offensive weapons. Not only could scalar weapons simply devastate any missile launch by any power, but make it impossible for any power even to launch its missiles simply by pulsing the circuits making launches possible, and "taking the system down". Moreover, scalar weaponry could be used to detonate such weapons on the launch pad. In short, the geopolitical gain for Europe's two nuclear powers would be incalculable. Acquisition of scalar weaponry would level the playing field once again. By making Russian and American thermonuclear arsenals impotent, their own smaller though sizeable thermonuclear arsenals would gain in weight and importance.

For the other three nations - Japan, Germany, and Italy - the reasons for pursuing development of such weaponry are rather different. All three nations certainly have the technological capability of doing so, and all three certainly have a sufficient industrial base, though in Italy's case that base would be severely strained. In any case, it is to be noted that these three nations are the former Axis powers, and therefore have undertaken specific treaty obligations not to develop atomic, biological, or chemical weapons of mass destruction on their territory. In addition, Japan only very recently, and very reluctantly, decided to increase its defense spending above its self-imposed voluntary limit of one percent of its gross domestic product. Each of these nations therefore has a legal obstacle to the acquisition of certain types of weapons of mass destruction. Moreover, prevailing public opinion within and outside each nation would certainly

The Giza Death Star Deployed

be a factor weighing against the development of nuclear weaponry. Lacking such weapons, their political clout on the world stage, notwithstanding their powerful economies and - in Germany's case -respectably-sized and superbly equipped military, is all out of proportion to post-war international diplomatic structures and protocol.⁶⁴

The second reason these nations might have been strongly tempted to develop scalar weaponry is likewise an obvious one. In Japan's case, to the West lies the nuclear colossus of Russia, and the powerful long-range potential threat of a nuclear China with gigantic manpower reserves, an increasingly sophisticated economy, a gifted and intelligent scientific community, an ancient and proud culture...and old scores to settle. And of course, to the East is the United States, a dubious ally should the pressure from either Russia or China escalate and the American situation at home or elsewhere take a turn for the worse. Japan has compelling reasons to develop such weaponry. Therefore, I believe her to be one of the "Triad nations" mentioned by Bearden. Moreover, Japan would have compelling reasons to demonstrate her possession of such weaponry both to the Soviet Union and to China and, in my opinion, would not hesitate to do so.

In Germany's case, the reasons for development of scalar weaponry are even more pressing. By 1965, West Germany was literally on the front line of defense between the Warsaw pact and the NATO Allies, and locked into a game of nuclear chess between the two superpowers and the lesser nuclear powers of France and Britain. Germany had committed itself to develop no such weapons of its own. For any realistic German politician or general, this was simply an intolerable situation. West Germany's first federal Chancellor, Konrad Adenauer, expressed reservations,⁶⁵ and in the early 1960s a Bundeswehr White Paper clearly

⁶⁴One need only consider the fact that Germany's military is larger than Great Britain's with the exception of the Royal Navy, that its economy is significantly larger, and that its trade is global in extent, rivaling Japan's and America's. The military potential both of Japan and of Germany, as well as their potential ability to project force on a global basis, remains high, yet they do not have permanent seats or vetoes in the U.N. Security Council. One way of verifying the possession of such weaponry by these two major powers would be precisely the revision of the United Nations' Security Council and the seating of these two powers as permanent members of the body with veto rights within coming years.

⁶⁵The Nuclear Axis: the Secret Collaboration Between West Germany and South Africa (New York Times Books: 1978), p. 27.

called for Germany to develop her own independent nuclear arsenal.⁶⁶ Ever the consummate politician of German Realpolitik himself, Secretary of State Henry Kissinger in the early 1970s contrived of the idea of a "multi-lateral force," in essence but a scheme to give Germany nuclear weapons. For obvious reasons, the outcry from France and Britain, not to mention the Soviet Union, to all these plans was fierce. The plans were, at least publicly, dropped.⁶⁷ So Germany had both compelling military, political, and legal reasons to pursue the development of a form of weaponry of mass destruction that would do an end run around existing military technologies and doctrines, and the enormous arsenals of the United States and Soviet Union, with which it could never hope to catch up. For these reasons, as well as others explored below, I believe Germany to be the second member of the very select Scalar Weapons club.

There is also another consideration: no really good or plausible explanation exists for the sudden Soviet volte face with its East German ally. The behavior of Gorbachev in allowing the Wall to be torn down -almost on the demand of West Germany and the United States - is all but inexplicable save on two hypotheses: that it was the action of desperation, or that it was the response of a weakened enemy, whose economy, already a shambles, discovers that its old foe is armed with the most unimaginably destructive weapons ever conceived. The Soviet Union simply had no more moves left on the nuclear chessboard, no cards left to play. So in 1989, the Wall finally came down, and Richelieu's old nightmare of a united Germany was for the second time in modern history a reality.

But who is the third "Triad" nation that is "not hostile to the US?" A little history is necessary to answer this question.

(1) The Soviet Union's Scavenger Hunt

Ironically, it was the Soviet Union itself that began the quest for scalar weaponry, and for reasons very similar to those advanced above for France and the United Kingdom. To understand why it would have undertaken the development of such weaponry, one has to go back to the end of World War Two and the beginning of the nuclear age and Cold

⁶⁶ Ibid., pp. 350-352.

⁶⁷ I am firmly of the opinion that Germany developed nuclear and thermonuclear weapons and delivery systems on her own anyway.

The Giza Death Star Deployed

War. Fully one half of all the fifty million military and civilian casualties of World War Two were suffered by the Russians. The war could not have been won, and most certainly would have been lost, without them. For German Wehrmacht, the sheer scale of operations on the Russian front dwarfed all others; all else, the Italian and French theatres, was for the Nazi military colossus a mere sideshow. It was not a contest between good and evil, but between two brutal and paranoid regimes intent upon their own survival and the utter annihilation of the other. After a three-month campaign the Wehrmacht came within a hair's breath of doing just that, and the Red Army after clawing its way back over the next three and a half years finally succeeded.

For Russia, the cost was enormous. Not only the loss of approximately sixteen percent of Russia's pre-war population, but the utter devastation and dislocation of her labor force, industry, and European Russia's infrastructure. Her economy was a shambles, her manpower reserves exhausted, her people war weary. And on top of all this, America had exploded an atomic bomb. To the western Allies, the Red Army looked like it was poised to roll over Western Europe. After all, it had just defeated the Wehrmacht, and was therefore demonstrably very well equipped and capably led.

But to Stalin and his marshals the situation looked bleak indeed. His economy was in shambles, and he needed to demobilize. But he could not. The Red Army was his only credible bargaining chip; only its numbers and the threat they posed offset the American atomic monopoly. Much to the chagrin of Soviet planners, they had to do the impossible: they had to maintain their economy on a war footing while rebuilding its infrastructure, and they had to acquire and deploy atomic weapons in sufficient numbers as to be a credible power vis-a-vis the U.S.A. By 1949, Russian spies and scientists give Stalin his A-bomb, and a few months after the American H-bomb, the Soviet Union acquired its own thermonuclear capability. But the Soviet Union could never hope to out produce America in thermonuclear weapons.

Bearden's commentary on the Soviet position at this juncture is illuminating:

As one aftermath of the U.S. development and use of the atomic bomb, Stalin -ever the total dictator - lashed his Soviet Academy of Sciences furiously. Undoubtedly he pointed out that the destiny of communism had been frustrated by this great technical breakthrough made by the Americans (with help from the

Secret Societies, Psychics, Spies, SS, Soviets, and Scalars

British and from political European refugees). He informed his scientists in no uncertain terms that the next such breakthrough had better be Soviet. He planned to do exactly what the U.S. had done: Find a new area for a great technical breakthrough and superweapon, put the entire resources of the nation behind it, develop it in great secrecy, and thrust it upon the U.S. and its allies at the eleventh hour....⁶⁸

The Soviet scientists organized the most massive scientific scavenger hunt in history, a Manhattan Project-sized effort in and of itself, all designed simply to scour western scientific journals for a clue that might suggest such a superweapon:

Academy scientists vigorously turned to a massive search for the new breakthrough area. Scientific literature from the West was hauled to Russia by the shipload. Thousands of Soviet PhDs and engineers were put to work in huge analysis institutes, sifting through the literature and digesting it - and carefully noting anomalies and areas which should be followed up. Nothing even remotely approaching such a technical digestion and analysis effort has ever been attempted in the West.⁶⁹

In short, Soviet science was scouring the forgotten or discarded and in some cases even the exotic and esoteric avenues of Western science. The Soviet Union was, due to its isolation and ideological factors, in almost the same situation as the Nazi foe it had just defeated had been.

Bearden's argument now takes a decidedly speculative turn, but one that is very convincing. Arguing that the Soviets have scalar weapons because certain events and physical anomalies are best explained by their existence, he then poses the question how and why were they led to develop them? His answer is, of course, the scenario already outlined. He then inquires what specifically might the Soviet scientists have discovered as they sifted through these scientific journals to enable them to acquire such weapons? In other words, was there anything in the scientific, peer-reviewed literature that would serve as the theoretical foundations for development of such ultra-powerful weapons?

His answer is astonishing. The Russian physicists discovered a not only a basis for the unification of physical fields that was pre-relativistic,

⁶⁸ Bearden, "Historical Background of Scalar EM Weapons," *Analysis of Scalar/electromagnetic technology*, p. 12.

⁶⁹ *Ibid.*, p. 13.

The Giza Death Star Deployed

but they found one that was weaponizable. And not only was it weaponizable, but it was a very flexible weapons platform, capable of a variety of uses in varying degrees of destructive power, up to and including gigantic regional devastation far beyond the power of hydrogen bombs.

Bearden argues that in scouring the western scientific journals the Soviets would have come across three relatively obscure, highly mathematical, and entirely pre-relativistic papers. Two of them were by the mathematician and theoretical physicist E.T. Whittaker, and one was by a physicist named Barus. Of the three, the Whittaker papers are breathtaking in their implications. All of them were published shortly before the appearance of Einstein's theory of Special Relativity.

The first paper, a lengthy and highly mathematical tome, is a masterpiece whose full implications - in spite of its benign title "On the partial differential equations of mathematical physics" - are spelled out by Whittaker himself in the conclusion of the paper:

It is clear from the foregoing that the field of force due to a gravitating body can be analyzed, by a "spectrum analysis" as it were, into an infinite number of constituent fields; and although the whole field of force does not vary with time, yet each of the constituent fields is of an undulatory character, consisting of a simple wave-disturbance propagated with uniform velocity. This analysis of the field into constituent fields can most easily be accomplished by analyzing the potential $1/r$ of each attracting particle into terms of the type

$$\frac{\sin(uVt-ur)}{r}$$

as in the example given. To each of these terms will correspond one of the constituent fields. In each of these constituent fields the potential will be constant along each wave-front, and consequently the gravitational force in each constituent field will be perpendicular to the wave-front, i.e., the waves will be longitudinal.

But these results assimilate the propagation of gravity to that of light: for the undulatory phenomena just described, in which the varying vector is a gravitational force perpendicular to the wave-front, may be compared with the undulatory phenomena made familiar by the electromagnetic theory of light, in which the varying vectors consist of electric and magnetic forces parallel to the wave-front. The waves are in other respects exactly similar, and it seems probable that an identical property of the medium ensures their propagation through space.

Secret Societies, Psychics, Spies, SS, Soviets, and Scalars

This undulatory theory of gravity would require that gravity should be propagated with a finite velocity, which however need not be the same as that of light, and may be enormously greater.

Of course, this investigation does not explain the cause of gravity; all that is done is to shew that in order to account for the propagation across space of forces which vary as the inverse square of the distance, we have only to suppose that the medium is capable of transmitting, with a definite though large velocity, simple periodic undulatory disturbances, similar to those whose propagation by the medium constitutes, according to the electromagnetic theory, the transmission of light.⁷⁰

Superluminal longitudinal waves of great velocity, it will be recalled, were exactly what Nikola Tesla discovered in his direct current impulse experiments. And as will be seen in a subsequent chapter, such waves also can induce gravitational effects.

It is unlikely that Whittaker knew about Tesla's longitudinal electrical experiments, nor that Tesla knew of Whittaker's paper. But according to Bearden, it is likely that the Soviets knew of both, and put the theory, and the practice, together. The Soviets, in other words, had concluded that Tesla had discovered, and experimentally verified, what Whittaker's pre-relativistic mathematics predicted.

Whittaker's second paper, "On an Expression of the electromagnetic Field due to Electrons by means of Two Scalar Potential Functions," contains a breathtaking abstract, forming a theoretical basis for Tesla's observations, and a frightening potential to weaponize the phenomenon via harmonic interferometry of the two scalar potentials:

The object of the present paper is to show that when any number of electrons are moving in any manner the functions which define the resulting electrodynamic field, namely, the three components of dielectric displacement in the aether and the three components of the magnetic force at every point in the field, can be expressed in terms of the derivatives of two scalar potential functions. (Previous writers have expressed them in terms of a scalar potential function and a vector potential function, which are equivalent to four scalar potential functions.) These two scalar potential functions are explicitly evaluated in terms of the charges and co-ordinates of the electrons. It is then shown that from these results the

⁷⁰ E.T. Whittaker, "On the partial differential equations of mathematical physics," *Mathematische Annalen*, Vol 57, 1903 (333-355), p. 355, emphasis in the original.

The Giza Death Star Deployed

general functional form of an electrodynamic disturbance due to electrons can be derived.⁷¹

The careful reader will have noted from the above two quotations that Whittaker maintains that the dielectric and magnetic displacement can both advance along parallel waves fronts, and not in quadrature opposition as current standard "textbook" theory would maintain. This is in fact what engineer Eric Dollard has confirmed in his breathtaking recreation of Tesla's original high-energy direct current impulse experiments. Moreover, Whittaker explicitly maintains that this can be the result of an interferometry of two scalar, and no vector, components. (The crucial, and now almost forgotten, distinction between scalar and vector analysis will be examined in more detail in chapter seven.)

The connection between Germany and Russia's pursuit of scalar weaponry appears to be corroborated by a recent story that was recorded in the April 2002 edition of Fate magazine. I would never have known of its existence had a friend not phoned me to tell me that the first review of The Giza Death Star had appeared in its pages. Anxious to read it, I drove to a nearby newsstand and bought the magazine, but another story — "Domes of Wrath" by Vladimir V. Rubtsov, Ph.D. - immediately captured my attention.

The story recounts events that allegedly occurred during the German retreat in January of 1943. According to the account, a retreating German regiment laid an ambush for an advancing Soviet column of infantry, annihilating it in a murderous crossfire of machine guns from both flanks and two hills that overlooked the line of march of the Russian unit. Days later, as the Soviets sent in more reinforcements to the area to investigate the disappearance of this unit, which had failed to report to its intended position on time, they were met with something of a shock. The German regiment that had laid the ambush was dead, to the last man. At this point, I will pick up Rubtsov's account of the anomalous nature of the massacre:

At last, or rather, first of all - no large shell or bomb craters were discovered in either of the two sites of destruction. The corpses of Soviet soldiers had numerous bullet wounds, but the German soldiers' wounds were more consistent with sudden detonation of ammunition (in haversacks, cartridge pouches, and

⁷¹E.T. Whittaker, "On an Expression of the Electromagnetic Field Due to electrons by means of Two Scalar Potential Functions," Proceedings of the London mathematical Society, Vol. 1, 1904 (367-372), p. 367, emphasis in the original.

Secret Societies, Psychics, Spies, SS, Soviets, and Scalars

simply in the hand). Throughout the whole battlefield, littered with rifles and submachine guns, there was literally not a single live cartridge or hand grenade, every explosive device in the German positions had detonated spontaneously, wherever it happened to be: in rifle magazines, in the pouches of soldiers' equipment, in the backs of vehicles, in boxes on the ground. All these munitions appeared to have exploded simultaneously. Besides, many corpses had no visible injuries at all - but the faces of the fallen were distorted with wild horror.⁷²

Meeting with a man in a nearby village who was alive at the time, Rubtsov records what the man claimed occurred near the two sites of the ambush:

Against the background of the approaching gray darkness, from behind the skyline (open in mis sector of the horizon to a great distance), mere appeared a low, red glow. It reached, as far as Anatoliy could judge, not less than one kilometer in length, resembling the burning of stubble on an autumn field.

For a few seconds, the glow twinkled and oscillated. Then it started to rise quickly, taking the shape of a clearly outlined shining, fiery bubble.... The sharp, clear, ideally geometric contours of a spheroid with a well-defined, roundish, convex surface... Having reached its maximal dimensions, it seemed to stand still for two to three minutes, continuing to glow quite evenly with red light, without any oscillations or any signs of inner movement. Neither curling flames, nor gleams of explosions, nor dark smoky streaks could be seen on its smooth, seemingly polished surface. It was exactly like a gigantic soap bubble of fire.

Eventually, the spheroid started to change. The red tone faded and grew dimmer, being replaced here and there by whitish spots. Then the spheroid began to splinter into separate pale scraps. The decay was developing; the dark, cloudy evening sky appeared between the scraps, and the scraps themselves faded and appeared to dissolve in the surrounding space.

...Suddenly, some three minutes later, the phenomenon reappeared, this time about two or three kilometers to the left of its former position. The dimensions of the second spheroid were not so impressive: maybe 700-800 meters at its base. A few minutes later, it too disappeared, falling apart like the first one.⁷³

Rubtsov notes that Anatoliy said the mysterious bubbles produced no sound.

Speculating on the event, the two entertained the idea that it may have been a German secret weapons test gone horribly wrong,⁷⁴ but it seems

⁷² Vladimir V. Rubtsov, Ph.D., "Domes of Wrath", Fate, April 2002, 16-23, pp. 18-19.

⁷³ Ibid., p. 20.

⁷⁴ Ibid., p. 21.

The Giza Death Star Deployed

unlikely that the Germans would have tested it on a whole regiment of their own troops, especially when that regiment would be sorely needed to stem the advancing flood of Russian units after the Stalingrad debacle. Then again, the Nazi regime was known to be less than concerned with normal human morality and conduct of war. Equally, it could have been a Russian weapons test. There too, practical considerations would seem to say "no", however, since the Communist regime exercised a fanatical control over its secret weapons projects, and would have been unlikely to allow such a weapon to be tested so close to the front lines where danger of capture was always a possibility. Rubtsov himself mentions that Anatoliy believes it was an extra-terrestrial intervention.

Discounting the latter possibility, we are left with one obvious conclusion. The appearance of such spheroids and the detonation of munitions, as we shall see in chapter seven, is one very telltale signature of a low power use of scalar weaponry. In my opinion, the details of the account confirm the reality of the event, for one can imagine the horror of the victorious German regiment as it was suddenly bathed in an incomprehensible, soundless red light and its ammunition began exploding in their ammunition belts, their haversacks, and right in their bare hands. Barring an extraterrestrial intervention, one is left to conclude that this display of scalar weaponry was probably German, since the positions of the German units would have been known only to the Germans, the Russian unit having simply become lost to the Russian commanders in the field (how else explain the Russians sending units to search for the lost unit which failed to report at its destination?) The careful positioning and planning that went into the ambush would dovetail with the precise tuning and preparation that such a weapon would have to have had. And finally, the post-war Soviet scramble to acquire information on scalar weapons and their theory would indicate that perhaps, at some very high level within the Soviet command structure, someone knew precisely what to look for, what documents to copy, and what German radar scientists to capture at the end of the war.⁷⁵

As a final interesting note, some stories do circulate that the Soviet Union sent out teams of archaeologists, from the 1950s to its collapse, to

⁷⁵As a sideline, it is perhaps worth noting that some Germans, Romanians and Hungarians stated after the war that the Germans had in fact tested some sort of "death ray" on Russian troops a few times during the war. Most of these reports involve a date of late 1944, during the Axis ouster from Romania.

Secret Societies, Psychics, Spies, SS, Soviets, and Scalars

scour ancient archaeological sites. There are rumors that the Russians discovered "crystals" of some sort, and that these discoveries remain a highly classified national secret of the Russian government.

(2) France (Infra)Sounds Off

As the Soviets were busily, though very secretly, developing the theory and engineering of this "scalar" technology, scientists in France made another discovery of a "scalar" nature: the power of very low frequency highly amplified sound waves to collapse the structure of matter itself through acoustic vibration. Discovered in the 1950s by the French physicist Gavreau, and quickly seized upon by the DeGaulle government as a fast and cheap method to dominate a battlefield overrun with Russian tanks, the phenomenon was soon weaponized and placed in remote controlled robots for tactical use. But as Gavreau also demonstrated, with enough power, amplification, and a large enough weapon, much larger devastation could be created. Thereafter Gavreau's infrasound weaponry disappeared from discussion, but doubtless, not from French laboratories, for Gavreau had discovered one important aspect of scalar technology: the power of acoustics to smash the molecular and atomic structure of any element.⁷⁶ France discretely informed the Soviet Union of its discovery via a series of controlled demonstrations. The message was clear. I therefore believe France to be a possible contender for the third Scalar Triad nation.

(3) World War Two: The Ideological Problem for Science in Germany

The ideological problem for science in Germany under the Nazi regime was almost identical to that of science in Soviet Russia under the Communists, and hence the pressure on its scientists to develop an "alternative paradigm" was quite strong. But what does all this mean? And what relevance does it have to the investigation of the weapon hypothesis of the Great Pyramid?

In order to understand why Germany would seek to develop such weapons, especially under the Nazis, it is necessary to understand some

⁷⁶ Cf. chapter 8.

The Giza Death Star Deployed

basic geopolitics. First one must understand that Germany's military doctrine is a product, not of fanatical Nazis, but simply of her geopolitical situation. Surrounded by such powerful potential enemies as France, Russia, England and (at one time) Austria, Prussia simply had to develop a military that, man-for-man, canon for canon, could outfight and out maneuver any enemy. "Blitzkrieg" or "firepower attrition" became Prussia's, and thus Germany's, de facto military doctrine: the ability to concentrate overwhelming force at a locality, deliver a knockout punch, and then move rapidly to exploit the blow, or to turn and face a new enemy. Frederick the Great, and not the Kaiser or Hitler, created the doctrine. The Kaiser merely gave it mobile heavy artillery, and Hitler merely added the tanks and dive-bombers.

Second, this means two things will always be a stable factor in the national life and policies of any self-respecting German government: (1) a strong military with the best available conventional weaponry and a massive reserve system capable of being activated on very short notice; and (2) an impetus to investigate any avenue of research that will lead to the "decisive weapon", i.e., weaponry that will give the German military a decisive tactical and/or strategic edge on the global geopolitical chess board and secure her very shaky position in the center of a Europe dominated by powerful nations.

With that observation, we have Germany's entry into the race - not to acquire atomic weapons - but the vastly more efficient and destructive scalar weaponry.

The trouble is, Germany entered the race not once, but twice, the first time during World War Two. Having denounced relativity and certain aspects of quantum mechanics as "Jewish physics," the Fuhrer severely shackled German physics, not only driving out of Germany the very men who might have delivered to him the ultimate weapon of his day, but also limiting any research into ideologically approved channels. The dividend was enormous, but came too late to do the Nazi leadership any good.

At the war's end, Allied scientific scavengers made their way into Germany and began hauling off railroad cars full of German patents and secret wartime research - much of it still classified! - and they found something very frightening indeed. Not only because of Germany's isolation, but because of the Nazi rejection of standard western physics -"Jewish physics " — and its ideological adherence to the Nazi equivalent of the old concept of aether and vacuum-space energy, German science had

pushed the frontiers of "esoteric" physics in new and frightening directions. In this regard, the famous book on the occult influence in Nazism, by Louis Pauwels and Michel Bergier, *The Morning of the Magicians*, makes an intriguing and suggestive comment:

When the War in Europe ended on May 8th, 1945, missions of investigation were immediately sent out to visit Germany after her defeat. Their reports have been published; the catalogue alone has 300 pages. Germany had only been separated from the world since 1933. In twelve years the technical evolution of the Reich developed along strangely divergent lines. Although the Germans were behind as regards the atomic bomb, they had perfected giant rockets unmatched by any in America or Russia. They may not have had radar,⁷⁷ but they had perfected a system of infra-red ray detectors which were quite as effective. Though they did not invent silicones, they had developed an entirely new organic chemistry, based on the eight-ring carbon chain.

...They had rejected the theory of relativity and tended to neglect the quantum theory.... They believed in the existence of eternal ice and that the planets and the stars were blocks of ice floating in space. If it has been possible for such wide divergencies to develop in the space of twelve years in our modern world, in spite of the exchange of ideas and mass communications, what view must one take of the civilizations of the past? To what extent are our archaeologists qualified to judge the state of the sciences, techniques, philosophy and knowledge that distinguished, say, the Maya or Khmer civilizations?⁷⁸

Ideology and isolation were the twin catalysts that gave birth in Germany to the prototypes of today's sophisticated array of conventional "smart" weapons and the less well-known, but far more destructive, scalar weapons. To put it in modern terms, because of the Nazi rejection of relativistic "Jewish physics", the German physicists working on secret weapons projects were forced into the very early pursuit of what modern physics would later call quantum gravity.

⁷⁷ In fact, they had more than just radar.

⁷⁸ Louis Pauwels, Michel Bergier, *The Morning of the Magicians*, pp. 170-171.

⁷⁹ An unsubstantiated, but believable, rumor exists that the FBI knew that "German intelligence has already spirited away a sizable amount of Telsa's research several years before his death. This stolen material, it is thought, would eventually result in the development of the Nazi flying saucer. The United States was going to make sure that this would not happen again." Tim Swartz, *The Lost Journals of Nikola Tesla* (Global Communications, No Date), p. 11.

The Giza Death Star Deployed

(a) Say that again, please: The Germans Came up with what!?

A number of very peculiar mysteries surrounds the end of World War Two in Europe, and the persistence afterward of an Allied "legend" concerning the origins of the atomic age and its most visible icon: the mushroom cloud. It is worth pausing here to survey these mysteries and what they might signify for the question at hand, scalar weaponry.

Recently a remarkable book appeared in Great Britain. The book's author, Nick Cook, is an editor and reporter for the prestigious periodical *Jane's Defense Weekly*, a name familiar to anyone with a serious interest in the latest military technology and related engineering matters. Cook's book, *The Hunt for Zero Point*, is as its title suggests, about the very secret and hidden research probably being conducted by the United States and a very few other countries into the release of the enormous energies of the vacuum flux, or zero point, energy predicted by quantum mechanics.

However, as Cook recounts in his book, much of his early interest was damped by something that he kept bumping into, no matter where he turned: the "Legend". Quickly tracing connections between early post-war anti-gravity research and the appearances in Europe's skies of the first UFOs, he, much to his chagrin, bumped into "the Legend." The Legend is that the earliest "flying saucers" were exotic airframes built and tested by the Nazis as part of their weird and strange wartime research. Cook's reaction, like my own when I first learned of The Legend, was one of laughing derision-turned-contemptuous dismissal, for the problem of The Legend is that it ultimately traces back to but a few post-war sources, each with their own questionable agendas and associations, and most of it unsubstantiated. And the Legend seems to grow with each retelling, until by now, on the fringes of contemporary UFO, it maintains that the Nazis erected a secret base in Antarctica to which they transported thousands of scientists who perfected their anti-gravity craft (in some versions colluding with aliens or people from "the hollow earth") and currently are orchestrating a massive deception in preparation for the Big Comeback.

Thus, so The Legend goes, one can account for the massive military expedition of Admiral Byrd in 1947 (Operation Highjump), its sudden and inexplicable "defeat", Byrd's cryptic remarks and warnings reported in various South American newspapers, subsequent atomic detonations by the USA over the South Pole ostensibly in support of research for the International Geophysical Year, and so on.

Secret Societies, Psychics, Spies, SS, Soviets, and Scalars

But there is equal strangeness, if not downright implausibility, to military operations and statements of both sides during the last days of the war. Consider the following Inventory of High Strangeness:

1. Hitler, during a conference with his generals in the Bunker in 1945, made the wild pronouncement, when questioned by one of them as to why the strongest and best formations left to the Wehrmacht were deployed, not in defense of Berlin, but of Prague, that Prague was the key to winning the war. Allied military intelligence also confirmed that the strongest SS panzer formations were deployed in the vicinity of Prague, an order of battle that, on the plain face of things, made no military sense to them, other than, as the Allies' own estimates of the situation concluded, that Berlin had ceased to be an important economic and military target.
2. General Patton's US Third Army literally raced through Bavaria into Bohemia, making a beeline for the famous Skoda armaments works at Pilsen, all but blown off the map by Allied bombing raids.
3. Hitler boasted that Germany would deploy horrendous new weapons that would snatch victory from defeat at "five minutes past midnight."
4. The Germans were nearing completion of an enormous airfield in Norway.
5. U-boats departed Germany with secret cargoes, some bound for Japan, others to the South Atlantic, right up to the end of the war. One of these, the U-234, was carrying plans for rockets, jet aircraft, scientists and engineers, and two Japanese military officers, was bound for Japan. When captured by the Americans, the U-boat's torpedo tubes were discovered to have been full of metal cylinders that, according to some reports, were lined with gold. Gold lining has but one purpose: to protect from radiation of refined uranium, yet Germany, so the Allied legend goes, was nowhere near a functioning nuclear reactor, and therefore, nowhere near enough stockpiling of weapons-grade uranium. Other U-boats surrendered themselves to Argentinian authorities three months after the war, and their captains steadfastly refused to reveal their cargoes or whereabouts for the three months following the German surrender.

The Giza Death Star Deployed

6. With respect to the probable use of the cylinders in U-234 to transport refined uranium, it is worth noting that as late as March 1945, American engineers in the Manhattan project complained that their stocks of U-235 were about half the necessary critical mass for a bomb, after three years of intensive stockpiling and research. So another nasty question for standard history looms: where did the other half come from?
7. Curiously, approximately a week before the German surrender, a lone Luftwaffe Ju-390 flew from Norway to within 12 miles of New York City, and then back to Norway, a non-stop flight of over 32 hours.⁸⁰
8. Equally curious is the fact that the American uranium bomb dropped on Hiroshima was never tested. We are implicitly asked to believe the post-war histories that the Americans dropped their one and only supply of an uranium bomb on Hiroshima without having first tested it, an exercise of military folly and incompetence unthinkable at that stage of the war. What if the bomb had not exploded, and the Japanese, eagerly at work on their own A-bomb (and accordingly to one version, within days of testing their own version of it successfully⁸¹) recovered it?
9. Finally, and perhaps most importantly, what does one make, when all is said and done, of the sudden inability of Heisenberg, Hartek, Diebner, Gerlach, Hahn and others to produce the bomb, especially since Heisenberg was able, within a week of the news of Hiroshima, to come up with an essentially correct estimate of the

⁸⁰ The Junkers 390 was an enormous six-engined heavy-lift transport plane that could conceivably have doubled as a bomber, resembling in some respects the later American Convair B-36 "Peacekeeper" transcontinental strategic bomber. It was easily capable of a round-trip non-stop flight from Scandinavia to New York. According to the best available records, only two versions of the airplane were ever built. After the war, one of these craft mysteriously went "missing", along with whatever cargo it was carrying to wherever. Equally mysterious, SS General Dr. Ing. Hans Kammler, the Third Reich's plenipotentiary for all secret weapons research, "died" (or disappeared) under mysterious circumstances at the end of the war. Kammler, in his official capacity, had jurisdiction over all of Germany's heavy-lift long range transport aircraft, including the four-engined Ju 290 and the six-engined Ju 390.

⁸¹ Robert K. Wilcox, *Japan's Secret War: Japan's Race Against Time to Build its Own Atomic Bomb* (New York: Marlowe and Company, 1995).

critical mass of a uranium bomb and the basic design of the bomb itself?

In short, the whole affair seems implausible. Not merely the Nazi UFO "Legend," but the equally improbable Allied "spin" after the end of the war, ably summed up by Manhattan Project scientist and engineer, Samuel Goudschmidt: "We were just better." How does one really explain why so many "brilliant nuclear physicists, including Nobel Prize winners before the war, (were) apparently struck by some strange malady which turned them into incompetent bunglers during the Second World War; of the Peenemiinde team who produced the world's first large rockets within a short space of time, but only because they were interested in space flight. But from 1943 to 1945, this same Peenemunde team, now considerably larger, appears to have been suffering from a similar 'sickness' that affected the nuclear workers, because nothing new emerged from Peenemunde in one-and-a-half years, only paper rockets."⁸² How does one explain a wartime incompetence on the part of Heisenberg, Oberth, Diebner, Hartek, Gerlach, von Braun and others, that equally mysteriously vanishes just as quickly - in Heisenberg's case within less than a week! -after the end of the war?

Several hypotheses to these perplexing questions have been advanced in recent years, including the stupendous notion that Heisenberg almost single-handedly sabotaged Germany's a-bomb research.⁸³ For a variety of reasons, I discount that explanation, not the least of which is because that Heisenberg's was not the only line of nuclear research being pursued in Germany. Dr. Kurt Diebner most likely headed a completely separate a-bomb project in conjunction with the Deutsche Reichspost,⁸² a position in

⁸² Philip Henshall, *The Nuclear Axis: Germany, Japan and the Atom Bomb Race 1939-45* (Stroud: Sutton Publishing Limited: 2000), Introduction.

⁸³ Cf. Thomas Powers, *Heisenberg's War: The Secret History of the German Bomb* (Da Capo Press: 1993). In deliberate opposition to Powers, the more-thoroughly researched (from a scientific standpoint) work of Paul Lawrence Rose, *Heisenberg and the Nazi Atomic Bomb Project: A Study in German Culture* (Berkeley, California: University of California Press, 1996). Rose points out that a body of evidence exists to support the idea that Heisenberg labored under the "reactor" concept of a fission-bomb, thus leading to errors of miscalculation of critical mass. Notwithstanding Rose's excellent research, however, a Top Secret 1942 Heereswaffenamt paper, most likely by Dr. Kurt Diebner, correctly estimated the critical masses both of a uranium bomb and of a plutonium bomb. So the problem is not that the Germans did not know the critical mass, but that they did. Labor as Rose does to continue the Allied version of the Legend, his book does more to exhibit its real problematic.

The Giza Death Star Deployed

which he would have come into close contact with the secretive Baron Manfred von Ardenne, whose solution to the acquisition of a stockpile of weapons-grade uranium was not so much novel, as obvious, and from the post-war Allied Legend's point of view, highly problematical. Von Ardenne's solution was the typical engineer's solution to the problem of constructing a working atomic reactor and keeping it safe from Allied bombers: simply use massive numbers of mass spectrometers and ultra-centrifuges to enrich uranium.⁸⁴ The standard response to this has always been that the construction of such a large Oak Ridge sized facility would have certainly caught the attention of Allied aerial reconnaissance, and not long after that, of Allied bombers.

So how does one resolve all these facts of the Inventory of High Strangeness that surrounds the end of World War Two? While leaving the details to be the subject, perhaps, of another book, I believe that the following best explains the anomalous military dispositions and behaviors of the Germans and Allies shortly before and immediately after the end of the European theatre of operations:

1. Germany built, and tested, and perhaps deployed on a very limited basis, fuel-air bombs shortly before the war or shortly after its beginning, using them - if she used them at all - on the eastern front.
2. Germany built, and tested, one and possibly more atomic weapons, some with an incredibly small critical mass utilizing the "boosted fission" process subsequently explored by American and Western bomb scientists in the late 1960s and 1970s. These were likely tested ca. mid-1943 to late 1944. These early "tactical nukes" - if used at all - may have been used on the Eastern front. Affidavits from captured German pilots and Italian military officers confirm tests of weapons whose signatures can only be those of nuclear weapons.⁸⁵

⁸⁴Not so well known is the fact that unlike many German scientists, von Ardenne decided to collaborate with the Soviets after the war on their own atomic bomb project, a fact which won him the coveted "Stalin Prize," the Soviet equivalent to the Nobel prize. Von Ardenne was the first non-Russian scientist to have that distinction, which leaves one guessing just how much he had to do with the first Russian mushroom cloud.

⁸⁵Cf. the recently declassified statement of the German pilot Hans Zinnser, whose description of such a test in a remote region of the Harz Mountains in 1944 is explainable only as a nuclear test of some sort. It should be noted that the Harz Mountains were one target of General Patton's headlong dash through southern Germany in the closing days

3. The argument that a large Oak Ridge-sized separation facility would have been detectable and subject to Allied bombing, and that hence Germany would have been incapable of stockpiling enough weapons-grade material, is fallacious, since there were two means the Nazi regime had at its disposal to protect such facilities:
 - a. Unpleasant as it is to contemplate, the Nazis could have, and I believe probably did, build some such facility near the death camp of Auschwitz, which it had become obvious to the Nazis that the Allies knew about, but did not bomb.⁸⁶
 - b. More importantly, since the recent reunification of Germany, a number of hitherto unknown, and large, Nazi underground "factory" facilities have come to light, not the least of which is a curious complex of facilities disguised in mines in the former German province of Silesia, northwest of Breslau in what is now Poland. Germany could thus have simply hidden such facilities both from the Allies and from Soviet aerial reconnaissance. It is a well known fact that the western Allies had no idea of the huge extent of these underground facilities until the capture of several rocket and jet aircraft production plants in Thuringia by Patton's troops in 1945.
4. Given these possibilities, the German and Allied order of battle and actual operations in the final weeks of the war make sense, since Prague was the logical logistical and operational center of a German army desperately trying to preserve these facilities and their precious research from capture until their fantastic projects could be brought to fruition. And let it be recalled that these troops were the last viable Waffen SS formations available to the German command, and that the Reich's secret weapons research was by that time consolidated under the direction of SS General Dr. Ing. Hans Kammler, a fanatic butcher utterly devoid of moral scruples.

of the European war. Thus, the conventional explanation of Allied historiography, that the Allied commanders were afraid of a last-ditch Nazi stand in the "Alpine Redoubt" may be nothing more than a cover story for what Allied intelligence already knew.

⁸⁶ The Nazi "logic" in this is easily understood if one recalls current accusations of America and its Western Allies that Saddam Hussein and the Baathist regime in Iraq hide their secret research installations in, under, or near humanitarian facilities such as hospitals.

The Giza Death Star Deployed

5. The flight of the lone Ju-390 from Norway to New York in the final war days of 1945 now makes sense, for it is nothing less than a "proof of concept" that the Luftwaffe could successfully, even at that late stage of the war against overwhelming Allied air superiority, mount a single aircraft strike against the principal American strategic target of the war.... And a single airplane strike against New York by a heavy lift transport plane can mean only one thing...

It is against this rather dramatic and macabre backdrop that we return to Nick Cook's perplexity at having so consistently bumped into the Nazi-UFO "Legend" while researching his *The Hunt for Zero Point*. As Cook observes, the one physicist in the odd mix of Germans interred by the British at Farm Hall after the war was Walter Gerlach, a specialist in gravitational, not nuclear, physics, for Gerlach highlights, perhaps better than Heisenberg himself, the question "The Germans were up to what!?"

Cook, tracing the German connection to its final end, comes across a Polish researcher, Witkowski, who told him of the affidavit of an SS General sentenced to death by a Polish war crimes court after the war, and of a strange experiment known simply as "The Bell." I cite his work extensively here because of its intrinsic interest to the question of German interest in what we are now calling scalar weaponry:

For years, Witkowski had been sifting through archives related to the many secret Nazi scientific establishments in and around Breslau - modern-day Wroclaw - looking for traces of wartime secret weapons work. What he'd uncovered was evidence of a systematic SS-controlled R&D operation in a rat-run of interconnected facilities, many of them underground, in the remote Sudeten Mountains in the south-west of Poland - Lower Silesia as it had been, before its hand-over to Poland under post-war reparations by Germany.

Witkowski's research led him to conclude that a number of these facilities had been used by the SS for nuclear research work. But one site did not conform to the pattern. In this case, he said, a series of experiments had taken place in a mine in a valley close to the Czech frontier. They had begun in 1944 and carried on into the April of the following year, under the nose of the advancing Russians.

The experiments required large doses of electricity fed via thick cabling into a chamber hundreds of meters below ground. In this chamber, a bell-shaped device comprising two contra-rotating cylinders filled with mercury, or something like it, had emitted a strange pale blue light.

Secret Societies, Psychics, Spies, SS, Soviets, and Scalars

At this juncture, let us pause briefly and simply note that mercury is an essential component to the well-known "mercury vortex engines" described in ancient Sanskrit literature that was cited in my previous book. The Nazis, assiduously combing ancient texts for clues to the source of their occult-based doctrine of "vril" energy, would certainly have come across these references, and with their quantum physicists' approach to gravity, put "two and two" together.

A number of scientists who had been exposed to the device during these experiments suffered terrible side effects; five were said to have died as a result.

"Word had it that the tests sought to investigate some kind of anti-gravitational effect, Witkowski said. He wasn't in a hurry to agree with this assessment, he added, but he was sufficiently intrigued by the data to alert me to the possibilities."⁸⁷

Witkowski had, Cook, recounts, uncovered the existence of a unit within Kammler's research command structure called SS Kommandosache III:

It was then that Witkowski, who had listened for several minutes patiently enough, interrupted me. His research had uncovered the existence of an SS-run 'Special Evacuation Kommando (command, team or unit) mat had evacuated the 'Bell' and its supporting documentation, prior to the Russians' overrunning the facility. The evidence said it had been shipped out, destination God only knew where; except it wasn't there when the Russians arrived."⁸⁸

This SS operational command was also involved in a "general evacuation plan" apparently hatched by none other than Martin Bormann:

The papers that Witkowski had been allowed to transcribe detailed the activities of a special unit of the Soviet secret intelligence service, the NKVD, forerunner of the KGB. Attached to this unit were two Polish officers, General Jakub Prawin, head of the Polish military mission in Berlin, and Colonel Wladyslaw Szymanski, a senior member of his staff.

It was during their 'deriefing' of a former high-ranking official from the Reichsicherheitshauptamt, the Reich Central Security Office or RSHA, that Prawin and Szymansky learned of 'General plan 1945'.

Their interrogation subject, Rudolf Schuster, had worked at the RSHA -one of four security organizations run by the SS-controlled Sicherheitsdienst or Security Service - until his deployment on 4 June 1944 to the Special Evacuation Kommando, an organization unknown to the NKVD, which prided

⁸⁷ Nick Cook, *The Hunt for Zero Point*, pp. 182-183.

⁸⁸ *Ibid.*, p. 183.

The Giza Death Star Deployed

itself on knowing everything. Schuster, it transpired, had been responsible for the ELF's transportation arrangements.

Schuster's information must have set alarm bells ringing at the highest Soviet levels, for Prawin and Szymanski had learned that the man behind General plan 1945 was none other than Martin Bormann, Hitler's deputy, last seen fleeing the Fuhrerbunker on the night of 1 May. Though supposedly killed in the attempted break-out, Bormann's body had never been formally identified. Tying Bormann into a scheme for some kind of evacuation procedure, therefore, had disturbing implications, but pumping Schuster was evidently pointless as it was clear he was only privy to the transportation details. The SS, operating on its traditional compartmentalisation system of security, had kept him from the broader aspects of the plan. It was apparent, however, that much of the Kommando 's activities centred on the territory of Lower Silesia, now southwest Poland.

At this juncture, General SS Sporrenburg and a special SS Sonderkommando enter the picture:

Sporrenberg was a big shot, one of a scattering of senior SS police generals of exalted rank and status positioned to give Himmler absolute power throughout Germany in the closing years of the war. To put his seniority in perspective, he carried the same rank as Ernst Kaltenbrunner, the brutal Austrian who succeeded Heydrich as head of the Reich Security Office, the Nazi's central agency for internal counter-espionage and repression. For Sporrenberg to have been assigned the command of the Special Evacuation Kommando unit attached specifically to Hanke's gau of Lower Silesia shows how important Bormann's evacuation plan was considered to be.

And, I thought, just how ... secret. There has never been any official acknowledgement of the existence of the Special Evacuation Kommando.

Exactly what, I asked Witkowski, was the Kommando tasked with evacuating?

Sporrenberg, he continued, was sent for trial and sentenced to death in 1952, but not before he had testified in secret before the Polish courts about his role as one of Lower Silesia's main plenipotentiaries for the evacuation of high-grade technology, documents and personnel or his part in the murder of 62 scientists and lab-workers associated with a top-secret SS-run project in a mine near Ludwigsdorf, a village in the hills south-east of Waldenburg, close to the Czech border.

Sporrenberg, operating under the political oversight of Gauleiter Hanke, had been in charge of a Kommando cell tasked with 'northern route' evacuations via Norway, which remained in German hands until the very end of the war."

Back to "the Bell":

Secret Societies, Psychics, Spies, SS, Soviets, and Scalars

But it was Sporrenberg's northern route operations that underpinned the reason for the trip, because it was Sporrenberg who provided the only details that have ever come to light on the Bell.

The experiment started out at a top-secret SS-run facility near Leubus (Lubiaz in modern-day Poland), northwest of Breslau, in early-mid 1944. With the Soviets' rapid push into Poland during late 1944/early 1945, the unit was transferred to a castle on a hill above the ancient village of Puerstenstein (Ksiaz), 45 km to the south, close to the Lower Silesian coal-mining centre of Waldenburg. From there, it was moved again to the mine near Ludwigsdorf (Ludwikowice), 20 km the other side of Waldenburg, nestling in the northern reaches of the Sudeten Mountains. The Wenceslas Mine, where the Bell ended up, had been requisitioned by the SS as part of a neighboring underground weapons complex, codenamed Riese - 'Giant'.

Riese, only part-completed by the end of the war, was an attempt to transform an entire mountain into an underground weapons production centre. The many tens of kilometers of galleries that had been tunnelled by the end of the war had been clawed from the rock by inmates drafted in from the nearby concentration camp of Gross-Rosen. Modern excavations of Riese show that the SS had been attempting to link it to the Wenceslas mine via a tunnel almost ten kilometres long."

And the heavy lift Junkers 290 and 390 transport aircraft reenter the picture.

"The Germans maintained a special detachment of aircraft, probably Ju290s, and a single Ju 390, both rare heavy transport types, based at Opeln - Opole today -a hundred kilometres from here. Witnesses say the planes were well camouflaged and that some were painted with yellow and blue identification markings, which suggests they were masquerading as Swedish planes. If so, it was almost certainly a unit of KG 200, the Luftwaffe special operations wing, which frequently flew aircraft under the flag of enemy or neutral countries. The point is, the Evacuation Kommando had the ability to move thousands of tons of documentation, equipment and personnel, and they could move it north or south. Sporrenberg's brief was to go north. The whole operation was highly secret. But nothing, it seems, was more secret than the Bell."

Following his capture, as much as Sporrenberg was able to divulge to Soviet intelligence and the Polish courts about the Bell was this, Witkowski said. The project had gone under two codenames: 'Laternenträger' and 'Chronos' and always involved 'Die Glocke' - the bell-shaped object that had glowed when under test. The Bell itself was made out of a hard, heavy metal and was filled with a mercury-like substance, violet in colour. This metallic liquid was stored in a tall thin thermos flask a metre high encased in lead three centimeters thick.

The experiments always took place under a thick ceramic cover and involved the rapid spinning of two cylinders in opposite directions. The

The Giza Death Star Deployed

mercury-like substance was codenamed 'Xerum 525'. Other substances used included thorium and beryllium peroxides, codenamed Leichtmetall.

The chamber in which the experiments took place was situated in a gallery deep below ground. It had a floor area of approximately 30 square metres and its walls were covered with ceramic tiles with an overlay of thick rubber matting. After approximately ten tests, the room was dismantled and its component parts were destroyed. Only the Bell itself was preserved. The rubber mats were replaced every two to three experiments and were disposed of in a special furnace.

Each test lasted for approximately one minute. During this period, while the Bell emitted its pale blue glow, personnel were kept 150 to 200 metres from it. Electrical equipment anywhere within this radius would usually short circuit or break down. Afterwards, the room was doused for up to 45 minutes with a liquid that appeared to be brine. The men who performed this task were concentration camp prisoners from Gross-Rosen.

During the tests, scientists placed various types of plants, animals and animal tissues in the Bell's sphere of influence. In the initial test period from November to December 1944, almost all the samples were destroyed. A crystalline substance formed within the tissues, destroying them from the inside; liquids, including blood, gelled and separated into clearly distilled fractions.

Plants exposed to the Bell included mosses, ferns, fungi and moulds, animal-tissues included egg white, blood, meat and milk; the animals themselves ranged from insects and snails to lizards, frogs, mice and rats.

With the plants, chlorophyll was observed to decompose or disappear, turning the plants white four to five hours after the experiment. Within eight to fourteen hours, rapid decay set in, but it differed from normal decomposition in that there was no accompanying smell. By the end of this period, the plants had usually decomposed into a substance that had the consistency of axle grease.

These effects are entirely consistent with the sort of temporal anomalies one would expect to encounter with non-linear scalar weaponry and its "time-reversed" waves.

In a second series of experiments that started in January 1945, the damage to the test subjects was reduced to around 12-15 per cent following certain modifications to the equipment. This was reduced to two to three per cent after a second set of refinements. People exposed to the programme complained of ailments, in spite of their protective clothing. These ranged from sleep problems, loss of memory and balance, muscle spasms and a permanent and unpleasant metallic taste in the mouth. The first team was said to have been disbanded as a result of the deaths of five of the seven scientists involved."

There were scant clues, he admitted, but those that Sporrenberg had provided in his testimony seemed to add up to something. Many of the descriptions used by the Bell scientists did not gel with any of the accepted terms associated with nuclear physics, nor were there any obvious radioactive

Secret Societies, Psychics, Spies, SS, Soviets, and Scalars

materials used in the experiments themselves. One of the terms Sporrenberg had picked up had been 'vortex compression'; another was 'magnetic fields separation'. These were physical principles that had come to be associated with the new wave of gravity and anti-gravity pioneers - people like Dr Evgeny Podkletnov, Witkowski said.

Podkletnov. Now, I began to pay more attention. If I'd interpreted Witkowski correctly, there was some kind of a relationship between the Russian's experiments with spinning superconductors - the effect he had tripped over in Finland when his assistant's pipe-smoke had hit that column of gravity-shielded air - and the effect produced by the Bell.

Witkowski also claimed there were anomalies in the curriculum vitae of professor Walther Gerlach that placed him firmly in the orbit of the gravity scientists, despite the fact that, ostensibly, his discipline was nuclear physics. In the 20s and 30s, Witkowski discovered, Gerlach had immersed himself in phenomena such as 'spin polarisation', 'spin resonance' and the properties of magnetic fields - areas that had little to do with the physics of the bomb, but much to do with the enigmatic properties of gravity.

A student of Gerlach's at Munich, O.C. Hilgenberg, published a paper in 1931, entitled 'About Gravitation, Vortices And Waves in Rotating Media' - putting him in the same ballpark as Podkletnov and the Bell. And yet, after the war, Gerlach, who died in 1979, apparently never returned to these subject matters, nor did he make any references to them; almost as if he had been forbidden to do so.

'The Germans ignored Einstein and developed an approach to gravity based on quantum theory,' Witkowski said 'Don't forget that Einsteinian physics, relativity physics, with its big-picture view of the universe, represented Jewish science to the Nazis. Germany was where quantum mechanics was born. The Germans were looking at gravity from a different perspective to everyone else. Maybe it gave them answers to things the pro-relativity scientists hadn't even thought of.'

"The (the SS-run organization Forschungen Entwicklungen und Patente), according to Witkowski's researches, operated independently of the Reichforschungsrat, the Reich Research Council, but would unquestionably have had oversight of it.

My guess was that the FEP had been administered by Kammler's secret research cell within the Skoda Works. After the war, the Allied powers seized 340,000 German-held patents from the captured records of the Reich Research council.

But here was something else: the cream of Germany's wartime scientific research had been skimmed off by the SS and compartmentalized for its own use. Its value would have been immeasurable. Perhaps this really was what Kammler had returned to Czechoslovakia for in the death throes of the Reich?

Again we must pause, for several components of the Inventory of High Strangeness begin to make sense. Witkowski alludes to the existence of a

The Giza Death Star Deployed

secret SS research facility based at the Skoda works in Pilsen. In actual fact, there was such a research facility, but its function was that of a think-tank, designing fantastic paper projects - including a futuristic "Star wars" space-based system of gigantic solar mirrors!⁸⁹ - and the necessary technology trees to the acquisition of such weapons in deliberate calculated steps. To this end, the Germans actually began to convert the old Wenceslas mine in a remote region of the Sudeten mountains.

High on the opposite bank was a large red-brick house, an original 19th century feature of the Wenceslas Mine. But look a little closer, Witkowski said, and you could see where the Germans had tunneled into the ground underneath and constructed a large concrete bunker, one of the many blockhouses scattered around the complex. All of the bunkers had been ordered with earth and trees planted on top.

In short, the Germans had gone to a great deal of trouble to ensure that the place looked pretty much as it had always looked since mining operations began here at the turn of the last century, a clear indication that whatever had happened here during the war had been deeply secret. Now, half a century after the Germans had left, second-guessing the use to which it had been put, simply from the available physical evidence, was far from easy.

That, I could understand. The place was as far off the beaten track as I'd ever been on the continent of Europe. I felt like I was tramping on ground that had hardly been touched since the Germans had pulled out more than half a century earlier.

The first thing to point out, Witkowski said, was the structure at the end of the valley. This, built before the war, was a power-station capable of burning a thousand tons of coal a day -enough to provide the valley with vast quantities of electricity. It had more than likely been this single feature that had drawn the SS to the site, Witkowski said, since it had helped to make the place entirely self-sufficient. After the war, when the Russians eventually made it into these hills, they would have an abandoned complex given over to some quasi-military purpose, a mine shaft that had been flooded, possibly deliberately, and little more.

And in the midst of this High Strangeness, an even more curious structure, a modern concrete "henge":

⁸⁹The Nazi scientists even worked out the calculations for how large such a mirror would have to be to be of any strategic offensive value. The fact of the existence of such a research unit, not only dreaming of such systems, but working out the general parameters and technology trees of its staged long-term acquisition long before "Star Wars" was a gleam in Ronald Reagan's eye or a science fiction movie epic on the silver screen should give one pause.

Secret Societies, Psychics, Spies, SS, Soviets, and Scalars

Caught in the headlights, rising out of the ground straight ahead, was a circular concrete construction 30 metres wide and 10 high. With its 12 metre-thick columns and horizontal beams, it was part-reminiscent of some ritual pagan edifice.

Witkowski parked the car, but left the headlights on, the beams bathing the columns of the object in bright white light.

He was studying what looked like a partly exposed underground drain. Its concrete cover had cracked to reveal a duct about a foot across.

'This carried the electricity cable from the power-station,' he said. 'It disappears into the ground just beyond the car, but diverts via this thing.'

'What is it?' I asked again.

'I am not sure. But whatever it is - whatever it was - I believe the Germans managed to complete it. In this light it is difficult to see, but some of the original green paint remains. You do not camouflage something that is half-finished. It makes no sense.' He paused. 'There is something else. The ground within the structure has been excavated to a depth of a metre and lined with the same ceramic tiles that Sporrenberg describes in the chamber that contained the Bell. There are also high-strength steel hooks set into the tops of the columns. I think they were put there to support something; to attach to something. Something that must have exerted a lot of power.'

I looked at him. 'What are you saying?'

He took a moment before replying. 'I'm saying I think it's a test-rig. A test-rig for a vehicle or an engine of some kind. A very powerful one.'

And there it is. Whatever the Bell was, it certainly represents something so secret that no one is talking about it to this day, though I am convinced that it did survive the war. In this light, it is perhaps significant that the UFO that allegedly crashed at Kecksburg, Pennsylvania in 1965, and that immediately caught the attention of the US military (which placed the town under virtual martial law until it was retrieved), is described as being bell-shaped and of approximately the same dimensions as "the Bell" described by SS general Sporrenberg.⁹⁰ But whatever the Bell was, its observed effects are quite in consonance with the effects of a scalar weapon.

⁹⁰ Cf. Michael Hesemann, *UFOs: the Secret History* (New York: Marlowe and Company, 1998), pp. 166-173, especially the drawing on p. 173. Kecksburg may thus be an unnoticed component of "the Legend." Some may object that the connection to the account of Sporrenberg's "Bell" is tenuous at best, since the Kecksburg object is alleged to have had some sort of "hieroglyphic" writing around the wide part of the rim. However, this too might indicate a connection, rather than a fact in contraindication of it, since the SS was known to be obsessed with the study of ancient runic writing and script.

The Giza Death Star Deployed

The signature of German interest in scalar weaponry can be found in an entirely different, and seemingly unrelated area, in a branch of materials science then unique to her alone: radar absorbent materials. This research in turn led to some interesting discoveries that highlight the connection between Nazi Germany, scalar weaponry, and the Soviet Union. Thomas Bearden puts it this way:

Ironically, Stalin's "great technological breakthrough" was to come from Germany's radar scientific team, taken to the Soviet Union after the war. This team had drastically advanced the theory of radar cross section and radar absorbing material (RAM). They were on the verge of discovering phase conjugate (time-reversed radar waves) which would enable the great new superweapons Stalin sought.⁹¹

Note what Bearden is saying here. Phased-array radar technology is an essential step in the development of scalar interferometric weaponry. In *The Giza Death Star I* pointed out the architectural similarity between a modern phased radar array and the Great Pyramid. I can now state the reason I why made that comparison: phased arrays are essential technologies to the development of phase conjugate mirrors able to reflect time-reversed "scalar" waves back to a target. It would not have taken the Soviet and German scientists long to put Tesla's and their own research together with Whittaker's and Barus' papers to formulate a working model for a unified and weaponizable scalar physics. In fact, unsubstantiated rumors persist that one reason the FBI confiscated Tesla's papers on his death in 1943 was that it knew of German military intelligence's interest in, and possible theft of, Tesla's high-energy impulse technology and papers.

Moreover, an important principle of the use of "non-linear materials" was discovered by the German scientists and developed by the Russians. Non-linear materials are essential to the development of the superluminal phase conjugate waves that are amplified by scalar weaponry and reflected back on their target in a greatly amplified pulse. Non-linear materials would, of course, include stone and materials found in the earth's crust.⁹²

The Soviet scientists with the aid of their German counterparts discovered these superluminal scalar waves shortly after the world war, in

⁹¹Bearden, "Historical Background of Scalar EM Weapons," *Analysis of Scalar Electromagnetic Technology*, p. 12, emphasis added.

⁹²Greer, op. cit., pp. 533-534.

essence, by continuing the line of wartime German research. Their western counterparts, thanks to the efforts of the "relativity police" and their denial of the possibility of superluminal waves and local engineering of space-time, did not publicly admit the existence of such waves until the early 1970s, though Tesla, Barus, and Whittaker had written of them decades earlier. Thirty years had already elapsed while the Soviets developed their new technology. The nature of the discovery occurred when several beams were interfered on a target of Radar Absorbent Material. The result was four-wave mixing and amplification of phase conjugate superluminal wave effects. And let it be noted, the Soviet-German team discovered this anomaly in microwaves.⁹³

In *The Giza Death Star* I pointed out Dunn's hypothesis that the King's Chamber's Coffin was constructed as the optical cavity for a maser. I also elaborated his hypothesis with one of my own: that the maser was an essential component for pumping a cohered superluminal "pilot" or scalar wave of enormous destructive potential to a target. I also mentioned the peculiar electro-gravitic properties of the B-2 Stealth Bomber, and alluded to a comparison of phased-radar arrays and the Great Pyramid. All these technologies are crucial components in the production of scalar weaponry of mass destruction.

Finally, it is to be noted that the Russians, beginning in the final days of the Soviet Union, and continuing until now, have built several large pyramids around Moscow and throughout the former Soviet Union, and have conducted serious scientific research on the strange source of their power. One physicist is a man with weighty academic credentials. This is Dr. Volodymyr Krasnoholovets, a Ukrainian theoretical physicist with ties to the former Soviet military through the Institute of Physics of the Ukrainian National Academy of Sciences in Kiev. Notably, Dr. Krasnoholovets has posited the existence of a hitherto unknown energy field that he calls the "inerton field."⁹⁴

⁹³ Bearden, *Gravitobiology*, pp. 26-27. The discovery was actually made by the Germans before the war's end, but they did not, until their capture by the Soviets, have the time to analyze the results of their experiments. What they had discovered was essentially a microwave version of Tesla's longitudinal electric impulses. Cf. Bearden, p. 76.

⁹⁴ Cf. Volodymyr Krasnoholovets, "Submicroscopic Deterministic Quantum Mechanic." More will be said of Dr. Krasnoholovets' research later in this book.

The Giza Death Star Deployed

D. A Brief Mention of a Weapon Function for the Great Pyramid

Finally, rounding out this survey of esoteric "high strangeness" in Pyramid research, mention must be made of a book entitled *Giza-Genesis: the Best Kept Secrets* by Howard Middleton-Jones and James Michael Wilkie. Claiming to predict the existence of secret chambers and passages within the building on the basis of some convoluted - one is tempted to say labyrinthine, Baroque, or even Byzantine - interpretations of the text of Genesis and other biblical books, this work nonetheless contains some eye-opening and quite provocative diagrams that suggest nothing less than a machine function for the whole compound.

One such diagram is a superposition of the ground plans of the Giza Temples one over the other. The result is clearly nothing less than the schematics for a machine, and self-evidently a very advanced machine (Figure One):⁹⁵

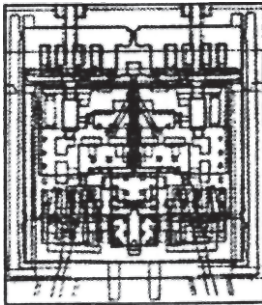

Figure One:
The Superposed Temple Groundplans:
A Schematic of a Machine

⁹⁵Howard Middleton-Jones and James Michael Wilkie, *Giza-Genesis, the Best Kept Secrets*, Vol. 1 (Tempe, Arizona: Dandelion Books, 2001), p. 71.

The authors point out the resemblance between this schematic and the alleged matter-antimatter annihilation reactor of Bob Lazar's flying disks. Whether or not that is the case, the schematic overlay in and of itself is suggestive that a very sophisticated technology once existed.

Yet another interesting confirmation of my hypothesis that those structures at Giza built subsequently to the Great Pyramid may have been laid out on a previously existing ground plan are the authors' intriguing rotations of the complex around a central axis, thus corroborating one of Dunn's and my ideas from a different vantage point: that the whole compound itself may have been designed as a machine to aid the Pyramid in achieving resonance (Dunn) and complex interferometer (me).

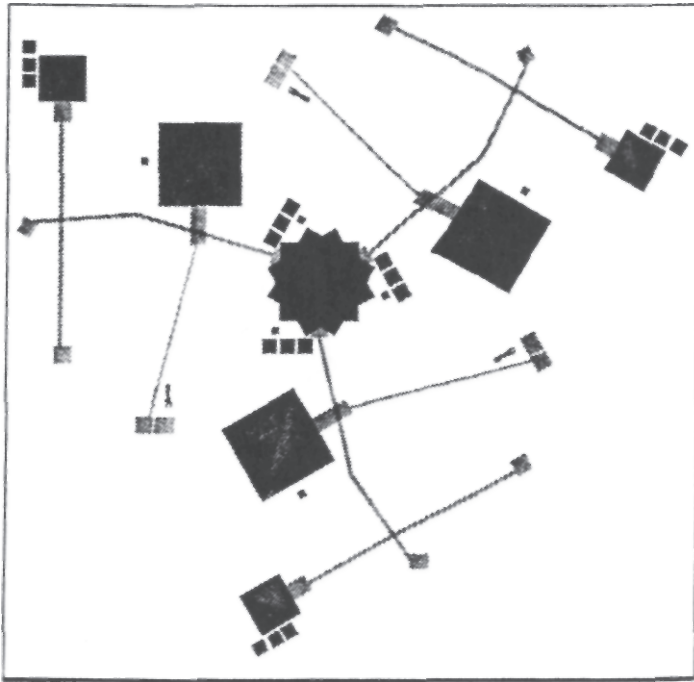

Figure Two: Middleton-Jones' and Wilkie's Overhead Rotation of the Giza Compound at 120 Degrees

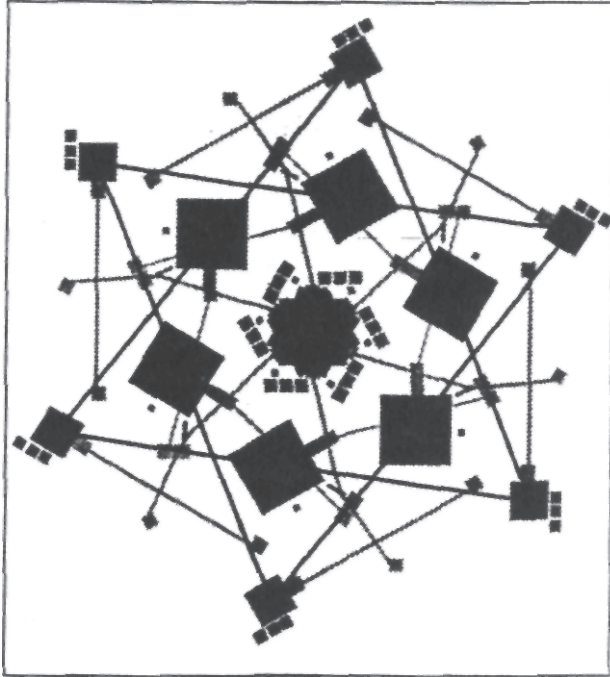

Figure Three: Rotations and Tetrahedral Analogs

In Part Three the significance of Figure Three will be explored in conjunction with "tetrahedral physics."

Essentially, the authors have a scenario wherein activation of the Great Pyramid was required in order to reestablish the harmony of the earth's grid and to protect it from a rather breathtaking warfare being conducted by aliens against our own sun!⁹⁶ Normally one would be inclined to dismiss all this with a derisive chuckle....yet the astonishing geometries and schematics of their book remain to disturb one's peace. And of course, the notion of an "energy grid" on the earth is not at all new.

However, other than this one brief allusion to some sort of defensive weapon function for the compound, there is no mention elsewhere in the literature on the Great Pyramid that it was a weapon at all, except in Sitchin's own texts, a suggestion neither he nor Dunn appear to have pursued.

E. Conclusions

Gathering all these things together, one may now conclude:

- Only Dunn, a few others, and I have any examination, in the increasingly burgeoning revisionist literature on the Great Pyramid, of any machine function;
- The Great Pyramid architecturally resembles a phased radar array, as was observed in my previous book, *The Giza Death Star*;
- Stealth technology and radar absorbent materials, as well as phased radar arrays, are essential components to the development of phase conjugate scalar weaponry, all of which research was initially undertaken by Nazi Germany and transferred subsequently to the Allied powers and Soviet Union after the war;
- Scalar weaponry thus requires the use of non-linear materials to configure its impulse, stone being precisely one such non-linear material;
- The quartz of granite may be irradiated and under proper conditions may result in masing action if a plasma is present; both quartz and plasma were present in the *Giza Death Star*;
- A pulsed and cohered output in the microwave range - in resonance to the earth, as Tesla also observed - is an essential component of scalar weaponry;

⁹⁶ Ibid., pp. 193-194.

The Giza Death Star Deployed

- Four to five nations likely have developed offensive strategic scalar weaponry capable of devastating large regions of the earth's surface in one fell blow: the United States, Russia, Japan, Germany, France, and the United Kingdom;
- The physics of scalar weaponry is essentially a unified physics;
- There appears to be a conspiracy of some sort to coordinate "revisionist opinion" regarding the Great Pyramid away from any consideration of the machine hypothesis, and away from any consideration of the structure as a weapon, though the interest of physicists - with known connections to military and intelligence communities, and with their own resumes of esoteric pursuits - in Giza is a known quantity;
- Finally, since the time of Newton, there has been a persistent secret society, intelligence, and military interest in the structure, and seemingly, an effort to divert attention away from explorations of any version of the machine hypothesis, weapon or otherwise. Of course, this does not automatically signal a weapon function for the structure. Military interest could just as easily be explained on the basis of a possible communications function. However, such interest certainly does not preclude a weapon function, and if such a function could be established on other foundations, then such interest would constitute corroborative evidence.

With all this said, has the case for a weapon function really been made?

No, it has not. The evidence presented here in parts one and two is at best corroborative evidence, but it is not yet fundamental or direct evidence. But can a more convincing scientific case be made for a weapon function of the structure, beyond the testimony of the ancient texts cited by Sitchin? If so, then can it be reasonably argued that the function of that weapon was offensive in nature, as a weapon of strategic mass destruction?

I believe it can.

A careful, point for point comparison of the Great Pyramid with aspects of contemporary theory regarding the cohering of the zero point energy flux and with Tesla's Direct Current Impulse Magnifying Transformers and the requirements of his system of wireless power transmission will reveal that the Pyramid may have been a very sophisticated - indeed, a very over-engineered - version of Tesla's

transformer. The over-engineering itself suggests that a satisfying argument can be made that it could have been nothing else than a weapon. We will now consider more direct arguments and evidences for a weapon function and then proceed to an analysis of the putative functions of the various structural components of the Great Pyramid in fulfilling that function.

The Giza Death Star Deployed

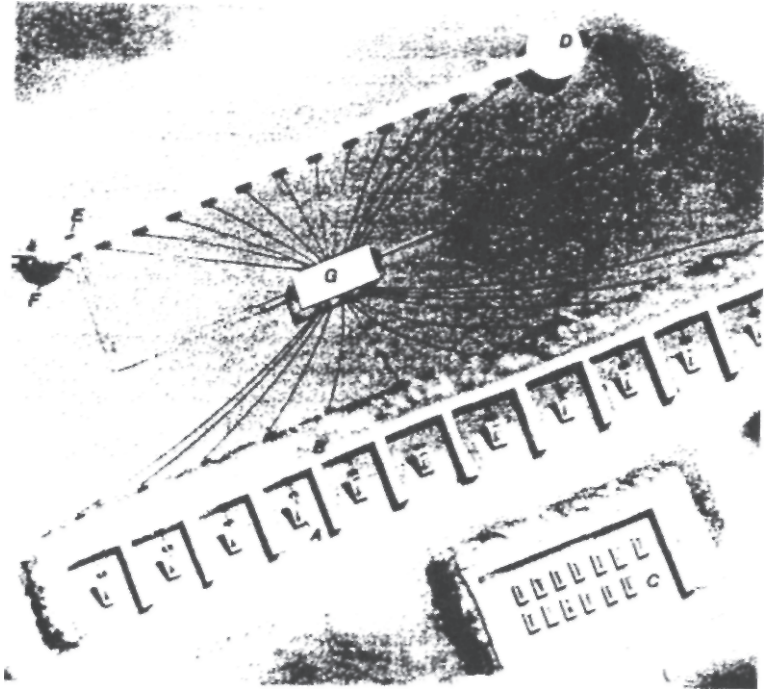

A Suspected Soviet "Tesla" Weapon Installation at Semipalatinsk, U.S. Satellite Photo Published in Aviation Week and Space Technology, July 28, 1980.

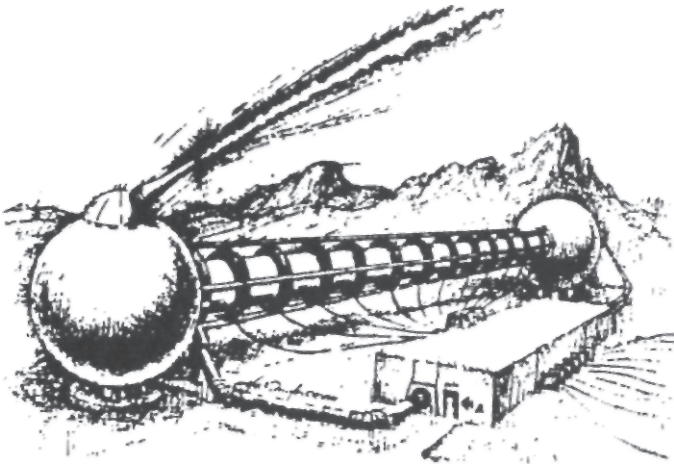

Artist Hal Crawford's Drawing of the Soviet Installation at Semipalatinsk

THE GIZA DEATH STAR DEPLOYED:
PART THREE:
TESLA, SCALAR, TETRAHEDRAL AND HARMONIC
ANALYSES OF THE PHYSICS AND ENGINEERING OF THE
GREAT PYRAMID

MESSAGE? OR MACHINE? A PRECIS OF THE WEAPON HYPOTHESIS

"I have devoted much of my time during the year past to the perfecting of a new small and compact apparatus by which energy in considerable amounts can now be flashed through interstellar space to any distance without the slightest dispersion. "

Nikola Tesla, New York Times, Sunday, 11 July, 1937.

A. Five Hypotheses, Two Models, and a Method

Throughout this and my previous work, *The Giza Death Star* I have referred to several of the most prevalent alternative hypotheses of the origins and functions of the Great Pyramid. For convenience, one may narrow these down to five basic hypotheses:

1. The Time Capsule Hypothesis;
2. The Prophecy-in-Stone Hypothesis, or as Bauvall puts it, a "hermetic device";
3. The Observatory Hypothesis;
4. The Machine, or Power Plant Hypothesis;
5. The Weapon Hypothesis.

As alternative explanations of the possible function of the Pyramid, each of these has its unique strengths and weaknesses. And they all share one common strength: none of them adhere to the ridiculous notion that the three giant pyramids of Giza, and in particular, the over-engineered complexity and work of genius that is the Great Pyramid, are tombs for dead Egyptian kings.

A closer look at the five basic explanations will disclose that Hypothesis 2 is but a variant of 1, and 5 but a variant of 4. Those two groups, 1 and 2, and 4 and 5, view the Great Pyramid by one or another of two models: it is a Message, or it is a Machine. Sandwiched somewhere in between these two groups is Hypothesis 3, the Observatory Hypothesis, for the Time Capsule Hypothesis, Hypothesis 1, depends in some degree on the fact that at the very least the Pyramid was a simple machine: an astronomical and terrestrial observatory, a kind of very bulky sundial.

1. Weaknesses of the Message Model

In its most notorious form, the "Prophecy-in-Stone" Hypothesis, the Pyramid is viewed as a message - whether unintentional or intentional - from God, or the gods, or even our more enlightened and sophisticated ancestors, to us. And in most versions, the "message" is understood to be a benign one. We may rather quickly dispense with this view on the basis that those who so view it expose themselves to two serious weaknesses:

1. Those who view it as a kind of "Bible Prophecy-in-stone" can do so only by theological interpretation of the biblical text itself, and then comparing that to certain measures of the Pyramid and various historical events. Usually these interpretations run along classic fundamentalist "dispensationalist" lines, complete with the "two-stage" return of Christ, with raptures, tribulations, millennium and various "previous dispensations". Since each of these views are recent innovations, and not part of the original or early Christian patristic understanding of the biblical texts, such views are questionable on theological and historical grounds alone. Thus, even if such correspondences do exist, and even if this model is "successful" at making predictions of future events, those events can only be successfully "predicted" a posteriori, that is, they will still have to be "interpreted" as having been predicted. Such correspondences therefore cannot mean what such interpretations maintain they mean since such "Bible Maps of the Ages" were unknown in the Patristic period and found no entrance into Christianity until Joachim of Fiore in the Middle Ages.

2. Those who view it as a type of "New Age Prophecy-in-Stone" are subject to a similar criticism, and even more so, since the selection of various esoteric and mythological traditions is itself an act of constructing the interpretation.

One may therefore dispense with the Prophecy-in-Stone Hypothesis since it depends on supplemental texts or some other supplemental knowledge to convey the message apart from the monument itself. This would introduce "transmission errors" into the message and hence would be self-defeating. Moreover, there is nothing to indicate which

The Giza Death Star Deployed

corroborative text or religious tradition (by which the Great Pyramid-as-prophecy is to be interpreted) is to be selected. The monument thus becomes a superfluous, unneeded entity, a six million-ton violation of Ockham's Razor!

A much more sophisticated version of the Message Model is the Time Capsule Hypothesis. On this view, the Pyramid literally becomes, at the minimum, a stone "bureau of standards and measures," and at the maximum, a mathematical message left for us to decipher when we had once again attained a similar plateau of scientific achievement. One may appreciate the sophistication of this view by comparing it to proposals advanced for contacting and communicating with an extraterrestrial intelligent life form, or conversely, how "they" might attempt to contact and communicate with us.

Obviously, we cannot send a message in English, Arabic, or Japanese, for while such a message may be understood as intelligent communication by "them," unless it were an extremely long message, there would be no guarantee that it had been deciphered and understood correctly. The same would be true in reverse. If "they" were communicating to us in ET-German or ET-Swahili, the message would have to be long enough to permit some degree of decryption. And again, there would be no guarantee that the message was correctly translated and understood. Without a corresponding "key-text", we would be virtually lost. We would, in fact, find ourselves back to the problem inherent in the Prophecy-in-Stone Hypothesis: the Monument (in this case, the message itself) would require a text (in this case, the key code) to decipher.

The way around this conundrum is that any such "message" would have to occur in the most universal language possible: mathematics and geometry. This is essentially the argument of the two foremost schools of the Message Model of ancient monuments: Richard Hoagland and his Mars researchers on the one hand, and Graham Hancock, Robert Bauvall and the "ancient catastrophists" on the other.

In the Hoagland-Mars version, the "message" is basically that the mathematics and geometries of Cydonia (and by extension, Giza and other such sites on earth) encode a hyper-dimensional "tetrahedral" physics, a physics that in turn is the key to unleash enormous amounts of energy, if we but knew how to engineer it.¹ While this message is essentially benign,

¹In fairness to Hoagland, the zeal and passion with which he expounds the essentially benign nature of this message is perhaps due to the fact that he cannot but help

Message? Or Machine: A Precis of the Weapon Hypothesis

more recently Hoagland's Mars version of the model has taken on elements of the planetary catastrophism of Van Flandern and the Bauvall-Hancock version of Giza.

In the latter version, the planetary catastrophe comes in regular, measurable, predictable "cycles" based on astronomical data. On this view, the Giza compound was built as a permanent monument and message by a dying civilization to warn us of a similar fate so that, with the proper enlightenment, preparation and "spiritual insight" we might avoid or at least mitigate it.

The Hoagland-Mars and the Bauvall-Hancock versions of the message model have common features. Both argue for the existence of a paleoancient (and in Hoagland's version, spacefaring) Very High Civilization. Both argue for a major planetary catastrophe on earth, or Mars, or elsewhere, and in some versions, all three. But for all their resemblances, it is actually Hoagland's version that is the stronger of the two, for the following reasons.

In the Bauvall-Hancock version, the problem of textual construction again intrudes, albeit very subtly, in the form of comparisons between Central American monuments, belief systems (the extra-monumental "text" again), and Giza. In Hoagland's version, there really is no extra-monumental text that is subject to construction by which the monuments are interpreted.

But again and again, in his writing and public appearances, Hoagland refers to the "message" of Cydonia as an attempt to preserve and communicate his tetrahedral "hyperdimensional" physics. Either Hoagland is being merely rhetorical, and no message was intended for us, or Hoagland - if he means his rhetoric - has made an assumption that exceeds the evidence.

In short, the basic problem with the Message Model is simply this: the presence of redundant mathematical and geometric relationships may be an indicator of intelligent design, but it is not thereby simultaneously an indication of attempted communication. Any hypothetical reconstruction of the motivations of the builders can only come as a corollary of an

be aware of the fact that the physics he proposes could equally be the source of a great superweapon. Perhaps, then, his zeal and passion are designed to publicize as widely as possible the implications of "tetrahedral physics" before the subject is quietly and deliberately shuffled to the sidelines, only to disappear and become the subject of more sinister research.

The Giza Death Star Deployed

analysis of the possible functions of the structures, and any functional analysis must introduce external factors that exist outside of the formal mathematical theorems embodied in the structure. In short, the Message Hypothesis is rather weak, since it violates, or rather, ignores the implications of Godel's incompleteness theorem. To maintain that the Cydonia or Giza structures were intended as communication is an a posteriori argument and therefore a weak argument.² Godel's theorem in fact exposes a serious weakness in any argument that universal mathematical symbols can function as a message to or from extraterrestrials beyond the mere communication of "here we are and we are intelligent because we know this." Any formal system remains incomplete, and points to information outside that system, and hence, the Pyramid, if it is such a "statement" or "message in geometry" must perforce be an incomplete one. It invites interpretation or "completion" by propositions lying outside the system itself.

This brings us to the last three hypotheses: 3 Observatory, 4 Power Plant, and 5 Weapon.

2. The Machine Hypotheses

As mentioned above, in all five hypotheses the Pyramid does function as a simple machine, as an observatory of astronomical and terrestrial data.

(a) The Weakness of the Observatory Hypothesis

But when considered on its own - i.e., as if it were intended to be nothing more than an Observatory - a serious weakness exposes itself. Why engineer so many other physical and astronomical analogs into the structure? Why build into the structure analogs of the atomic weights of certain elements?³ Why make the inside of the Observatory inaccessible?

Thus the Observatory hypothesis - while advanced by some of the most sophisticated minds, and seemingly the most rational and easiest of all the alternative hypotheses to swallow - is actually the least rational of them all, for it simply ignores the over-engineered complexity of the

²Notice I said a weak argument, not an invalid one. Any hypothesis concerning an artifact is perforce to some degree a posteriori.

³ Cf. the next chapter.

structure.⁴ This brings us to what are, to my mind, the most serious contenders, Dunn's Power Plant Hypothesis, and my own weapon hypothesis.

(b) The Weakness of the Power Plant Hypothesis

Briefly, the weaknesses of Dunn's Power Plant Hypothesis are four:

1. It ignores relevant textual data that indicate a possible function of the machine;
2. It ignores relevant textual data that indicate what the missing components might have been; and,
3. It tends to ignore the possible functional purposes of the various mathematical dimensions of the structure and stellar and galactic correspondences of those dimensions.
4. Finally, in seeking to explain the functional purpose of the structure's various components - the chambers, shafts, coffer and so on - Dunn does not state how the acoustic, microwave, and peizo-electric components were integrated, nor does he offer an explanation of how embedded quartz crystals in granite could build a charge of more than a few milliamps, far too low, it would seem, to have functioned as a power plant. However, it is to be noted that, suggestively, he mentions Tesla in connection with his theory, implying that he is not thinking of its electrical power output in any conventional sense.

This being said, these also constitute in my mind the great strength of his work, in that he seeks to explain the structure in terms of known engineering principles, and not on extrapolated speculative principles of what I call "paleophysics" or other external factors.

⁴ As Gantenbrink also pointed out, the "air shafts" could not possibly have been intended to "observe" the stars since the bends in the shafts made it impossible to view them. He goes too far, however, when he dismisses the stellar alignments of these shafts on that basis.

The Giza Death Star Deployed

(c) The Weapon Hypothesis

The Weapon Hypothesis, conversely, does seek to take into account the direct textual and corroborative textual and archaeological data. Because of this, the Weapon Hypothesis is subject to the same type of criticism as advanced against the hypotheses of the Message Model. However, in the Weapon Hypothesis, the reliance upon external text is severely limited for the following reasons:

1. The direct textual evidence indicative of a weapon function is used as a point of departure to formulate the hypothesis to be investigated, and nothing more. That is, Sitchin's "text" does not control the details of the investigation of the various parts of the structure, as it does in the Bauvall-Hancock version of the Message Model. Once the hypothesis is formally announced, science takes over as a basis on which to speculate on the type of physics and to posit the hypothesized functional purpose of the components of the structure. The hypothesis does not therefore stand or fall on the translation or interpretation of the text itself. Text is a corroborative, not primary, datum on this view.
2. Corroborative texts are thus utilized only insofar as they are tools to verify or deny the possible existence of a sophisticated "paleophysics", a physics sophisticated enough to be weaponized in the manner suggested by the primary component of the investigation, the Pyramid itself.

(d) A Method

This being stated, however, there is a substantial methodological weakness to the Weapon Hypothesis:

1. The Weapon Hypothesis tends to the view that every dimensional measure or structural component was functionally significant, seeking explanations of these putative functions in contemporary research and theory, and when these fail, a speculative reconstruction is attempted. Such may not have been the case, and Dunn's hypothesis avoids this weakness.

2. This is mitigated by the fact, however, that the Weapon Hypothesis is an open-ended hypothesis, i.e., it acknowledges that not every structural feature may ultimately prove to be functionally significant.

The great merit of both hypotheses of the Machine Model is their open-endedness. That is, both hypotheses may ultimately be disproven, but in the process, they both have laid a solid prima facie case that the Great Pyramid is a machine. If the hypotheses are counter-indicated, it only remains to discover what kind of machine it actually was.

The great strength of Dunn's Power Plant Hypothesis is its reliance solely on an analysis and interpretation of its engineering, apart from external corroborating textual data, whether direct or indirect. By the same token, that is simultaneously its weakness, since it methodologically imposes the condition that a class of evidence claiming relevance to the question at hand, namely texts, is ignored.

The great strength of the Weapon Hypothesis is the fact that it seeks textual corroboration, and therein lies also its weakness, for to do so it must re-interpret those texts, claiming a decayed pedigree from a purely scientific archetype, with all the correspondent historical reconstruction that this entails.

B. Outline of Part Three

With these thoughts in mind, the previous two parts of this work have advanced various corroborating scenarios and indirect evidences for the hypothesis that the Great Pyramid was a weapon of mass destruction. In this part, the direct evidence for that hypothesis is considered by way of a detailed examination of each component of that hypothesis.

Part three of this work is therefore divided into the following chapters:

- Chapter 5, this chapter, outlines the "Models of Weaponization" and summarizes the rest of part three.
- Chapter 6, "A Tesla Analysis" briefly surveys the basic requirements of Tesla's system of wireless power transmission and presents the main argument for why the Great Pyramid was likely intended to be nothing else than a weapon of mass destruction, if its function was based on a system similar to Tesla's.

The Giza Death Star Deployed

- Chapter 7, "Cohering the Zero Point Energy Flux: A Synopsis of Scalar Physics," outlines a theoretical model of scalar electromagnetics and compares it to paleophysical principles discovered in The Giza Death Star. One important principle that emerges is that physical reality is infinitely extended at the microscopic and macroscopic scales in the form of a harmonic series, and that the engineering of the Giza Death Star implies that some sort of "equal tempering," analogous to that in music, is necessary to the unification of physics.
- Chapter 8, "Configuring the Scalar Impulse Wave" details the role and function of the components of the Giza Death Star itself based on the direct and indirect evidences presented in all three parts of this work.
- Chapter 9, "Quantum Numerology, Feedback Loops, and Tetrahedral Physics" explores further "harmonic" analysis of the dimensional measures of the Great Pyramid in terms of the coefficients of the Planck units, and outlines the foundations of "tetrahedral" physics and explores its possible significance.
- Chapter 10, "Conclusions and Implications: The Direct and Corroborative Evidence and Some Scenarios" gathers the evidence presented in The Giza Death Star and The Giza Death Star Deployed.

C. Assumptions

The weapon hypothesis of the function of the Great Pyramid rests on the following assumptions:

1. That Nikola Tesla's impulse magnifying transformer technology, and the phenomena it accessed, were the first observed effects of scalar wave stressing of the vacuum potential, or of cohering the "zero point energy flux" of spacetime;
2. That this technology was the first applied example of a type of physics now known as "scalar electromagnetics" or "electrogravity";
3. That the theoretical foundations of this physics in turn closely parallels the physics exhibited in certain ancient esoteric and occult texts, among them the Hermetica of Hermes Trismegistus

Message? Or Machine: A Precis of the Weapon Hypothesis

examined in my previous books, *The Giza Death Star*, and Chinese traditions of a superweapon called a "yin-yang mirror";

4. That on the basis of a comparison of the known requirements for Telsa's system of the wireless transmission of power for peaceful purposes with the Great Pyramid itself, the latter exhibits certain design features strongly suggesting it was engineered for no other purpose than that of offensive strategic weaponry of mass destruction, and that it was not designed merely as a peaceful "power plant" for the wireless transmission of power;
5. That the observed and/or predicted physical effects of this technology and the underlying theoretical model would result in gravitational anomalies, a prediction corroborated by various ancient texts and traditions; and that the use of recursive "time-reversed" phase conjugate waves closely parallel myths of "yin-yang" mirrors and other persistent dualistic physical models in ancient cosmological schemes.

The weapon hypothesis must therefore also give a detailed comparison and explanation of each of the following components of the Great Pyramid and their putative functions based on the Tesla-scalar physics model.

D. Models of Weaponization

To the reader careful enough to have noticed, here and in my previous book, *The Giza Death Star*, various models of a sophisticated directed energy weapon of mass destruction have been discussed:

1. Plasma canon;
2. Fusion torches;
3. Solar mirrors;
4. Weather modification;
5. Behavior modification;
6. Electrical vibration of the earth, inducing earthquakes;
7. "Yin-Yang" mirrors relying on recursive scalar waves: phase conjugation directing a superluminal wave form that coheres the vacuum flux, modulated by gravitational, acoustic, and cohered electromagnetic energy in the microwave range and hyper-accelerating them to target, inducing nuclear chain reactions

The Giza Death Star Deployed

directly in the nuclei of atoms in the selected target region, a region which may be of any scale. Targeting of this type of weaponry is via harmonic interferometry.

E. The Hypothesized Functions of the Great Pyramid's Component Materials, Geometric and Harmonic Features and Dimensions, Chambers, and Feedback Loops

Assuming each component of the structure to be essential to its proper and efficient functioning, the weapon hypothesis will have give explanations for four basic elements of the structure: (1) the selection of particular materials in its construction, including the speculated missing components treated in The Giza Death Star; (2) its geometric and harmonic features, such as parabolic faces, squared circle and cubed sphere geometries, and so on; (3) its internal chambers; and (4) its feedback loops.

In order to prepare the reader, each hypothesized function of the components of the structure explored in the remaining chapters are summarized here. In the main text of the chapters themselves, footnotes of references will continue to be given on the same page as before. Where it is necessary to advance a tentative and crude mathematical model of the arguments, or where the mathematical modeling of other authors is quoted, every effort is made in the main text to explain the technical nature of these hypotheses for a general readership.

(1) The Selection of Materials Used in its Construction

- The Role of Hydrogen Plasma in the Great Pyramid was to accomplish one or more of the following:
 - Experiments demonstrate that in bucking electromagnetic fields and caduceus coils hydrogen is a necessary technology to access quantum vacuum or ZPE fluctuations and to engineer the local space-time structure of the medium, or aether;
 - It is an analog of nuclear processes in order for the Pyramid to have functioned as a coupled oscillator to those processes in Any Possible Receiver (i.e., target).
- The Role of Materials Selected in Construction:
 - Granite was selected for:

Message? Or Machine: A Precip of the Weapon Hypothesis

- Its known piezoelectric properties in order to build up an enormous electrostatic potential to be accessed and released as a direct current impulse against a resistance barrier of nonlinear material to create a coherent and pulsed scalar wave.
- In this regard experiments with caduceus coils wound around quartz crystal and utilizing bucking electromagnetic fields to produce gravitational anomalies may be relevant, since the ancient texts speak of gravitational anomalies in the proximity of the Pyramid when it was fully functional.
- The lattice structure of granite (i.e. of its quartz) may therefore have served the function of a wave-guide for the impulse.
- Limestone (Calcium Carbonate) was selected for the bulk of the structure and for its Casing Stones because:
 - Non-linear materials are essential in the four-wave mixing necessary to the engineering of scalar impulse waves.
 - The overall crystalline structure of the Pyramid itself may also have functioned as a wave-guide for the impulse.

(2) Its Geometric and Harmonic Features such as parabolic faces, squared circle and cubed sphere geometries, and so on

- The overall functions of the whole structure of the Great Pyramid are as follows:
 - It functions as a phase conjugate mirror, an analog or coupled harmonic oscillator, of the earth and other local inertial systems, since the latter are not isotropic systems and therefore do not lend themselves to that function, whereas the materials selected in its construction and their deliberate placement in the structure indicate that its function is enhanced by its overall isotropism, i.e., the more or less uniform distribution of material throughout its essentially symmetric design. The "squared circle" and "cubed sphere" properties of the structure make it a crystalline analog of the earth and of Any Possible Receiver (i.e., target) on the earth or nearby space.
- Its parabolic faces function to collect and focus the background radiation, the geometries and inertial forces of local space systems - the information in the field - of the base galactic and solar systems into the structure and thereby to oscillate and modulate its impulse to Any

The Giza Death Star Deployed

Possible Receiver under the influence those systems. This design feature confirms its function as an "analog computer" and "coupled oscillator" of Any Possible Receiver.

- The apothems of the faces function as the virtual leads to the impulsing transformer component of the structure.
- The missing crystals in the interior of the structure, the Grand Gallery - a PHI-corundum (i.e., sapphire) crystal - and of the apex, function as the electro-gravitational dielectric antenna of the structure.
- The overall geometry of the Pyramid is itself that of a large crystal lattice, possibly a coil, and a waveguide for the impulse.

(3) The Functions of Its Internal Chambers

- The Role of Construction Features:
 - The Stone Courses - in their heights and thicknesses - function as analogs and therefore as coupled harmonic oscillators of the atomic weights of the elements as they might occur in Any Possible Receiver.
 - The Stone Courses also function as the windings of the secondary in the system of (Tesla) direct impulse magnifying transformers, with the non-linear nature of the limestone itself contributing to the over-all phase conjugation function of the structure. Viewed both as a crystal and a coil, the Pyramid's stone courses thus function as a wave-guide for the impulse, with the thicknesses of each course perhaps being analogs of the atomic weights of certain elements.
 - The Queen's Chamber functioned, as Dunn indicates, to generate the hydrogen gas. I further hypothesize that this gas was electrically "pinched" into the ion-acoustic resonant mode of plasma in other chambers of the structure.
 - The Grand-Gallery functioned for gravito-acoustic infrasound generation and amplification and to oscillate and pinch the hydrogen gas into the ion-acoustic mode of plasma.
 - The Antechamber functioned as a sonic baffle to "damp" frequencies not resonant to A Given Receiver (i. e. specific target) allowing only resonant harmonics of the target's "fundamental" electro-gravitational signal to enter the King's Chamber for phase conjugation, cohering, amplification and pulsing.
 - The King's Chamber combined several functions:

Message? Or Machine: A Precis of the Weapon Hypothesis

- As the Tertiary Coil to the magnifying and impulsing transformer;
- To pinch the plasma further;
- To stress the piezoelectric properties of its granite in resonance to the harmonics entering from the Grand Gallery via the Antechamber
- To amplify the gravito-acoustic signal entering from the Grand Gallery;
- To cohere and modulate the electromagnetic and scalar impulse in the optical cavity of the Coffin by four-wave mixing.
- The Nested Feedback Loop Structure of the Queen's Chamber, Grand Gallery, Antechamber, King's Chamber
 - Embodies the Sumerian Ratio 6:8::9:12 in Harmonics of the Planck Units, indicating a structured potential of the quantum vacuum was being engineered, and by careful coupled harmonic oscillation, was being directed toward the King's Chamber and amplified in the process.
 - The presence of the Sumerian ratio indicates that the physics is scale invariant, and that a "well-tempering" of the entire infinitely-extended harmonic series was being deliberately utilized, employing any "harmonic signature" of a target as the fundamental, and damping any non-resonant frequencies that would lead to the equivalent of a "Pythagorean Comma" in the electrogravitational scalar impulse being configured by the structure, since the lack of such tempering and damping would only dissipate the scalar wave into "noise."
- The "uneven" or "unfinished" look to the stone work of the Subterranean Chamber and the large granite blocks of the King's Chamber was in fact intentional, being the result of "tuning" the structure to the proper resonances.

6.

A TESLA ANALYSIS: THE BASIC ARGUMENT FOR THE WEAPON HYPOTHESIS

"Note that, in 1912, Nikola Tesla stated in an interview that it would be possible to split the planet, by combining vibrations with the correct resonance of the earth itself. Tesla stated 'Within a few weeks, I could set the earth's crust into such a state of vibrations that it would rise and fall hundreds of feet ...and practically destroying civilization.'"

Lt. Col. T.E. Bearden (Ret.), "Historical Background of Scalar EM Weapons"

A. Eric Dollard's Experiments: The Basics of Tesla's High Energy Direct Current Impulse Magnifying Transformers and the Wireless Transmission of Power

Engineer Eric Dollard has reproduced Tesla's original experiments in longitudinal electric wave generation by sudden direct current impulses in a remarkable series of videotapes. Tesla's experiments may be reproduced using very easily obtained standard electrical equipment. To understand the basics of his experiment, one must have an understanding of what standard electromagnetic theory says about the relationship of the electric and magnetic fields.

In order to understand his experiments, it is necessary to begin with the basics.

According to standard electromagnetic theory, the transverse electromagnetic sine wave is in opposition to the longitudinal dielectric impulse, that is, they cannot exist in any relationship other than perpendicularity, and therefore cannot be parallel:

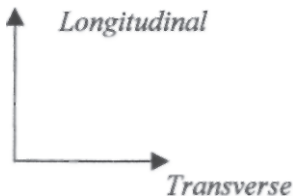

A Tesla Analysis: The Basic Argument for a Weapon Function

This is just a fancy way of saying what everyone learned in junior high school shop when they learned the "right hand rule": the magnetic and electric fields exist perpendicularly to each other.¹

At this juncture, it is necessary to understand the difference between an analog and a digital computer, and how Dollard's and Tesla's circuits function in the former capacity. In his video demonstration of the existence of longitudinal dielectric superluminal impulses, "Transverse and Longitudinal Electric Waves,"² Dollard summarizes the difference between the two types of computer. A digital computer, the type with which we are all familiar, has a numerical functioning only, and thus, no direct measurement of a physical function is possible. Such a function can only be mathematically modeled. As a consequence, particularly in the case of digital computers, based as they are on standard electromagnetic theory, the mathematical form of the computer itself is dissimilar to that of the very wave under study. A digital computer cannot therefore be directly connected to the system under study without means of an elaborate, and distorting, interface.³

An analog computer, on the other hand, has both a numerical and a physical functioning. In the plainest terms, Dollard's circuits are the computer, whereas the wave itself is the system under study. Thus, the circuit permits direct measurements to be made of the phenomenon at any point. As such, the physical and mathematical form of the circuit is identical to the system under study.

With this in mind, a standard electrical circuit of coils and capacitors is constructed where the coils are in parallel, and the capacitors in series, producing the standard electromagnetic, textbook orthogonality (perpendicularity) of dielectric and magnetic fields. Dollard's electrical schematic analog is as follows:



¹ That so few people now in modern America know this basic fundamental physical law is a sad commentary on the state of education in general, and scientific education in particular.

² Available from Borderland Sciences.

³ These observations occur at 16 minutes 45 seconds into the tape.

The Giza Death Star Deployed

The capacitors thus produce the dielectric impulse at 90° to the electromagnetic current of the coils, which may be seen by placing simple standard meters at either end of the system. Near the power source, the circuit is cool, and near the load end, hot. Calculation of the electric wave's velocity based on the standard frequency computation method yields a velocity approximately 80% of the velocity of light.

However, one may construct a circuit where the transverse electromagnetic sine wave and the dielectric longitudinal scalar impulse are not in quadrature opposition, but where the plane of each wave advances along an axis denoted by a common vector. In this case, Dollard's electrical schematic analog is as follows, with the capacitors in parallel and the coils in series:

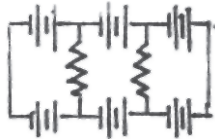

Testing the system with the very same meters yields an impulse at the load end, by the same method of calculation, as Dollard quips, in excess of the velocity of light "relativity police" notwithstanding. Dollard then makes an interesting series of observations, in part relying on texts published by Tesla's associate, Charles Steinmetz, and others before the "relativity police" captured the field. In the normal, alternating current "sine wave" form of magnetic and dielectric field opposition, both forms of energy are out of phase and opposed in space. This, notes Dollard, is "an unnatural form" of electricity. In the second analog computer, however, readings for the magnetic and dielectric field components indicate that the two are not in opposition but in spatial conjunction, a very "natural" form of electricity. Dollard also notes, before the rise of current standard theory, that what is now erroneously known as "dielectric field" was formerly known simply as "electricity"!⁴

⁴ Dollard, op. cit, 33:40.

A Tesla Analysis: The Basic Argument for a Weapon Function

It is critical to the weapon hypothesis to note that in systems designed for wireless dielectric impulse power transmission that the schematic above is duplicated in the receiver in a 1:1 harmonic, but with the primary and secondary coils of the receiver wound in the opposite direction to the transmitter. This fact constitutes the single most important basis for the argument that the Great Pyramid was a weapon of mass destruction, as we shall see in a moment.

It is also important in connection to the weapon hypothesis to note that Tesla and Dollard observe that the power at the load (receiver) is increased if the spark gap at the transmitter contains a plasma to lower impedance. This in turn tends to confirm the analysis of the Great Pyramid as a sophisticated analog of the Tesla oscillating impulse magnifying transformer, since on Dunn's analysis it contained such a plasma in the form of hydrogen.⁵

The 1:1 transmitter-receiver ratio is a strong indication as to why the Great Pyramid was a weaponized application of the dielectric impulse phenomenon, rather than merely for the production and wireless transmission of power for peaceful uses. A known receiver would give a set of certain specific mathematical properties based on similar properties to be found in the transmitter, existing in a 1:1 ratio or some harmonic, as indicated by Dollard and Tesla. Accordingly, a receiver and transmitter in such a system would have been relatively simple things to engineer.

Since analysis of Tesla impulse technology seems to corroborate and correlate with so many features of the Great Pyramid, one must therefore find a suitable answer or hypothesis, based upon the same paradigm and heuristic technique, as to why the Great Pyramid is such an over-engineered transmitter if it were to belong to such a system.

For the moment I will set aside a detailed comparison - which will follow in chapter 8 - and for the sake of argument, I will view the Great Pyramid as such an impulse magnifying transmitter that simultaneously functions as an analog computer and harmonic oscillator. Thus viewed, it is a set of all possible subsets of oscillatable elements - both chemical and geometric - where no known receiver exists in a 1:1 ratio at the other end

⁵I argue elsewhere that this hydrogen existed in plasma state by dint of the electrical pinching of the gas found present in the Queen's Chamber, Grand Gallery, Antechamber, and King's Chamber much like the neon plasma in a neon light is pinched from the walls of the tube by the passage of electrical current through it, thus solving the "hot containment problem" associated with thermonuclear fusion in a manner similar to Dr. Philo Farnsworth's "plasmator" patents.

The Giza Death Star Deployed

of the system. This means that it was built to oscillate Any Possible Receiver (target) configuration on the load end of the system. As will be seen in the next chapter and chapter 9, this also implies that it must interact with the geometric properties of local space, and with the fundamental physical constants themselves. Putting this argument as plainly as possible, the Great Pyramid was deliberately engineered to do without the presence of a receiver or appliance at the "load" end of the system, and thus is designed to impulse, oscillate, and load targets, since the chemical and geometric configuration of Any Possible Receiver in local space will vary on a case to case basis. That variance, and the ability of the Pyramid to oscillate any known variance, is the reason for its over-engineering. And the over-engineering in turn constitutes strong direct evidence that its purpose was not for the peaceful wireless transmission of enormous amounts of power over great distances.

B. The Analogs of the Atomic Weights of the Elements in the Great Pyramid

If this analysis is true, one should in turn expect some analog of the atomic weights and/or other atomic properties of the known and unknown elements to be present in the Great Pyramid. The Great Pyramid must be able to configure the analog combinations of these elements in some harmonic other than a 1:1 ratio of their combinations in Any Possible Receiver.

In his Study in Pyramidology, E. Raymond Capt presents the following thesis of a correspondence between certain stone courses of the Great Pyramid and the atomic weights of some elements in the periodic table: "It appears the elements and their atomic weights are revealed in the mathematic (sic.) statistics of the masonry courses of the Great Pyramid."⁶ Two methods of detecting this correspondence are elaborated by Capt:

- Method One:

"It is known that the various elements are grouped according to their characteristics, or their properties. According to one scientific theory, the element Neon (Ne) No. 10 is the nucleus of all succeeding elements and the true starting point of the atomic development. By a mathematical process based

⁶ Capt, op. cit., p. 251.

A Tesla Analysis: The Basic Argument for a Weapon Function

upon the altitude of Course No. 10 of the P's masonry, we find the atomic weight of Uranium (U) No 92 corresponds to the 92nd course of masonry above course No. 10.

The atomic weight is arrived at by taking the said altitude in P inches and moving the decimal point one place to the left, thus dividing by 10. P Course No. 92 s 238y P inches above Course No. 10, thus yielding 238.7 as the atomic weight of Uranium No. 92.... By the same method of computing, other elements in the same group show the following relationships."⁷

Capt then reproduces the following table and diagram:

ELEMENT	ATOMIC No.	ATOMIC WEIGHT	COURSE No. PYRAMID	HEIGHT ABOVE COURSE No. 10	ONE TENTH HEIGHT
URANIUM (U)	92	238.07	92	2387 P"	238.7 P"
THORIUM (Th)	90	232.32	90	2320 P"	232.0 P"
RADIUM (Ra)	88	226.05	88	2259 P"	225.9 P"
RADON (Rn)	86	222.00	86	2214 P"	221.4 P"

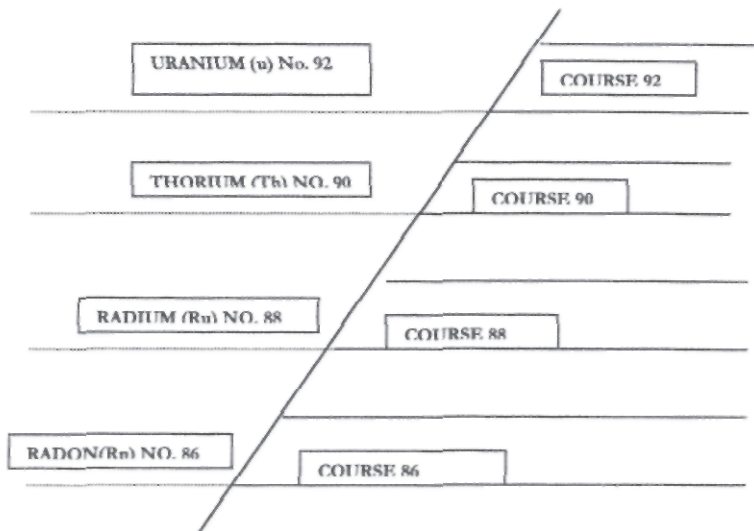

- Method Two:

"Another different but equally significant agreement between the atomic elements and the P course measurements is found by dividing the height

⁷ Ibid.

The Giza Death Star Deployed

(232.52050 Sacred Cubits) of the P in four equal parts. The quarter heights will fall on the following course numbers - 43, 95, 152, 215, (Apex). The heights being 58.27 Cubits, 115. 80 Cubits, 174.16 Cubits, 232.52 Cubits. (Apex) The atomic weight of the following elements closely correspond to the four quarter heights:⁸

Capt then produces the following diagram:

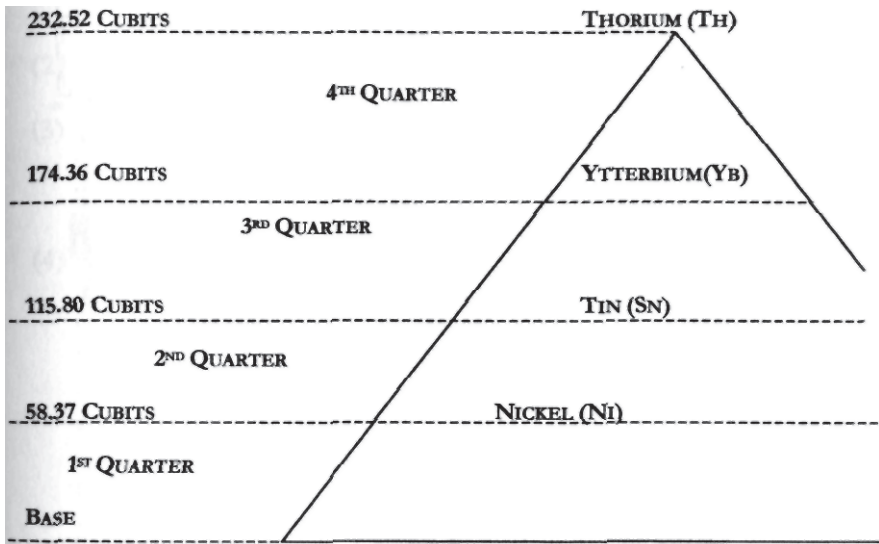

Peter Lemesurier's *The GREAT PYRAMID Decoded* presents a rather different interpretation of the stone courses, producing a graph demonstrating a deteriorating wave form with 26 distinct peaks.

⁸ Capt, op. cit, 252.

A Tesla Analysis: The Basic Argument for a Weapon Function

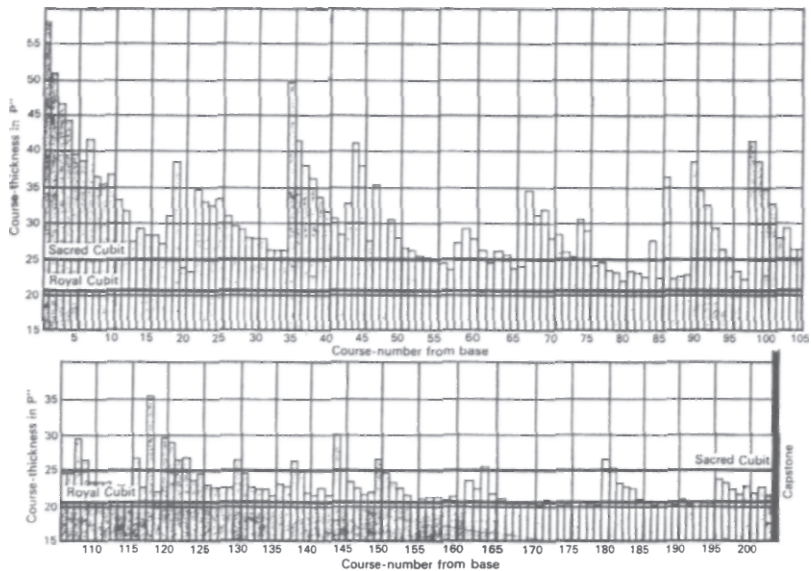

Figure 1 Lemesurier 's Graph of the Stone Course Thicknesses

His commentary is reproduced in full:

Allowing for (the degree of error in Petrie's measurements), it will be seen from the graph that a number of surprisingly regular 'curves' result, interspersed with a number of sudden 'peaks' - features which may conceivably have an objective, exterior in some field of specialist inquiry yet to be identified. Internally, however, it is noteworthy that factorisation (sic., et passim) of the course numbers of the 26 unmistakably peak courses produces as factors the numbers 1, 2, 3, 4, 5, 6, 7, 8, 9, 10, 11, 12, 13, 19, 29, 41, and 67 (all of them features of the Pyramid's geometric and/or arithmetical codes...., plus the further numbers 17, 23, 37, and 59. Since it would presumably have been perfectly possible for the designer to have chosen exclusively prime numbers for his peak courses - or numbers divisible only by 2, 3, and 5, say - it seems reasonable to see in his choice of peak courses a deliberate

The Giza Death Star Deployed

indication of the essential signals comprising his internal code and a hint that factorisation (sic.) might play a role in its application."⁹

(1) Possible Implications

With respect to the two methods of Capt and Lemesurier's observation of the wave form evident in the thicknesses of the stone courses and the evident factorization, one may speculate that:

- (1) There is some connection between the 26 peaks of the wave form of the stone courses and the gravito-acoustic harmonic resonator arrays of the Grand Gallery;¹⁰
- (2) That the factorization of the stone courses may represent a harmonic understanding of the periodic table; and
- (3) That this putative harmonic understanding in turn may have some relationship to the Pythagorean comma and particle¹¹ and represent therefore a quantized theory of the harmonics of the elements; finally,
- (4) Since it is hypothesized that the Pyramid oscillated all possible waveforms within a target, and since analogs of significant physical constants and properties are found in other dimensions of the structure, it would stand to reason that some similar analog of the periodic table would find an analog in some structural component of the Pyramid. It is perhaps also significant that there are 204 stone courses in the structure, if one counts the capstone, and over 200 fundamental particles in contemporary quantum theory; and finally,
- (5) Some authors have speculated that the wave form evident in the thickness of the stone courses may have been an architectural feature designed to allow the structure to absorb and dissipate the shocks of earthquakes.

Returning now to our main argument, the Great Pyramid must be able to configure oscillations of combinations of elements in some harmonic as

⁹ Lemesurier, op. cit., pp. 333-334.

¹⁰ Cf. my previous book, *The Giza Death Star*, pp. 269-270.

¹¹ The Pythagorean Comma was discussed in my previous book, *The Giza Death Star*, on pp. 211-215, 228. The Pythagorean Particle is discussed in chapter 9 of the present work.

A Tesla Analysis: The Basic Argument for a Weapon Function

they exist when combined in Any Possible Receiver (target). If receivers for the reception of electrical power or communications had been present at the load end of the system, then any "power plant" or "communications device" at the source end would have been capable of much simpler construction. If the purpose of the Great Pyramid was merely to produce power for normal peaceful uses, this could easily have been accomplished by a much more simple structure along the lines of Dollard's schematic above, and received by a similar device in some harmonic configuration to the transmitter (with oppositely wound coils). Following Tesla's principles, it thus would have been totally unnecessary to the system to engineer analogs of all possible elements and their combinations in the transmitter, since a similarly configured receiver would be necessary as the load to the system if and only if the purpose of the system was peaceful, i.e., merely for the production and use of electrical power.

It is the presence of significant physical and structural analogs in the Great Pyramid of the chemical elements - as well as of its over-engineered complexity, the nested feedback loops of the Planck units in harmonic expression (cf. chapter 9), and analogs of galactic, planetary, and quantum mechanical properties, and so on - that indicates that it is constructed deliberately as the transmitter for impulses or oscillations of Any Possible Receiver in local space. That is, it could have been constructed for no other purpose than as a weapon.

Accordingly, the transmitter must also oscillate all possible combinations of elements in all likely mass gradients. One has here perhaps a further corroboration of why corundum (sapphire and ruby) must once have existed as components of the resonator arrays in the Grand Gallery, since they are needed to oscillate all possible mass gradients in the receiver by dint of their gravito-acoustic properties.

This, then, constitutes the basic argument for a weapon function. What follows in the remaining chapters of this book merely elaborates this very fundamental and simple line of reasoning.

(2) Beyond the Threshold of Stability

On the basis of the above considerations, there are four possible ways that any possible receiver can be loaded past the threshold of stability: (1) A chargeless "superluminal" scalar "carrier" wave of dielectric impulse loads acoustic energy directly into the atomic nuclei of a

The Giza Death Star Deployed

receiver, causing it to initiate fission or possibly fusion reactions depending upon the properties of the wave-target interaction; or,

- (2) The production of a sudden, nearly instantaneous equivalent of a large "artificial or virtual" mass gradient in nearby space to a target would subject it to tidal stresses of a sudden nature similar to the production of an artificial Roche limit, causing an instability that could not be damped and again causing the receiver to cross the threshold of stability; or,
- (3) The production of a properly configured, rigorously reversed impulse upon a potential region would produce "virtual particles" of equivalent mass but opposite spins, i.e., would produce matter-anti-matter annihilations within the potential region;¹² or,
- (4) Any combination of the above.

Of these possibilities, number four seems, unfortunately, the most likely result of the type of unified paleophysics that seems to be implied in the structure, but any one of them would be capable of producing the type of regional, hemispheric, or even planetary annihilation that other physical evidences seem to imply.

C. Bear den on the Problem of Isotropy and Anisotropy

The basic argument for a weapon function may be advanced on a slightly different basis by considering the problem of the isotropic or anisotropic characteristics of the oscillator itself. As for Bearden, "it is my thesis that Tesla had discovered what today is called the time-reversed wave, pumping, and the phase conjugate mirror effect. It is also my thesis that his magnifying transmitter would have worked, just as he said, if he could actually have caused the pumped phase conjugate mirror of the earth to go into self-oscillation."¹³ The method for doing this is simple:

¹² I am aware that this violates the customary standard view of quantum mechanics that all such phenomena exhibit the "wave-particle duality." However, it might be that a coherent model can be constructed wherein "waves observed", i.e., interacting with matter of any sort, are observed as particles. This would correlate to LeBon's understanding of radioactivity as well as Van Flandern's proposed "meta-model" of cosmology.

¹³ T.E. Bearden, "Maxwell's Original Quaternion Theory was a Unified Field Theory of Electromagnetics and Gravitation," *Proceedings of the International Tesla Society* (6/24-6768), p. 6/44.

A Tesla Analysis: The Basic Argument for a Weapon Function

We visualize a powerful initiation/activation transmitter operating at a fixed frequency within the earth's resonant frequency band, transmitting a signal vertically into the earth - just as Tesla planned. A deeply buried ground (plate) is to be used for good earth coupling - again, just as Tesla constructed.

When the transmitter wave is sent vertically down into the nonlinear earth medium, by Newton's third law a "back-(electromagnetic force)" wave is also produced, 180 degrees out of phase. These two waves are locked together (caused to modulate each other) by the non-linear earth medium. This produces a scalar pump wave, with the earth now able to begin to act as a pumped phase conjugate mirror.¹⁴

The resonant properties of the King's Chamber and Coffin to the Schumann resonance of the earth has already been pointed out in my previous book, *The Giza Death Star*.

Bearden then comments as follows on the necessary components to receive power from such a system:

To the distant extraction site, the earth appears as a giant, self-powered triode. The extraction transceiver can "input to the local grid" and "receive from the local plate" freely, without having to furnish any power to the cathode or plate. All that need be done to extract enormous energy is to input the "grid signal" into the earth,¹⁵ and receive the enormous "plate signal response." The standing (Scalar Wave) is continuously replenished from the stress energy in the earth itself, so power may be extracted continuously. Or, if the grid signal is pulsed, the plate extraction power is pulsed. In that manner pulses of (electromagnetic) energy of incredible power can be extracted from the earth. This of course enables the powering of fantastically powerful pulsed directed energy weapons.¹⁶

Note that Bearden has essentially reprised our previous argument: in order for the system to function for the transmission of power for peaceful purposes, a relatively simple receiver exists at the "load" end of the system, a receiver that according to Dollard can exist in a simple harmonic relationship to the transmitter's geometric properties. In the absence of such a receiver, an overly-engineered transmitter can only be for the purpose of "inputting signal" into any possible geometric configuration of Any Possible Receiver.

¹⁴ Ibid., p. 6/45.

¹⁵ "Input the grid signal into the earth," i.e., construct the receiver in harmonic relationship to the pumped wave itself. Emphasis added.

¹⁶ Ibid., p. 6/47, emphasis added.

The Giza Death Star Deployed

However, the earth is not an isotropic, that is to say, it is not a uniform medium. It consists of different elements in different mixtures and compounds, under different internal stress conditions at any given location on its surface or within it. It is anisotropic, that is, not uniform. As such, "its deviations disrupt the idealized situation so that very appreciable damping of the (scalar wave) occurs, quickly extinguishing the self-pumping feature."¹⁷ It is to be noted that the Great Pyramid would appear to be precisely an analog of this idealized situation, since its material construction and geometric characteristics are relatively isotropic.

With that in mind, Bearden's commentary is most illuminating:

Accordingly, the idealized scheme previously presented must be modified to minimize anisotropic damping. The major task is to establish in the earth the standing (electromagnetic) wave of our frequency choice that essentially acts as a sine wave, allowing the buildup of the (scalar wave) by the earth regeneration effect. So let us consider why a wave breaks up in a nonlinear medium.

The speed of a wave in a material medium depends not only on the medium's characteristics but also at least somewhat upon the amplitude of the wave. Hence, for a sine wave, the peaks travel faster than the lower parts of the wave, overtaking them and causing destructive interference, with consequent wave breakup and severe damping. This exact problem has been met and successfully overcome with ultrasonic sound waves in the ocean.

Remember Gavreau's infrasound?

We shall apply the same technique to help overcome our breakup and dephasing problems in the earth.

Briefly, a remarkable phenomenon occurs if two sine waves, separated by a frequency difference, are simultaneously transmitted into the nonlinear medium. In this case, we wish to utilize the difference frequency between the two transmitted waves, and we wish to have this difference frequency wave propagate through the medium as a sine wave. Accordingly, we pretend that we have transmitted into the earth the difference beat frequency between the two waves.

If the medium is not too anisotropic, it can be shown mathematically that the difference frequency will be essentially propagated through the nonlinear medium as a sine wave, and will not be subject to breakup and damping...

Since the earth is spherical, spherical standing scalar (electromagnetic) resonance waves are set up in it. Therefore the oscillation condition ... exists at every point on the earth's surface.¹⁸

¹⁷ Ibid., p. 6/47, emphasis added.

¹⁸ Ibid., pp. 6/49-6/49, bold emphasis Bearden's, plain italicized emphasis mine.

A Tesla Analysis: The Basic Argument for a Weapon Function

But if the intention is to oscillate the anisotropic medium itself, howsoever it may be found at any location, then the transmitter must not only be of a relatively isotropic material and geometric construction, but it must also be able to oscillate the anisotropic characteristics of any location, and thus must contain some analog of the geometric and material characteristics of any location, and be able to configure the characteristic "signal" of that location. That is, on Bearden's scheme, the transmitter and receivers would be of relatively simple construction, without having to reproduce physical analogs of the receiver. Analogues of the atomic weights of the elements, much less of harmonics of Planck units, would be as unnecessary to such a scheme as they were unnecessary to Tesla if the intention were only to transmit power. Within the context of a "Tesla analysis" of the structure, it is the over-engineering of the Pyramid that constitutes the strongest prima facie evidence for the weapon function.

Now we have a basis for understanding why Sitchin's texts, cited in my previous book, *The Giza Death Star*,¹⁹ placed such a heavy emphasis on the destruction of the components that once existed inside the structure, in the Queen's Chamber, the Grand Gallery, King's Chamber, and the Apex itself, for as was seen there, the Pyramid may be analyzed into two basic components. The first component is the fixed, stable structure itself, functioning as an analog, and therefore, oscillator, of universal physical and geometric properties, constants, and components. This, and this only, is the structure that remains at Giza, the empty shell.

The second element of component was the now-missing parts -Sitchin's "magic crystals" or the "gravito-acoustic resonators" that I referred to in my previous book - that allowed it to "input signal" to any specific target location and load it past the threshold of stability. That is to say, the missing components were not only the tuning and therefore the targeting mechanism, but the "bullets", which in any weapon based on harmonic interferometry are one and the same thing. The missing components allowed the Pyramid to be configured to be resonant, to be targeted, anywhere in nearby space, to "read" its signal, and pump a standing wave within it.

Recalling the acoustic piano illustration of coupled harmonic oscillators that I used in *The Giza Death Star* to explain the concept perhaps is the best illustration Holding one or more keys down silently

¹⁹Cf. *The Giza Death Star*, pp. .

The Giza Death Star Deployed

that are close overtones of a struck key allows the open strings of the piano - essentially an oscillator of "all possible keys" - to vibrate sympathetically and receive energy from the struck string. The missing components of the Pyramid functioned like holding down the pressed keys of our piano; thus reading the harmonic "signature" of the target, and amplifying and reflecting that amplified energy back upon it, the target was destroyed with an unerring accuracy. Such a "reading" of the harmonic signature of a target would have produced strong field effects in the Pyramid, including gravitational effects.

This selection of mechanical and inertial imagery of acoustics is not accidental, as we shall see in chapter 9. But for now we may conclude that the Giza Death Star was a horrifyingly "loud" - an overpowering, and massively destructive - "pipe organ."

COHERING THE ZERO POINT, VACUUM ENERGY FLUX: A SYNOPSIS OF SCALAR PHYSICS AND PALEOPHYSICS

"The reason for adamant Soviet insistence that the SDI genie must not be tested in space is that, should the U.S. develop scalar EM weapons - such as high energy scalar lasers ~ and deploy them as SDI modifications, the power would be enormously increased With one or two shots, such a laser could devastate a whole republic of the USSR."

Lt. Col. T.E. Bearden (Ret.), "Historical Background of Scalar EM Weapons"

A. Conceptual Foundations of Scalar Electrogravitational Physics

"Scalar physics" is a term given to a kind of "unified physics" based on Maxwell's original equations of electromagnetism. According to its foremost exponent, retired US airforce lieutenant colonel T.E. Bearden, this physics is distinguished from classical post-relativistic physics in three major ways:

- Scalar physics accepts the existence of a propagation medium, or aether, for the forces of gravity and electromagnetism.¹ Unlike the classical "aether" of 19th century physics, this aether may be described as "hydrodynamic," i.e., as possessed of fluid properties. As such, it is an aether that is itself being swept along in space by celestial bodies.
- Gravity waves are longitudinal and propagate at faster-than-light velocities; and,
- Such longitudinal waves may be generated by a complex harmonic interferometry of electromagnetic waves, indicating the

¹ Whether gravity and electromagnetism can use the same propagation medium is not clarified by Bearden, though in the pre-relativistic era the implication of most physicists remarks on the subject was that there was but one medium for both types of forces. Torn Van Flandern presents cogent arguments that the media for gravity and electromagnetic force propagation are two distinct entities in his *Dark Matter, Missing Planets, and New Comets*. Cf. pp. 27-77 for a complete exposition of the topic of gravity, the medium, and resolutions of conflicts with the theories of relativity. I disagree with his view however, since this seems an unnecessary supposition and one that would tend to de-unify rather than unify the fields.

The Giza Death Star Deployed

relationship between gravity and electromagnetism and their unification in a kind of hyper-complex "well tempered" or "equal tempered" harmonic series.

- The fact that a propagation medium (or media) are supposed in this model means "spacetime in a sense may be regarded as a conglomerate of potentials - including the scalar (electromagnetic) potentials."²
- "Bidirectional harmonic wave structures" thus constitute the basic structure of the vacuum.
- Most importantly, the infolded scalar electromagnetic wave structure inside side a potential region that has been harmonically interfered is called "the information content of the field".⁴
- In the medium (or media), "continual creation and annihilation of spin-2 gravitons is occurring. A scalar potential, then, is composed of this dynamic structure. "

It should be noted that these suppositions bear some resemblance to a different cosmological model - though one still far more "classical" than post-relativistic - proposed by astronomer Tom van Flandern.

(1) Maxwell's Quaternion Electromagnetic Theory

According to Bearden, modern theoretical physics took a massive wrong turn after Maxwell first formulated his equations of electromagnetism. As was outlined in my previous book *The Giza Death Star*, Maxwell first formulated his equations in quaternion geometry, which differs significantly from the standard "vector analysis" in which subsequent electromagnetic theory - and most subsequent mathematical physics including relativity - are couched. To understand the effects that this change of mathematical language, from quaternions to vector analysis, had on physics, we need only to understand a few simple concepts.

First, there are two types of effects that electromagnetic fields can have on charged particles: (1) translation, and (2) stress. There are two

² T.E. Bearden, *Gravitobiology* (Tesla Book Company, 1989), p. 2.

³ *Ibid.*, p. 9.

⁴ *Ibid.*, p. 18. Bearden notes that this terminology is that of the Soviet scientists who pioneered scalar physics research. The term was used loosely in *The Giza Death Star* to describe the way the ancients viewed the forces of vacuum space.

⁵ *Ibid.*, p. 19, emphasis in the original.

Cohering the Zero Point, Vacuum Energy Flux

types of translation, or movement. The first type is simple translation in a straight line, produced by the electric, or E, field itself. The second type of movement is that of a swirl, or spiral, mathematically symbolized as the "B" field.

Now let us assume there are two vectors, E_1 and E_2 , acting upon a particle, as shown.



The result is a translation in the direction of vector E_3 , which is called a "resultant" vector. Thus, in systems where a large number of translation vectors are involved, "the entire system can be replaced by a single vector insofar as translation is concerned."

Now observe that if no translation occurs, the resultant is a "zero vector." However, one must always recall that one is dealing with geometry and not simply mathematics or numbers. One can therefore envision a multitude of multi-vector systems resulting in a zero-translation vector, yet that have different internal stresses and geometries:

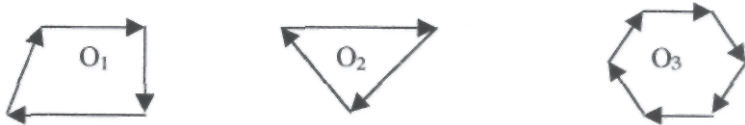

Now we may explain a term that I used in *The Giza Death Star* in reference to certain passages in the *Hermetica*. There I referred to "mind" as being "information in the field." In the technical sense that this phrase is used by Soviet physicists, it means precisely the information contained within such a zero-summed vector matrix. Each of the above examples thus contains different information, which we may regard as the "scalar harmonic signature" of that particular region, or field.

⁶ Bearden, "Maxwell's Original Quaternion Theory Was a Unified Field Theory of Electromagnetics and Gravitation," *Proceedings of the International Tesla Society*, 6/24-6/68, p. 6-24, emphasis in the original.

The Giza Death Star Deployed

The result of such a change of mathematical languages on physics is enormous, since it posits certain assumptions about the aether, and the interactions (or lack thereof) of the "observable world" with it.

The point is, in the use of vector analysis to represent "electromagnetic" forces and effects, certain assumptions are involved in the mathematical model itself. The abstract vector space (the "medium" in which the vectors are assumed to exist) is taken not to be subject to stress, strain, local spin, etc. The vector space medium is assumed not to interact in any fashion with the vectors, nor the vectors with the medium. The vector space itself has no momentum or physical characteristics of its own, and it contains no virtual state particle flux and virtual state energy. It is a totally static medium...⁷

Bearden summarizes the effects of an aetherless vector analysis in nine points:

1. Vectors do not interact with vector space (the medium).
2. Vectors need no "physical connector" to interact.
3. Vector space (the medium) contains no hidden subspaces.
4. Vector space (the medium) has no energy, pressure, flux, flux density, hidden fields, curvature, or physical properties.
5. All vector zeros are identical and produce no action on the vector space (the medium).
6. Vector zero and the absence of a vector are identical
7. A zero-resultant (for translation) multivector system produces no translation. It also produces no non-translation action and is replaceable by a zero vector.
8. A multivector system that has a zero vector resultant has no internal action on the medium (the vector space).
9. Neither the medium (vector space) itself, nor any part of it, has a scalar or vector value.⁸

Note that number 5,6, and 8 are the key elements missing from a stress-free, non-physical medium.

Since no internal geometries are even posited as the result of different multi-vector systems summing to zero, all our electromagnetic theory and engineering "have been 'force-fitted' to the universal photoelectric effect," i.e., to the interactions between photon and electron, and not to the potential electro-gravitational effects of the nucleus, where the bulk of atomic mass, and positive electric charge, resides. We are observing, and

⁷ Bearden, "Maxwell," p. 6/26.

⁸ Ibid., p. 6/27, emphasis added.

engineering, only the shell, to coin a pun. In short, the atom itself is like a very small Faraday cage. Most electromagnetic reactions occur between photons and the surrounding electrons, and not the nucleus, of atoms. The nucleus, just like a person standing in a Faraday cage, is "shielded" from these effects.

Now let us consider vector cross products in standard linear algebra -the mathematical model everyone learns as "Maxwell's equations", and the actual quaternion mathematical geometry that he really used, with my apologies to readers that are not mathematically inclined! In standard vectors in three dimensions, the vector resultant in three dimensions v is composed of the sum of three vectors each moving in the directions of the $x, y,$ and z axes of standard Cartesian coordinates,

$$v = ai + bj + ck,$$

where i, j, k are the individual unit vectors respectively, and a, b, c are constants. If the unit vectors i, j, k are all zero vectors, then $v = 0$.

Now we imagine a case of the product of two identical translation vectors yielding a resultant translation vector R_b of zero:

$$|v \times v| = |v|^2 \sin \theta = A^2 \sin \theta = R_t = |0|.$$

Note that this standard zero vector equation says nothing at all about the internal stress on a particle as a result of the two interacting vectors $v \times v$ summing to zero.

Two interpretations are possible. One is that nothing, translational or otherwise, is happening. If one is trained in physics to replace the resultant with a zero-vector, then one implicitly is taught to assume no significant EM effects are occurring at all, if the only significant effect in view is translation, which is the only significant thing vector analysis can model!

However, the other interpretation is that translation effects are only one subset of possible effects, and that non-translation effects, non-linear effects - electromagnetic or otherwise - may be occurring.

Now we turn to a quaternion analysis of the very same process. A quaternion is essentially a scalar plus a vector (for the non-mathematical, a

⁹ Bearden, *Ibid.*, pp. 6/30-6/31.

The Giza Death Star Deployed

"scalar" is simply a number, like the number or coefficient of a constant or variable):

$$q = w + v.$$

Substituting our previous Cartesian expression into this, we discover a quaternion is made up of a scalar component plus the various unit vectors of a standard system:

$$q = w + ai + bj + ck.$$

A quaternion product therefore yields interesting results. The translation unit vectors still produce a zero-translation vector resultant, but there is also an internal interaction of the coefficients, the scalar component remains, representing the sheer magnitude of force present at the stressed point of the medium:

$$q \times q = w^2 + v \times v = a^2 + b^2 + c^2 + 0_i,$$

where 0_i is the translation or zero vector.

It is very important to understand what this internal "hyper-dimensional" interaction of the coefficients of the constants (the $a^2 + b^2 + c^2$ in the above expression) seems to imply, insofar as the physical constants are concerned. Since the coordinate or vector component has disappeared, the normal technique of dimensional analysis has disappeared with it, and there is only an interaction of the scalar, nonlinear component in "hyper-space;" this tremendous interaction would then "flow downhill" into our standard space, just like water dammed up behind a dam flows downhill. The problem is then to figure out how to turn the key to open the spillway. This "dimensionless" interaction of constants will be explored more fully in chapter nine.

That is, quaternion cross products produce non-zero scalar resultants that may be understood as indicating the non-translation stress of the medium itself. Since this scalar resultant has no electromagnetic translation involved,

it does not interact with the electron shells of the atom. Instead, it passes through the electron-shell 'Faraday cage' surrounding the nucleus and interacts with the highly non-linear nucleus. What is now oscillating is the electromagnetic

Cohering the Zero Point, Vacuum Energy Flux

potential (charge) of the nucleus itself. The energy density of the charged nucleus - and hence its electromagnetic potential - is being oscillated as a periodic function of time. The oscillating potential, however, is deterministically substructured (internally polarized) by the infolded electromagnetic multivector system.¹⁰

Consequently, much current electromagnetic and gravitational theory went tragically awry in three very fundamental ways:

- By dispensing with a dynamic aether and adopting a vector analysis version of electromagnetics, no interactions between vector systems and their medium was possible.
- Thus, since no interactions were possible, local stressing of the medium was not possible.
- And thus, electromagnetics focussed almost exclusively on translation as the most fundamental type of physical action.

(2) Deliberate Editing by Heaviside?

It was Oliver Heaviside who "edited" (butchered would be a more appropriate word) Maxwell's original quaternion formulations by reducing the admittedly more cumbersome and complex quaternions to vector analysis by throwing out what he viewed as its "metaphysical" scalar component. By throwing out Maxwell's scalar "potentials" of the medium, he effectively reduced electromagnetism to a consideration of "translation" and "fields". One cannot help but wonder why, in the case of so many esteemed scientists and engineers such as Maxwell, Tesla, and Moray, their clear theoretical formulations and observed and repeatable experiments into the properties of "aetheric" energy seem to all but disappear from the textbooks and history books. One need wonder no further, of course, than to comprehend the threat that such physics poses, not only militarily, but even more basically, to the whole geopolitical and economic structure of the post-industrial world, based as it is on inefficient "translation" energy. The deliberate confiscation and editing of Tesla's and Moray's patents and papers by governmental and other agencies is well known. One wonders if, perhaps, Maxwell himself was the victim of an organized campaign of disinformation and misrepresentation in order to

¹⁰Ibid., p.6/33.

The Giza Death Star Deployed

keep the more sensational aspects of his theory from being investigated too closely by the general public. Maxwell provided the theory, and Tesla the experiments. It leaves one to wonder what a quaternion analysis of Tesla's impulse experiments might reveal.

In any case, whether deliberate or not, the effects of Heaviside's alteration of Maxwell's equations on the formulation of Einstein's special and general relativity theories demonstrates the lasting effects that a seemingly minor shift of mathematical language and paradigms can have on the development of physics and engineering. Since Heaviside's massively truncated version of Maxwell's theory envisions only vector translation electromagnetic waves passing rapidly through the local medium, any effects of such passage would perforce have to be miniscule and negligible. Only in the presence of large masses would there be a sufficient number of electrons gathered to exert a gravitational effect on electromagnetism, which is exactly what Einstein predicted! In short, only in the presence of large masses would bending of spacetime occur.

Not only has Einstein thus limited himself to a view that restricts electromagnetic effects to translation and the photoelectric effect, but he has also engendered the implicit assumption in so much practical and applied physics that no laboratory experimentation in the warping of local space-time is possible.¹² Local space-time remains flat and uncurved. In fact, with General Relativity, "Einstein did not write a theory of unrestricted anisotropic spacetime at all; instead, he wrote a sort of 'special relativity with distant perturbations.'"¹³ Discarding the aether as a dynamic and interactive medium with the observed world after the fallacious interpretation of the results of the Michelson-Morley experiment, and confining himself to the Heaviside version of electromagnetism, Einstein discarded the two paradigms that would have made his sought unification of electromagnetism and gravity possible:

¹¹Bearden, "Maxwell," p. 6/37.

¹²With regard to the Philadelphia Experiment, it is often alleged that Einstein's involvement was due to his allegedly having actually completed his Unified Field Theory in secret. This seems highly unlikely, since the one necessary mathematical component that would have allowed for such unification, quaternion geometry, was dispensed with from the outset.

¹³Ibid.

Cohering the Zero Point, Vacuum Energy Flux

local and therefore engineerable curved spacetime via an infolded scalar potential of the aether.¹⁴

(3) Characteristics of the Scalar Wave

Scalar electromagnetic waves have some peculiar properties, properties first noted by Nikola Tesla - who in all likelihood discovered them in his direct current high voltage impulse experiments - and researched by the Nazis as part of their radar-cloaking investigations into Radar Absorbent Materials (RAMs) during World War Two. As we have seen, according to Bearden it was the Soviets who first put two and two together to create a theoretical model to guide their own research into this tremendously very beneficial, and potentially very destructive, phenomenon.

The basic method of creating the phenomenon was through interferometry: combining beams of electromagnetic energy on a nonlinear propagating medium, such as a radar absorbent material:

If two weak monochromatic (electromagnetic) waves are run together 180 degrees out of phase, and run through a nonlinear medium so that they modulate each other and lock together, they make a strange "scalar (electromagnetic) wave" that is an electrogravitational wave of pure potential, and one that you are controlling. Such a wave goes down through the electron shells of the atom, and is absorbed in the nucleus. If you choose the right mix of waves in the scalar wave, and just keep irradiating the nuclei with that "pattern," the nuclei will gradually rearrange themselves. For example, they will be transmuted into another element, given the proper signal mix. That is actually how biological systems are able to transmute elements to a limited degree, using millivolts and microwatts of power. They do not have giant supercolliders!¹⁵

It should be noted that Bearden is maintaining that phenomena such as radioactivity are not inherent properties of certain "unstable elements" but rather a property of certain elements in some sort of harmonic relationship

¹⁴ Of course, almost as soon as relativists had banished the notion of a dynamic aether, quantum mechanics revitalized the notion, disguising its reappearance under the terms zero point energy, vacuum flux, or (my personal favorite), "quantum foam".

¹⁵ T.E. Bearden, "The Western Scientific Community's Record on Unorthodox Science," Analysis of Scalar/Electromagnetic Technology (Tesla Book Company), 47-54, p. 51.

The Giza Death Star Deployed

to the potential of the vacuum, i.e., to the geometry of space and the objects in it.

Bearden's comments on what this scalar wave actually signifies for a principle that can be weaponized are chilling. The scalar wave

represents a gigantic electrogravitational standing wave, and hence a giant oscillating potential in spacetime. This standing wave represents a sort of gigantic "capacitor, or accumulator of infolded energy. Enormous energy may be collected in this potential, charged-up over a period of time. "Shortout" of this giant capacitor - by transmitter failure - can result in a large flash-over discharge of the (electrogravitational) energy into the local earth, producing a massive (electrogravitational) ground wave that can be enormously destructive.¹⁶

As has been noted elsewhere, this scalar wave is longitudinal, i.e., a wave of compression and rarefaction in the medium itself. As Tesla discovered, the "field-wave" travels faster than the wave it propagates. As such, these longitudinal electro-gravity waves propagate faster than light.

(4) Zero-Summed Vector Fields, Interferometry, and Scalar Weaponry

As was mentioned in the previous chapter, one essential technology in the production of scalar waves is Radar Absorbent Materials, or "RAM" or stealth technology.

The RAM technology is precisely what is needed to develop and design phase conjugate mirrors for radar frequency bands. Phase conjugate mirrors are capable of producing a time-reversed (TR) wave in direct response to a received ordinary wave. The mirror may be powerfully "pumped" with energy to produce a very large amplification of the time-reversed wave.¹⁷

In the Giza Death Star I observed that one ancient myth of a superweapon was the Chinese legend of the "yin-yang" mirror, i.e., of a mirror that reflected the duality of the yin-yang cosmos. Here one has a modern corroboration of that notion in a mirror that reflects and amplifies a superluminal longitudinal wave back upon a target emitting electromagnetic waves.

¹⁶ T.E. Bearden, "Soviet Phase Conjugate Weapons," Analysis of Scalar/ Electromagnetic Technology (Tesla Book Company), 35-46, p. 37.

¹⁷ T.E. Bearden, *Ibid.*, p. 35.

Cohering the Zero Point, Vacuum Energy Flux

The characteristics of this wave form further obey the populations of the longitudinal and particulate structure of gravity outlined in section A. There it was noted that, since Newton, science has treated gravity more or less as a field of instantaneous action acting upon lines of force between bodies.

A time-reversed wave has startlingly different weapon capabilities, compared to a normal wave.

Such a wave precisely retraces the path of the ordinary wave that stimulated it to be formed. So it possesses an "invisible wire" through space, back to the original position of whatever emitted its stimulus wave.¹⁸

This "invisible wire" or "harmonic signature" effect is a strong indication that gravity constitutes the main ingredient of a scalar wave. Moreover, it corroborates another unusual phenomenon first observed by Tesla: the effects of such a wave did not dissipate according to the standard inverse square law. However, it should be noted that such a gravity wave cannot be the only component of a scalar wave, since gravity does appear to obey dissipation laws.

But how would this be achieved? Bearden's explanation is chilling:

An artificial potential can be produced by deliberately opposing electric or magnetic fields so that they vectorially sum to zero. The result becomes a "zero vector" field insofar as resultant or "envelope" fields and external observers are concerned. This field has no electric or magnetic field, yet it possesses a multifold substructure. It is a stress in spacetime vacuum itself. By varying the substructure vector components, with the resultants always summing to zero, a pure scalar potential wave - spatiotemporal stress wave - can be produced.

Each of the component electric and magnetic force fields in the zero summation are still exclusively present, though not exclusively present to an external observer. All the component energies are "infolded" against each other and locked-in as stress energy of vacuum, even though the wave possesses no "envelope" force field magnitude and hence no ordinary electromagnetic energy.

By interfering two beams of such scalar waves at a distance, a scalar interferometer is produced. Energy may be produced at the distant interference site, or it may be extracted from that distant site. No electromagnetic energy, as such, flows in the intervening space between the transmitters and the distant

¹⁸ Bearden, op. cit., p. 35, emphasis in me original.

¹⁹ This is the aspect missed by Van Flandern. If gravity is to be considered a longitudinal wave in a classical action-reaction system, then the acting wave will indeed, per Newton, obey an inverse square law dissipation effect, but the reacting wave will not.

The Giza Death Star Deployed

target site. This is Tesla's old "transmission of energy at a distance without losses," and scalar interferometry was his secret.²⁰

Note that energy may be extracted from targets by means of this interferometry. One such signature of this type of use of a weapon in potential regions filled with living creatures would be their sudden and inexplicable death. One may further expect that the creatures would in some instances show evidence as having been "cooked" by a very sudden, very high-powered burst of microwave energy. It is the equivalent to drawing out the minute electromagnetic energies that living creatures use to survive, the equivalent to pulsing aircraft to shut off their power and communications systems. Like the plane being nothing but a useless hunk of metal at that point, a bird would simply be a useless, and very dead, hunk of meat, no more capable of flight than a jet aircraft without its electrical systems.

Bearden summarizes the effect of such a scalar impulse as follows:

(An electromagnetic pulse) will dud any and all electronic equipment; explode high explosives, fuels, and combustibles; and render any modern weapon harmless. The high (electrogravitic pulse) will detonate a nuclear warhead immediately in a "full-up" nuclear detonation. It will also instantly kill any living creature, including every cell, bacterium, virus, and organism in its body. It will also detonate any ordinary, non-radioactive material with a low-order nuclear detonation of all its nuclei.²¹

I find this aspect of the physics and its application quite alarming, because recently in Tennessee and Florida, in two separate incidents, animals and birds suddenly and inexplicably fell dead, oftentimes while in the midst of flight. This is a strong indication that someone, somewhere, has developed and deployed scalar weaponry.²² It is also to be stressed that this is a very low level application of such weaponry.

²⁰ T.E. Bearden, "USSR: New Beam Energy Possible?" Analysis of Scalar/Electro magnetic Technology (Tesla Book Company), 31-33, p. 32. Bold-faced emphasis added.

²¹ T. E. Bearden, "Historical Background of Scalar EM Weapons," Analysis of Scalar/Electromagnetic Technology, 11-25, p. 19.

²² One must not assume, of course, that the "someone" is the United States, simply because these incidents occurred here. Scalar weaponry can be deployed at tremendous distances from target areas.

Cohering the Zero Point, Vacuum Energy Flux

But what does such zero-summing interferometry mean? Bearden aptly expresses the meaning in an analogy, and draws out its tremendous implications:

Visualize two sets of opposing and balanced forces pressing on the sides of a plate. The forces sum to zero, so the resultant force acting on the plate for translation is zero. Hence the plate does not translate (move away or accelerate). However, the plate is under internal stress (compressive), and is in quite a different condition than when it has no external forces at all acting on it.

Now visualize the forces being applied with rigid rods welded to the sides of the plate, so that the forces may alternately "pull" as well as "push." Let the forces rhythmically vary, alternately "pulling" and "pushing", but always remaining balanced so that their summation for a translation resultant is constantly a zero vector. The plate never accelerates or moves in translation, but it now contains an internal stress wave which (sic.) rhythmically varies between compression and tensile stress. Rigorously the plate internally possesses a scalar stress wave, or a "wave of internal stress in the medium."

Now visualize a similar "plate-like" region of vacuum, with its virtual particle flux, instead of the material plate. Visualize two opposing sets of (unzipped) (electromagnetic) force fields, acting in and on the plate-like region, so that they rhythmically increase and decrease, changing direction also, but always with a zero vector summation. In this case, there is an unzipped zero resultant (electromagnetic) force field (it is zero by our assumed conditions), but there is a rhythmic oscillation of the intensity of the vacuum flux (intensity of the vacuum potential) and the vacuum structuring in the region. That is, there is a rhythmic and steady oscillation of the stress energy and structuring of vacuum, and hence of the curvature of spacetime, in the plate-like region.

Rigorously, this oscillation - which we call a scalar electromagnetic wave - is a gravitational wave, since the local curvature of spacetime is being oscillated. Further, it differs from a "natural" gravitational wave in several respects: (1) it has a deterministic pattern or substructure, (2) it patterns or "polarizes" the vacuum, (3) it constitutes local curvature of spacetime, something which ordinary general relativity assumes cannot be accomplished, (4) it deterministically engineers the virtual state and local spacetime, (5) it is localized general relativity, (6) since it is achieved by converting electromagnetic field energy into artificial gravitational field energy, one can expect tremendous gains of gravitational and inertial effects in and around electrical circuits utilizing such fields precisely, (7) it affects the Schroedinger wave and the probabilities of the states being propagated forward by the Schroedinger wave. With the scalar electromagnetic wave, one can thus deterministically engineer the emergence of quantum change, and violate one of the fundamental assumptions of quantum mechanics, that of the totally statistical nature of quantum change, (8) the scalar wave can accomplish direct and localized change of the rate of flow of time (even to its reversal) and a variation of mass and inertia, without concomitant translation of

The Giza Death Star Deployed

matter, (9) by locally curving and patterning vacuum spacetime, a stabilized standing scalar electromagnetic wave can provide macroscopic violation of the conservation laws, which rigorously depend on a locally flat spacetime (Lorentz frame), (10) since the components in the zero summation may be electromagnetic waves, and may be "locked together" and broadcast to a great distance and interfered there, effects at great macroscopic distances may be achieved, in violation of present assumptions of physics, and (11) since excess negative time flow may be locally produced, antigravity, negative energy, and negentropy may be locally produced.²³

These lengthy observations require some commentary.

First, it is to be noted that scalar interferometry produces a wave of internal stress in the medium. That is, by stressing the medium itself, anything within that stressed region experiences extreme destabilization.

Second, note that "one can expect tremendous gains of gravitational and inertial effects in and around electrical circuits utilizing such fields precisely, " and that "the scalar wave can accomplish direct and localized change of the rate of the flow of time (even to its reversal) and a variation of mass and inertia, without concomitant translation of matter." Recall that Sitchin's texts spoke of a strong gravitational and inertial effect in the vicinity of the Pyramid when it was fully operational. In those texts, the reference to the "destiny stone" spoke of a "strong power" that was employed "to grab to kill me, with a strong tracking which (sic.) seizes to kill me." This was one of the internal components that was ordered to be "pulled out...be taken apart...and to obliteration be destroyed."²⁴ In other words, the ancient texts corroborate the existence of strong gravitational anomalies, and indicate that the Pyramid possibly employed some version of scalar physics.

Finally, Bearden notes that a "pumped phase conjugate mirror", i.e. a mirror that amplifies the signals it reflects, "becomes a powerful and lethal ray weapon capable of enormous destruction at extreme distances. Basically, such a weapon is not distance limited."²⁵

According to Dr. Stefan Possony, in addition to utilizing RAM or stealth technology in an offensive capacity, "interferometers will be the

²³T.E. Bearden, "Scalar Electromagnetics and Antigravity," Analysis of Scalar/Electromagnetic Technology, 73-87, pp. 78-79, italicized emphasis in me original, boldface emphasis added.

²⁴Zechariah Sitchin, The Wars of Gods and Men (Avon, 1985), p. 168.

²⁵T.E. Bearden, "Some Characteristics of the Phase Conjugate Wave," Analysis of Scalar/Electromagnetic Technology, 89-92, p. 90.

Cohering the Zero Point, Vacuum Energy Flux

principle component of any such weapon."²⁶ Other necessary components of such weaponized scalar technology would be "explosive power generators... special power units to produce energy from vacuums, translators to create and alternate waves, Fourier transformation computers and transmitters, and aiming-pointing instruments."²⁷

(5) Scalar Lasers

A final component of such weaponry would be a cohered electromagnetic output, in order to cohere the electrogravitational impulse itself. According to Bearden, the potential destructive effect of this addition explains one reason the Soviet Union so adamantly objected to the Reagan administration's determination to develop and deploy a "star wars" strategic defense initiative.

The reason for adamant Soviet insistence that the SDI genie must not be tested in space is that, should the U.S. develop scalar electromagnetic weapons - such as high energy scalar lasers - and deploy them as SDI modifications, the power would be enormously increased. With one or two shots, such a laser could devastate a whole republic of the USSR.²⁹

That is, is the United States were able to cohere the phenomenon - a field in which it is more proficient than its Soviet counterpart - a deadly new strategic offensive weapon would be created.

B. Principles of Zero Point, or Vacuum Energy, Coherence

Engineer and inventor Moray King has spent a lifetime investigating reports and inventions utilizing structured vacuum potentials as a source of

²⁶Dr. Stefan T. Possony, "The Tesla Connection," *Analysis of Scalar/Electromagnetic Technology*, 102-107, p. 106.

²⁷ Ibid.

²⁸ Indeed, there may have been some type of inside knowledge operative when Senator Edward Kennedy of Massachusetts described the system in those terms, i.e., as a system of deliberately designed offensive strategic potential and purpose, and not defensive. The alarm and strong reaction of the Soviet leadership during this period of history become more understandable if SDI is viewed as having ultimately a strategic offensive, rather than merely defensive, purpose.

²⁹ T.E. Bearden, "Historical Background of Scalar EM Weapons," *Analysis of Scalar/Electromagnetic Technology*, 11-25, p. 24.

The Giza Death Star Deployed

energy. The recent fruits of this research he has published in an important collection of monographs called *Quest for the Zero Point Energy: Engineering Principles for "Free Energy."*³⁰ He begins by noting that most inventions and theories have a common methodology: tapping the Zero Point Energy or ZPE as a practical engineerable idea arises from combining ZPE theories with the more recent theories of non-equilibrium thermodynamics and system self-organization.³¹

ZPE refers to the energy that exists at zero degrees Kelvin, i.e., in the absence of all heat, and thus it is the energy assumed by quantum mechanics to be inherent in the fabric of space itself. Thus "the ether came back into science" not as a physical substance but rather as a "randomly fluctuating energy."³²

Thus the latter theories "not only open the possibility of inducing coherence in this energy, but also provide the underlying principles on how this could be achieved."³³ However, there is a problem. Beyond the problem of how random vacuum fluctuations could become organized, or "coherent" and periodic,

Any spontaneous coherence seems to violate the second law of thermodynamics, which is generally understood to mean systems should evolve toward random behavior, not toward coherence. ...Prigogine won the 1977 Nobel prize in chemistry for defining the conditions under which a system could evolve from randomness toward coherence. The conditions are that the system must be 1) far from equilibrium, 2) nonlinear in its dynamics and 3) have an energy flux through it. These conditions are expressed in general system theory terms, and it turns out that the already published theories of the ZPE can under certain circumstances fulfill these conditions.³⁴

King suggests that one method would be precisely to utilize the vorticular motion of a plasma in ion acoustic mode. This might additionally manifest itself as a gravitational anomaly.³⁵

³⁰Moray B. King, *Quest for Zero Point Energy: Engineering Principles for "Free Energy"* (Kempton, Illinois: Adventures Unlimited Press, 2001).

³¹*Ibid.*, p. 13.

³²*Ibid.*, p. 15.

³³*Ibid.*

³⁴*Ibid.*, p. 14. A fuller discussion of non-equilibrium dynamics and systems theory in the context of this sub-quantum dynamics follows in chapter nine.

³⁵ *Ibid.*

Cohering the Zero Point, Vacuum Energy Flux

The reason for this is apparent. General Relativity describes gravity as a curvature of space resulting from stress energy. Consequently, if the ZPE has the enormous energy density predicted by theory, any local coherence of that energy would produce significant gravitational, or temporal anomalies, or both. The ZPE is consequently the only type of energy large enough to curve space by technological means.³⁶ A practical experiment to test this theory would be to pump a plasma or charged fluid through a vortex ring with precessional flow.³⁷ The use of plasma in a precessional flow might indicate that the Great Pyramid somehow cohered ZPE fluctuations, since there are strong indicators that it once contained hydrogen plasma, and it is well known that it embodies the earth's precession.

Precessional motion of plasma holds the link to another phenomenon mentioned in my previous book as possibly having been involved in the physics and engineering of the Great Pyramid: sonoluminescence.

Schauberger³⁸ did a series of experiments circulating water in specially spiraled pipes. At certain velocities the fluid flow manifested negative resistance, i.e., energy creation, as well as a strange bluish glow appearing in the water near the bottom of the vortex. Such a glow is reminiscent of sonoluminescence(sic.).... The theoretical research by Reed (1992), Jennison (1978) and winter (1991) suggests a golden mean, logarithmic spiral is the three-space projection of a fundamental, hyperspatial flow of an ether (or ZPE flux).... Precessional motion may be the method to manifest the largest ZPE coherence. DePalma (1973) observed a direct gravitational and inertial anomaly in his experiments involving forced precession of a counter-rotating pair of gyroscopes.³⁹

Sonoluminescence regularly displays this bluish light when harmonically resonant acoustic waves cavitate water molecules. Moreover, recent research suggests that emissions of photons during sonoluminescence are "far too rapid for the fastest atomic electron transitions" but rather represent a "10¹¹ amplification of energy."⁴⁰ This suggests anomalous energy amplification, indicating that resonant acoustic interaction with substances somehow taps and coheres the ZPE flux. Another method

³⁶ Ibid., p. 19.

³⁷ Ibid., pp. 18, 19.

³⁸ The famous Austrian naturalist and physicist who was supposedly involved in creating vortex engines for the alleged Nazi flying disc secret weapons program.

³⁹ King, op. cit.,pp. 39-40.

⁴⁰ Ibid., p. 33.

The Giza Death Star Deployed

suggested is to twist the lattice structure of a crystal abruptly by alternating magnetic fields.⁴¹

The basis of these suggestions lies in a version of quantum mechanics known as stochastic electrodynamic theory. For our purposes it is important to note that this theory holds that the energy density is stored in space at any given point is related to frequency. "There is only one functional form that fulfills this postulate, and that is the energy density must be proportional to the frequency cubed. The function's scaling constant is related to Planck's constant which (sic.) completely specifies the description of the ZPE spectrum"⁴² The problem is that this theory leads to an energy density at every point in space that is infinite. Physicists "solve" this problem by using a scheme called "renormalization," a fancy word for an accounting trick that simply tosses out the infinities.⁴³

The physicist Wheeler proffered his own theory to account for this problem, a theory called "geometrodynamics" that attempted to reconcile quantum mechanics and General Relativity. The result was that random ZPE fluctuations enter and leave our three dimensional space via a hyper-dimensional structure called "wormholes," the "black holes" so popular in modern physical theory.⁴⁴

The infinities nevertheless will not go away, but the anomalous experiments are there, indicating that the ZPE exists. There is consequently a massive problem in theoretical physics. As King notes,

At the heart of the issue is a paradigm conflict. Most scientists were taught that the vacuum is an empty void, yet quantum theory concludes it's (sic.) an energetic plenum. It can't be both ways. The conflict has given rise to many paradigm "camps" each with its own characteristic belief regarding the vacuum energy:

1. Quantum physics is wrong. Quantum events can be explained classically using self-field. ZPE does not exist.
2. Relativity is wrong. A material-like ether exists.

⁴¹Ibid., p. 58.

⁴²Ibid., p. 97, emphasis added.

⁴³Note again the dominance of the mathematical model in determining what might really be the case. The "accounting trick" is nevertheless necessary in order to make the theory itself practically useful.

⁴⁴Ibid., p. 98.

⁴⁵The most recent attempt to resolve it, of course, is the monstrously complex twenty-six dimensions of string theory.

Cohering the Zero Point, Vacuum Energy Flux

3. Quantum physics is correct, but the ZPE is a theoretical artifact; it is not real.
4. The ZPE physically exists, but its magnitude is too small to be an appreciable energy source.
5. The ZPE physically manifests large energetic fluctuations, but they cannot be tapped because of entropy; they are random and ubiquitous like a uniform heat bath.
6. The ZPE is a manifestation of chaos in an open nonlinear system. Under certain conditions it can exhibit self-organization and therefore become available as a source.
7. The ZPE is a 3-space manifestation of electric flux from a physically real, fourth dimension of space. It can be twisted into our 3-space yielding alterations in the space-time metric. It can be tapped as a source, and doing so locally alters gravity, inertia, and the pace of time.⁴⁶

The Russian physicist Akimov has extended and experimentally researched paradigms 6 and 7 by positing a basic quasi-particle that he calls the Phyton, a particle the size of the Planck length, exhibiting two counter-rotating spins "as if it were a pair of particles superimposed within one another."⁴⁷

On the basis of his survey of the literature and experiments on ZPE coherence, King derives the following principles for cohering the ZPE flux:

1. Drive the system into a far from equilibrium state, typically with an abrupt electrical discharge....
 - As was noted in the previous chapter, the Transmitter-Receiver system as posited for the Great Pyramid Weapon existed in precisely such a non-equilibrium, non 1:1 ratio. We have further posited such abrupt electrical impulse as the method by which its discharge was achieved.
2. Work with a nonlinear system.... A component containing plasma or corona can make the system nonlinear.
 - As was argued by Christopher Dunn in *The Giza Power Plant*, there is strong evidence that the Great Pyramid once contained hydrogen plasma in a highly radioactive, and

⁴⁶ Ibid., pp. 124-125.

⁴⁷ Ibid., pp. 130-131.

The Giza Death Star Deployed

therefore probably ion acoustic mode. Moreover, limestone and granite are non-linear materials.

3. Accelerate those particles that maximize their vacuum polarization interaction with the ZPE. These are typically nuclei or ions.
 - As mentioned above, this plasma may have existed in ion-acoustic mode, the mode that, with proper control of other parameters, would most cohere the ZPE flux into the target.
4. Surround the ZPE coupling component with abrupt electromagnetic field compression and release....(by creating) bucking field conditions.
 - The compression and release was possibly accomplished by the constant resonance of the Pyramid to the Schumann resonance, alternatively stressing and releasing the quartz of the granite and limestone in the structure, and possibly inducing a kind of "virtual lattice twisting".
5. Use counter-rotation for spinning systems.... (Precession)
 - The Pyramid's coupling to the precession of the equinoxes is well known, and possibly indicates an element of ZPE coherence at the macro-level of the solar and galactic systems, for it was posited in The Giza Death Star that macro-systems appeared to have been rendered in terms of some quantum state by the Pyramid's engineering, and vice versa, that micro systems were understood to be miniature representations of macro-systems. Moreover as was seen in chapter four, and as will be further explored in chapter nine, the whole complex appears to be designed to exist in a state of "virtual" rotation, the basic elements of which exhibit a tetrahedral physics of hyperdimensionality.
6. Create vortical forms....
 - As above.
7. Mimic pair production....

Cohering the Zero Point, Vacuum Energy Flux

8. Use high voltage to stress and polarize the vacuum....Tesla coils can do likewise...Couple their energy to the system.⁴⁸
- As was seen in The Giza Death Star and as will be explored in the next chapter, the Great Pyramid contains some of the essential elements of Tesla's Direct Current Impulse Magnifying Transformers, and as is evident from this and the previous chapter, contains astonishing elements of the necessary properties of scalar weaponry: non-linear materials, crystalline structure, and overall isotropy.

To summarize this and the previous chapter, the extensive use of nonlinear materials - granite, limestone, and plasma - in the structure are strong indicators that the structure was designed as a massive machine to cohere the ZPE flux and direct it via scalar harmonic interferometry to target.

C. Scalar Physics and Paleophysics: A Comparison of Principles

A simple comparison of the principles of scalar electromagnetics and the principles of "paleophysics" outlined in my previous book The Giza Death Star is now in order.

Scalar Physics

Recursive wave functions form the basic type of translational action. Scalar waves propagate back to a source of electromagnetic radiation at faster-than-light velocities and their force is not limited by normal inverse square relations.

Infolded multi-vector zero-summed systems constitute the "information in the field" of various systems.

The medium is dynamic and can

Paleophysics

The cosmos is viewed as a vast system of interlocking dynamic systems, existing in various states of opposing forces: Yin and Yang, etc.

"Mind" gives rise to all things, connoting the presence within the medium of intelligent and intelligible information.

The medium is dynamic and does

⁴⁸ Ibid., pp. 183-184.

The Giza Death Star Deployed

and does interact with the observable world via stresses placed upon it.

The basis of scalar physics is interferometry, implying a fundamentally harmonic view of physical reality.

Scalar physics is weaponizable, and can create weapons of mass destruction capable of acting over tremendous (interplanetary?) distances and over large regions and potentially on a planetary scale. Such weapons are essentially "mirrors" which read the harmonic signature of targets and reflect a harmonically resonant scalar potential back upon them.

interact with the observable world, giving rise to various bodies by the variety of their motions.

Physical reality is fundamentally unified via motion, and therefore, via harmonics.

Ancient traditions speak of "Yin-Yang" mirrors and other sophisticated weapons capable of large scale devastation. They also allude to interplanetary wars.

Such a comparison would not be complete, however, without a detailed comparison of the actual known necessary components of scalar devices and the known properties of the Giza Death Star.

Cohering the Zero Point, Vacuum Energy Flux

D. A Comparison of Scalar-Plasma Physics and Known Properties of the Great Pyramid

Scalar Physics

Phased radar arrays and knowledge of microwave radiation properties is a necessary component of scalar weapons.

Cohered output of a high voltage impulse on non-linear materials appears necessary to achieve the wave-mixing effect needed to create a scalar impulse wave.

Scalar devices would produce strong local gravitational and inertial anomalies, including the warping of spacetime and the bending of light.

Scalar effects are best achieved in earth resonance, but on isotropic mediums, which the earth is not.

Tesla noted that the impulse effect was increased with plasma arcs and antennae whose dimensions were harmonically resonant to the element from which it was composed.

Great Pyramid

The Great Pyramid architecturally resembles modern phased radar arrays, and its four faces appear to be parabolic reflectors.

The Coffin is designed as the optical cavity of a maser, and is moreover designed of highly nonlinear granite with highly piezoelectrical properties.

The Great Pyramid reportedly produced such anomalies when fully functional, according to the ancient texts cited by Sitchin.

The Great Pyramid is in resonance with the Schumann resonance of the earth, and moreover is so engineered to be crystalline and isotropic in its overall chemical composition and geometry. It is an isotropic structure par excellence.

The Great Pyramid employed a hydrogen plasma electrically pinched in ion-acoustic mode of resonance, and its stone courses appear to be geometric analogs of the atomic weights of some of the elements.

The Giza Death Star Deployed

Two things must be added as a final aside. Pyramid researchers have long noted that the simple geometry of the Pyramid itself when reproduced in scale models, appears to resonate with the "life energy" of living things. Meats and fruits placed inside such scale model "Great Pyramids" have been reported not to putrify. Colonel Bearden has also noted, in numerous other papers and books on scalar physics, that the Soviets made great strides in the connection between scalar electromagnetics and biological processes. Whether such reports are true or not remains to be seen. Certainly efforts to reproduce "pyramid energy" experiments have not been universally successful. As yet unknown factors may play a role in the reasons for the alternating failures and successes of these experiments.

However, a second, grimmer, reminder of the Great Pyramid's ultimate purpose comes from World War Two. Then, with the full fury of Rommel's Afrika Korps bearing down on them, British and other Allied bomber pilots were issued a stern order about the mute pile of limestone and granite standing on the Giza plateau. They were ordered not to fly over it at certain altitudes. The reason?

If they did, all their electrical systems would inexplicably go haywire, if not fail completely.⁴⁹

⁴⁹ G. Patrick Flanagan, *Pyramid Power: The Millenium Science* (Anchorage: Earthpulse Press, 1997), p.p. 25-26.

CONFIGURING THE SCALAR IMPULSE WAVE: THE INTEGRATED ENGINEERING OF THE GIZA DEATH STAR

"Electrical capacity is to gravity, as inductance is to magnetism."
Michael Faraday

"Commence primary ignition."
Faceless Voice, initiating activation of the Death Star, Star Wars

On September 22, 1940, with Adolf Hitler's armies astride Western Europe, the Luftwaffe raining bombs on England, and German U-boats sinking England's oceanic lifeblood at a hemorrhagic rate, a curious article appeared in The New York Times. It is directly relevant to information already considered in this book, and to be considered more fully here.

The anonymous author of the article began by noting that Nikola Tesla, then 84 years old, told him that he would divulge to the United States government the secret of a new field of force, which Tesla called his "teleforce," capable of melting airplane motors at a distance of 250 miles. The author presumably does not consider that if the motor could be melted at such a distance, so could the entire airplane!

In any case, he goes on to explain the nature of Tesla's "teleforce," presumably learned from a personal interview, since the writer of the article knew "Mr. Tesla for many years:"

This "teleforce" is based on an entirely new principle of physics that "no one has ever dreamed about", different from the principles embodied in his inventions relating to the transmission of electrical power from a distance, for which he has received a number of basic patents. This new type of force, Mr. Tesla said, would operate through a beam one-hundred-millionth of a square centimeter in diameter, and could be generated from special plant (sic.) that would cost no more than (sic.) \$2,000,000 and would take only about three months to construct.

....The beam would melt any engine, whether diesel or gasoline driven, and would also ignite the explosives aboard any bomber.

....The beam, he states, involves four new inventions, two of which have already been tested. One of these is a method and apparatus...eliminating the need for a "high vacuum"; a second is a process for producing "very good

The Giza Death Star Deployed

electrical force"; third is a method of amplifying this force; and the fourth is a new method for producing "a tremendous repelling electrical force". This would be the projector, or gun of the system. The voltage for propelling the beam to its objective, according to its objective, according to the inventor, will attain a potential of 80,000,000 volts.¹

The resemblance of published diagrams of Tesla's "death ray" does indeed bear a striking resemblance to those of famous Jesuit scientist Athanasius Kircher's pictures of Archimedes' mirror, discussed previously.

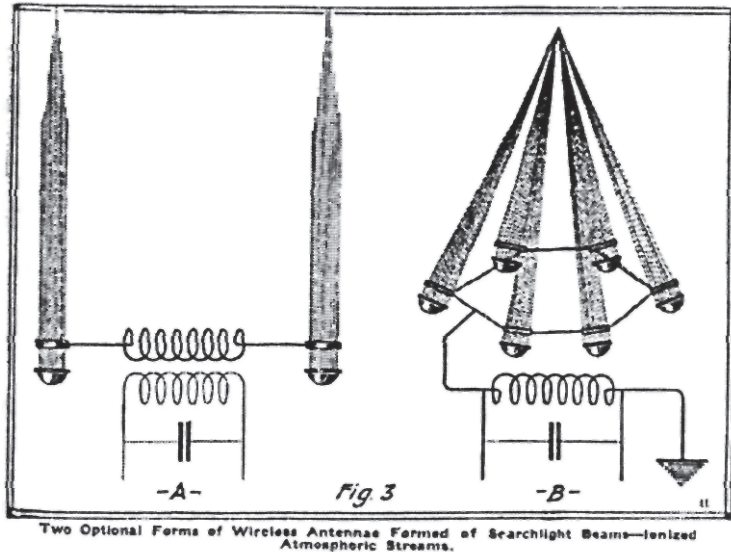

Tesla's "Death Ray"

¹ "Tesla's 'Teleforce' Defensive Beam Against Air Attack," The New York Times, Sept. 22, 1940, no page number given; cited in Nexus, January-February 2002, p. 41.

Configuring the Scalar Impulse Wave

Once again, one notes the theme of interfering or focussing several beams on a target.

Sudden high voltage direct current impulse against a resistance barrier is the essential parameter uniting and unifying several distinct physical phenomena, and affords the easiest entry into any attempt to back-engineer the Giza Death Star and reconstruct the underlying theoretical model of the physics that made it possible. With this point of departure the functions of the following various components, chambers, and dimensions of the Great Pyramid are inferred and will be outlined in this chapter:

- The Queen's Chamber: Hydrogen Gas Generation
- The Grand Gallery: Gravito-Acoustic Infrasound Generation and Amplification
- The Antechamber: Infrasonic Baffle
- The King's Chamber: Tertiary Tesla Coil, Plasma Pinching, Harmonic Piezoelectric Stressing and Acoustic Amplification
- The Coffin: Cohered Optical Cavity
- The Stone Courses: Coil Windings, Crystal Lattice Structure, Periodic Atomic Weight Resonance
- The Parabolic Faces: Focus and Collection of Base Stellar and Galactic Systems' Waves
- The Apothem: "Virtual Leads"
- The Missing Apex Crystal: Dielectric Antenna
- The Selection of Calcium Carbonate (Limestone) Casing Stones
- Nested Feedback Loops as "Virtual Coil Windings" and Geometric Amplification

It is to be stressed that the comparisons, inferences, and speculations contained in this chapter are just that: comparisons, inferences, and speculations. They are further elaborations of a hypothesis, not the statements of empirically grounded or rigorously tested theory, concerning the Great Pyramid.

The Giza Death Star Deployed

Part One: Foundational Concepts

A. The Tesla Direct Current Magnifying Impulse Transformer

Engineer Eric Dollard is unique in having successfully reproduced Dr. Nikola Tesla's direct current electrostatic impulse technology and its anomalous results. His work will be extensively cited without commentary, with commentary following.

We begin, then, with Dollard's exposition of the Tesla Direct Current Magnifying Impulse Transformer:

"At the turn of the century Tesla was in the process of devising a means of wireless power transmission. The transmission involved the generation of longitudinal ether waves.... [1] Tesla claims that the waves from his transformer propagate at $\pi/2$ the velocity of light. It is interesting to note that the velocity measure on the Tesla coil is also $\pi/2$ greater than the velocity of light but this does appear to be a phase velocity rather than a group velocity.

"In his writings Tesla indicates some seemingly impossible phenomena surround the emanations from the spherical terminal capacity, and I have determined this to be true by experiment. One is that the power gradient (Poynting vector) is in the same axis as the dielectric flux gradient. The other is the slow formation of a conductive area surrounding the sphere that is not ionic in nature (in other words is not a spark or glow discharge).

"Contrary to popular belief, the Tesla transformer is not a steady state device but is a magnifier of transient phenomena. Also it does not behave like a ... (L.C. network) nor a transmission line, [2] but more like a unique type of wave guide. If all parts of the system are designed properly the (electromotive force) and hence [3] dielectric flux jumps from zero to an enormous value almost instantaneously, thereby producing an almost inconceivable displacement current into space. The transformer is then basically a device for rapidly discharging the capacitor bank nearly instantly into free space, producing an enormous dielectric shock wave similar to a sonic boom.

"Because the dissipation of the transformer is for all practical purposes negligible, the energy keeps increasing at a linear rate per cycle of oscillation, thereby accumulating a gigantic quantity of electrical energy. ([4] A form of laser action may be possible.)

"[5] In order for the transformer to resonate with the planet the energy storage in the active region that grows around the sphere terminal must equal the conjugate energy storage of the earth, a stiff requirement.

"It is interesting to note that dielectric breakdown in this active region grow (sic.) into a log periodic form based on $x^2 - x = 1$ as the log base. [6] This will be recognized as the transcendental (sic.) PHI or Golden Ratio. [7] In glow discharges the ions of metallic elements form stable spheres of diameter inverse to the atomic weight of the element involved

Configuring the Scalar Impulse Wave

"The transformer's principals (sic.) of operation are as follows: "[8] The first requirement is the sudden collapse of an energy field thereby producing a sudden impulse of energy, second is the transforming properties of the odd harmonic order single wire delay line (coil) which allow for the production of enormous (electromotive force) and (magnetic motive force), and third, the dielectric phenomena surrounding the free space capacity terminal."²

The following implications emerge from this abstract:

- (1) The superluminal velocity of the energy impulse itself was a conclusion that Tesla drew from observation and inference, since there does not yet exist a viable way to measure one-way propagation of light and presumably of superluminal phenomena. Tesla's reasoning was that since the force propagated by the impulse did not diminish in accordance with the inverse square law, it may be inferred that it was a form of "time reversed" and hence superluminal wave.
- (2) It will be recalled from descriptions of this transformer given in The Giza Death Star that the discharged impulse was not conducted through the coils, but "aerodynamically" over the surface of the coils. Hence, the coils may be viewed as types of "virtual crystals" or "electric lenses", or, as Dollard puts it, "wave guides." This point becomes important in subsequent considerations.
- (3) Tesla's initial transformer was no taller than a child and produced massive shock waves. His subsequent famous experiments with a much larger version of this device in Colorado Springs produced lightening displays and shock waves visible and felt miles away. It stands to reason that if the Great Pyramid incorporated similar design features for a similar purpose, that its discharged impulse would be that much greater.
- (4) While Dollard does not indicate the basis of his statement that "a form of laser action may be possible" it is relatively easy to infer why he might say this. The lack of inverse square energy dissipation effects in the impulse indicate a phenomenon exhibiting a tendency toward coherence properties, if not outright coherence itself. The harmonic nature of the transformer suggests that

² Eric Dollard, *Condensed Introduction to Tesla Transformers* (Eureka, California: Borderland Sciences, 1986), pp. 1-2, 5, emphasis added.

The Giza Death Star Deployed

coherence of the phenomenon may be harmonically derived in some fashion.

- (5) It is highly significant that the Tesla impulse magnifying transformer must be resonant to the energy of the earth. The Great Pyramid is resonant to the mass and thermal gradients of the earth and, as is well known, incorporates harmonics of various terrestrial and celestial geometries in various dimensional measures of the structure. In short, the Tesla transformer and the Great Pyramid both appear to be electro-harmonic coupled oscillators to the earth.
- (6) The log periodic growth of the energy buildup in the conductive "corona" around the transformer according to the PHI ratio strongly suggests that the presence of the same number in the Great Pyramid has the functional purpose of achieving the same energy buildup, though of course on a much more massive scale.
- (7) The inverse diameter relationship of the ionic sphere (of whatever element has been chosen as the dielectric) to the atomic weight of that dielectric element suggests a relationship between the lattice structure of the elements themselves and the harmonics of the impulse waveform. This suggests that radioactivity and electric impulse are related phenomena, and that radioactivity is not an inherent property of closed systems as in the conventional view, but an interactive phenomenon of open systems, namely, electric impulse and various elements. In order for the Great Pyramid to have functioned as a weapons system in the manner hypothesized in The Giza Death Star, this suggests that there be some analog to the atomic weights of the elements in the dimensions of the structure itself in order for it to achieve resonance with the presence of such elements in a target region, as was seen in chapter six.
- (8) The requirement of a very sudden field collapse in order to produce the longitudinal electric impulse wave suggests that a curious and surreal "darkening" would occur in the region of the device during discharge. This same phenomenon may be seen on films of nuclear explosions as the field collapses and space itself is sucked into a vortex, and was attested by Tesla himself. As will be shown subsequently, others working with different aspects of the impulse phenomenon also record similar darkening effects associated with field collapse.

Configuring the Scalar Impulse Wave

Dollard then makes a significant statement concerning the field gradient of the electric potential of the device: "It would seem possible (for) the gradient to continue to increase beyond the dielectric terminal." In that instance the electro-motive force "also becomes greater farther from the terminal, possibly reaching astronomical proportions."³ In other words, great potential can be built up in a target region simply by the transmitter's distance from it. Potential becomes a function of distance from the dielectric terminal or antenna. Obviously, this makes it entirely feasible that it could have had interplanetary uses.

Considered as a system, the Tesla impulse magnifying transformer

"can be divided into FIVE distinct components:

- 1) EARTH
- 2) REFLECTING CAPACITANCE
- 3) ENERGY TRANSFORMER
- 4) COUPLING TRANSFORMER
- 5) RESONANT COIL."⁴

Elsewhere Dollard is more specific:

"It is quite possible that the magnetic gradient and force will increase as the wave penetrates the earth. Hence the 5 sections of the Tesla transformer:

1. Earth
2. Primary system/power supply
3. Secondary wave coil
4. Tesla or magnification coil
5. Dielectric antenna."⁵

This catalogue of systems components now permits a schematic comparison of the Great Pyramid and a Tesla Magnifying Transformer, utilizing an adaptation of Dollard's schematic of the latter, and Dunn's schematic of the former.

³Dollard, op. cit., p. 10, emphasis added.

⁴Dollard, Theory of Wireless Power (Eureka, California: Borderland Sciences, 1986), p. 7.

⁵Dollard, Condensed Introduction, p. 11.

The Giza Death Star Deployed

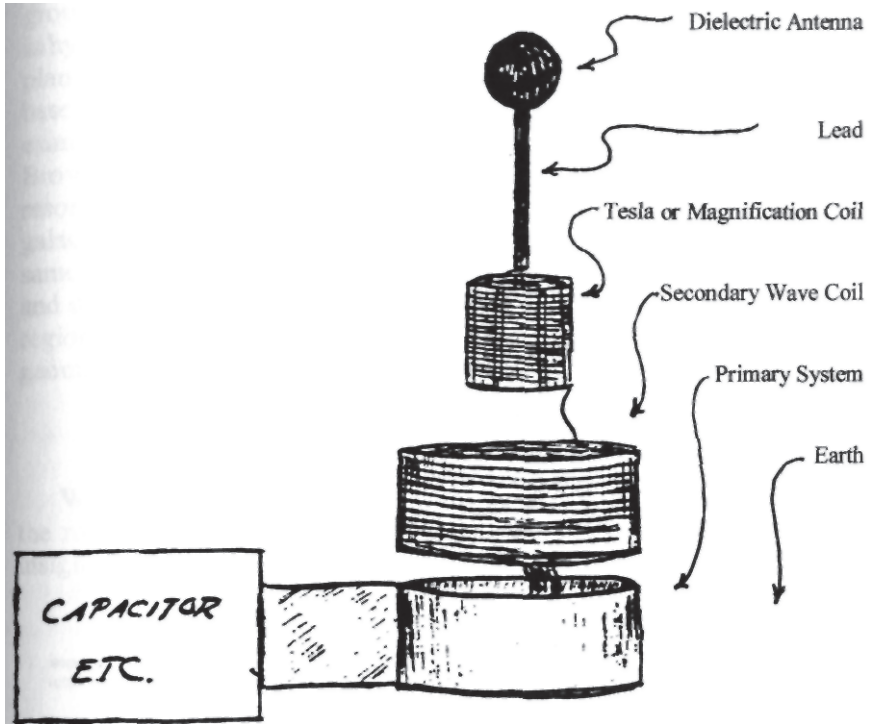

Figure 1a:
Modified Version of Dollard's Schematic of a Tesla Magnifying Transformer

Configuring the Scalar Impulse Wave

Apex: Cubed Sphere 1/100th
the dimensions of the whole structure

Lead: The Apothem of the Parabolic
Faces

Tesla or Magnification Coil:
King's Chamber

Secondary Wave Coil: Stone Courses
Minus the Bottom Course

Primary System: Bottom Stone Course And
The Base Systems (Earth, Solar and Galactic
Systems)

Earth

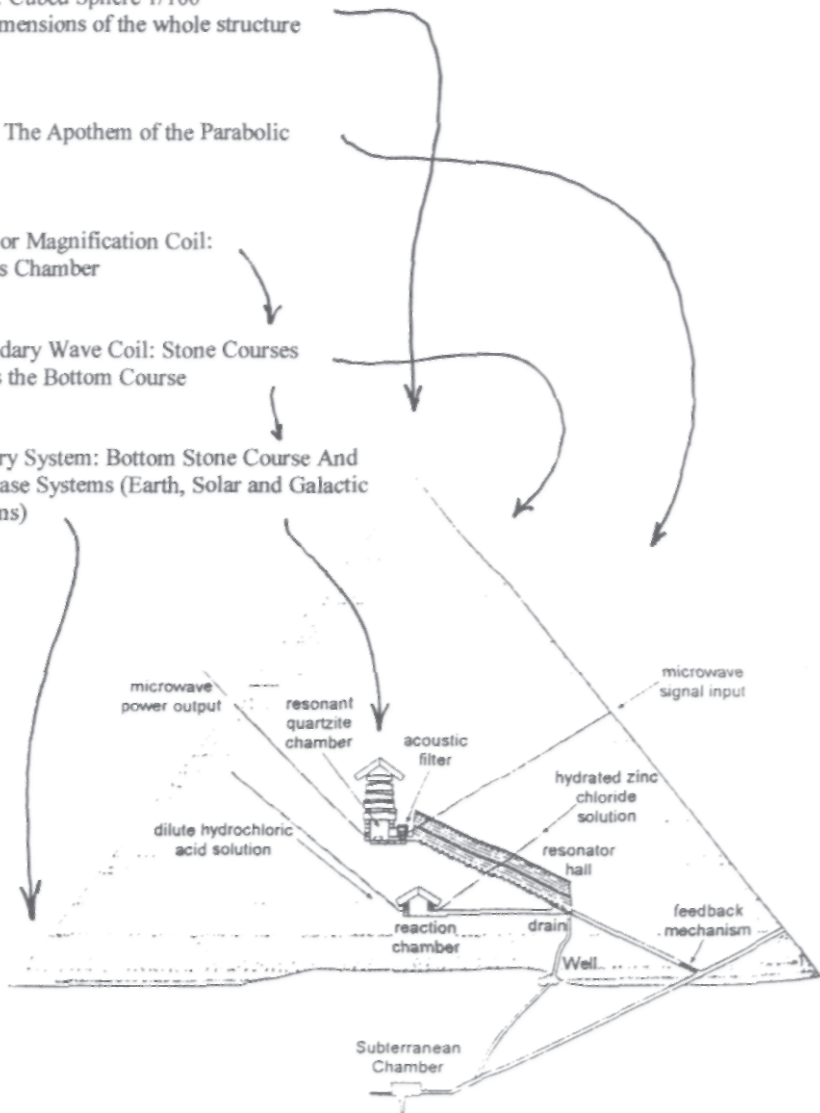

Figure 1b: Christopher Dunn's Schematic Cut-Away of the Great Pyramid

The Giza Death Star Deployed

Significant differences should be noted. While the Tesla transformer is grounded to earth (Tesla called it "resonant to earth"), the Great Pyramid is hypothesized to be grounded, or resonant, not only to the earth (the base planetary system) but also to the sun and galactic center (base stellar and base galactic systems). We shall see momentarily why this is so by examining the electro-gravitational work of Dr. Thomas Townsend Brown. In other words, the geometry of the Pyramid, while primarily resonant to terrestrial geometries, is also coupled to those of the solar and galactic systems, utilizing the same superluminal wave form to access the same inertio-mechanical, or "gravito-acoustic" energies that it amplifies and discharges. As was outlined in chapter 5, if it is to oscillate any target region anywhere in nearby space it must also be an analog of their geometries.

(1) Virtual Grounds

Why this is so may not be readily apparent without a consideration of the role of the "ground" in the Tesla magnifying transformer. Dollard's insights here are crucial and fundamental:

"Because the energy is propagated (through) the 'ground' the question exists as to how to ground the apparatus, that is, how to establish an electric reference point, since the so called ground is not the hot terminal of the transponders, and therefore is incapable of also serving as an electric reference point. Here exists the singular feature of the Tesla...transformer in that the distributed mutual inductance and odd function resonance work to establish a virtual ground. ... The principle behind this is the geometrical reconfiguration of the fundamental components of energy, the kinetic and potential, this reconfiguration resulting in the separation of cause and effect in not only time but also in space.⁶

The implications are enormous.

What is normally called the "ground" in electrical circuit schematics -as in the previous schematics - is the earth, and the antenna is space. Tesla's impulse technology simply inverted this relationship. The "ground" became the geometric configuration of space. And the "antenna " became the earth.

⁶ Dollard, Theory of Wireless Power, p. 11.

Configuring the Scalar Impulse Wave

(2) And the Base Planetary, Stellar, and Galactic Systems

Taking this process one step further, it is conceivable that the Great Pyramid - by dint of some functions of its hypothesized missing components - may have been able to reconfigure its ground and antenna relationships by inverting them, depending upon where in local space a target was located and what effect it was desired to achieve in the target. That is, for some targeted regions, earth may have indeed been selected for the ground, and space for the antenna, or vice versa. The parameter of "virtual grounds" also opens up other implications such as virtual cathodes and virtual anodes that will assume great importance when the matter of the containment of the hypothesized hydrogen plasma in the Pyramid is addressed.

(3) Coupling of Three Types of Standing Waves

The superluminal velocity and chargeless nature of the impulse given off by the Tesla magnifying transmitter are not subject to inverse square dissipation laws. As Dollard avers, the effect can actually grow with distance from the impulsing source itself, establishing a longitudinal compression wave not only in space and in time, but also, since it is superluminal, it accesses space-time compressions best viewed as hyper-relativistic or "extra-dimensional;"

"It can be seen that the (Tesla Magnifying Transformer) involves three distinct standing waves in its operation, each coupled to the other (through) two points of refraction. Each of these standing waves represents a distinct dimensional aspect:

- 1) EARTH WAVE; SPACE DIMENSIONAL
- 2) INTER TRANSFORMER; TIME DIMENSIONAL
- 3) RESONANT COIL; EXTRA DIMENSIONAL.

The analogous relations in musical representation are:

- 1) HARMONY; SPACE DIMENSIONAL
- 2) RHYTHM; TIME DIMENSIONAL
- 3) MELODY; EXTRA DIMENSIONAL

In order for mis triple resonant, or sextic (sic.) energy transient to operate in consonant resonance, conjugate relation must be made to exist between all six energies. Unfortunately, very little theoretical knowledge exists for transients of more than double energy. This is primarily due to the limited understanding of

The Giza Death Star Deployed

the science of algebra with regard to the solutions of equations of higher than second degree."⁷

The extremely high degree of integration of these and other principles in the structure and dimensions of the Great Pyramid strongly suggests that its builders had found some method whereby to solve these higher order equations, and that such a method might be reconstructed from careful study of the structure.

B. Thomas Townsend Brown and the Stages of Dielectric Displacement

Thomas Townsend Brown pioneered a little known area of research called electro-gravitics and played a prominent role in the initial planning and design stages of the Philadelphia Experiment to make a ship invisible.⁸ His patents for electro-gravitic devices are a matter of public record both in England and the United States. They grew from his exploration of a phenomenon familiar to anyone who has worked with cathode ray tubes or toy train transformers. Like Tesla's own transformer, Brown's electrogravitic devices grew from the observation of and further experimentation with sudden, high voltage electrical impulses. If a cathode tube is suddenly and energetically switched on, the tube will jerk toward the direction of its positive pole. Electric energy is suddenly converted to kinetic motion. The phenomenon persists only as long as the impulse, and the tube returns to its rest state just as quickly as it jumped from it. A series of such repeated impulses, Brown reasoned, might conceivably be used as a method of propulsion.

Reasoning that continued impulses of a capacitor could prevent the return to its rest state, Brown constructed a series of experiments as a young man in his garage laboratory. On the basis of his observations, Brown, like Tesla, hypothesized that there was a "form of radiation quite different to the transverse electromagnetic wave. He called it 'radiant energy' and thought that it was present throughout the Universe and was gravitational in nature, but as yet was invisible to instruments."⁹ Physicists

⁷ Dollard, *Theory of Wireless Power*, p. 14.

⁸ For the best introduction to Brown's discoveries and how he became to be involved in the alleged Philadelphia Experiment, cf. Gerry Vassilatos, *Lost Science* (Kempton, Illinois: Adventures Unlimited Press, 1999), pp. 225-281.

⁹ Gavin Dingley, "ParaSETI: ET Contact Via Subtle Energies," *Nexus*, Col 8, No 1, January-February 2001 37-43, p. 40.

Configuring the Scalar Impulse Wave

at Brown's local CalTech rejected his ideas, since it would have meant that gravity was bipolar, repelling as well as attracting.¹⁰

Initially rejected by university physicists, he came to Kenyon College in Ohio and to the attention of a classmate and friend of Albert Einstein, Dr. Paul Biefeld. Biefeld was captivated by the experiments, and made laboratory space and resources available for more refined versions of the experiments.

"With the new instrumentation and enhanced laboratory access, several details in his strange electric force now became apparent. In 1924, he mounted two spheres of lead on a glass rod and suspended them by two strong insulating supports, forming a swing-like pendulum. When each sphere was oppositely and highly charged with sudden impulses of 120 Kilovolts the entire pendulum swung sideways to a maximum point...and very slowly came back to rest. The electropositive sphere led the motion once again.

"What Tom now saw was truly astonishing. The pendulum literally remained suspended in the space for a long time. There were two clearly observable phases in the whole action. The 'excitation phase' took less than five seconds. The 'relaxation phase' required thirty to eighty seconds, coming back to rest [1] in a series of fixed steps."¹¹

Brown's explanation relied upon Einstein's General Theory of Relativity, which posited space-warping capabilities to large masses exerting enormous gravitational force on the surrounding region of space. The theory further implied a link between electromagnetism and gravity. Brown reasoned that "if gravitation was truly the result of a distorted space then high voltage electric shock was somehow further modifying that distortion."¹²

At this juncture, it is necessary to say a few brief things about how General Relativity models gravity. As was seen in chapter 7, General Relativity models gravity as a geometric warp or "bubble" in space time. The concept may be easily conceived by imagining a trampoline on which a bowling ball or other heavy object has been placed. The trampoline surface itself would represent space-time (though only in two, and not four, dimensions), and the bowling ball would represent the distorting influence of a large mass. Note that the bowling ball is a three dimensional object exercising a warping influence on a two dimensional surface. From

¹⁰ Ibid.

¹¹ Vassilatos, op. cit., p. 246.

¹² Ibid.

The Giza Death Star Deployed

the standpoint of a "flatlander" living on the surface of the trampoline, the bowling ball represents also a hyperdimensional object to his two-dimensionally habituated senses. It might thus also appear to our trampoline flatlander that the bowling ball is loading energy into the system, i.e., the surface of the trampoline, from outside. This energy the flatlander records as the tension (a physicist would call it potential) evident in the surface of the trampoline; the closer he walked (or perhaps, slithered) to the bowling ball, the more this tension or energy would increase. Suddenly removing the bowling ball would demonstrate the presence of this energy, for the trampoline would suddenly snap back to its rest state, to the chagrin of the flatlander. In General Relativity, gravity is very much like the bowling ball of our example, for Einstein modeled gravity as a wave of energy traveling in five, not three, dimensions. This leads us back to Dr. T.T. Brown.

Biefeld quickly steered Brown to a series of articles in various scientific journals of the day that recorded experiments where mass was lost in highly charged objects. After all, Michael Faraday himself was aware of the connection: "Electrical capacity is to gravity, as inductance is to magnetism." This led Brown to a further hypothesis: the missing mass was in the distorted space surrounding the electro-statically impulsed and displaced object.¹³ In this Brown was exploring the further implications of the breakdown and inversion of concepts of cause and effect Dollard discovered while experimenting with Tesla's version of electro-impulse technology. In Brown's case, the relativistic order is inverted: mass does not create distorted space, but distorted space - non-equilibrium conditions - creates mass. Thrust is therefore provided not by crude thermodynamic processes of action-reaction, but merely by distorting space through high voltage impulse on a dielectric. Once the space was distorted, the positively charged mass moved into it, and stayed there -apparently defying gravity - until the space distortion itself dissipated.

Subsequent experiments with improved capacitors clarified the laws he was uncovering.

"He found that longer impulse durations required longer relaxation times. Greater dielectric mass in the capacitors amplified the thrusts. Increased voltages amplified the thrust. He also verified that electric current had nothing to do with the distortion of space at all. Tom estimated the current in these

¹³Vassilatos, op. cit., pp. 246-247.

Configuring the Scalar Impulse Wave

gravitator cells at 3.7 microamps, virtually a 'zero' value. It was the electrostatic impulse which effected the space 'warp.'... Once the gravitator had absorbed the distortion, it stopped accelerating. No amount of additionally applied voltage had any motional effect on the gravitator after this point... Space dynamically interacted in the dielectric with the electrostatic shock."¹⁴

That is, Brown discovered what Eric Dollard was subsequently to discover: that the dielectric functioned as a wave guide, interacting with space itself; only the purpose or use to which Brown put it was put was different. Brown further discovered that the effect was also dependent upon the material composition of the dielectric itself. Thus, the chemical element, the electrostatic impulse, and spatial geometry exist as a complex of interrelationships in such impulse technologies.

Specifically, Brown discovered that these strange electrical "mass translations" were only detectable if:

- 1) The K-factor of the dielectric (its ability to store energy) was high (in the order of 2,000 or more);
- 2) The density of the dielectric was high (in the order of 10 g/cm³ or more);
- 3) The applied voltage across the capacitors was high (in the 100,000 V range).¹⁵

This leads immediately to a consideration of Brown's most profound discovery:

"While working with the gravitator, Dr. Brown discovered that its behavior as a pendulum varied literally 'with the phases of the moon.' In addition, there were startling effects which the sun evidently impressed on the gravitator during its charge-discharge cycles. Whether solar or lunar, it was clear that natural gravitational field conditions were observably affecting local space conditions right before his eyes. The peak maxima and minima of the gravitator varied so much during full moon phases, that he was able to chart the performance against the celestial activities with great precision. After acquiring so much data, he was able to predict what celestial conditions were occurring without visually sighting them. This is when the military became intrigued with his work....

"The gravitator rises during the electrostatic excitation pulse, doing so rather rapidly and discontinuously. When carefully observed, the 'rise' phase consists of several 'graded steps.' Once through this 'stepped rise', the gravitator appears to be in a fluidic channel while suspended at an angle. In this levitated position, the gravitator 'bobs' several times. After the Shockwave has

¹⁴ Vassilatos, op. cit., pp. 247, 248.

¹⁵ Dingley, op. cit., p. 41.

The Giza Death Star Deployed

saturated its dielectric thoroughly, the gravitator begins its lengthy 'fall' back to the rest point. Here, more than during the rise phase, one most clearly observes the 'rest steps' which last for several minutes.

"The discovery identified the number and position of spatially disposed 'rest steps' with the positions of sun and moon. In more refined optical examinations, one could even discern the effect of certain planetary configurations on the gravitator. These fixed space 'slots' became the most intriguing discovery since his original observation of the electrogravitic interaction."¹⁶

(1) As Quantized States?

In *The Giza Death Star* I pointed out certain approximate harmonics of Planck's constant were discovered in Pyramid analogs of the earth-moon gravitational neutral point, and posited that the physics and engineering of the Pyramid was based precisely on using such approximations as ways of rendering non-quantum, macro-sized systems in terms of some quantum state more typical of the atom and its electron cloud and its "shells." It is possible that Brown's gravitators are accessing precisely this phenomenon, expressed perhaps as spatial harmonics of the Planck length, and that its "rise" and "rest" steps or stages represent some form of scale invariant "quantum mechanics."

Intrigued by this discovery of the solar, lunar, and planetary gravitational effects on his gravitators, Brown was recruited by the Naval Research Laboratory and did highly classified research on gravity wave detection throughout the 1930s. Significantly, this research involved the refrigeration of his units, much like the later Soviet research involved the use of artificial sapphires cooled to near absolute zero and placed in a vacuum.

Brown's work on dielectrics and gravitational effects soon brought him to a consideration of the materials used in dielectrics. In fact, much of his work for the Navy in the late 1930s involved the investigation of the gravitational and dielectric properties of granite and basalt:

One of the characteristics of a dielectric is its resistivity - how good an insulator it is. If resistivity is not high enough, then the dielectric is rendered inefficient. This is usually a fixed value, but Brown found that the resistivity of some materials would change over time. In a classified naval report entitled "Anomalous Behaviour of massive High-K Dielectrics", Brown described how

¹⁶Vassilatos, op. cit., p. 251.

Configuring the Scalar Impulse Wave

the resistivity of some materials would alter and even follow sidereal diurnal changes. He also noted that some materials would generate spontaneous radiofrequency bursts whose amplitude was a function of the material's mass and K-factor. Also, he found many granitic and basaltic rocks to be electrically polarised; that is, they behaved like electric cells or batteries. These rocks would have as much as 700 mV across them, the amplitude of which would also change in sympathy with solar sidereal cycles. Again, the rock's sensitivity to such changes depended upon its K-factor and mass. It was this latter relation that suggested the phenomenon is gravitational.

During 1937 in Pennsylvania, a Navy-sponsored monitoring station was in operation to record such changes in the electrical self-potential of these rocks. It was noted that there was a strong correlation with the cycles of the moon, which added further support to the hypothesis that the effect is gravitational in nature.¹⁷

As if this were not enough, there was more, much more, and the attentive reader of the previous chapters will note the significance of the following remarks on Brown's scientific quarrying into the nature of the relationship of gravity and electricity:

From these investigations, it is clear that the phenomenon is gravitational in nature and that it manifests as high-frequency electricity. Brown concluded that the energy is in fact the radiant energy he had hypothesized while still at CalTech...constantly emitted from astronomical objects in outer space. While simple high-K dielectric materials would pick up the radiation and convert it directly into electrical energy, more complex dielectrics such as granitic and basaltic rock would convert the energy into DC electricity. Not only this, but these rocks are in fact tuned to only a portion of the total radiated energy present throughout the Universe. This means that your average lump of basalt is a natural gravity-wave AM receiver, tuned into only a few specific radio stations!¹⁸

Let us pause and note what is being said here:

- 1) High mass increases the efficiency of receiving gravitational energy and converting it to electromagnetic energy in the form of DC current;
- 2) A high capacitance also increases the efficiency of the effect;
- 3) High applied voltage across the capacitor also increases the efficiency of the effect;

¹⁷ Dingley, op. cit, p. 41.

¹⁸ Ibid., emphasis added.

The Giza Death Star Deployed

- 4) The effect is even detectable naturally in granitic and basaltic rocks;
- 5) The effect is variable over time as the geometric conditions of local space change; and finally,
- 6) In their natural state, granite and basalt are only tuned to a narrow band of frequencies of gravity waves.

Obviously, the Great Pyramid fulfills all the conditions that Brown observed, and massively so, save one: the sixth, for the peculiar construction of the Pyramid makes it apparent, as I have already argued, that its function was to collect and amplify the inertial harmonic "signature" of any possible receiver or target in local space.

Brown went further than this, filing a patent in 1953 describing the rudiments of a system for communication via "modulated gravitational radiation."¹⁹ This system involved simple modifications to a standard radio system's antenna. A coil is connected at its base to the output of a high power radio transmitter "so that the radiofrequency energy is end-fed." At the other end of the coil is a spherical electrically conducting body. This acts as "an isotropic capacitor, and so forms a tuned circuit with the coil."²⁰ The similarities to Tesla's basic system of wireless power transmission will be noted. Perhaps it is equally significant that Tesla, as most researchers into his Colorado Springs experiments are aware, claimed to have received extra-terrestrial communications with his own device.²¹

One should also note that Sitchin maintains that one of the primary functions of the Great Pyramid was as a communications device, and that the structure exhibited strong gravitational pull when fully operational.²² Dunn, of course, posits a "power plant" function in his version of the machine hypothesis. Could the Great Pyramid, in the light of all of this information, possibly have functioned as either a communications device or power plant? Since the same basic technology and configuration are involved in both Brown's and Tesla's version of the equipment, and given the similarities of the Pyramid in some respects to that equipment, the answer would seem to be "yes". At lower power output it could function

¹⁹ Ibid., p. 41.

²⁰ Ibid.

²¹ Ibid.

²² Cf. my Giza Death Star, p. 50.

Configuring the Scalar Impulse Wave

as either. But it is the Pyramid's over-engineering, its incorporation of analogues of the harmonic signal of any possible receiver, as well as its sheer size and mass, that would also seem to indicate that it was capable of a much more destructive use, and that such a usage was its intended purpose and function.

(2) The Space Warp, Quantized Macrosystems States, and the Philadelphia Experiment

Brown's involvement with the Philadelphia Experiment began with a rather unconventional extension of a very conventional technology: arc welding. The US Navy had constructed a highly classified facility for arc-welding armor-plated hulls. The difference between this facility and normal arc welding was simply its sheer size. The arc for the welds was provided by an enormous capacitor bank, and provided such a huge discharge that it was unsafe for the workers to remain inside the chamber when the welding was actually sparked since the enormous voltage released an intense bombardment of X-rays.

But strange phenomena were almost immediately observed in the new facility, and this prompted an official Navy investigation.

"Phenomena which have no reasonable explanation at all. Researchers examined the site, separately asked workmen to confirm the rumors they were hearing, and watched the process for themselves in the control booth.

"What they saw was truly unprecedented. With the electrical blast came an equally intense 'optical blackout'. The sudden shock of the intense electric weld impulse was indeed producing a mysterious optical blackening of perceptual space, an effect which was thought to be ocular in nature. This intense blackout was believed to be a result of.. .retinal bleaching, a chemical response of the eye to intense 'instantaneous' light impulse. This was the conventional answer. The more outrageous fact was that the effect permeated the control room, causing 'retinal blackout' even when personnel were shielded by several protective walls.... Careful examination of the effect before the (Naval Research Laboratory) now proved perplexing. First, the 'blackout effect' could be photographed as well as experienced.²³

This was the least of NRL's worries, for workers reported that tools left in the weld room simply disappeared after the impulse. Filming one such

²³ Vassilatos, op. cit, pp 254,255.

The Giza Death Star Deployed

weld with deliberately placed objects confirmed the reports; the objects simply vanished.

Conventional explanations were immediately offered that stated the dematerialized objects were being bombarded with intense and sudden X-rays. They were "cooked" apart. But examination of the weld room after such disappearances produced no trace gases of the missing items. The Navy then turned once again to Dr. Brown, whose gravitational detection work was already well known to them. Indeed, one gains the impression that, for the US Navy at least, Dr. Brown was more of an authority on gravity than Dr. Einstein!

In a briefing given to the Navy investigators, Brown surmised that something like a massless miniature black hole was being created by the high voltage sudden electrostatic impulse of the welder.

"Dr. Brown continued to describe what was occurring in and around the arc channel. The channel itself was producing its own 'hard' vacuum in stages. Though occurring in atmospheric pressure, the explosive force of the plasma arc had thrust all atmospheric gases out of the arc in its first few microseconds of formation. The full force of the blast was now occurring across a vacuum dielectric. The vacuum actually hindered the complete discharge of the capacitor bank for a few more microseconds, allowing the potential to build beyond those effects observed in weak lightning channels.

"It was in a sudden avalanche that the entire discharge occurred across this vacuum space, warping space through an electrogravitic interaction. The interaction was directly related to the voltages, the dielectric column, and the brevity of the impulse.²⁴ The normal density of inertial space was being instantaneously pierced, the arc literally 'punching a hole' through the continuum.

"The explosive vacuum arc set the stage for 'uncommon' observations. Surrounding the intense electrical impulse, space itself was collapsing; space and everything within that space. The strange blackout effect would be expected if all available light was being bent into the arc channel. Incapable of escaping the distortion of space, the blackout effect spread outward. Provided the distortion was intense enough, a specific large volume of space would be 'drawn' in toward the arc channel. The interaction took a few microseconds to effect. There was no escaping its presence.

"Furthermore, the blackout would produce various effects in 'successive stages. At weak levels, one could maintain the blackout effect without noticing any effects on nearby matter. There would be an intensity at which significant 'modifications' of matter would be noticed. These would include internal

²⁴ It will be recalled that similar variables were observed by Tesla to have affected his own impulse results.

Configuring the Scalar Impulse Wave

material strains and spontaneous electrical discharges. Provided the blackout effect was 'slow enough,' these material modifications could tear matter apart in an explosion of electrical brilliance."²⁵

That is, the particular rise and rest stages of his gravitator paralleled the quantized intensity of the warp effect. Complete and near-instantaneous production of the effect would simply totally annihilate all matter it touched, leaving not even any "trace gases." A "weaker" and "slower" use of the effect would cause the massless and chargeless shock wave to enter the nuclei of atoms and ruthlessly rip them apart in a hugely violent nuclear reaction that was not a standard chain reaction. Why this is so is apparent. The shock wave, being massless and chargeless, is a distortion in the fabric of local space and time itself, and hence, a distorted geometry literally rips apart the particles of atoms and unleashes the enormous energies binding them together. Being a massless, chargeless, and purely inertial phenomenon of spatial geometry, the shock wave is not impeded by the electrostatic repulsion of the atoms in the target region. The Shockwave thus shares certain characteristics with - and is perhaps even a harmonic of - certain acoustic phenomena known as infrasound, explored subsequently in this chapter.

Finally, the Navy correctly surmised that at an even weaker "step" or harmonic, the effect would be simply to bend light more gently around the warped region rendering anything inside the bubble invisible. This was clearly conceived by the Navy as the first step in gaining the experimental data necessary to control the effect in its more obviously weaponized form.

C. Radioactivity in the Open Systems Paradigm: Le Bon's "Photo-aetheric Effect"

(I) Element-Ray Interactions

One constant feature both of these impulse technologies and of the harmonic systems entanglement physics examined in *The Giza Death Star* is its reliance upon open systems, rather than closed systems, and nowhere is this paradigm thrown into higher relief than in a consideration of radioactivity. In the conventional model learned in physics programs,

²⁵ Vassilatos, op. cit., pp. 258-259.

The Giza Death Star Deployed

radioactivity, while a dynamic phenomenon, is a phenomenon of essentially closed systems that are "inherently unstable," and therefore capable of giving off spontaneous emissions of energy.

To the early twentieth century Belgian physicist Le Bon, however, radioactivity was not an inherent condition of an element, but a condition of the element's atomic structure with respect to external sources of energy. This paradigm shift changed everything, and enabled him to conduct an astonishing series of almost forgotten experiments, forgotten, because physicists insist on interpreting them along the closed system paradigm and hence dismissing their significance through a process of mere misinterpretation. The substance of Le Bon's theory is that the relationship between element and radiation is essentially harmonic.

"In Dr. Le Bon's thesis, the photonuclear reaction involved a special 'coupling action' which naturally existed between element and ray. Each element responded to a specific light energy series. Whenever the proper ray struck near the specific element, there was a disintegration 'reaction.' It was not necessary for the ray to strike the element dead-center. The mere proximity of the ray to an atom of the element was sufficient to stimulate atomic disintegration.

"Disintegrated atoms could produce very distinct products of particles, forces, and rays. These products and the nature of the radioactive disintegration was(sic.) determined by the element used and its specific range of resonant rays. One could design a reaction by appropriately arranging elements and rays. Not every ray which (sic, et passim) struck near an element could provoke the photonuclear reaction. Specific rays and specific elements were necessarily brought together before the reaction could begin. A 'fortunate providence'. Furthermore, that this bombardment was a true reaction and not just a simple collision became clear by experiment.

"According to Le Bon, the intensity of the bombarding rays was not important. When deep ultraviolet rays couple with the proper 'resonant' element, showers of identical rays were liberated. The photonuclear reaction was a high-yield electron reaction.... Proper entrant photons from space observably stimulate electron cascades in specific materials. Each photon was capable of stimulating the emission of countless others in a chain reaction which completely swept through the material. In this mounting cascade, prolific volumes of atoms were disintegrated. Only the presence of elemental 'impurities' blocked the continual disintegration of certain elements."²⁶

²⁶ Vassilatos, op. rat, p. 194, emphasis added.

Configuring the Scalar Impulse Wave

Le Bon's primary interest in this consideration was to explain why the deep ultraviolet radiation from the sun failed to disintegrate all in its path. He reasoned that there were two explanations.

First, complete annihilation was avoided because sunlight was diffused and scattered, and not focused. Second, because the each particular frequency in the deep ultraviolet vibrated only one element in such a way as to produce the electron cascade and the resulting atomic disintegration.

As Le Bon observed, even deeper violet end radiation, the deadly high frequency "black light" of gamma rays of certain frequencies when coupled to certain elements resulted in total annihilation, releasing "unimaginable" amounts of energy.²⁷ "One could produce pure electrostatic flux with no other dangerous emissions by actively coupling the proper rays and elements together."²⁸ This coupling of resonant frequency and element together allowed one to tailor whatever kind of energy result one wished: heat, kinetic, attractive, repulsive, or disintegrative.

(2) Crystals as Wave Guides

In stating these theories, Le Bon was basically maintaining that the structures of the elements were resonant to certain frequencies, particularly on the ultra-violet end of the spectrum. Lattice structure functioned essentially like a coupled oscillator to the incoming radiations, cavitating itself apart. As was hypothesized in The Giza Death Star, one likely missing component of the Grand Gallery were its vast arrays of crystalline gravito-acoustic resonators, the most significant of which would have been corundum, or sapphires, resonant to the violet end of the visible light spectrum.

In this open systems model of radioactivity, crystals are quite similar in function to the coil in the Tesla magnifying transformer, and similarly, in the transformer, the coil with its windings and nodal intersections of windings at many precise geometric points functions very similarly to the lattice structure of a crystal. Thus, in order for the Great Pyramid to have been a machine based on this electrostatic impulse and interactive open systems radioactivity model, significant analogs of coils and crystals must both be present in the structure.

²⁷ Ibid., p. 195.

²⁸ Ibid., p. 196.

The Giza Death Star Deployed

One is also able to perceive certain obvious parallels to the electro-inertial Shockwave of Brown. Le Bon appears to have observed the second stage or "weak" form of Brown's wave, since it fails to annihilate matter completely due to its comparative diffusion and the impurity of matter itself. In this, there is the faintest glimmer of how the Pyramid might have "controlled" its output. It did so by using the second "slower" or "weak" form of the electro-inertial shockwave and the elemental impurities - the chemical compound nature - of the target itself. This once again implies that the Pyramid, if it functioned as a weapon in the manner hypothesized, must have coupled harmonic oscillators of the elements themselves in order to produce the explosive electron cascade that would result in the violent cavitation and resulting nuclear explosion of any compounded elements in the target region. These must be present in order to configure the very complex waveform necessary to oscillate and disintegrate all potential elements within the target region.

D. Infrasound Again

At the extreme opposite end of the spectrum of cycles and oscillations is infrasound, extremely low frequency vibrations well below the range of human hearing, oscillations of lower than sixteen cycles per second, much lower than the lowest bass notes on the largest 128' stops of the Atlantic City Auditorium pipe organ. Infrasonic waves are purely acoustic phenomena, of such low frequency and power that they are capable of being transmitted through space. Waves of pure longitudinal compression, they are best associated with the seismic shock waves of earthquakes.

First discovered by French physicist Dr. Vladimir Gavreau, they were immediately seized upon by the French government and developed for military purposes as a cheap, cost effective stop-gap weapon of mass destruction in the aftermath of World War Two and the Soviet-American monopoly on atomic weapons until France's own nuclear program produced a French bomb.

Gavreau and his research team first constructed very large organ pipes, "weakly" powered by a typical blower, over seventy-five feet long and six feet wide. Turning the device on, the results were spectacular, if not horrifying. His team was immediately seized in a pressure vice-grip from

²⁹It must be pointed out that this instrument is the only pipe organ in the world to have incorporated a 128' stop, whose notes were not so much heard as felt.

Configuring the Scalar Impulse Wave

all sides, experiencing profound nausea and disorientation. The experience of his team recalls the observations that Sitchin records occurred in the ancient Sumerian texts, where the opponents of the Pyramid when in its proximity were seized with a strong hand that threatened death.³⁰ The braces that propped the "organ pipe" up crumbled under the vibration. Only because one team member resisted the pain to shut off the blower switch were fatal results averted. Subsequent efforts both miniaturized the deadly whistles and made them remotely controllable and their effects targetable.³¹

The smaller models resembled very large "police whistles" whose "overall characteristics were quite simple to determine, a mathematical formula being devised for the purpose. The whistle's resonant pitch was found by dividing its diameter into a numerical constant of 51."³² As Gavreau quickly learned, infrasound devices required "extremely large baffles."³³

Both of these facts are of interest because of their possible connection and use in the Pyramid. The connection between electrical and gravitational energy via electrostatic impulse was evident in the experiments of Brown. A similar connection between very low sound and gravity was noted in *The Giza Death Star*. One thing now clearly emerges: all waveforms thus encountered are essentially massless, chargeless, and longitudinal, extending from the very highest impulses accessed by the high frequency end of the electromagnetic spectrum to the very low cycles of infrasound. It is thus posited that this constitutes a longitudinal harmonic series. It is perhaps therefore quite significant that the angle of inclination of the apothem of the Great Pyramid is approximately 51 degrees, within a few minutes and seconds of arc. Moreover, as Dunn observed, the function of the Antechamber could have been nothing else other than as a very large sonic baffle, the Grand Gallery possibly being an extremely long infrasonic "organ pipe." This will be explored further part two of this chapter.

³⁰ Cf. Farrell, *The Giza Death Star*, p. 50.

³¹ Vassilatatos, *op. cit.*, pp. 293-296.

³² *Ibid.*, p. 296.

³³ *Ibid.*, p. 299.

The Giza Death Star Deployed

E. Farnsworth 's Virtual Electrodes and Hot Fusion Plasma Containment

As noted in my previous book, Dr. Philo Farnsworth used advanced electron optical focussing to concentrate ions in a vice grip in what he called a fusor tube, "comprising a spherical anode surrounding a cathode. On the anode portion of the electron tube, ion canons were mounted so that their beams would intersect in the center of the cathode," establishing within the tube what amounted to virtual electrodes.³⁴

In the Giza Death Star I also pointed out that if one accepts Dunn's analysis, then at the very least the Great Pyramid contained vast quantities of hydrogen gas, possibly approaching a near-plasma state. If it did contain a plasma outright, it could only exist in one of two types of state: endothermic, or the "cold fusion" state, or exothermic, or "hot fusion". The genius of Farnsworth's "fusor" tube was its total ability to maintain and contain the extremely hot temperatures of hot fusion in the vice grip of virtual electrodes. The process is familiar to anyone who has noticed a neon light up close: the illuminated gas when heated by electric charge passing through it actually draws away from the walls of the glass tube enclosing it in a kind of pinching effect.

Supposing for the sake of argument that the Great Pyramid did contain such a fusion plasma in its inner chambers by some similar such method, whether exothermic or endothermic,³⁵ what would have been the reason for doing so, beyond providing a power source for the weapon? The answer lies in the fact that at almost every turn, the Pyramid is an analog of some physical process or system. Given the postulated harmonic nature of the weapon, it would have been necessary to produce as close an analog as possible to the energies that ultimately drove the nuclear interactions of the systems it oscillated. In this sense, also, the Giza Death Star may have literally been an intensely focused, miniature, and quite artificial star, releasing the extraordinary deep ultraviolet and gamma radiations that, as Le Bon pointed out, were so necessary to cause the ray-element interactions leading to atomic disintegration. Low levels of radiation

³⁴ Joseph P. Farrell, *The Giza Death Star*(Kempton, Illinois: Adventures Unlimited Press, 2001), p. 147.

³⁵I should stress that I think it far more likely to have been endothermic if a plasma existed within it at all for the obvious reason that an exothermic plasma would simply melt the crystal arrays once present in the Grand Gallery and elsewhere.

Configuring the Scalar Impulse Wave

would have to be maintained so as not to disrupt or disintegrate the crystal arrays within any of the Pyramid's chambers.

F. Inferred Physical Postulates

A brief reprise of physical and engineering principles is in order before proceeding to examine their presence and functional application in the Giza Death Star.

- Sudden, high voltage electrostatic impulse against a region of low impedance produces an electro-dynamic, or if one prefers, electro-acoustic or electro-gravitic shockwave that is longitudinal and superluminal in velocity. As such, this Shockwave is an alternating compression and rarefaction of the fabric of local space and local time.
- This shockwave is massless and chargeless, and suffers no diminution of force - but may actually increase in force - over distance, and is not subject to the dissipation of the inverse square law.
- Radioactivity is an open systems phenomenon, depending on the interactions of rays and elements, certain rays producing an electron cascade within resonant elements causing various degrees of atomic disintegration as desired.
- The massless and chargeless Shockwave is essentially a purely harmonic inertial phenomenon that may be configured to carry resonant frequencies of any conceivable target provided the elements within the target are coupled and oscillated. It is thus a highly complex waveform comprised simultaneously of electric, gravitational, and acoustic information.
- This waveform may be configured in certain "steps" that in turn may represent some harmonic of quantized states in a macrosystem. Accordingly, it may be
 - Weakly configured to produce power from intra-atomic reactions;
 - More strongly configured to produce bubbles or force fields to bend the electromagnetic gradient around a given area or object to shield it from view;

The Giza Death Star Deployed

- Still more strongly configured to produce a more intense field of force to protect the area from any incoming object or merely electromagnetic ray;
- Still more strongly configured to produce strong local space-time distortions equivalent to producing a large mass in the region instantaneously, and thus producing reactionless thrustless means for propulsion (or the synthesizing of materials in different gravities than are possible under normal terrestrial conditions);
- Still more strongly configured to produce an advancing superluminal "time-reversed" planar wavefront that, being massless and chargeless, carries its warping space-time geometry into the heart of nuclei of atoms in any given target region and disrupting them by the cavitation that results from that distortion, producing enormous nuclear-electric explosions in any aggregate of elements. The work of Le Bon suggests that this wave is the phase conjugate of the harmonic relationship between the electromagnetic frequency-and-chemical element of his open systems approach to radioactivity. Such engineering of local space-time distortions literally rip the fabric of space that holds atoms together apart provided that an appropriate phase conjugate "mirror" can reflect and amplify those harmonics back upon them in a literal embodiment of the ancient Chinese legend of a "Yin-Yang" mirror;
- Configured in its strongest condition, where the immediate and total annihilation of all matter in the target region occurs almost instantaneously.

Turning to a consideration of the engineering principles embodied, these may be reduced to one fundamental and paramount consideration: all possible systems states of any potential target must have some actual dimensional, structural, or process analog in the Pyramid itself in order for it to function as a coupled oscillator and amplifier of the harmonics of any target. This forms the ultimate reason for the astonishing catalog of physical constants, thermal gradients, harmonics of quantum states, planetary geometries, atomic properties of elements, and nuclear, electromagnetic, acoustic and gravitational processes at work in the structure.

Configuring the Scalar Impulse Wave

Part Two: Inferred Applications in the Great Pyramid

A. The Queen's Chamber: Hydrogen Generation

Christopher Dunn argues quite convincingly in his book *The Giza Powerplant* that the overpowering stench that welled up the descending shaft from the Queen's Chamber and that greeted the first modern visitors inside the Great Pyramid was probably the result of generating hydrogen gas by the simple process of combining hydrated zinc chloride and hydrochloric acid. Zinc plus hydrochloric acid yields Hydrogen gas plus zinc chloride solution.³⁶ This would not only explain the stench recorded by the Pyramid's first modern visitors, but also provide a possibility that such gas at some point inside the Pyramid's processes became an ionized plasma, emitting the strong radiations alluded to in Sitchin's ancient Sumerian texts. As will be seen, there is a possibility that it achieved a plasma or near-plasma state in the King's chamber.

B. The Grand Gallery:

(1) Gravito-Acoustic Infrasound "Organ Pipe "

Most people are familiar with the pipes of a pipe organ. Made of metal or wood of varying but precise lengths, they have a hole at the bottom for the admission of air, a long column of air contained by the pipe, an opening at the side with a lip designed to set the column inside the pipe into vibration when air is admitted to the bottom of the pipe, and an opening at the top. These pipes come in predictable lengths that are all harmonic multiples of each other, the numbers visible on the organ stops designating the length of the pipe at the lowest note on the keyboard or pedal board, 32', 16', 8', 4' and so on. The number thus designates the length of the column of air being vibrated in the pipe. Most people are unaware, however, of the vast difference in physical form of the organ pipes they do not see. A trip inside the sound chamber of a pipe organ

³⁶ Christopher Dunn, *The Giza Power Plant* (Santa Fe, new Mexico: Bear and Co.: 1998), pp. 199-200.

The Giza Death Star Deployed

reveals a vast and strange array of oddly shaped pipes, each one producing a different quality of sound depending not only on the length of the pipe but also on other physical configurations, including the material that the pipes are made of. Some piped are capped, which effectively doubles the length of the vibrating column of air inside it, reflecting the sound wave back down the pipe. A capped pipe thus physically only four feet long vibrates with a fundamental of a pipe twice its length (Figure 2):

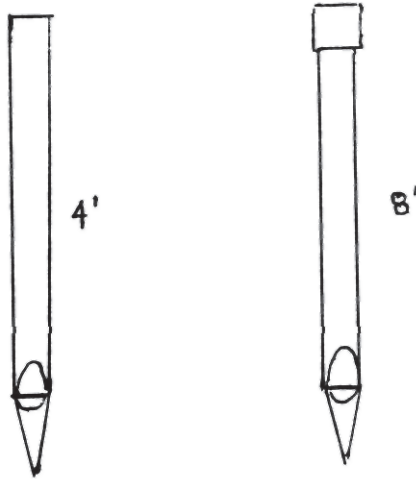

Figure 2: Capped and Uncapped Organ Pipes

Turning to the three dimensional cutaway schematic of the Great Pyramid in Figure Three, the resemblances between an organ pipe and the Grand Gallery become apparent. Note the shaft at the bottom admitting air. The Helmholtz-type crystal resonator arrays would serve the purpose for setting the column in motion as the hydrogen moved across the openings of each resonator.

Configuring the Scalar Impulse Wave

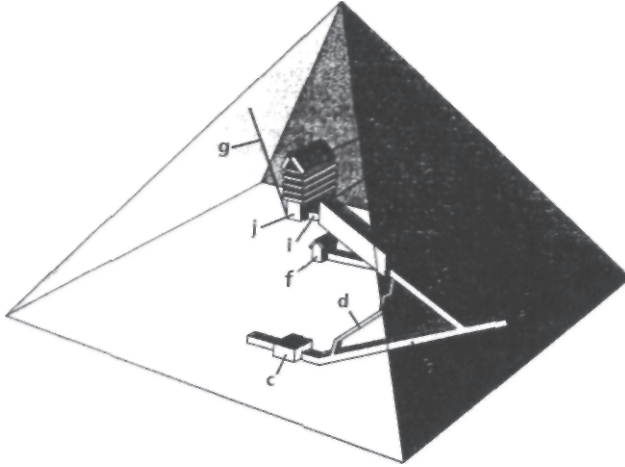

Figure 3: Three Dimensional Cutaway View of the Great Pyramid

Note that the hydrogen gas being generated in the Queen's Chamber would naturally flow upward through the well-shaft and emerge in the Grand Gallery. As Dunn demonstrated in his book *The Giza Power Plant*, the upward incline of the chamber ensures a smooth steady flow of the gas throughout the chamber. However, note at the top end of the Gallery the very low passageway leading to the King's Chamber. The "organ pipe" of the Grand Gallery is partially capped in such a manner that the sound waves reflecting off the polished limestone surfaces of the walls and slanted acoustically-tiling roof of the chamber would tend to send some waves back down its tremendous length, and back and forth, effectively doubling the enormously low infrasonic fundamental of the chamber, just as in an organ pipe.

The Giza Death Star Deployed

However, Figure Four shows something else:

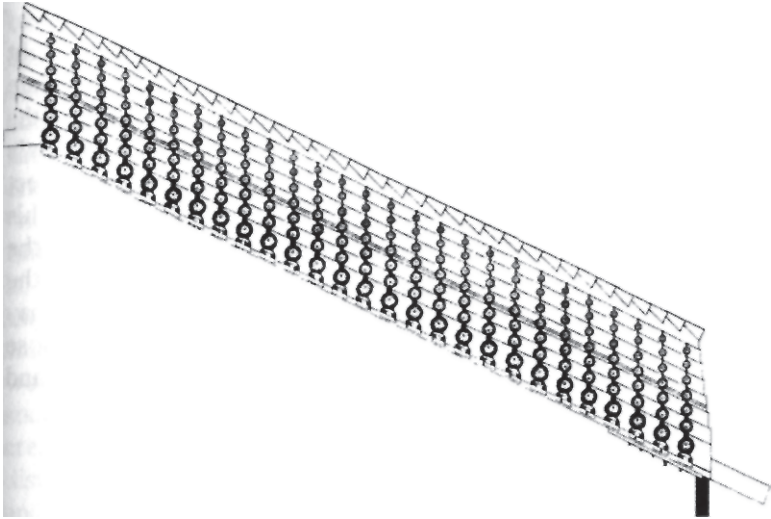

Figure 4: The Grand Gallery: Cross View

It will be observed that the Grand Gallery is an ingenious set of "virtual pipes" within a pipe, since there are nine distinctly rectangular, and increasingly narrow, channels of air within it, if one counts the lowest section and then moves upward toward the roof. Eight of these sections become increasingly narrow in harmonic step-wise fashion as one looks from the bottom of the diagram to the top. Thus, looked at another way, no less than nine possible infrasonic fundamentals are being generated and amplified by the chamber. At the lowest point of the chamber, of course, one finds the granite plugs essential to "cap" the pipe at the other end.

Viewed in this sense, the Grand Gallery is indeed an amplification chamber, but an amplification chamber of the horrible and deadly harmonies of infrasound. This in mind, we examine once again the probable presence within it at one time of no less than twenty-seven crystalline Helmholtz resonator arrays.

Configuring the Scalar Impulse Wave

(2) The Missing Gravito-Acoustic Resonator Crystal Arrays

It was posited in The Giza Death Star that the missing components of the Grand Gallery once consisted of twenty-seven banks of crystals, eight crystals per bank, of Helmholtz resonators designed to detect and oscillate gravity waves in addition to being resonant to the photon emissions of the excited hydrogen gas within the structure (Figure Five). Given Tesla's statements with respect to the properties of selenium being able to detect (and possibly magnify) the superluminal impulse waves generated by his transformer, and given the role of corundum (sapphire and ruby) in the detection of gravity waves in subsequent Soviet research as well as the persistence of sapphire as a "destiny stone" in esoteric literature, we may safely posit that at least three crystalline components, or elements of those crystalline components, are known: corundum in the form of sapphire and ruby, and in each the presence of an "impurity" of selenium.

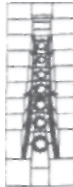

Figure Five: Missing Helmholtz Arrays in the Grand Gallery

In this regard it should be recalled that one of Thomas Townsend Brown's functions for the Naval Research Laboratory in the 1930s was to measure gravity waves by taking his equipment to deep underground caves and

The Giza Death Star Deployed

locations in Pennsylvania and Ohio.³⁷ The reason for Brown's spelunking adventures are rather obvious: deep underground rock formations provide the best "insulation" from the noise of background radiation. Gravity waves can therefore be detected by measuring minute amounts of variation in the spatial displacement of his dielectrics at different distances and depths from the center of the earth's gravity since gravitational acceleration varies with distance from the center of gravity. Precisely the same two things are found in the Grand Gallery: the presence of an enormous amount of rock shielding from extraneous background radiation "noise", and precisely stepped variations in height of the arrays measuring minute differences in gravitational acceleration. The Grand Gallery, however, has one advantage that Brown did not. The polished limestone surfaces, plus the crystal arrays themselves, would have amplified any such detections, and with amplification, have oscillated them. In other words, the function of the Grand Gallery was not only to measure or detect such minute celestial geometric variations, but to amplify them in order to create one of the fundamental conditions for the structuring of a "mass distortion" effect in the targeted space at any given moment of celestial and planetary geometric configuration.

C. The Antechamber: Sonic Baffle

The harmonic information of the gravitational and acoustic energies are then passed to the King's Chamber via the Antechamber, which, as Dunn persuasively argues, is constructed as an acoustic baffle to filter out frequencies and overtones not resonant with the target. One may therefore reasonably speculate that it would have been necessary for some means or method of remote controlling the raising and lowering of the baffles in the "portcullis" based on the primary harmonics being oscillated at any given moment of celestial configuration in the Grand Gallery. This filtered and harmonically resonant information and energy then passes into The King's Chamber.

³⁷ Vassilatos, op. cit., p. 252.

Configuring the Scalar Impulse Wave

D. The King's Chamber:

(1) Tertiary Tesla Coil, and Possible Plasma Pinching: Harmonic Piezoelectric Stressing and Amplification

As argued by Dunn in *The Giza Power Plant* and noted in my previous book *The Giza Death Star*, the massive granite stones surrounding the chamber would be stressed to give off piezoelectric effects in two ways: first, by the immense load bearing down on the granite, and secondly, by the sonic vibrations coming from the Grand Gallery and Antechamber. Moreover, the hydrogen gas in the chamber would itself give off strong radiations, since the electrons of the hydrogen atoms would continually jump from excitation states back to rest states in resonance with the sonic vibrations coming from the Grand Gallery and Antechamber. The massive granite stones in the five chambers above the main chamber are each acoustically tuned to the chamber below it, magnifying the amplification of the electro-acoustic input even more, and loading more and more stress on the piezo-electric properties of the granite. An enormous electrostatic potential with precise longitudinal acoustic properties is thus being created in the King's Chamber.

Now we may add a further observation, based on the accumulated experience of Eric Dollard with Tesla Magnifying Impulse Transformers. The power of the transformer was dependent upon the geometry of the system, specifically, on the number of windings in, and on the surface area of, the coil. The King's Chamber is thus the tertiary coil, or the "Tesla Coil Proper" of the whole structure, since each granite stone course functions as a winding. Moreover, the relationships of the various surface areas of the King's Chamber are resonant to very specific celestial and terrestrial and temporal properties.

If there is any hydrogen plasma to be found in the Great Pyramid, then the King's Chamber is the most natural place to look for it, since the surrounding "coil" and buildup of potential on the surface of the "coil" would - as in a neon light tube - "pinch" the plasma, keeping it away from the walls of the chamber and Coffin and melting the granite of each. But how would the Pyramid achieve such enormous potentials?

It will be recalled that the Great Pyramid was built in a time before the Sahara was a desert. With adequate rainfall, the porous limestone facing would absorb moisture and become electrically conductive. A capstone of

The Giza Death Star Deployed

corundum, sheathed perhaps in a heat-resistant metal, could act as an effective lightening rod, attracting strikes that would, in effect, "super charge" the structure like a monstrously huge capacitor, and bringing the peizo-electric properties of the structure into enormous stress. To discharge the weapon, one merely had to "tune" it to the harmonic signature of the target.

(2) The Coffin: Cohered Optical Cavity

All this energy being loaded into the King's Chamber must have a means of damping, or else the massive buildup of acoustic infrasound, gravitational space-time distortions and electrostatic potential would simply have vaporized the entire edifice. Moreover, Dunn hypothesizes that the "air-shaft" entering the King's Chamber on the same side as the passageway from the Acoustic Baffle was a microwave input channel. On this basis, he made a further convincing case that since the ends of the coffin are slightly concave, it had all the trappings of the optical crystalline cavity for a maser. Thus, he concludes on the basis of physics that it must at one time actually have been placed in a direct line between the two airshafts.

The enormous radiations occurring in the chamber would then have been modulated on the cohered carrier microwave, and exited the chamber via the horn antenna on the other air shaft. If a plasma was thus present in the chamber, this cohered microwave radiation would have supplied a powerful and focussed current to "pinch" the plasma being carried along with the microwave through the narrow shaft to the surface of the Pyramid, again keeping the plasma from melting the surrounding rock. If this is so, then an enormously and highly concentrated "fusion" or "plasma torch" was also being created that alone would have burned through anything it encountered. For the moment, we leave this concentrated emission of cohered and coupled gravito-infrasonic, electromagnetic, and thermonuclear energy aside, and journey to the outside of the Pyramid.

Configuring the Scalar Impulse Wave

E. The Stone Courses of the Pyramid:

(1) Secondary Coil Windings, Crystal Lattice Structure

We may now be more explicit as to which coil function the limestone courses of the whole Pyramid fulfill. Dollard remarks as follows:

"The function of the secondary coil is threefold. The first is the transforming of the primary (magnetic motive force) pulse into an abrupt travelling electric wave. Second, to provide a constant potential constant current transformation for good voltage regulation at the output terminal of the Tesla coil, and third is to match the drive impedance of the Tesla coil to the drive impedance of the earth.

"The secondary coil is of a low characteristic impedance.... This low impedance requires it to be of high self capacity. This capacity is best facilitated by flat spiral coils of wide strip, or by short coils of wide strip, or by short coils of wide strip wound edgewise. The diameter of the secondary must be very nearly that of the primary loop."³⁸

How can an analog of this possibly be discovered in the Great Pyramid?

A clue is afforded by Dollard's subsequent remarks that the mass of the large flat copper strip that constitutes the primary and the mass of the copper in the secondary coils should be equal. "This of course goes along with standard transformer theory but it must be remembered that the depth of penetration of waves into conductors is microscopic for impulses. This copper requirement must be modified to equal surface area rather than weight."³⁹ If one takes the bottom course of stones as the primary and the remaining ones as the secondary, one has perhaps a very loose analog of these two components.

A better indicator, however, lies in two facts: first, that the impulse wave travels over the surface of the coils, rather than being conducted through them; and second, the variable thicknesses of the stone courses would seem to be precisely the type of wide flat windings that Dollard indicates are necessary for the secondary. The requirement of surface area resonance to the primary and its function of coupling to the impedance of the earth should be noted, for the whole Pyramid is, as many have observed, constructed as a "cubed sphere" whose dimensional measures -

³⁸ Dollard, Condensed Introduction to Tesla Transformers, pp. 6-7

³⁹ Ibid., p. 16.

The Giza Death Star Deployed

surface area, perimeter and so on - are resonant to some terrestrial dimension.

Moreover, the conical structure of the Pyramid itself, the "secondary" is in line with Tesla's own later developments of his initial technology, since he employed precisely such conical secondaries in later more refined versions of his transformer. But in the Pyramid, the secondary has yet another function that goes far beyond what Tesla or Dollard envision.

(2) Periodic Atomic Weight Resonance

As indicated previously, in order to harmonically oscillate and disrupt a target the Pyramid would have to be found to incorporate some analog of the chemical elements themselves in any possible combination. Since Le Bon hypothesized that each element had a corresponding deep ultra-violet or gamma ray frequency that corresponded to it to produce the maximum photo-aetheric or photonuclear effect, then one should expect to find this analog in the secondary coil, that is, in that part of the Tesla Magnifying Transformer that uses electromagnetic energy to drive the longitudinal "electro-acoustic impulse" in the tertiary, or Tesla coil proper. One should expect, in other words, the harmonic information of the elements to occur in that portion of the structure and transformer process that happens prior to their modulation in the superluminal longitudinal carrier wave. And that is precisely where such analogs do occur in the Giza Death Star: the Stone courses of the structure itself, as was seen in an earlier chapter.

F. The Parabolic Faces: Focus and Collection of Base Stellar and Galactic Systems' Waves

As was hypothesized in The Giza Death Star, the parabolically indented faces of the Great Pyramid may have served the function of collecting the background radiations of the solar and galactic system. In this respect, its function as a "wave guide" and amplifying mirror or crystal of the extreme degree of sophisticated integration of functions in its engineering a property not appreciated, perhaps, without some visual confirmation. As was noted in chapter four, the eighteenth Napoleonic print is remarkable for its modern military "feel":

Configuring the Scalar Impulse Wave



Figure 6: The Eighteenth Century Napoleonic Print of the Great Pyramid

In any case, such a structural feature was essential not only for structural integrity and stability but, once again, because the Great Pyramid was a coupled harmonic oscillator designed to oscillate to total spatio-temporal geometry of its target, since the target itself was subject to the influences of these systems. Both functions are elegantly fulfilled in this one simple and efficient expedient.

G. The Apothem: "Virtual Leads"?

The French print also points out another possible function of the apothem as a "virtual lead" of the impulse from the primary to the dielectric antenna of the apex, indicating the shortest path for the impulse to take over the surface of the structure.

H. The Missing Apex Crystal: Dielectric Antenna

The final constituent in the "Tesla Impulse component" of the Pyramid was the Apex. Here Dollard is clear: the antenna is a dielectrical spherical

The Giza Death Star Deployed

antenna. Since the missing Apex is exactly 1/100 the dimensions of the whole structure, it is in harmonic resonance with it, and in turn, with the earth, providing perhaps an answer to Dollard's own question on the relationship between the dielectric's dimensions and the earth's. In keeping with the other hypothesized missing components, the Apex most likely was of some highly conductive crystalline form, gold, platinum, or perhaps once again corundum. As a "cubed sphere" like the rest of the Pyramid, it is geometrically the equivalent of a sphere.

I. The Selection of Calcium Carbonate (Limestone) Casing Stones

Nothing in the Pyramid is there by chance or happenstance, but by deliberate choice, and very seldom is there just one reason for something being there. Beyond the reflective and insulating properties of limestone, there are perhaps unexplored radioactive properties in accordance with Le Bon's "open systems paradigm" of ray-element interactions that made its selection an appropriate choice of material from the point of view of not only engineering the structure for ease of construction, but engineering the physics. Moreover, pace Brown's experiments, it is also possible that limestone was selected for its dielectric properties. But most significantly, it is definitely non-linear material, an essential component of the sophisticated scalar weaponry outlined by Bearden and reviewed in previous chapters.

But even this rather speculative but nevertheless gruesome inventory of the functions of various components of the Giza Death Star does not exhaust the sophistication of its engineering. To appreciate fully the scale of physics involved, one must examine not only the large-scale components and physical systems being oscillated and amplified, as was done in this chapter, but also the very small quantum world, and the weird, tetrahedral mathematical universe of "quantum numerology" that may have been behind the unification of the physics of the very large and very small in the paleoancient world that constructed and deployed the Giza Death Star.

QUANTUM NUMEROLOGY, FEEDBACK LOOPS, AND TETRAHEDRAL PHYSICS

"We may well discover that we are the Martians."
Richard C. Hoagland

"...The Great Pyramid was probably not built by a religious cult of priest-kings seeking an afterlife. The miniaturisation of the Earth in the Great Pyramid's dimensions would therefore have been a scientific rather than a religious statement....It seems entirely reasonable that an already-existing Pyramid became the focus of a religious cult, which regarded it as a means of ascending to the heavens."
Alan F. Alford, *The Phoenix Solution*.¹

A. Nested Harmonic Feedback Loops as "Virtual Coil Windings" and "Lattice Structure ": Geometric Amplification

In my previous book *The Giza Death Star* I mentioned in passing that one very interesting feature of the Great Pyramid, known to most who have studied it closely, is the multiple levels at which certain fundamental physical or geometric principles and constants recur over and over again in various harmonic multiples. These were "nested feedback loops" as I called them. Deliberately, I did not elaborate the idea, choosing instead merely to catalogue them on the basis of close harmonic multiples of the Planck units without exhibiting the characteristics of these feedback loops. There are three essential features that must be born in mind in any approach to this stupendous feat of integrated engineering:

- (1) The first is drawn from the general nature of Tesla Impulse Magnifying Transformers themselves. From the exposition of Dollard's experimental reconstructions of this technology it will have been apparent that the impulse is driven linearly from the primary, through the secondary to the tertiary, where it is magnified and driven to the dielectric. There meeting a resistance barrier the current stops and an abrupt, powerful longitudinal

¹ Alan F. Alford, *The Phoenix Solution: Secrets of a Lost Civilization* (London: New English Library, 1998), p. 477.

The Giza Death Star Deployed

electric "compression" waves splatters out superluminally from the antenna. The Tesla coil or tertiary itself must, according to Dollard, be of the same length as the secondary, but of maximum impedance.

- (2) The second is the ordered series of ratios 6:8::9:12 that drives the emergence of the differing overtone series based respectively on fifths, fourths, and thirds outlined in the platonic harmonics in The Giza Death Star. There it was discovered that an approximation of these three naturally occurring overtone series had to be made to allow for the unification and integration of the three series into one unified harmonic system. One would expect harmonics of this series of ratios in the structure
- (3) Finally, it was discovered that a similar harmonic approximation of Planck's constant - normally 6626076 - by a coefficient of 6626 resulted in close harmonic multiples of that constant in certain Pyramid dimensions to within one or two decimal places. For example, the North-South measure of the bottom of the niche in the Queen's chamber is 20.60659 Pyramid inches. The harmonic coefficient is therefore 2060659, which divided by 6626 yields 310.9959.

(1) The Feedback Loops, or "Virtual Coil Windings" or "Virtual Lattice Structure" of the Total System of Inner Chambers Based on Harmonics of Planck's Constant (Engineered Theoretical Value of 6626) and the Sumerian Ratio 6:8::9:12:

On this view, the "feedback loops" are virtual lattice structures or coil windings within the Pyramid. As the following tabulation and schematic make clear, the "feedback loops" are literally harmonically impelled by the sheer dimensions of the geometry of the structure toward the King's Chamber and their final integrated, modulated and cohered output.

Let us now go a step further in extrapolating what harmonics might have been oscillated or coupled to each of the twenty-six arrays. Taking the fundamental measure of 20.60659 Pyramid inches as the fundamental with its various overtones, and dividing by the engineered theoretical values of the Planck units, one obtains the following table:

Quantum Numerology, Feedback Loops, and Tetrahedral Physics

QUEEN'S CHAMBER (PLASMA SUPPLY)	HARMONIC
Niche bottom (N-S) 20.60659	1
Niche depth (E-W) 41.21319 (=20.60659 x 2)	2
Niche top (N-S) 61.81978 (=20.60659 x 3)	3
Grand Gallery (Gravito-Acoustic Amplification)	
Ramp Width	2
Roof Width	2
Distance Across Great Step (N-S)	3
Width over Ramp Tops	4
Distance Across Great Step (E-W)	4
Length of Roof	9(9.06)
Antechamber: First Low Passage	
Height	2
Width	2
Length	2.5 (2.524)
Antechamber Proper (Sonic Baffle)	
Face of Boss to Wall Width	1
Floor Width	2
Height of Boss from Floor	2
Length of Granite Floor	5
Height of East Wainscoat	5
ANTECHAMBER: SECOND LOW PASSAGE	
Height	2
Width	2
King's Chamber (Amplification and Modulation)	
Coffer Width 38.69843 (= x 1.8778637)	~2
Coffer Height	2
N-S Width of Whole Chamber	10
Height of Chamber	12
Diagonal of E-W Width of Chamber	15
E-W Length	20
Floor Diagonal	22

Observe carefully what is happening here:

- (1) The "Sumerian ratio" 6:8::9:12, discussed extensively in my previous book *The Giza Death Star*, occurs in various harmonic combinations:
- (2) Those combinations are in turn harmonics of the Planck constant of the minimum quantum of action;
- (3) Beginning with the "fundamental" measure of 20.60659 pyramid inches in the Queen's Chamber, there are three distinct stages or peaks of harmonic amplification that follow:

The Giza Death Star Deployed

- (a) the first peak at the ninth harmonic in the Grand Gallery;
- (b) the second peak at the fifth harmonic in the Antechamber;
- (c) and the ultimate peak at the twenty-second harmonic in the King's Chamber.

In other words, the amplification proceeds by geometric and dimensional multiplication of harmonics of Planck's constant in a unidirectional fashion toward the King's Chamber, where the feedback loops or "windings" (or lattice structure) builds to an enormous series by curling each accumulation back into itself and passing it on to the next stage, where it is curled back in upon itself, and so on. These considerations permit one more speculative set of inferences to be taken.

Note particularly that the harmonic overtones of the measure are all very close harmonics, to within one or two decimal places at most, of the Planck constant, and moreover, note the peculiar property of the harmonics of the Planck length decimal place being a repeated pattern of 9,8,7,6,5,4,3,2,1,0. It is perhaps not without significance that there exist twenty-six slots for these arrays in the Grand Gallery, and twenty-six dimensions in that mathematical behemoth of contemporary unified field theory within theoretical physics, super-string and M-theory.

(2) Dimensional Measures of the Outer Structure and Planck Unit Harmonics

Other significant harmonics of the Planck units exist in very unusual places in the Great Pyramid, suggesting once again the harmonic basis of the unification of fields and the rendering of micro and macro physical systems in terms of harmonics of the Planck units, i.e., in terms of the geometries of some quantum state. Remembering that I have assigned theoretical coefficients of 6626, 6362, and 4799 to the Planck constant, Planck length, and Planck mass, and dividing the coefficients of various dimensions of the Pyramid as recorded by Capt by these, gives the results in the following table. Note particularly those cases where the quotient returned is within two tenths of a decimal place of a whole value, or less. We will discuss the ramifications of the results after the tables.

Quantum Numerology, Feedback Loops, and Tetrahedral Physics

Trigonometric Values of the Pyramidic PI Angle of 51 ° 51', 14.3" of Arc (Capt, p. 136):

Trigonometric Function	Planck Constant	Planck Length	Planck Mass
	/6626	/6362	/4799
Sin .7864391	1186.8987	1236.15	1638.7562
Cos .6176678	932.1880	970.87	1287.0761
Tan 1.2732595	1921.5809	2001.32	2653.1350
Cosec 1.2715542	1919.0374	1998.67	2649.6233
Sec 1.1689931 (PHI!)	2443.39456	2541.78	3373.6051
Cot .7853981	1185.3276	123.45	1636.5869

Square Base of Pyramid in Pyramid Inches (Capt, p. 138)

	Planck Constant	Planck Length	Planck Mass
	+6626	+6362	+4799
35,524,235	5361.3394	5583.8156	7402.4245

Height of 35th Course from Base in Pyramid Inches (Capt, p. 138)

11626	1.7546	1.8274	2.4226
-------	--------	--------	--------

Sum of Base Diagonals as an Analog of the Precession of the Equinoxes (Capt, p. 151)

25826.54	389.7757	405.9500	538.1650
----------	----------	----------	----------

The Mean Distance to the Sun in Miles (Capt, p. 153)

91,856,060	13862.9731	14438.2364	19140.6668
------------	------------	------------	------------

Cubic Content of the Coffin in Pyramid Inches (Capt, p. 154)

71250	10.7531	11.1993	14.8468
-------	---------	---------	---------

Polar Radius of Earth in Miles (Capt, p. 154)

3949.89	59.6106	62.0849	82.3065
---------	---------	---------	---------

Expansion and Rectification Factors and the Offset of the Interior Alignment of the Chambers from the Vertical Axis (Capt, pp. 218-219)

Displacement Factor:

The Giza Death Star Deployed

286.10213	4317.8709	4497.0469	5961.7031
-----------	-----------	-----------	-----------

Expansion

Factor:

3576	.53969	.56208	.74516
------	--------	--------	--------

Pyramid Perimeter With and Without Casing, i.e., With and Without Rectification (Capt, p. 223)

Planck Constant /6626	Planck Length /6362	Planck Mass /4799
--------------------------	------------------------	----------------------

Without

Casing

36,238	5.4690	5.6960	7.5512
--------	--------	--------	--------

With Casing

(+ 286)

36,524	5.5122	5.7409	7.6108
--------	--------	--------	--------

These results require some commentary, since they tend to confirm certain speculations I advanced elsewhere:

- (1) With respect to celestial mechanics, the mean distance from the earth to the center of the sun is expressed in some form (not yet fully understood) of the geometry of a quantum state;
- (2) Similarly, the precession of the equinoxes is expressed in some form of the geometry of a quantum state;
- (3) The earth's spherical dimensions are expressed as a harmonic of the Planck Length, and possibly as a harmonic of the Planck constant of action and Planck mass;
- (4) The displacement factor of the entire structure, that is, the difference between cased and uncased (non-rectified and rectified) dimensions, as well as the asymmetrical displacement of the interior chambers, are expressed as harmonics of all Planck units;
- (5) The expansion factor, and non-rectified and rectified expansion factors, are approximately one half of the Planck constant and Length, and approximately seven tenths of the Planck Mass;
- (6) The Coffin appears to be not only the optical cavity of a maser, pace Dunn, but also an optical cavity and coupled oscillator in and

of itself, since its volume is a harmonic of all Planck units we have examined.

Point number three requires further development. If the Pyramid was to couple gravitational energy as a set of acoustic information modulating a superluminal "scalar" carrier wave, then some conversion of gravitational mass and acceleration into length seems to be implied. The phenomenon is not as esoteric as it sounds. Everyone is familiar with pendulums. The frequencies of their swing are a function of the length of the pendulum and the force of gravity. Similar effects are predicted by Relativity.

In *The Giza Death Star I* suggested that one of the primary functions of the Grand Gallery was to amplify and oscillate the gravitational and acoustic harmonics of the earth and local space itself. Following Dunn, it was posited that some series of 27 resonating arrays once filled the chamber. We now take this analysis a step further. If the 27 arrays were meant to oscillate certain harmonic steps, then the first 26 arrays might represent the fundamental (array 1), its various harmonic "overtones" (arrays 2-26), and the "octave" (array 27). The first thing one notices about this speculation is the odd recurrence of the number 26.

(3) The Odd Recurrence of the Number 26

The number 26 keeps popping up in peculiar places during this investigation. It will be recalled that there are twenty-six distinct "peaks" in the thicknesses of the stone courses from the bottom to the top of the structure, and likewise twenty-seven slots along the inclined ramp of the Grand Gallery where, as I have hypothesized on the basis of Dunn's work, large arrays each held eight crystalline Helmholtz-type gravito-acoustic" resonators. In other words, there is a coupling of the external surface windings of the stone course "peaks" on the exterior of the Pyramid with the internal harmonic arrays in the Grand Gallery in yet another "feedback loop". Some of these crystals - in a hypothesis that can only be called sheer speculation, yet I believe made on the basis of solid corroborative esoteric tradition - were specially constructed artificial "dark" crystals with a strange "black luminescence" that was due to a peculiar refraction index.

The Giza Death Star Deployed

(4) Harmonics of the Planck Units in the Pyramid's Analog of the Earth's Polar Radius

Since gravitational acceleration is a function in part of the mass and dimensions of the earth, then one would expect, in confirmation of the above hypothesis regarding the Grand Gallery and its arrays, that its twenty-seven arrays are meant to oscillate some harmonic of the earth. Taking the Pyramid's polar radius measure of 3949.89 miles as given by Capt, and dividing this measure by 27 yields some highly suggestive results, for if each of the quotients of the polar radius is in turn divided by the theoretical coefficients of the Planck units preciously adopted, the following table is obtained.

Harmonic Of Polar Radius	Planck's Constant H	Planck Length L	Planck Mass M _p
6626	6362	4799	
1 st 146.292	22.078	22.995	30.484
2 nd 292.584	44.157	45.989	60.968
3 rd 438.876	66.235	68.984	91.452
4 th 585.168	88.314	91.977	121.935
5 th 731.460	110.392	114.973	152.419
6 th 877.752	132.471	137.968	182.903
7 th 1024.044	154.549	160.963	213.387
8 th 1170.336	176.628	183.957	243.871
9 th 1316.628	198.706	206.952	274.355
10 th 1462.920	220.785	229.868	304.839
11 th 1609.212	242.863	252.941	335.322
12 th 1755.504	264.942	275.936	365.806
13 th 1901.796	287.020	298.931	396.290
14 th 2048.088	309.099	321.925	426.744
15 th 2194.380	331.177	344.920	457.258
16 th 2340.672	353.256	367.915	487.742
17 th 2486.964	375.334	390.909	518.078
18 th 2633.256	397.413	413.904	548.709
19 th 2779.548	419.491	436.898	579.193
20 th 2925.840	441.570	495.893	609.677
21 st 3072.132	463.648	482.888	640.161
22 nd 3218.424	485.727	505.882	670.645
23 rd 3364.716	507.805	528.877	701.129
24 th 3511.008	529.883	551.872	731.612
25 th 3657.300	548.944	574.866	762.096

26th 3803.592	574.040	597.567	792.580
27th 3949.884	596.119	620.856	823.064

Note that all of the results for the Planck Length are within two tenths of a whole number multiple or harmonic of the various quotients of the polar radius when divided by 27. This suggests a conversion of mass to length along some lines as the following.

Assuming a functional conversion of mass to length, then we have

$$\exists f: \{m \rightarrow \lambda_m$$

where f is the arbitrary function of the argument and λ_m is the wavelength of the mass conversion. The gravitational acceleration would therefore exist in some relation to this wavelength:

$$a_g : \lambda_m,$$

where a_g is the gravitational acceleration. The implications are enormous, and in keeping with T.T. Brown's gravitational investigations, for one could conceivably develop a definition of gravitational frequency for each of the elements on this basis in a kind of gravitational-harmonic periodic table of the elements. In any case, the table suggests a convenient formula:

$$1/27 r_p \sim 22.995 L$$

or simply, one twenty-seventh of the polar radius of the earth is approximately 22.995 times the theoretical coefficient of the Planck Length. As may be indicated by the analogs of certain atomic weights in the stone courses, this formula suggests that the Great Pyramid's builders may have been in possession of precisely this kind of gravitational equivalent of the periodic table of elements. However, in order to confirm some sort of length to mass functional conversion as being embodied in paleophysics, one must look carefully at the notion of "tetrahedral" hyperdimensional physics.

B. "Tetrahedral" Physics

Every physicist has, I suppose, a degree of the metaphysician in him, and conversely, every metaphysician has a degree of the physicist in him.

In that light, Richard Hoagland has more than any other popularized the notion that there once existed a sophisticated unified physics in very ancient times, a physics based on elementary geometric forms, the most basic of which is the first of the Platonic solids. In order to aid the understanding of this physics and its very simple geometry, I will proceed step by step through Hoagland's and his associate Errol Torrun's expositions of the mathematical relationships embedded in the D and M Pyramid on Mars at Cydonia, and then proceed to a speculative analysis of these in conjunction with the Great Pyramid and the scalar physics examined previously in this book. In doing so, I will attempt to construct and summarize the principles of the putative paleophysics that I have explored in this book and my previous book, *The Giza Death Star*.

(1) The Zero Summed Vector Matrix of the Initial State of the Medium and its Cosmological Implications

Let us begin with a series of "thought experiments," as Einstein called them.

Imagine an endless sea of ultra-fine spherical particles, infinitely smaller than the particles with which quantum mechanics deals. This sea is infinitely extended in every direction, and each of its particles is rotating in the same direction at the same speed relative to each other particle.

Now imagine an Observer, within this sea, on any one of these particles. Because all of the particles are rotating in the same direction at exactly the same speed, the Observer can detect no movement either of his own particle, nor of any other. Moreover, he can detect no difference of size, shape, nor, in fact, of any temporal or spatial property whatsoever, since time and space themselves are dimensional characteristics that one can only derive by comparison of differences. In effect, for our Observer, nothing whatsoever exists, save himself.

Now imagine another Observer, somehow existing outside this infinitely extended sea: God. For Him the situation is identical: endlessly rotating particles, all rotating at exactly the same velocity in exactly the

same direction, all sum to zero. Put differently, in vector analysis, an infinite number of vectors on each spinning particle, and an infinite number of such particles, still sum to zero. There is still nothing.

But recall that quaternion analysis told us something else: that each vector was accompanied by a scalar, a "pure magnitude" of directionless force. Thus, in terms of the quaternion model, the endless sea of nothing contains an infinite potential of "information in the field," which may be the source of the troublesome infinities that daunt quantum mechanics (recall the "accounting trick" of renormalization).

Now let us extend our thought experiment a bit further.

Let us imagine that our Observer administers a "thump" to one of these particles. Immediately what was an infinitely extended "nothing" both spatially and temporally, begins to take on specific characteristics, since the motion of that particular particle will become different than all the others. As a result, both time and space themselves instantly come into existence, since they can now be measured by comparison of the "thumped" particle's motion relative to all the others. We have here, in effect, a physical model of a kind of creation ex nihilo.

But how might our Observer do this? Quantum mechanics tells us the answer: merely by observing or thinking it to be. Or put differently, the Observer, by attempting to observe a difference in the particles, actually causes that difference to arise.

Note that an age old paradox is apparently resolved, for in its initial undifferentiated state of pure equilibrium, the endless sea of rotating particles itself, time and space, being dimensionless, are both infinitely extended, and yet once the "thump" is administered, they come into existence as measurable, real entities. And, it should be noted, every particle in that sea comes into existence as a measurable, real entity as well. From this standpoint, all three standard physical cosmologies - the oscillating universe, the steady state universe, and the Big Bang cosmology - each have a certain element of truth.

(2) The First Platonic Solid: Spherically Embedded Tetrahedra

Once our particle is "thumped," chances are that it will eventually careen into another particle, administering a thump to it, and so on and so on. Out of this series of collisions, the complexity of the system grows,

The Giza Death Star Deployed

and the total system begins to oscillate as the infinite potential of the information in the field begins to come into existence.

But what do all of these rotating and thumped particles, notwithstanding their slight differences of rotation and so on, have in common? Let us extend our though experiment a bit further.

If one takes a sphere of any radius, then the simplest three dimensional form which may be embedded in it is a tetrahedron. If we place this tetrahedron inside a sphere that we imagine to be rotating around an axis, and align one point of the tetrahedron on that axis, then, as a universal geometric law, the other three points of the tetrahedron will all touch 19.5° north or south latitude, depending on which pole of the sphere we orient the tetrahedron:

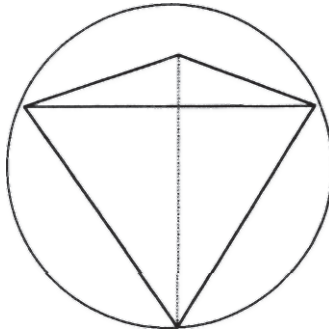

Before proceeding further in analyzing this simple geometry, we need to turn to Enrol Torrun's mathematical analysis of the dimensions of the D and M Pyramid on Mars. Torrun's analysis provided the catalyst that led to the mathematical exploration of the structures at Cydonia and to Hoagland's subsequent exposition of the tetrahedral physics and of course the intelligent design that were ultimately implied by Torun's analysis.

Laying aside the obvious, but unscientific, criterion that "if it looks like a pyramid," Torrun developed a set of four criteria to evaluate the D and M Pyramid:

1. Is the object's geometry inconsistent with known landforms and geomorphic processes? (i.e., does the object exhibit straight lines, curved

Quantum Numerology, Feedback Loops, and Tetrahedral Physics

- lines, having fixed radii, regular patterns, one or more axes of symmetry, and does the combination of these characteristics preclude geomorphology as a mechanism of origin?)
2. Is the object aligned with the cardinal directions and/or with significant astronomical events?
 3. Is the object collocated with other objects that are also inconsistent with the surrounding geology? And if so, are they geometrically aligned with each other?
 4. Does the object's geometry express mathematically significant numbers, and/or the symmetries associated with the architecture?²

Torrun also notes that these criteria themselves are not sufficient to denote intelligent design, but rather that when the totality of evidence is viewed as a whole the possibility of natural origin is precluded. "This is precisely," he maintains, "the same 'convergence of evidence' technique used in the photo-interpretation of aerial photography and satellite imagery."³

Pursuing "the most conservative possible approach" precisely because mathematical relationships in the Great Pyramid had been abused "by mostly well-meaning investigators" in attempts to prove "various theories," Torun also notes that he chose to concentrate on the simplest mathematical relationships:

1. The values of observable angles expressing radian measure.
2. Examining the ratios formed between the observable angles for equality with mathematically significant numbers.
3. Examining the Sine, Cosine, and Tangent of measured angles for the presence of mathematically significant numbers.⁴

The five-sided D and M Pyramid is then reproduced:

² Eerol Toerun, "D&M Pyramid - Criteria." www.his.com/~tharsis/pyramid/criteria.html

³ Ibid.

⁴ Ibid.

The Giza Death Star Deployed

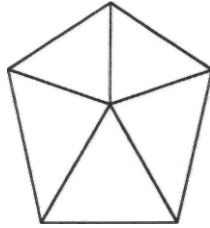

Torrun then observes that the D and M Pyramid on Mars displays a "complex interplay between a five-fold and six-fold symmetry" since "both symmetries are present simultaneously," a technique of embedding that was also "widely practiced by the architects of antiquity" because "it was believed that geometry and certain mathematical relationships were crucial building blocks of the Cosmos."⁵ The following diagrams of this embedded six-fold and five-fold symmetry are then produced:

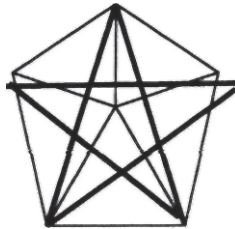
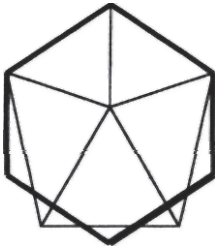

⁵Ibid.,

Noting that the angles of the D and M Pyramid are not equivalent means that ratios can be constructed, ratios displaying "significant values with a preponderance of square roots and fractions involving square roots." Specifically, the ratios yield values that are close approximations of $\sqrt{2}$, $\sqrt{3}$, and of e/π . π 's significance is known to most people, but e , it should also be noted, is the basis of logarithms. Most interesting is the fact that geometrically expressed, the ratio of e/π is nearly equivalent to that of $\sqrt{3}/2$.

This last ambiguous relationship between e/π and $\sqrt{3}/2$ leads Torun to the geometry of a circumscribed tetrahedron as the resolution of the ambiguity. Noting that the sine of 60° is defined as $\sqrt{3}/2$ gives a value of 0.866025, and e/π gives 0.865256, the resolution appears tetrahedral. This is because "the surface area of a sphere, divided by the surface area of the tetrahedron circumscribed by it, yields a very close approximation of e which shall be termed e' : $s = 2.718282$; $e' = 2.720699$." Substituting e' into the ratio e/π , or e'/π gives a result of 0.866025 which is approximately equivalent to $\sqrt{3}/2$. This would tend to confirm the hypothesis that we have advanced here and in The Giza Death Star that the basis of the harmonic unification of physics was via engineered geometric approximations of fundamental constants.

Hoagland's website, however, reproduces another intriguing geometric pattern, one on which he does not comment at great length. If one now imagines two tetrahedra embedded in such a rotating sphere of any radius, aligning one tetrahedron on one pole and the other on the other pole, and orienting them with respect to each other so that they are exactly perpendicular to each other in their rotational symmetry, then one encounters a very familiar symbol of the sacred geometry of various occult systems:

The Giza Death Star Deployed

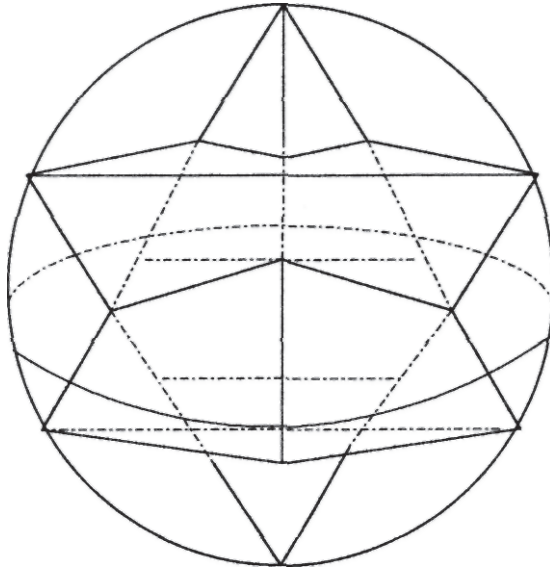

The familiar form is, of course, the "Star of David", the Babylonian symbol that the Hebrews brought back with them on their return to Palestine after the Exile, and that has since become the most famous symbol of the Jewish religion. But it may be the most famous symbol of a sophisticated physics, as we shall see.

The first thing one notes is its similarity to the geometry of the Giza compound if rotated around an axis running through the top of the Great Pyramid, as was seen in chapter four:

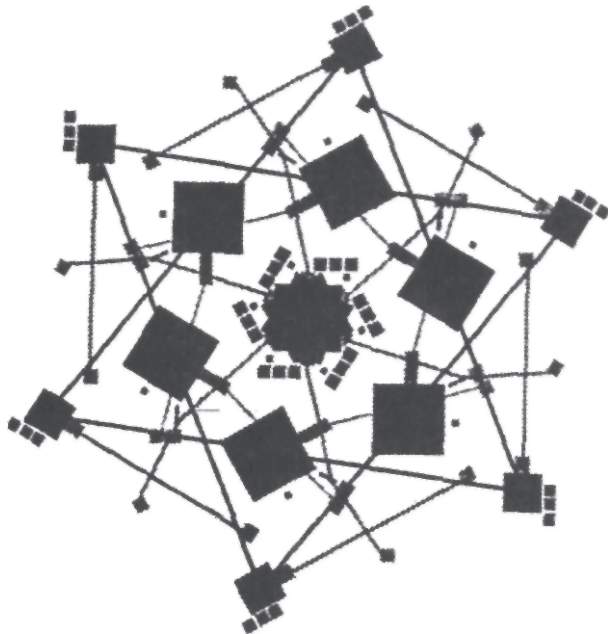

This similarity tends to confirm the hypothesis of Alan Alford that was examined in chapter two, namely, that the Second Pyramid, the Sphinx, the third pyramid and the "temples" and "causeways" appear to have been built much later than the Great Pyramid, but built on a precise geometric plan. That is, the other major structures may have been built on sites that previously existed and that were once occupied by something else, or may have been built on sites that were already a part of the original design. In any case, it would appear that when considered as a compound, the whole complex is designed deliberately to rotate fundamental geometries of space, and therefore, that the compound is a two dimensional analog of the three dimensional phenomenon of two embedded tetrahedra. In short, the Giza Compound is a large scale example of the same tetrahedral physics and mathematics that Hoagland and Torrun have discovered on Mars at Cydonia.

This would tend to confirm another hypothesis advanced by Hoagland and others: whoever built the Cydonia compound and the Great Pyramid and laid out the geometry of Giza may have been one and the same group. In any case, the physics represented is the same, and if the function of the

The Giza Death Star Deployed

Great Pyramid was indeed as a machine, as a weapon of some sort, then we have possibly one clue as to the function of the Cydonia complex as well. And this in turn would tend to corroborate our hypothesis that the civilization that built the Great Pyramid may indeed have been capable of interplanetary travel... and interplanetary warfare.

But what, exactly, is that physics? Hoagland does not comment on the figure, nor on the peculiar hexagonal region formed at the plane of intersection of the two embedded tetrahedra. He has made claims that the embedded tetrahedral geometries represent an exciting new source of energy, and on this basis has made predictions about features of planetary and celestial mechanics that have subsequently been verified. Yet, he remains curiously reticent on stating exactly why this geometry should represent a new source of energy and what exactly that energy is. I believe he is silent because he knows full well the vast implications of the physics involved as well as the potential for a dreadful weaponization of that physics. Here we can only speculate what the physics of these embedded tetrahedra really means.

Let us return, for a moment, to the notion of vector analysis, translation vectors, and quaternion geometries, and recall that in standard vector analysis, a zero sum vector matrix says that the following diagrams result in a translation vector of zero, even though it is apparent that the geometries themselves represents very different internal rotations and stresses:

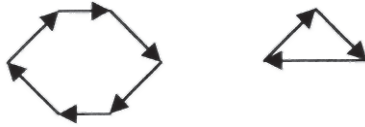

It will be recalled that in vector analysis, the sum of forces in both of the above simple two dimensional geometries, since there is no scalar component, is zero. But in quaternion analysis, since each vector is composed of the vector itself plus a scalar (i.e., a measure of pure magnitude with no direction), the sum of forces present in the two geometries is radically different, with the hexagonal figure being actually

the sum of six scalars, looking something like this: $a^2 + b^2 + c^2 + d^2 + e^2 + f^2 > 0$.

Now let us take the process of vector analysis a bit further, and note that each face of a tetrahedron can model a vector system summing to zero, with a quaternion sum of three scalars. "Unfolding" or "squishing" the three dimensional tetrahedron into a two dimensional representation allows us to see how a zero-summed vector analysis of the system would nevertheless produces certain stress points or "potentials", precisely where Hoagland maintains that rotating masses have such upwellings of energy, at 19.5° degrees north or south latitude:

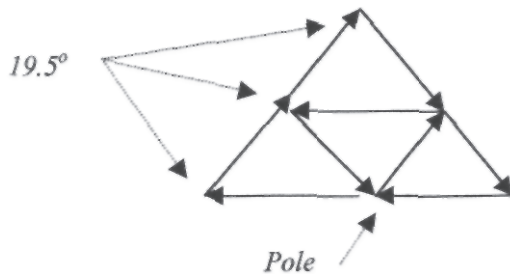

Now let us return to the diagram of the embedded tetrahedra and assume that each line of the tetrahedron represents a vector of force such that the tetrahedra represent a spatial geometry where the vectors sum to zero, i.e., where no translation vector results. Let us first once again "squish" the figures into a two dimensional representation. A simple pictorial representation of this concept would look something like this:

The Giza Death Star Deployed

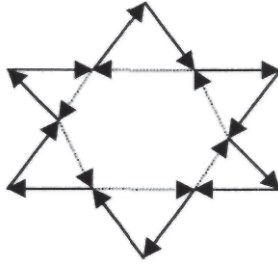

Here again one may see how the geometry - at some risk of oversimplification - models two interlocking systems both of which separately sum to zero, and both of which together sum to zero, but now with an enormous scalar potential in quaternion analysis, since each vector, on that analysis, is comprised of a scalar component, a pure magnitude of force. "Unfolding" our diagram back into three dimensions looks like this, and note how the "stress points" are revealed as the two types of spaces interact:

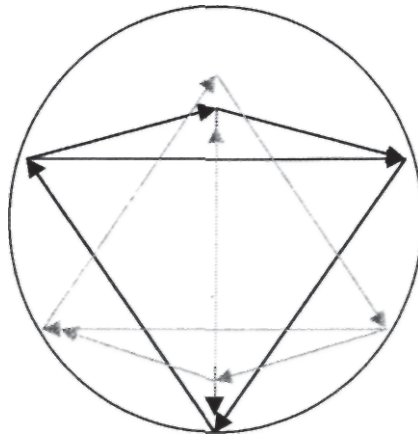

This diagram leads one to a series of rather astonishing speculations, not the least of which is that any spherical mass of any dimension or scale

whatsoever may be modeled as an internal tetrahedrally configured stress in the medium. And that postulate leads to another: one may stress any spherical mass of any scale by rotating fields of forces "tetrahedrally", i.e., by taking the two embedded tetrahedra out of their symmetrical opposition to each other. In other words, this simple geometry of the Platonic solid, one of the oldest symbols in existence, may actually at one time have represented the simplest possible geometric description of the "reaction space" of the three dimensional with hyperdimensional worlds. One might go even further.

By rotating tetrahedra in such a manner, a toroid or "donut" shape is described by the vertices of the tetrahedra at 19.5° north or south latitude. One therefore might equally model charged particles in terms of such inscribed tetrahedra on a virtual spherical space of tiny dimension.

In terms of the weapon hypothesis it is this diagram, in other words, that is the original "death star," for the alignments of the Great Pyramid with Sirius - the "death star" of occult lore - are not the original association of the structure with death. The tetrahedral geometry itself is the "death star," for it makes possible the basic physical model of the system.

Why this is so will perhaps be made clearer if we connect the previous speculations on the Planck length harmonics of the earth's polar radius with the "tetrahedral physics" of this fundamental Platonic solid. It was suggested that the table of results of those harmonics implied a functional conversion of mass to length such that a "gravitational frequency periodic table of the elements" might once have existed.

The connection to tetrahedral geometries is this. Since the sphere circumscribing two such rotated and embedded tetrahedra may be of any size, let us assume then that it represents a sphere of the radius of one wavelength λ_m of an atom of any given element. Since that wavelength is a gravitational "frequency" peculiar to that element, the resulting dimensions of the sphere and embedded tetrahedra represent the geometries of that element in its stable state (orthorotated or "perpendicular" tetrahedra) and in an unstable state crossing the threshold of stability, the tetrahedra being rotated to produce a "wobble" or cavitation in the nucleus of any given atom. One may likewise make another prediction that I will state clearly here: that eventually it will be

The Giza Death Star Deployed

discovered that there is a tetrahedral geometry to the phenomenon of photon entanglement.

If this speculation is so, it leads to another: the "wobble" or cavitation in such stressed regions of the medium would be evident to us as electron "jumps" from one state to a higher or lower state, with corresponding emissions of photons. That is, the photoelectric effect is an electromagnetic "three dimensional signature" of an inertial and gravitational phenomenon occurring in the nucleus and the medium itself occurring in a space with different dimensional properties, exactly as Brown's investigations revealed. The "wobble" could be represented by an asymmetry in the hexagonal plane on the equator of the sphere and the two embedded tetrahedra. In short, that hexagonal structure represents a simple geometry of the reaction space, or phase space, of any matter in any mass and dimension.⁶ The geometric dimensions of that hexagonal structure, whether of the symmetric and orthorotated tetrahedra, or any particular asymmetrical configuration, may thus be an ultimate basis of the geometry of phase space, photon entanglement, and the now emerging theories of the cellular structure of large systems. But more on this in a moment.

Thus, we may speculate that the diagram also represents a simple means of saying that any atom represents a stress - stable or unstable - in the medium. Thus, on this model, observable phenomena such as charges -protons, electrons, neutrons - and mass represent the results of that stress, not its cause.⁷ And consequently, the medium may be so stressed as to cause any element or combination of elements to cross the threshold of stability, or at lower orders of stress, cause any element or combinations of elements to reconfigure themselves.

⁶ It is to be noted that this geometry is scale invariant. Hoagland does provide the polar pictures of clouds around Saturn's pole, which evidences a clear hexagonal pattern, as evidence of the truthfulness of his tetrahedral physics and its ability to make predictions.

⁷ This tends to confirm LeBon's notion of radioactivity as the result of the configuration space of an atom and its medium, rather than the standard view of radioactivity as an inherent condition of instability in certain elements. All elements, on this view, come in "stable" and "unstable" states, some tending toward one, others toward the other, state depending upon their inertial geometries.

The diagram, and its deadly potential for weaponization, represents the true "death star" hidden at Giza, beyond the Great Pyramid itself.⁸

But how does all this specifically relate to the Great Pyramid and to the discovery of harmonics of the Planck units embedded in it? Very simply stated, the geometry models something that is scale invariant, i.e., something as applicable to planetary mechanics (as Hoagland construes it), as well as something on much smaller scales of size. In chapter seven we saw how quaternion analysis leads to a dimensionless interaction of the coefficients of the constants themselves. So the question now becomes "Is there a tetrahedral basis to this dimensionless interaction of constants?" That is, taking any system of embedded tetrahedra in a spherical mass to represent the simplest possible geometry of the relationship and interaction of normal three dimensional space (the sphere) and hyperspace (the tetrahedra), may one develop certain basic arithematical "harmonic equations" of the relationships of the fundamental geometric and physical constants π , e , ϕ , h (Planck's constant), L (the Planck length) and M_p (the Planck Mass)? The answer is an astonishing and resounding "Yes!"

Imagining our sphere now to be very tiny, with a radius equivalent to the Planck Length L , one may assign the harmonic value of that unit, or a coefficient of 6362 as the fundamental resonance of the radius of that sphere. Noting now that that the radius touches three vertices of each tetrahedron precisely at 19.5° north or south latitude on this incredibly small sphere of space, the following very simple trigonometric diagram may be made of the relationship between normal and tetrahedral hyperspaces:

⁸ This requires some comment by way of commentary on Richard Hoagland's behavior in public interviews. Many people, this author included, have repeatedly begged Mr. Hoagland to "get down to specifics" and "publish the details." Beyond the fact that Mr. Hoagland's associate Errol Torrun has done precisely that, and beyond the fact that Mr. Hoagland himself made several predictions concerning celestial and planetary mechanics based on this mathematics that seem subsequently to have been borne out, one is still left with a disquieting reticence on his part to disclose too many of the details. I firmly believe that one reason he is reluctant to do so is precisely for the reason that the physics involved represents a vast and awesome destructive potential for weaponization.

The Giza Death Star Deployed

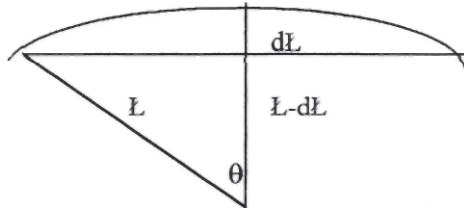

[1] $L/\sin 30^\circ = dL/\sin 120^\circ$, which reduces to

[2] $L (\sin 30^\circ) = dL (\sin 120^\circ)$. Further reduction gives

[3] $[L (\sin 120^\circ)]/\sin 30^\circ = dL$, which gives the values

[4] $L (.866)/.5 = dL$.

(For those unfamiliar with the calculus, the symbol "d" is often mistaken to be an algebraic symbol, representing a number to be found at the conclusion of some problem. Such is not the case, however. The symbol "d" simply means "the differential of, or more plainly put, "a little bit of or "some increment of the value of the symbol which follows it. Thus, $n = [n-dn] + dn$.)

This may be written as a generalized relationship since .866 so closely approximates e/π :

[5] $dL/\sin FI = n(e/\pi)L$,

where n is any number. This gives us our first tetrahedral harmonic equation:

[T1] $dL/\sin FI \sim n(e/\pi)L$.

This in turn suggests that further relationships between the universal geometric constants e , FI , and π and the Planck units h , L , and M_p may be defined:

Quantum Numerology, Feedback Loops, and Tetrahedral Physics

$$h = 237.065$$

$$[6] \text{PI}/2 = 1.570795 = 1570795 \text{ harmonic} / \quad L = 246.903$$

$$M_p = 327.317$$

This gives two results within .2 of a whole harmonic. Moreover, the ratios of the two closest results also give close approximations to the Pythagorean Comma ratios developed in The Giza Death Star. Two further equations may be developed:

$$[T2] \text{PI}/2 \sim 237.065h$$

$$[T3] \text{PI}/2 \sim 246.903 L.$$

The tetrahedral relationships between the geometric constants and the Planck mass and Planck length are even more intriguing.

Torrùn speculates on the existence of a tetrahedral version of the constant e , which is designated by the symbol e' . Taking the coefficients of PI as 314159 and of e' as 272070, the following relationships between e' , and PI obtain:

$$e'/\text{PI} = .86603 \quad \text{PI}/e' = 1.15470.$$

Converting to coefficients gives

$$e'/\text{PI} = 86603 \quad \text{PI}/e' = 115470.$$

Dividing these two relationships by the Planck mass and Planck length coefficients gives:

The Giza Death Star Deployed

$$(e'/\text{PI})/M_p = 18.04668 (\text{PI}/e')/L = 18.14995.$$

The difference between the results is 0.10327.

Others have noted the connection between the Fine Structure Constant and the Pythagorean Comma.

Robert Temple, whose work *The Crystal Sun* we encountered early on in this work, is best known for his bestseller on the highly accurate astronomical knowledge of the African Dogon tribe (likewise encountered earlier in this work), *The Sirius Mystery*. Let us cite his remarks on the astonishing astronomical knowledge encoded at Giza and its peculiar relationship to the Pythagorean Comma which was discussed at length in my previous work, *The Giza Death Star*:

According to the new figures, Sirius B has a mass 1.053 that of our sun.

It is now possible to make a correlation whereby the Great Pyramid may be seen to represent Sirius B and the Pyramid of Khephren⁹ may be seen to represent our sun.

If we follow my line of reasoning, we find a correlation accurate to two decimal points. The way I have arrived at it is this: according to the leading authority on the pyramids, Dr. I.E.S. Edwards, the measurement of each side of the base of the Pyramid of Khephren was originally 707.75 feet. As for the Great Pyramid, Edwards says that the original measurements of the four sides of the base were: North 755.43 feet, South: 756.08 feet, East: 755.88 feet, and West: 755.77 feet. The mean of these four measurements is 755.79 feet. If we compare the mean side of the base of the Great Pyramid with the side of the base of the Pyramid of Khephren, we find that the larger measurement is 1.0678 that of the smaller. We know from the new astronomical data that the mass of Sirius B is 1.053 that of our sun. The correspondence is thus accurate to 0.014. However, even this tiny discrepancy may be highly significant. For 0.0136 (which rounded off is 0.014) is the precise discrepancy between the mathematics of the octave and the mathematics of the fifth in harmonic theory, which 1.0136 is referred to as the Comma of Pythagoras, and was known to the ancient Greeks who are said to have obtained knowledge of it from Egypt.

...I have done a great deal of work on the Comma of Pythagoras over many years, and I found it necessary to give a name to the decimal increment of 0.0136 itself: I have named it the Particle of Pythagoras.... I believe the numerical coefficient of this Particle, 136, is related to the 136 degrees of freedom of the electron discussed by the famous physicist, the late Sir Arthur

⁹ "The Pyramid of Khephren", i.e., the Second Pyramid.

Quantum Numerology, Feedback Loops, and Tetrahedral Physics

eddington, and that the number plus one gives the Fine Structure Constant of physics, which is $137.$ ¹⁰

Now we may return to the peculiar result of 0.10327.

Note that if we then divide the coefficient of this result by two, we obtain the result of 5163.5. It is perhaps significant that the angle of the Pyramid's faces is $51^\circ 51' 14''$ of arc.

Putting all this together, we may derive a first harmonic equation of the tetrahedral relationships between the Planck Length and Planck Mass:

$$[1] (\epsilon'/\pi)M_p \cong (\pi\epsilon')L.$$

In other words, there would appear to be some sort of n-dimensional tetrahedral geometrical basis for a mass to length conversion function.

We may explore this functional relationship further by introduction of the Fine Structure Constant (symbolized by \hbar), with a value of 1/137:

$$[(\epsilon'/\pi)M_p] \cdot \hbar = 131728, \text{ or}$$

$$[(\epsilon'/\pi)M_p] \cdot \hbar \approx 10 + \pi, \text{ and}$$

$$[(\pi\epsilon')L] \cdot \hbar = 132481, \text{ or}$$

$$[(\pi\epsilon')L] \cdot \hbar \approx 10 + \pi$$

or a difference of 0.0753. Thus, one may derive a further tetrahedral harmonic equation:

$$[(\pi\epsilon')L] \cdot \hbar \cong [(\epsilon'/\pi)M_p] \cdot \hbar \approx 10 + \pi.$$

¹⁰ Robert Temple, *The Sirius Mystery: New Scientific Evidence of alien Contact 5,000 Years Ago* (Rochester, Vermont: Destiny Books, 1998), pp. 23-25. Temple of course means that the Fine Structure Constant has a numerical coefficient of 137, since its actual value is close to 1/137.

The Giza Death Star Deployed

For our purposes, we note a confirmation of the speculative development of a functional conversion of mass to length mentioned previously, since the above equations may be developed further:

$$dL/\sin\theta \approx 1930.1859 n M_p, \text{ and}$$

$$d(\pi/\epsilon)/\sin\theta \approx n (\epsilon/\pi)L,$$

where n designates any number or harmonic of the other quantities in the designated function. Note that the coefficient 19301859 is quite close to the tetrahedral angle of 19.5 degrees (placing the decimal at 19.301859).

By incorporating Planck's constant \hbar into previous results, the tetrahedral nature of the relationships becomes even clearer:

$$\frac{[(\epsilon'/\pi)M_p] \cdot \hbar}{\hbar} \cong 19.94$$

$$\frac{[(\pi\epsilon')/L] \cdot \hbar}{\hbar} \cong 19.94$$

Adding the constant PHI to the mix confirms another tetrahedral angle:

$$\frac{[(\epsilon'/\pi)M_p] \cdot \hbar}{\hbar} \cong 32.26651$$

$$\frac{[(\pi\epsilon')/L] \cdot \hbar}{\hbar} \cong 32.26651.$$

It is my intuition that these equations are telling us how to oscillate the "tetrahedral" hyperspatial signature of any mass, if certain features are known. It is telling us to configure resonance in a relationship to the terms PI, e', M_p, L, h, and PHI.

Quantum Numerology, Feedback Loops, and Tetrahedral Physics

A final confirmation of the tetrahedral properties of gravity is confirmed if we take the result of $10+\text{PI}$ and divide it by the coefficient of the gravitational constant, 667259, its coefficient in the metric system(!):

$10+\text{PI}/G= 1.96949$. Thus:

$$\frac{[(\pi/\epsilon')L] \cdot p}{\hbar} \cong 19.94 \cong \frac{[(\pi/\epsilon')L] \cdot p}{G}$$

and

$$\frac{[(\epsilon'/\pi)M_p] \cdot p}{\hbar} \cong 19.94 \cong \frac{[(\epsilon'/\pi)M_p] \cdot p}{G}$$

That is to say, disconcerting as I find mixing metric with Pyramid measures to be, that it appears the relationship of the coefficients of the primary physical constants is tetrahedral in nature. Obviously, a genuinely topological and mathematical analysis of these relationships would be much more complex, but the arithmetic interaction of the scalars (the coefficients themselves) is there, and it may be telling us something very significant.

Conclusions

The following conclusions seem to be implied by these speculations:

1. In contradiction to current widely held belief, relativistic mass-to-length conversions may occur on the quantum and sub-quantum levels in a locally engineerable space;
2. In contradiction to current widely held belief, these conversions may be founded upon rather simple geometric and harmonic functions;
3. There are fundamental relationships between abstract and scale invariant geometric constants and the fundamental constants of

The Giza Death Star Deployed

quantum mechanics, and these relationships may be tetrahedrally modeled;

4. A tetrahedral modeling along the lines suggested further implies that tetrahedral physics was the method perhaps once pursued as the means of the harmonic unification of physics, i.e., of the "well-tempering" of all aspects of the frequency spectrum from the very low frequency of large masses' and systems' inertial mechanics through the acoustic range and on to the very high frequency of the electromagnetic, and presumably, gravitational, spectrums; and,
5. The presence of the symbolical form of two orthorotated tetrahedra within a sphere, as of significant and redundant harmonic multiples of the various Planck units in dimensional measures of the Great Pyramid, as well as close approximations of the Pythagorean Comma in some ratios of the previous equations suggest quite strongly that such a "well-tempered" harmonically unified physics once existed, and that its mathematical modeling was profoundly simple.

Speculation can take one only so far, but I believe enough evidence has been presented to constitute a sufficient *prima facie* case for the hypothesis that the Great Pyramid was a vastly, hugely, sublimely integrated marvel of military engineering of unparalleled offensive powers of mass destruction.

But why only military? Surely a case could be made that the unified technology implied by the unified phenomenon of electric impulse could have been built for purely benign purposes.

Could the structure and its "electro-gravito-acoustic inertial space warp shock wave" not have been configured in a very weak state for communication purposes? Most certainly it could have been so configured. Could it not have been configured to beam power all over the earth, and possibly elsewhere? If the principles herein examined are true, then again, most assuredly it could have been. Could it not have been configured to provide motive and propulsive force? Perhaps. Might it not have been used to provide "defensive bubbles" or "force fields" around a region under attack by an enemy or, for that matter, out of control weather phenomena? Possibly. Could it have been configured to obliterate enormous targets? Very likely.

But which of these purposes seems most plausible to me is based on the most obvious of all the evidence concerning the Great Pyramid, and that is its sheer size and the enormous amounts of effort that went into maintaining such amazingly close tolerances in almost every aspect of the structure. Millions of tons of rock engineered in a vast integrated system of feedback loops, atomic weight-and-geometric correspondences, resonator arrays, infrasound generation and amplification chambers, huge electrical capacitance, cohered electromagnetic output, possible plasma pinching (and definite hydrogen presence), piezoelectric effect, and a monstrously long catalogue of precise mathematical and geometric constants, including that essential constant to nuclear physics and quantum mechanics, were not ever found in any system proposed by geniuses such as Tesla or Brown or Farnsworth for communication, or mere power production. The scale, scope, and probably prohibitive cost and inconceivably enormous and destructive output of its integrated engineering exceed any imaginable purpose save one.

It was conceived, designed, built, and deployed, as the most horrific weapon of mass destruction mankind has ever known or is likely to know. Its malignantly sublime integration of the known constants and forces, and their configuration in the overkill of the space-distorting Shockwave of superluminal velocity, was not, in the final analysis, overkill at all, but essential if one wanted to wreak wholesale devastation on a regional or planetary scale with but one single, but very unique, weapon.

THE POWER OF SHAPES AND THE FIRE WITHIN

"Every shape manipulates aether in some manner. "

Dan A. Davidson¹

"A detailed analysis of the fundamentals of quantum physics carried out recently by the author has shown that a vague vacuum of quantum physics and an empty space of general relativity should make way for a single substrate. "

Dr. Volodymyr Krasnoholovets.²

The word "pyramid" possibly comes from two Greek words, "**πυρ**" meaning "fire" and possibly one or two other words: "**μηδος**", meaning "counsels, plans" or even "schemes, cunning craft," and another similar word meaning "guardian". Thus the word "pyramid" would mean something like "artful" or "cunning fire", or "guardian of the fire." It is also often said that the word "pyramid" means "the fire within," if the second part of the word - "mid" - is traced to yet a third possible Greek origin.

But when all is said and done, there is no real satisfactory explanation for the Greek origins of the word "pyramid," for the word itself is Egyptian in origin. Whatever the mysterious etymological connections between the Egyptian original and the later Greek may be, the original Egyptian word for a pyramid, Per-Neter, signifies a structure or shape that was designed "to generate, transform, utilize and transmit energy."³ In both their ancient Egyptian and classical Greek senses, the words suggest that the pyramidal shape itself is designed to tap into, and direct, some form of energy.³

It was the meaning of the word "pyramid" itself, plus the consistent esoteric traditions that connected the structures to sources of power and energy, that led many researchers in the 1970s to investigate pyramid shapes and the Great Pyramid more completely. And we have already seen

¹ Dan A. Davidson, *Shape Power: A Treatise on How Form Converts Universal Aether into Electromagnetic and Gravitic Forces and Related Discoveries in Gravitational Physics* (Sierra Vista, Arizona: Rivas Publishing, 1997), p. xvii.

² Volodymyr Krasnoholovets, Ph.D., "On the Way to Disclosing the Mysterious Power of the Great Pyramid."

³ Stephen S. Mehler, *The Land of Osiris* (Kempton, Illinois: Adventures Unlimited Press, 2001), p. 48.

Shape Power and the Fire Within

how serious physicists and other scientists were investigating the structure long before that. And as was suggested in the previous chapter, there may be a geometric basis for this amazing claim that mere geometrical configuration of a structure can contribute not only to its efficiency, but also to the manipulation of the energy of the medium itself.

One such "shape power" investigator is Dan A. Davidson. Davidson is unequivocal in his acceptance of the premise of a superfluidic medium or "aether", and that matter and its various associated fields and charges are but special cases or configurations of that aether.⁴ Moreover, consciousness appears able to manipulate this medium.⁵ Davidson appears to confirm three corollaries to the Weapon Hypothesis that have been explored in the previous chapters:

1. That gravity is a special type or gradient of electric charge;
2. That the flow of Zero Point or "aetheric" energy into a nucleus can be achieved by rotation; or
3. That the flow of Zero point or "aetheric" energy into a nucleus can be achieved by sound, or harmonics.⁶

As Davidson notes, the famous (or as the case may be, infamous) nineteenth century inventor John Worrell Keely stated in 1896 that "inertia was a result of the resistance of mass to the local aethric field."⁷

For those unfamiliar with Keely, Keely claimed to have discovered twenty-seven particulate structures underlying the proton, using his beautifully weird machines based on harmonic oscillations. And all this in the late nineteenth century long before quantum mechanics had won the field. Keely was, of course, roundly denounced by the scientific community of his day as a fraud and charlatan. In the post-relativistic era Keely's notion of inertia was, of course, simply dismissed, since the Michelson-Morley experiment so "conclusively" demonstrated the nonexistence of the aether.

⁴ Dan A. Davidson, *Shape power: A Treatise on How Form Converts Universal Aether into Electromagnetic and Gravitic Forces and related Discoveries in Gravitational Physics* (Sierra Vista, Arizona: Rivas Publishing, 1997), p. 1, cf. also p. 3.

⁵ *Ibid.*, p. 3.

⁶ *Ibid.*, p. 6.

⁷ *Ibid.*, p. 7.

The Giza Death Star Deployed

That is, until theoretical physicist Hal Puthoff published a peer-reviewed paper in 1994 in *Physical Review* that said exactly the same thing, since any mass, at the nuclear level, is linked directly to the aether as a particular geometrical configuration of it.⁸ So we are back to the tetrahedral geometry explored in the previous chapter: the simplest three dimensional shapes that may be inscribed in a sphere are tetrahedra and pyramids, and these, if rotated, may account for the torroidal shapes of charged particles such as electrons and protons.

Thus, if one produced a scalar wave, which is but a stress wave in the medium itself, that "stress wave in aether would be instantaneously propagated into all time and space."⁹ This is why interferometry and analogs of Any Possible Receiver are the basis of the Weapon Hypothesis, and also why certain coefficients and materials are selected in the Great Pyramid. All analogs of physical objects - the fundamental constants and geometries associated with them - must be present to "read" the signature of any region or mass in order to stress that region, and only that region.

Stated differently, the presence of simple coefficients of the various physical constants in fundamental and harmonic multiples indicates the scalar character of the structure.

Since the basic feature of aetheric engineering is, according to Davidson, shape itself it follows that the lattice structure of crystals, relying as they do on the basic geometries of the platonic solids (especially tetrahedra, pyramids and the "simpler" solids), focuses and concentrates this energy at the points of the structure. The regularity of the a crystalline structure also explains why acoustics is the necessarily basis for tapping into the energy of the medium. By oscillating or vibrating all atoms of a given region, they will move together - physicists call this type of motion "coherence" - and thus the amount of energy flowing into the region will be greater. And of course, the greater the mass that is so oscillated, the more energy will flow into the region.

A much more substantial research into "pyramid power" was undertaken in the former Soviet Union where several large pyramids were built and their properties investigated at great expense. The research is being continued by Dr. Volodymyr Krasnoholovets of the Institute of Physics of the Ukrainian National Academy of Sciences in Kiev. Notably, Krasnoholovets has been led by his research to posit a "sub-quantum

⁸ Ibid., p. 6.

⁹ Ibid., p. 7.

Shape Power and the Fire Within

mechanics" with some peculiar properties that recall our own speculations about the tetrahedral properties of the medium.

Noting that the electromagnetic, the weak, and the strong forces of current quantum mechanics intersect at a scale of 10^{-28} cm, Krasnoholovets then takes this measure as the size of the building blocks of space itself.¹⁰ Space thus has a cellular structure - as I pointed out in my examination of the Hermetica in my previous book - where particles appear as deformations of this structure. These elementary perturbations of space itself, these "fundamental particles", Krasnoholovets very suggestively calls "inertons." Without going into the complicated argument of his paper, it is worth noting that Krasnoholovets makes mention of the "ex nihilo" characteristics:

Of special note is the approach proposed by Bounias (1990, 200) and Bounias and Bonaly (1994, 1996, 1997). Basing on topology and set theory, they have demonstrated that the necessity of the existence of the empty set leads to topological spaces resulting in a "physical universe". Namely, they have investigated the links between physical existence, observability, and information. The introduction of the empty hyperset has allowed a preliminary construction of a formal structure that correlates with the degenerate cell of space supporting conditions for the existence of a universe. Besides, among other results we can point to their very promising hypothesis on a non-metric topological distance as the symmetric difference between sets: this could be a good alternative to the conventional metric distance which so far is still treated as the major characteristic in all concepts employed in gravitational physics, cosmology, and partly in quantum mechanics.¹¹

Behind the obtuse technical language lies a series of very unique insights:

1. The current mathematical "languages" used to describe the interactions of sub-atomic particles with space is inadequate;
2. It is inadequate because it is based on a form of mathematical language where measurements of distance, or more simply, vectors are the primary thing in view;
3. A more adequate way to account for the peculiarities of quantum and sub-quantum mechanics is via set theory, that is, a mathematical language that compares the properties of systems or

¹⁰Dr. Volodymyr Krasnoholpjets, "Submicroscopic Deterministic Quantum Mechanic," p. 1.

¹¹Ibid., p. 5, emphasis added.

The Giza Death Star Deployed

sets wherein properties of distance and vectors are only sub-sets of a greater set of properties. Simply put, Krasnoholovets is saying that the fundamental language of physics must change from a linear mathematical language - points, lines, planes, vectors and so on - to a non-linear language inclusive of such things but not limited to them. Hence his emphasis on information. Sets of physical properties, on this view, are a much fuller description of the "information in the field."

Thus, like Keely long before, Krasnoholovets introduces the idea that the fundamental relationship between a particle and space itself is harmonic in nature, since a particle, by moving, exhibits inertia and sets up an oscillation in space itself. Or as he puts it, "It is the space substrate, which induces the harmonic potential responding to the disturbance of the space by the moving particle" itself that is in primary view.¹²

But what has all this to do with pyramids? Krasnoholovets' answer is rather breathtaking:

Let A be a point on the Earth's surface from which an inerton wave is radiated. If the inerton wave travels around the globe along the West-East line, its front will pass a distance $L_1=2*\text{PI}*r_{\text{earth}}$ per circle. The second flow spread along the terrestrial diameter; such inerton waves radiated from A will come back passing distance $L_2=4*\text{PI}*r_{\text{earth}}$. The ratio is

$$L_1/L_2 = \text{PI}/2.$$

If in point A we locate a material object with linear sizes (along the West-East line and perpendicular to the Earth's surface) such that it satisfies (the above) relation, we will receive a resonator of the Earth's inerton waves.¹³

That is, the Great Pyramid, because it is constructed in precisely such a fashion and geometric disposition with respect to the earth, is a coupled harmonic oscillator of the very inertial properties of the planetary space

¹² Ibid., p. 13. For those of a more technical inclination, this means that the probability wave function ψ of standard quantum mechanics becomes a range that defines a particle's inerton cloud, having dimensions of λ along the vector of movement and 2λ in the transverse direction. Since inerton clouds can interact with each other, the wave structure that results is similar to "ultrasound" which can "destroy, polish, or crush" an object(p. 19).

¹³ Ibid., p. 20, emphasis added.

Shape Power and the Fire Within

itself. If there is any doubt that this is what the Ukrainian physicist means, he dispels it immediately:

Note that the Earth inerton field is also the principal mover that launched rather fantastic quantum chemical physical processes in Egyptian pyramids...power plants of the ancients that has recently been proven by Dunn.¹⁵ This means that the Great Pyramid is fundamentally a coupled harmonic oscillator of gravitational energy itself, since in Krasnoholovets' view such inerton waves are "carriers of the inert properties of particles"¹⁵ and therefore are the "real carriers of gravitational interaction."

According to the Ukrainian physicist, pyramids come in three basic shapes, defined by their relationship to the ratio of the side "a" of the pyramid to its height "h". Three shapes emerge:

1. A "sharp" pyramid, where the ratio a/h is less than $\pi/2$;
2. The Great Pyramid itself, where the ratio a/h is almost exactly $\pi/2$;
3. And an "obtuse" pyramid, where the ratio a/h is greater than $\pi/2$.

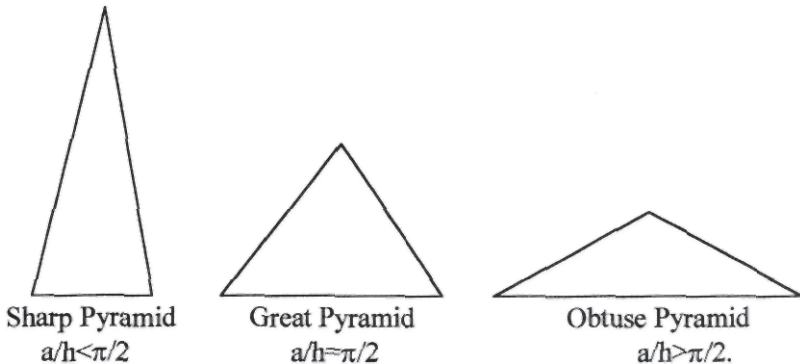

¹⁴ Ibid.

¹⁵ Ibid., p. 21.

¹⁶ Ibid., p. 22.

The Giza Death Star Deployed

What would the functions of these different pyramidal shapes, as defined by the crucial ratio $\text{PI}/2$ be? Krasnoholovets speculates that "the sharp pyramid plays the roll of a radiator" and that it may also "function as an antenna absorbing inerton radiation from outer space."¹⁷ The obtuse pyramid "to the contrary...may rather function as a radiator that emits emplified inerton waves into the Earth surface."¹⁸ And thus, the most efficient shape to combine both functions would be in the dimensions of the Great Pyramid itself, "the happy medium."¹⁹ The use of the sharp pyramidal shape as a radiator or antenna is interesting, for a similar idea was posited as the actual physical function of obelisks by David Hatcher Childress.²⁰

Krasnoholovets also describes a series of medical and electrical experiments undertaken by the Soviet and later the Russian government, including research into pyramidal effects on antiviral activity in immunoglobulin,²¹ various longevity experiments,²² and the effects of pyramidal shapes on damping and defeating electrical fields.²³ But why would a serious theoretical and research physicist of the former Soviet Union be researching pyramids?

Krasnoholovets is unusually candid about the relationship of the Institute of Physics of the Ukrainian National Academy of the Sciences. "Our institute," he notes, "was one of the leading scientific centers of the former USSR; in particular, it holds the leadership and continues to maintain the lead in the expertise needed in military research."²⁴ One has difficulty imagining a former Soviet research institute of physics investigating pyramids solely for medical reasons or the peaceful production of power. Perhaps the Soviet scientists were familiar with the ancient Sumerian texts reproduced by Sitchin that suggested a weapon function for the Pyramid. And perhaps, too, it is significant that Soviet

¹⁷ Volodymyr Krasnoholovets, "On the Way to disclosing the Mysterious Power of the Great Pyramid," p. 14

¹⁸ Ibid.

¹⁹ Ibid.

²⁰ David Hatcher Childress, *Atlantis and the Power System of the Gods: Mercury Vortex Generators and the Power System of Atlantis* (Kempton, Illinois: Adventures Unlimited Press, 2002), pp. 255-281.

²¹ Krasnoholovets, "On the Way", p. 3.

²² Ibid., p. 4.

²³ Ibid., p. 5.

²⁴ Ibid., p. 3.

Shape Power and the Fire Within

interest in the pyramid power began at approximately the same time that Sitchin published his texts in *The Wars of Gods and Men* in 1987. In any case, the appearance of Krasnoholovets' papers on pyramid power several years after Lt. Col. Thomas Bearden first raised the warning about Soviet research into scalar weaponry tends to confirm Bearden's analyses, and gives them, to coin a pun, a definite shape.

11.

THE OTHER PYRAMIDS

"By applying Tesla 's technology in the Great Pyramid, using alternating timed pulses...we maybe able to set into motion 5,273,834 tons of stone! If we have trouble getting the Great Pyramid going, there are three small pyramids nearby that we can start first to get things going. "

Christopher Dunn'

"(Bob Vawter) found overtones and resonance effects that recorded at different frequencies than those measured previously by other researchers in the Great Pyramid This evidence enabled us to speculate that the Per-Neters may have been 'tuned' to different frequencies to resonate harmonically with each other. "

Stephen S. Mehler²

On investigating the two pyramids at Dashur, I was struck by the fact that they both have exactly the same height, 105 meters, and the same final sloop in their upper parts of 43°22'. This cannot have occurred by coincidence. "

Alan F. Alford³

The Great Pyramid, while certainly the most unique, is of course not the only pyramid in Egypt, or for that matter the world.

However, the idea that it was a weapon based on the principle of the harmonic oscillation of the properties of space itself does suggest a possible explanation for the other Egyptian pyramids. As has been pointed out in previous chapters, the layout of Giza itself suggests that the other structures, while not necessarily built at the same time, all had some function to perform in perhaps enhancing the overall efficiency of the weapon. And if it was not a weapon, Dunn may very well be correct that the other structures were somehow used to "get things going." And David Hatcher Childress has pointed out the possible use of obelisks (or more ancient objects they were patterned after) in an extension of Dunn's "power plant" hypothesis. It is worth noting that the pyramidion on top of

¹ Christopher Dunn, *The Giza Power Plant: Technologies of Ancient Egypt* (Santa Fe, New Mexico: Bear and Company, 1998), p. 149.

² Stephen S. Mehler, *The Land of Osiris* (Kempton, Illinois: Adventures Unlimited Press, 2001), p. 120. Mehler uses the term "per-neter" as an ancient Khmetian term for "pyramid." Mehler is referring to the Red Pyramid at Dashur, some miles south of Giza

³ Alan F. Alford, *The Phoenix Solution: Secrets of a Lost Civilization* (London: Hodder and Stoughton, 1998), p. 61.

The Other Pyramids

many obelisks has precisely the side to height ratio of greater than $PI/2$ that Krasnoholovets maintains is a property of antennae or power radiators.

In any case, on the power plant and "system grid" view, we may posit that the other Egyptian Pyramids were resonant to some specific harmonic of local space. Of course, we maintain that the analogs of various properties of Any Possible Target are unique to the Great Pyramid alone in the degree to which those analogs are present in so many harmonic combinations and "feedback loops." That multiplicity argues very strongly that it was a weapon. But the same basic physics and technology, as should now be obvious, could also be configured with relative ease for almost any purpose from power production to communication. So a brief exploration of some of the unusual properties of the other Egyptian pyramids is in order here. We will concentrate on Dashur, and two other famous Egyptian pyramids, the Red Pyramid and the "Bent" Pyramid.

A. Dashur: The Standard Egyptological Explanation

According to the outmoded (and quite irrelevant) views of standard Egyptology, the Dashur site was built by Sneferu, who first tried to "out build" the Great Pyramid by deciding on the steep incline angle of 54° for the Bent Pyramid, but when this soon proved unfeasible, abandoned the idea for the less severely inclined angle of the upper portion of the structure. Being unsatisfied with the "imperfect" result of the "Bent" Pyramid, Sneferu then decided to build a better "tomb" for himself and thus built the Red Pyramid. Moreover, according to the standard line of Egyptology, since Sneferu fathered Khufu, who they maintain built the Great Pyramid, the Dashur site is evidence of the "progress" in pyramid-building that one would expect to find leading up to the massive structure at Giza. The Dashur experiment came first, they maintain, and the perfection of the art occurred later, at Giza.

1. The Red and Bent Pyramids

Originally sheathed in brilliant white limestone casing like the Great Pyramid, the Red Pyramid of Dashur gets its name from the red stones revealed when its casing stones were stripped away through the years. While the surface area that the Red Pyramid covers is comparable to that of the two giant pyramids of Giza, the Red Pyramid has a much smaller

The Giza Death Star Deployed

mass, given that its sides slope at an angle of $43^{\circ} 22'$.⁴ This would make it an "obtuse" pyramid in relation to the side to height ratio of less than $\text{PI}/2$. Like the Great Pyramid, it has an entrance leading down a sloping passage, which ends at a chamber with a corbelled roof of eleven corbels, sitting at roughly ground level, similar to the Great Pyramid's Grand Gallery in its corbelling, dissimilar in that it is neither inclined nor above ground level.⁵ Another short passage leads to another similarly corbelled chamber directly beneath the pyramid's apex.⁶

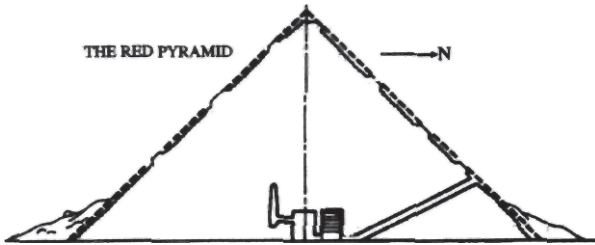

Whatever its mysterious design features were meant to accomplish, it most certainly was never a tomb, which may be confirmed by examining the engineering "mistake" of the Bent Pyramid, which, after the Great Pyramid itself, may be the "most interesting pyramid in the whole of ancient Egypt."⁷

⁴ Alan F. Alford, *The Phoenix Solution: Secrets of a Lost Civilisation* (London: Hodder and Stoughton, 1998), p. 52.

⁵ *Ibid.*, p. 52.

⁶ *Ibid.*

⁷ *Ibid.*, p. 55.

The Other Pyramids

The more southern of the two Dashur Pyramids, the Bent Pyramid rises to exactly the same height as the Red Pyramid, approximately 344.48 feet. Its upper angle of inclination, $43^{\circ}22'$ is exactly the same as the angle of inclination of the Red Pyramid. For the first lower third, however, its lower angle of inclination is $54^{\circ}28'$. And, unique to all the Egyptian pyramids in this duality, the duality seems to be an intentional design feature, since the Bent Pyramid has both northern and western entrances.⁸

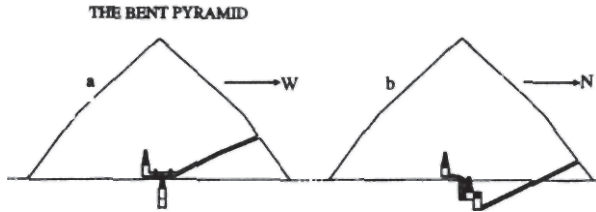

The Bent Pyramid's chambers, unlike the Red Pyramid whose chamber lie above ground, lie partially above, and partially below ground. Duality again. The passages themselves are curious studies in duality. The northern passage descends at a little more than 28 degrees but changes approximately half way down to a little more than 26 degree, and the western passage, descending at 30 degrees initially changes in mid-course to a little more than 24 degrees.⁹ At the end of this, two "portcullis" systems of limestone slabs are found, which may have had the function of "sonic baffles" similar to Dunn's hypothesis for the Antechamber in the Great Pyramid.

Alford then remarks that when he first visited Dashur, he was conditioned by the standard view of Egyptology to find these two Pyramids examples of the inferior workmanship of the Egyptians, who were still learning the art of pyramid building prior to Giza.

I had been seduced into believing that the builders of the Bent Pyramid were over-enthusiastic amateurs who had lost confidence in their design, in contrast to

⁸ Ibid.

⁹ Ibid., p. 56.

The Giza Death Star Deployed

the professionals who had built the near-perfect pyramids of Giza. However, having now visited Dashur, and seen with my own eyes the remarkable quality of the Red Pyramid, I am forced to question the conventional wisdom, and ask whether the Bent Pyramid was of an equivalent high standard. One man who certainly seemed to think so was the father of modern Egyptology, Sir Flinders Petrie, who inspected both of these structures in the 19th century. Petrie stated that "the general work of this pyramid is about equal to that of the Larger Pyramid of Dashur." He also observed that the exterior casing of the Bent Pyramid had "good and close joints" and was "of the same quality as that of the Second Pyramid of Gizeh."¹⁰

So how does one explain the apparent "design failure" of the Bent Pyramid and its curious dualities?

By geometry, of course.

Under geometric analysis, the design of the Bent Pyramid can hardly be qualified as a failure, but rather as part of a deliberate plan and design flawlessly executed. For one thing, the fact that the Bent Pyramid is of exactly the same height as the Red Pyramid is hardly coincidental.¹¹

Furthermore, those who know their pyramid geometry will understand that the slope of 43°22' is one of two significant angles which are a whole number ('N') function of pi, where the following formula is operative:

$H=N \times S/2 \pi$, where H=height of the pyramid and S= length of a side in its base.

The logic here is very simple. 'N' represents the number which determines the slope of the pyramid. If N is exactly "" the pyramid will have a slope of 51°50' as in the Great Pyramid of Giza. If N is exactly '3', on the other hand, the slope will be 43° 22', which is the final slope of both pyramids at Dashur.¹²

But, asks Alford, "what would it mean if we could prove that the slope had been changed at a significant height in the Bent Pyramid?" Such a discovery would "certainly undermine the weight of that particular argument" of Egyptology that the change was due to a design flaw and the inability of Sneferu's unpractised engineers in building a pyramid at such a steep angle.¹³

¹⁰ Ibid., p. 60.

¹¹ Ibid., p. 61.

¹² Ibid.

¹³ Ibid.

The Other Pyramids

As Alford explains,

An emergency change should produce a non-significant number, not a whole number like '3' or '4' (as above). An intended change, on the other hand, would produce a significant number, of which we might only envisage two possibilities in the myriad total outcomes - the mid-point 3.5, or pi itself, 3.14. Let's try it:

Bent Pyramid Height 105 m = $N \times (\text{side } 188\text{m}/2 \text{ pi})$

Thus $N=105/29.92$

Thus $N = 3.5^{14}$

But this "amazing result" is significant not only of the fact that the Bent Pyramid's design was hardly accidental, but also suggests that it, at least, was built after the Red Pyramid and the Great Pyramid, since the whole number N in the latter cases is 3 and 4 respectively.¹⁵

And this suggests a difficulty for the standard chronology of Egyptology, which maintains that Sneferu built the Dashur pyramids and then his son Khufu the Great Pyramid at Giza.

It is this lack of precedent and evolutionary development, this sudden confidence and expertise of Sneferu, which is so troubling to me, and indeed to Egyptologists. These giant pyramid projects at Dashur were planned and executed by experts. Of course they are within the limits of human achievement, but only given the necessary experimentation and learning experience. But where are the experiments, and where did this learning experience come from. It is almost as if Sneferu recaptured a lost knowledge, almost as if he acquired the keys to an ancient library of wisdom - a parallel to the modern idea of a lost 'Hall of Records.'¹⁶

In other words, the Egyptologists' explanation of Giza being presaged by Dashur, with Dashur as the "learning experience" and Giza as the "perfection of the art", really explains nothing. It merely pushes the mystery back further, and further muddles the chronology. How did Sneferu's engineers build the two marvels of Dashur? Where are the "experiments"?

The Bent Pyramid's incorporation of 3.5 also strongly suggests that the Great Pyramid was already in existence when Sneferu undertook to build the Red and Bent Pyramids, further confounding the standard chronology and buttressing Alford's claims for the antiquity of the Giza

¹⁴ Ibid., p. 62.

¹⁵ Ibid., pp. 62-63.

¹⁶ Ibid., 79.

The Giza Death Star Deployed

structures. In yet another Giza-Dashur parallel, it is known that the Bent Pyramid was cased with the yellowish limestone that also cased the Second giant Pyramid of Giza, and that the Red Pyramid was once cased with the same pure white limestone as once cased the Great Pyramid. And that begs the question of just which site was the original, and which was the imitator.¹⁷

Intrigued by this question, Alford took a ruler and connected the apex of the Red Pyramid with that of the Great Pyramid on a map, and drew another line connecting the apex of the Bent Pyramid with the Second Pyramid, and discovered that over a distance of 20 kilometers, the lines were exactly parallel. Since the two giant Giza Pyramids were built closely together on a clear diagonal plan, "it does not take a genius to see which pair of pyramids has been oriented to the other, and it is thus evident that Sneferu built his pyramids after and not before the Great Pyramids of Giza. Such a conclusion is entirely consistent with the archaeological evidence which (sic, et passim) reveals Giza to have been an important site in the 1st Dynasty, in contrast to Dashur which had little importance prior to the reign of Sneferu."¹⁸

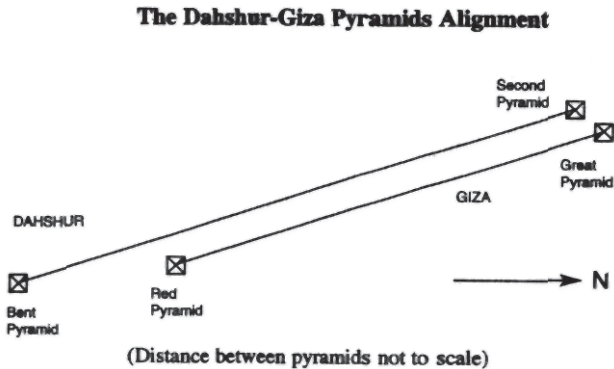

That Sneferu was responsible for the building of the two great Dashur pyramids is beyond question. But what possibly could their function have

¹⁷ Ibid., p. 80.

¹⁸ Ibid.

The Other Pyramids

been? If we accept Alford's idea that he indeed had access to, or rediscovered, some lost cache of knowledge, and tie it in with our own hypothesis or that of Dunn and Childress, then the function of the Dashur monuments seems to suggest itself.

Robert Vawter, trained as a musician and acoustical engineer as well as a field archaeologist, was able to do preliminary sound experiments and recordings in September 1997 that indicated the red Pyramid creates harmonic resonance at a different frequency than other pyramids.... He found overtones and resonance effects that recorded at different frequencies than those measured previously by other researchers in the Great Pyramid. This evidence enabled us to speculate that the (Pyramids) may have been "tuned" to different frequencies to resonate harmonically with each other.¹⁹

Moreover, as Mehler observes, the meaning of the name "Sneferu" itself may be a clue. The Bent Pyramid was not a mistake at all:

The Bent Pyramid is a true (Pyramid) and was purposely built the way it was for principles of energy production through acoustical harmonic resonance by virtue of its unique shape. The Red Pyramid, at a 43 degree angle, may vibrate in a specific harmonic with the bent Pyramid, and that also may be the reason for the term "Double Harmony" (Sneferu) at the site, not a specific king's name.... (Dunn) suggested that the Bent Pyramid, with its two angles of construction could produce multiple frequencies of sound, and this may be, in itself, the reason for the term Double Harmony.²⁰

Given the geometric relationships between Giza and Dashur, the evident design employed in the construction both of the Red Pyramid and of the Bent Pyramid, and the established resonant properties of the two pyramids of Dashur, one must conclude that they, too, are coupled harmonic oscillators of the structures at Giza. They may very well represent some sort of sophisticated power plant.

But they are, for all that, the imitators of a much more formidable pattern and physics evident at Giza.

¹⁹ Stephen J. Mehler, *The Land of Osiris* (Kempton, Illinois: Adventures Unlimited Press, 2001), pp. 70-71.

²⁰ *Ibid.*, pp. 72-73.

CONCLUSIONS

To me, one of the most disquieting things about the rash of books on ancient societies and their hypothetical science and technologies is the persistent theme that all these technologies, if adequately investigated, would yield a new era of unparalleled plenty and peace for humanity.

Unquestionably, the ability to engineer local space-time in such a fashion as to draw energy from the vacuum flux - while not currently engineerable to any practical degree - holds great promise for resolving many of our world's most pressing needs: the unequal distribution of wealth, the concentration of power and technology in the hands of but a very few nations, the poisoning of our environment with the unclean results of our depleting petroleum reserves. All this, at a stroke, would be resolved if the avenues of research suggested herein by me and other researchers were vigorously pursued.

Many researchers into this field also cite a variety of traditions and ancient texts that humanity is now entering a new age of promise, or, with a perplexing ability to ignore contradictions, cite the same texts as evidence that "the end is near" after which, if we only endure or undergo some sort of planetary initiation, have our collective consciousness "raised" and embrace the new paradigms and the new technologies it promises, all will be well.

What I find so disconcerting with my own research into those same texts is the ever-present insistence that whatever cataclysms as befell that paleoancient Very High Civilization were, they seemed to be initiated by human actions and technologies whose power for evil and destruction were almost as great as their promise for good. Sitchin himself is an example of this incongruity, though perhaps the most cautious one, for he himself conjectures on a series of devastating "Pyramid Wars", one of which was fought in part to eliminate the Great Weapon, if not the technology that made it possible. Nonetheless, he does not seem to notice what his own texts imply, namely, that the "pile of rocks" at Giza was once much more than simply an anomalous collection of weirdly out of place mathematical and physical dimensions. Indeed, for him the Great Pyramid was a "beacon" to far off interplanetary travelers.

Conclusions

Likewise Dunn, whose work is in so many ways admirable, seems to hesitate at pursuing his own connection of Tesla technology to the Great Pyramid. Yet the evidence of a persistent military and intelligence interest during the twentieth century in the Great Pyramid and other Giza structures is there for anyone who would bother to look, and this suggests that someone, somewhere in the various national, corporate, and academic halls of power knows very well what the possibility of a new energy source and its engineered application at Giza suggest: not only a limitless supply of power, but also a "limitless" capability for destruction. On either hypothesis - Dunn's Power Plant or my own Weapon Hypothesis - the geopolitical stakes involved at Giza are immense. Perhaps this is the best explanation of the recent Soviet and Russian research into scalar weaponry and pyramid power, the latter being but the modern fruit of the seed sown long before by Joseph Stalin's charge to his scientists to seek and develop a new form of weaponry of mass destruction that would do an end-run around the West's thermonuclear superiority.

If there is promise in the emerging technologies and theories, it is a promise that holds the potential both for great good and for great evil. I have no doubt that in time the theories necessary to create such technology - theories still in their infancy - will be perfected. Nor do I doubt that the technology will inevitably and ultimately be produced. It very nearly was once, with the experiments of Nikola Tesla and Thomas Townsend Brown. Indeed, they may have been successful in creating a first generation version of it. What may have been perfected since then in various Japanese, German, Russian, British, French and American laboratories we can only guess at.

But perhaps a clue - and a warning - to their nature may have been given by the Soviets themselves when, to a mystified American delegation to the SALT I talks, they proposed banning weapons of mass destruction more horrifying than any hitherto imagined. We may possibly expect, as a means of predicting its existence, that calls for a space-based weapons system will eventually be made to "protect" the earth from the occasional wandering large asteroid that comes "too close for comfort." With such planet-busting technology at hand, such objects could be shattered to pieces like the proverbial crystal glass in the Memorex commercials. But such a convenient and seemingly benign explanation would serve notice that weapons far more destructive than mere hydrogen bombs not only existed but were also being deployed in space.

The Giza Death Star Deployed

But perhaps we have already quietly been told that they not only exist, but have been used, albeit at very low power, in the all-too-convenient earthquakes that seemed to accompany the recent aerial bombing and ground offensive in Afghanistan waged by American and allied forces.

In either case, one thing seems clear: once, long ago, such a weapon did exist. Once, long ago, it was used to wreak untold devastation on this planet and possibly others. Once, long ago, a war was fought to disable it permanently.

But the shell of it still stands, serenely dominating the skyline of modern Cairo, a city whose name in Arabic means Mars, the god of war.

The Great Pyramid.



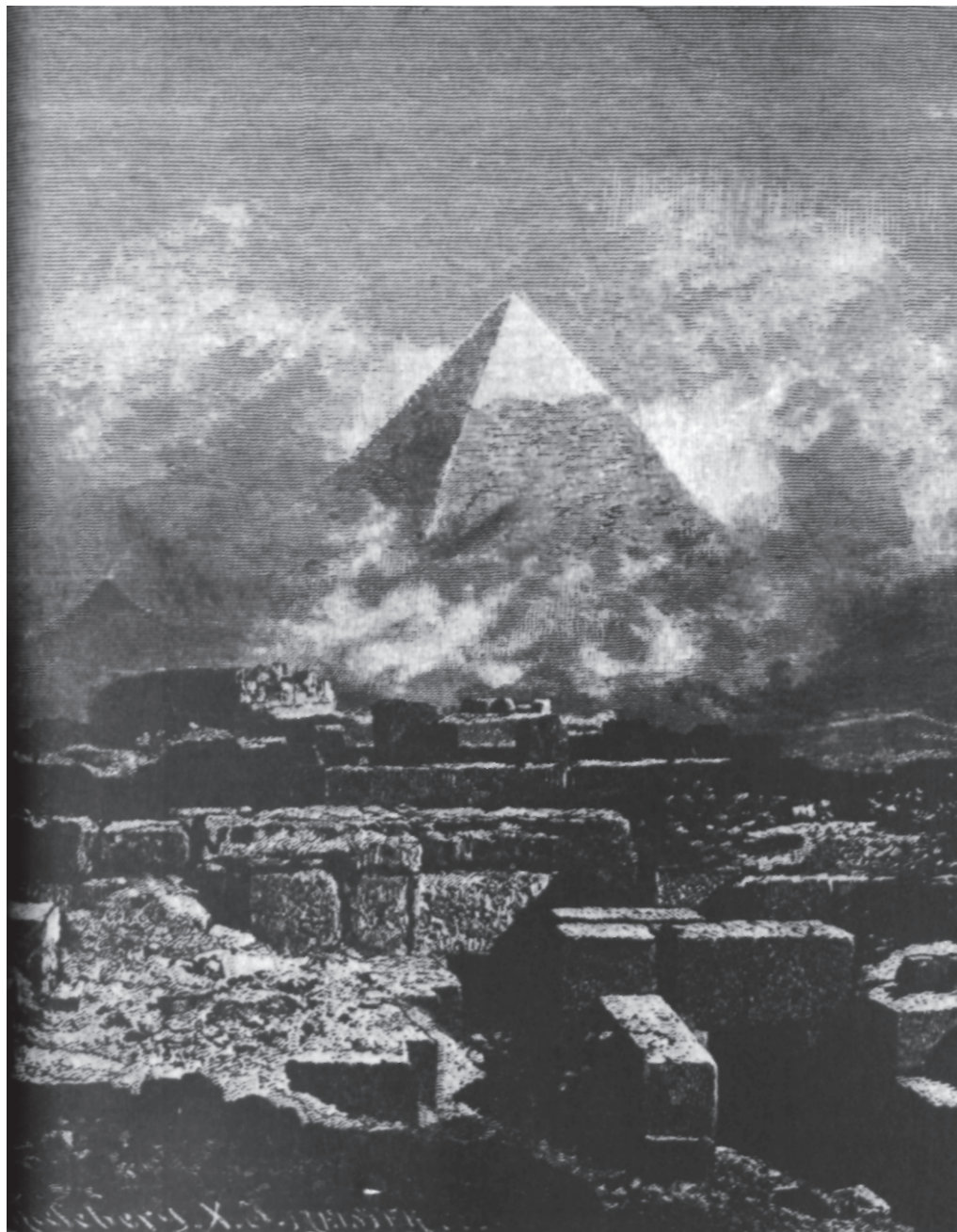

W. H. H. X. 1881